

1 Introduction	23
1.1 How to use the Manual	25
2 Installing Bforartists	28
3 Interface	39
4 Workspaces	50
5 Topbar and Statusbar	63
5.1.1 Topbar and Statusbar - File menu	68
5.1.2 Topbar and Statusbar - Edit menu	120
5.1.3 Topbar and Statusbar - Render menu	127
5.1.4 Topbar and Statusbar - Window menu	130
5.1.5 Topbar and Statusbar - Help menu	132
6 Editors introduction	134
7 Editors - 3D Viewport	149
7.0.1 Editors - 3D Viewport - Object mode - Object Context Menu	161
7.0.10 Editors - 3D Viewport - Metaball - Edit Mode - Metaball context menu	197
7.0.11 Editors - 3D Viewport - Text - Edit Mode - Text context menu	201
7.0.12 Editors - 3D Viewport - Grease Pencil object - Edit Mode - Point context menu	205
7.0.13 Editors - 3D Viewport - Grease Pencil object - Sculpt Mode - Brushes context menu	217
7.0.14 Editors - 3D Viewport - Grease Pencil object - Draw Mode - Brushes context menu	219
7.0.15 Editors - 3D Viewport - Grease Pencil object - Vertex Paint Mode - Brushes context menu	222
7.0.16 Editors - 3D Viewport - Grease Pencil object - Weight Paint Mode - Brushes context menu	225
7.0.17 Editors - 3D Viewport - Armature - Edit Mode - Armature context menu	227

7.0.18 Editors - 3D Viewport - Armature - Pose Mode - Pose context menu	237
7.0.19 Editors - 3D Viewport - Armature - Edit Mode - Lattice context menu	244
7.0.2 Editors - 3D Viewport - Mesh Object - Edit Mode - Vertex Context Menu	247
7.0.3 Editors - 3D Viewport - Mesh Object - Edit Mode - Edge Context Menu	263
7.0.4 Editors - 3D Viewport - Mesh Object - Edit Mode - Face Context Menu	280
7.0.5 Editors - 3D Viewport - Mesh Object - Sculpt Mode - Brushes context menus	299
7.0.6 Editors - 3D Viewport - Mesh Object - Vertex Paint Mode - Brushes context menus	302
7.0.7 Editors - 3D Viewport - Mesh Object - Weight Paint Mode - Brushes context menus	304
7.0.8 Editors - 3D Viewport - Mesh Object - Texture Paint Mode - Brushes context menus	306
7.0.9 Editors - 3D Viewport - Curve + Surface Object - Edit Mode - Curves context menus	308
7.1 Editors - 3D Viewport - Header	320
7.1.1 Editors - 3D Viewport - Header tools and Options	323
7.1.10 Editors - 3D Viewport - Header - Mesh - Edit Mode - Vertex Menu	383
7.1.11 Editors - 3D Viewport - Header - Mesh - Edit mode - Edge Menu	398
7.1.12 Editors - 3D Viewport - Header - Mesh - Edit mode - Faces menu	411
7.1.13 Editors - 3D Viewport - Header - Mesh - Edit mode - UV menu	424

7.1.14 Editors - 3D Viewport - Header - Mesh - Sculpt mode - Sculpt menu _____	432
7.1.15 Editors - 3D Viewport - Header - Mesh - Sculpt mode - Brush menu _____	446
7.1.16 Editors - 3D Viewport - Header - Mesh - Sculpt mode - Mask menu _____	447
7.1.17 Editors - 3D Viewport - Header - Mesh - Sculpt mode - Face Sets menu _____	450
7.1.18 Editors - 3D Viewport - Header - Mesh - Vertex Paint mode - Paint menu _____	453
7.1.19 Editors - 3D Viewport - Header - Mesh - Vertex Paint mode - Brush menu _____	457
7.1.2 Editors - 3D Viewport - Header - Quick Menu _____	458
7.1.20 Editors - 3D Viewport - Header - Mesh - Weight Paint mode - Weights menu _____	460
7.1.22 Editors - 3D Viewport - Header - Mesh - Texture Paint mode - Brush menu _____	470
7.1.23 Editors - 3D Viewport - Header - Curve - Edit mode - Curve menu _____	471
7.1.24 Editors - 3D Viewport - Header - Surface - Edit mode - Surface menu _____	489
7.1.25 Editors - 3D Viewport - Header - Curve & Surface - Edit mode - Control points menu _____	506
7.1.26 Editors - 3D Viewport - Header - Curve & Surface - Edit mode - Segments menu _____	514
7.1.27 Editors - 3D Viewport - Header - Metaball - Edit mode - Metaball menu _____	515
7.1.29 Editors - 3D Viewport - Header - Text - Edit mode - Text menu _____	529
7.1.3 Editors - 3D Viewport - Header - View Menu _____	532

7.1.30 Editors - 3D Viewport - Header - Grease Pencil - Edit mode - Grease Pencil menu	542
7.1.31 Editors - 3D Viewport - Header - Grease Pencil - Edit mode - Stroke menu	558
7.1.32 Editors - 3D Viewport - Header - Grease Pencil - Edit mode - Points menu	568
7.1.33 Editors - 3D Viewport - Header - Grease Pencil - Draw mode - Draw menu	571
7.1.34 Editors - 3D Viewport - Header - Grease Pencil - Vertex Paint mode - Animation menu	575
7.1.35 Editors - 3D Viewport - Header - Grease Pencil - Vertex Paint mode - Active Layer menu	577
7.1.36 Editors - 3D Viewport - Header - Grease Pencil - Vertex Paint mode - Paint menu	578
7.1.37 Editors - 3D Viewport - Header - Grease Pencil - Weight Paint Mode - Weights Menu	581
7.1.38 Editors - 3D Viewport - Header - Armature - Edit mode - Armature menu	585
7.1.39 Editors - 3D Viewport - Header - Armature - Pose mode - Pose menu	603
7.1.4 Editors - 3D Viewport - Header - Navigation Menu	623
7.1.40 Editors - 3D Viewport - Header - Lattice - Edit mode - Lattice menu	633
7.1.41 Editors - 3D Viewport - Header - Particle - Particle mode - Particle menu	646
7.1.42 Editors - 3D Viewport - Header - Hair Curve - Edit mode - Curves menu	649
7.1.43 Editors - 3D Viewport - Header - Hair Curve - Sculpt mode - Curves menu	653
7.1.5 Editors - 3D Viewport - Header - Select Menu	654

7.1.6 Editors - 3D Viewport - Header - Add Menu _____	705
7.1.7 Editors - 3D Viewport - Header - Edit mode - Add menu _____	732
7.1.8 Editors - 3D Viewport - Header - Object menu _____	733
7.1.9 Editors - 3D Viewport - Header - Mesh - Edit mode - Mesh menu _____	783
7.2 Editors - 3D Viewport - Tool Shelf _____	834
7.2.1 Editors - 3D Viewport - Tool Shelf - Object Mode _____	838
7.2.10 Editors - 3D Viewport - Tool Shelf - Metaball - Edit Mode _____	876
7.2.11 Editors - 3D Viewport - Tool Shelf - Text - Edit Mode _____	879
7.2.12 Editors - 3D Viewport - Tool Shelf - Grease Pencil - Edit Mode _____	880
7.2.13 Editors - 3D Viewport - Tool Shelf - Grease Pencil - Sculpt Mode _____	889
7.2.14 Editors - 3D Viewport - Tool Shelf - Grease Pencil - Draw Mode _____	892
7.2.15 Editors - 3D Viewport - Tool Shelf - Grease Pencil - Vertex Paint Mode _____	898
7.2.16 Editors - 3D Viewport - Tool Shelf - Grease Pencil - Weight Paint Mode _____	900
7.2.17 Editors - 3D Viewport - Tool Shelf - Armature - Edit Mode _____	901
7.2.18 Editors - 3D Viewport - Tool Shelf - Armature - Pose Mode _____	913
7.2.19 Editors - 3D Viewport - Tool Shelf - Lattice - Edit Mode _____	917
7.2.2 Editors - 3D Viewport - Tool Shelf - Mesh - Edit Mode _____	920
7.2.20 Editors - 3D Viewport - Tool Shelf - Hair Curve - Sculpt Mode _____	967
7.2.3 Editors - 3D Viewport - Tool Shelf - Mesh - Sculpt Mode _____	971
7.2.4 Editors - 3D Viewport - Tool Shelf - Mesh - Vertex Paint Mode _____	987
7.2.5 Editors - 3D Viewport - Tool Shelf - Mesh - Weight Paint Mode _____	990

7.2.6 Editors - 3D Viewport - Tool Shelf - Mesh - Texture Paint Mode _____	997
7.2.7 Editors - 3D Viewport - Tool Shelf - Mesh - Particle Edit Mode _____	1000
7.2.8 Editors - 3D Viewport - Tool Shelf - Curve - Edit Mode _____	1005
7.2.9 Editors - 3D Viewport - Tool Shelf - Surface - Edit Mode _____	1017
7.3 Editors - 3D Viewport - Sidebar _____	1020
7.3.1 Editors - 3D Viewport - Sidebar - Item tab _____	1021
7.3.10 Editors - 3D Viewport - Sidebar - Tool Tab - Particle Edit Mode _____	1035
7.3.11 Editors - 3D Viewport - Sidebar - Tool Tab - Grease Pencil - Sculpt Mode _____	1039
7.3.12 Editors - 3D Viewport - Sidebar - Tool Tab - Grease Pencil - Draw Mode _____	1047
7.3.13 Editors - 3D Viewport - Sidebar - Tool Tab - Grease Pencil - Vertex Paint Mode _____	1064
7.3.14 Editors - 3D Viewport - Sidebar - Tool Tab - Grease Pencil - Weight Paint Mode _____	1069
7.3.15 Editors - 3D Viewport - Sidebar - Tool Tab - Grease Pencil - Layer Panel _____	1071
7.3.16 Editors - 3D Viewport - Sidebar - Tool Tab - Hair Curve - Sculpt Mode _____	1074
7.3.17 Editors - 3D Viewport - Sidebar - View Tab _____	1090
7.3.18 Editors - 3D Viewport - Sidebar - Animation Tab _____	1102
7.3.2 Editors - 3D Viewport - Sidebar - Tool Tab _____	1105
7.3.3 Editors - 3D Viewport - Sidebar - Tool Tab - Object Mode _____	1107
7.3.4 Editors - 3D Viewport - Sidebar - Tool Tab - Edit Mode _____	1108
7.3.5 Editors - 3D Viewport - Sidebar - Tool Tab - Pose Mode _____	1111
7.3.6 Editors - 3D Viewport - Sidebar - Tool Tab - Mesh - Sculpt Mode _____	1112

7.3.7 Editors - 3D Viewport - Sidebar - Tool Tab - Mesh - Vertex Paint Mode _____	1178
7.3.8 Editors - 3D Viewport - Sidebar - Tool Tab - Mesh - Texture Paint Mode _____	1201
7.3.9 Editors - 3D Viewport - Sidebar - Tool Tab - Mesh - Weight Paint Mode _____	1239
8 Editors - Image Editor _____	1259
8.1 Editors - Image Editor - Header _____	1267
8.1.1 Editors - Image Editor - Header - Header Tools and Options .	1269
8.1.2 Editors - Image Editor - Header - Quick Menu _____	1277
8.1.3 Editors - Image Editor - Header - View menu _____	1279
8.1.4 Editors - Image Editor - Header - Image menu _____	1284
8.1.5 Editors - Image Editor - Header - Select menu _____	1289
8.1.6 Editors - Image Editor - Header - Add menu _____	1291
8.1.7 Editors - Image Editor - Header - Mask menu _____	1294
8.2 Editors - Image Editor - Tool Shelf _____	1302
8.3 Editors - Image Editor - Sidebar _____	1307
8.3.1 Editors - Image Editor - Sidebar - Tools Tab in Paint Mode __	1308
8.3.2 Editors - Image Editor - Sidebar - Image Tab _____	1340
8.3.3 Editors - Image Editor - Sidebar - View Tab _____	1352
8.3.4 Editors - Image Editor - Sidebar - Scopes Tab _____	1355
8.3.5 Editors - Image Editor - Sidebar - Mask Tab _____	1358
9 Editors - UV Editor _____	1363
9.1 Editors - UV Editor - Header _____	1375
9.1.1 Editors - UV Editor - Header - Header Tools and Options ____	1379
9.1.2 Editors - UV Editor - Header - Quick Menu _____	1388
9.1.3 Editors - UV Editor - Header - View Menu _____	1390
9.1.4 Editors - UV Editor - Header - Select Menu _____	1395
9.1.5 Editors - UV Editor - Header - Image Menu _____	1401
9.1.6 Editors - UV Editor - Header - UV menu _____	1405

9.2 Editors - UV Editor - Tool Shelf _____	1428
9.3 Editors - UV Editor - Sidebar _____	1443
9.3.1 Editors - UV Editor - Sidebar - Image Tab _____	1444
9.3.2 Editors - UV Editor - Sidebar - Tools Tab _____	1457
9.3.3 Editors - UV Editor - Sidebar - View Tab _____	1462
10 Editors - Compositor _____	1465
10.1 Editors - Compositor - Header _____	1474
10.1.1 Editors - Compositor - Header - Tools and Options _____	1476
10.1.10 Editors - Compositor Editor - Header - Add Menu - Filter _	1478
10.1.11 Editors - Compositor Editor - Header - Add Menu - Vector .	1498
10.1.12 Editors - Compositor Editor - Header - Add Menu - Matte _	1504
10.1.13 Editors - Compositor Editor - Header - Add Menu - Distort .	1525
10.1.14 Editors - Compositor Editor - Header - Add Menu - Group .	1539
10.1.15 Editors - Compositor Editor - Header - Add Menu - Layout _____	1542
10.1.16 Editors - Compositor Editor - Header - Node menu _____	1544
10.1.2 Editors - Compositor - Header - Quick Menu _____	1549
10.1.3 Editors - Compositor Editor - Header - View Menu _____	1551
10.1.4 Editors - Compositor Editor - Header - Select Menu _____	1555
10.1.5 Editors - Compositor Editor - Header - Add Menu _____	1558
10.1.6 Editors - Compositor Editor - Header - Add Menu - Input _	1559
10.1.7 Editors - Compositor Editor - Header - Add Menu - Output _	1576
10.1.8 Editors - Compositor Editor - Header - Add Menu - Color _	1582
10.1.9 Editors - Compositor Editor - Header - Add Menu - Converter _____	1602
10.2 Editors - Compositor Editor - Tool Shelf _____	1616
10.3 Editors - Compositor Editor - Sidebar _____	1621
10.3.1 Editors - Compositor Editor - Sidebar - Node Tab _____	1622
10.3.2 Editors - Compositor Editor - Sidebar - Tool Tab _____	1630
10.3.3 Editors - Compositor Editor - Sidebar - View Tab _____	1631

10.3.4 Editors - Compositor Editor - Sidebar - Options Tab _____	1634
10.3.5 Editors - Compositor Editor - Sidebar - Add Tab _____	1636
10.3.6 Editors - Compositor Editor - Sidebar - Relations tab _____	1637
11 Editors - Texture Node Editor _____	1642
12 - Geometry Node Editor _____	1643
12.1.1 Editors - Geometry Nodes Editor - Header - Tools and Options _____	1652
12.1.10 Editors - Geometry Nodes Editor - Header - Add Menu - Output _____	1655
12.1.11 Editors - Geometry Nodes Editor - Header - Add Menu - Geometry - Read _____	1656
12.1.12 Editors - Geometry Nodes Editor - Header - Add Menu - Geometry - Sample _____	1660
12.1.13 Editors - Geometry Nodes Editor - Header - Add Menu - Geometry - Write _____	1666
12.1.14 Editors - Geometry Nodes Editor - Header - Add Menu - Geometry - Operations _____	1669
12.1.15 Editors - Geometry Nodes Editor - Header - Add Menu - Geometry _____	1677
12.1.16 Editors - Geometry Nodes Editor - Header - Add Menu - Curve - Read _____	1691
12.1.17 Editors - Geometry Nodes Editor - Header - Add Menu - Curve - Sample _____	1698
12.1.18 Editors - Geometry Nodes Editor - Header - Add Menu - Curve - Write _____	1701
12.1.19 Editors - Geometry Nodes Editor - Header - Add Menu - Curve - Operations _____	1709
12.1.2 Editors - Geometry Node Editor - Header - Quick Menu ____	1720
12.1.20 Editors - Geometry Nodes Editor - Header - Add Menu - Curve - Primitives _____	1722

12.1.21 Editors - Geometry Nodes Editor - Header - Add Menu - Curve Topology _____	1733
12.1.22 Editors - Geometry Nodes Editor - Header - Add Menu - Instances _____	1736
12.1.23 Editors - Geometry Nodes Editor - Header - Add Menu - Mesh - Read _____	1743
12.1.24 Editors - Geometry Nodes Editor - Header - Add Menu - Mesh - Sample _____	1750
12.1.25 Editors - Geometry Nodes Editor - Header - Add Menu - Mesh - Write _____	1753
12.1.26 Editors - Geometry Nodes Editor - Header - Add Menu - Mesh - Operations _____	1774
12.1.27 Editors - Geometry Nodes Editor - Header - Add Menu - Mesh - Primitives _____	1787
12.1.28 Editors - Geometry Nodes Editor - Header - Add Menu - Mesh - Topology _____	1796
12.1.29 Editors - Geometry Nodes Editor - Header - Add Menu - Mesh - UV _____	1803
12.1.3 Editors - Geometry Nodes Editor - Header - View Menu ____	1806
12.1.30 Editors - Geometry Nodes Editor - Header - Add Menu - Point _____	1810
12.1.31 Editors - Geometry Nodes Editor - Header - Add Menu - Volume _____	1817
12.1.32 Editors - Geometry Nodes Editor - Header - Add Menu - Simulation _____	1820
12.1.33 Editors - Geometry Nodes Editor - Header - Add Menu - Material _____	1825
12.1.34 Editors - Geometry Nodes Editor - Header - Add Menu - Texture _____	1829

12.1.35 Editors - Geometry Nodes Editor - Header - Add Menu - Utilities - Color _____	1845
12.1.36 Editors - Geometry Nodes Editor - Header - Add Menu - Utilities - Text _____	1856
12.1.37 Editors - Geometry Nodes Editor - Header - Add Menu - Utilities - Vector _____	1863
12.1.38 Editors - Geometry Nodes Editor - Header - Add Menu - Utilities - Field _____	1871
12.1.39 Editors - Geometry Nodes Editor - Header - Add Menu - Utilities - Math _____	1875
12.1.4 Editors - Geometry Nodes Editor - Header - Select Menu _____	1891
12.1.40 Editors - Geometry Nodes Editor - Header - Add Menu - Utilities - Rotation _____	1893
12.1.41 Editors - Geometry Nodes Editor - Header - Add Menu - Utilities _____	1896
12.1.42 Editors - Geometry Nodes Editor - Header - Add Menu - Group _____	1902
12.1.43 Editors - Geometry Nodes Editor - Header - Add Menu - Layout _____	1905
12.1.44 Editors - Geometry Nodes Editor - Header - Add Menu - Hair - Deformation _____	1908
12.1.45 Editors - Geometry Nodes Editor - Header - Add Menu - Hair - Generation _____	1920
12.1.46 Editors - Geometry Nodes Editor - Header - Add Menu - Hair - Guides _____	1926
12.1.47 Editors - Geometry Nodes Editor - Header - Add Menu - Hair - Read _____	1934
12.1.48 Editors - Geometry Nodes Editor - Header - Add Menu - Hair - Utility _____	1938

12.1.49 Editors - Geometry Nodes Editor - Header - Add Menu - Hair - Write _____	1942
12.1.5 Editors - Geometry Node Editor - Header - Add Menu _____	1944
12.1.50 Editors - Geometry Nodes Editor - Header - Node menu _____	1946
12.1.6 Editors - Geometry Node Editor - Header - Add Menu - Attribute _____	1951
12.1.7 Editors - Geometry Nodes Editor - Header - Add Menu - Input - Constant _____	1959
12.1.9 Editors - Geometry Nodes Editor - Header - Add Menu - Input - Scene _____	1964
12.2 Editors - Geometry Nodes Editor - Tool Shelf _____	1969
12.3 Editors - Geometry Nodes Editor - Sidebar _____	1974
12.3.1 Editors - Geometry Nodes Editor - Sidebar - Node tab _____	1975
12.3.2 Editors - Geometry Nodes Editor - Sidebar - Item Tab _____	1977
12.3.3 Editors - Geometry Nodes Editor - Sidebar - Tool Tab _____	1979
12.3.4 Editors - Geometry Nodes Editor- Sidebar - View Tab _____	1980
12.3.5 Editors - Geometry Nodes Editor - Sidebar - Group tab _____	1982
12.3.6 Editors - Geometry Nodes Editor - Sidebar - Add _____	1987
12.3.7 Editors - Geometry Nodes Editor - Sidebar - Relations tab _____	1988
13 Editors - Shader Editor _____	1993
13.1 Editors - Shader Editor - Header _____	2001
13.1.1 Editors - Shader Editor - Header - Tools and Options _____	2003
13.1.10 Editors - Shader Editor - Header - Add Menu - Color _____	2009
13.1.11 Editors - Shader Editor - Header - Add Menu - Vector _____	2020
13.1.12 Editors - Shader Editor - Header - Add Menu - Converter _____	2032
13.1.13 Editors - Shader Editor - Header - Add Menu - Script _____	2049
13.1.14 Editors - Shader Editor - Header - Add Menu - Group _____	2051
13.1.15 Editors - Shader Editor - Header - Add Menu - Layout _____	2054
13.1.16 Editors - Shader Editor - Header - Node menu _____	2056
13.1.2 Editors - Shader Editor - Header - Quick Menu _____	2060

13.1.3 Editors - Shader Editor - Header - View Menu _____	2062
13.1.4 Editors - Shader Editor - Header - Select Menu _____	2065
13.1.5 Editors - Shader Editor - Header - Add Menu _____	2068
13.1.6 Editors - Shader Editor - Header - Add Menu - Input _____	2069
13.1.7 Editors - Shader Editor - Header - Add Menu - Output _____	2086
13.1.8 Editors - Shader Editor - Header - Add Menu - Shader _____	2092
13.1.9 Editors - Shader Editor - Header - Add Menu - Texture _____	2125
13.2 Editors - Shader Editor - Tool Shelf _____	2151
13.3 Editors - Shader Editor - Sidebar _____	2156
13.3.1 Editors - Shader Editor - Sidebar - Item Tab _____	2157
13.3.2 Editors - Shader Editor - Sidebar - Tool Tab _____	2165
13.3.3 Editors - Shader Editor - Sidebar - View Tab _____	2166
13.3.4 Editors - Shader Editor - Sidebar - Options Tab _____	2168
13.3.5 Editors - Shader Editor - Sidebar - Add Tab _____	2179
13.3.6 Editors - Shader Editor - Sidebar - Relations tab _____	2181
14 Editors - Video Sequence Editor _____	2186
14.1 Editors - Video Sequence Editor - Header _____	2198
14.1.1 Editors - Video Sequence Editor - Header - Tools and Options _____	2199
14.1.10 Editors - Video Sequence Editor - Header - Image Menu _____	2207
14.1.2 Editors - Video Sequence Editor - Header - Quick Menu _____	2209
14.1.3 Editors - Video Sequence Editor - Header - View Menu _____	2211
14.1.4 Editors - Video Sequence Editor - Header - Export Menu _____	2220
14.1.5 Editors - Video Sequence Editor - Header - Navi Menu _____	2221
14.1.6 Editors - Video Sequence Editor - Header - Select Menu _____	2223
14.1.7 Editors - Video Sequence Editor - Header - Marker Menu _____	2228
14.1.8 Editors - Video Sequence Editor - Header - Add Menu _____	2230
14.1.9 Editors - Video Sequence Editor - Header - Strip Menu _____	2241
14.2 Editors - Video Sequence Editor - Tool Shelf _____	2252
14.3 Editors - Video Sequence Editor - Sidebar _____	2265

14.3.1 Editors - Video Sequence Editor - Sidebar - Preview - Tool tab _____	2266
14.3.2 Editors - Video Sequence Editor - Sidebar - Preview - View tab _____	2267
14.3.3 Editors - Video Sequence Editor - Sidebar - Sequencer - Strip tab _____	2272
14.3.4 Editors - Video Sequence Editor - Sidebar - Sequencer - Tool tab _____	2291
14.3.5 Editors - Video Sequence Editor - Sidebar - Sequencer - Modifier tab _____	2292
14.3.6 Editors - Video Sequence Editor - Sidebar - Sequencer - Proxy&Cache tab _____	2302
14.3.7 Editors - Video Sequence Editor - Sidebar - Sequencer - View tab _____	2306
15 Editors - Movie Clip Editor _____	2309
15.1 Editors - Movie Clip Editor - Header _____	2324
15.1.1 Editors - Movie Clip Editor - Header Tools and Options ____	2326
15.1.10 Editors - Movie Clip Editor - Header - Mask Mode - Mask Menu _____	2338
15.1.2 Editors - Movie Clip Editor - Header - Quick Menu _____	2349
15.1.3 Editors - Movie Clip Editor - Header - View Menu _____	2351
15.1.4 Editors - Movie Clip Editor - Header - Select Menu _____	2361
15.1.5 Editors - Movie Clip Editor - Header - Tracking Mode - Clip Submode - Clip Menu _____	2365
15.1.6 Editors - Movie Clip Editor - Header - Tracking Mode - Clip Submode - Track Menu _____	2366
15.1.7 Editors - Movie Clip Editor - Header - Tracking Mode - Graph Submode - Graph Menu _____	2377
15.1.8 Editors - Movie Clip Editor - Header - Mask Mode - Clip Menu _____	2379

15.1.9 Editors - Movie Clip Editor - Header - Mask Mode - Add Menu _____	2380
15.2 Editors - Movie Clip Editor - Tool shelf _____	2382
15.2.1 Editors - Movie Clip Editor - Tool shelf - Tracking Mode ____	2384
15.3 Editors - Movie Clip Editor - Sidebar _____	2399
15.3.1 Editors - Movie Clip Editor - Sidebar - Footage Tab _____	2400
15.3.2 Editors - Movie Clip Editor - Sidebar - Track tab _____	2403
15.3.3 Editors - Movie Clip Editor - Sidebar - Tracking Mode - Sta- bilization tab _____	2412
15.3.4 Editors - Movie Clip Editor - Sidebar - Tracking Mode - View tab _____	2415
16 Editors - Dope Sheet _____	2418
16.1.1 Editors - Dope Sheet - Header tools and options _____	2426
16.1.2 Editors - Dope Sheet - Header - Quick Menu _____	2436
16.1.3 Editors - Dope Sheet - View Menu _____	2438
16.1.4 Editors - Dope Sheet - Select Menu _____	2441
16.1.5 Editors - Dope Sheet - Marker Menu _____	2444
16.1.6 Editors - Dope Sheet - Channel Menu _____	2446
16.1.7 Editors - Dope Sheet - Key + Frame Menu _____	2450
16.2 Editors - Dope Sheet - Channel list _____	2454
16.3 Editors - Dope Sheet - Sidebar _____	2457
17 Editors - Timeline _____	2462
17.1.1 Editors - Timeline - Header Tools and Options _____	2469
17.1.2 Editors - Timeline - View Menu _____	2476
17.1.3 Editors - Timeline - Marker Menu _____	2478
17.1.4 Editors - Timeline - Select Menu _____	2481
17.2 Editors - Timeline - Channel list _____	2484
18 Editors - Graph Editor _____	2486
18.1.1 Editors - Graph Editor - Header tools and options _____	2496
18.1.2 Editors - Graph Editor - Header - Quick Menu _____	2502

18.1.3 Editors - Graph Editor - View Menu _____	2504
18.1.4 Editors - Graph Editor - Select Menu _____	2508
18.1.5 Editors - Graph Editor - Marker Menu _____	2512
18.1.6 Editors - Graph Editor - Channel Menu _____	2515
18.1.7 Editors - Graph Editor - Key Menu _____	2521
18.2 Editors - Graph Editor - Channel list _____	2535
18.3 Editors - Graph Editor - Sidebar _____	2538
18.3.1 Editors - Graph Editor - Sidebar - F-Curve Tab _____	2539
18.3.2 Editors - Graph Editor - Sidebar - Modifiers Tab _____	2542
18.3.3 Editors - Graph Editor - Sidebar - View Tab _____	2554
19 Editors - Drivers Editor _____	2555
19.1.1 Editors - Drivers Editor - Header tools and options _____	2569
19.1.2 Editors - Drivers Editor - Header - Quick Menu _____	2575
19.1.3 Editors - Drivers Editor - View Menu _____	2577
19.1.4 Editors - Drivers Editor - Select Menu _____	2580
19.1.5 Editors - Drivers Editor - Channel Menu _____	2583
19.1.6 Editors - Drivers Editor - Key Menu _____	2587
19.2 Editors - Drivers Editor - Channel list _____	2597
19.3.1 Editors - Drivers Editor - Sidebar - F-Curve Tab _____	2599
19.3.2 Editors - Drivers Editor - Sidebar - Drivers Tab _____	2602
19.3.3 Editors - Drivers Editor - Sidebar - Modifiers Tab _____	2609
19.3.4 Editors - Driver Editor - Sidebar - View Tab _____	2621
20 Editors - Nonlinear Animation Editor _____	2622
20.1.1 Editors - NLA Editor - Header tools and options _____	2631
20.1.2 Editors - NLA Editor - Header - Quick Menu _____	2635
20.1.3 Editors - NLA Editor - View Menu _____	2637
20.1.4 Editors - NLA Editor - Select Menu _____	2641
20.1.5 Editors - NLA Editor - Marker Menu _____	2644
20.1.6 Editors - NLA Editor - Edit Menu _____	2647
20.1.7 Editors - NLA Editor - Add Menu _____	2653

20.2 Editors - NLA Editor - Channel list _____	2655
20.3.1 Editors - NLA Editor - Sidebar - Edited Action tab _____	2658
20.3.2 Editors - NLA Editor - Sidebar - Strip tab _____	2661
20.3.3 Editors - NLA Editor - Sidebar - Modifiers Tab _____	2666
21 Editors - Text Editor _____	2679
22 Editors - Python Console _____	2694
23 Editors - Info Editor _____	2704
24 Editors - Toolbar _____	2708
25 Editors - Outliner _____	2751
26 Editors - Properties Editor _____	2784
26.10 Editors - Properties Editor - Particle Properties Tab _____	2788
26.10.1 Editors - Properties Editor - Particle Properties Tab - Emitter _____	2793
26.10.10 Editors - Properties Editor - Particle Properties Tab - Hair - Hair Dynamics panel _____	2794
26.10.11 Editors - Properties Editor - Particle Properties Tab - Hair - Cache Panel _____	2797
26.10.12 Editors - Properties Editor - Particle Properties Tab - Hair - Rotation panel _____	2802
26.10.13 Editors - Properties Editor - Particle Properties Tab - Hair - Render panel _____	2804
26.10.14 Editors - Properties Editor - Particle Properties Tab - Hair - Viewport Display panel _____	2810
26.10.15 Editors - Properties Editor - Particle Properties Tab - Hair - Hair Shape panel _____	2813
26.10.16 Editors - Properties Editor - Particle Properties Tab - Hair - Field Weights panel _____	2814
26.10.17 Editors - Properties Editor - Particle Properties Tab - Velocity panel _____	2816

26.10.18 Editors - Properties Editor - Particle Properties Tab - Physics panel _____	2817
26.10.19 Editors - Properties Editor - Particle Properties Tab - Children panel _____	2836
26.10.2 Editors - Properties Editor - Particle Properties Tab - Emitter - Emission Panel _____	2851
26.10.20 Editors - Properties Editor - Particle Properties Tab - Force Field Settings panel _____	2854
26.10.21 Editors - Properties Editor - Particle Properties Tab - Vertex Groups panel _____	2867
26.10.22 Editors - Properties Editor - Particle Properties Tab - Textures panel _____	2869
26.10.23 Editors - Properties Editor - Particle Properties Tab - Custom Properties panel _____	2871
26.10.3 Editors - Properties Editor - Particle Properties Tab - Emitter - Cache Panel _____	2872
26.10.4 Editors - Properties Editor - Particle Properties Tab - Emitter - Rotation panel _____	2877
26.10.5 Editors - Properties Editor - Particle Properties Tab - Emitter - Render panel _____	2879
26.10.6 Editors - Properties Editor - Particle Properties Tab - Emitter - Viewport Display panel _____	2885
26.10.7 Editors - Properties Editor - Particle Properties Tab - Emitter - Field Weights panel _____	2888
26.10.8 Editors - Properties Editor - Particle Properties Tab - Hair	2889
26.10.9 Editors - Properties Editor - Particle Properties Tab - Hair - Emission Panel _____	2891
26.11 Editors - Properties Editor - Visual Effects Properties Tab	2894
26.12 Editors - Properties Editor - Physics Properties Tab	2905

26.12.1 Editors - Properties Editor - Physics Properties Tab - Force Field panel _____	2908
26.12.2 Editors - Properties Editor - Physics Properties Tab - Collision panel _____	2940
26.12.3 Editors - Properties Editor - Physics Properties Tab - Cloth panel _____	2943
26.12.4 Editors - Properties Editor - Physics Properties Tab - Dynamic Paint panel _____	2958
26.12.5 Editors - Properties Editor - Physics Properties Tab - Soft Body panel _____	2978
26.12.6 Editors - Properties Editor - Physics Properties Tab - Fluid panel _____	2991
26.12.7 Editors - Properties Editor - Physics Properties Tab - Rigid Body panel _____	3031
26.12.8 Editors - Properties Editor - Physics Properties Tab - Rigid Body Constraint panel _____	3038
26.13 Editors - Properties Editor - Object Constraints Properties Tab _____	3047
26.14 Editors - Properties Editor - Object Data Properties Tab ____	3085
26.14.1 Editors - Properties Editor - Object Data Properties Tab - Mesh Object _____	3087
26.14.10 Editors - Properties Editor - Object Data Properties Tab - Empty&Image Object _____	3107
26.14.11 Editors - Properties Editor - Object Data Properties Tab - Sound Object _____	3115
26.14.12 Editors - Properties Editor - Object Data Properties Tab - Camera Object _____	3119
26.14.13 Editors - Properties Editor - Object Data Properties Tab - Light Object _____	3136

26.14.14 Editors - Properties Editor - Object Data Properties Tab	
- Light Probe Object _____	3148
26.14.15 Editors - Properties Editor - Object Data Properties Tab	
- Force Field Object _____	3155
26.14.16 Editors - Properties Editor - Object Data Properties Tab	
- Point Cloud Object _____	3163
26.14.2 Editors - Properties Editor - Object Data Properties Tab -	
Curve Object _____	3166
26.14.3 Editors - Properties Editor - Object Data Properties Tab -	
Surface Object _____	3184
26.14.4 Editors - Properties Editor - Object Data Properties Tab -	
Metaball Object _____	3193
26.14.5 Editors - Properties Editor - Object Data Properties Tab -	
Text Object _____	3196
26.14.6 Editors - Properties Editor - Object Data Properties Tab -	
Volume Object _____	3208
26.14.7 Editors - Properties Editor - Object Data Properties Tab -	
Grease Pencil Object _____	3213
26.14.8 Editors - Properties Editor - Object Data Properties Tab -	
Armature Object _____	3227
26.14.9 Editors - Properties Editor - Object Data Properties Tab -	
Lattice Object _____	3242
26.15 Editors - Properties Editor - Material Properties Tab _____	3254
26.16 Editors - Properties Editor - Texture Properties Tab _____	3279
26.17 Editors - Properties Editor - Bone Properties Tab _____	3306
26.18 Editors - Properties Editor - Bone Constraint Properties _____	3316
26.2 Editors - Properties Editor - Render Properties Tab _____	3324
26.3 Editors - Properties Editor - Output Properties Tab _____	3371
26.4 Editors - Properties Editor - View Layer Properties Tab _____	3391
26.5 Editors - Properties Editor - Scene Properties Tab _____	3443

26.6 Editors - Properties Editor - World Properties Tab _____	3455
26.7 Editors - Properties Editor - Collection Properties Tab _____	3462
26.8 Editors - Properties Editor - Object Properties Tab _____	3465
26.9 Editors - Properties Editor - Modifiers Properties Tab _____	3487
26.9.1 Editors - Properties Editor - Modifiers Properties Tab - Mesh - Modify modifiers _____	3492
26.9.10 Editors - Properties Editor - Modifiers Properties Tab - Grease Pencil - Modify modifiers _____	3516
26.9.11 Editors - Properties Editor - Modifiers Properties Tab - Grease Pencil - Generate Modifiers _____	3526
26.9.12 Editors - Properties Editor - Modifiers Properties Tab - Grease Pencil - Deform Modifiers _____	3559
26.9.13 Editors - Properties Editor - Modifiers Properties Tab - Grease Pencil - Color Modifiers _____	3581
26.9.14 Editors - Properties Editor - Modifiers Properties Tab - Lattice - Modify modifiers _____	3594
26.9.15 Editors - Properties Editor - Modifiers Properties Tab - Lattice - Deform Modifiers _____	3597
26.9.16 Editors - Properties Editor - Modifiers Properties Tab - Lattice - Physics Modifiers _____	3616
26.9.2 Editors - Properties Editor - Modifiers Properties Tab - Mesh - Generate modifiers _____	3617
26.9.3 Editors - Properties Editor - Modifiers Properties Tab - Mesh - Deform Modifiers _____	3658
26.9.4 Editors - Properties Editor - Modifiers Properties Tab - Mesh - Physics Modifiers _____	3685
26.9.5 Editors - Properties Editor - Modifiers Properties Tab - Curve&Text - Modify modifiers _____	3698
26.9.6 Editors - Properties Editor - Modifiers Properties Tab - Curve&Text - Generate Modifiers _____	3703

26.9.7 Editors - Properties Editor - Modifiers Properties Tab - Curve&Text - Deform Modifiers _____	3732
26.9.8 Editors - Properties Editor - Modifiers Properties Tab - Curve&Text - Physics Modifiers _____	3752
26.9.9 Editors - Properties Editor - Modifiers Properties Tab - Volume - Modifiers _____	3753
27 Editors - File browser _____	3758
28 Editors - Asset Browser _____	3772
28.1 Asset Browser - Default Asset Library _____	3789
29 Editors - Spreadsheet _____	3794
30 Editors - Preferences _____	3800
31 Data System _____	3847
32 Advanced - Command Line _____	3851
33 Advanced - Scripting & Extending Bforartists _____	3857
34 Advanced - Working Limits _____	3863
35 Bforartists Addons _____	3865
35.1 Bforartists Brush Panels _____	3869
36 Troubleshooting _____	3876
37 Glossary _____	3882
38 About this Manual _____	3898
39 Bforartists History _____	3900
40 Manual Update History _____	3910
41 Standard Keymap _____	3917
42 Important Hotkeys _____	4004

The Bforartists 3 Reference Manual



bFORartists



Version 3.6.2

Introduction

Welcome to the reference manual for Bforartists 3, the free and open source 3D creation suite.

First let's explain what the manual is and what not. It is a reference manual. This means it lists and explains the available tools, the interface and general concepts.

What it is not: it is no general CG tutorial. It will not explain workflows. That's a task for tutorials. It covers however here and there the needed workflow to get a tool working or to explain how it is meant to work.

Chapters 1 to 5 covers general concepts. Chapters 6 to 30 explains the single editors and their tools. And everything afterwards is additional information.

This manual is for Bforartists 3 version 3.6.2 published at 28.08.2023

Web page: <https://www.bforartists.de/>

The source code can be found at GitHub: <https://github.com/Bforartists/Bforartists>



1.1 How to use the manual

Table of content

How to use the Manual.....	1
General Manual structure.....	1
Editor Type.....	2
Editor Area.....	2
Menus, options, tabs and panels.....	3
Object Types and their modes.....	3

How to use the Manual

The question of how to use the manual sounds odd in the first moment. You simply read it! But there are a few things to know before you can really find easily what you are looking for. Because using a 3d software requires some special 3d knowledge. And it needs a bit of knowledge about Bforartists to understand the structure of the manual. So that you can find what you need, both, from coming the software side, and from coming the manual side.

In worst case a manual chapter looks like this:

7.3.14 Editors - 3D View - Sidebar - Tool Tab - Grease Pencil - Weight Paint Mode

How do you supposed to find the needed information here? Why is this title so long? What is a mode, what is a sidebar, a tab? And what is a grease pencil?

Well, the manual chapter names are some sort of breadcrumbs. And you can follow this breadcrumbs. It is always the same pattern, at least for the chapters about the editor types and their tools.

Chapter number - Editor type - Editor area - Tab and panel if available - Object type - and the Mode in which the object needs to be to show the tool.

And with this knowledge you should now easily be able to find what you are looking for. And this in both directions. Coming from the software and searching in the manual. And coming from the manual and searching the tool in the software.

Let's talk about the details.

General Manual structure

Chapter 1 to 6 contains some general information. Like the official key map. Or the general interface. The different single editor types starts with chapter 7. And at the end you will find some miscellaneous information.

Editor Type

The different editor types is the first thing that brings structure into the manual. The different Editor types.

In the shot at the right you see that Bforartists is made of several areas. These are the several editor types. They all have their purpose. You have one editor type for the 3d view. One for the file browser, one for the UV editing, one for the Node editor, and so on. In this shot we see the 3D view (green), Toolbar editor (red), Outliner (pink), the Properties Editor (yellow), at the bottom the Timeline editor (blue). And the header and footer.

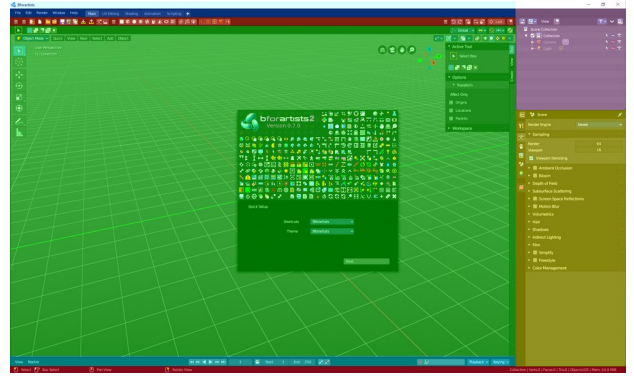

Each editor type has its own main chapter.

Chapter 7 is all about the 3D view. So every chapter that starts with a 7 is a chapter for the 3D view.

Chapter 8 is all about the Image Editor.

Chapter 9 is all about the UV Editor, and so on.

Please have a look in the manual chapter 6 Editors Introduction. Here we list and describe all the different Editor types.

Conclusion

The manual chapter for the editors starts with the number. Followed by the editor type.

Example: 7 Editors - 3D View

Editor Area

Each editor can have several areas. The header, a toolbar at the left, a sidebar at the right, A tools area, the viewport to display and modify the content, some navigation elements, a panel where you can adjust some operations, and maybe even a footer.

Here as an example the 3D view.

At the top is the Tool Settings. Marked with blue. Here you can find settings for the currently active tool.

Below the tool settings is the Header. Marked with pink. It contains menus, tools and settings.

In the middle is the actual viewport. Here you see and modify for example your mesh data.

At the left you can find the Tool Shelf. Marked with green. It contains all the tools.

The yellow area is the navigate widgets.

At the right of it you can find the Sidebar. Marked with blue again. It contains settings and transform values.

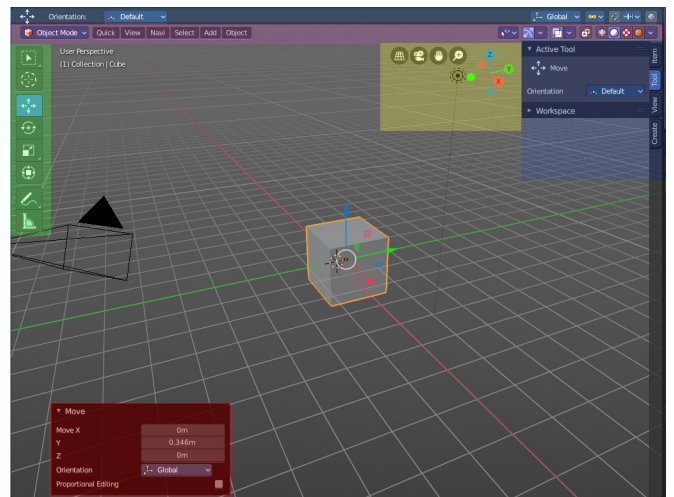

And it is the place where ad dons adds its panels.

At the bottom left you can find the Adjust Last Operation panel. Marked with red. This panel appears when you do an operation, like move the mesh to another location, and allows you to adjust the values for the operation afterwards.

Conclusion

The manual chapter for the editors starts with the number. Followed by the editor type. Followed by the area type.

Example: 7.1 Editors - 3D View - Header

Menus, options, tabs and panels

Text menus and options are usually to find in the Header. So this are logical sub chapters for all header chapters.

Tabs and panels are usually to find in the sidebar. So this is the logical sub chapters for all sidebar chapters.

Conclusion

The manual chapter for the editors starts with the number. Followed by the editor type. Followed by the area type. Followed by the sub types in this area.

Example: 7.1.5 Editors - 3D View - Header - Select Menu

Example: 7.3.2 Editors - 3D View - Sidebar - Tool Tab

Object Types and their modes

There are several object types in Bforartists that you can work with. One of the most common object types is the mesh object.

Each object can have several modes to modify this object type. The mesh object has for example an edit mode where you can modify the mesh. A sculpt mode where you can sculpt the mesh. A vertex paint mode, a weight paint and a texture paint mode.

Each mode has its own tool set. This means that some tools just shows with specific object types and being in a mode where these tools shows.

And this is the last and very important breadcrumb in our manual chapter titles. Object type and required mode.

Conclusion

The manual chapter for the editors starts with the number. Followed by the editor type. Followed by the area type. Followed by the sub types in this area. Followed by object type and needed mode to show these tools.

Example: 7.3.7 Editors - 3D View - Sidebar - Tool Tab - Mesh - Vertex Paint Mode



2 - Installing Bforartists

Table of content

Getting Bforartists.....	2
Download Bforartists.....	2
Minimum Requirements.....	2
Installing on Linux.....	2
Compiling yourself.....	2
Installing.....	3
Running from the terminal.....	3
Avoiding Alt+Mouse Conflict.....	3
Installing on OSX.....	3
Installing on MS-Windows.....	4
Exe.....	4
Uninstalling previous versions.....	4
Zip.....	4
Import previous settings.....	4
Save new Settings.....	5
Configuration.....	5
Language.....	6
Input.....	6
File and Paths.....	6
Input Devices.....	6
Mice.....	6
Mouse Button Emulation.....	6
Keyboards.....	7
Numpad Emulation.....	7
Non-English Keyboards.....	7
Graphic Tablets.....	7
3D Mice.....	7
Configuring Directories.....	7
Platform Dependent Paths.....	7
Linux.....	8
Mac OSX.....	8
MS-Windows.....	9
Path Layout.....	9
Temporary Directory.....	10

Getting Bforartists

Download Bforartists

Bforartists downloads can be downloaded here: <https://www.bforartists.de/content/download>

Bforartists is available for download for Linux, mac OS and MS-Windows. Linux users needs to compile Bforartists by themselves though. We don't have binaries for this OS

There is also the source code available at GitHub. <https://github.com/Bforartists/Bforartists>

Minimum Requirements

Minimum

- 32-bit dual core 2Ghz CPU with SSE2 support.
- 2 GB RAM
- 24 bits 1280×768 display
- Mouse or track pad
- OpenGL 2.1 compatible graphics with 512 MB RAM

Recommended

- 64-bit quad core CPU
- 8 GB RAM
- Full HD display with 24 bit color
- Three button mouse
- OpenGL 3.2 compatible graphics with 2 GB RAM

Installing on Linux

Compiling yourself

There may not be the newest version of Bforartists available for Linux. Or not for your Linux distribution. Or not at all. Means you want or need to compile Bforartists from source code. Here you can find a tutorial that shows the whole process under Linux Ubuntu 17. Most of the process should work for other Linux distributions too.

https://www.bforartists.de/data/tuts/Building_with_Ubuntu17.pdf

Installing

Compile the Linux version for your architecture to the desired location (eg. ~/software or /usr/local).

Bforartists 2 can now be launched by double-clicking the executable.

For easy access, you can configure your system by adding a menu entry or shortcut for Bforartists and associate and open `.blend` files with Bforartists when opening from the file browser. These settings typically belong to the Window Manager (KDE, Gnome, Unity).

Running from the terminal

To run Bforartists from the terminal without needing to be in the executable directory, add the extracted folder to the environment `PATH`.

Add the following command to `.bash_rc` or `.bash_profile` with Bforartists's binary:

```
export PATH=$/path/to/Bforartists-VERSION-linux-glibcVERSION-ARCH:$PATH
```

Tip

If you use daily builds and update Bforartists frequently, you can link or always rename your folder to 'Bforartists' and use this name for the `PATH` environment variable and for keeping the window manager menu up to date.

Avoiding Alt+Mouse Conflict

Many Window Managers default to `Alt - LMB` for moving windows, which is a shortcut that Bforartists uses to simulate a 3 button mouse. You can either have this feature disabled `User Preferences > Input > Emulate 3 Button Mouse` or you can change the Window Manager settings to use the *Meta* key instead (also called *Super* or *Windows key*):

- **KDE:** System Settings > Window Behavior > Window Behavior > Window Actions , Switch 'Alt' for 'Meta' key
- **Unity/Gnome:** enter the following in a command line (effective at next login):

```
gsettings set org.gnome.desktop.wm.preferences mouse-button-modifier '<Super>'
```

Installing on OSX

After downloading Bforartists for Mac-OS X, uncompress the file and drag `Bforartists.app` onto the Applications folder.

Tip

Because *Bforartists* doesn't use the standard OS menu system, you likely have a redundant menu-bar at the top.

To remove it see this post on Macworld, but beware that it is somewhat complex. As an alternative: simply make *Bforartists* full screen by **Alt - F11** or by **File ▶ Window ▶ Toggle Window Full screen**.

Installing on MS-Windows

Exe

Download the installer, and execute it. Follow the advice of the installer.

Uninstalling previous versions

Bforartists 1 and 2 have different folders and settings. This will not conflict. And you can have them installed side by side.

But in case you want to install a new version of Bforartists 2, and have an earlier version of Bforartists 2 already installed, then please uninstall this previous version first. Bforartists is in permanent development. And so lots of things can change with every version. Like which add-on is in what folder, or the number of add-ons at all. And this can lead to dysfunctional or a double set of add-ons or files then when you simply install over the old installation.

Changes at the settings are not affected by uninstalling the software. They are stored in the appdata directory, and will remain. You can work with the old settings, see point below. But there is no guarantee that everything works flawless then. Old settings may or may not work proper.

Zip

Download the .zip file.

Place the zip file where you want Bforartists to be. This can be everywhere at your system. Then extract the zip file. To start Bforartists you have to double click at the exe file inside the created folder now.

It is also recommend to make a shortcut towards this executable. So that you don't have to navigate to the folder all the time when you want to start Bforartists. Place this shortcut at the desktop or the quickstart taskbar.

Import previous settings

When you install a new version of Bforartists and had an older version installed, then you might experience that your old settings are gone, and Bforartists starts with the factory settings again.

Have a look at the splash screen. When there is a button down left, then this means that old settings from the previous version is available. And that you can import it. Which can be done with a click at the Load xxx Settings button.

Bforartists is based at Blender. And follows under the hood the naming conventions of Blender. So the number that you can see at the button here is the Blender version number that was used for the old settings.

This just works for the former version. You can import 2.81 settings in 2.82. But settings from 2.80 does not show.

Beware of possible conflicts. The key map is still in change here and there. New add-ons pr code might conflict with the ones that you have installed.

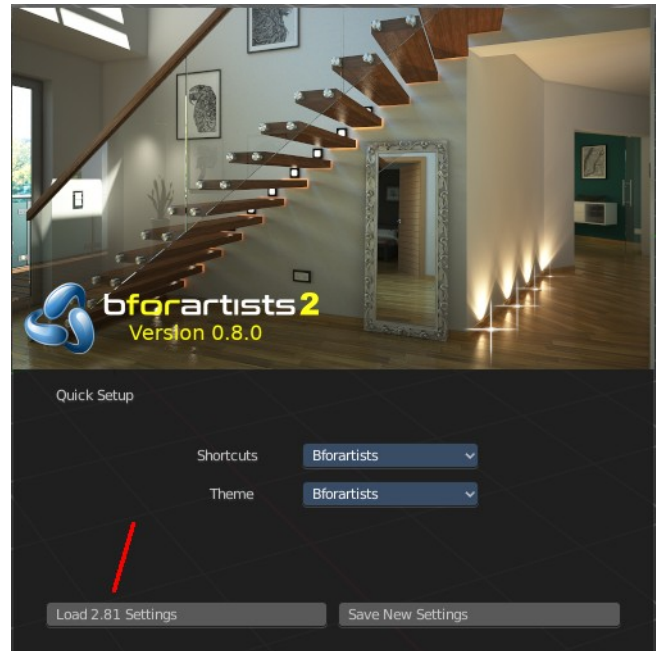

Save new Settings

Bforartists starts with a quick setup dialog as long as you haven't saved the new settings by clicking at the Next button down right. When you save the new settings, then you will see the workflow content like common links and last used scenes.

Note that you will lose the ability to load previous settings when you click at the Save New Settings button. So when you want to import old settings, do this step first.

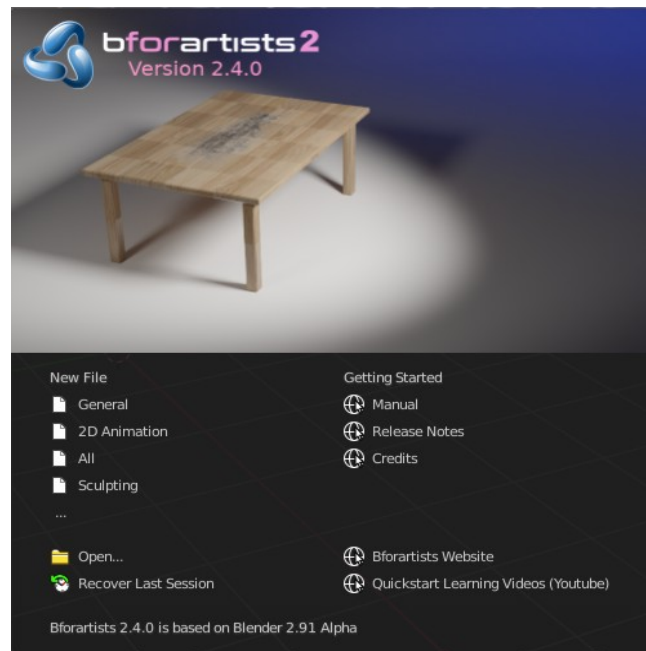

Configuration

Here are some quick preferences that you may wish to set as quickly as possible. The full list and explanation of the preferences is in the section *User Preferences*.

Language

At File ▶ User Preferences ▶ System, enable **International Fonts** to choose the **Language** and what to translate from **Interface**, **Tool tips** and **New Data**. See more at [Internationalization](#)

Input

If you have a compact keyboard without a separate number pad enable File ▶ User Preferences ▶ Emulate Numpad.

If you don't have a middle mouse button you can enable File ▶ User Preferences ▶ Emulate 3 Button Mouse.

File and Paths

At File ▶ User Preferences ▶ File you can set options such as what external **Image Editor** to use, such as GIMP or Krita, and the **Animation Player**.

The **Temp** directory sets where to store files such as temporary renders and autosaves.

Tip

// at the start of a path in Bforartists means the directory of the currently opened **.blend** file, used to reference relative-paths.

If you trust the source of your `.blend` files, you can enable `Auto Run Python Scripts`. This option is meant to protect you from malicious Python scripts that someone can include inside a Bforartists file. This would not happen by accident, and most users leave this option on to automatically run scripts such as `Rigify` that controls the skeleton of a human rig.

Input Devices

Bforartists supports various types of input devices:

Keyboard (recommended: keyboard with numeric keypad, English layout works best)

Mouse (recommended: 3 button mouse with scroll wheel)

NDOF Devices (also known as *3D Mouse*)

Graphic Tablets

Mice

Mouse Button Emulation

If you do not have a 3 button mouse, you will need to emulate it by checking the option in the User Preferences.

The following table shows the combinations used:

3-button Mouse	LMB	MMB	RMB
2-button Mouse	LMB	Alt-LMB	RMB

Keyboards

Numpad Emulation

If you do not have a numeric Numpad on the side of your keyboard, at a laptop for example, you may want to emulate one (uses the numbers at the top of the keyboard instead, however, removes quick access to layer visibility).

Non-English Keyboards

Bforartists defaults are made for an English keyboard layout. It works fine at non-English keyboards in most cases. But in the input manager in the user preferences you may stumble across some oddities.

Graphic Tablets

Graphics tablets can be used to provide a more traditional method of controlling the mouse cursor using a pen. This can help to provide a more familiar experience for artists who are used to painting and drawing with similar tools, as well as provide additional controls such as pressure sensitivity.

3D Mice

3D Mice or NDOF devices are hardware that you can use to navigate a scene in Bforartists. Currently only devices made by 3Dconnexion are supported. These devices allow you to explore a scene, as well as Walk/Fly modes.

Configuring Directories

There are three different directories Bforartists may use, their exact locations are operating system dependent.

LOCAL

Location of configuration and runtime data (for self contained bundle)

USER

Location of configuration files (normally in the user's home directory).

SYSTEM

Location of runtime data for system wide installation (may be read-only).

For system installations both **SYSTEM** and **USER** directories are needed.

For locally extracted Bforartists distributions, the user configuration and data runtime data are kept in the same sub-directory, allowing multiple Bforartists versions to run without conflict, ignoring the **USER** and **SYSTEM** files.

Note

You may need to have the “show hidden files” option checked in your file browser settings.

Platform Dependent Paths

Every OS handles the peripheral paths a bit different. The default locations for each system are as follow. Note that the path `./|BFORARTISTS_VERSION|/` is relative to the Bforartists executable.

Linux

LOCAL

`./2.80/`

USER

`$HOME/.config/Bforartists/2.80/`

SYSTEM

`/usr/share/Bforartists/2.80/`

Note

The **USER** path will use `$XDG_CONFIG_HOME` if its set:

`$XDG_CONFIG_HOME/Bforartists/2.80/`

Mac OSX

LOCAL

`./2.80/`

USER

`/Users/$USER/Library/Application Support/Bforartists/2.80/`

SYSTEM

`/Library/Application Support/Bforartists/2.80/`

Note

OSX stores the Bforartists binary in `./Bforartists.app/Contents/MacOS/Bforartists`, so the local path to data & config is:

`./Bforartists.app/Contents/MacOS/2.80/`

MS-Windows

LOCAL

`.\2.80\.`

USER

`C:\Documents and Settings\%USERNAME%\AppData\Roaming\Bforartists\Bforartists\2.80\`

SYSTEM

`C:\Documents and Settings\All Users\AppData\Roaming\Bforartists\Bforartists\2.80\`

Path Layout

This is the path layout which is used within the directories described above.

Where `./config/startup.blend` could be `~/.Bforartists/2.80/config/startup.blend` for example.

`./autosave/ ...`

Autosave blend file location. *Windows only, temp directory used for other systems.*

Search order: LOCAL, USER.

`./config/ ...`

Defaults & session info.

Search order: LOCAL, USER.

`./config/startup.blend`

Default file to load on startup.

`./config/userpref.blend`

Default preferences to load on startup.

`./config/bookmarks.txt`

File selector bookmarks.

`./config/recent-files.txt`

Recent file menu list.

`./datafiles/ ...`

Runtime files.

Search order: LOCAL, USER, SYSTEM

`./datafiles/locale/{language}/`

Static precompiled language files for UI translation.

`./datafiles/icons/*.png`

Icon themes for Bforartists user interface. *Not currently selectable in the theme preferences.*

`./datafiles/brushicons/*.png`

Images for each brush.

`./scripts/ ...`

Python scripts for the user interface and tools.

Search order: LOCAL, USER, SYSTEM.

`./scripts/addons/*.py`

Python add-ons which may be enabled in the user preferences, includes import/export format support, render engine integration and many handy utilities.

`./scripts/addons/modules/*.py`

Modules for add-ons to use (added to Python's `sys.path`).

`./scripts/addons_contrib/*.py`

Another add-ons directory which is used for community maintained add-ons (must be manually created).

`./scripts/addons_contrib/modules/*.py`

Modules for `addons_contrib` to use (added to Python's `sys.path`).

`./scripts/modules/*.py`

Python modules containing our core API and utility functions for other scripts to import (added to Python's `sys.path`).

`./scripts/startup/*.py`

Scripts which are automatically imported on startup.

`./scripts/presets/{preset}/*.py`

Presets used for storing user defined settings for cloth, render formats etc.

`./scripts/templates/*.py`

Example scripts which can be accessed from: Text Space's Header → Text → Script Templates.

`./python/ ...`

Bundled Python distribution, only necessary when the system Python installation is absent or incompatible.

Search order: LOCAL, SYSTEM.

Temporary Directory

The temporary directory is used to store various files at run-time (including render layers, physics cache, copy-paste buffer and crash logs).

The temporary directory is selected based on the following priority:

- User Preference
- Environment variables (`TEMP` on MS-Windows, `TMP` & `TMP_DIR` on other platforms).
- The `/tmp/` directory.



3 - Interface

Table of content

Tooltips.....	2
Interface.....	2
User Interface Principles.....	3
Splash Screen.....	3
Header.....	4
Scroll Header.....	4
Show / Hide header.....	4
Flip Header to top or bottom.....	5
Panels.....	5
Pinning panels.....	5
Open just one Panel at a time.....	5
Tabs.....	6
Menus, Buttons and Controls.....	6
Menu.....	6
Button.....	6
Toggles.....	6
Edit Box.....	6
Snapping.....	7
Drop down box.....	7
Color Picker.....	7
Widgets.....	7
Cursors.....	8
Value Editing.....	8
Multi Value Editing.....	8
Expressions.....	8
Expressions as Drivers.....	8
Units.....	8
Unit Names.....	9
Menu shortcuts.....	9
Tool Shelf.....	10
Opening and closing by menu and hotkey.....	10
Resize.....	10
Open Tool Shelf by Plus Button.....	10
Sidebar.....	10
Opening and closing by menu and hotkey.....	10
Resize.....	11
Open Sidebar by Plus Button.....	11
Input Devices.....	11
Non English Keyboard.....	11

Tooltips

When you hover with the mouse over an UI element, like a button, then you can see a tooltip.

A tooltip can contain the tool name, a short description of the tool, the hotkey, and a Python tooltip.

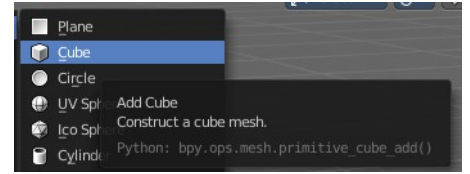

The Python tool tip shows you the name of the operator. It is of interest for programming needs. It can be turned off in the User Preferences.

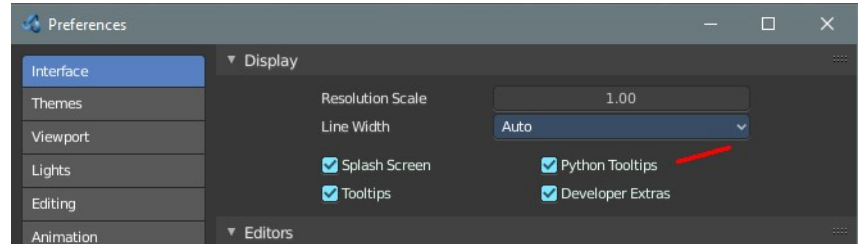

The tool tips in the Tool Shelf acts a bit different than the tool tips in the rest of the UI. It will not show you the Python tool tips, since it is a gigantic hack on top of the existing UI.

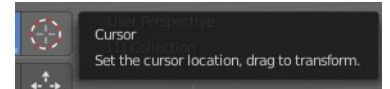

Interface

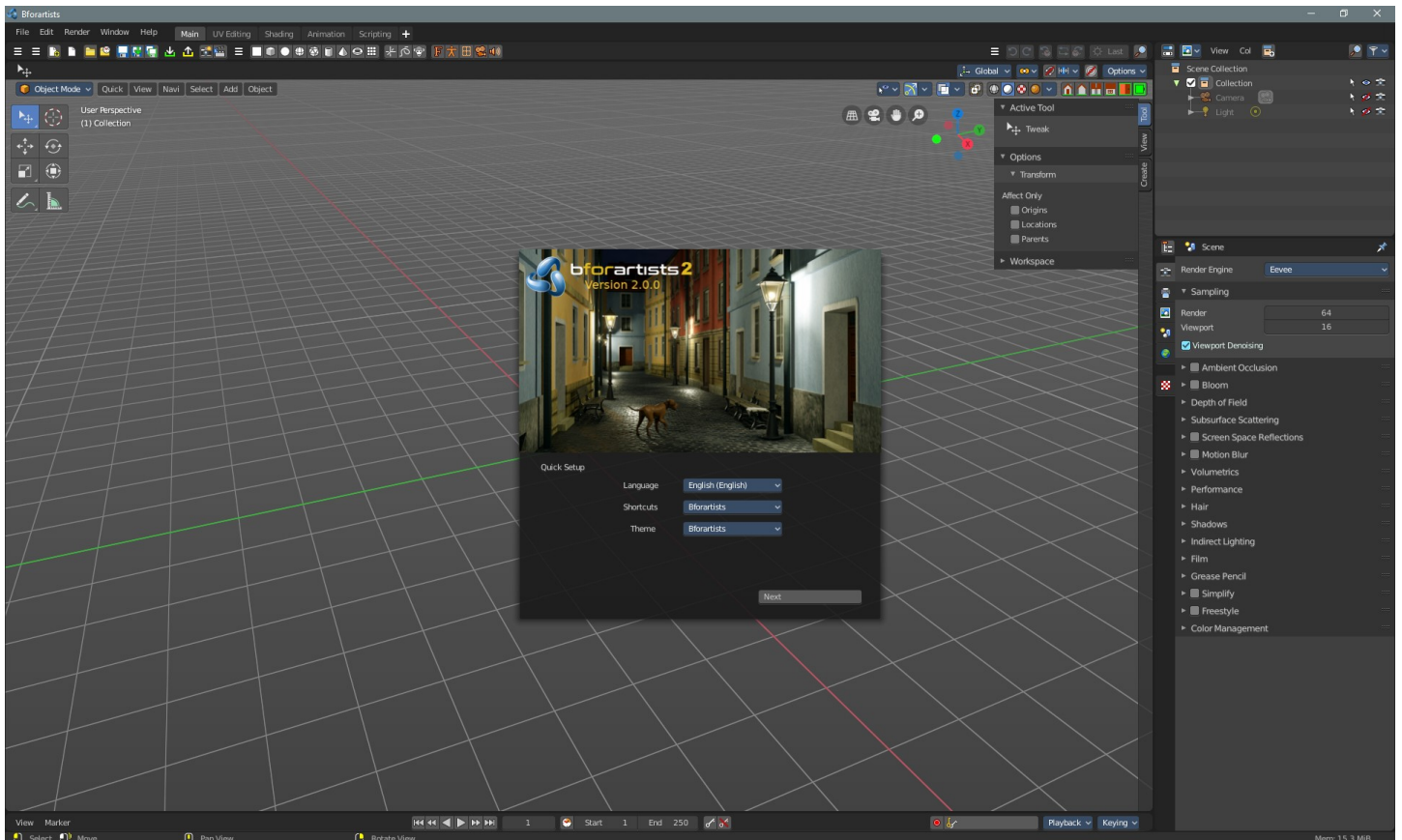

User Interface Principles

The UI is made of several different workspaces. Each workspace is made of several editors for the different purposes. And this editors are made of several sub elements. Like a Header or a tool shelf, or a sidebar. UI elements are organized in tabs, menus and panels.

The idea is to have a non overlapping and blocking UI with a non modal tool set. Which is just partially to achieve. See header below. And by the fact that you work in modes ...

As a consequence of the non overlapping UI concept, the interface avoids to work with popup panels where possible. You can adjust the tool after you use it, in the so called last operation panel. It can be found in the 3D view for example, down left.

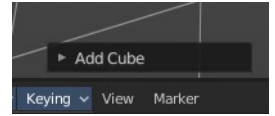

Splash Screen

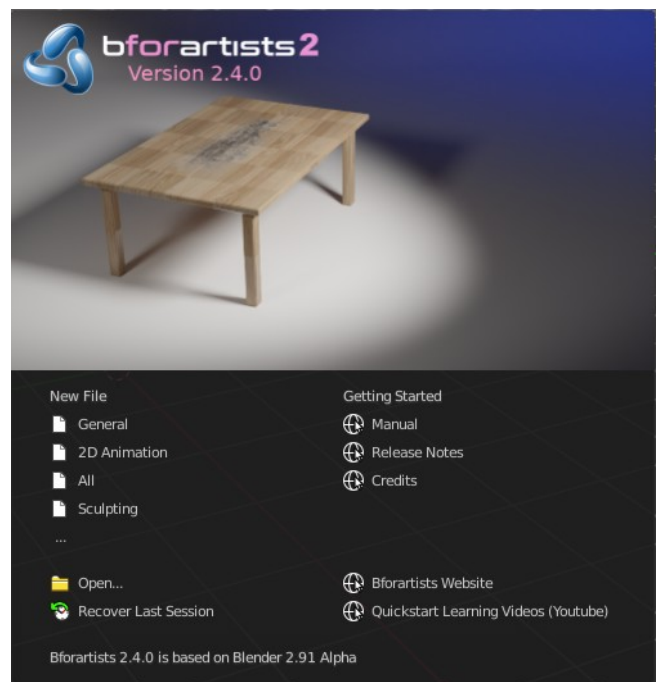

The splash screen shows at startup. You can turn it off in the User Preferences.

At the very first start you can do a quick setup, and choose with what language and key map and what theme you want to work. Clicking at the Next button will then make this change permanent.

It is recommend to click at the Next button, since it creates some needed directories.

When you don't have any recent files, then the splash screen shows a Getting Started section with some links to useful resources.

And when you have recent files, then the splash screen lists them instead of the Getting Started section.

Here you can read at what Blender version the current Bforartists version is based at.

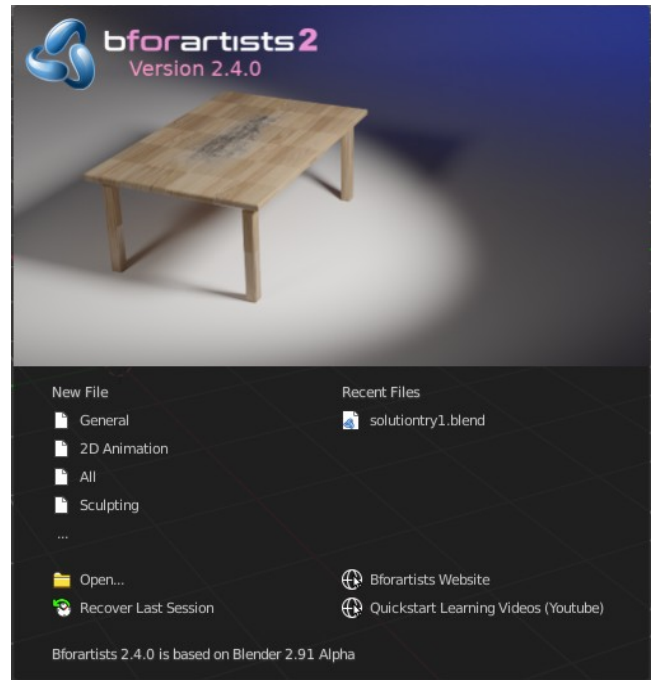

Header

Every editor has a header area. It usually contains the menu. And some tools or settings.

Scroll Header

A header can be scrolled! This is especially useful in the layouts where the header is this crowded with tools that it doesn't fit to display all content into the layout anymore. This is for example the case in the UV layout.

To scroll the header, click with the middle mouse button at it, and drag.

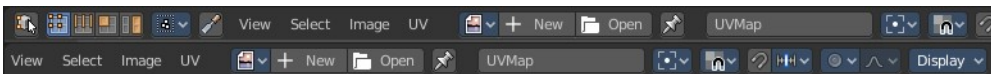

Show / Hide header

You can hide the header in the right click menu. The Toggle Header menu item. Then the menu vanishes. Obviously you can't reveal the header this way, since now the header is hidden, and the "toggle" is not to reach anymore. But there is another way.

Hidden headers shows a little triangle button at the right side. You can reveal the header by clicking at it.

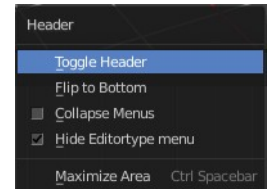

Flip Header to top or bottom

The header can either be displayed at the top or at the bottom.

Right click at an empty space somewhere at the menu bar of an editor. You will see a menu now. This allows you to choose if you want to display the menu bar at the top of the editor, or at the bottom. The menu item is either called Flip to Top, or Flip to Bottom, dependent of the current status.

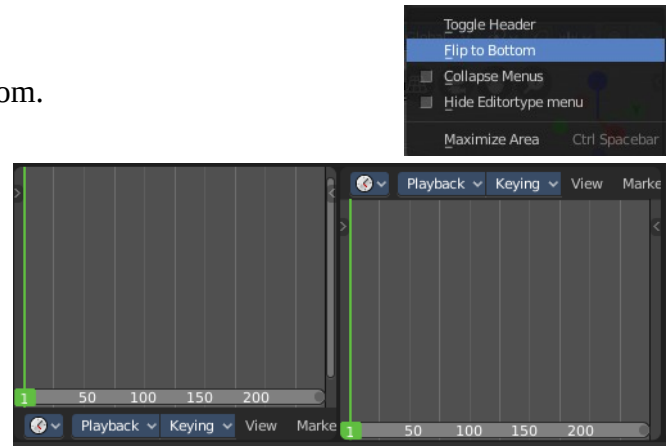

Panels

A Panel is a container that contains tools and settings. They are used in quite a few locations. In the Properties editor for example. Or in the sidebars.

Panels can be rearranged in order. Simply drag them over each other to achieve the order that you need.

Panels can be expanded and collapsed by clicking at the title bar.

When you hold down ctrl and click at the title bar then this panel will open, and all other panels will close.

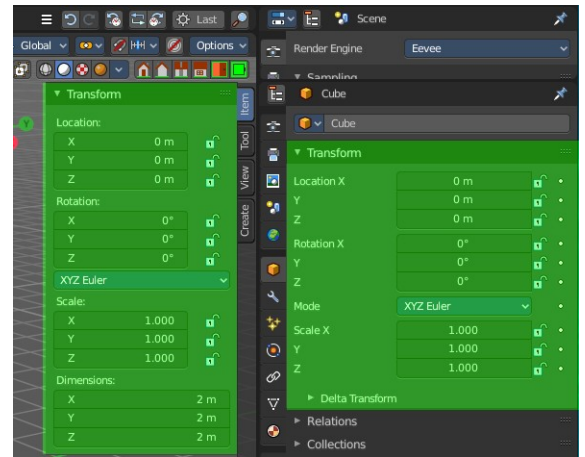

Pinning panels

Normally the tabs just displays the panels of the current tab. But you can pin panels so that they display always. This counts also for content from other tabs. Here i have pinned the panel from the Mini Lightlib in the Create tab. And it shows in the View tab now.

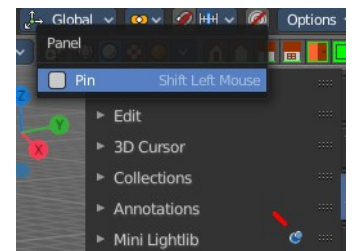

Right click at the tab that you want to pin. A menu pops up. Check the Pin checkbox. The tab will now show a pin, and will display permanently.

To unpin the panel simply click at the Pin icon.

Open just one Panel at a time

This can be done by clicking at the header of a panel and holding down ctrl.

Tabs

The Sidebars can have Tabs to switch between different content. Also the Properties editor has them. The tabs helps to organize the available tools into categories. In the 3D view it's also a common place where addons adds themselves.

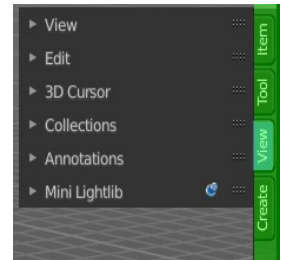

Menus, Buttons and Controls

The UI contains various control elements. Buttons, Menus, toggles, etc.

Menu

In the header you may find text menus. A text menu contains usually buttons. But it can also contain toggles. Or other menus.

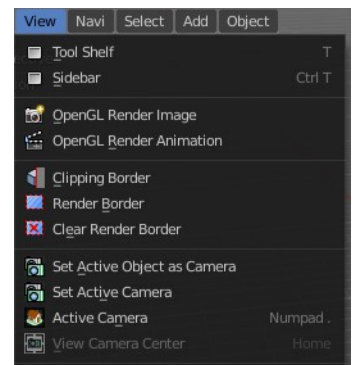

Button

A button is a UI element that allows you to perform an operation at click. There are various button types in the UI. Text Buttons in the text menus, text buttons in the panels, and icon buttons in the header and in the tool shelf.

Toggles

Toggles can be radio buttons. But also icon or text buttons. Where they are the same is that they have states. On and off for example. They can also have more states than just two.

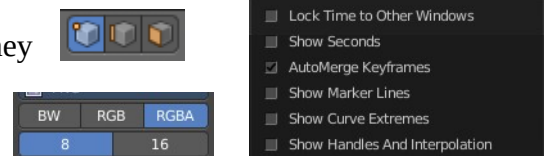

Edit Box

Some UI elements are editable. Edit boxes are used for things like position, angle, name, etc. . Click into the editable area to enter the edit mode. Do the changes, like typing in a new value, then press Enter to confirm the change.

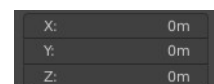

Value edit boxes have some extra functionality. They work as sliders too. Hover with the mouse over the edit box. The mouse cursor will turn into two arrows.

Snapping

Sliders can snap incrementally. Hover with the mouse over the slider, start to slide, and holding down **Ctrl** will snap the sliders in incremental steps.



When it's a default value between 0 and 1 then it usually snaps in 0.1 steps. When it's a default value over 1 then it usually snaps in steps of 10.

Drop down box

A drop down box is another kind of a menu. Usually you choose something here. Like a special setting. Or when you add a modifier. A list drop down box can show you the loaded textures for example. and allow you to choose another one.

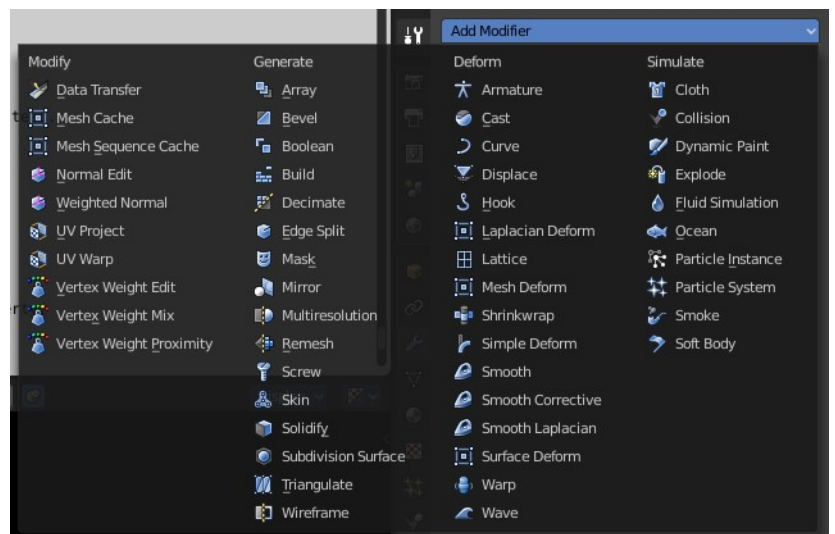
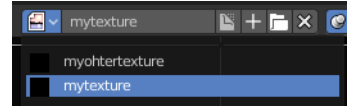

Color Picker

You may stumble across color pickers in the UI. When you do a painting job for example. This allows you to adjust color for the specific task. Like adjusting the brush color.



Widgets

There are various widget types in Bforartists to find. Most of them in the 3D View. Widgets allows you to manipulate the transformation along one or more axis.

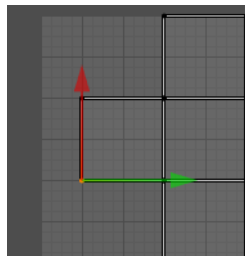
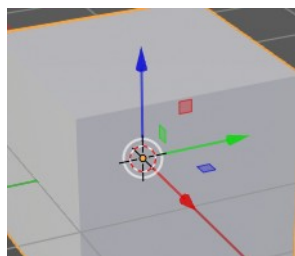

Cursors

A cursor is a center point, and allows manipulation in different ways. Objects gets created at the 3D cursor in the 3D view. You can set the cursor at different locations. You can snap it to elements, and you can snap elements to it.

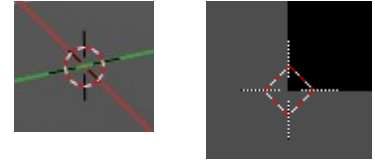

Value Editing

You will find lots of value edit boxes in the Bforartists interface. To set the render size for example. Or to set the position of an object.

Multi Value Editing

Sometimes you want to edit multiple values at once. The object scale for example. This can be done by clicking into the first edit box, and then drag with the mouse across the other edit boxes. They will become active now. And when you edit one value, then the other values will change too.

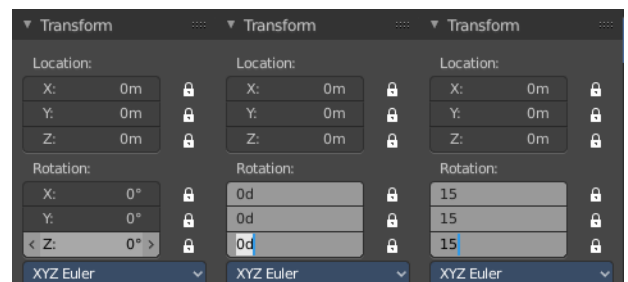

Expressions

You can also enter expressions in value edit boxes. And the result will be calculated. For example, $3 * 2$ instead of 6. or $5 / 10 + 3$. Even constants like π (3.142) or functions like $\text{sqrt}(2)$ (square root of 2) may be used.

Expressions as Drivers

You may want your expression to be re-evaluated after its entered. Blender supports this using *Drivers* (a feature of the animation system).

Expression beginning with #, have a special use. Instead of evaluating the value and discarding the expression, a driver is added to the property with the expression entered.

The expression `#frame` is a quick way to access map a value to the current frame, but more complex expressions are also supported `#fmod(frame, 24) / 24` for example.

This is simply a convenient shortcut to add drivers which can also be added via the RMB menu.

Units

You can mix units with numbers. This means when you work in meters, then you can type in cm for centimeters. And the correct value will be used then.

You can even mix units in the same expression. For example $1\text{m}, 3\text{mm}$. Or do complex mathematical calculations like $2.2\text{mm} + 5' / 3'' - 2\text{yards}$.

Commas are optional.

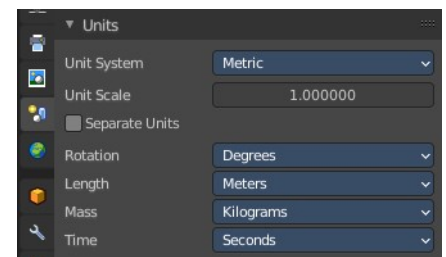

Units can be adjusted in the Properties Editor in the Scene tab in the Units panel.

Such units needs to be set in the scene settings. Metric or Imperial.

Unit Names

Unit names have can be used with both long and short forms. Both is recognized.

Here is a list of recognized unit names you can use. Plurals of the names are recognized too, so `meter` and `meters` can both be used.

Imperial Units

Full Name	Short Name(s)	Scale of a Meter
thou	mi l	0.0000254
inch	", in	0.0254
foot, feet	', ft	0.3048
yard	yd	0.9144
chain	ch	20.1168
furlong	fur	201.168
mile	mi, m	1609.344

Metric Units

Full Name	Short Name(s)	Scale of a Meter
micrometer	um	0.000001
millimeter	mm	0.001
centimeter	cm	0.01
decimeter	dm	0.1
meter	m	1.0
dekameter	dam	10.0
hectometer	hm	100.0
kilometer	km	1000.0

Menu shortcuts

- Arrow keys can be used to navigate into a menu
- Each menu item has an underlined character which can be pressed to activate it.
- Number keys or numpad can be used to access menu items. (Where **1** is the first menu item, **2** the second... etc. For larger menus **Alt - 1** the 11th... up to **Alt - 0** the 20th)
- Press **Return** to activate the selected menu item.
- Press **ESC** to cancel the menu.

Tool Shelf

Some editors have a Tool Shelf at the left side. This tool shelf contains the tools. It can be resized by dragging. It can be closed and opened.



Opening and closing by menu and hotkey

The view menu provides you with menus to close and to open the Tool shelf.

It also shows the hotkey.

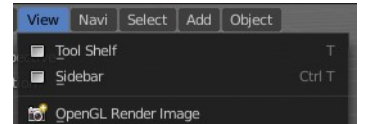

Resize

You can grab the border and drag the Tool Shelf and the Properties Sidebar to the left or to the right to expand or to close it.

The tool shelf shows a special behavior when you drag it bigger. Then the icon buttons becomes text buttons.



Open Tool Shelf by Plus Button

When a sidebar is closed then you will see a little plus button. When you click at this button then the sidebar will reappear.



Sidebar

Some editors have a Sidebar at the right side. It can be resized by dragging. It can be closed and opened.

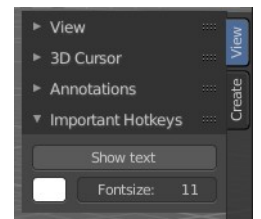

Opening and closing by menu and hotkey

The view menu provides you with menus to close and to open the Tool shelf.

It also shows the hotkey.

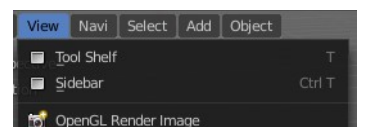

Resize

You can grab the border and drag the Sidebar to the left or to the right to expand or to close it.

Open Sidebar by Plus Button

When a sidebar is closed then you will see a little plus button. When you click at this button then the sidebar will reappear.



Input Devices

Bforartists supports various types of input devices:

- Keyboard (recommended: keyboard with numeric keypad, English layout works best)
- Mouse (recommended: 3 button mouse with scroll wheel)
- NDOF Devices (also known as *3D Mouse*)
- Graphic Tablets

Non English Keyboard

If you use a keyboard with a non-English keyboard layout, you may stumble across bugs and quirks and odd behaviors. Blender was developed for and with the UK or US layout. Some quirks for other keyboard layouts slipped through. And quite a few of those old bugs are still unfixed in Bforartists too.



4 Workspaces

Table of content

Introduction.....	2
Modifying Workspaces.....	2
Resizing Editor Windows.....	2
Splitting Editor Windows.....	3
Unioning Editor Windows.....	3
Swapping Contents.....	3
Make Editor Window floating.....	4
Change Editor Type.....	4
Show / Hide the editor type menu.....	4
Collapse Menus.....	5
Resize Tool Shelf and Properties content.....	5
Create new Workspace.....	5
Workspace Settings.....	6
Save changes at the Workspace.....	6
Delete Workspace.....	7
Load Workspace layout from Blend Files.....	7
Standard Workspaces.....	8
Default.....	8
Modeling.....	8
Sculpting.....	8
UV Editing.....	9
Texture Painting.....	9
Shading.....	9
Nodes.....	10
Animation.....	10
Compositing.....	10
Rendering.....	11
Scripting.....	11
2D Animation.....	11
Full Canvas.....	12
Material.....	12
Masking.....	12
Motion Tracking.....	13
Video Editing.....	13
Assets.....	13

Introduction

A Workspace is a layout with different editors. For example, in most workspaces you have a 3d view editor, an outliner and a properties editor. It includes Top Bar and Footer. And every workspace can have some specific settings. The Sculpting Workspace starts for example in Sculpt mode. And not in Edit Mode like the default workspace.

To switch between the workspaces simply click at the tabs.

The chapter tabs and default workspaces is explained in the chapter Topbar. It is menu functionality. And menu functionality gets explained where the menu is.

This chapter here is about the general functionality of workspaces.

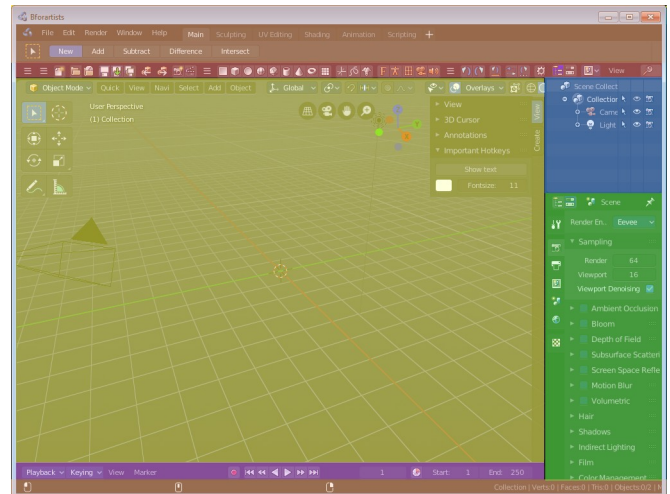

Modifying Workspaces

Resizing Editor Windows

Move the mouse over a border between the editors. The mouse cursor will turn into a double arrow. Drag the arrow around and the editor will resize with your moving mouse.

In the Default layout there are two editors that are collapsed to just show the menu. The menu bar at the top is an own editor. The Info editor. You can drag it down to reveal a text field. Here Bforartists displays all the former actions as strings. When you create a primitive for example, then it displays a string with the python command for it.

The other collapsed editor is at the bottom. The timeline.

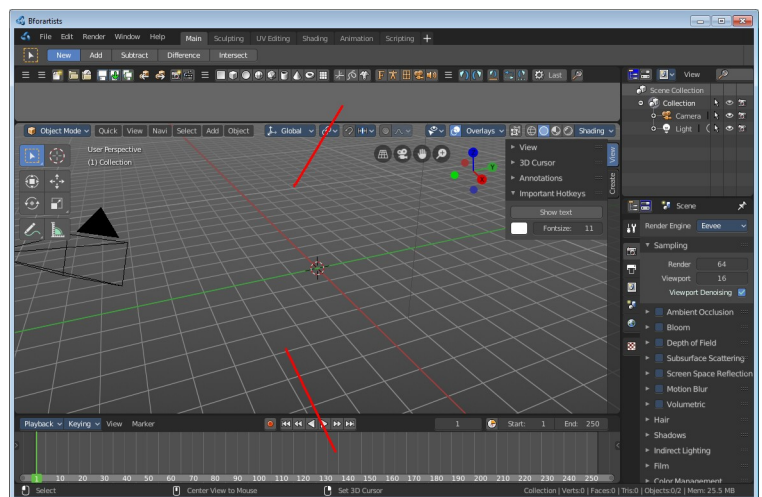
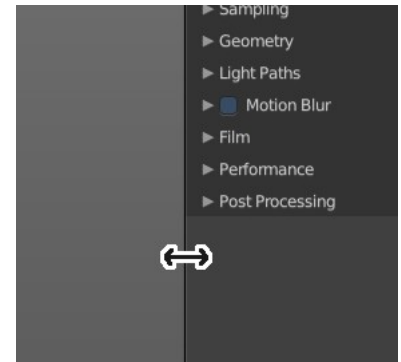

Splitting Editor Windows

When you move the mouse over the upper corner of an editor window, then the mouse pointer turns into a white cross.

When you click and drag the mouse inwards of the current editor, then the editor splits up. You open a second 3D view for example.

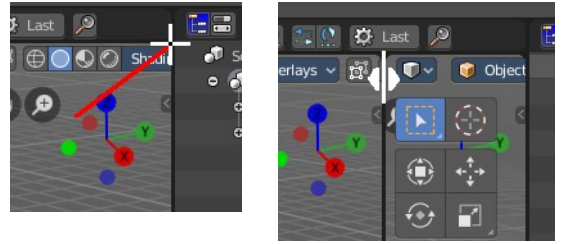

Unioning Editor Windows

The method is nearly the same than with splitting the editor windows. When you move the mouse over the upper corner of an editor window, then the mouse pointer turns into a white cross.

When you click and drag the mouse outwards of the current editor, then the editor unions with the neighbor editor. Note that this just works when they are in one row, horizontally or vertically.

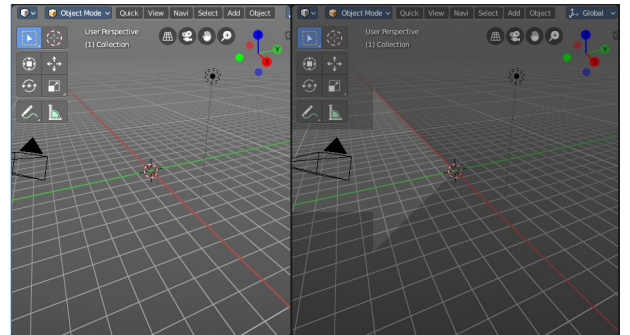

Swapping Contents

You can swap the contents between two editors with clicking at the corner area, holding Ctrl, and drag into the target editor. The mouse pointer will turn into a swap icon. When you release the mouse the two editors will swap their positions.

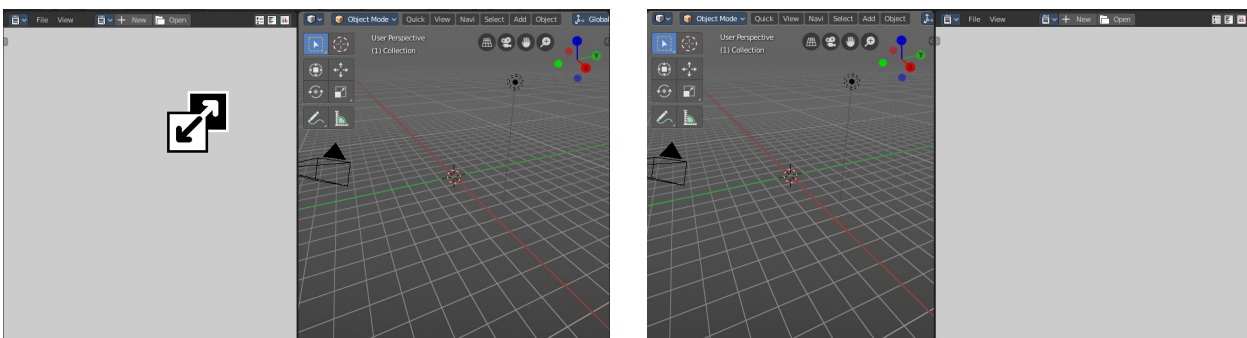

Make Editor Window floating

When you move the mouse over the upper corner of an editor window, then the mouse pointer turns into a white cross.

Hold down Shift, and drag the mouse. The editor will detach from the Blender surface. This is useful for a multi monitor setup for example. Now you can place this editor at Monitor 2.

Note that there is no way to reintegrate this floating editor window back into the Blender UI once it is detached. You have to close it.

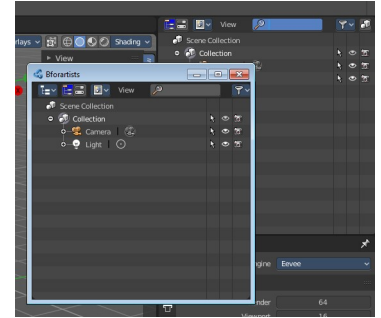

Change Editor Type

There is a Editor Type menu in every header. This menu is usually hidden in the default layouts. It can be revealed by either splitting the editor window. Or in the right click menu in the header. Hide editortype menu. See next point.

When you click at this button then a menu with all available editor types opens up. And you can change the current editor to another editor type.

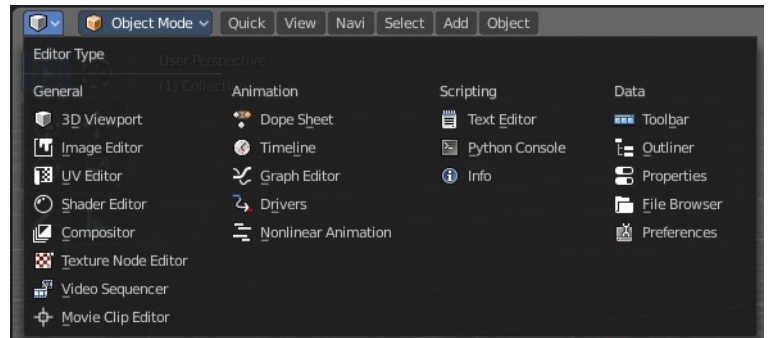
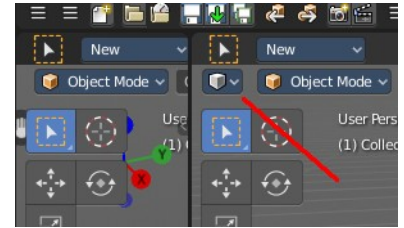
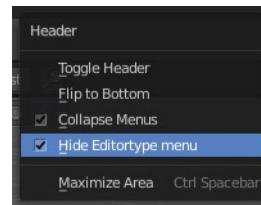

Show / Hide the editor type menu

You might have noticed that the editor type menu is not available in the editors of the standard layouts. This is to reduce visual noise and to free some UI space.

You can show and hide this editor type menu. To do so right click at an empty space somewhere at the menu bar of an editor. You will see a menu now. Check or uncheck the menu item Hide Editortype Menu to show or hide the Editor Type menu.

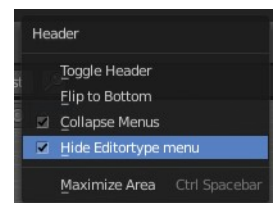

Collapse Menus

The text menus can be collapsed to free some UI space. Right click at an empty space somewhere at the menu bar of an editor. You will see a menu now. Choose if you want to display the text menu collapsed or expanded.

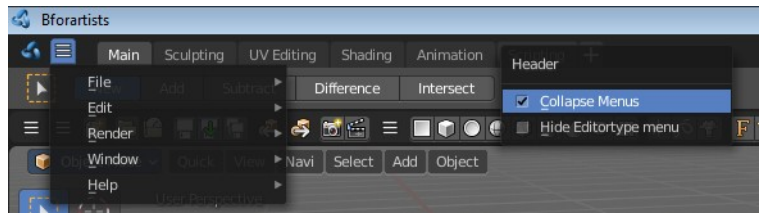

Resize Tool Shelf and Properties content

You can resize the Tool Shelf content and the Properties Sidebar content. This means that you can zoom in or out. This trick also works in the Properties Editor.

Move the mouse over the upper region of the Tool Shelf.
 Hold down Ctrl key
 Click with Middle Mouse button. The mouse pointer will turn into two white triangles.

Now drag up or down to resize the area content

OR

Move the mouse over the upper region of the Tool Shelf.
 Simply press Numpad + or Numpad -



To reset the area content to default scale move the mouse over the area and press Home key (german keyboard layout Pos 1)

Create new Workspace

Click at the + sign at the right of the tabs. The Add Workspace menu will open up. Choose Duplicate Current. This will create a new tab. The name will be something like mycurrentworkspace.001.

To rename the new layout double click at the name. The text becomes editable.

Now you can start to edit your workspace and its settings.

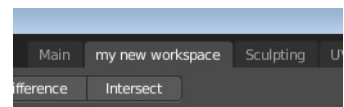
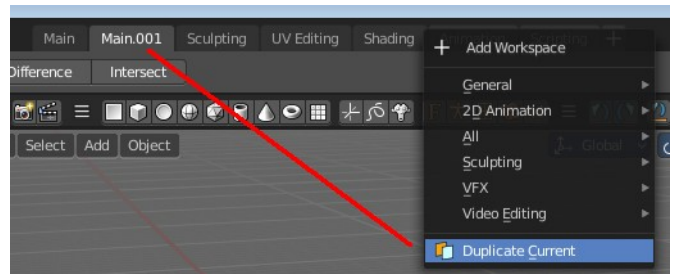

Workspace Settings

A workspace is not only a set of editor windows. In the Properties editor you can also find some workspace specific settings.

In this settings you can define in what mode the workspace starts. You can exclude addons. And you can add custom properties. Which are basically just values for scripting needs.

The settings from this panel will load every time you switch to this workspace.

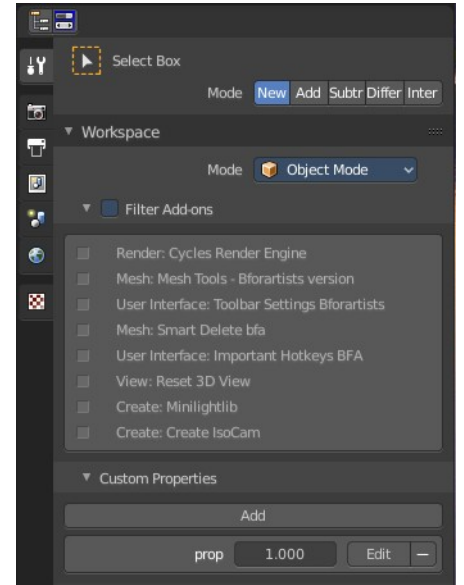

Save changes at the Workspace

You cannot save new workspaces or modifications at an existing workspace directly. To save modifications at an existing workspace you have to save the Startup File. This menu item can be found in the File menu.

Once saved you will find this new workspace also in the add workspace menu under your template.

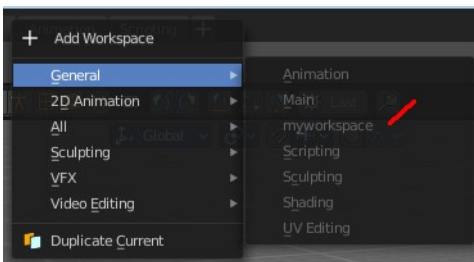
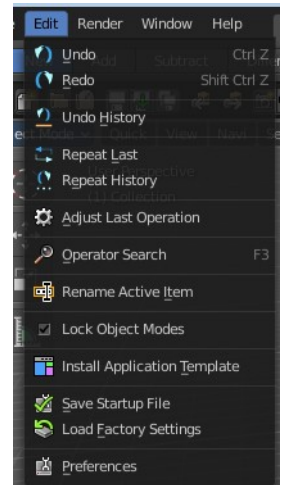

When you are in the default application template then this settings will save the new workspace to the defaults.

When you are in one of the other application templates though, then you will save the new workspace to the template. Same counts for the factory settings. You will then load the factory settings from the current active application template.

The menu entry will also look a bit different then. You will see a label that gives you a hint about the current application template in use. In this case the sculpting application template.

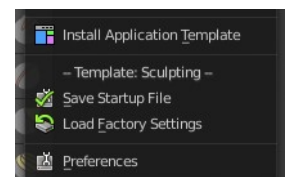

Note that this also affects other changes. Bforartists will for example now start with the currently active layout. And it will also preserve the changes that you did at other layouts before saving.

So when you work at a layout be sure that you don't accidentally do changes at other areas. And before you save the startup file you should switch back to the layout with which you want to start Bforartists.

Delete Workspace

Workspace can also be deleted. To do so right click at the tab that you want to delete, and choose delete in the menu.

Note that you can remove your own created workspaces this way. But the default workspaces will remain in the menus. They will just vanish from the tabs. These workspaces are protected so that you cannot remove them completely.

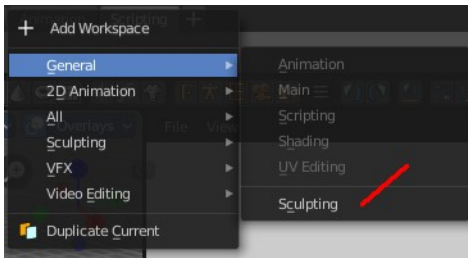
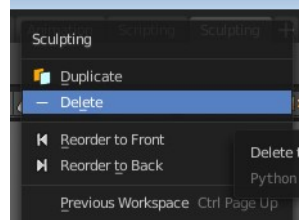

Load Workspace layout from Blend Files

Every blend file saves also the layout in which the scene is at the point of saving. Means you can load a layout from the blend file.

This feature is off by default since it is usually unwanted behavior to load layouts from other people.

You can turn it on in the User Preferences in the File tab. Tick the menu item Load UI. Then save User Settings.

Note that now all Blend files that you open will load the workspace layout that the Blend files are saved with.

You can also do this at a file by file base. The file browser allows you to load a blend file with the saved layout. This setting can be found down left in the file browser.

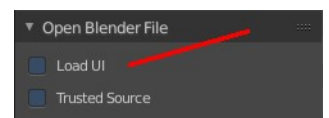
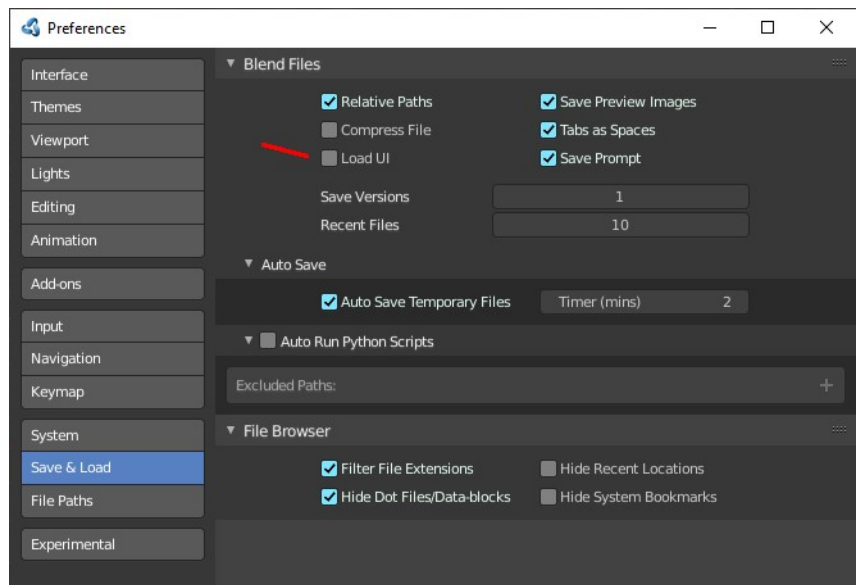

Standard Workspaces

Default

This layout is for general 3D work. Here you work at your 3D scene. Here happens modeling, texturing, etc. . It is also the workspace with which Bforartists opens up. It contains a 3D View editor, an Info editor, a Timeline editor, a Outliner editor and a Properties editor.

It starts in Object Mode.

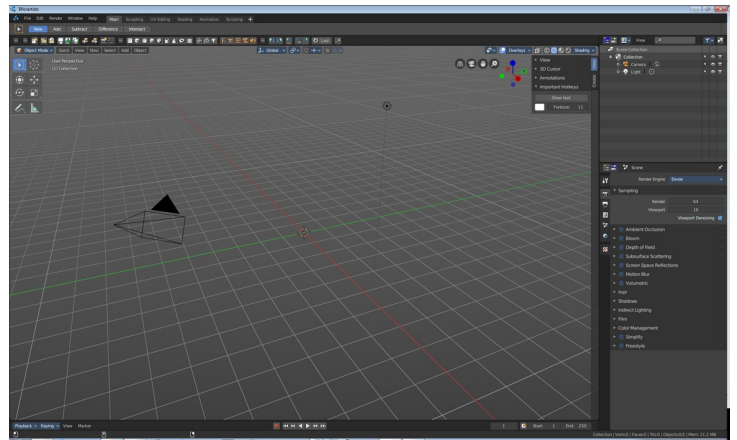

Modeling

Same as the Default workspace.

It starts in Object Mode.

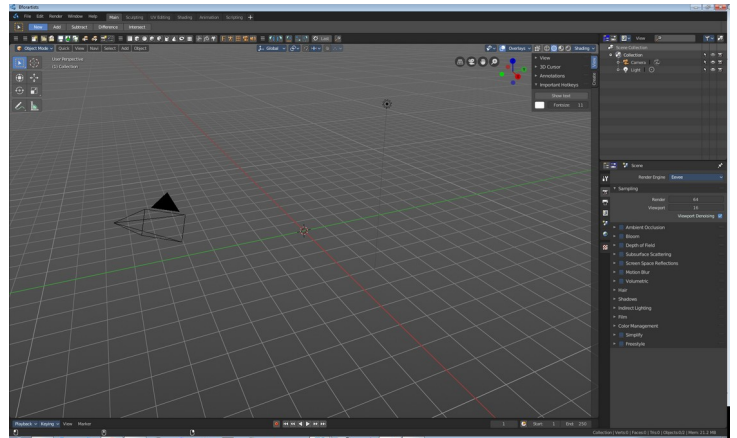

Sculpting

This workspace is dedicated to sculpting.

It starts in Sculpt Mode in case you have an object in the scene.

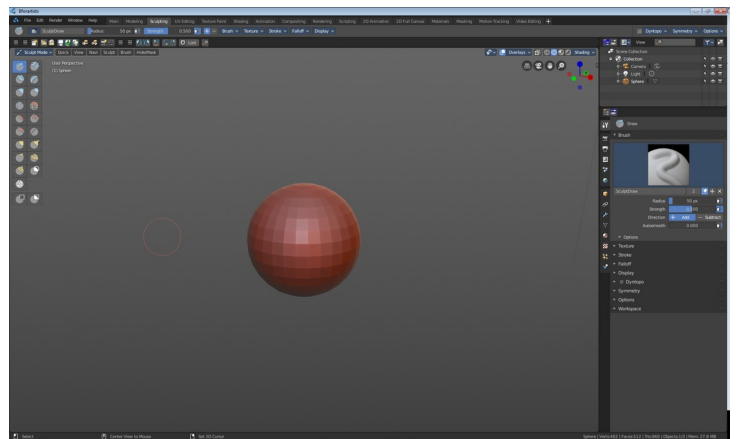

UV Editing

The UV Editing is made for texturing and UV mapping. It contains an Info Editor, a UV Editor and a 3D View editor.

The 3D View starts in Edit mode.

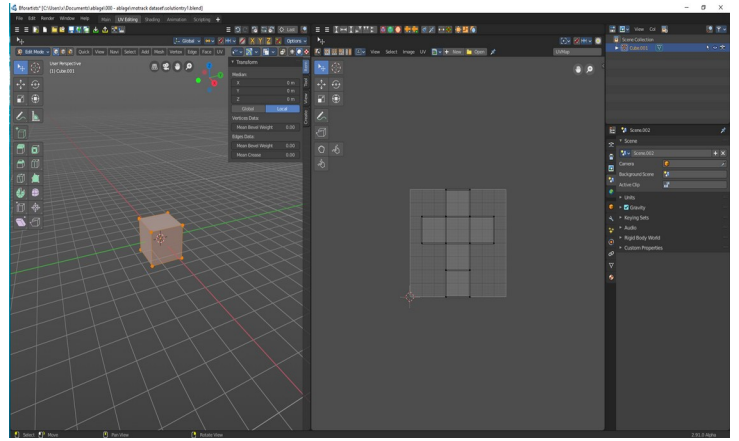

Texture Painting

The texture painting workspace is made to do texture painting work. It contains an Info Editor, a Image Editor and a 3D View editor.

The 3D View starts in Edit mode.

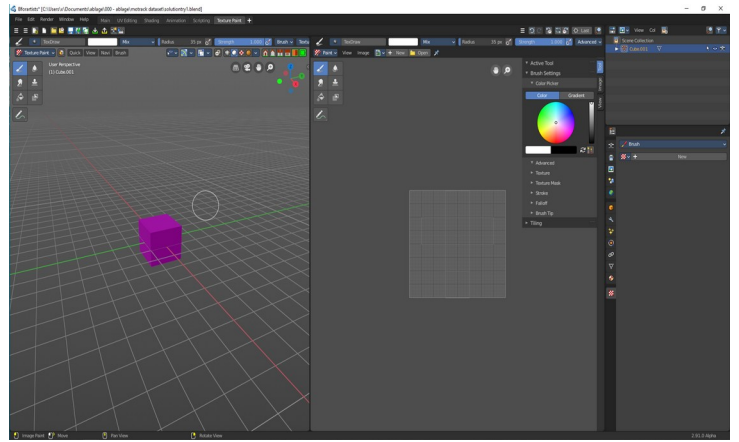

Shading

The workspace to do all the shader and material work.

It comes with a file browser, an image editor, the 3D view in a special view look setup, the shader editor, outliner and properties editor.

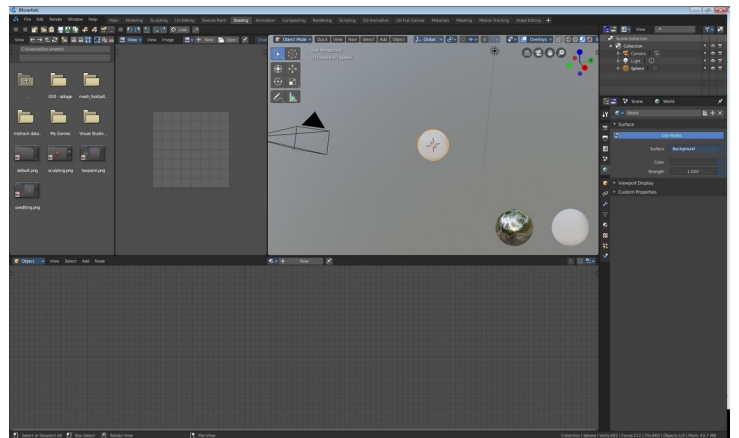

Nodes

The workspace to work with the geometry nodes.

Basic 3d view with the geometry nodes editor plus the spreadsheet editor to have access to the mesh data. A timeline at the bottom. And the usual outliner and properties editor.

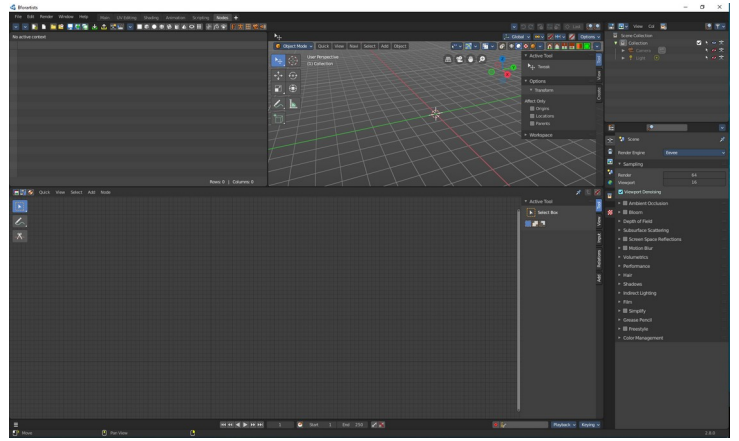

Animation

This workspace provides you with a layout that is optimized for Animation tasks. It contains two 3D View editors, an Info Editor, a Outliner Editor, a Properties Editor, a Timeline Editor, a Dope Sheet Editor.

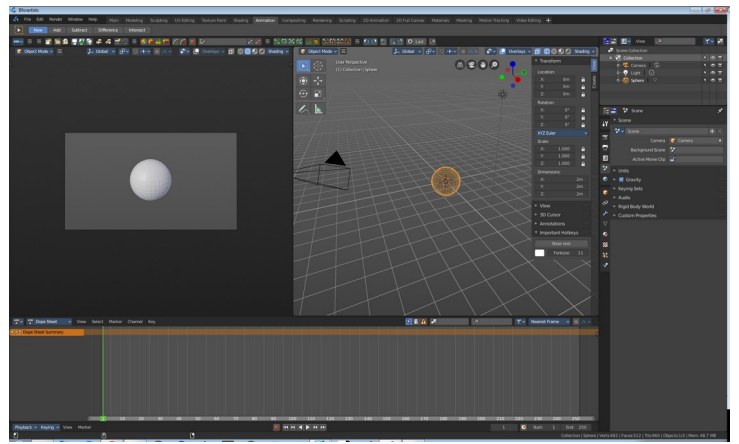

Compositing

The workspace to do compositing and post processing.

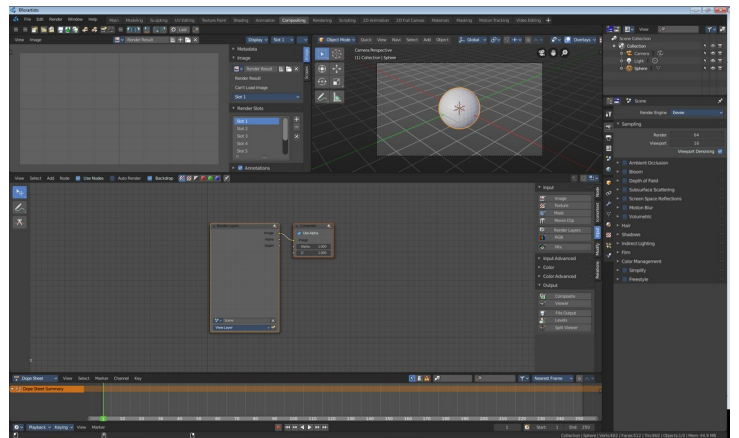

Rendering

A workspace for the rendering.

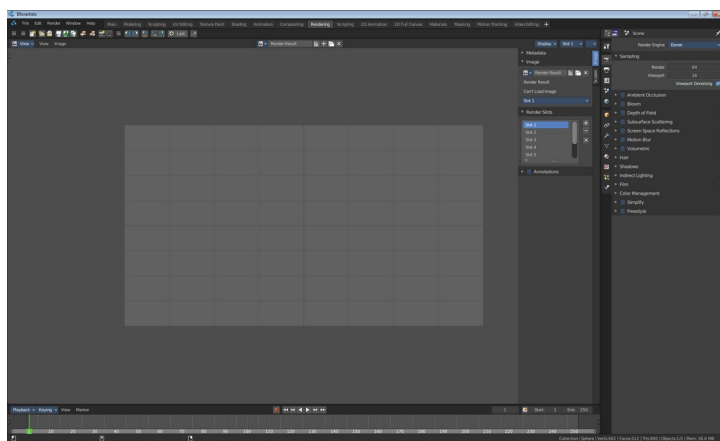

Scripting

The scripting workspace gives you a layout where you can write Python code. It contains an Info editor, a 3D View editor, a Console editor, a Text editor, a Outliner Editor and a Properties Editor.

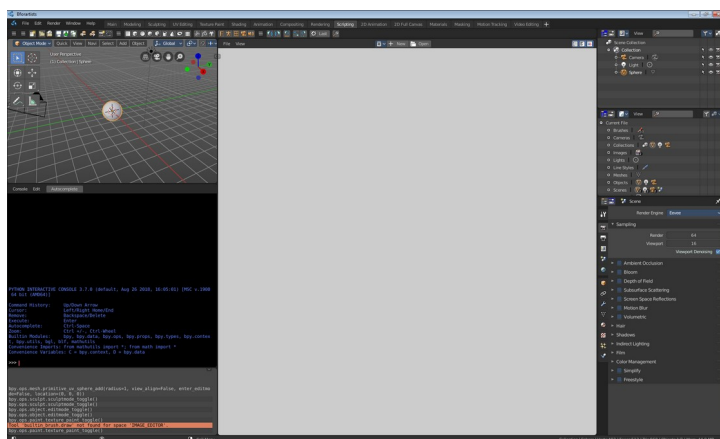

2D Animation

A workspace to work with the grease pencil and to create 2D animation.

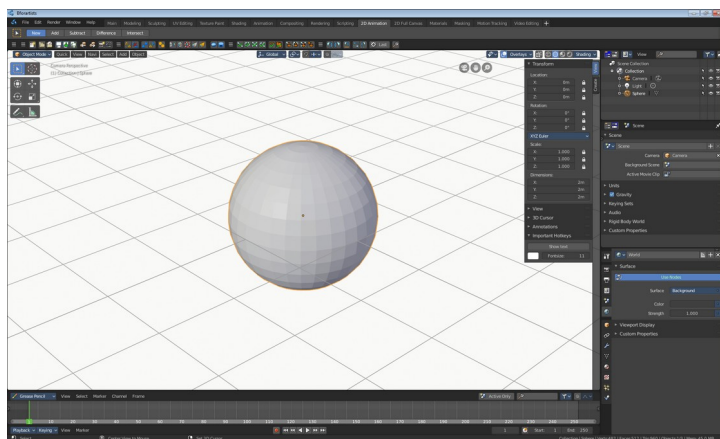

Full Canvas

A workspace to work with the grease pencil and to create 2D animation. The 3D view is maximized.

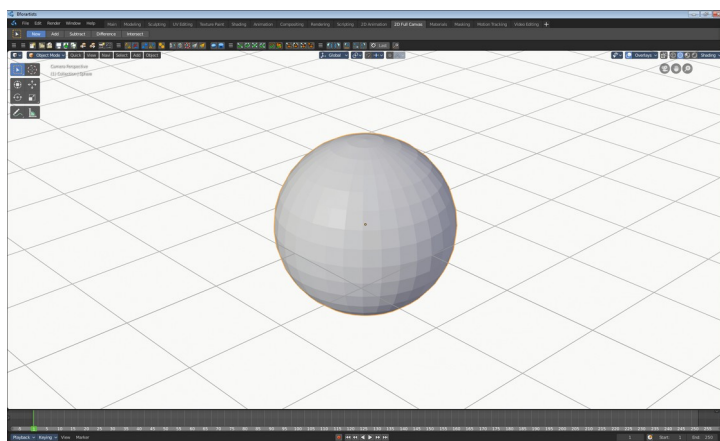

Material

The workspace to do all the shader and material work.

It comes with a file browser, an image editor, the 3D view in a special view look setup, the shader editor, outliner and properties editor.

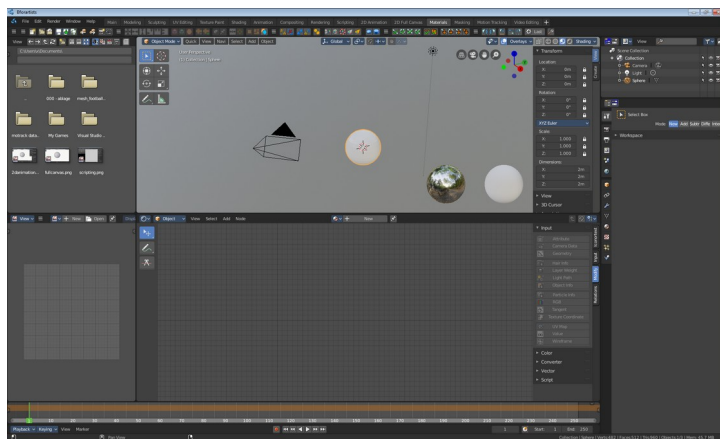

Masking

A workspace for the VFX workflow, to mask content.

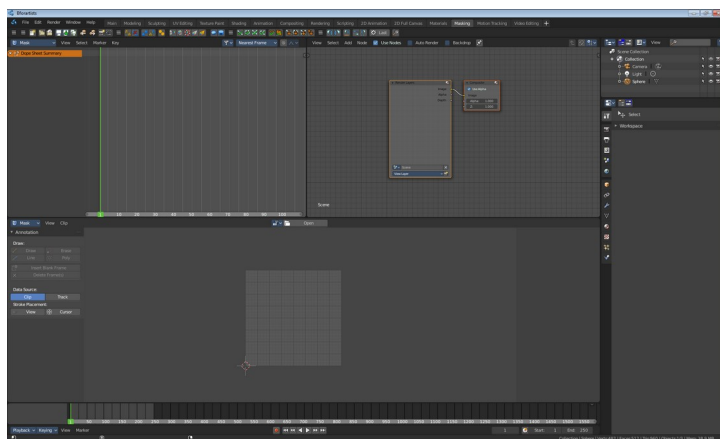

Motion Tracking

A workspace for the VFX workflow. The Motion tracking layout.

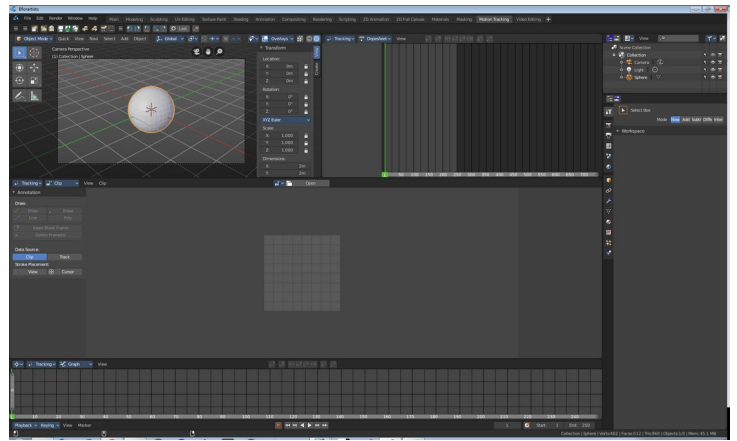

Video Editing

A workspace to edit videos.

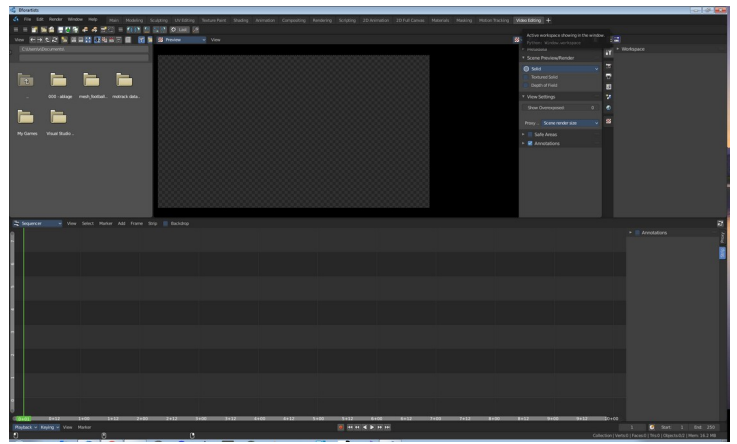

Assets

A workspace that provides you the asset browser.

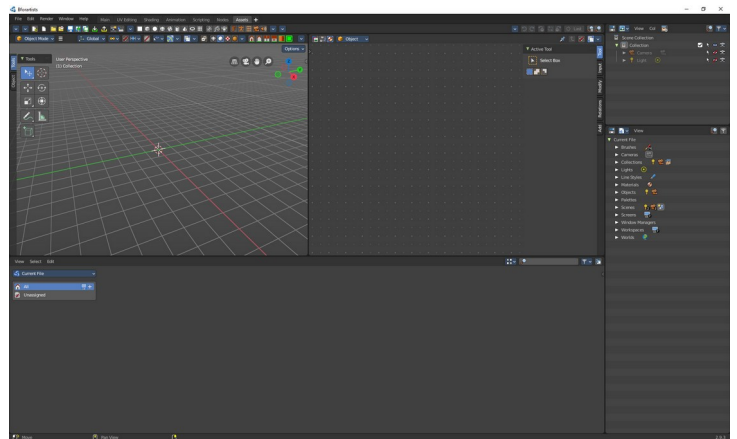



5 Topbar and Statusbar

Table of content

Introduction.....	2
Topbar.....	2
Header Right Click menu.....	2
Collapse Menus.....	2
Hide Editortype Menu.....	2
Navigation Tabs.....	2
Adding a new tab.....	3
Rename a tab.....	3
Tab Right Click Menu.....	3
Duplicate.....	3
Delete.....	3
Reorder to Front.....	3
Reorder to Back.....	3
Previous Workspace.....	3
Next Workspace.....	3
Edit Source.....	3
Header.....	4
Show Menus.....	4
Hide Editortype Menu.....	4
Statusbar.....	4
Status Bar Context Menu.....	4
Scene Statistics.....	4
Scene Duration.....	4
System Memory.....	4
Video Memory.....	5
Bforartists Version.....	5

Introduction

The interface of Bforartists is made of several UI elements and layouts. Topbar and status bar are the two UI elements that are visible in all layouts. They contain some general functionality.

Topbar

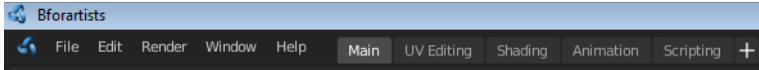

The Topbar is the area at the top that is visible in all workspaces. The top bar contains some general menus like File and Edit. And it contains tabs to switch between workspaces.

Header Right Click menu

The header has, like all headers, some right click menu functionality.

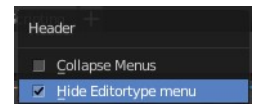

Collapse Menus

Make the menus in the header appear collapsed.

Hide Editortype Menu

This menu item has no purpose in the Topbar header. The Topbar header does not have a editortype menu.

Navigation Tabs

With the tabs you can switch between different workspaces of an application template.

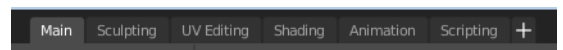

Application templates are a collection of Workspaces. A Workspace is a layout of screens and special setups. Like in what mode the workspace starts, how the windows are arranged and so on.

Every layout is made of several editors. The 3D View, a Properties Editor, the header and footer, the Toolbar at the top, and so on.

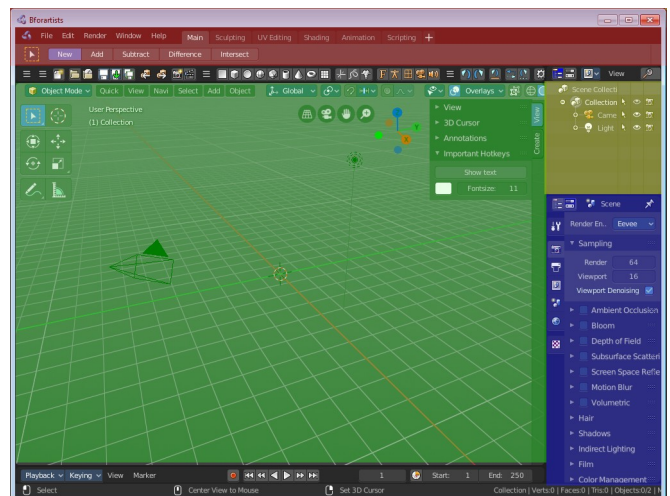

Adding a new tab

You can also add a new workspace to the existing ones. For this you can either add one of the existing workspaces from the Add Workspace menu that hides under the + button at the right. The greyed out menu items are already added to the Tabs.

The other way is by duplicating the current workspace, tweak it to your needs, and rename it then. This can also be done in the Add Workspace menu. Duplicate Current.

When done, save the startup file to make the change permanent. Be careful here, this overwrites the current startup.blend file with all its settings.

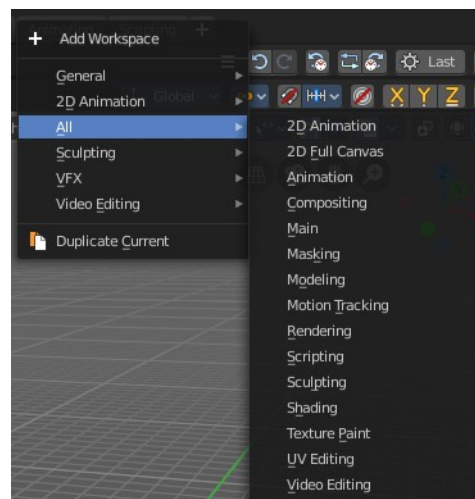

Rename a tab

To rename a tab double click at it. The name turns into an edit box. And you can edit the name of the tab.

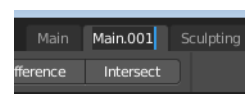

Tab Right Click Menu

When you right click at a tab then you will reveal a menu with further functionality.

Duplicate

Duplicates the workspace with all its settings.

Delete

Deletes the workspace with all its settings.

Reorder to Front

Orders the tab to be the first in the list.

Reorder to Back

Orders the tab to be the last in the list.

Previous Workspace

Cycle to the previous workspace.

Next Workspace

Cycle to the next workspace.

Edit Source

Open the Python script that contains this button in the text editor. Note that you need to have a text editor open.

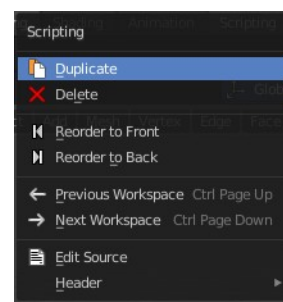

Header

Same menu than the right click menu in the header area.

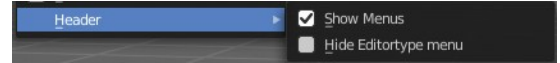

Show Menus

Make the menus in the header appear collapsed.

Hide Editortype Menu

This menu item has no purpose in the Topbar header. The Topbar header does not have a editortype menu.

Statusbar

The statusbar is, besides the Topbar, the second UI element that will display in all workspaces. At least when you don't hide it away. Which is not recommended. Since here you can find the scene information. In this area you will also see informations and warnings about the current operation. For example, you can see the progress bar for rendering in this area. Besides that, the footer also displays some infos about navigation.



The Navigation content changes, dependent of where you have the mouse over, and what tool or functionality you want to use.

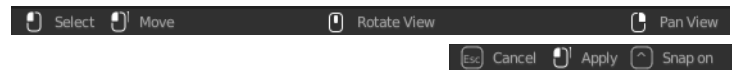

In the middle to the right you will see things like the render status bar, when you have a render job running. But in this area you can also see some warnings occur.



When you right click at the status bar then you will reveal a context menu where you can choose what information you want to display in the right area of the footer. By default the Bforartists version number is shown.

Status Bar Context Menu

Scene Statistics

This shows scene statistics like the active collection, object, faces, tris and total objects in the scene.

Scene Duration

This shows the scene frame information including total duration and current frame of total frames.

System Memory

This shows system memory usage

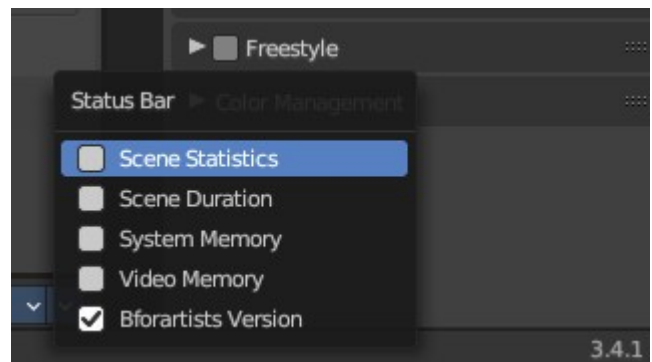

Video Memory

This shows GPU memory usage

Bforartists Version

This displays the version number of Bforartists



5.1.1 Topbar and Statusbar - File menu

Table of content

Detailed table of content.....	1
File Menu.....	10
New.....	11
New from Template.....	11
Open.....	12
Open Recent.....	12
Revert.....	12
Recover last Session.....	12
Recover Autosave.....	12
Save.....	12
Incremental Save.....	12
Save As.....	12
Save Copy.....	12
Link.....	12
Append.....	14
Data Previews.....	15
Import.....	16
Export.....	29
External Data.....	50
Clean Up.....	52
Quit.....	53

Detailed table of content

Detailed table of content

Detailed table of content.....	1
File Menu.....	10
New.....	11
New from Template.....	11
Standard Application Templates.....	11
General.....	11
2D Animation.....	11
All.....	11
Sculpting.....	11
VFX.....	11
Video Editing.....	12
Open.....	12
Open Recent.....	12
Revert.....	12
Recover last Session.....	12
Recover Autosave.....	12
Save.....	12
Incremental Save.....	12

Save As.....	12
Save Copy.....	12
Link.....	12
Advanced Filter.....	13
Import Settings.....	13
Relative Path.....	13
Select.....	13
Active Layer.....	13
Instance Collections.....	13
Please Note:.....	13
Known Limitations.....	13
Append.....	14
Advanced Filter.....	14
Import Settings.....	14
Select.....	14
Active Collection.....	14
Instance Collection.....	14
Fake User.....	14
Localize All.....	14
Data Previews.....	15
Refresh Data Set Previews.....	16
Batch Generate Previews.....	16
Clear Data Set Previews.....	16
Batch Clear Previews.....	16
Import.....	16
Collada.....	17
Import Data Options.....	17
Import Units.....	17
Custom Normals.....	17
Armature Options.....	17
Fix Leaf Bones.....	17
Find Bone Chains.....	17
Auto Connect.....	17
Minimum Chain Length.....	17
Keep Bind Info.....	17
Alembic.....	17
Manual Transform.....	17
Scale.....	17
Options.....	17
Relative Path.....	17
Set Frame Range.....	18
Is Sequence.....	18
Validate Meshes.....	18
Always add Cache Reader.....	18
USD.....	18
Data Types.....	18
Cameras.....	18
Curves.....	18
Lights.....	18
Materials.....	18
Meshes.....	18
Volumes.....	18

Shapes.....	18
Skeletons.....	18
Blend Shapes.....	19
Path Mask.....	19
Scale.....	19
Mesh Data.....	19
UV Coordinates.....	19
Vertex Colors.....	19
Mesh Attributes.....	19
Include.....	19
Subdivision.....	19
Import Instance Proxies.....	19
Visible Primitives Only.....	19
Guide.....	19
Proxy.....	19
Render.....	19
Options.....	19
Set Frame Range.....	19
Relative Path.....	20
Create Collection.....	20
Light Intensity Scale.....	20
Materials.....	20
Import all Materials.....	20
Import USD Preview.....	20
Set Material Blend.....	20
Material Name.....	20
Import Textures.....	20
None.....	20
Packed.....	20
Copy.....	20
Textures Directory.....	20
File name collision.....	20
SVG as Grease Pencil.....	21
Resolution.....	21
Scale.....	21
Wavefront(OBJ).....	21
Transform Panel.....	21
Scale.....	21
Clamp Bounding Box.....	21
Forward Axis.....	21
Up.....	21
Options.....	21
Split by Object.....	21
Split by Group.....	21
Vertex Groups.....	22
Validate Meshes.....	22
Motion Capture (BVH).....	22
Target.....	22
Transform panel.....	22
Scale.....	22
Rotation.....	22
Forward.....	22

Up.....	22
Animation Panel.....	22
Start Frame.....	22
Scale FPS.....	22
Loop.....	23
Update Scene FPS.....	23
Update Scene Duration.....	23
Scalable Vector Graphics (SVG).....	23
Stanford (PLY).....	23
Hide Operator Properties.....	23
STL.....	23
Transform Panel.....	23
Scale.....	23
Scene Unit.....	23
Forward.....	24
Up.....	24
Facet Normals.....	24
FBX.....	24
Operator Presets.....	24
Include Panel.....	25
Custom Normals.....	25
Subdivision Data.....	25
Custom Properties.....	25
Import Enums as Strings.....	25
Image Search.....	25
Transform Panel.....	25
Scale.....	25
Decal Offset.....	25
!Experimental! Apply Transform.....	25
Use Pre/ Post Rotation.....	25
Manual Orientation panel.....	25
Forward.....	25
Up.....	26
Animation Panel.....	26
Animation Offset.....	26
Armature Panel.....	26
Ignore Leaf Bones.....	26
Force Connect Children.....	26
Automatic Bone Orientation.....	26
Primary and secondary Bone Axis.....	26
glTF 2.0 (glb, gltf).....	26
Pack Images.....	26
Merge Vertices.....	26
Shading.....	27
Guess original bind pose.....	27
Bone Direction.....	27
Wavefront(OBJ) (legacy).....	27
Operator Presets.....	27
Include panel.....	27
Image Search.....	27
Smooth Groups.....	28
Lines.....	28

Transform Panel.....	28
Clamp Size.....	28
Up.....	28
Geometry Panel.....	28
Split / Keep Vert Order.....	28
Split by Object.....	28
Split by Group.....	28
Keep Vert Order Poly Groups.....	28
X3D Extensible 3D.....	29
Operator Presets.....	29
Transform Panel.....	29
Forward.....	29
Up.....	29
Export.....	29
Collada.....	29
Operator Presets.....	30
Main.....	30
Selection Only.....	30
Include Children.....	30
Include Armatures.....	30
Include Shape Keys.....	30
Global Orientation.....	30
Apply.....	30
Forward Axis.....	30
Up Axis.....	30
Texture Options.....	30
Copy.....	30
UV.....	31
Only Selected Map.....	31
Geom.....	31
Export Data Options.....	31
Triangulate.....	31
Apply Modifiers.....	31
Transform.....	31
Arm.....	31
Armature Options.....	31
Deform Bones only.....	31
Export to SL/OpenSim.....	31
Anim.....	31
Include Animations.....	31
Key Type.....	31
Samples/Curves.....	31
Keep Smooth Curve.....	32
Sampling Rate.....	32
Keep Key frames.....	32
All Keyed Curves.....	32
Include all Actions.....	32
Transform Type.....	32
Extra.....	32
Collada Options.....	32
Use Object Instances.....	32
Use Blender Profile.....	32

Sort by Object Name.....	32
Keep Bind Info.....	32
Limit Precision.....	32
Alembic.....	33
Manual Transform.....	33
Scale.....	33
Scene Options.....	33
Frame Start.....	33
End.....	33
Samples Transform.....	33
Geometry Samples.....	33
Shutter Open.....	33
Shutter Closed.....	33
Use Instancing.....	33
Custom Properties.....	33
Flatten Hierarchy.....	33
Only.....	33
Selected Objects.....	33
Visible Objects.....	34
Object Options.....	34
UV's.....	34
Pack UV Islands.....	34
Normals.....	34
Vertex Colors.....	34
Generate Coordinates.....	34
Face Sets.....	34
Curves as Mesh.....	34
Subdivisions.....	34
Apply.....	34
Use Schema.....	34
Triangulate.....	34
Quad Method.....	34
Polygon Method.....	35
Particle Systems.....	35
Export Hair.....	35
Export Particles.....	35
Universal Scene Description (USD).....	35
Export settings.....	35
Selection Only.....	35
Visible Only.....	35
Animation.....	35
Hair.....	35
UV Maps.....	35
Normals.....	35
Materials.....	35
Use Settings for.....	36
Materials.....	36
To USD Preview Surface.....	36
Export Textures.....	36
Overwrite Textures.....	36
File References.....	36
Relative Texture Paths.....	36

Experimental.....	36
Instancing.....	36
Grease Pencil as SVG.....	36
Scene Options.....	36
Object.....	36
Export Options.....	36
Sampling.....	36
Fill.....	36
Normalize.....	36
Clip Camera.....	37
Grease Pencil as PDF.....	37
Scene Options.....	37
Object.....	37
Export Options.....	37
Frame.....	37
Sampling.....	37
Fill.....	37
Normalize.....	37
Wavefront(OBJ).....	38
Limit to.....	38
Selected Only.....	38
Scale.....	38
Forward Axis.....	38
Up Axis.....	38
Object.....	38
Apply Modifiers.....	38
Properties.....	39
Geometry.....	39
Materials.....	39
Export.....	39
PBR Extensions.....	39
Path Mode.....	39
Grouping export.....	39
Animation.....	39
Export Animation.....	39
Frame Start / End.....	39
Motion Capture BVH.....	40
Transform Panel.....	40
Scale.....	40
Rotation.....	40
Root Translation Only.....	40
Animation Panel.....	40
Start Frame.....	40
End Frame.....	40
Stanford (PLY).....	40
Format.....	40
Include Panel.....	40
Forward.....	40
Up.....	40
Scale.....	41
Geometry Panel.....	41
Apply Modifiers.....	41

Normals.....	41
UV's.....	41
Vertex Colors.....	41
STL.....	41
ASCII.....	41
Batch Mode.....	41
Include Panel.....	41
Selected Only.....	41
Transform Panel.....	41
Scale.....	41
Scene Unit.....	42
Forward.....	42
Up.....	42
Geometry panel.....	42
Apply Modifiers.....	42
FBX.....	42
Operator Presets.....	42
Path Mode.....	43
Embed Textures.....	43
Batch Mode.....	43
Batch Own Dir.....	43
Include Panel.....	43
Limit to.....	43
Selected Objects.....	43
Active Collection.....	43
Object Types.....	43
Custom Properties.....	43
Transform Panel.....	43
Scale.....	43
Apply Scaling.....	43
Forward.....	43
Up.....	44
Apply Unit.....	44
Use Space Transform.....	44
!Experimental! Apply Transform.....	44
Geometry Panel.....	44
Smoothing.....	44
Export Subdivision Surface.....	44
Apply Modifiers.....	44
Loose Edges.....	44
Tangent Space.....	44
Armatures.....	44
Primary Bone Axis.....	44
Secondary Bone Axis.....	44
Armature FBX Node Type.....	45
Only Deform Bones.....	45
Add Leaf Bones.....	45
Bake Animation.....	45
Key all Bones.....	45
NLA Strips.....	45
All Actions.....	45
Force Start/ End Keying.....	45

Sampling Rate.....	45
Simplify.....	45
glTF 2.0 (glb, gltf).....	45
Operator Presets.....	45
Format.....	46
Copyright.....	46
Remember Export Settings.....	46
Include panel.....	46
Limit to.....	46
Selected Objects.....	46
Visible Objects.....	46
Renderable Objects.....	46
Active Collection.....	46
Active Scene.....	46
Data.....	46
Custom Properties.....	46
Cameras.....	46
Punctual Lights.....	47
Transform Panel.....	47
Y Up.....	47
Geometry Panel.....	47
Apply Modifiers.....	47
UV's.....	47
Normals.....	47
Tangents.....	47
Vertex Colors.....	47
Loose Edges.....	47
Loose Points.....	47
Materials.....	47
Images.....	47
Automatic.....	47
Jpeg Format (jpg).....	47
None.....	48
Compression sub subpanel.....	48
Animation.....	48
Use Current Frame.....	48
Animation sub subpanel.....	48
Limit to Playback Range.....	48
Sampling Rate.....	48
Always Sample Animations.....	48
Group by NLA Tracks.....	48
Export Deformation Bones only.....	48
Shape Keys sub subpanel.....	48
Shape Key Normals.....	48
Shape Key Tangents.....	48
Skinning.....	48
Include all Bone Influences.....	49
X3D Extensible 3D.....	49
Operator Presets.....	49
Include Panel.....	49
Selection Only.....	49
Hierarchy.....	49

Name Decorations.....	49
H3D Extensions.....	49
Transform Panel.....	49
Scale.....	49
Forward.....	49
Up.....	50
Geometry Panel.....	50
Apply Modifiers.....	50
Triangulate.....	50
Normals.....	50
Compress.....	50
External Data.....	50
Automatically Pack into .blend.....	50
Pack Resources.....	50
Pack linked libraries.....	51
Unpack linked libraries.....	51
Unpack Resources.....	51
Use Files in current Directory (create when necessary).....	51
Write files to current directory (overwrite existing files).....	51
Use files in original location (create when necessary).....	51
Write files to original location(overwrite existing files).....	51
Make Paths Relative.....	52
Make Paths Absolute.....	52
Report Missing Files.....	52
Find Missing Files.....	52
Clean Up.....	52
Unused Data.....	52
Recursive Unused Data.....	52
Unused Linked Data.....	52
Recursive Unused Linked Data.....	52
Unused Local Data.....	52
Recursive Unused Local Data.....	53
Quit.....	53

File Menu

The File menu contains file related functionality.

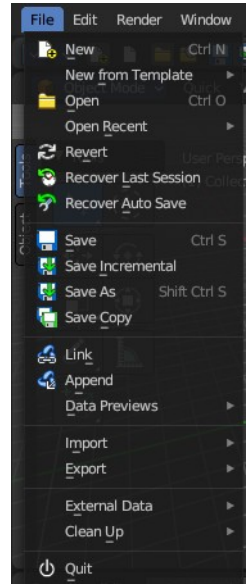

New

Creates a new scene, using the current active template.

New from Template

Choose to create a new file with predefined Application Templates.

Application templates is a collection of workspaces for a predefined purpose.

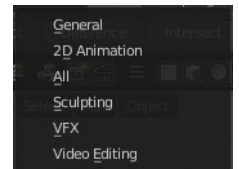

Standard Application Templates

General

The general application template comes with the workspaces to create 3D content.

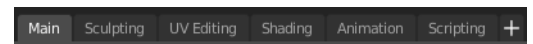

2D Animation

The 2D Animation application template comes with the workspaces to create 2D animation.

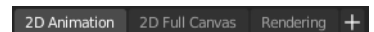

All

The All application template contains all default workspaces.



Sculpting

The Sculpting application template comes with the workspaces for sculpting needs.



VFX

The VFX application template comes with the workspaces for motion tracking.

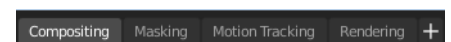

Video Editing

The Video Editing application template comes with the workspaces for video editing.

Video Editing Rendering +

Open

Open a blend file.

Open Recent

Open last recent blend files.

Revert

Reload the last saved file.

Recover last Session

Open the last closed blend file. (quit.blend)

Recover Autosave

Open the last autosaved blend file.

Save

Save blend file.

Incremental Save

Saves an already saved blend file with incremental file name. myfile.blend gets saved as myfile1.blend, myfile2.blend, myfile3.blend, and so on.

You need to have the blend file saved once to set this save method active.

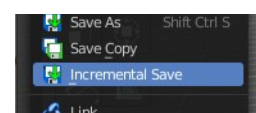
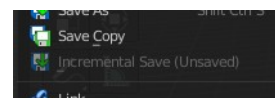

Save As

Save blend file as.

Save Copy

Saves a copy of the current file.

Link

Link allows you to link content from another blend file. The content remains in the other blend file. The linked blend file will be required to work with the linked content.

When you click at Link then a file browser will open. Down left you will see some further options.

Advanced Filter

This filter allows you to filter the content of the blend file for specific object types.

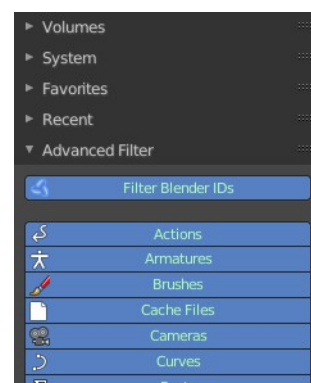

Import Settings

At the right you can reveal the import settings.

Relative Path

Available only when linking, see *relative paths*.

Select

Makes the object *Active* after it is loaded.

Active Layer

Enabled by default, the object is assigned to the visible layers in your scene. Otherwise, it is assigned to the same layers it resides on in the source file.

Instance Collections

This option links the collection to an object, adding it to the active scene.

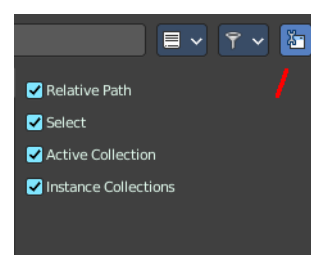

Please Note:

When you select an Object type, it will be placed in your scene at the cursor. Many other data types - cameras, curves, and materials for example - must be linked to an object before they become visible.

You cannot move a linked object. Its position is defined in its source file. If you want to modify the object locally you can either use Dupli Groups or make the object local, in the 3D View, Object / Relations menu.

Appending data you already have linked, will add objects / groups to the scene, but will keep them linked (and un-editable).

Known Limitations

In general dependencies shouldn't go in both directions. Attempting to link or append data which links back to the current file will likely result in missing links.

When linking objects **directly** into a `.blend` file, the *Rigid Body* settings won't be linked in since they're associated with their scenes world. As an alternative you could link in the entire scene and set it as a Background Set Scene.

Append

Append allows you to append content from another blend file. The content will be copied over, and become part of the current blend file.

When you click at Link then a file browser will open. Down left you will see some further options.

The difference to Link is that with Append the object becomes part of the current blend file. And it is editable.

Advanced Filter

This filter allows you to filter the content of the blend file for specific object types.

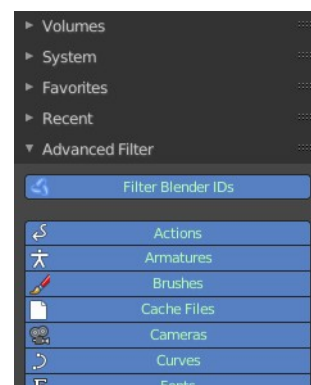

Import Settings

At the right you can reveal the import settings.

Select

Makes the object *Active* after it is loaded.

Active Collection

Put the new objects into the active collection.

Instance Collection

Create instances for collections rather than adding them directly to the scene.

Fake User

Set Fake User for appended objects, except Objects and Groups

Localize All

Localize all appended data, including indirectly linked from other libraries.

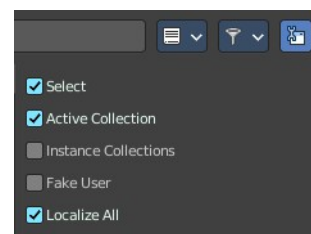

Data Previews

Data Previews is a sub menu with functionality around the Data Preview in the Bforartists file browser. The functionality in this menu creates and handles previews of the objects in a blend file.

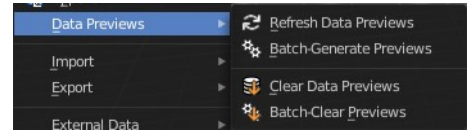

Data Previews are displayed in the file browser when you link or append something from this file and when you use thumbnails as display method. It is meant for the case when you want to turn a blend file into an asset library. Materials, ready textured objects, etc. .

This feature is currently broken. You can't create data previews yet in Bforartists 2. Example images taken from Bforartists 1.

Workflow:

First create a scene with your assets. Make sure to remove the camera from the scene. It can work, but it can also make trouble, and prevent the batch generation to work at the blend file. And an asset library doesn't need a camera anyways. Not so important is lights, it does not make trouble like the camera. But you won't get a data preview icon for lights.

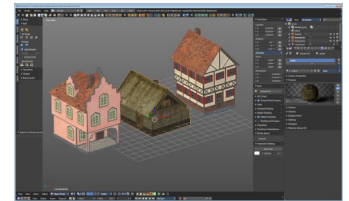

Save the scene. Restart Bforartists or create at least a new scene. We want to have a look what we currently get as preview when we want to link or append from this blend file. Make sure to turn the view in the file browser to thumbnails. It's always just the default icon for the assets. Left Materials, right the Objects.

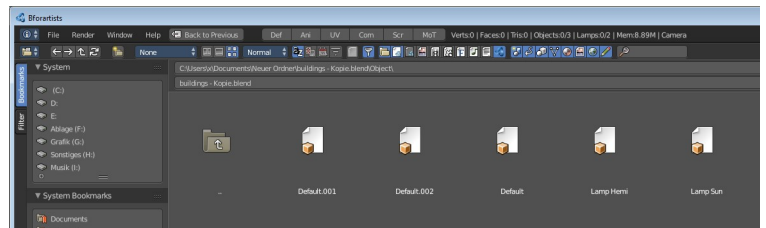
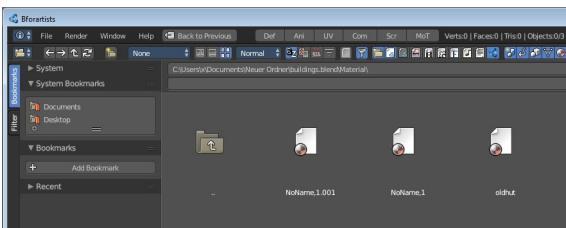
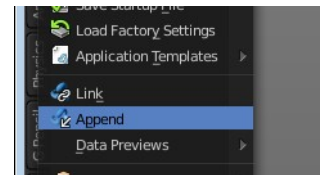

Now let's run Batch Generate Previews at this blend file.

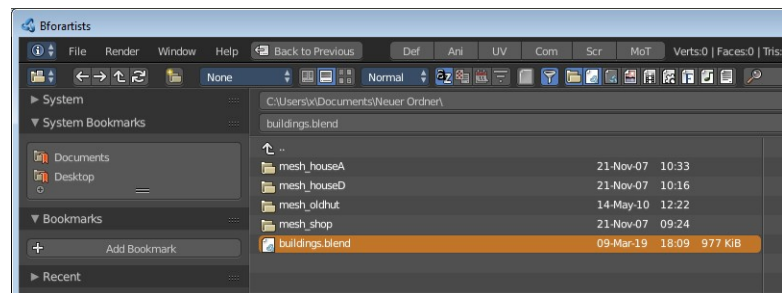
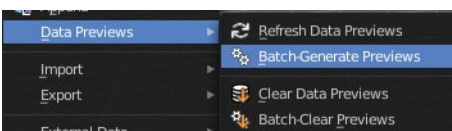

This process takes a while. Now let's try to append from the same file again. You will get proper preview

thumbnails now. Left Materials, right the objects. Here you will see again that lamps have no preview icon.

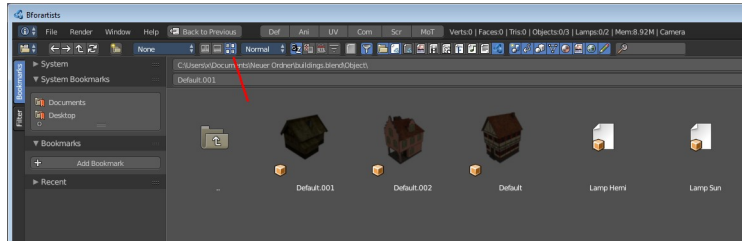
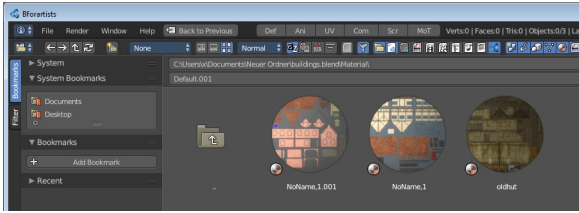

Refresh Data Set Previews

Refreshes the existing data set previews.

Batch Generate Previews

Generates the previews for the data objects in the selected blend file(s). The scene that you want to work at should not be loaded.

Clear Data Set Previews

Removes existing previews for some types in the target blend file.

Batch Clear Previews

Removes all existing previews in the target blend file.

Import

Import is a sub menu with the available 3D import file formats. You will be prompted to the load dialog which provides some further import options down left in the file browser tool shelf.

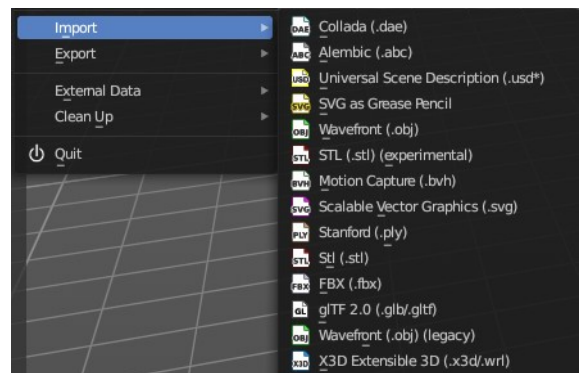

Collada

Imports a file in collada file format. Collada is a general file format that is able to store and load animation.

Import Data Options

Import Units

Imports the units that is used to save the collada file . If unticked Blender Units will be used.

Custom Normals

Import custom normals if available.

Armature Options

Fix Leaf Bones

Fix orientation of Leaf bones. Collada file formats only supports joints, not bones.

Find Bone Chains

Find best matching bone chains and ensure that the bones in the chain are connected.

Auto Connect

Auto connect parent bones that have exactly one child bone.

Minimum Chain Length

When searching bone chains disregard chains of length below this value.

Keep Bind Info

Store Bindpose Information in custom bone properties for later use in later collada export.

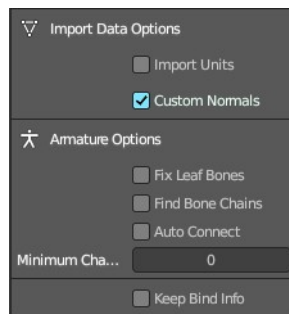

Alembic

The alembic file format is for static geometry. It does not support armatures, hair or particles.

Manual Transform

Scale

Set the import scale factor.

Options

Relative Path

Select the file relative to the blend file.

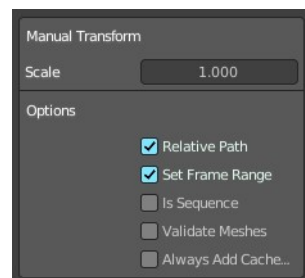

Set Frame Range

Sets the Frame range start and end point in Bforartists to match the one in the alembic file.

Is Sequence

Import sequenced files that are split in cache parts.

Validate Meshes

Check for invalid mesh data in the file. Note that this operation may take some time.

Always add Cache Reader

Add cache modifiers and constraints to imported objects even when they are not animated. This allows updating the alembic archive when reloading.

USD

Imports a Universal Scene Description (USD) file. It reads *.usd, *.usdc and *.usda files.

Data Types

Cameras

Import cameras (perspective and orthographic).

Curves

Import curve primitives, including USD basis and NURBS curves. (Note that support for Bézier basis is not yet fully implemented.)

Lights

Import lights. Does not currently include USD dome, cylinder or geometry lights.

Materials

Import materials. See also the experimental Import USD Preview option.

Meshes

Import meshes.

Volumes

Import USD OpenVDB field assets.

Shapes

Import USD Shapes.

Skeletons

Import USD Skeletons.

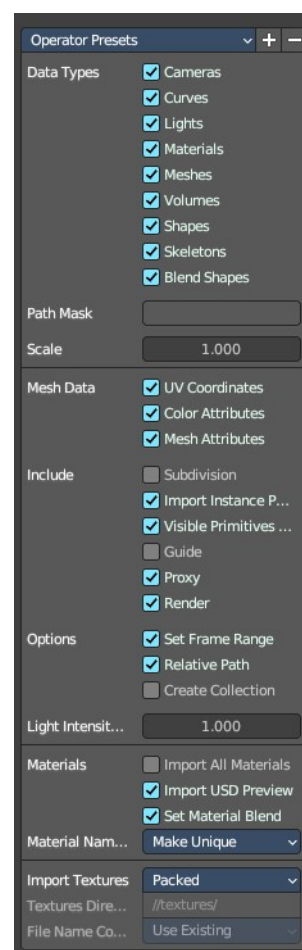

Blend Shapes

Import USD Blend Shapes.

Path Mask

Import only the subset of the USD scene rooted at the given primitive.

Scale

The scale size at import.

Mesh Data

UV Coordinates

Load mesh UV coordinates.

Vertex Colors

Import the USD mesh display Color values as Blender mesh vertex colors.

Mesh Attributes

Read USD PrimVars as mesh attributes.

Include

Subdivision

Create subdivision surface modifiers from the subdivision in the file.

Import Instance Proxies

Create unique Blender objects for USD instances.

Visible Primitives Only

Do not import invisible USD primitives. Only applies to primitives with a non-animated visibility attribute. Primitives with animated visibility will always be imported.

Guide

Include primitives with purpose guide.

Proxy

Include primitives with purpose proxy.

Render

Include primitives with purpose render.

Options

Set Frame Range

Update the scene's start and end frame to match those of the USD stage.

Relative Path

Select the file relative to the blend file.

Create Collection

Add all imported objects to a new collection.

Light Intensity Scale

Scale for the intensity of imported lights.

Materials

Import all Materials

Import all materials. Also materials that are not used by the geometry.

Import USD Preview

Convert USD Preview Surface shaders to Principled BSDF shader networks.

Set Material Blend

If the Import USD Preview option is enabled, the material blend method will automatically be set based on the opacity and opacityThreshold shader inputs, allowing for visualization of transparent objects.

Material Name

How to import the material name when it conflicts with an existing material in the scene.

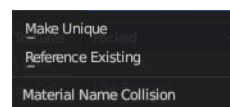

Import Textures

How to import textures.

None

Don't import textures.

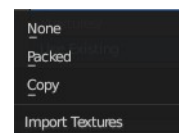

Packed

Import Texture as packed data.

Copy

Copy files to texture directory.

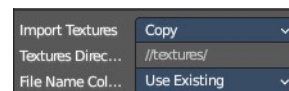

Textures Directory

The textures directory.

File name collision

What to do if a texture name already exists.

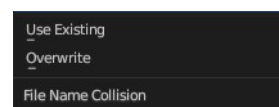

SVG as Grease Pencil

Imports a svg file as a grease pencil object.

Resolution

The resolution of the svg import.



Scale

The scale of the svg import.

Wavefront(OBJ)

Transform Panel

Scale

Scale factor for the obj import.

Clamp Bounding Box

Clamp bounds under this value. A value of zero disables this feature.

Forward Axis

The Forward orientation at import.

Up

The Up orientation at import.

Options

Split by Object

Import loose mesh parts as single objects.

Split by Group

Import Obj Groups as meshes.

Vertex Groups

Import Obj groups as vertex groups.

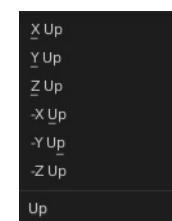
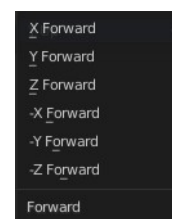
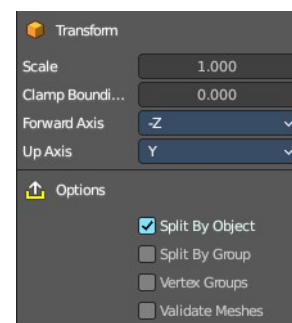

Validate Meshes

Check at import for invalid data.

Motion Capture (BVH)

The Biovision Hierarchy (BVH) character animation file format is a file format to carry motion capture data.

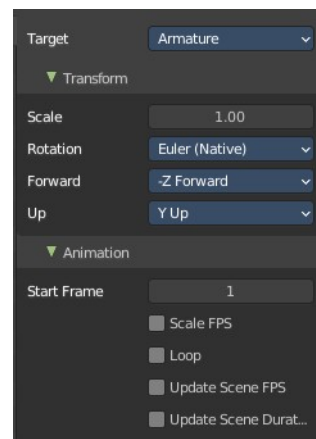

Target

You can either target an armature or an object.

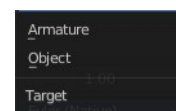

Transform panel

Scale

The import scale.

Rotation

The rotation type.

Forward

The forward orientation.

Up

The Up orientation.

Animation Panel

Start Frame

The start frame for the animation.

Scale FPS

Scale the frame rate of the BVH file to the current scenes. With off every frame of the BVH is one frame in Bforartists.

Loop

Loop the animation playback.

Update Scene FPS

Sets the scene frame rate to that of the BVH file. Note that this nullifies the Scale FPS feature since the scale will be 1:1.

Update Scene Duration

Extend the scene duration to be the one of the BVH file duration.

Scalable Vector Graphics (SVG)

Scalable Vector Graphics is usually a 2D file format to describe vector graphics. But Vector graphics are also curves. Which can be used in a 3 dimensional space.

SVG has no import properties.

Stanford (PLY)

The Stanford Triangle Format was designed to store three-dimensional data from 3D scanners. It is a static file format for mesh data, and cannot carry animation data.



Hide Operator Properties

Stanford PLY has no operator settings. This checkbox makes sure that the sidebar is collapsed. It has nothing to do with an import setting.

STL

STL (Standard Triangulation/Tessellation Language) is a standard format for many cad software. It is a format for static geometry, it cannot handle animation. The format is popular for 3d printing purposes.

Transform Panel

Scale

The import scale.

Scene Unit

Apply the scene unit at the geometry at import.

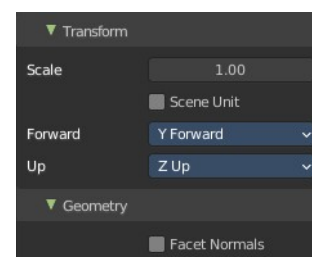

Forward

The Forward orientation at import.

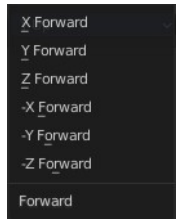

Up

The Up orientation at import.

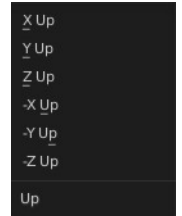

Facet Normals

Import the geometry with faceted faces.

FBX

FBX is a proprietary file format from Autodesk. FBX is a general file format that is able to store and load animation.

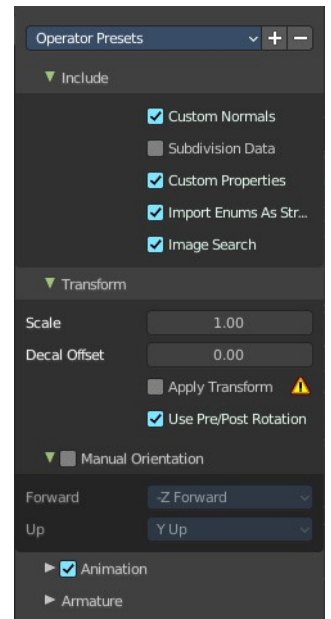

Operator Presets

Store and load presets. To add a preset, adjust the import dialog, click at the + button behind the drop down box, add the name of the preset, and click OK. The preset will be stored automatically. To use the preset simply choose it in the drop down box. Don't get irritated by that the drop down box still shows "Operator Presets" when you choose your preset. The values of the chosen preset are set.

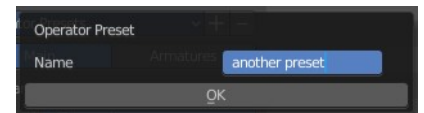

To remove a preset choose it in the drop down box, and click at the - button behind the drop down box. Also here, don't get irritated by that the drop down box still

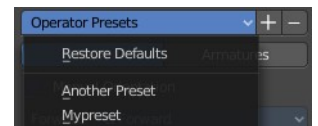

shows "Operator Presets" . The chosen preset will be deleted.

Include Panel

What data to import.

Custom Normals

Import custom normals.

Subdivision Data

Import Subdivision.

Custom Properties

Import User properties as Custom properties

Import Enums as Strings

Store enumeration values as strings.

Image Search

Search the sub directions for associated images.

Transform Panel

Scale

Adjust the scale factor at import.

Decal Offset

Displace geometry of alpha meshes.

!Experimental! Apply Transform

Bake space transform into object data. This avoids unwanted rotations when the target space is not aligned with the Bforartists space. Warning! This feature is experimental. Use at own risk.

Use Pre/ Post Rotation

Use Pre or Post Rotation from FBX transform. This feature may not work in all cases.

Manual Orientation panel

Enables custom orientation instead of using the orientation from the fbx file.

Forward

The Forward orientation at import.

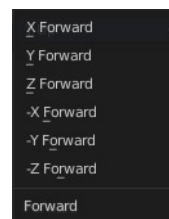

Up

The Up orientation at import.

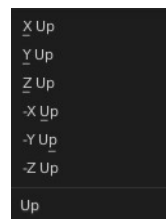

Animation Panel

Animation Offset

Adjust an offset in frames for the imported animation.

Armature Panel

Ignore Leaf Bones

Ignore the last bone at the end of the chain.

Force Connect Children

Force connection of the children bones to their parent.

Automatic Bone Orientation

Try to align the mayor bone axis with the bone children.

Primary and secondary Bone Axis

Manually adjust the bone orientation per axis. Note that this features are greyed out when Automatic Bone Orientation is ticked.

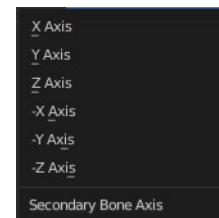
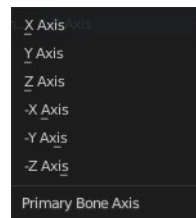

glTF 2.0 (glb, gltf)

The GL Transmission Format from the Khronos Group is a file format for 3D scenes and models, and is based at the JSON standard.

Pack Images

Pack all images into the Blend file at loading the glTF file.

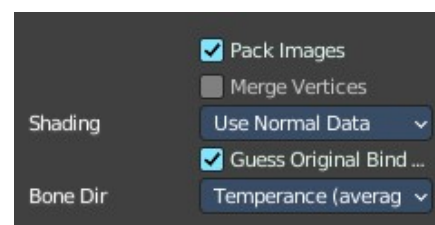

Merge Vertices

glTF stores every vertice of faces as an extra vertice. There is no shared vertice between two faces. Merge vertices merges the vertices of neighbor faces together.

Attention! It currently cannot combine vertices with different normals.

Shading

Define the shading of the imported geometry.

Use Normal Data uses the existing Normals.

Flat shading shades the whole mesh flat and faceted.

Smooth shading shades the whole mesh smooth.

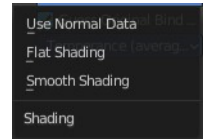

Guess original bind pose

Tries to guess the original bind pose for skinned meshes. Off means the rest pose is used as the bind pose.

Bone Direction

Heuristic method for placing bones.

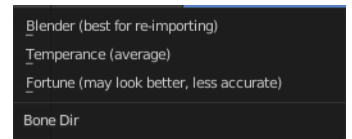

Wavefront(OBJ) (legacy)

This is the legacy Obj importer.

Wavefront Obj is a file format for static geometry. And while you can still create a sequence of meshes for animation with it (some software stores shape keys that way for example), you cannot store animation in the file. It is also unique since it is usually made of two files. A OBJ part that contains the mesh data. And a MTL part that contains the material including the connected textures.

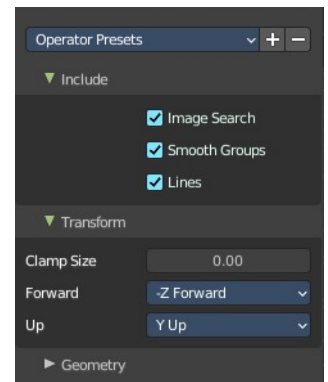

Operator Presets

Store and load presets. To add a preset, adjust the import dialog, click at the + button behind the drop down box, add the name of the preset, and click OK. The preset will be stored automatically. To use the preset simply choose it in the drop down box. Don't get irritated by that the drop down box still shows "Operator Presets" when you choose your preset. The values of the chosen preset are set.

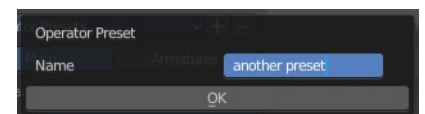

To remove a preset choose it in the drop down box, and click at the - button behind the drop down box. Also here, don't get irritated by that the drop down box still shows "Operator Presets" . The chosen preset will be deleted.

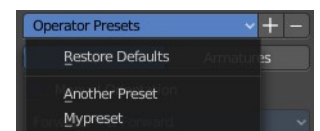

Include panel

Image Search

Search sub directions for associated images.

Smooth Groups

Surround smooth groups by sharp edges.

Lines

Import Lines and Faces with 2 verts as edge.

Transform Panel

Clamp Size

Clamp bounds under this value. A value of zero disables this feature. Forward

The Forward orientation at import.

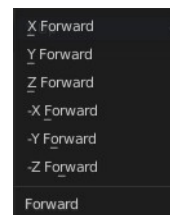

Up

The Up orientation at import.

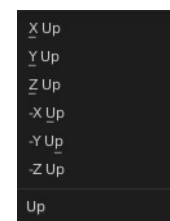

Geometry Panel

Split / Keep Vert Order

Split splits the mesh up. Keep Vertex Order imports everything as one mesh. Both methods have some further options.

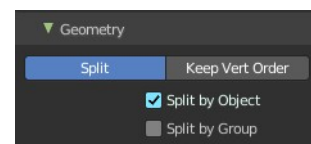

Split by Object

Import loose mesh parts as single objects.

Split by Group

Import Obj Groups as meshes.

Keep Vert Order Poly Groups

Import Obj groups as vertex groups.

X3D Extensible 3D

Extensible 3D (X3D) is a family of co-ordinated royalty-free open standards for file formats that can store representations of interactive 3D objects and scenes.

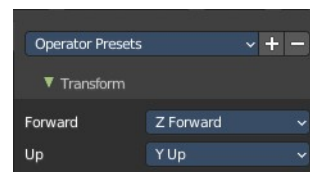

Operator Presets

Store and load presets. To add a preset, adjust the import dialog, click at the + button behind the drop down box, add the name of the preset, and click OK. The preset will be stored automatically. To use the preset simply choose it in the drop down box. Don't get irritated by that the drop down box still shows "Operator Presets" when you choose your preset. The values of the chosen preset are set.

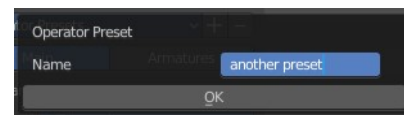

To remove a preset choose it in the drop down box, and click at the - button behind the drop down box. Also here, don't get irritated by that the drop down box still shows "Operator Presets". The chosen preset will be deleted.

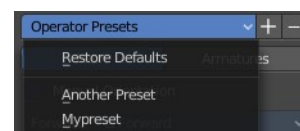

Transform Panel

The scale factor.

Forward

The forward orientation.

Up

The up orientation.

Export

Export is a sub menu with the available export formats.

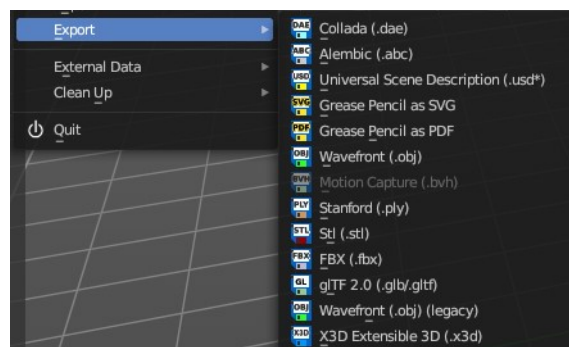

Collada

Exports a file in collada file format. Collada is a general file format that is able to store and load animation.

Operator Presets

Store and load presets. To add a preset, adjust the import dialog, click at the + button behind the drop down box, add the name of the preset, and click OK. The preset will be stored automatically. To use the preset simply choose it in the drop down box. Don't get irritated by that the drop down box still shows "Operator Presets" when you choose your preset. The values of the chosen preset are set.

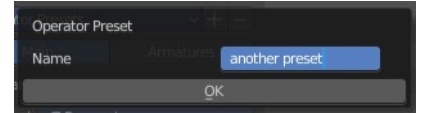

To remove a preset choose it in the drop down box, and click at the - button behind the drop down box. Also here, don't get irritated by that the drop down box still shows "Operator Presets" . The chosen preset will be deleted.



The Collada exporter is divided into several sub tabs since it would be too much to display all settings at once.

Main

Selection Only

Only export selected elements, not the whole scene.

Include Children

Export all children of selected objects, even if not selected.

Include Armatures

Export related armatures, even if not selected.

Include Shape Keys

Export all shape keys from Mesh Objects.

Global Orientation

Apply

Rotate all root objects to match the global orientation. With this option off the global settings are used by a collada object basis.

Forward Axis

The forward axis orientation.

Up Axis

The up axis orientation.

Texture Options

Copy

Copy the textures to the same folder where the .dae file is exported.

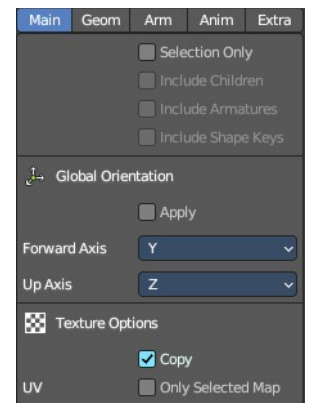

UV

Only Selected Map

Export only the selected UV map.

Geom

The geometry export section.

Export Data Options

Triangulate

Triangulates the mesh at export.

Apply Modifiers

Applies the modifiers for export. The resolution can be adjusted in the drop down box behind the Apply Modifiers checkbox. You can choose between View and Render.

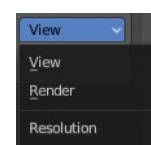
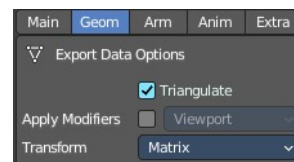

Transform

The transform type. Either transform the whole matrix. Or decomposed into the single components.

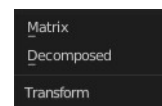

Arm

The armature export section.

Armature Options

Deform Bones only

Only export deforming bones with armatures.

Export to SL/OpenSim

Compatibility mode for SL, OpenSim and other compatible online worlds.

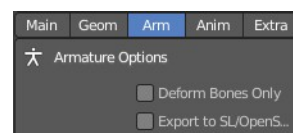

Anim

The Animation export section.

Include Animations

Export Animation if available.

Key Type

Samples/Curves

Export sample keys or curves keys.

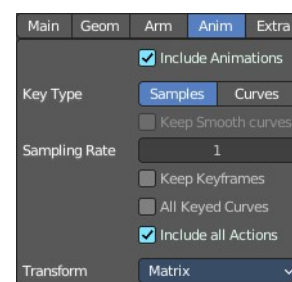

Keep Smooth Curve

Just available with TransRotLoc transformation type. Export also the curve handles if available.

Sampling Rate

The distance between two key frames.

Keep Key frames

Use existing key frames. as sample points.

All Keyed Curves

Export also curves that has just one key or are completely flat.

Include all Actions

Export also unassigned actions.

Transform Type

The transform type for translation, scale and rotation. Matrix or TransRotLoc.

Extra

Some extra export settings.

Collada Options

Use Object Instances

Instantiate multiple objects from same data.

Use Blender Profile

Export Blender specific settings for shader, bones, materials, etc.

Sort by Object Name

Sort exported data by name.

Keep Bind Info

Store Bind Pose Information in custom bone properties for later use during Collada export.

Limit Precision

Reduce the precision of the exported data to 6 digits.

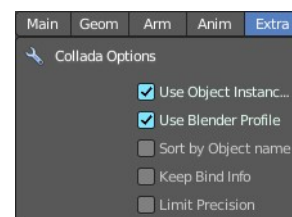

Alembic

The alembic file format is for static geometry. It does not support armatures, hair or particles. However, there are some options to export at least some data of it.

The alembic export options are divided into four sections.

Manual Transform

Scale

The export scale factor.

Scene Options

Frame Start

The start frame of the export.

End

The end frame of the export.

Samples Transform

Number of times per frame at which animated transformations are sampled.

Geometry Samples

Number of times per frame at which geometry transformations are sampled.

Shutter Open

The start frame to sample transform and geometry samples. Valid range is -1 to 1. -1 indicates the previous frame, 0 indicates the current frame, and 1 indicates the next frame.

Shutter Closed

The end frame to sample transform and geometry samples. Valid range is -1 to 1. -1 indicates the previous frame, 0 indicates the current frame, and 1 indicates the next frame.

Use Instancing

Export data duplicated objects as alembic instances.

Custom Properties

Export custom properties to Alembic . userProperties

Flatten Hierarchy

Remove parent / children relationship.

Only

Selected Objects

Export selected objects only.

Visible Objects

Export visible objects only.

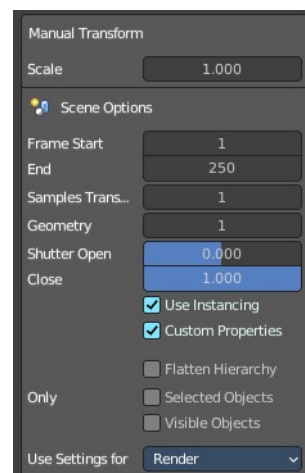
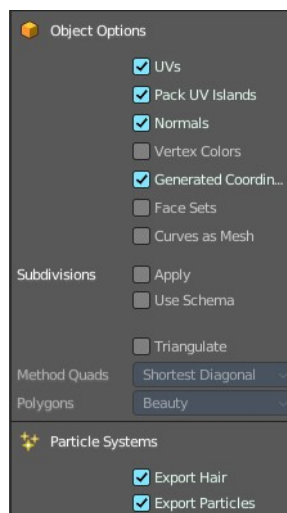

Object Options

UV's

Export UV's. Note that Alembic just supports a single UV map.

Pack UV Islands

Export UV's with packed islands.

Normals

Export Normals.

Vertex Colors

Export Vertex Colors.

Generate Coordinates

Export undeformed mesh vertex coordinates.

Face Sets

Export per Face shading group assignments.

Curves as Mesh

Export Curves and Nurbs surfaces as meshes.

Subdivisions

Apply

Export subdivision surfaces as meshes. Means apply subdivision modifier before export.

Use Schema

Export meshes using Alembic's subdivision schema.

Triangulate

Triangulate meshes before export.

Quad Method

The quad method that gets used to triangulate the meshes. You need to activate Triangulate.

Polygon Method

The polygon method that gets used to triangulate the meshes. You need to activate Triangulate.

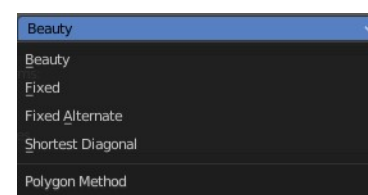
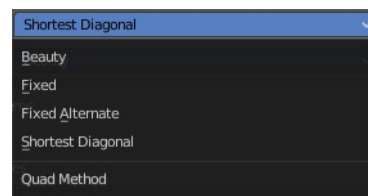
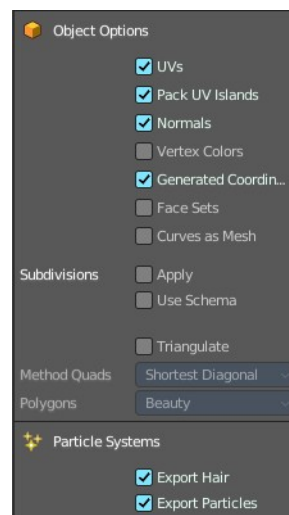

Particle Systems

Alembic does not support hair or particles. However, here you can find some options to export at least some data of it.

Export Hair

Export hair particle systems as animated curves.

Export Particles

Export non-hair particles.

Universal Scene Description (USD)

USD is a system for authoring, composing and reading hierarchically organized scene description. It is developed by Pixar.

Export settings

Selection Only

Export just the selected object(s), and not the whole scene.

Visible Only

Export visible geometry only.

Animation

Export animation.

Hair

Export hair.

UV Maps

Export UV Maps.

Normals

Export Normals.

Materials

Export Materials.

Use Settings for

Use the render settings or the viewport settings for the export.

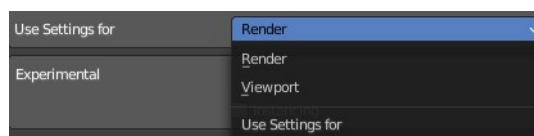
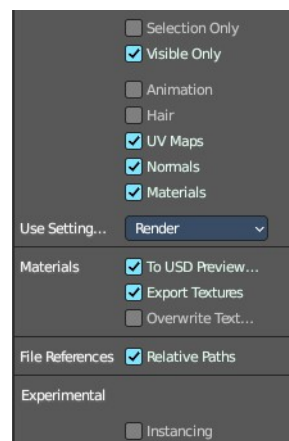

Materials

To USD Preview Surface

Generate a USD preview shader.

Export Textures

Export referenced textures to a "textures" directory.

Overwrite Textures

Overwrite existing textures.

File References

Relative Texture Paths

Make the texture paths relative to the usd file.

Experimental

Instancing

Instanced objects are exported as references in USD. Else they are exported as real objects.

Grease Pencil as SVG

Exports the grease pencil object as a svg file.

Scene Options

Object

What kind of objects to export from the scene.

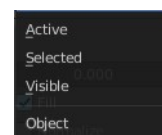
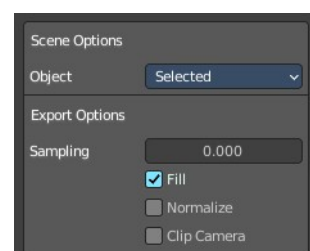

Export Options

Sampling

Precision of Stroke sampling. Low values gives high precision. Zero disables the feature.

Fill

Export strokes with fill enabled.

Normalize

Export strokes with constant thickness.

Clip Camera

Clip drawings to camera size when exporting.

Grease Pencil as PDF

Exports the grease pencil object as a pdf file.

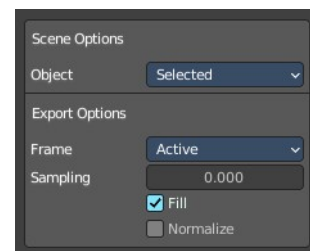

Scene Options

Object

What kind of objects to export from the scene.

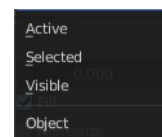

Export Options

Frame

Which frames to include in the export. The active frame or the selected frames. The active frame must not be the selected frames since you can select more than one.

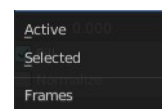

Sampling

Precision of Stroke sampling. Low values gives high precision. Zero disables the feature.

Fill

Export strokes with fill enabled.

Normalize

Export strokes with constant thickness.

Wavefront(OBJ)

Wavefront Obj is a file format for static geometry. And while you can still create a sequence of meshes for animation with it (some software stores shape keys that way for example), you cannot store animation in the file. It is also unique since it is usually made of two files. A OBJ part that contains the mesh data. And a MTL part that contains the material including the connected textures.

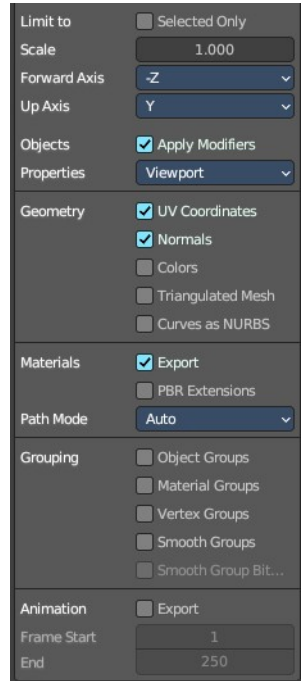

Limit to

Selected Only

Just export the selected geometry.

Scale

The export scale factor.

Forward Axis

Which axis points forward.

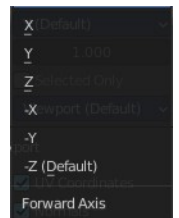

Up Axis

Which axis points upwards.

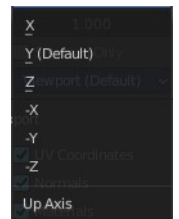

Object

Apply Modifiers

Apply modifiers before exporting the geometry.

Properties

Where to grab the object properties from. They can differ between viewport settings and render settings.

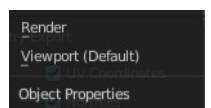

Geometry

What kind of data to export. The labels should be self explaining.

Note that the OBJ file format cannot carry the Blender material settings. The Obj file format uses a primitive Phong shader.

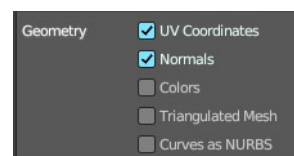

Materials

Export

Export MTL Library. You need a Principled Node with a texture node connected.

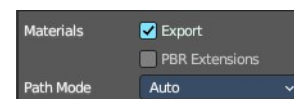

PBR Extensions

Export MTL Library using PBR extensions. Roughness, Metallic, Sheen, Clearcoat, Anisotropic and Transmission.

Path Mode

The method to use reference paths.

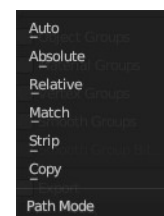

Grouping export

What kind of relationship data to export. The labels should be self explaining.

Note that the OBJ file format cannot carry the Blender material settings. The Obj file format uses a primitive Phong shader.

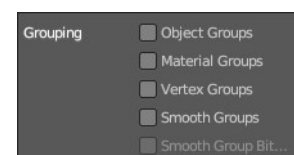

Animation

Export Animation

Export the animation. Note that Obj is no file format that can store animations. What gets exported is a sequence of single meshes.

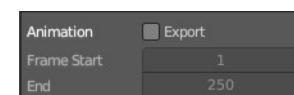

Frame Start / End

The frame start and frame end of the animation.

Motion Capture BVH

The Biovision Hierarchy (BVH) character animation file format is a file format to carry motion capture data.

To export BVH you need to have an armature with animation selected.

Transform Panel

Scale

The scale factor for the export.

Rotation

The rotation order that is defined in the BVH file.

Root Translation Only

Only write out translation values for the root bone.

Animation Panel

Start Frame

The start frame of the animation.

End Frame

The end frame of the animation.

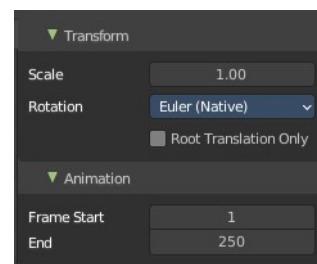

Stanford (PLY)

The Stanford Triangle Format was designed to store three-dimensional data from 3D scanners. It is a static file format for mesh data, and cannot carry animation data.

Format

Ascii or binary format.

Include Panel

Forward

The forward orientation.

Up

The up orientation.

Scale

The scale factor for the export.

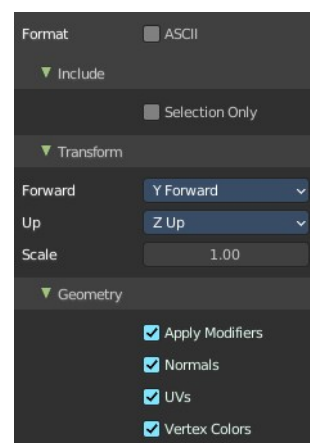

Geometry Panel

Apply Modifiers

Apply all modifiers before export.

Normals

Export Normals.

UV's

Export UV's.

Vertex Colors

Export Vertex Colors.

STL

STL (Standard Triangulation/Tessellation Language) is a standard format for many cad software. It is a format for static geometry, it cannot handle animation. The format is popular for 3d printing purposes.

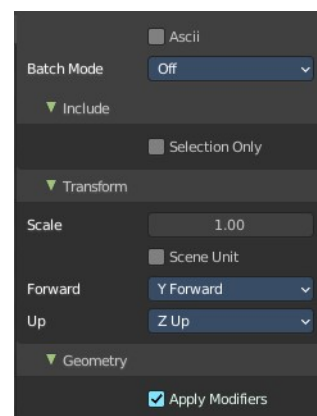

ASCII

You can either export the file as binary format or as ASCII format.

Batch Mode

Export all geometry to one file or create a file for every object.

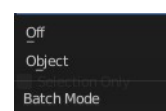

Include Panel

Selected Only

Export only the selected object(s).

Transform Panel

Scale

The import scale.

Scene Unit

Apply the scene unit at the geometry at export.

Forward

The Forward orientation at export.

Up

The Up orientation at export.

Geometry panel

Apply Modifiers

Apply all modifiers before export.

FBX

FBX is a proprietary file format from Autodesk. FBX is a general file format that is able to store and load animation.

Operator Presets

Store and load presets. To add a preset, adjust the import dialog, click at the + button behind the drop down box, add the name of the preset, and click OK. The preset will be stored automatically. To use the preset simply choose it in the drop down box. Don't get irritated by that the drop down box still shows "Operator Presets" when you choose your preset. The values of the chosen preset are set.

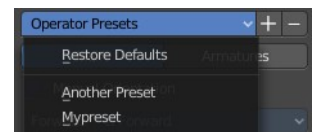
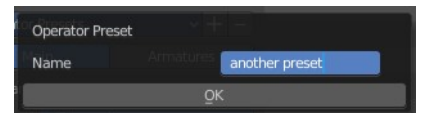

To remove a preset choose it in the drop down box, and click at the - button behind the drop down box. Also here, don't get irritated by that the drop down box still shows "Operator Presets" . The chosen preset will be deleted.

The FBX exporter is divided into several panels since it would be too much to display all settings at once.

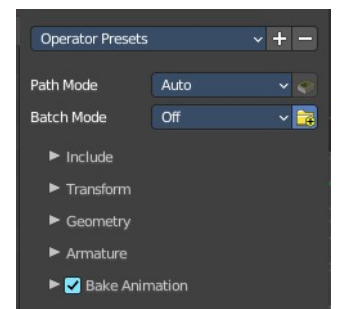

Path Mode

Method used to reference paths.

Embed Textures

Embed textures in the FBX Binary. Just with method Copy!

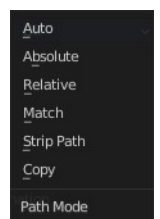

Batch Mode

Gives the opportunity to batch export independent parts. Like one file for each scene. Or one file for each collection.

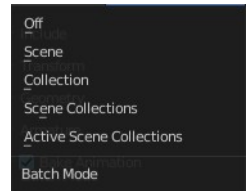

Batch Own Dir

Setup the export directory for batch export.

Include Panel

Limit to

Selected Objects

Export just selected objects.

Active Collection

Export just the active collection.

Object Types

What object types in the scene to export. Holding shift key adds to the current selection.

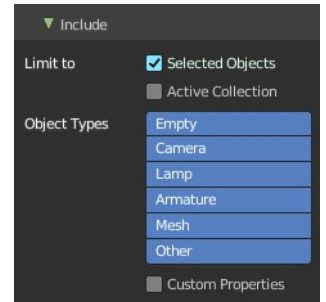

Custom Properties

Export custom properties if available.

Transform Panel

Scale

The scale factor for export.

Apply Scaling

How to apply custom and unit scaling in the generated FBX file.

Forward

The forward orientation.

Up

The up orientation.

Apply Unit

Take the current Blender Units into account.

Use Space Transform

Apply global space transforms to the object rotations.

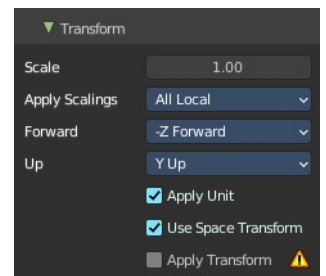

!Experimental! Apply Transform

Bake space transform into object data.

Geometry Panel

Smoothing

Define what smoothing information gets exported.

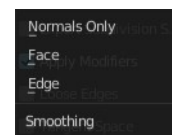
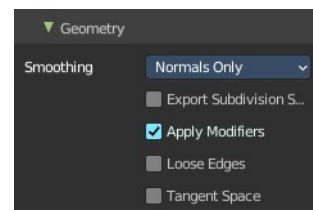

Export Subdivision Surface

Export the last catmull rom subdivision modifier as FBX subdivision. This does not apply the modifier, even if apply modifiers is enabled.

Apply Modifiers

Apply existing modifiers before exporting.

Loose Edges

Export loose edges. Loose edges are polygons with just two vertices.

Tangent Space

Add binormal and tangent vectors together with the tangent space information. This feature just works with tris or quads.

Armatures

Primary Bone Axis

The primary bone axis orientation.

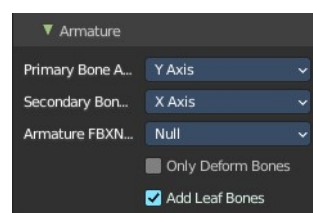

Secondary Bone Axis

The secondary bone axis orientation.

Armature FBX Node Type

FBX type of node used to represent a Blender Bone.

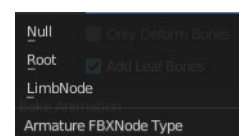

Only Deform Bones

Only export deforming bones, and none deforming ones when they have children.

Add Leaf Bones

Add a final bone at the end of every bone chain.

Bake Animation

Export baked keyframe animation.

Key all Bones

Force export at least one key of animation for all bones.

NLA Strips

Export each non muted NLA strip.

All Actions

Export each action as a separated FBX anim stack.

Force Start/ End Keying

Always add a key frame at start and end of actions for animation channels.

Sampling Rate

How often to evaluate animated values, in frames.

Simplify

Simplify the animation. 0.0 to disable. 1.0 does not simplify at all. Higher values simplifies the animation then.

glTF 2.0 (glb, gltf)

The GL Transmission Format from the Khronos Group is a file format for 3D scenes and models, and is based at the JSON standard.

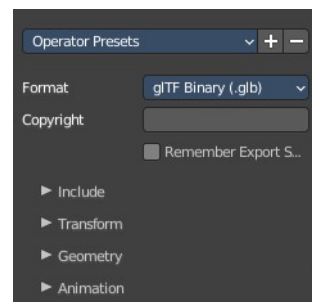

Operator Presets

Store and load presets. To add a preset, adjust the import dialog, click at the + button behind the drop down box, add the name of the preset, and click OK. The preset will be stored automatically. To use the preset simply choose it in the drop down box. Don't get irritated by that the drop down box still shows "Operator Presets" when you choose your preset. The values of the chosen preset are set.

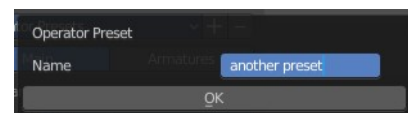

To remove a preset choose it in the drop down box, and click at the - button behind the drop down box. Also here, don't get irritated by that the drop down box still shows "Operator Presets" . The chosen preset will be deleted.

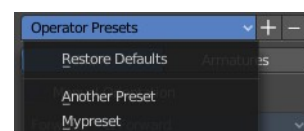

glTF 2.0 exporter is divided into several tabs since it would be too much to display

all settings at once.

Format

Choose between three export formats. Binary, Embedded and Separate.

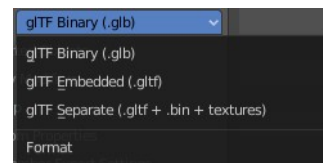

Copyright

Enter a custom copyright string.

Remember Export Settings

Store glTF settings in the blender project. You need to save the project then.

Include panel

Limit to

Limit the export to the chosen selection.

Selected Objects

Export just selected objects.

Visible Objects

Export just visible objects.

Renderable Objects

Export just renderable objects.

Active Collection

Export just selected objects from the active collection.

Active Scene

Export everything in the active scene

Data

Custom Properties

Include custom properties in the export.

Cameras

Include cameras in the export.

Punctual Lights

Include punctual lights in the export.

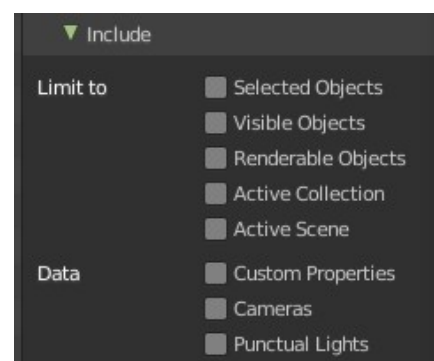

Transform Panel

Y Up

Export all objects with the Y up orientation.

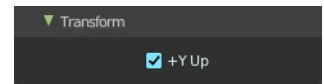

Geometry Panel

Apply Modifiers

Apply all modifiers before export.

UV's

Export UV's

Normals

Export Normals.

Tangents

Export Tangents.

Vertex Colors

Export Vertex Colors.

Loose Edges

Export loose edges.

Loose Points

Export loose points.

Materials

How to deal with materials at export. Export them, export with placeholders, or don't export.

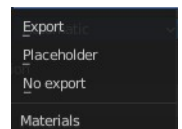
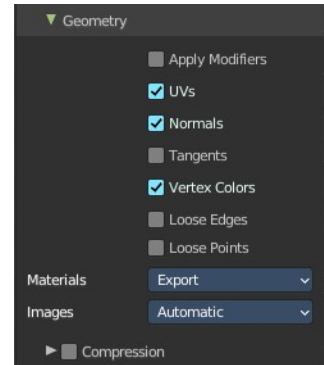

Images

How to deal with images at export.

Automatic

exports PNG images as Png Images, and Jpg Images as Jpg images.

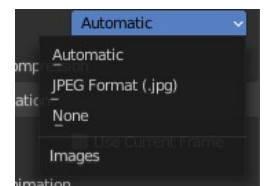

Jpeg Format (jpg)

Exports all images as jpg.

None

Exports no images.

Compression sub subpanel

Compress the mesh data using the Draco algorithm.

The settings should be self explaining.



Animation

Use Current Frame

Export the scene in current animation frame.

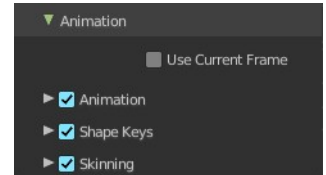

Animation sub subpanel

Export active actions and NLA tracks.

Limit to Playback Range

Clips animations to selected playback range.

Sampling Rate

How often to evaluate animated values in frames

Always Sample Animations

Apply sampling to all animations.

Group by NLA Tracks

Group actions with the same name into their own NLA tracks.

Export Deformation Bones only

Export Deformation Bones only.

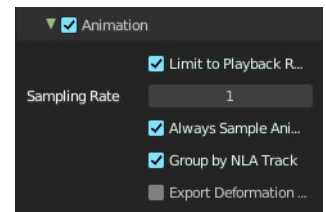

Shape Keys sub subpanel

Export Shape Keys. Also called Morph Targets.

Shape Key Normals

Export vertex Normals. with shape keys.

Shape Key Tangents

Export vertex tangents with shape keys.

Skinning

Export Skinning data.

Include all Bone Influences

Allow vertex influences greater 4.

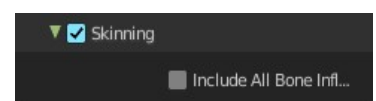
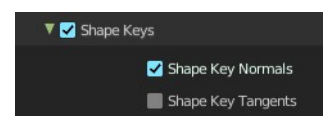

X3D Extensible 3D

Extensible 3D (X3D) is a family of co-ordinated royalty-free open standards for file formats that can store representations of interactive 3D objects and scenes.

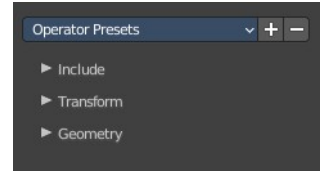

Operator Presets

Store and load presets. To add a preset, adjust the import dialog, click at the + button behind the drop down box, add the name of the preset, and click OK. The preset will be stored automatically. To use the preset simply choose it in the drop down box. Don't get irritated by that the drop down box still shows "Operator Presets" when you choose your preset. The values of the chosen preset are set.

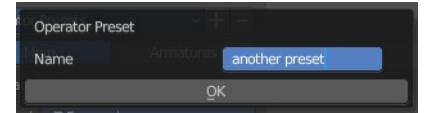

To remove a preset choose it in the drop down box, and click at the - button behind the drop down box. Also here, don't get irritated by that the drop down box still shows "Operator Presets". The chosen preset will be deleted.

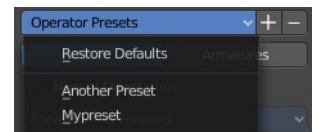

Include Panel

Selection Only

Export just selected objects.

Hierarchy

Export Parent Child relationship.

Name Decorations

Add Name Prefixes to indicate their type.

H3D Extensions

Export shaders for H3D.

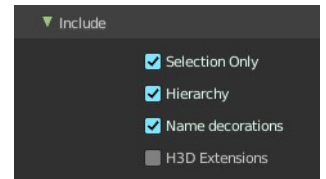

Transform Panel

Scale

The scale factor.

Forward

The forward orientation.

Up

The up orientation.

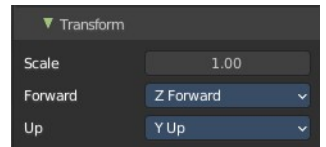

Geometry Panel

Apply Modifiers

Apply modifiers before export.

Triangulate

Triangulate the geometry before export.

Normals

Export Normals.

Compress

Compress the exported file.

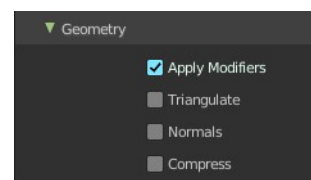

External Data

A Blend file may work with external data. Textures for example. Or text files. Or other Blend files, used as libraries.

In this menu you can adjust some settings for external data.

External data like textures or text files can also be packed directly into the blend file. This has some advantages, like that now all data is in one file. But also some drawbacks. Texture editing is for example not longer possible. You would have to export the texture first to be able to save the modifications.

Packed data displays a packed icon in the drop down box. This example is from the header of the UV editor. But you can see this icon also in the material editor at the texture node then.

Library Blend files cannot be packed. Use append instead of link to have the data of another blend file in the blend file.

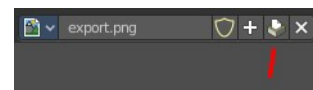
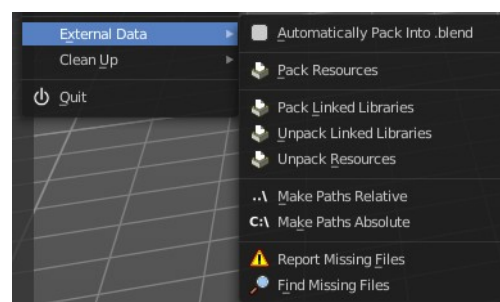

Automatically Pack into .blend

Automatically pack all files into the blend file. Don't forget to save the blend file. Note that this greys out the two menu items Pack all into Blend and Unpack packed Files.

Pack Resources

Packs all external data into the blend file. Note that the paths must fit, and the external data must be available. A common pitfall here is that the textures uses absolute paths, and are moved to another location meanwhile. See Make all Paths Relative or Find missing Files. Or that you have a not longer existing file linked that shouldn't be in the blend file at all. See Outliner, Orphan Data.

You will get a warning when something is missing.

Pack linked libraries

Pack all linked library files into the current .blend file



Unpack linked libraries

Unpack all linked library files from the current .blend file to their original locations.

Unpack Resources

Unpack packed files exports all packed data. You will get an options menu choose between several different unpack methods.

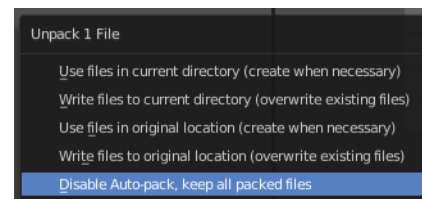

Use Files in current Directory (create when necessary)

Extracts all files to the current directory of the blend file. If the files in the current directory exists, reuse it. Else extract the ones from the blend file.

NOTE! The title is misleading, it does NOT write the files to the current directory. But into a sub folder, textures for example, in the current directory. Which gets created if necessary. And this option is not to change.

Write files to current directory (overwrite existing files)

Extracts all files to the current directory of the blend file, and writes it to the current directory. Existing content will be overwritten.

NOTE! The title is misleading, it does NOT write the files to the current directory. But into a sub folder, textures for example, in the current directory. Which gets created if necessary. And this option is not to change.

Use files in original location (create when necessary)

Extracts all files into their original directories where they were before packing them into the blend file. If the files in the original directory exists, reuse it. Else extract the ones from the blend file. This feature uses absolute paths.

Write files to original location(overwrite existing files)

Extracts all files into their original directories where they were before packing them into the blend file. If the files in the original directory exists, reuse it. Else extract the ones from the blend file. This feature uses absolute paths.

Make Paths Relative

The path will be shortened to just the file name. For example, C:\myfolder\mysubfolder\mytexture.jpg turns into texture.jpg . Relative paths allows you to move the whole project folder to another location. The file paths will still be valid.

Make Paths Absolute

Makes all paths absolute. For example, texture.jpg turns into C:\myfolder\mysubfolder\mytexture.jpg. Absolute paths requires the full valid path for all files.

Report Missing Files

Scans through the blend file and tries to find missing files. You will get a warning when a missing file is found.

Find Missing Files

Browse for the new location of moved files.

Clean Up

Here you can remove unused data. It removes all data from the scene that is not longer in use and has no fake user assigned to keep it in the scene.

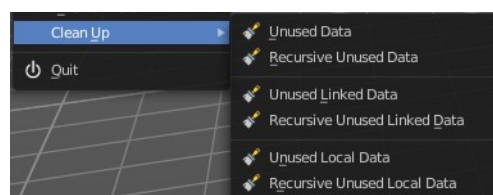

It is similar functionality to the Clean Up feature in the outliner. But more granular. Unused Data does the same than the purge button in the outliner.

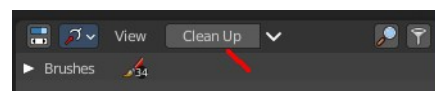

Unused Data

Removes unused data blocks.

Recursive Unused Data

Recursively removes unused data blocks. Means the child objects gets removed too.

Unused Linked Data

Removes unused data that is linked to this file.

Recursive Unused Linked Data

Recursively removes unused data that is linked to this file. Means the child objects gets removed too.

Unused Local Data

Removes unused local data.

Recursive Unused Local Data

Recursively removes unused local data. Means the child objects gets removed too.

Quit

Quit Bforartists.



5.1.2 Topbar and Statusbar - Edit menu

Table of content

Edit Menu.....	2
Undo.....	2
Redo.....	2
Undo History.....	2
Repeat Last.....	2
Repeat History.....	2
Adjust Last Operation.....	2
Menu search.....	3
Operator Search.....	3
Rename active Item.....	3
Batch Rename.....	3
Add / Remove Operator.....	4
Data Source.....	4
Data Type.....	4
Type.....	4
Find / Replace.....	5
Find.....	5
Replace.....	5
Case Sensitive.....	5
Set Name.....	5
Method.....	5
Name.....	5
Strip Characters.....	5
Characters.....	5
Strip From.....	5
Change Case.....	5
Convert to.....	5
OK.....	5
Application Templates.....	6
How to create an application template.....	6
Save Startup File.....	7
Load Factory Settings.....	7
Open Preferences Folder.....	7
Preferences.....	7

Edit Menu

Undo

Reverts the last step.

Note. Bforartists uses two separated histories for the Object Mode and the Edit Mode. Means when you leave the Edit mode then you will loose the undo steps in the edit mode.

Redo

Rolls back your last Undo action.

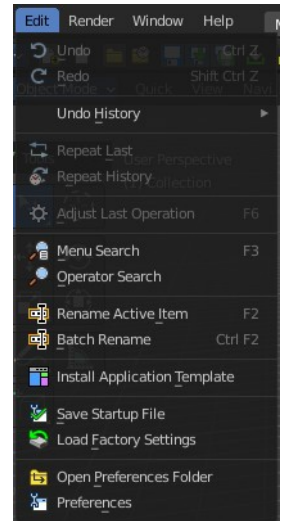

Undo History

The Undo History is a list of the last operations. Here you can roll back to a specific step.

Note that this Undo History is a session history, and does not save to the Blend file.

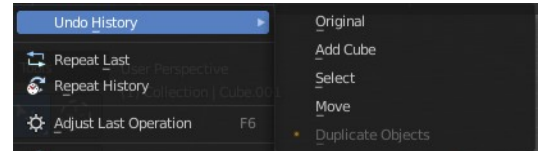

Repeat Last

Repeat last repeats the last operation. For example, when you have moved an object by 5 in X, then it moves the object by 5 in X with every repeat last step.

Repeat History

Repeat History calls a menu with the last actions where you can choose an action to be repeated.

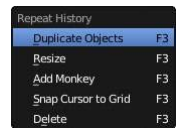

Adjust Last Operation

Some operations have settings, and can be further tweaked. It's the Blender ass forward concept for setting up an operation. In other software you set up an operation and perform it then with this settings. In Blender you first perform the operation, and tweak its settings afterwards. At least sometimes, this concept is not consistent. Bforartists is a fork of Blender. And so we have to live with this concept too.

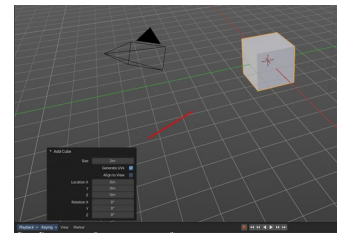

For example, when you create a primitive, then you may want to adjust the size, or tick options like generate UV's at creation. This is done in the Last Operator panel. This Last Operator Panel is usually down left in the view.

The Adjust Last Operation calls exactly this content as a menu popup.

Note that when you perform another operation, like moving the cube after creation, then the last operation content for creation is gone. It will now display the last operation content for the transform operation.

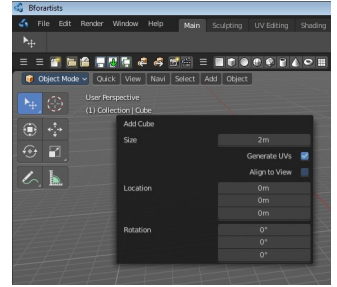

Menu search

Lists the available menus.

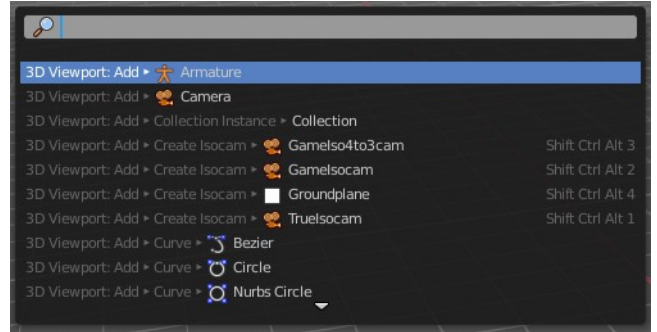

Operator Search

This menu item calls a search menu where you can search through all available operators, and perform them if needed. Think of it as one gigantic searchable drop down menu that contains everything available.

Even operators that have no menu entries are listed. Which is useful for scripting purposes, when you want to perform a script operation, but don't have a menu button (yet).

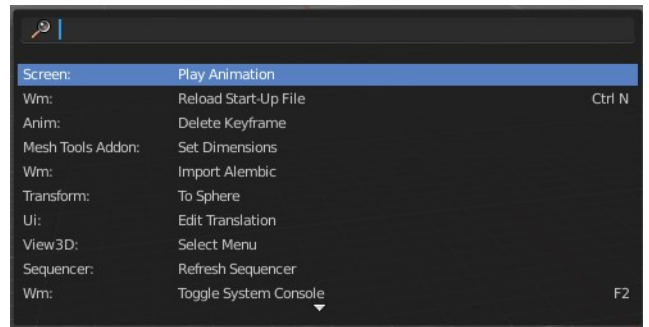

You can navigate with the mouse or with arrow up and down buttons. Performing an operator can be done by clicking at it or by hitting enter.

Note that this search just lists the old traditional operators from before Blender 2.80. Not the ones in the Tool Shelf, which is a completely independent tool system.

Rename active Item

Allows you to rename the currently active item. A rename dialog will pop up where you can type in a new name for the current item. You can have more than one item selected. Just the active item gets renamed.



Batch Rename

Allows you to rename more than one item or parts of the name at once. It will open a rename dialog with

various settings.

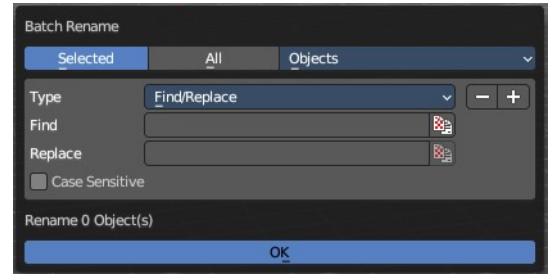

Add / Remove Operator



This allows you to add more than one operator and method. And here you can remove the operators too.

Data Source

Rename just the selected objects, or all objects.

Data Type

Choose the data type that you want to process.

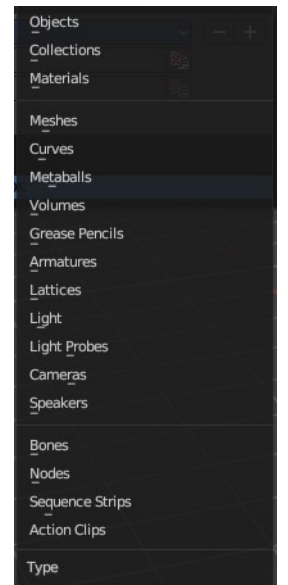

Type

Choose the operation method. The content of the panel will change with the different types.

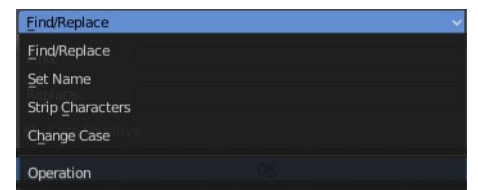

Find / Replace

Find and replace names in the chosen objects.

Find

The string that you want to modify.

Replace

The replacement.

Case Sensitive

Operate case sensitive, or handle small and big letters as equal.

Set Name

Set name of the chosen objects.

Method

Set the method.

Sets the name new. Sets a number as a prefix Or Sets a number as a suffix.

Name

The name to set.

Strip Characters

Strip characters in the names of the chosen objects.

Characters

What type of characters to change.

Strip From

To strip from the start or to strip from the end.

Change Case

Convert to

Change the string to upper case, lower case or title case.

OK

Accept the settings and apply the batch rename operation.

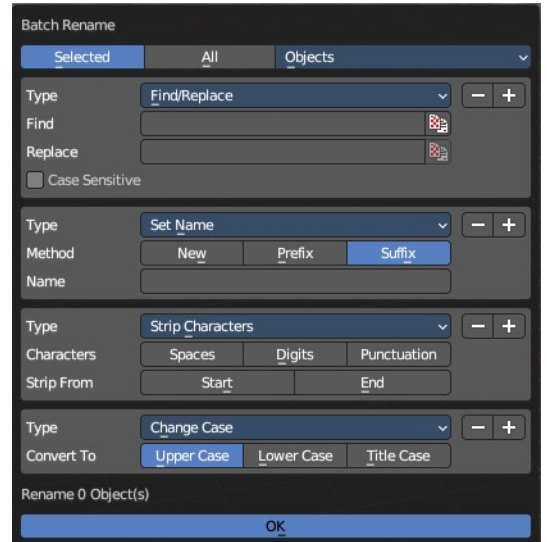

Application Templates

Load a new application template.

Application templates is a predefined set of workspaces with its own setup. It can contain its own layout, theming, its own startup file, its own add on set and scripts, a own key map and own lighting, and its own User Preferences.

Bforartists comes with six internal application templates already. Have a look at the "new" menu item in the file menu. Clicking at one of the menu items creates in fact a new scene by using one of the existing application templates.

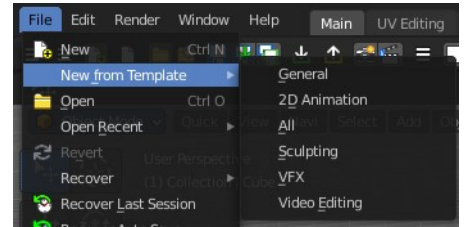

How to create an application template

An application template is basically a zip file that contains a startup.blend, a userpref.blend, a splash.png and a __init__.py file that defines this all as an application template.

startup.blend and userpref.blend can be created in the Edit menu. So tweak everything to your needs, and save the startup file.

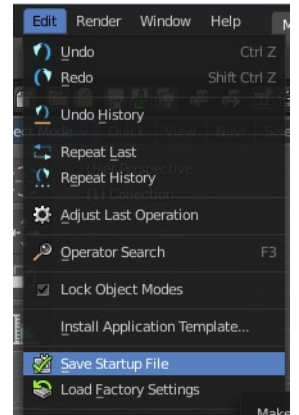

At Windows you will find them in the appdata directory in the Bforartists folder.

At Linux it's in /home/yourusername/.config/bforartists/2.80/config/

Copy those two files, startup.blend and userpref.blend, and throw them into a folder where you want to build the application template in. Rename this folder to AT_01, or to whatever name you want it to use.

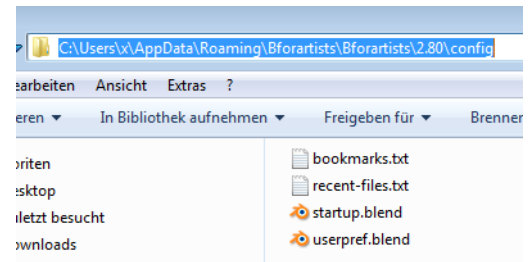

Next create a png image as a splash screen for your template, and save it as splash.png into the AT_01 folder. The required size is 501x250. Everything else will throw an error, and you won't be able to see the new splash. You can alternatively also create a splashx2.png file in double size. This is for hi dpi monitors.

The required __init__.py file is a python file with a def register and a def unregister.

```
def register():
    print(Registering application template : {0}.format(__name__))

def unregister():
    print(Unregistering application template : {0}.format(__name__))
```

So copy over this text, and save this file as __init__.py in the AT_01 folder

We should now have four files in the AT_01 folder. Zip the AT_01 folder. The template is finished for installing.

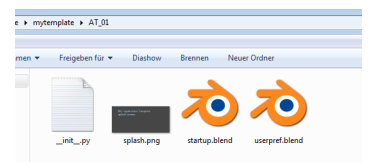

But as a last step, and before you install the template, remove the startup.blend and userpref.blend that we have created to build the application template from the config directory, to have a clean environment.

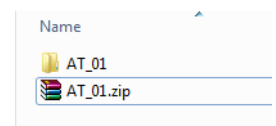

Once installed you will find the new application template in the New menu.

To remove an application template you need to remove its data in the config folder. There is no functionality to uninstall it.

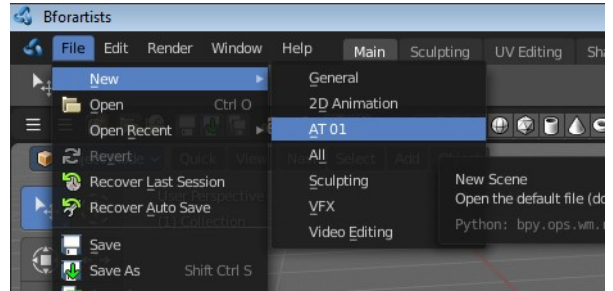

Save Startup File

Saves a startup.blend with the current configuration.

A startup.blend stores layout informations. Editor layouts, default values, if a panel is open or closed, etc. .

Load Factory Settings

Resets Bforartists into a fresh installed state. All customer modifications, like activated addons, changes at the layout, etc. will be ignored.

Open Preferences Folder

Opens the folder in which the Bforartists settings and addons are stored.

Preferences

Opens the Preferences window. Adjust various settings.

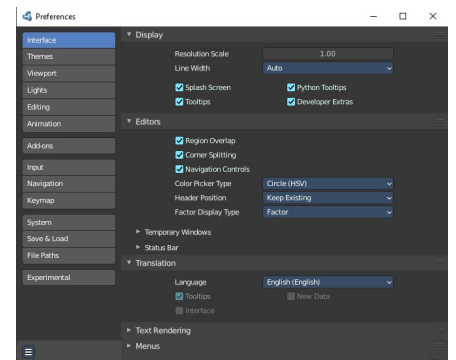



5.1.3 Topbar and Statusbar - Render menu

Table of content

Render Menu.....	2
Render Image.....	2
Render Animation.....	2
Mixdown Audio.....	2
Options.....	2
Relative Path.....	2
Accuracy.....	2
Containers.....	2
Format.....	2
Split Channels.....	2
OpenGL Render Image.....	3
OpenGL Render Animation.....	3
Show / Hide Render.....	3
Play rendered Animation.....	3
Lock Interface.....	3

Render Menu

This menu contains functionality around rendering.

Most of the render settings can be found in the Properties editor in the Render tab. And here you can also choose the render engine.

Rendered images can be saved in the Image menu like any other image.

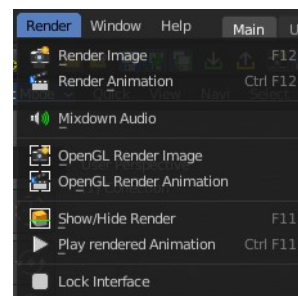

Render Image

Renders the current scene as an image by using the current chosen renderer.

Render Animation

Renders the current scene as an animation by using the current chosen renderer.

Mixdown Audio

Mixdown and export the scene's audio to an audio file. You will open an export dialog when you click at Mixdown Audio. Further Audio settings can be found in the Properties editor.

Options

The options can be found down left in the Save dialog.

Relative Path

Select the file relative to the blend-file.

Accuracy

Sample accuracy, important for animation data (the lower the value, the more accurate).

Containers

Choose between different audio export formats.

Format

Some *Audio Containers* also have option to choose a codec. For more information see [here](#).

Split Channels

Each audio channel will be rendered into a separate file.

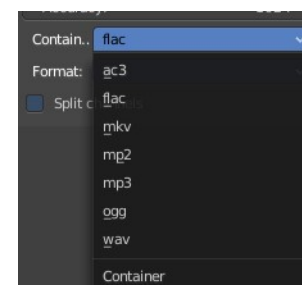
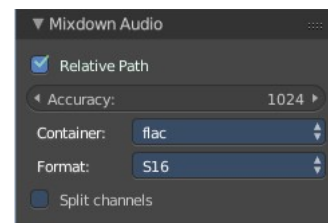

OpenGL Render Image

Renders an Image, using the Viewport OpenGL renderer.

OpenGL Render Animation

Renders an animation, using the Viewport OpenGL renderer.

Show / Hide Render

Toggles the display of the render view.

Play rendered Animation

Plays back the rendered animation sequence.

Lock Interface

Lock the interface while rendering to free the memory for the UI to the renderer.



5.1.4 Topbar and Statusbar - Window menu

Table of content

Window Menu.....	1
New Window.....	1
New Main Window.....	1
Toggle Window Full screen.....	1
Next Workspace.....	1
Previous Workspace.....	1
Show Status Bar.....	1
Save Screenshot.....	1
Save Screenshot (Area).....	2
Toggle System Console.....	2

Window Menu

Window related functionality.

New Window

Creates a new instance of Bforartists. But without Top Bar.

New Main Window

Creates a new instance of Bforartists with its own workspace and scene settings and with the Top Bar.

Toggle Window Full screen

Makes Bforartists full screen.

Next Workspace

Cycle to next workspace.

Previous Workspace

Cycle to previous workspace.

Show Status Bar

Display the footer.

Save Screenshot

Saves a screenshot from the whole application.

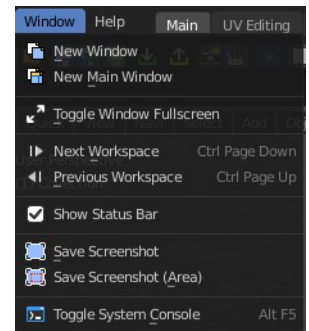

Save Screenshot (Area)

Saves a screenshot from the area under the mouse.

Toggle System Console

Toggles the System console. This is a Windows feature. Under Linux and Mac you can use the bash.



5.1.5 Topbar and Statusbar - Help menu

Table of content

Help Menu.....	1
Manual.....	1
Release Note.....	1
Bforartists Website.....	1
Quickstart Learning Videos.....	1
Report a Bug.....	1
Blender Python API reference.....	1
Save System Info.....	1
Splash Screen.....	2

Help Menu

The Help menu contains some external links to useful resources. In this menu you can also find a utility to save the system information and to show the splash screen.

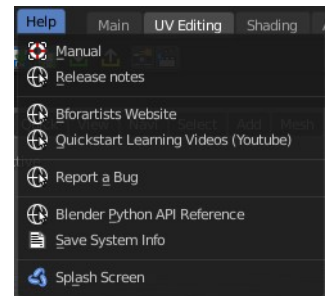

Manual

Opens the Bforartists Manual page in a web browser.

Release Note

Opens the Bforartists Release note page in a web browser.

Bforartists Website

Opens the Bforartists page in a web browser.

Quickstart Learning Videos

Opens the Bforartists Quickstart Youtube channel where you can find the Quickstart tutorial learning videos.

Report a Bug

Report a bug. The link leads you to GitHub. You need to create a GitHub account to be able to report a bug.

Blender Python API reference

Opens the Blender Python API reference page in a web browser.

Save System Info

Save your system informations to a text file.

Splash Screen

Reveals the Splash Screen.



6 Editors introduction

Table of content

Introduction.....	2
Header right click menu.....	2
Toggle Header.....	2
Flip to Bottom / Top.....	2
Collapse Menus.....	2
Hide Editortype Menu.....	3
Horizontal Split.....	3
Vertical Split.....	3
Duplicate Area into New Window.....	3
Toggle Maximize Area.....	3
Toggle Full screen Area.....	3
Close Area.....	3
Area Options.....	3
Horizontal Split.....	3
Vertical Split.....	3
Join Areas.....	4
Swap Areas.....	4
Editor Type menu.....	4
RMB menus at tools.....	4
Assign Shortcut / Change Shortcut / Non Keyboard Shortcut / Remove Shortcut.....	5
Online Python Reference.....	5
Edit Source.....	5
Reset to Default Value.....	5
Reset All to Default Value.....	5
Reset Single to Default Value.....	5
Unset.....	6
Add Driver.....	6
Add Drivers.....	6
Add Single Driver.....	6
Add to Keying Set.....	6
Add All to Keying Set.....	6
Add single to Keying Set.....	6
Remove from Keying Set.....	6
Copy Data Path.....	6
Copy to Selected.....	6
Copy as new Driver.....	6
Resize Tool Shelf and Properties content.....	7
Hotkey recognition.....	7
The editor types.....	8
3D Viewport.....	8
Image Editor.....	8
UV Editor.....	9
Compositor.....	9
Texture Node editor.....	9
Geometry Node editor.....	10
Shader Node editor.....	10
Video Sequence Editor.....	10

Movie Clip Editor.....11
 Dope Sheet Editor.....11
 Timeline Editor.....11
 Graph Editor.....12
 Drivers Editor.....12
 Nonlinear Animation Editor.....12
 Text Editor.....13
 Python Console.....13
 Info Editor.....13
 Toolbar Editor.....14
 Outliner Editor.....14
 Properties Editor.....14
 File Browser.....15
 Spreadsheet Editor.....15
 Preferences.....15

Introduction

The Bforartists Interface is made of several workspaces. And every layout is made of several editors.

The editors brings the functionality to the layout. Every editor type has another purpose. The 3D View for example is made to modify 3D data such as meshes or curves.

In this chapter we will talk about the general aspects of the editors. And give an overview over the available editor types and their purpose.

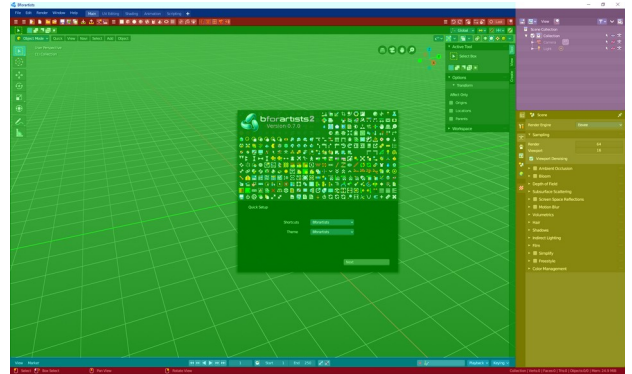

The detailed description happens for every editor one by one then.

Header right click menu

Each header has a header menu that appears when you right click at it.

Toggle Header

Hides the header. To reveal it you have to click at the small triangle at the right side then.

Flip to Bottom / Top

Displays the header at the top or the bottom of the editor.

Collapse Menus

Displays the text menus as one collapsed icon.

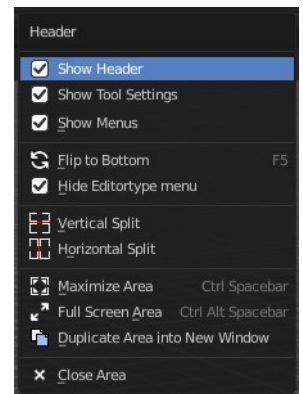

Hide Editortype Menu

Hides the editortype menu where you can switch to other editor types.

Horizontal Split

Splits the current view horizontally into two independent editor windows.

Vertical Split

Splits the current view vertically into two independent editor windows.

Duplicate Area into New Window

Duplicate Area into New Window makes the selected editor window floating. You can then drag it around at the monitor. It is not connected with the rest of the UI anymore.

A separated window cannot be merged into the main window again. You have to close it when not longer needed.

Toggle Maximize Area

Displays the editor maximized with menus.

To return from the maximized view press hotkey ctrl + spacebar. Or reuse the menu item in the area menu.

Toggle Full screen Area

Displays the editor maximized without menus.

To return from the full screen view press hotkey ctrl + alt + spacebar.

Close Area

Closes the editor.

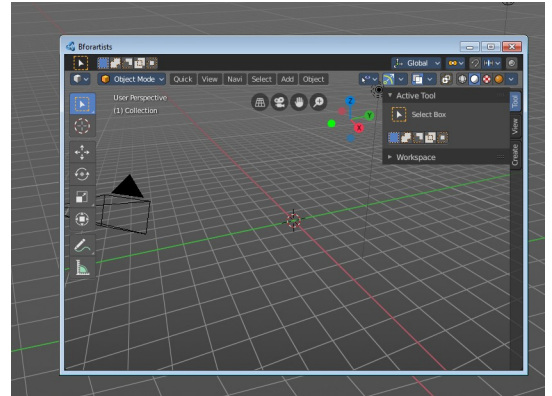

Area Options

When you right click at a border of an editor, then you will call the Area options menu.

Horizontal Split

Splits the current view horizontally into two independent editor windows.

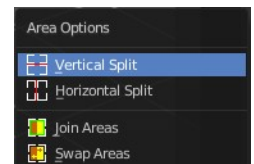

Vertical Split

Splits the current view vertically into two independent editor windows.

Join Areas

Joins the two editors that shares the border.

Swap Areas

Swaps the content of the editors that shares the border.

Editor Type menu

The Editor Type menu gives you an overview of all available editor types. And here you can switch to another editortype.

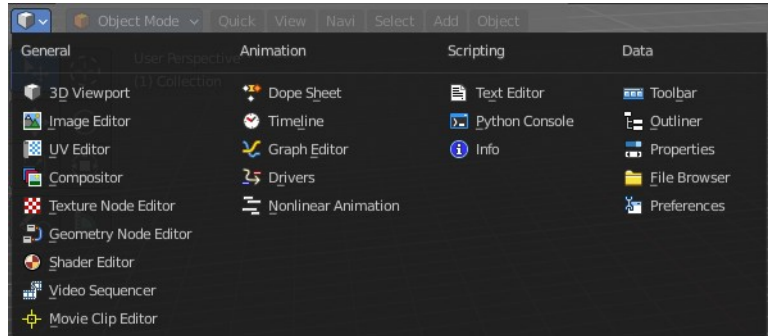

This menu is hidden in the standard workspaces. See Header Menu, Hide Editortype menu.

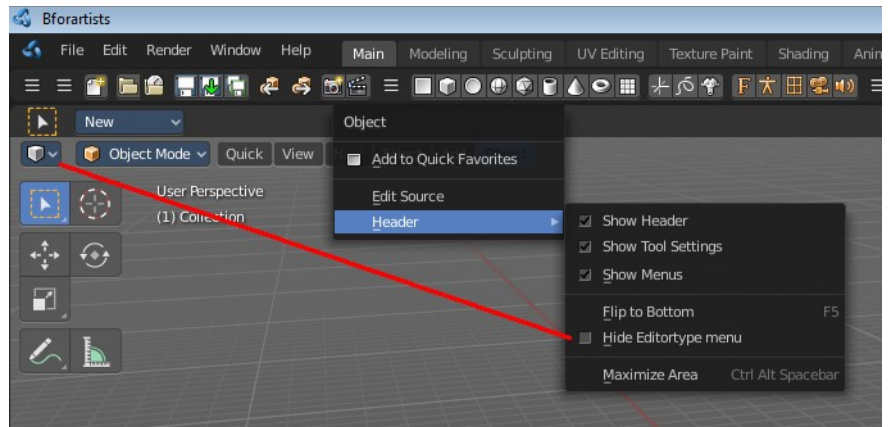

RMB menus at tools

Every tool or UI element has usually a RMB menu where you can find various things.

The content is varying, dependent of the tool where you right click at. Value edit boxes have for example a Reset to Default Value menu item. For other tools you might be able to add or change the shortcut here. They all have the last three menu items, Online Python Reference, Edit source and Edit translation.

A few examples below. But we will cover important right click functionality also at the specific tool.

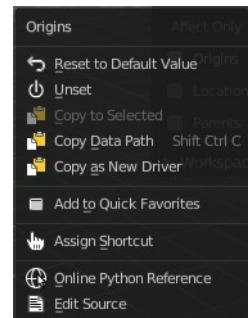

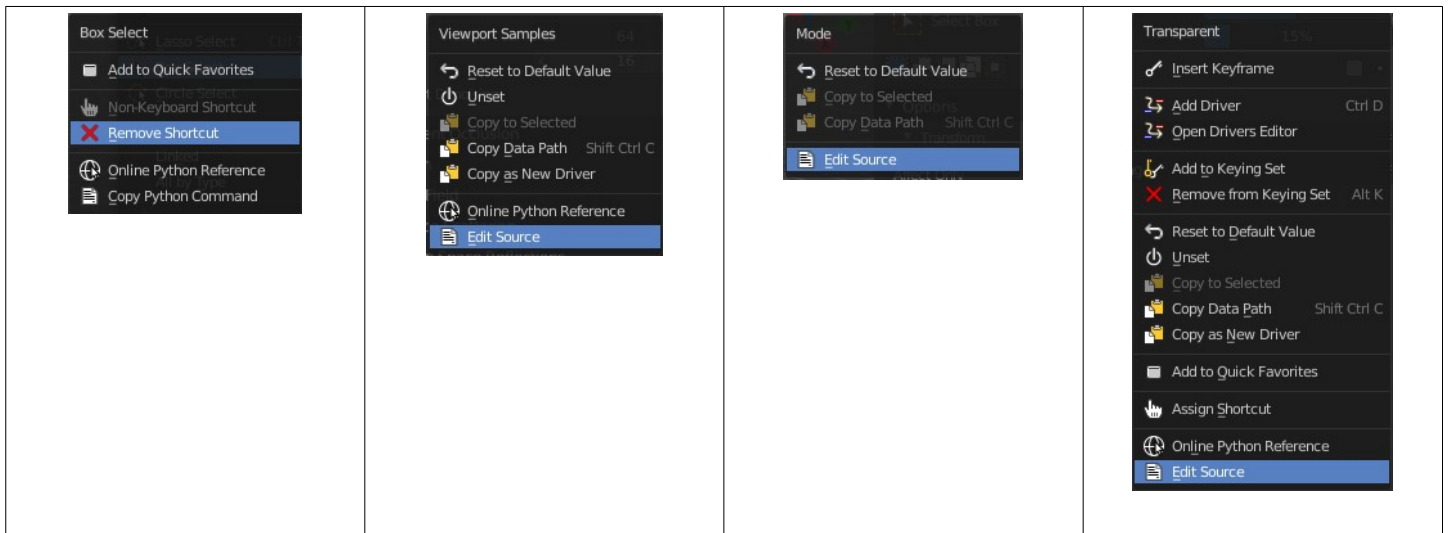

Assign Shortcut / Change Shortcut / Non Keyboard Shortcut / Remove Shortcut

These buttons allows you to assign or to remove a new shortcut to the tool or to change an existing shortcut for the tool. Note that this may or may not work proper. For some tools you might need to change the shortcut in the User preferences. Non Keyboard shortcut is such a case.

Online Python Reference

The Online Python Reference button opens the Bforartists Online Python reference page in your browser.

Edit Source

The Edit Source button opens the corresponding Python file for this element. Note that you need to be in the Scripting layout. The file loads in the Text editor there.

Reset to Default Value

Reset to Default Value is usually a RMB menu entry when you right click at an edit box. It resets the value to the default value.

Reset All to Default Value

Reset All to Default Value is usually a RMB menu entry when you right click at an edit box combo made of two, three or more edit boxes together. It resets the value for all the edit boxes in the combo to the default value.

Reset Single to Default Value

Reset Single to Default Value is usually a RMB menu entry when you right click at an edit box combo made of two, three or more edit boxes together. It resets the value for the single edit box under the mouse to the default value.

Unset

Unset is usually a RMB menu entry when you right click at an edit box. It is somehow similar to Reset to Default Value. But it clears the property instead of resetting it to the default value. Which can end in another value.

Add Driver

In Bforartists lots of things can be animated. Also buttons. Add Driver does exactly what it tells. It adds a driver for animation needs to the element.

Add Drivers

In Bforartists lots of things can be animated. Also buttons. Add Drivers does exactly what it tells. It adds a driver for animation needs to the elements.

Add Single Driver

In Bforartists lots of things can be animated. Also buttons. Add Driver does exactly what it tells. It adds a driver for animation needs to the single element under the mouse.

Add to Keying Set

Add to Keying Set adds the information of the element to the current key frame.

Add All to Keying Set

Add All to Keying Set adds the information of the element to the current key frame.

Add single to Keying Set

Add to Keying Set adds the information of the element to the current key frame.

Remove from Keying Set

Remove from Keying Set removes the information of the element from the current key frame.

Copy Data Path

Copy Data Path copies the RNA data path for this property.

Copy to Selected

Copy to Selected copies the property of this element to selected objects or bones.

Copy as new Driver

Create a new driver with this property as input, and copy it. It can then be pasted to the target property. Or pasted as a driver variable to extend an existing driver.

Resize Tool Shelf and Properties content

You can resize the Tool Shelf content and the Properties Sidebar content. This means that you can zoom in or out. This trick also works in the Properties Editor.

Move the mouse over the upper region of the Tool Shelf.

Hold down Ctrl key

Click with Middle Mouse button. The mouse pointer will turn into two white triangles.

Now drag up or down to resize the area content

OR

Move the mouse over the upper region of the Tool Shelf.

Simply press Numpad + or Numpad -

To reset the area content to default scale move the mouse over the area and press Home key (german keyboard layout Pos 1)

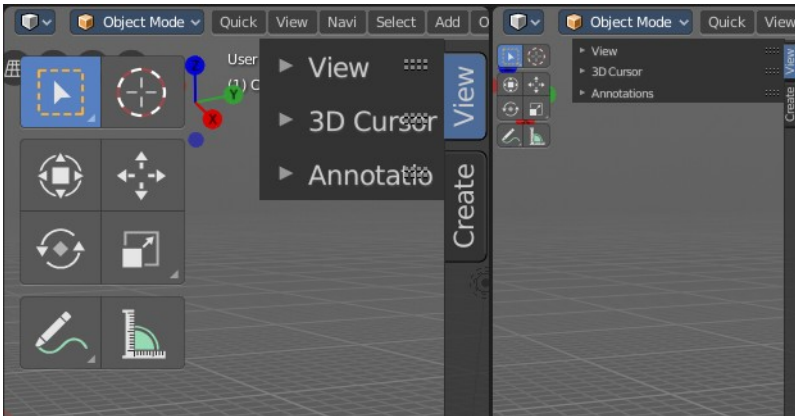

Hotkey recognition

What hotkey set works is dependent of the mouse position, over which editor the mouse is. Means when your mouse is over the 3d View, then the hotkeys from the 3D View gets recognized. This means when your mouse is not over the 3D View but the Outliner, and you press the hotkey for let's say move, then this hotkey will not be recognized.

A special behavior shows the sidebars here. They are part of the editors. But to have the mouse over the toolbars at the side can already prevent a hotkey from being triggered. Your mouse needs to stay in the active part of the editor.

The editor types

Bforartists provides a number of different Editor types for different purposes. For example, the 3D view is made to modify the 3D data, such as meshes or curves. You can have more than one editor window open at the same time.

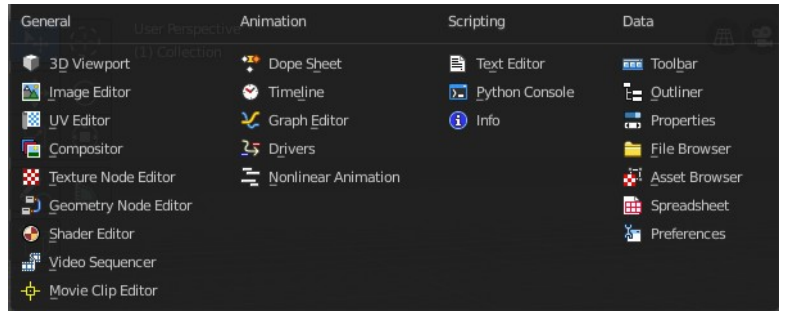

3D Viewport

The 3D View is the editor where you do your 3D work. The 3D view is the editor to model meshes, etc. . It's the core editor for everything where you work at your 3D data.

You will find it in every layout where you need to display your 3d data.

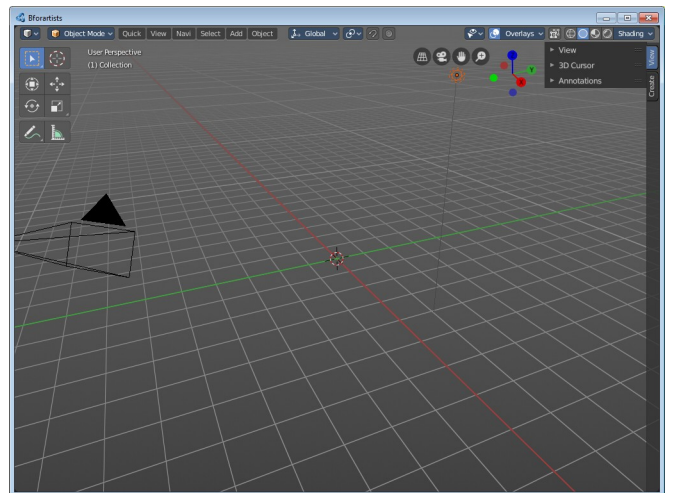
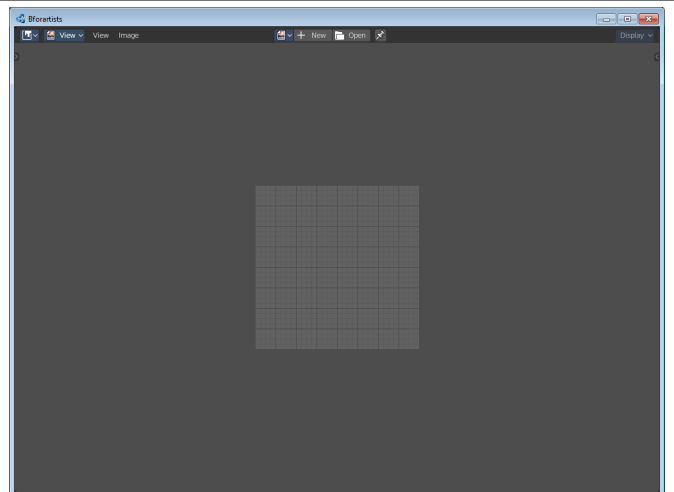

Image Editor

The Image Editor is the place where you work with textures.



Geometry Node editor

This editor allows you to manipulate geometry. It is node based.

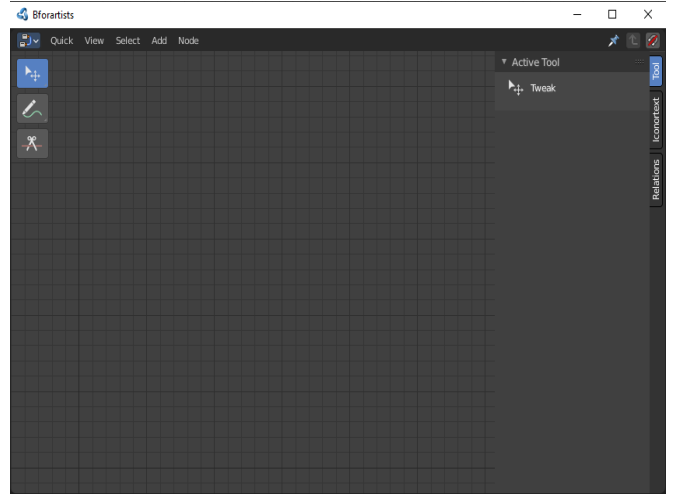

Shader Node editor

The shader Node editor is to create the materials for your objects. It is node based.

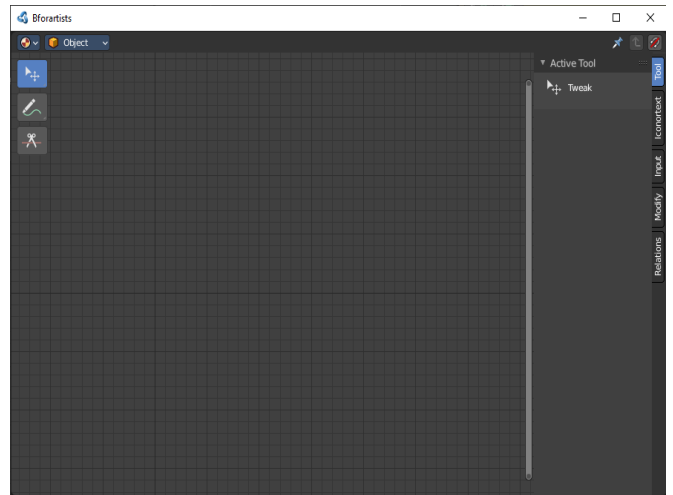

Video Sequence Editor

The video sequence editor allows you to work with video and audio clips. Here you can cut videos.

This editor can be found in the video editing layout.

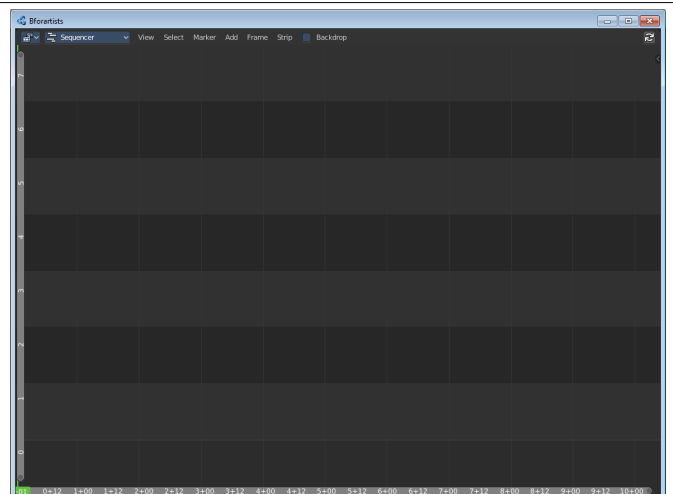

Movie Clip Editor

The movie clip editor is for tracking purposes.

You will find it in the Motion Tracking layout.

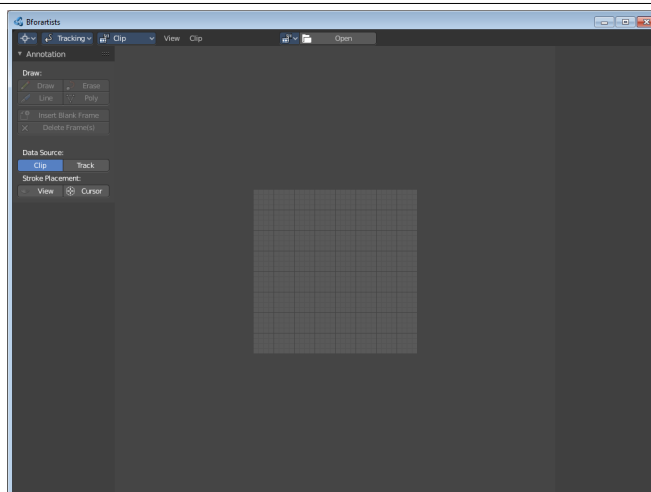

Dope Sheet Editor

The Dope Sheet Editor is the place where you deal with key frames.

The Dope Sheet Editor is one of five special editors for animation needs. You will find it in the animation layout.

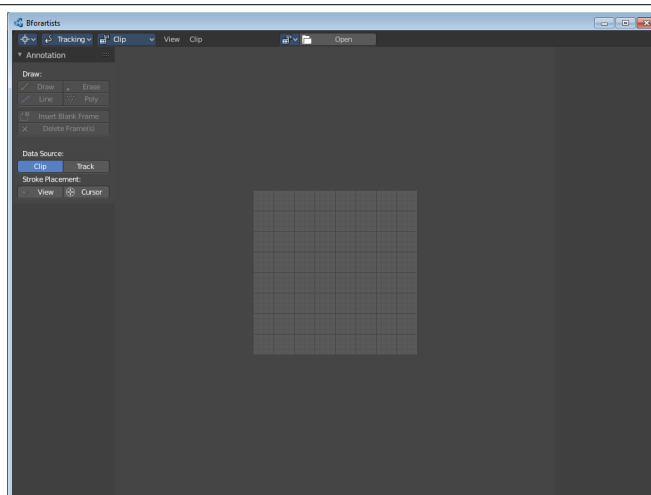

Timeline Editor

The timeline editor provides you with a toolbar for all animation needs. Start, stop, record, set keying set, etc.

The Timeline Editor is one of five special editors for animation needs. You will find it in the animation layout.

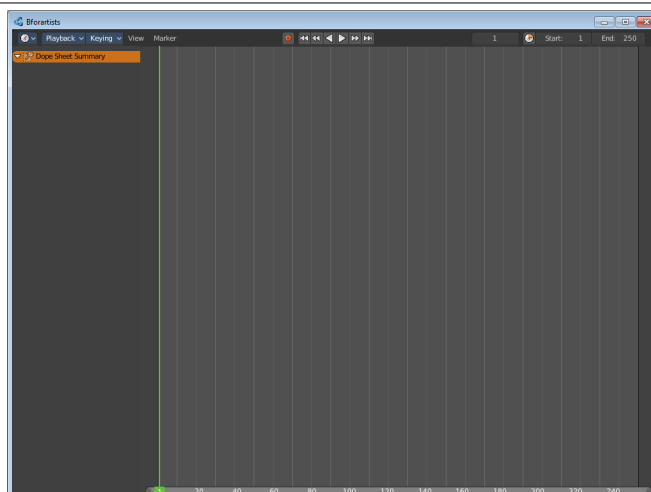

Graph Editor

The Graph Editor is the place where you work with function curves.

The Graph Editor is one of five special editors for animation needs.

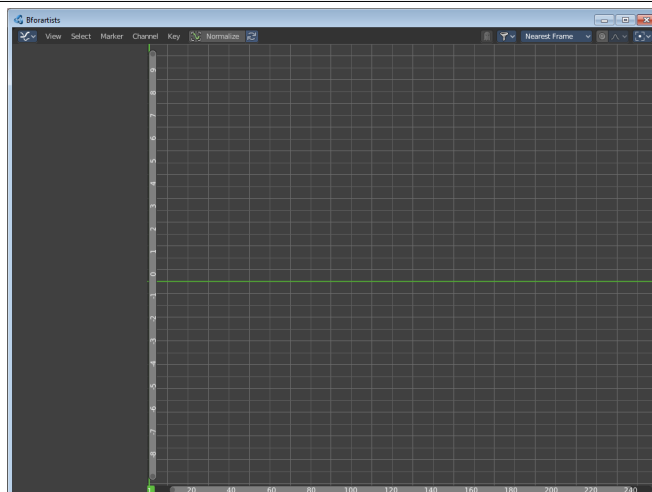

Drivers Editor

See and edit drivers.

The Drivers Editor is one of five special editors for animation needs.

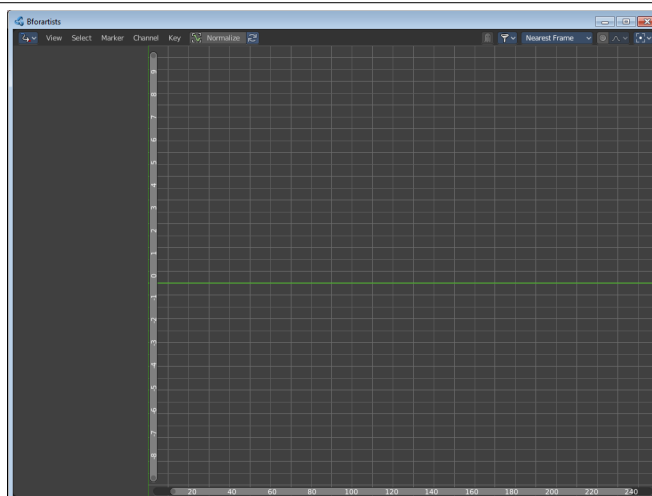

Nonlinear Animation Editor

The Nonlinear Animation Editor, in short NLA Editor, is the place where you work with Clips and Actions.

The Nonlinear Animation Editor is one of five special editors for animation needs.

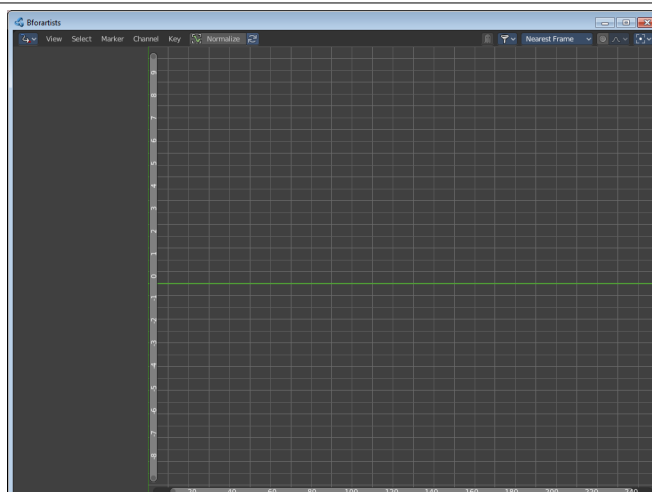

Text Editor

The Text Editor is the place where you write code. The scripts for addons for example.

You will find it in the Scripting layout.

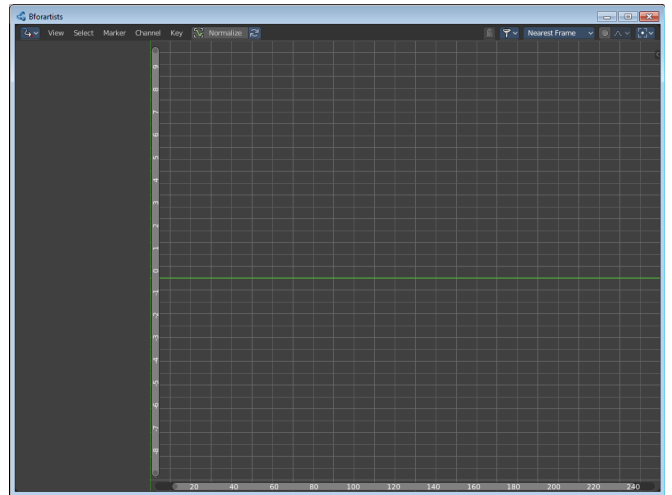

Python Console

The Python console gives you access to the Python API.

You will find it in the Scripting layout.

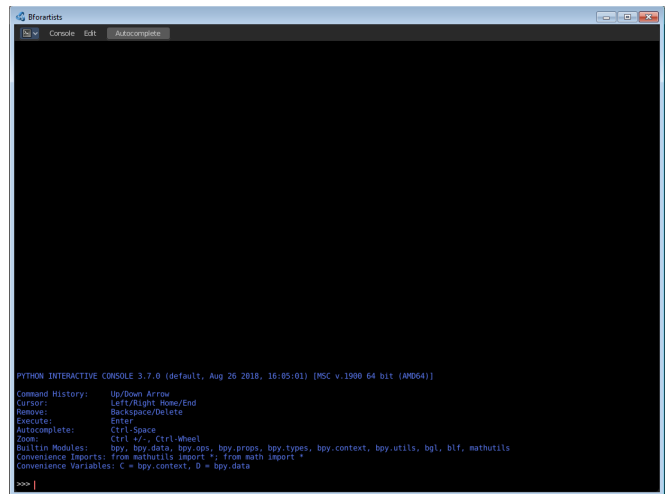

Info Editor

The Info Editor provides you with a list of the last performed operations. Including error messages.

You will find it in the Scripting layout.

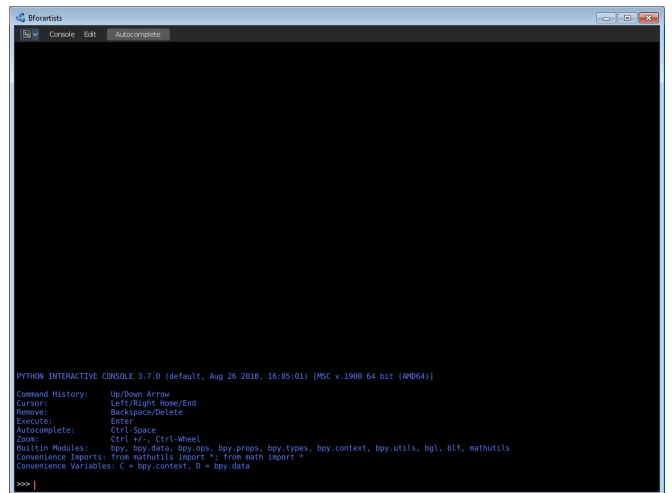

Toolbar Editor

It is as the name says a toolbar. Usually just the header area is visible. The rest of the editor has no purpose.

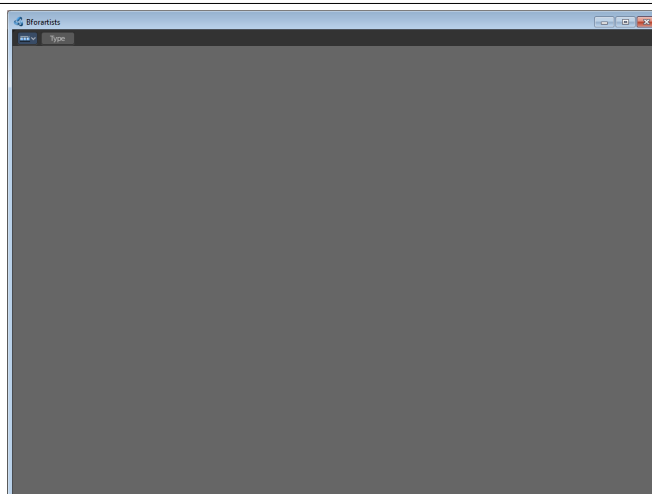

Outliner Editor

The Outliner is the place that gives you an overview of what is in the scene and in the file.

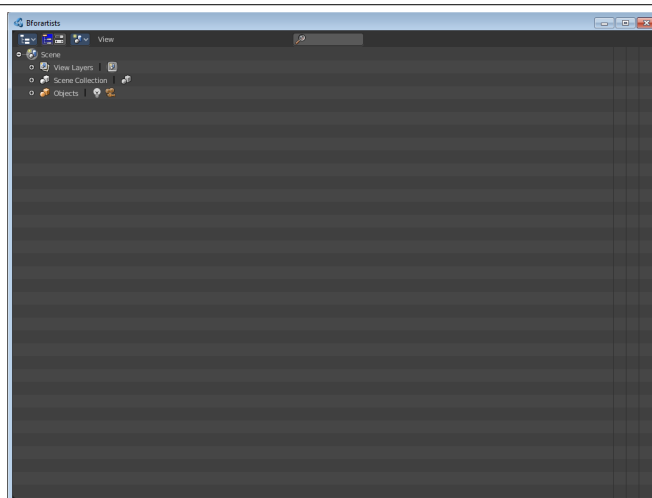

Properties Editor

The Properties editor is the place where you can see and tweak all properties for the 3D scene. The range goes from render settings across object settings up to particle settings. It is the data heart.

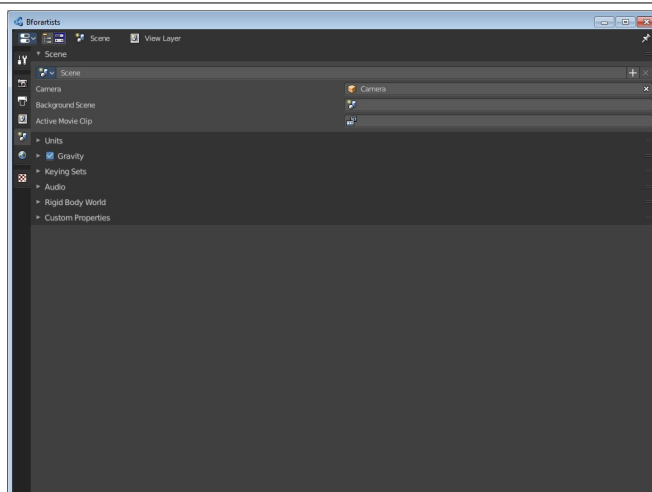

File Browser

The File Browser is the editor in which you can load and save data. Your last blend file for example.

This editor is not part of the standard workspaces. It usually gets called when you load or save a data.

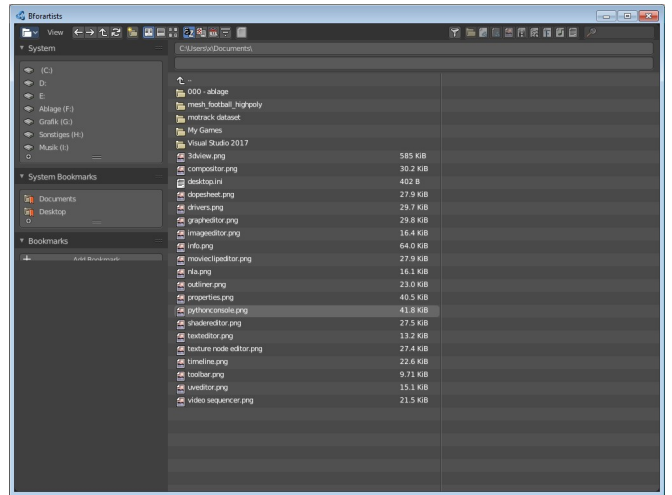

Spreadsheet Editor

The spreadsheet editor provides you with mesh informations.

This information can then for example be used in the geometry nodes editor.

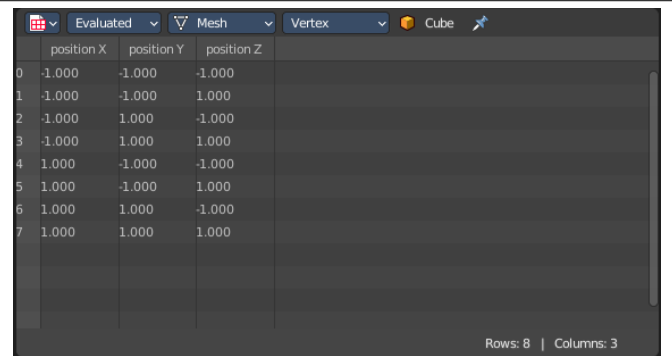

Preferences

The Preferences is the place where you manage all the settings of the software. Theme, Key map, etc.

This editor is not present in the standard workspaces. This editor can be called from the edit menu in the top bar.

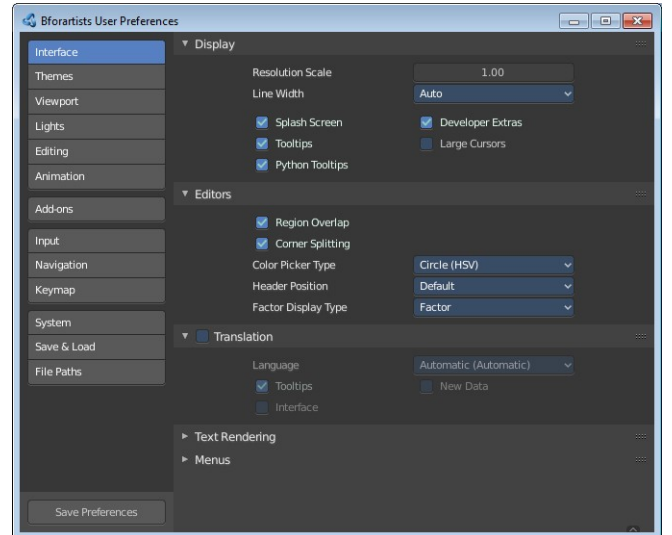



7 Editors - 3D Viewport

Table of content

3D View editor.....	2
Viewport Navigation.....	3
Navigation Elements.....	3
Perspective / Orthographic.....	3
Camera View.....	3
Move.....	3
Zoom.....	3
Mini Axis.....	3
Lock camera to view.....	4
Viewport navigation hotkeys.....	4
Object navigation.....	4
Trackball Navigation.....	4
Context Menus.....	5
Add to selection with Shift.....	5
Constraining the scaling axis (axis locking).....	5
Object Snapping with Increment snap.....	6
Slider snapping.....	6
Fine tuning Transform.....	6
Rotation transformations.....	6
Scale transformations.....	7
Numeric input for Transform.....	7
3D Cursor.....	8
Placement.....	8
Hotkey only functionality.....	8
File Menu - F4.....	8
Set 3D Cursor - Alt Right Mouse.....	8
Frame All - Ctrl Home.....	8
Frame All - Shift C.....	8
Pivot Point Pie menu - ` (german keyboard .).....	8
Call the Snap Pie menu - Shift E.....	9
Interactive Light Track to Cursor - Shift T.....	9
Call pivot pie menu -	9
Call orientation pie menu - ,.....	9
Cycle through select method - Shift Q.....	9
Toggle Viewport Gizmos - Tab.....	9
Loop Select - Alt Left Mouse.....	9
Loop Select - Shift Alt Left Mouse.....	9
Edge Ring Select - Ctrl Alt Left Mouse.....	9
Pick shortest path - Ctrl Left Mouse.....	10
Last Operator Pick shortest path.....	10
Face Stepping.....	10
Topology Distance.....	10
Fill Region.....	10
Deselected.....	10
Skip.....	10
Offset.....	10
Curve Object, Add Vertex - Ctrl Right mouse.....	10

- Armature Object, Extrude Forked - Shift S.....10
- Armature Object, Click Extrude - Ctrl Right mouse.....11
- Armature Object, Set Rotation Mode - Alt R.....11
- Stencil Brush Control Hotkeys.....11
 - Texture set:.....11
 - Mask set:.....11
- Radial Control.....11
- Face sets edit.....12
- Mask Expand.....12
- Edit Voxel Size.....12

3D View editor

The 3D View editor is the editor where you edit your 3D data. Here you can display and modify all the scene data like meshes, curves, metalballs, etc.

It has by default a grid in the middle. And you can navigate around in this view.

The single parts will be explained in own chapters. In this chapter you will find general informations that doesn't fit elsewhere.

The 3D View has several areas.

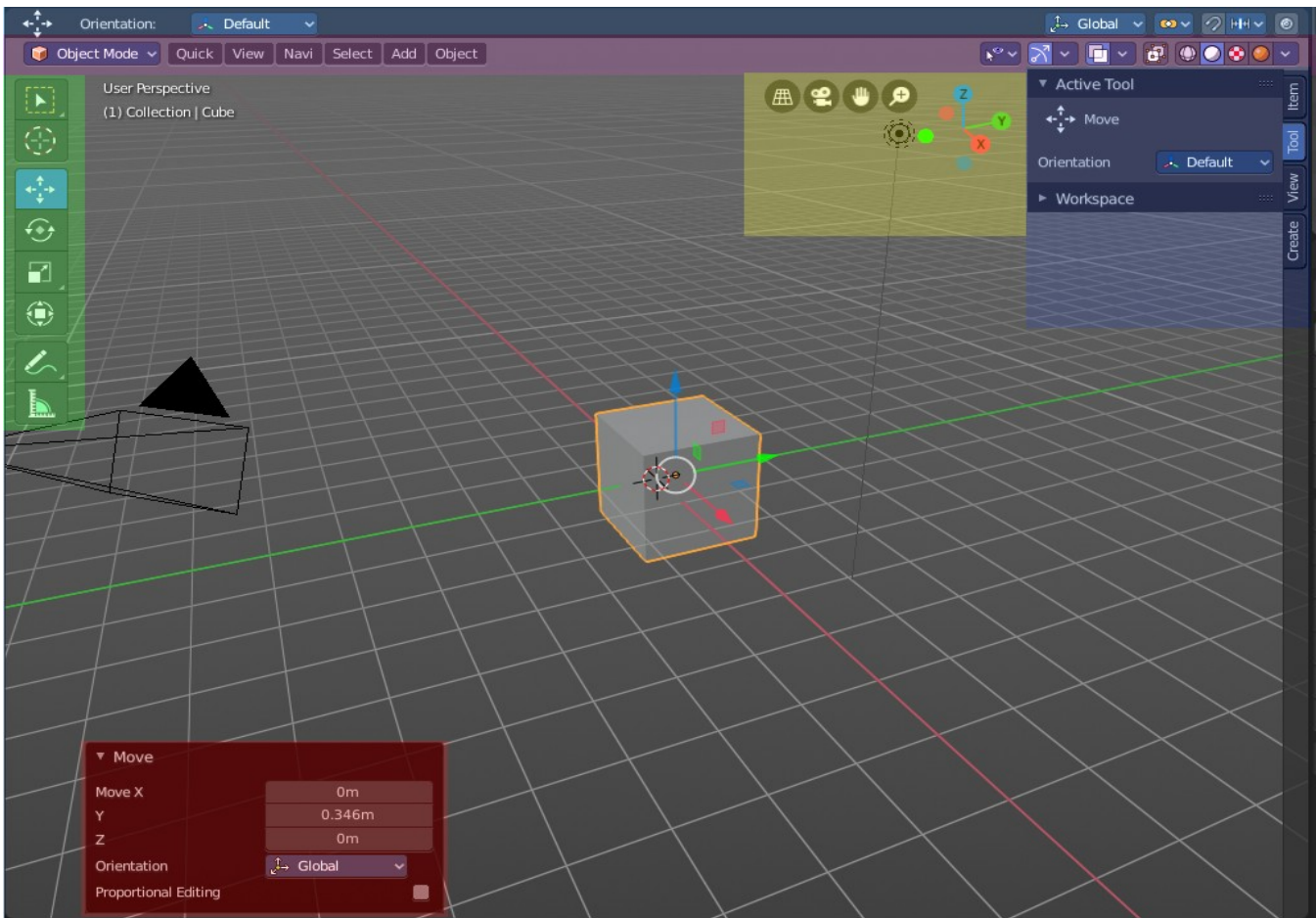

At the top is the Tool Settings. Marked with blue. Here you can find settings for the currently active tool.

Below the tool settings is the Header. Marked with pink. It contains menus, tools and settings.

In the middle is the actual viewport. Here you see and modify for example your mesh data.

At the left you can find the Tool Shelf. Marked with green. It contains all the tools.

The yellow area is the navigate widgets.

At the right of it you can find the Sidebar. Marked with blue again. It contains settings and transform values.

And it is the place where addons adds its panels.

At the bottom left you can find the Adjust Last Operation panel. Marked with red. This panel appears when you do an operation, like move the mesh to another location, and allows you to adjust the values for the operation afterwards.

Viewport Navigation

Navigation in the viewport happens mainly by mouse or hotkeys. Some of them does not have a menu entry. And needs to be explained here.

For the rest of the available navigation functionality have a look into the Navi menu in the header.

Navigation Elements

From left to right.



Perspective / Orthographic

Switch the view between perspective and orthographic view.

Camera View

Enter and leave the camera view. You need to have an active camera in the scene.

Move

Moves the view.

Zoom

Zooms in and out.

Mini Axis

A mini axis. It allows rotation of the view and snap to the nearest ortho view when it is in interactive navigation mode. See Viewport gizmos for more options. There you can turn it to a simple widget, or turn it even completely off.



Lock camera to view

Available when you are in camera view. Either navigate the passepartout around the camera, or navigate in the camera view.

Viewport navigation hotkeys

Right mouse button rotates the view.

Middle mouse button pans the view.

Holding ctrl + middle mouse button zooms the view.

Scroll Wheel zooms the view.

Holding down ALT and middle mouse button snaps the view to the next available orthographic view. Front, Left, etc. . When you continue dragging then you continue to the next orthographic view.

Numpad * resets the 3D view.

Left clicking into an empty space deselects what is currently selected. Exception: when you are in one of the navigation modes and drag the mouse, then the navigation takes over.

Object navigation

Hotkey W moves the selected object/s

Hotkey E rotates the selected object/s

Hotkey R scales the selected object/s

Trackball Navigation

Pressing the hotkey for object rotation once (by default the E key in the Bforartists key map) will rotate the object around the screen axis. Pressing the hotkey for rotation twice will activate trackball rotation. Now you can rotate the object freely around all three axis.

Context Menus

Not every functionality has a menu entry. Some is hotkey only.

One of it is calling the so called context menu. You will find it in several places in the UI. Normally it's a simple right click. But in the 3D view right click is occupied by the navigation in Bforartists. So in the 3D viewport we use double right click to reveal it.

The content of this menu is to 100% double content to already existing menus. And it is despite the name not contextual. The different menu types comes from the object modes, not from a context.

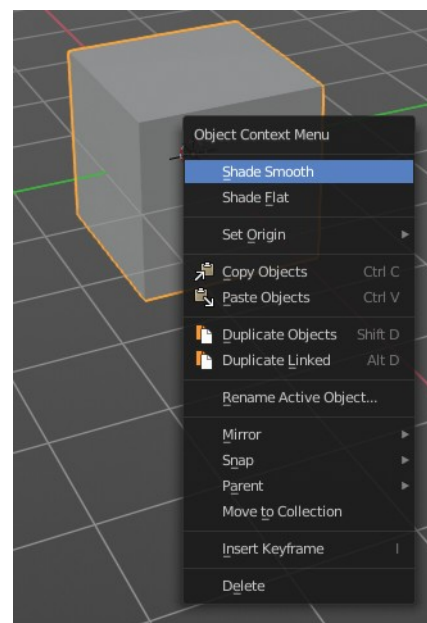

Add to selection with Shift

When you want to parent two objects together, then you need to select them. You can do this with border select for example. Or you select the first object, hold down shift, then the second object. The first object selected will be the child object then when you parent them together.

Constraining the scaling axis (axis locking)

Scaling can be constrained to a particular axis or axes through the use of *Axis Locking*. To constrain scaling, the following shortcuts can be used:

- **Scale Hotkey, X:** Scale only along the **X Axis**
- **Scale Hotkey, Y:** Scale only along the **Y Axis**
- **Scale Hotkey, Z:** Scale only along the **Z Axis**

Axis locking can also be enabled by pressing the MMB after enabling scaling and moving the mouse in the desired direction e.g.

- **Scale Hotkey,** move the mouse along the X axis, **MMB:** Scale only along the **X Axis**

Object Snapping with Increment snap

Holding **Ctrl** during a transform operation (such as grab, rotate or scale) will temporarily activate Transform Snapping. When the Snap Element is set to *Increment*, this allows the transformation to be performed in fixed steps.

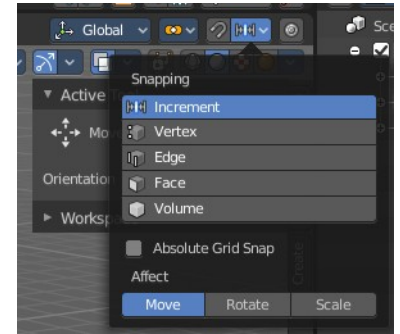

Slider snapping

Snapping also works at sliders for example. Hover with the mouse over the slider, start to slide, and holding down **Ctrl** will snap the sliders in incremental steps.



When it's a default value between 0 and 1 then it usually snaps in 0.1 steps. When it's a default value over 1 then it usually snaps in steps of 10.

Note that this also works at brushes hotkeys for example. Hotkey F usually allows to change the radius. When you hold down ctrl too then it increases or decreases the size by incremental steps.

Fine tuning Transform

Holding **Shift** during a transform operation will transform the object at 1/10th the speed, allowing much finer control over the snapping.

The magnitude of the transformation can be viewed in the 3D window header in the bottom left hand corner. Releasing **Ctrl** or **Shift** during the transformation will cause the movement to revert back to its normal mode of operation.

This fine tune transform operation works with both, the transform hotkeys and the 3D widget.

Tip

Combining with other controls

All of the precision controls detailed on the page can be combined with the *Axis Locking* controls and used with the different *Pivot Points*.

Rotation transformations

Holding **Ctrl** will cause rotations of 5 degrees.

Holding **Ctrl-Shift** will cause rotations of 1 degree.

Scale transformations

Holding **Ctrl** will cause size changes in increments of 0.1 BU.

Hold **Shift** down while scaling to scale the selected element in very fine increments.

Hold **Shift-Ctrl** down while scaling to scale the selected element in 0.01 BU increments.

Tip

Orientation dependent scaling

By default, all scaling happens around a Global Orientation. You can change the scaling orientation by pressing the axis key twice. For example, pressing **S, X, X** will by default set scaling to occur around the local orientation in **X** direction.

Note

Snapping modes

Note that if you have a Snap Element option enabled, holding **Ctrl** will cause the selection to snap to the nearest element.

Numeric input for Transform

Using the mouse for transformations is convenient. But if you require more precise control, then you can also enter numeric values. After pressing one of the navigation hotkeys, type a number to indicate the magnitude of the transformation.

You can see the numbers you enter in the bottom left hand corner of the 3D window header. Negative numbers and decimals can be entered by pressing the minus (**Minus**) and period (**.**) keys respectively.

The process is the same for translation, rotation and scale. Press the corresponding navigation hotkey, the header will show the values, then type in the values that you need. And finally left click or press enter to confirm. A right click abandons the operation.

For translation you have to define the axis in which you want to translate. So when you want to translate your object in **X** axis to 10, then press the translation hotkey, then type in **X 10**. And the object will arrive at **X** position 10. Keep in mind that pressing the navigation hotkey twice will work in local orientation.

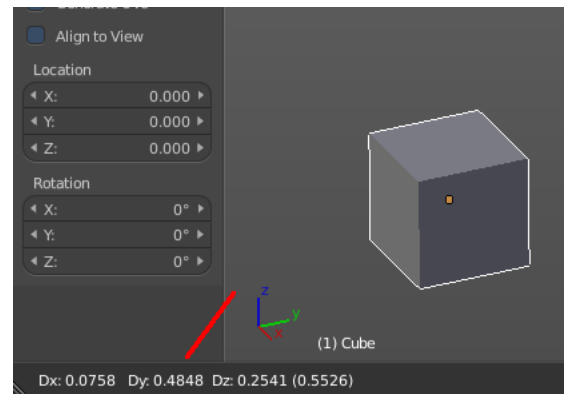

3D Cursor

The 3D Cursor is simply a point in 3D space which can be used for a number of purposes. It is often in the way. You can hide it in the properties sidebar in the 3D Cursor panel at the right.

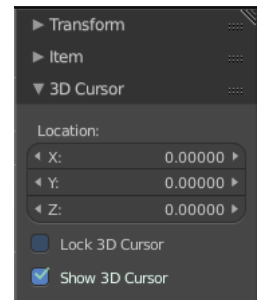

Placement

There are various methods to place this 3D cursor, including some snapping methods.

The free placement method with a hotkey is with Alt + RMB with the default Bforartists key map.

Hotkey only functionality

Important! These hotkeys works with the default Bforartists key map! And they do not list the N dof hotkeys. N dof is a 3d connexion mouse device that is also used for tablets.

Most of the tools can be found in the graphical UI. But there are still some tools that are hotkey only. Some have a UI brother with equal functionality. For example, Pick shortest path is the hotkey sister of Select shortest path. Some are hotkey only since they cannot be integrated in the graphical UI. Like calling the File menu under the mouse. Or mouse position dependent functionality like selecting an edge loop.

The navigation hotkeys and the context menus are excluded here since they are already covered.

File Menu - F4

Calls the file menu under the mouse.

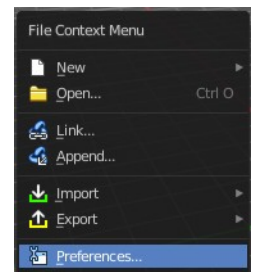

Set 3D Cursor - Alt Right Mouse

Sets the 3D cursor position to Mouse position.

Frame All - Ctrl Home

View all objects in the scene in all regions. This hotkey is for quad view.

Frame All - Shift C

View and center all objects in the scene.

Pivot Point Pie menu - ` (german keyboard .)

Calls a pivot point pie menu. The content is the same than in the pivot menu in the header.

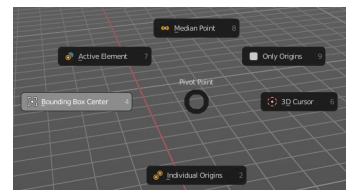

Call the Snap Pie menu - Shift E

Calls the Snap Pie Menu.

Interactive Light Track to Cursor - Shift T

Navigate a lamp of type sun or spot light to point at objects. The lamp follows the mouse cursor.

Call pivot pie menu - .

Call pivot pie menu.

Call orientation pie menu - ,

Call orientation pie menu.

Cycle through select method - Shift Q

Cycle through the select method in the tool shelf.

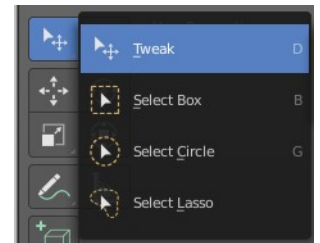

Toggle Viewport Gizmos - Tab

Toggles the display of the viewport gizmos.

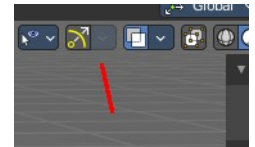

Loop Select - Alt Left Mouse

Selects an edge loop.

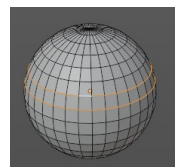

Loop Select - Shift Alt Left Mouse

Selects an edge loop., adds to selection.

Edge Ring Select - Ctrl Alt Left Mouse

Selects a ring loop.

Edge Ring Select - Shift Ctrl Alt Left Mouse

Selects a ring loop, adds to selection.

Pick shortest path - Ctrl Left Mouse

Mesh Object in Edit mode.

Pick the shortest path by selecting the first element, holding down ctrl, then selecting the last element.

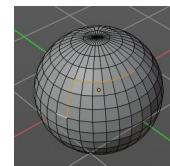

Last Operator Pick shortest path

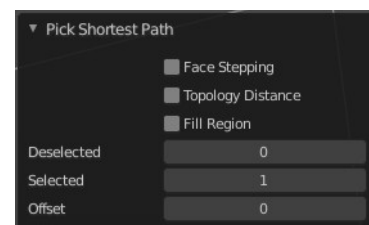

Face Stepping

Traverse connected faces.

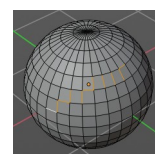

Topology Distance

Find the minimum number of steps instead of the shortest distance.

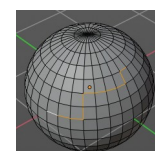

Fill Region

Select the region faces too.

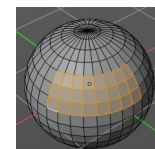

Deselected

Don't select the whole path, but just every nth element of it.

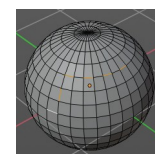

Skip

This is connected to nth element. Number of elements to skip at once.

Offset

This is connected to nth element. Start with an offset.

Curve Object, Add Vertex - Ctrl Right mouse

Edit Mode. Adds a duplicate of the selected curve points under the mouse.

Armature Object, Extrude Forked - Shift S

Edit Mode. Extrudes with option Forked enabled. Bones extrudes from the center of the selected joints.

Armature Object, Click Extrude - Ctrl Right mouse

Edit Mode. Extrudes the bone to mouse position.

Armature Object, Set Rotation Mode - Alt R

Pose Mode. Calls a menu under the mouse to set the rotation mode of the selected bone(s). The same menu is also in the Transform panel in the Item tab.

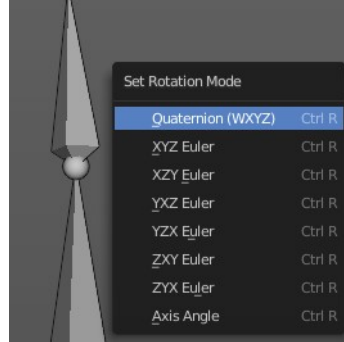

Stencil Brush Control Hotkeys

This is for the paint modes where you have a stencil map available. Vertex Paint and Texture Paint. They move, rotate and scale the stencil image. There are two possible sets. A texture stencil map. And a mask stencil map.

Texture set:

Alt Right Mouse

Shift Right Mouse

Ctrl Right Mouse

Mask set:

Shift Ctrl Alt Right Mouse

Shift Alt Right Mouse

Ctrl Alt Right Mouse

Radial Control

In Paint modes you can set the strength or radius of the brush not only by the sliders. But also by hotkeys.

Sets the brush radius - F

Sets the brush strength - Shift F

Sets the brush direction - Ctrl F

Sets the brush direction - Ctrl Alt F

Face sets edit

Sculpt mode. Calls a pie menu to set the face sets.



Mask Expand

Sculpt mode. Expands a Face mask.

Edit Voxel Size

Sculpt mode. Shows a grid and allows you to adjust the voxel resolution for remeshing. The slider in the remesh panel does not show the grid.

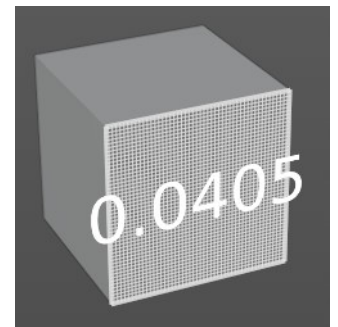
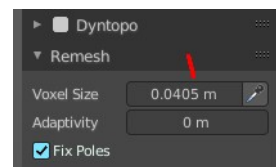

7.0.1 Editors - 3D Viewport - Object mode - Object Context Menu

Table of content

Detailed table of content.....	2
Object Context Menu.....	8
Object Context Menu - All objects.....	8
Copy Objects.....	8
Paste Objects.....	8
Duplicate Objects.....	9
Duplicate Linked.....	9
Rename active Item / Object.....	11
Mirror.....	11
Snap.....	12
Parent.....	13
Move to Collection.....	14
Toggle Local View.....	15
Remove from Local.....	15
Insert Key frame.....	15
Delete.....	15
Show/Hide.....	15
Mesh object.....	16
Shade Smooth.....	16
Shade Auto Smooth.....	16
Shade Flat.....	16
Convert to.....	16
Set Origin.....	17
Curve object.....	18
Shade Smooth.....	18
Shade Auto Smooth.....	18
Shade Flat.....	18
Adjust Extrusion.....	18
Adjust Offset.....	18
Convert to.....	19
Set Origin.....	19
Surface object.....	20
Shade Smooth.....	20
Shade Auto Smooth.....	20
Shade Flat.....	20
Convert to.....	20
Set Origin.....	21
Metaball object.....	22
Convert to.....	22
Set Origin.....	22
Text object.....	23
Adjust Extrusion.....	23
Adjust Offset.....	24
Set Origin.....	24
Volume object.....	25
Grease Pencil object.....	25
Convert to.....	25

Set Origin.....	26
Armature.....	27
Set Origin.....	27
Lattice.....	28
Set Origin.....	28
Empty + Image object.....	29
Adjust Empty Display Size.....	29
Speaker object.....	30
Camera object.....	30
Adjust Focal Length.....	30
Adjust Focus Distance.....	31
Object specific - Light object.....	31
Point light.....	31
Sun light.....	32
Spot light.....	32
Area light.....	33
Light Probe object.....	34
Force Field.....	34
Adjust Empty Display Size.....	35
Collection Instance.....	35
Adjust Empty Display Size.....	35
Set Origin.....	35

Detailed table of content

Detailed table of content

Detailed table of content.....	2
Object Context Menu.....	8
Object Context Menu - All objects.....	8
Copy Objects.....	8
Paste Objects.....	8
Last Operator Paste Selection from Buffer.....	8
Select.....	8
Active Collection.....	8
Duplicate Objects.....	8
Last Operator Duplicate.....	9
Duplicate Objects.....	9
Linked.....	9
Move X , Y , Z.....	9
Orientation.....	9
Proportional editing.....	9
Proportional Falloff.....	9
Proportional Size.....	9
Connected.....	9
Projected(2D).....	9
Duplicate Linked.....	9
Last Operator Duplicate Linked.....	11
Duplicate Objects.....	11
Linked.....	11
Move X , Y , Z.....	11

Orientation.....	11
Proportional editing.....	11
Proportional Falloff.....	11
Proportional Size.....	11
Connected.....	11
Projected(2D).....	11
Rename active Item / Object.....	11
Mirror.....	11
Interactive Mirror.....	11
Usage:.....	12
X Y Z Global.....	12
X Y Z Local.....	12
Last Operator Mirror.....	12
Orientation.....	12
Proportional editing.....	12
Proportional Falloff.....	12
Proportional Size.....	12
Connected.....	12
Projected(2D).....	12
Snap.....	12
Selection to Cursor.....	12
Selection to Cursor(Keep Offset).....	12
Last operator Snap Selection to Cursor.....	13
Offset.....	13
Selection to Active.....	13
Selection to Grid.....	13
Cursor to Selected.....	13
Cursor to World Origin.....	13
Cursor to Active.....	13
Cursor to Grid.....	13
Parent.....	13
Object.....	14
Object (Keep Transform).....	14
Armature Deform.....	14
With empty Groups.....	14
With Envelope Weights.....	14
With automatic Weights.....	14
Bone.....	14
Bone Relative.....	14
Move to Collection.....	14
Last Operator Move to Collection.....	14
Name.....	14
Toggle Local View.....	15
Remove from Local.....	15
Insert Key frame.....	15
Delete.....	15
Show/Hide.....	15
Show Hidden.....	15
Hide Selected.....	15
Last Operator Hide Selected.....	16
Unselected.....	16
Hide Unselected.....	16
Mesh object.....	16

Shade Smooth.....	16
Shade Auto Smooth.....	16
Shade Flat.....	16
Convert to.....	16
Curve.....	16
Mesh.....	16
Grease Pencil.....	17
Point Cloud.....	17
Last Operator Convert to.....	17
Target.....	17
Keep Original.....	17
Set Origin.....	17
Geometry to Origin.....	17
Origin to Geometry.....	17
Origin to 3D cursor.....	17
Origin to Center of Mass(Surface).....	17
Origin to Center of Mass(Volume).....	17
Last Operator Set Origin.....	17
Type.....	17
Center.....	17
Curve object.....	18
Shade Smooth.....	18
Shade Auto Smooth.....	18
Shade Flat.....	18
Adjust Extrusion.....	18
Adjust Offset.....	18
Convert to.....	19
Curve.....	19
Mesh.....	19
Grease Pencil.....	19
Point Cloud.....	19
Last Operator Convert to.....	19
Target.....	19
Keep Original.....	19
Set Origin.....	19
Geometry to Origin.....	19
Origin to Geometry.....	19
Origin to 3D cursor.....	19
Origin to Center of Mass(Surface).....	19
Origin to Center of Mass(Volume).....	19
Last Operator Set Origin.....	19
Type.....	20
Center.....	20
Surface object.....	20
Shade Smooth.....	20
Shade Auto Smooth.....	20
Shade Flat.....	20
Convert to.....	20
Curve.....	20
Mesh.....	20
Grease Pencil.....	20
Point Cloud.....	21
Last Operator Convert to.....	21

Target.....	21
Keep Original.....	21
Set Origin.....	21
Geometry to Origin.....	21
Origin to Geometry.....	21
Origin to 3D cursor.....	21
Origin to Center of Mass(Surface).....	21
Origin to Center of Mass(Volume).....	21
Last Operator Set Origin.....	21
Type.....	21
Center.....	21
Metaball object.....	22
Convert to.....	22
Curve.....	22
Mesh.....	22
Grease Pencil.....	22
Point Cloud.....	22
Last Operator Convert to.....	22
Target.....	22
Keep Original.....	22
Set Origin.....	22
Geometry to Origin.....	22
Origin to Geometry.....	23
Origin to 3D cursor.....	23
Origin to Center of Mass(Surface).....	23
Origin to Center of Mass(Volume).....	23
Last Operator Set Origin.....	23
Type.....	23
Center.....	23
Text object.....	23
Adjust Extrusion.....	23
Adjust Offset.....	24
Set Origin.....	24
Geometry to Origin.....	24
Origin to Geometry.....	24
Origin to 3D cursor.....	24
Origin to Center of Mass(Surface).....	24
Origin to Center of Mass(Volume).....	24
Last Operator Set Origin.....	24
Type.....	24
Center.....	24
Volume object.....	25
Grease Pencil object.....	25
Convert to.....	25
Path.....	25
Bezier Curve.....	25
Polygon Curve.....	26
Last Operator Convert Grease Pencil.....	26
Type.....	26
Bevel Depth.....	26
Bevel Resolution.....	26
Normalize Weight.....	26
Radius Factor.....	26

Link Stroke.....	26
Set Origin.....	26
Geometry to Origin.....	26
Origin to Geometry.....	26
Origin to 3D cursor.....	26
Origin to Center of Mass(Surface).....	26
Origin to Center of Mass(Volume).....	26
Last Operator Set Origin.....	27
Type.....	27
Center.....	27
Armature.....	27
Set Origin.....	27
Geometry to Origin.....	27
Origin to Geometry.....	27
Origin to 3D cursor.....	27
Origin to Center of Mass(Surface).....	28
Origin to Center of Mass(Volume).....	28
Last Operator Set Origin.....	28
Type.....	28
Center.....	28
Lattice.....	28
Set Origin.....	28
Geometry to Origin.....	28
Origin to Geometry.....	28
Origin to 3D cursor.....	28
Origin to Center of Mass(Surface).....	29
Origin to Center of Mass(Volume).....	29
Last Operator Set Origin.....	29
Type.....	29
Center.....	29
Empty + Image object.....	29
Adjust Empty Display Size.....	29
Speaker object.....	30
Camera object.....	30
Adjust Focal Length.....	30
Adjust Focus Distance.....	31
Object specific - Light object.....	31
Point light.....	31
Adjust Light Power.....	31
Adjust Light Radius.....	32
Sun light.....	32
Adjust Light Power.....	32
Adjust Sun Light Angle.....	32
Spot light.....	32
Adjust Light Power.....	33
Adjust Light Radius.....	33
Adjust Spot Light Size.....	33
Adjust Spot Light Blend.....	33
Area light.....	33
Adjust Light Power.....	34
Adjust Area Light Size.....	34
Light Probe object.....	34
Force Field.....	34

Adjust Empty Display Size.....	35
Collection Instance.....	35
Adjust Empty Display Size.....	35
Set Origin.....	35
Geometry to Origin.....	35
Origin to Geometry.....	35
Origin to 3D cursor.....	35
Origin to Center of Mass(Surface).....	35
Origin to Center of Mass(Volume).....	35
Last Operator Set Origin.....	36
Type.....	36
Center.....	36

Object Context Menu

Call this menu with double right click in the 3D viewport. You need to be in Object mode.

The Object Context Menu appears in object mode with all object types. Even without any object in the scene.

The content of this menu differs. With a mesh object you have for example smoothing available too. And with a curve object the convert options.

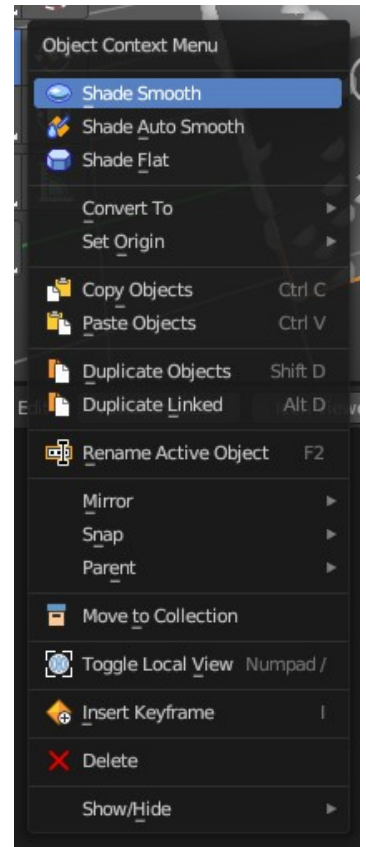

Object Context Menu - All objects

This content shows with all object types.

Copy Objects

Copies the selected object(s).

Paste Objects

Pastes copied object(s).

Last Operator Paste Selection from Buffer

Select

Select pasted object(s).

Active Collection

Put the pasted objects into the active collection.

Duplicate Objects

Duplicates selected objects. The copy is completely independent. All containing data

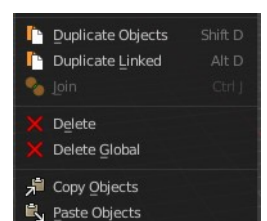
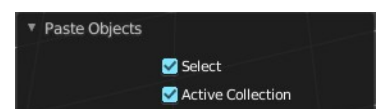
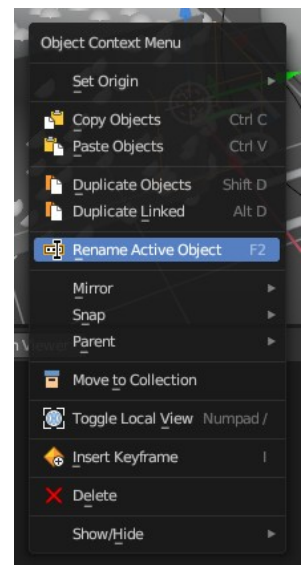

gets duplicated too. And you can edit the object instances completely independent. then.

You are automatically in grab mode, and so you can easily move the object out of position. Which is sometimes wanted, since you can position the duplicate then. But sometimes this is unwanted. A right click after releasing the mouse lets the object snap back into its creation position.

When you drag the duplicate around you will see the position values in the header.



Last Operator Duplicate

Duplicate Objects

Linked

With this option ticked the duplication happens with linked data.

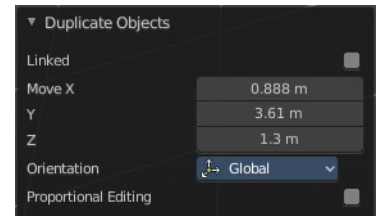

Move X , Y , Z

The Position of the duplicated object.

Orientation

Orientation is a drop-down box choose the type of orientation for the duplicate action.

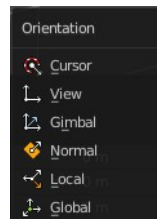

Proportional editing

Enables proportional editing. Activating proportional editing reveals further settings.

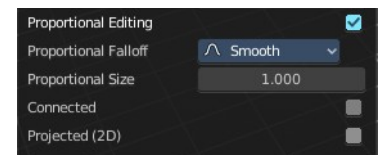

Proportional Falloff

Adjust the falloff methods.

Proportional Size

See and adjust the falloff radius.

Connected

The proportional falloff gets calculated for connected parts only.

Projected(2D)

The proportional falloff gets calculated in the screen space. Depth doesn't play a role. When it's in the radius, then it gets calculated.

Duplicate Linked

Duplicates selected objects. The instance has its own transforms. But the duplicate shares some data with the first instance. This means when you for example edit the mesh of one of the instances,

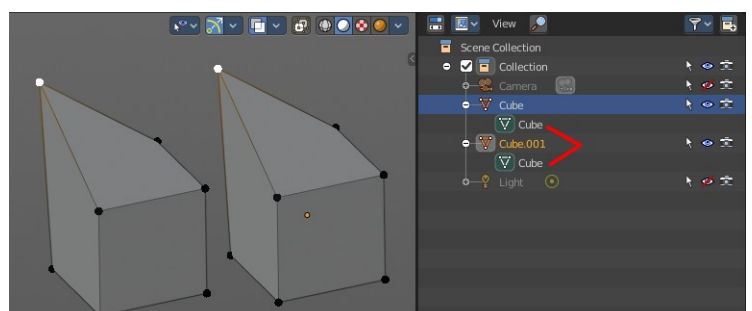

then the other instance gets modified too. As you can see this in the screenshot. Here you can also see that the mesh name is the same. The object name is different though.

If you want to make changes to an object in the new linked duplicate independently of the original object, then you will have to manually make the object a “single-user”. This can be done for example in the Outliner, in the right click menu of the object. (Currently broken). Or in the Object menu. Choose what attached data you want to make single user.

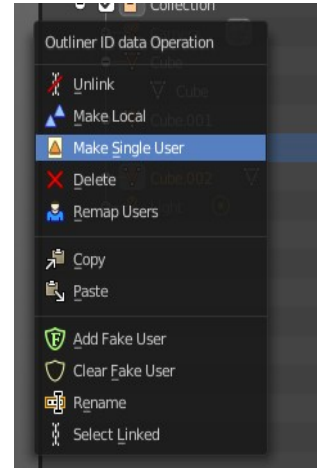
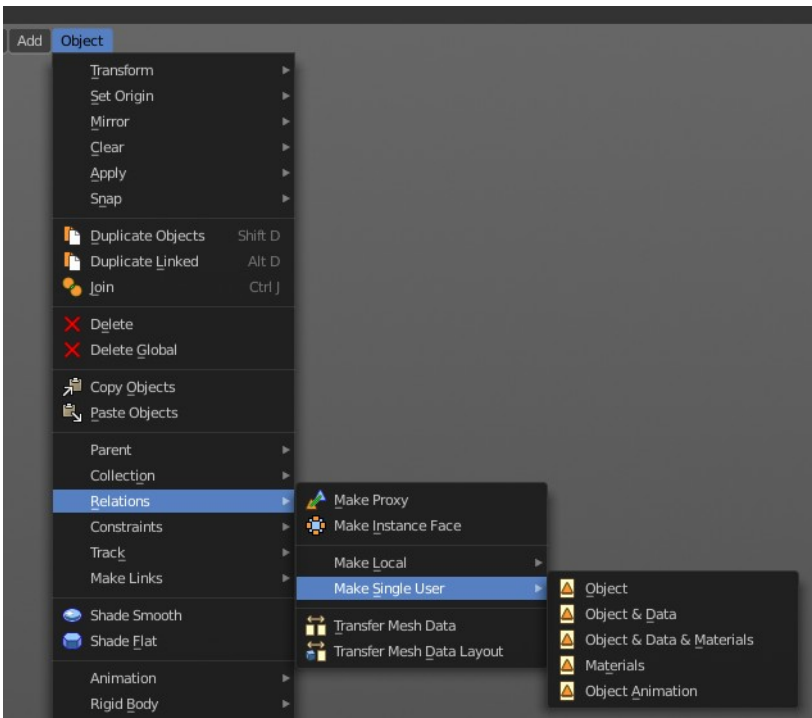

When you duplicate an object, then you are automatically in grab mode. And so you can easily move the object out of position. which is sometimes wanted, since you can position the duplicate then. But sometimes this is unwanted. A right click after releasing the mouse lets the object snap back into its creation position.

Duplicate linked instances the object data.

Explanation: Each Bforartists object type (mesh, lamp, curve, camera *etc.*) is composed from two parts: an *Object* and *Object Data* (sometimes abbreviated to *ObData*):

Object - Holds information about the position, rotation and size of a particular element.

Object Data - Holds everything else. For example. Meshes stores geometry, material lists, vertex groups, etc. . Cameras stores focal length, depth of field, sensor size, etc. .

Each object has a link to its associated object-data, and a single object-data, like a material, may be shared by many objects.

Last Operator Duplicate Linked

Duplicate Objects

Linked

With this option ticked the duplication happens with linked data.

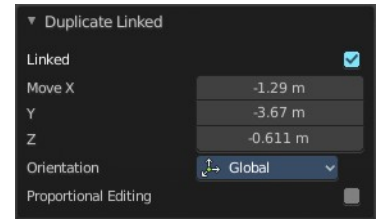

Move X, Y, Z

The Position of the duplicated object.

Orientation

Orientation is a drop-down box choose the type of orientation for the duplicate action.

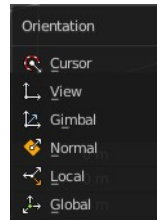

Proportional editing

Enables proportional editing. Activating proportional editing reveals further settings.

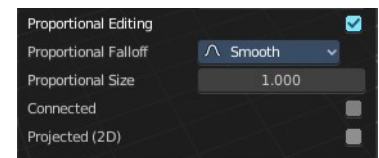

Proportional Falloff

Adjust the falloff methods.

Proportional Size

See and adjust the falloff radius.

Connected

The proportional falloff gets calculated for connected parts only.

Projected(2D)

The proportional falloff gets calculated in the screen space. Depth doesn't play a role. When it's in the radius, then it gets calculated.

Rename active Item / Object

Allows you to rename the currently active item or object. A rename dialog will pop up where you can type in a new name for the current item. You can have more than one item selected. Just the active item gets renamed.

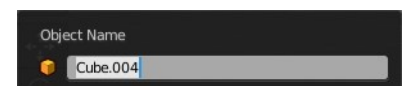

Mirror

Mirrors the selection.

Interactive Mirror

Mirrors the selection.



Usage:

Activate the tool. In the header you will now see further instructions. Which is: type in the axis at which you want to mirror. Interactive mirroring starts in Global space. You can change the orientation in the last operator.



X Y Z Global

Mirrors along the global axis.

X Y Z Local

Mirrors along the object axis.

Last Operator Mirror

Orientation

Choose the orientation in which the transform should happen.

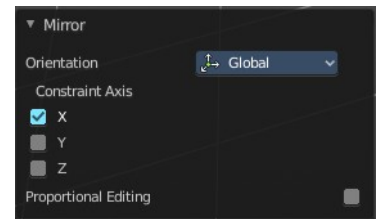
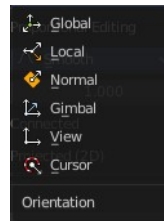

Proportional editing

Enables proportional editing. Activating proportional editing reveals further settings.

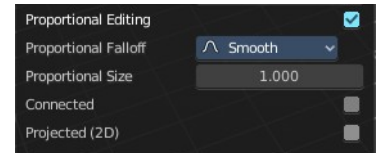

Proportional Falloff

Adjust the falloff methods.

Proportional Size

See and adjust the falloff radius.

Connected

The proportional falloff gets calculated for connected parts only.

Projected(2D)

The proportional falloff gets calculated in the screen space. Depth doesn't play a role. When it's in the radius, then it gets calculated.

Snap

Selection to Cursor

Snaps the currently selected object(s) to the cursor location.

Selection to Cursor(Keep Offset)

Snaps the currently selected object(s) to the cursor location, but keeps the offset of the selected objects to each other. Means the center of the current selection goes to cursor position. Not every individual object.



Last operator Snap Selection to Cursor

Offset

Keep the offset of the selected objects to each other.

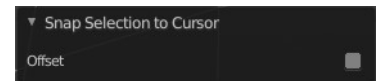

Selection to Active

Snaps the currently selected object(s) to the active object.

Selection to Grid

Snaps the currently selected object(s) to the nearest grid point.

Cursor to Selected

Moves the cursor to the center of the selected object(s).

Cursor to World Origin

Moves the cursor to the world origin.

Cursor to Active

Moves the cursor to the center of the active object.

Cursor to Grid

Moves the cursor to the nearest grid point.

Parent

The parent menu provides you with all parenting methods at object level.

To use parenting you first have to select the source object, hold down shift, then select the target object so that both are selected. This also works in the outliner (here you can also simply hold down shift and drag the source object at the target object to make it a child). The source object becomes the child object then.

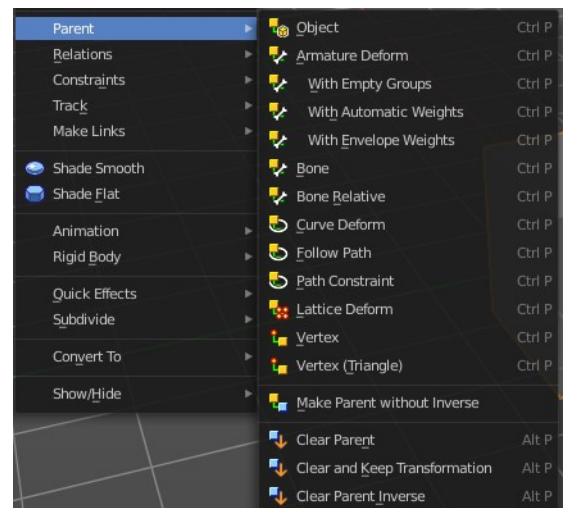

The methods are object type dependent. The armature methods requires to have a mesh and an armature. The path methods a curve. The available methods for the current selection can also be found out by pressing the hotkey ctrl P. This calls the parenting menu with just the available methods.

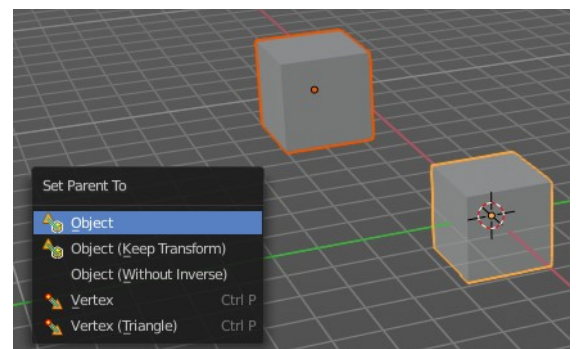

Object

Sets the parent to selected object.

Object (Keep Transform)

Sets the parent to selected object, but applies all transform before the operation.

Armature parenting creates an armature modifier at the mesh.

Armature Deform

Sets the parent to selected Armature.

With empty Groups

Sets the parent to selected Armature, using empty groups.

With Envelope Weights

Sets the parent to selected Armature, using envelope weights

With automatic Weights

Sets the parent to selected Armature, with automatic weights.

Bone

Sets the parent absolute to selected Bone.

Bone Relative

Sets the parent relative to selected Bone.

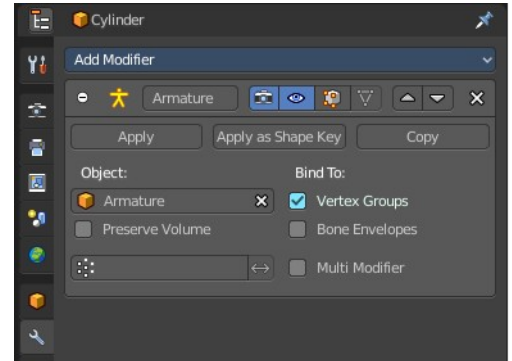

Move to Collection

Moves the selected object to a collection. The object is removed from the collection it was in.

By clicking at this menu item a popup will appear choose the new collection. Allows also to create a new collection. Once done, the object will be moved to this new created collection.

This operator can also be found in the Header Object menu.

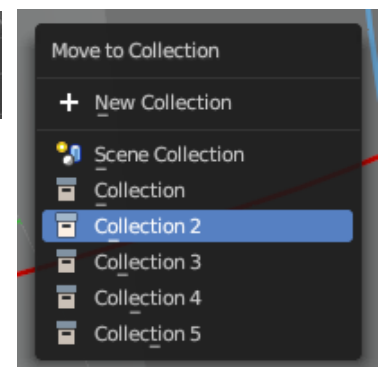
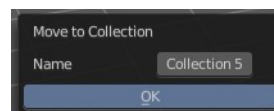

Last Operator Move to Collection

Name

Set a name for your new collection. When you haven't created a new collection, then this name stays blank.

Toggle Local View

Toggles local view isolating the selection in the viewport. You can find this operator in the Header View menu.

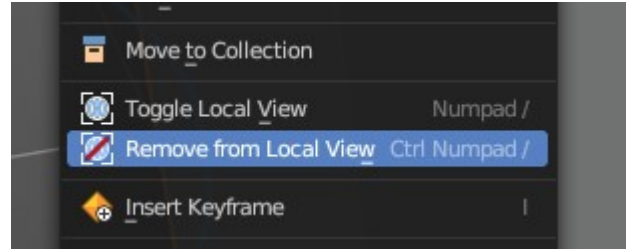

Remove from Local

Removes the selection from the Local View keeping the unselected items in the viewport.

You can find this operator in the Header View menu.

Note: This is a conditional operator that only shows when the context of the 3D View editor is in the Local View mode.

Insert Key frame

Calls the Insert Key frame menu

The keying set defines what kind of key frames gets recorded. When you start with an

animation, and your object does not have a keying set yet, then you will be prompted with a menu choose the proper keying set. The Insert Key frame menu.

Note that this just adds a keying set to the current key frame. And not to the whole object. That's why the keying set menu down right stays empty when you add a key frame. this way.

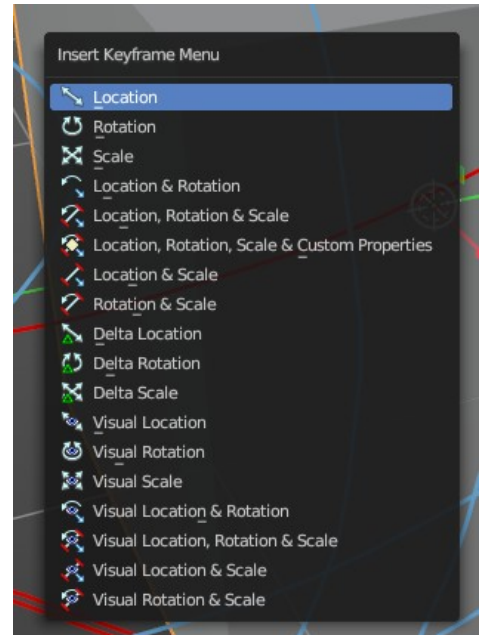

Delete

Deletes the selected object(s).

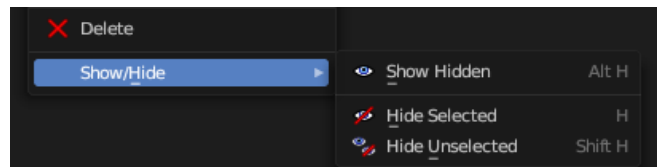

Show/Hide

Sub-menu with shows or hide selection, unselected or hidden operators.

Show Hidden

Makes all geometry in the scene visible again.

Hide Selected

Hides the selected geometry.

Last Operator Hide Selected

Unselected

Hides the not selected geometry.



Hide Unselected

Hides the not selected geometry. The selected geometry stays visible.

Mesh object

Shade Smooth

Sets the shading for the object to smooth. Smooth means that the sharp edges are no longer seen.

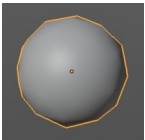

Shade Auto Smooth

Sets the shading for the object to smooth with Autosmooth activated. Autosmooth means that sharp edges above an angle threshold will have sharp faceted faces, meanwhile angles under the threshold will be smooth.

Shade Flat

Sets the shading for the object to flat. Flat means that every face of the object shows faceted, with a sharp edge.

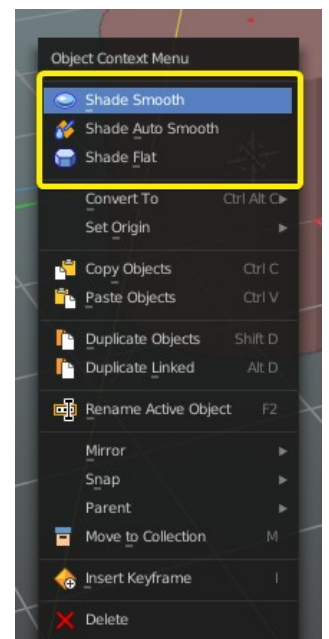
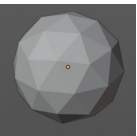

Convert to

Curve

Converts a selected Mesh or Text Object to a Curve Object.

Mesh

Converts a selected object to a Mesh Object.

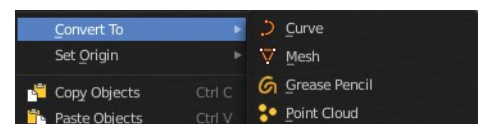

Grease Pencil

Converts a selected curve to a grease pencil stroke.

Point Cloud

Converts a selected object to a point cloud object.

Last Operator Convert to

Target

Target is a drop-down box that allows you to choose the convert method again.

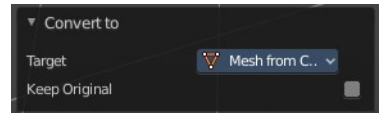

Keep Original

With this option ticked the original object gets kept. And a new object gets created.

Set Origin

Geometry to Origin

Sets the geometry to origin.

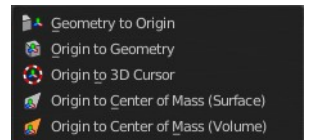

Origin to Geometry

Sets the origin to geometry.

Origin to 3D cursor

Sets the origin to the 3D cursor.

Origin to Center of Mass(Surface)

Sets the origin to the center of mass, calculating it from the center of the surface area.

Origin to Center of Mass(Volume)

Sets the origin to the center of mass, calculating from the center of the Volume. It must be manifold geometry with consistent normal's.

Last Operator Set Origin

The last operator is the same for all set origin methods.



Type

Choose the method again.

Center

Use the median center or the bounds center for calculation.

Curve object

Shade Smooth

Sets the shading for the object to smooth. Smooth means that the sharp edges are no longer seen.

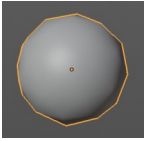

Shade Auto Smooth

Sets the shading for the object to smooth with Autosmooth activated. Autosmooth means that sharp edges above an angle threshold will have sharp faceted faces, meanwhile angles under the threshold will be smooth.

Shade Flat

Sets the shading for the object to flat. Flat means that every face of the object shows faceted, with a sharp edge.

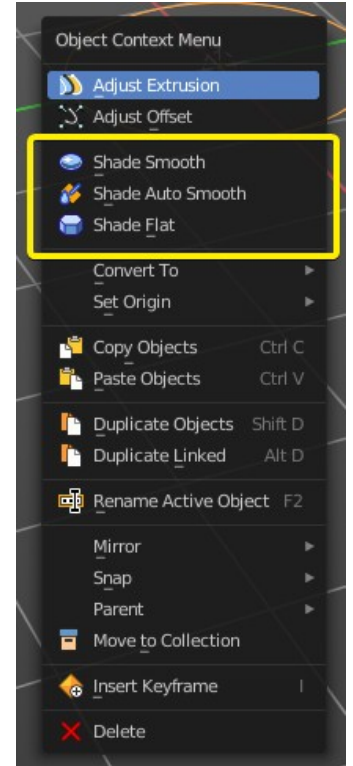
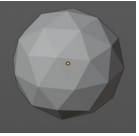

Adjust Extrusion

Extrudes a surface out of a curve or text object.

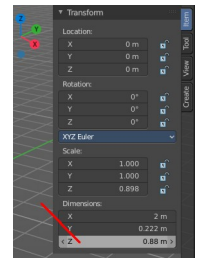
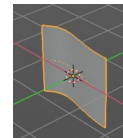
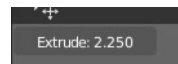

In the header you can see the height of the extrusion. In the Transform panel in the sidebar you can adjust this height also afterwards. The Z value.

Adjust Offset

Adjust Offset is just of interest when you have an extruded surface at the curve. It scales the surface size in x and z direction.

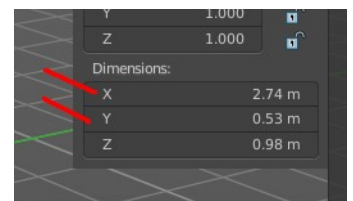
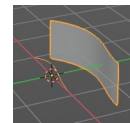

Convert to

Curve

Converts a selected Mesh or Text Object to a Curve Object.

Mesh

Converts a selected object to a Mesh Object.

Grease Pencil

Converts a selected curve to a grease pencil stroke.

Point Cloud

Converts a selected object to a point cloud object.

Last Operator Convert to

Target

Target is a drop-down box that allows you to choose the convert method again.

Keep Original

With this option ticked the original object gets kept. And a new object gets created.

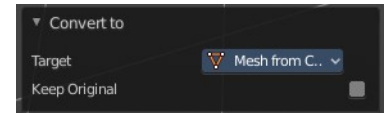
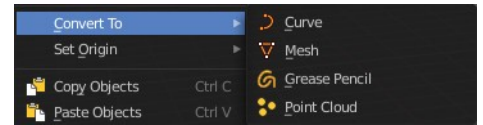

Set Origin

Geometry to Origin

Sets the geometry to origin.

Origin to Geometry

Sets the origin to geometry.

Origin to 3D cursor

Sets the origin to the 3D cursor.

Origin to Center of Mass(Surface)

Sets the origin to the center of mass, calculating it from the center of the surface area.

Origin to Center of Mass(Volume)

Sets the origin to the center of mass, calculating from the center of the Volume. It must be manifold geometry with consistent normal's.

Last Operator Set Origin

The last operator is the same for all set origin methods.

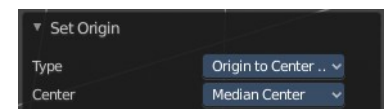
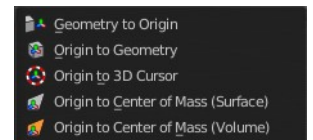

Type

Choose the method again.

Center

Use the median center or the bounds center for calculation.

Surface object

Shade Smooth

Sets the shading for the object to smooth. Smooth means that the sharp edges are no longer seen.

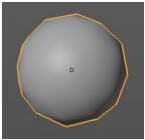

Shade Auto Smooth

Sets the shading for the object to smooth with Autosmooth activated. Autosmooth means that sharp edges above an angle threshold will have sharp faceted faces, meanwhile angles under the threshold will be smooth.

Shade Flat

Sets the shading for the object to flat. Flat means that every face of the object shows faceted, with a sharp edge.

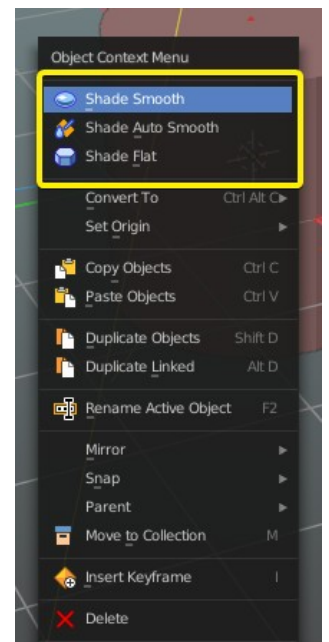
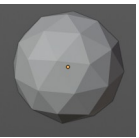

Convert to

Curve

Converts a selected Mesh or Text Object to a Curve Object.

Mesh

Converts a selected object to a Mesh Object.

Grease Pencil

Converts a selected curve to a grease pencil stroke.

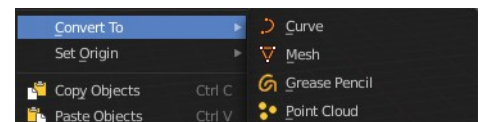

Point Cloud

Converts a selected object to a point cloud object.

Last Operator Convert to

Target

Target is a drop-down box that allows you to choose the convert method again.

Keep Original

With this option ticked the original object gets kept. And a new object gets created.

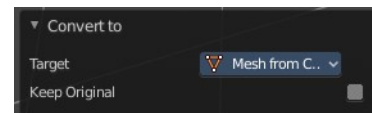

Set Origin

Geometry to Origin

Sets the geometry to origin.

Origin to Geometry

Sets the origin to geometry.

Origin to 3D cursor

Sets the origin to the 3D cursor.

Origin to Center of Mass(Surface)

Sets the origin to the center of mass, calculating it from the center of the surface area.

Origin to Center of Mass(Volume)

Sets the origin to the center of mass, calculating from the center of the Volume. It must be manifold geometry with consistent normal's.

Last Operator Set Origin

The last operator is the same for all set origin methods.

Type

Choose the method again.

Center

Use the median center or the bounds center for calculation.

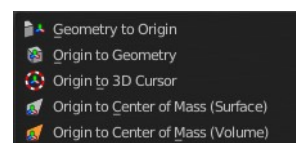

Metaball object

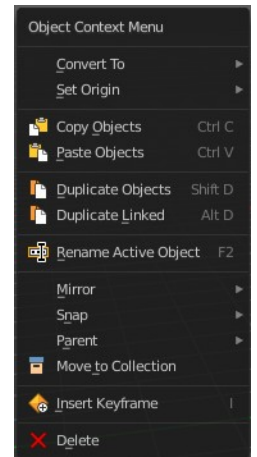

Convert to

Curve

Converts a selected Mesh or Text Object to a Curve Object.

Mesh

Converts a selected object to a Mesh Object.

Grease Pencil

Converts a selected curve to a grease pencil stroke.

Point Cloud

Converts a selected object to a point cloud object.

Last Operator Convert to

Target

Target is a drop-down box that allows you to choose the convert method again.

Keep Original

With this option ticked the original object gets kept. And a new object gets created.

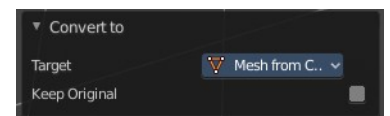
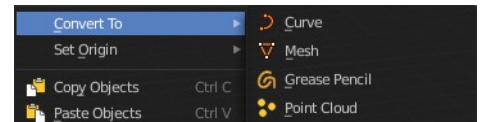

Set Origin

Geometry to Origin

Sets the geometry to origin.

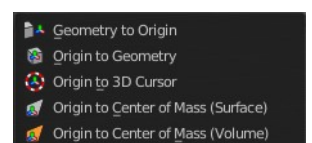

Origin to Geometry

Sets the origin to geometry.

Origin to 3D cursor

Sets the origin to the 3D cursor.

Origin to Center of Mass(Surface)

Sets the origin to the center of mass, calculating it from the center of the surface area.

Origin to Center of Mass(Volume)

Sets the origin to the center of mass, calculating from the center of the Volume. It must be manifold geometry with consistent normal's.

Last Operator Set Origin

The last operator is the same for all set origin methods.

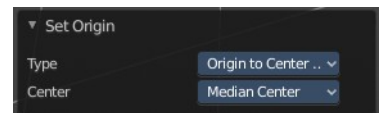

Type

Choose the method again.

Center

Use the median center or the bounds center for calculation.

Text object

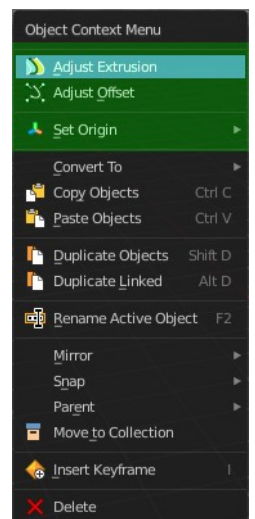

Adjust Extrusion

Extrudes a surface out of a curve or text object.

In the header you can see the height of the extrusion. In the Transform panel in

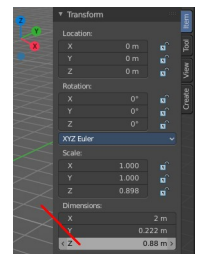
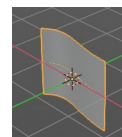
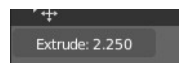

the sidebar you can adjust this height also afterwards. The Z value.

Adjust Offset

Width size is just of interest when you have an extruded surface at the curve. It scales the surface size in x and z direction.

Offset: 4.160

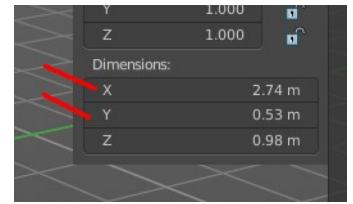
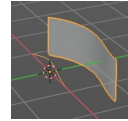

Set Origin

Geometry to Origin

Sets the geometry to origin.

Origin to Geometry

Sets the origin to geometry.

Origin to 3D cursor

Sets the origin to the 3D cursor.

Origin to Center of Mass(Surface)

Sets the origin to the center of mass, calculating it from the center of the surface area.

Origin to Center of Mass(Volume)

Sets the origin to the center of mass, calculating from the center of the Volume. It must be manifold geometry with consistent normal's.

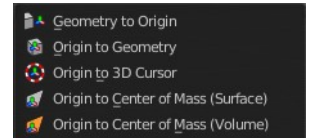

Last Operator Set Origin

The last operator is the same for all set origin methods.

Type

Choose the method again.

Center

Use the median center or the bounds center for calculation.



Volume object

Just default settings.

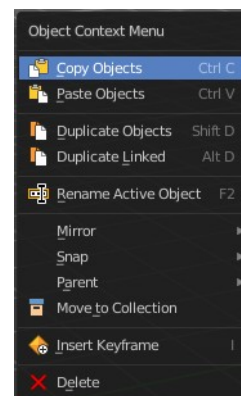

Grease Pencil object

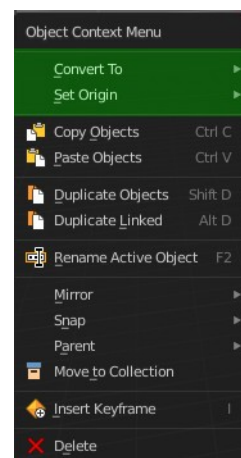

Convert to

Path

Converts a grease pencil stroke to a path.

Bezier Curve

Converts a grease pencil stroke to a bezier curve.

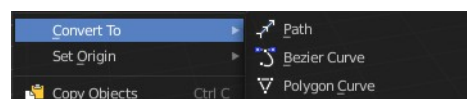

Polygon Curve

Converts a grease pencil stroke to a polygon curve.

Last Operator Convert Grease Pencil

Type

Type is a drop-down box that allows you to choose the convert method again.

Bevel Depth

A curve can have a extruded geometry with bevel. Adjust the bevel depth.

Bevel Resolution

A curve can have a extruded geometry with bevel. Adjust the bevel resolution.

Normalize Weight

Normalize the weight, set from stroke width.

Radius Factor

Multiplier for the points radii, set from stroke width.

Link Stroke

Link strokes with zero radius sections of curves.

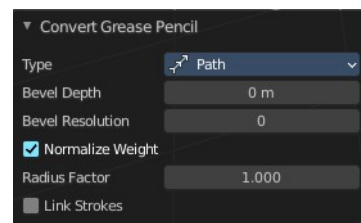

Set Origin

Geometry to Origin

Sets the geometry to origin.

Origin to Geometry

Sets the origin to geometry.

Origin to 3D cursor

Sets the origin to the 3D cursor.

Origin to Center of Mass(Surface)

Sets the origin to the center of mass, calculating it from the center of the surface area.

Origin to Center of Mass(Volume)

Sets the origin to the center of mass, calculating from the center of the Volume. It must be manifold geometry with consistent normal's.

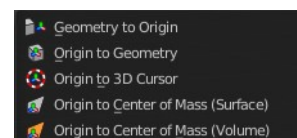

Last Operator Set Origin

The last operator is the same for all set origin methods.

Type

Choose the method again.

Center

Use the median center or the bounds center for calculation.



Armature

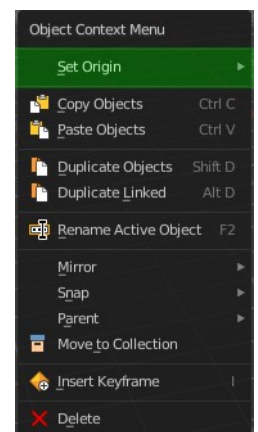

Set Origin

Geometry to Origin

Sets the geometry to origin.

Origin to Geometry

Sets the origin to geometry.

Origin to 3D cursor

Sets the origin to the 3D cursor.

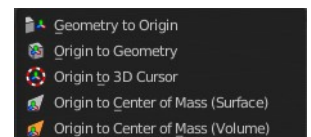

Origin to Center of Mass(Surface)

Sets the origin to the center of mass, calculating it from the center of the surface area.

Origin to Center of Mass(Volume)

Sets the origin to the center of mass, calculating from the center of the Volume. It must be manifold geometry with consistent normal's.

Last Operator Set Origin

The last operator is the same for all set origin methods.

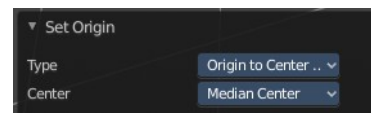

Type

Choose the method again.

Center

Use the median center or the bounds center for calculation.

Lattice

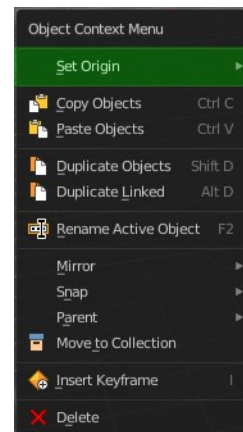

Set Origin

Geometry to Origin

Sets the geometry to origin.

Origin to Geometry

Sets the origin to geometry.

Origin to 3D cursor

Sets the origin to the 3D cursor.

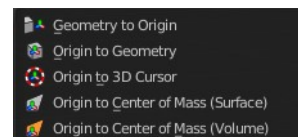

Origin to Center of Mass(Surface)

Sets the origin to the center of mass, calculating it from the center of the surface area.

Origin to Center of Mass(Volume)

Sets the origin to the center of mass, calculating from the center of the Volume. It must be manifold geometry with consistent normal's.

Last Operator Set Origin

The last operator is the same for all set origin methods.

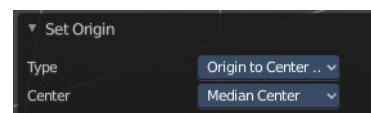

Type

Choose the method again.

Center

Use the median center or the bounds center for calculation.

Empty + Image object

The Image object types is a special kind of an empty. So they have the same entry in the context menu.

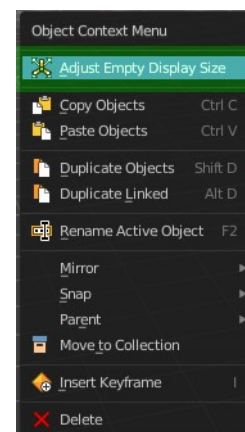

Adjust Empty Display Size

Scale the size of the empty in the viewport.

Note, this value does not show elsewhere. And there is no way to reset it to the default size except to scale it again with Empty Draw Size. The value in the header will help you.

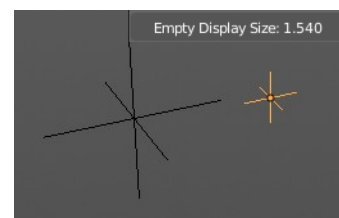

Speaker object

Just default settings.

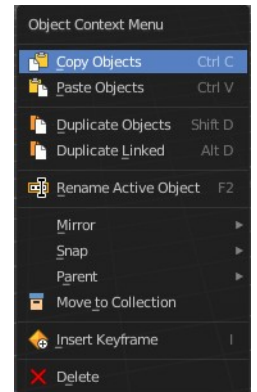

Camera object

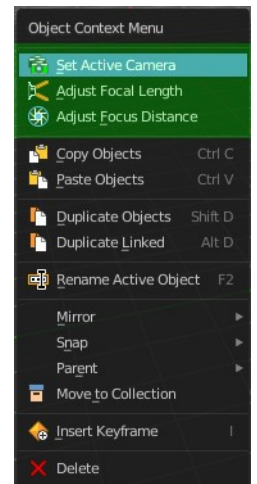

Adjust Focal Length

Changes the focal length of the camera. You can adjust it afterwards in the properties editor.

Camera Lens Scale: 6.690

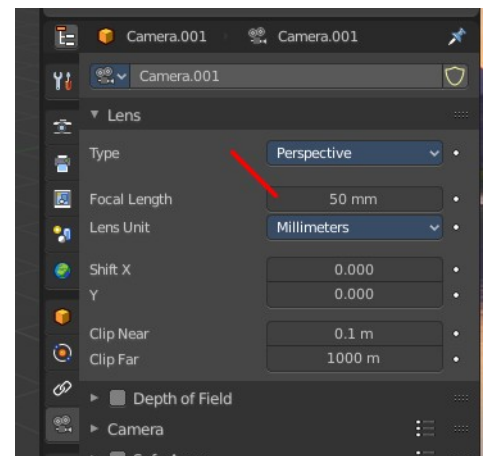
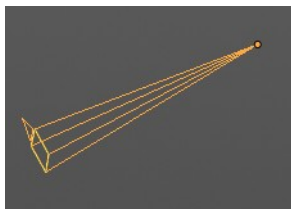

Adjust Focus Distance

Changes the focus distance for depth of field. You can adjust it afterwards in the properties editor. The values in the depth of field are not as exact as the dof distance values though.

Focus Distance: 7.820

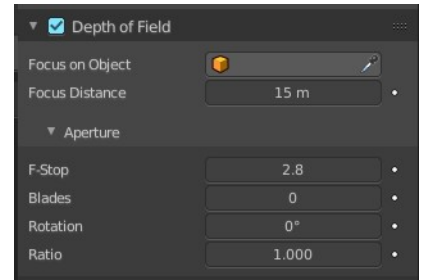

Object specific - Light object

There are four different light types. Each light type has its own settings. Power is the same in all. When you adjust the values then you will see a string with the values in the header.

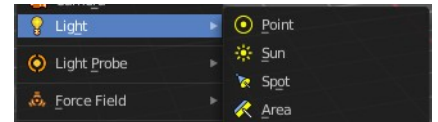

Point light

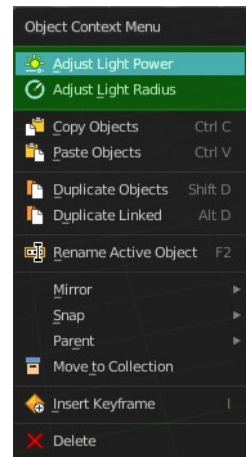

Adjust Light Power

Adjust the power of the light. The light power setting is in the properties editor in the light panel in the object data properties tab.

Light Energy: 11.770

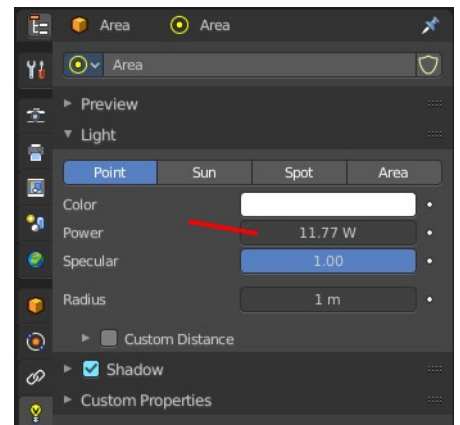

Adjust Light Radius

Adjust the radius of the point light.

Light Radius: 1.620

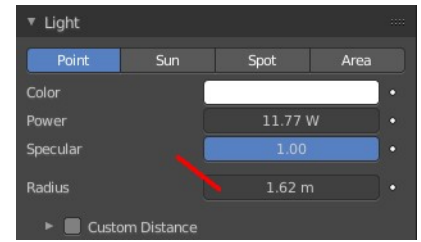

Sun light

Adjust Light Power

Adjust the power of the light. The light power setting is in the properties editor in the light panel in the object data properties tab.

Light Energy: 11.770

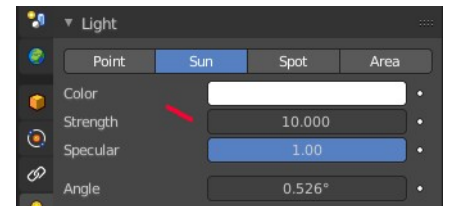

Adjust Sun Light Angle

Adjust the angle of the sun light.

Light Angle: 0.319

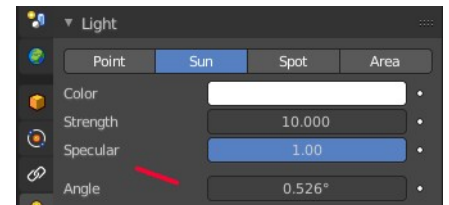

Spot light

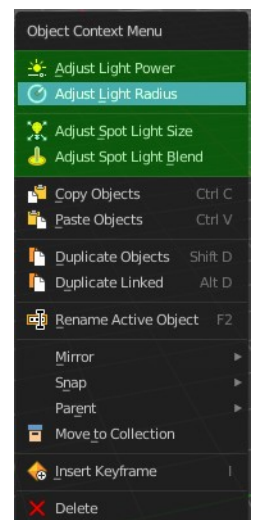
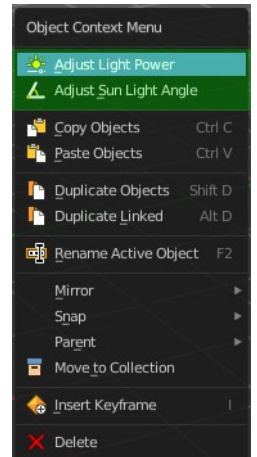

Adjust Light Power

Adjust the power of the light. The light power setting is in the properties editor in the light panel in the object data properties tab.

Light Energy: 11.770

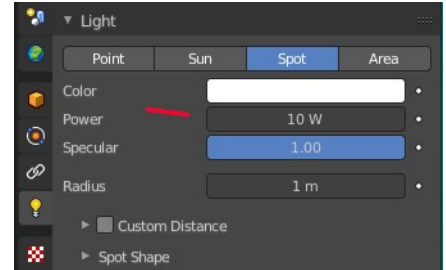

Adjust Light Radius

Adjust the radius of the light.

Light Radius: 1.620

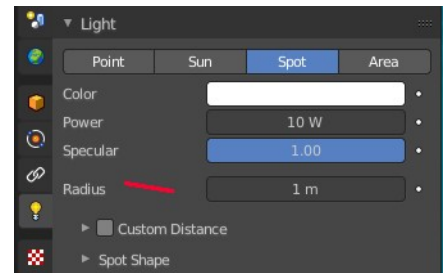

Adjust Spot Light Size

Adjust the angle of the spotlight beam. Note that the value in the header is in radians, while the value in the panel is in degrees.

Spot Size: 1.63

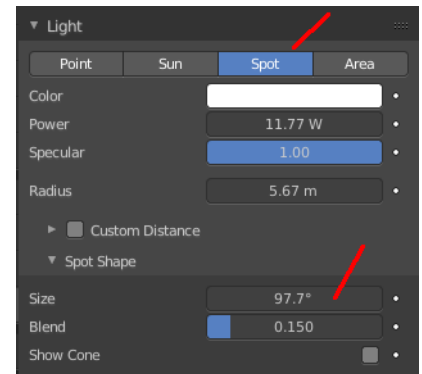

Adjust Spot Light Blend

Adjust softness of the spotlight edge.

Spot Blend: 0.21

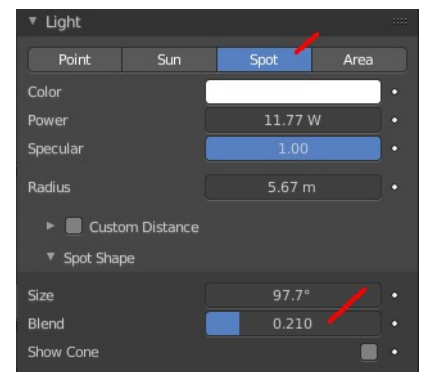

Area light

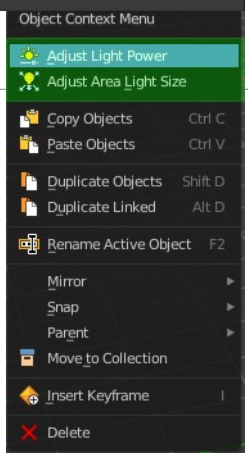

Adjust Light Power

Adjust the power of the light. The light power setting is in the properties editor in the light panel in the object data properties tab.

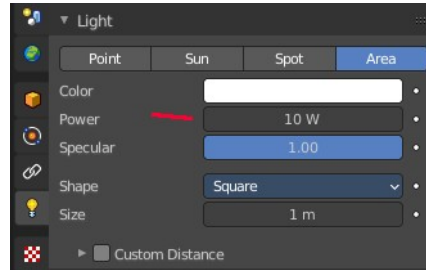

Adjust Area Light Size

Area light only.

Scale the size of the area light. Size Y appears with Shape Rectangle.

Light Size X: 2.760

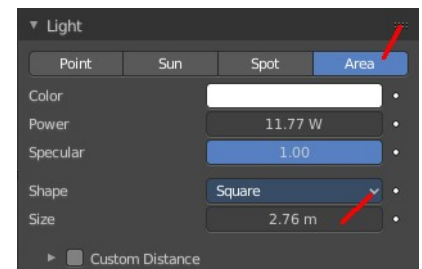

Light Probe object

Just default settings.

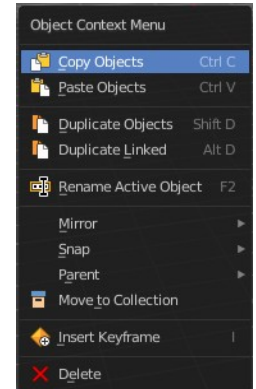

Force Field

The force field is displayed as an empty.

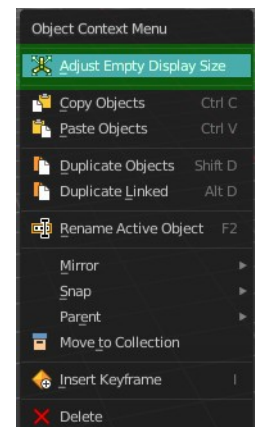

Adjust Empty Display Size

Scale the size of the empty in the viewport.

Note, this value does not show elsewhere. And there is no way to reset it to the default size except to scale it again with Empty Draw Size. The value in the header will help you.

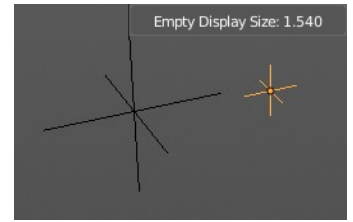

Collection Instance

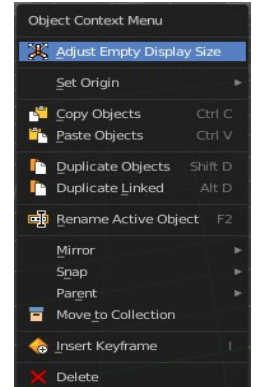

Adjust Empty Display Size

Scale the size of the empty in the viewport.

Note, this value does not show elsewhere. And there is no way to reset it to the default size except to scale it again with Empty Draw Size. The value in the header will help you.

Empty Display Size: 1.540

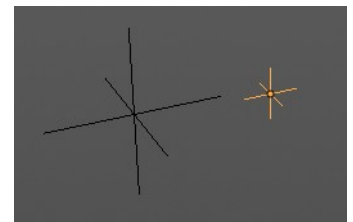

Set Origin

Geometry to Origin

Sets the geometry to origin.

Origin to Geometry

Sets the origin to geometry.

Origin to 3D cursor

Sets the origin to the 3D cursor.

Origin to Center of Mass(Surface)

Sets the origin to the center of mass, calculating it from the center of the surface area.

Origin to Center of Mass(Volume)

Sets the origin to the center of mass, calculating from the center of the Volume. It must be manifold geometry

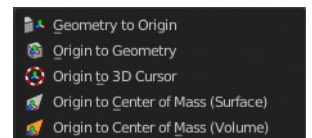

with consistent normal's.

Last Operator Set Origin

The last operator is the same for all set origin methods.

Type

Choose the method again.

Center

Use the median center or the bounds center for calculation.





7.0.10 Editors - 3D Viewport - Metaball - Edit Mode - Metaball context menu

Table of content

Metaball Context Menu.....	2
Duplicate.....	2
Last Operator Duplicate.....	2
Move X , Y , Z.....	2
Orientation.....	2
Proportional editing.....	2
Proportional Falloff.....	2
Proportional Size.....	2
Connected.....	2
Projected(2D).....	2
Mirror.....	3
Interactive Mirror.....	3
X Global, Y Global etc.....	3
Last Operator Mirror.....	3
Orientation.....	3
Constraint Axis.....	3
Proportional editing.....	3
Proportional Falloff.....	3
Proportional Size.....	3
Connected.....	3
Projected(2D).....	3
Snap.....	4
Last Operator Snap.....	4
Offset.....	4
Show/Hide.....	4
Show Hidden.....	4
Hide Selected.....	4
Last Operator Hide Selected.....	4
Unselected.....	4
Hide Unselected.....	4
Delete.....	4

Metaball Context Menu

Call this menu with double right click in the 3D viewport. You need to be in Edit mode with a Metaball object.

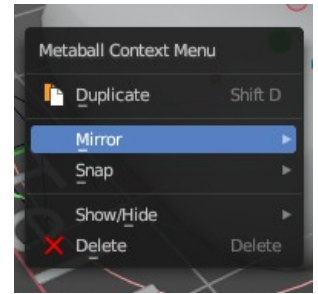

Duplicate

Duplicates the current selection.

The copy sticks to the mouse until you release it. A Right click while moving will reset the position of the duplicate. The duplicated part will be part of the same object.

When you drag the duplicate around you will see the position values in the header.

Last Operator Duplicate

Move X , Y , Z

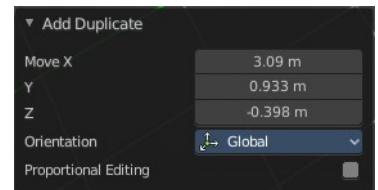

Orientation

Choose the orientation.

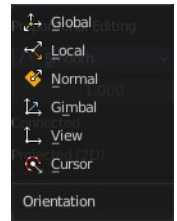

Proportional editing

Enables proportional editing. Activating proportional editing reveals further settings.

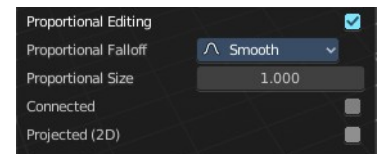

Proportional Falloff

Adjust the falloff methods.

Proportional Size

See and adjust the falloff radius.

Connected

The proportional falloff gets calculated for connected parts only.

Projected(2D)

The proportional falloff gets calculated in the screen space. Depth doesn't play a role. When it's in the radius, then it gets calculated.

Mirror

Mirror mirrors the selected geometry along the defined axis.



Interactive Mirror

Mirror by hotkeys. You activate the tool, type in x for x global for example, or x x for x local. And the selection gets mirrored.

X Global, Y Global etc.

Mirrors the selection around the chosen axis.

Last Operator Mirror

The Last Operator Mirror panel gives you tools to adjust the mirror action.

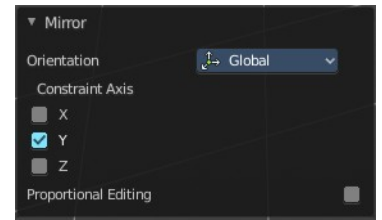

Orientation

Orientation is a drop-down box choose the type of orientation for the mirroring action.

Constraint Axis

Constraint Axis gives you again the possibility to define the mirror axis. You can choose more than one axis here.

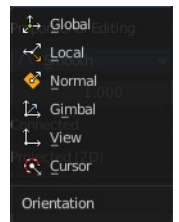

Proportional editing

Enables proportional editing. Activating proportional editing reveals further settings.

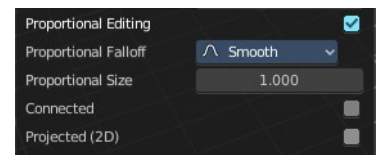

Proportional Falloff

Adjust the falloff methods.

Proportional Size

See and adjust the falloff radius.

Connected

The proportional falloff gets calculated for connected parts only.

Projected(2D)

The proportional falloff gets calculated in the screen space. Depth doesn't play a role. When it's in the radius, then it gets calculated.

Snap

Choose several methods to snap one element to another. The menu items should be self explaining.



Last Operator Snap

Some snap operations shows a last operation panel, some not.

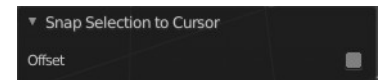

Offset

If the selection should snap as a whole, or if each individual element of the selection should snap.

Show/Hide

Sub-menu with shows or hide selection, unselected or hidden operators.

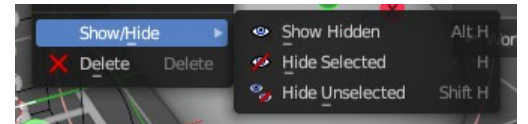

Show Hidden

Makes all geometry in the scene visible again.

Hide Selected

Hides the selected geometry.

Last Operator Hide Selected

Unselected

Hides the not selected geometry.



Hide Unselected

Hides the not selected geometry. The selected geometry stays visible.

Delete

Deletes the current selection.



7.0.11 Editors - 3D Viewport - Text - Edit Mode - Text context menu

Table of content

Edit Mode - Text Context Menu.....	2
Cut.....	2
Copy.....	2
Paste.....	2
Select All.....	2
Text.....	2
Cut.....	2
Copy.....	2
Paste.....	2
Paste File.....	2
To Uppercase.....	2
To Lowercase.....	2
Last Operator Set Case.....	2
Special Characters.....	3
Move Cursor.....	3
Toggle Bold.....	3
Toggle Italic.....	3
Toggle Underline.....	3
Toggle Small Caps.....	3
Kerning.....	3
Decrease Kerning.....	3
Increase Kerning.....	3
Reset Kerning.....	4
Last Operator Change Spacing.....	4
Delta.....	4
Delete.....	4

Edit Mode - Text Context Menu

Call this menu with double right click in the 3D viewport. You need to be in Edit mode with a Text object.

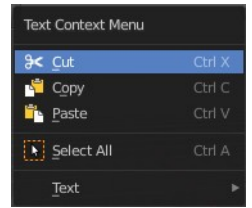

Cut

Cuts the selection.

Copy

Copies the selection.

Paste

Pastes a copied selection.

Select All

Selects the whole text.

Text

Cut

Cuts the selection.

Copy

Copies the selection.

Paste

Pastes a copied selection.

Paste File

Opens the file browser where you can choose a text file to paste the text from. It needs to be UTF8.

To Uppercase

Sets the selected text to be uppercase letters.

To Lowercase

Sets the selected text to be uppercase letters.

Last Operator Set Case

Set Case has one Last Operator for all items.

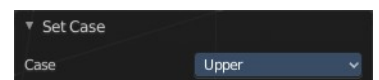
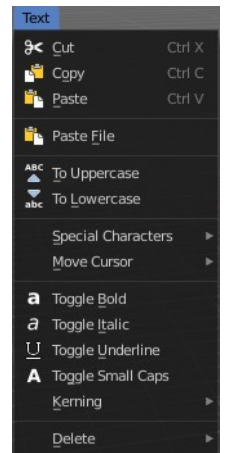

Special Characters

Special characters is a sub menu that contains some special text characters, like copyright, which you can insert into the text.



Move Cursor

Set the cursor at specific positions in the text.

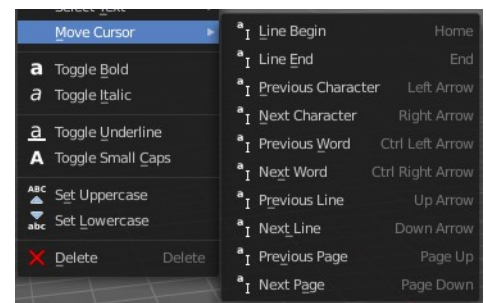

Toggle Bold

Bold sets the selected letters to be displayed as bold letters.

Toggle Italic

Italic sets the selected letters to be displayed as italic letters.

Toggle Underline

Underline sets the selected letters to be displayed as underlined letters.

Toggle Small Caps

Toggle small caps sets the selected letters to be displayed as if they were upper case letters, but with lower case size.

Kerning

Kerning is the distance between letters. Increase, decrease and reset the kerning.

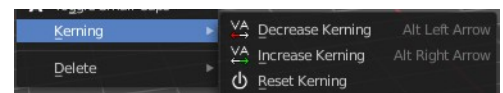

Decrease Kerning

Decreases the distance between the letters.

Increase Kerning

Increases the distance between the letters.

Reset Kerning

Resets the distance between the letters to the default values from the font.

Last Operator Change Spacing

Delta

Adjust the spacing. The range goes from -20 to 20.

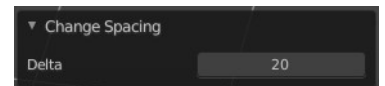

Delete

Deletes the selected text.

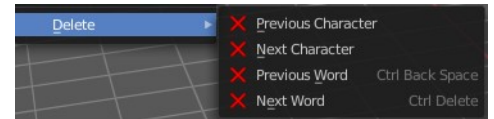

7.0.12 Editors - 3D Viewport - Grease Pencil object - Edit Mode - Point context menu

Table of content

Edit Mode - Point Context Menu.....	3
Subdivide.....	3
Last Operator Subdivide.....	3
Number of Cuts.....	3
Smooth.....	3
Repeat.....	3
Selected Points.....	3
Position.....	4
Thickness.....	4
Strength.....	4
UV.....	4
Extrude.....	4
Smooth.....	4
Last Operator Smooth Stroke.....	4
Repeat.....	4
Factor.....	4
Selected points.....	4
Position.....	4
Thickness.....	4
Strength.....	4
UV's.....	4
Bend.....	5
Shear.....	5
Last Operator Shear.....	5
Offset.....	5
Shear Axis.....	5
Axis.....	5
Axis Ortho.....	5
Orientation.....	5
Proportional editing.....	5
Proportional Falloff.....	5
Proportional Size.....	5
Connected.....	6
Projected(2D).....	6
To Sphere.....	6
Usage.....	6
Last Operator To Sphere Panel.....	6
Factor.....	6
Proportional editing.....	6
Proportional Falloff.....	6
Proportional Size.....	6
Connected.....	6
Projected(2D).....	6
Shrink/Fatten.....	7
Last Operator Shrink/Fatten.....	7

Offset.....	7
Offset Even.....	7
Proportional editing.....	7
Proportional Falloff.....	7
Proportional Size.....	7
Connected.....	7
Projected(2D).....	7
Mirror submenu.....	7
Interactive Mirror.....	7
X Global, Y Global etc.....	8
Last Operator Mirror.....	8
Orientation.....	8
Constraint Axis.....	8
Proportional editing.....	8
Proportional Falloff.....	8
Proportional Size.....	8
Connected.....	8
Projected(2D).....	8
Snap submenu.....	8
Last Operator Snap.....	8
Offset.....	9
Duplicate.....	9
Last Operator Duplicate.....	9
Mode.....	9
Move X, Y, Z.....	9
Orientation.....	9
Constraint Axis.....	9
Proportional editing.....	9
Proportional Falloff.....	9
Proportional Size.....	9
Connected.....	9
Projected(2D).....	9
Copy.....	10
Paste.....	10
Paste by Layer.....	10
Last operator Paste Strokes.....	10
Type.....	10
Merge.....	10
Last Operator Merge Strokes.....	10
Mode.....	10
Draw on back.....	10
Additive drawing.....	10
Cyclic.....	10
Dissolve Points.....	10
Delete Strokes.....	10
Merge by Distance.....	11
Last Operator Clean Loose Points.....	11
Threshold.....	11
Unselected.....	11
Split.....	11
Separate.....	11
Last Operator Separate Strokes.....	11
Mode.....	11

Active Layer.....	11
Selected Strokes.....	11
Selected Points.....	11
Delete Points.....	11
Last Operator Delete.....	11
Type.....	11
Dissolve.....	12
Dissolve.....	12
Dissolve Between.....	12
Dissolve Unselect.....	12
Last Operator Dissolve.....	12
Type.....	12

Edit Mode - Point Context Menu

Call this menu with double right click in the 3D viewport.

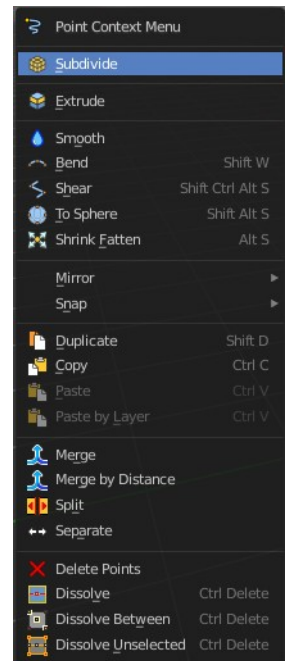

Subdivide

Subdivides the selected grease pencil geometry.

Last Operator Subdivide

Number of Cuts

Number of subdivision cuts.

Smooth

Smoothen the stroke, not just the new added vertices

Repeat

The number of times to repeat the procedure.

Selected Points

Limits the effect to only the selected points within the stroke.

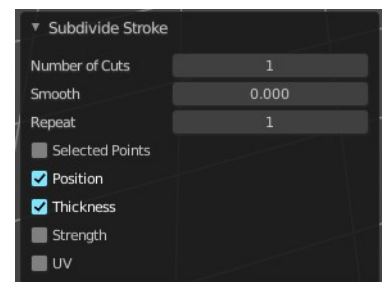

Position

The operator affects the points location.

Thickness

The operator affect the points thickness.

Strength

The operator affect the points strength (alpha).

UV

The operator affect the UV rotation on the points.

Extrude

Extrudes out the selected points. The new points stay connected with the original points of the stroke.

Smooth

Smoothens out the selected geometry.

Last Operator Smooth Stroke

Repeat

How often to repeat the procedure.

Factor

The amount of the smoothness to apply.

Selected points

When enabled, limits the effect to only the selected points within the stroke.

Position

When enabled, the operator affect the points location.

Thickness

When enabled, the operator affect the points thickness.

Strength

When enabled, the operator affect the points strength (alpha).

UV's

When enabled, the operator affect the UV rotation on the points.

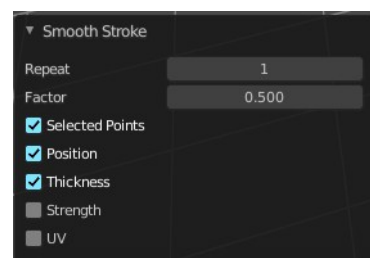

Bend

Bends the selection.

Shear

Shear shears the selection.

Last Operator Shear

Offset

Adjust an offset.

Shear Axis

The shear tool works along a imaginary 2d plane. The shear axis controls if the items are sheared along the x or the y axes of this plane. This is the plane along which the transformation happens. You can shear along the x or the y axis of this plane.

To make things even more complicated, the orientation of this imaginary plane is defined by the Axis and AxisOrtho items below.

Axis

Defines one axis of the imaginary shear axis plane.

Axis Ortho

Defines the other axis of the imaginary shear axis plane.

Orientation

Choose the orientation for the shear action.

Proportional editing

Enables proportional editing. Activating proportional editing reveals further settings.

Proportional Falloff

Adjust the falloff methods.

Proportional Size

See and adjust the falloff radius.

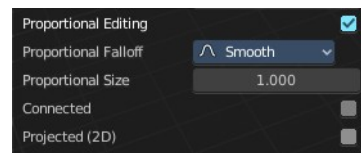
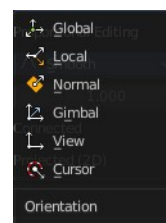
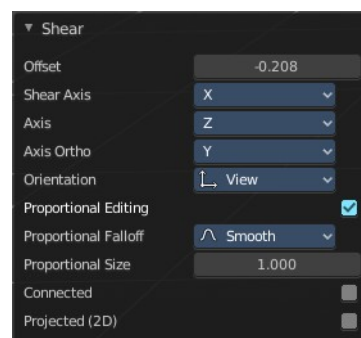

Connected

The proportional falloff gets calculated for connected parts only.

Projected(2D)

The proportional falloff gets calculated in the screen space. Depth doesn't play a role. When it's in the radius, then it gets calculated.

To Sphere

Shapes a selection of objects into the shape of a sphere. The calculation happens with the object origins.

Usage

Select the vertices, activate the tool, then drag the mouse in the 3D viewport. In the header you will read the current factor then. Which tells you how close you are towards the sphere shape.

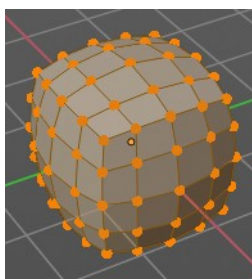

Last Operator To Sphere Panel

Factor

The factor to transform the selection into a shape form.



Proportional editing

Enables proportional editing. Activating proportional editing reveals further settings.

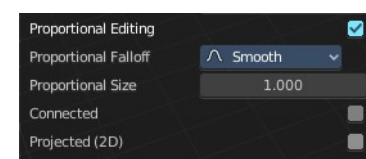

Proportional Falloff

Adjust the falloff methods.

Proportional Size

See and adjust the falloff radius.

Connected

The proportional falloff gets calculated for connected parts only.

Projected(2D)

The proportional falloff gets calculated in the screen space. Depth doesn't play a role. When it's in the radius,

then it gets calculated.

Shrink/Fatten

Shrink/Fatten scales the selected geometry along its normals. Transform orientation and Pivot point gets ignored.

A positive value pushes the vertices outwards. A negative value pushes the vertices inwards.

Last Operator Shrink/Fatten

The Last Operator Shrink/Fatten panel gives you tools to adjust the Shrink/Fatten operation. Here you have numeric input for the strength and a few more options.

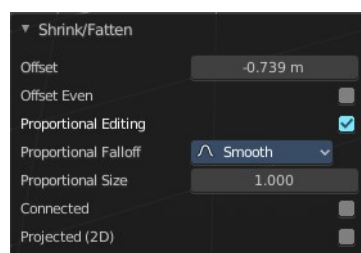

Offset

Offset is the strength of the offset for Shrink/Fatten.

Offset Even

Offset Even scales the selection to give more thickness in even areas.

Proportional editing

Enables proportional editing. Activating proportional editing reveals further settings.

Proportional Falloff

Adjust the falloff methods.

Proportional Size

See and adjust the falloff radius.

Connected

The proportional falloff gets calculated for connected parts only.

Projected(2D)

The proportional falloff gets calculated in the screen space. Depth doesn't play a role. When it's in the radius, then it gets calculated.

Mirror submenu

Mirror mirrors the selected geometry along the defined axis.

Interactive Mirror

Mirror by hotkeys. You activate the tool, type in x for x global for example, or x x for x local. And the selection gets mirrored.



X Global, Y Global etc.

Mirrors the selection around the chosen axis.

Last Operator Mirror

The Last Operator Mirror panel gives you tools to adjust the mirror action.

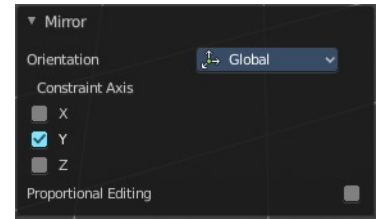

Orientation

Orientation is a drop-down box. Choose the type of orientation for the mirroring action.

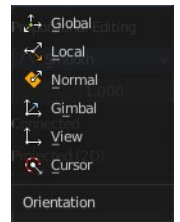

Constraint Axis

Constraint Axis gives you again the possibility to define the mirror axis. You can choose more than one axis here.

Proportional editing

Enables proportional editing. Activating proportional editing reveals further settings.

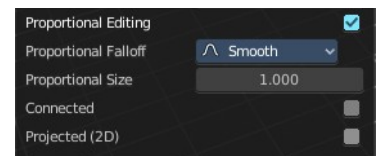

Proportional Falloff

Adjust the falloff methods.

Proportional Size

See and adjust the falloff radius.

Connected

The proportional falloff gets calculated for connected parts only.

Projected(2D)

The proportional falloff gets calculated in the screen space. Depth doesn't play a role. When it's in the radius, then it gets calculated.

Snap submenu

Choose several methods to snap one element to another. The menu items should be self explaining.

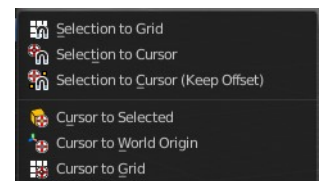

Last Operator Snap

Some snap operations shows a last operation panel, some not.

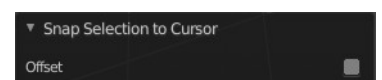

Offset

If the selection should snap as a whole, or if each individual element of the selection should snap.

Duplicate

Duplicates the current selection.

When you duplicate a selection, then it sticks to the mouse until you left click. And moves around. A right click repositions the duplicated geometry at its original location.

Last Operator Duplicate

Mode

Not to find out. No tool tip, no entry in the Blender manual. Good Job Blender Developers.

Move X, Y, Z

Adjust the position.

Orientation

Orientation is a drop-down box. Choose the type of orientation for the mirroring action.

Constraint Axis

Constraint Axis gives you again the possibility to define the mirror axis. You can choose more than one axis here.

Proportional editing

Enables proportional editing. Activating proportional editing reveals further settings.

Proportional Falloff

Adjust the falloff methods.

Proportional Size

See and adjust the falloff radius.

Connected

The proportional falloff gets calculated for connected parts only.

Projected(2D)

The proportional falloff gets calculated in the screen space. Depth doesn't play a role. When it's in the radius, then it gets calculated.

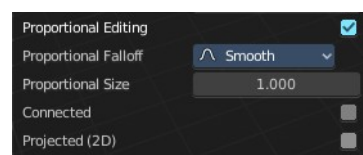
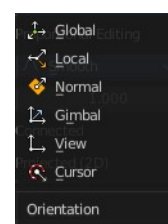
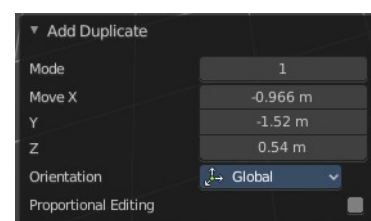

Copy

Copies the selection.

Paste

Pastes a copied selection to active layer. You can have more than one layer.

Paste by Layer

Pastes a copied selection to same, original layer. You can have more than one layer.

Last operator Paste Strokes

Type

Choose between the paste methods again.

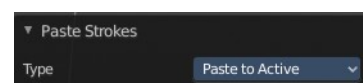

Merge

Allows you to paint a new stroke between the selected vertices. The selected points are not merged though, but a new stroke is created.

Last Operator Merge Strokes

Mode

Choose between stroke or point mode.

This feature is not documented in the Blender manual, there is no explanation in the tool tip, and it is not to find out what the difference is. Both do the same.

Draw on back

Draw the new stroke below all other strokes.

Additive drawing

Add to previous drawing

Cyclic

Close the new stroke

Dissolve Points

Dissolve the old selected points.

Delete Strokes

Deletes the old selected strokes.

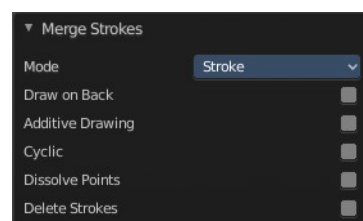

Merge by Distance

Merges vertices that are close to each other.

Last Operator *Clean Loose Points*

Threshold

The distance.

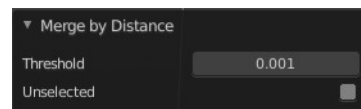

Unselected

Merge also unselected geometry.

Split

Splits the selection.

Separate

Separates the selection into a new grease pencil object.

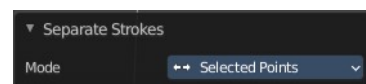

Last Operator **Separate Strokes**

Mode

Active Layer

Separate all the strokes at the current active layer.

Selected Strokes

Separate the whole stroke of the current selection.

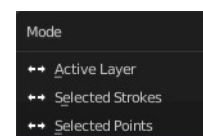

Selected Points

Separate the selected points with its edges.

Delete Points

Delete selected stroke points.

Last Operator **Delete**

Type

Choose what you want to delete.



Dissolve

Dissolve is a union operation. Two edges becomes one edge by removing the vertice in between.

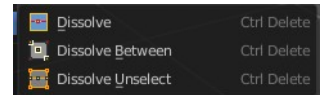

Dissolve

Dissolves the selection.

Dissolve Between

Dissolves the vertices between the selected vertices.

Dissolve Unselect

Dissolves the vertices that are not selected.

Last Operator Dissolve

Type

Choose how you want to dissolve.

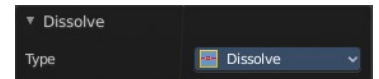

7.0.13 Editors - 3D Viewport - Grease Pencil object - Sculpt Mode - Brushes context menu

Table of content

Edit Mode - Brushes Context Menu.....	1
Radius.....	1
Strength.....	1
Active Layer.....	1
Layer drop down box.....	2
New Layer.....	2
Layer Edit Box.....	2
Remove Layer.....	2

Edit Mode - Brushes Context Menu

Call this menu with double right click in the 3D viewport. You need to be in Sculpt mode with a grease pencil object.

In Sculpt mode you will call a context menu with the sliders from the Brush settings.

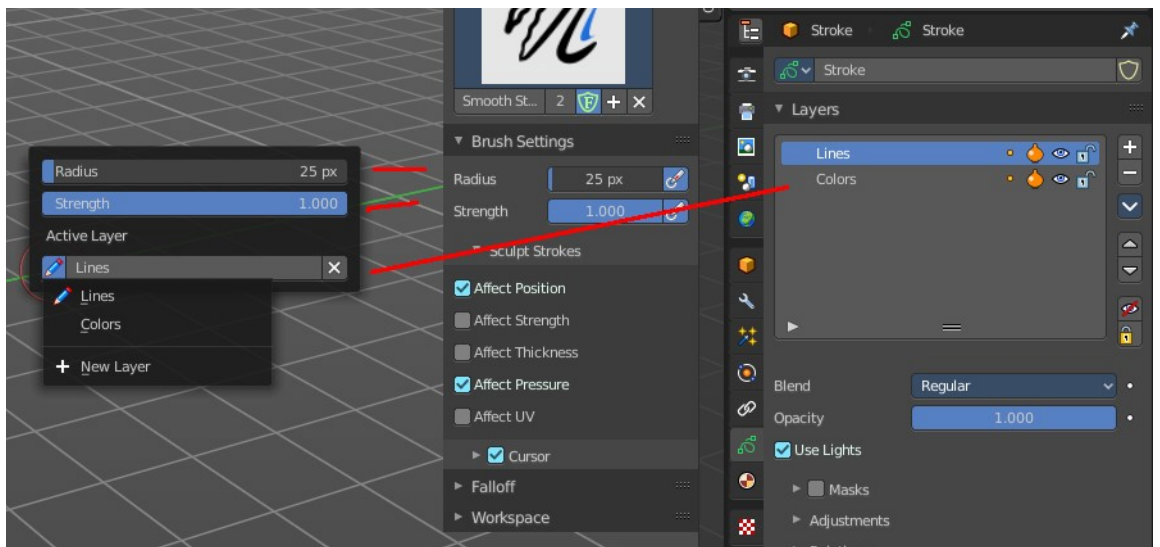

Radius

The radius of the sculpt brush.

Strength

The strength of the sculpt brush.

Active Layer

The active grease pencil layer. You can choose another layer, and add new layers here too. It is the same content

than in the Properties editor.

Layer drop down box

The list of available layers.

New Layer

Add a new grease pencil layer.

Layer Edit Box

The currently active grease pencil layer. Rename it by clicking into the field.

Remove Layer

Remove the grease pencil layer.

7.0.14 Editors - 3D Viewport - Grease Pencil object - Draw Mode - Brushes context menu

Table of content

- Draw Mode - Brushes Context Menu.....1
- Radius.....1
- Strength.....2
- Active Layer.....2
 - Layer drop down box.....2
 - New Layer.....2
 - Layer Edit Box.....2
 - Remove Layer.....2
- Show/Hide Dropdown.....2
 - Show All Layers.....2
 - Hide Active Layer.....2
 - Last Operator Hide Layer(s).....2
 - Unselected.....2
 - Hide Inactive Layers.....2
- Active Material.....2
 - Material drop down box.....3
 - Material Edit Box.....3

Draw Mode - Brushes Context Menu

Call this menu with double right click in the 3D viewport. You need to be in Draw mode with a grease pencil object.

In Draw mode you will call a context menu with the sliders from the Brush settings.

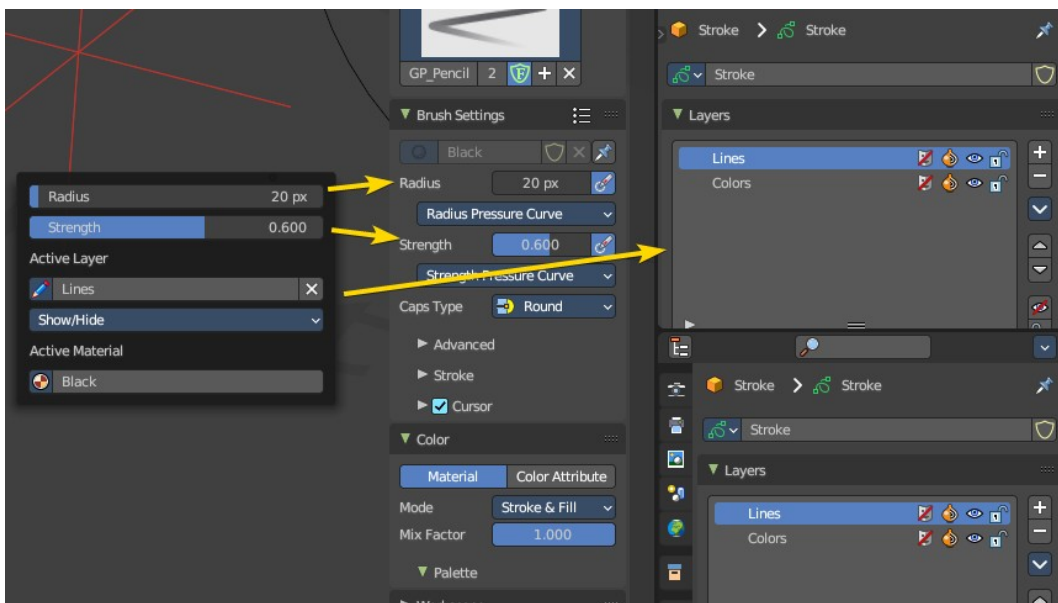

Radius

The radius of the sculpt brush.

Strength

The strength of the sculpt brush.

Active Layer

The active grease pencil layer. You can choose another layer, and add new layers here too. It is the same content than in the Properties editor.

Layer drop down box

The list of available layers.

New Layer

Add a new grease pencil layer.

Layer Edit Box

The currently active grease pencil layer. Rename it by clicking into the field.

Remove Layer

Remove the grease pencil layer.

Show/Hide Dropdown

Sub-menu with shows or hide all layers, active layers or inactive layers operators.

Show All Layers

Makes all layers in the grease pencil object visible again.

Hide Active Layer

Hides the active grease pencil layer.

Last Operator Hide Layer(s)

Unselected

Hides the not selected geometry.

Hide Inactive Layers

Hides the not selected grease pencil layer. The selected layer stays visible.

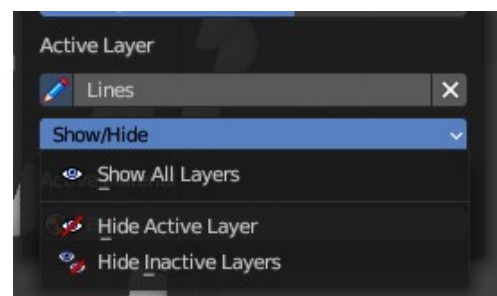

Active Material

The current active material.

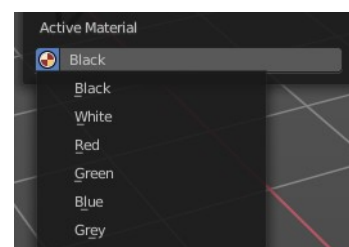

Material drop down box

The list of available materials.

Material Edit Box

The currently active material. Rename it by clicking into the field.

1

7.0.15 Editors - 3D Viewport - Grease Pencil object - Vertex Paint Mode - Brushes context menu

Table of content

- Vertex Paint Mode - Brushes Context Menu.....1
- Color dialog.....2
- Mode.....2
- Radius.....2
- Strength.....2
- Active Layer.....2
 - Layer drop down box.....2
 - New Layer.....2
 - Layer Edit Box.....2
 - Remove Layer.....2
- Show/Hide Dropdown.....2
 - Show All Layers.....2
 - Hide Active Layer.....3
 - Last Operator Hide Layer(s).....3
 - Unselected.....3
 - Hide Inactive Layers.....3

Vertex Paint Mode - Brushes Context Menu

Call this menu with double right click in the 3D viewport. You need to be in Vertex Paint mode with a grease pencil object.

In Vertex Paint mode you will call a context menu with the sliders from the Brush settings.

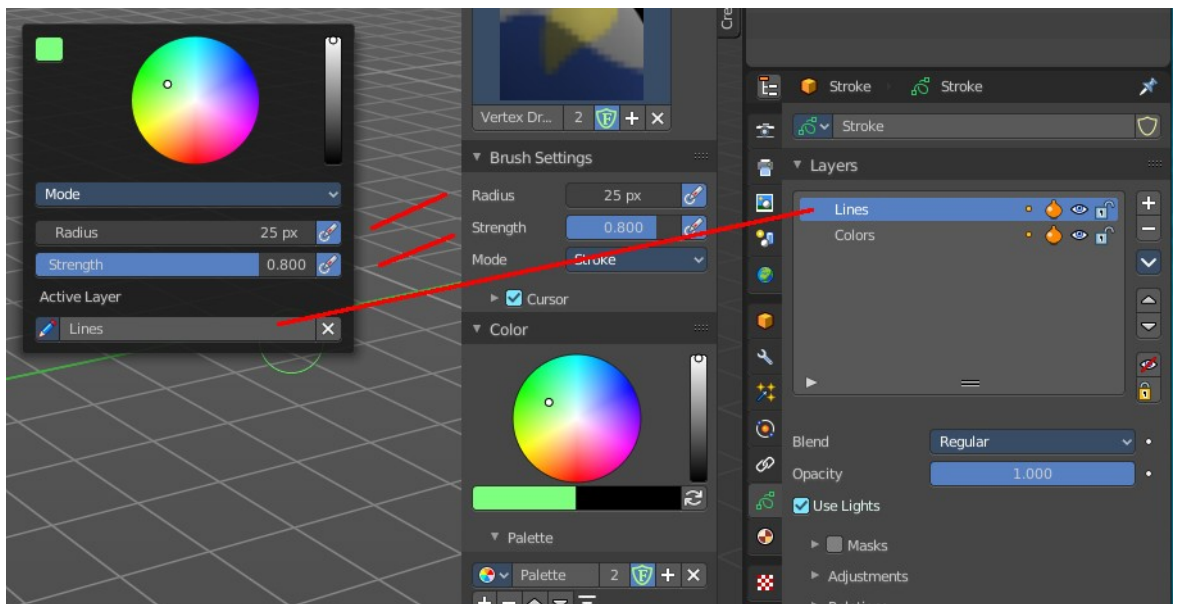

Color dialog

Define the color for your brush.

Up left is the active color. Change the color in the color dialog.

Mode

The stroke mode. What the vertex color affects. Stroke, Fill, or both.

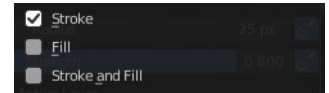

Radius

The radius of the sculpt brush.

Strength

The strength of the sculpt brush.

Active Layer

The active grease pencil layer. You can choose another layer, and add new layers here too. It is the same content than in the Properties editor.

Layer drop down box

The list of available layers.

New Layer

Add a new grease pencil layer.

Layer Edit Box

The currently active grease pencil layer. Rename it by clicking into the field.

Remove Layer

Remove the grease pencil layer.

Show/Hide Dropdown

Sub-menu with shows or hide all layers, active layers or inactive layers operators.

Show All Layers

Makes all layers in the grease pencil object visible again.

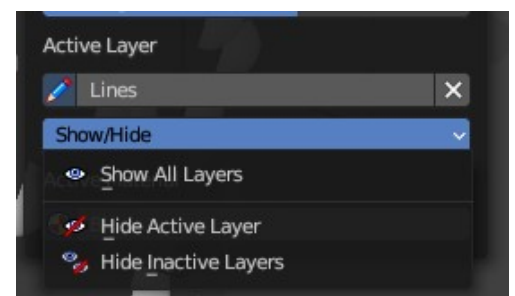

Hide Active Layer

Hides the active grease pencil layer.

Last Operator Hide Layer(s)

Unselected

Hides the not selected geometry.

Hide Inactive Layers

Hides the not selected grease pencil layer. The selected layer stays visible.



7.0.16 Editors - 3D Viewport - Grease Pencil object - Weight Paint Mode - Brushes context menu

Table of content

Weight Paint Mode - Brushes Context Menu.....	1
Radius.....	1
Strength.....	1
Weight.....	2
Active Layer.....	2
Layer drop down box.....	2
New Layer.....	2
Layer Edit Box.....	2
Remove Layer.....	2

Weight Paint Mode - Brushes Context Menu

Call this menu with double right click in the 3D viewport. You need to be in Weight Paint mode with a grease pencil object.

In Weight Paint mode you will call a context menu with the sliders from the Brush settings.

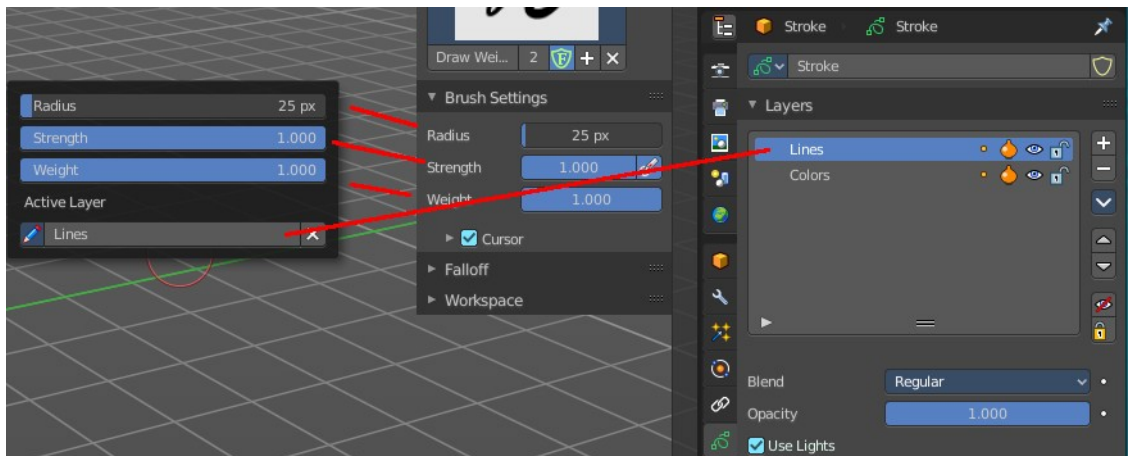

Radius

The radius of the sculpt brush.

Strength

The strength of the sculpt brush.

Weight

The vertex weight to paint to.

Active Layer

The active grease pencil layer. You can choose another layer, and add new layers here too. It is the same content than in the Properties editor.

Layer drop down box

The list of available layers.

New Layer

Add a new grease pencil layer.

Layer Edit Box

The currently active grease pencil layer. Rename it by clicking into the field.

Remove Layer

Remove the grease pencil layer.

7.0.17 Editors - 3D Viewport - Armature - Edit Mode - Armature context menu

Table of content

Edit Mode - Armature Context Menu.....	3
Subdivide.....	3
Last Operator Subdivide Multi.....	3
Number of Cuts.....	3
Duplicate.....	3
Last Operator Duplicate.....	3
Duplicate Objects.....	3
Flip Names.....	3
Move X , Y , Z.....	3
Orientation.....	3
Proportional editing.....	4
Extrude.....	4
Last Operator Extrude.....	4
Forked.....	4
Move X , Y, Z.....	4
Orientation.....	4
Proportional editing.....	4
Fill between Joints.....	5
Mirror.....	5
Interactive Mirror.....	5
X Global, Y Global etc.....	5
Last Operator Mirror.....	5
Orientation.....	5
Constraint Axis.....	5
Proportional editing.....	5
Proportional Falloff.....	5
Proportional Size.....	6
Connected.....	6
Projected(2D).....	6
Snap.....	6
Last Operator Snap.....	6
Offset.....	6
Switch Direction.....	6
Symmetrize.....	6
Last Operator Symmetrize.....	7
Direction.....	7
Names.....	7
Autoname Left/Right.....	7
Autoname Front/Back.....	7
Autoname Top/Bottom.....	7
Last operator Autoname by Axis.....	7
Axis.....	7
Flip Names.....	7
Last operator Autoname by Axis.....	7

Strip Numbers.....	7
Make Parent.....	8
Connected.....	8
Keep Offset.....	8
Last Operator Make Parent.....	8
Parent Type.....	8
Clear Parent.....	8
Clear Parent.....	8
Disconnect Bone.....	8
Last Operator Clear Parent.....	8
Clear Type.....	8
Split.....	9
Separate.....	9
Show/Hide.....	9
Show Hidden.....	9
Hide Selected.....	9
Last Operator Hide Selected.....	9
Unselected.....	9
Hide Unselected.....	9
Dissolve selected bones.....	9
Delete selected bones.....	10

Edit Mode - Armature Context Menu

Call this menu with double right click in the 3D viewport. You need to be in Edit mode with a armature object.

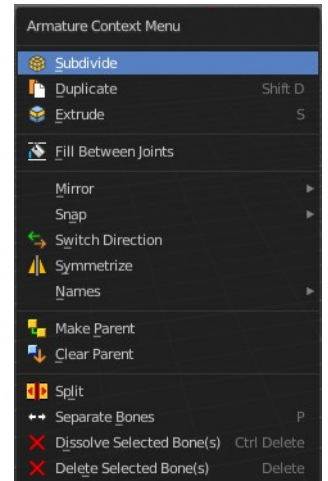

Subdivide

Subdivide subdivides the current selection.

Last Operator Subdivide Multi

Number of Cuts

Adjust the number of subdivisions.

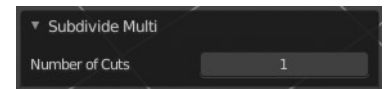

Duplicate

Duplicates selected bones.

You are automatically in grab mode, and so you can easily move the object out of position. Which is sometimes wanted, since you can position the duplicate then. But sometimes this is unwanted. A right click after releasing the mouse lets the object snap back into its creation position.

When you drag the duplicate around you will see the position values in the header.

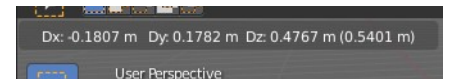

Last Operator Duplicate

Duplicate Objects

Flip Names

Tries to flip the names of the bones. This is a name convention feature. When you have a bone called mybone.R, then it tries to become mybone.L

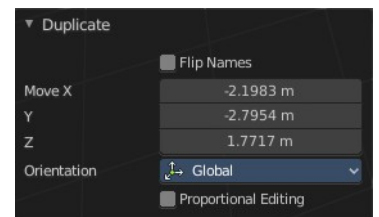

Move X , Y , Z

The Position of the duplicated object.

Orientation

Orientation is a drop-down box choose the type of orientation for the duplicate action.

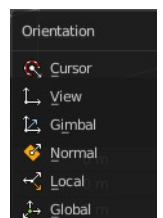

Proportional editing

This checkbox has no use here. You cannot activate it.

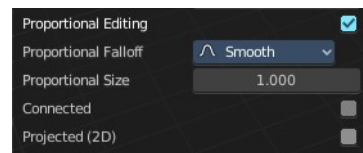

Extrude

Extrudes out a bone from the selected joints.

Last Operator Extrude

Forked

You need to tick X Axis Mirror. When you tick Forked, then the bone that you extrude to the one side will now be extruded to the other side too. The extrude gets mirrored along the x axis. This allows you to create a symmetrical armature.

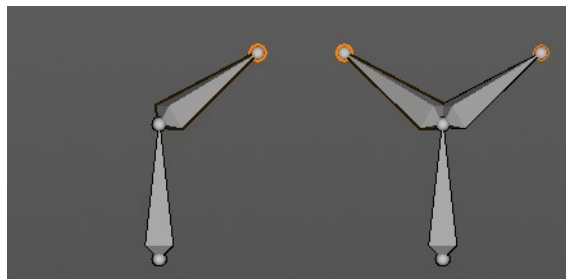
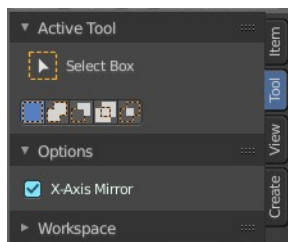
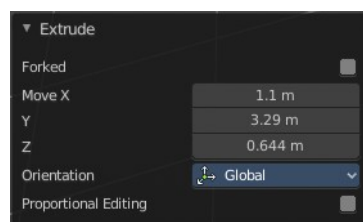

Move X , Y, Z

The transform values for the new created joint(s)

Orientation

Orientation is a drop-down box choose the type of orientation for the mirroring action.

Proportional editing

Proportional editing is dysfunctional. You cannot activate it.

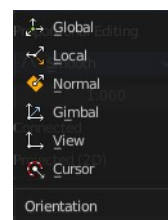

Fill between Joints

Fill between joints fills a bone between two selected joints.

When there is just one joint selected, then the bone is created between this selected joint and the 3D cursor.

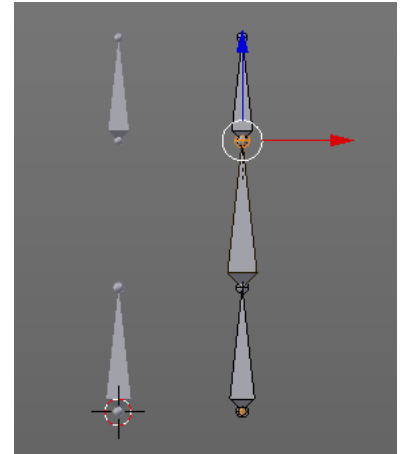

Mirror

Mirror mirrors the selected geometry along the defined axis.

Interactive Mirror

Mirror by hotkeys. You activate the tool, type in x for x global for example, or x x for x local. And the selection gets mirrored.



X Global, Y Global etc.

Mirrors the selection around the chosen axis.

Last Operator Mirror

The Last Operator Mirror panel gives you tools to adjust the mirror action.

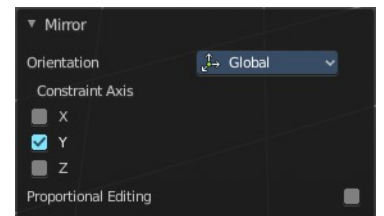

Orientation

Orientation is a drop-down box choose the type of orientation for the mirroring action.

Constraint Axis

Constraint Axis gives you again the possibility to define the mirror axis. You can choose more than one axis here.

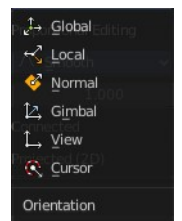

Proportional editing

Enables proportional editing. Activating proportional editing reveals further settings.

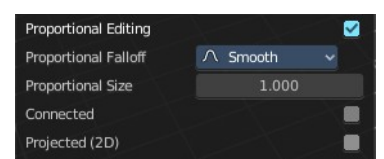

Proportional Falloff

Adjust the falloff methods.

Proportional Size

See and adjust the falloff radius.

Connected

The proportional falloff gets calculated for connected parts only.

Projected(2D)

The proportional falloff gets calculated in the screen space. Depth doesn't play a role. When it's in the radius, then it gets calculated.

Snap

Choose several methods to snap one element to another. The menu items should be self explaining.

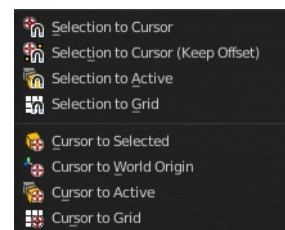

Last Operator Snap

Some snap operations shows a last operation panel, some not.

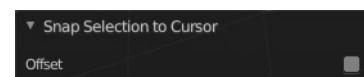

Offset

If the selection should snap as a whole, or if each individual element of the selection should snap.

Switch Direction

Switches the direction in which the selected bones are pointing.

Symmetrize

Creates a symmetrical mirrored copy of the currently selected bones along the X axis. The mirror center is the pivot of the armature.

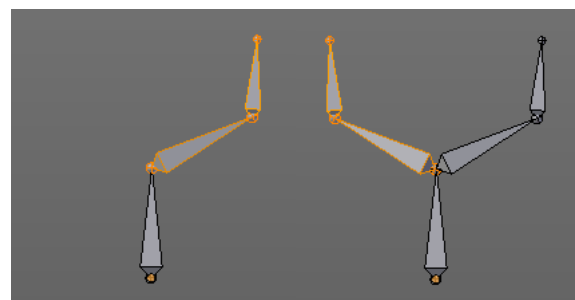

The bones that you want to symmetrize needs to follow the left right name conventions for bones. Bones without this left right naming are not affected by the tool. If there is a lower or upper case “L”, “R”, “left” or “right” with a separating dot in the bone name, then this tool creates and renames the bones names to its counter part. Bone.L becomes Bone.R.

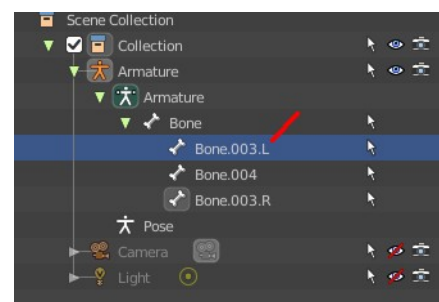

Last Operator Symmetrize

Direction

Define the calculation direction. From -X to + X or from +X to -X

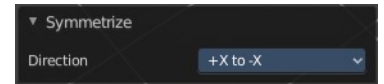

Names

Bforartists has some internal name conventions for a symmetrical armature. Bones are for example named mybone.L or mybone.R, dependent at which side of the mirror axis they are. The Names items allows you to rename the bone names to this name convention.



Autoname Left/Right

Renames the bones from left to right.

Autoname Front/Back

Renames the bones from front to back.

Autoname Top/Bottom

Renames the bones from top to bottom.

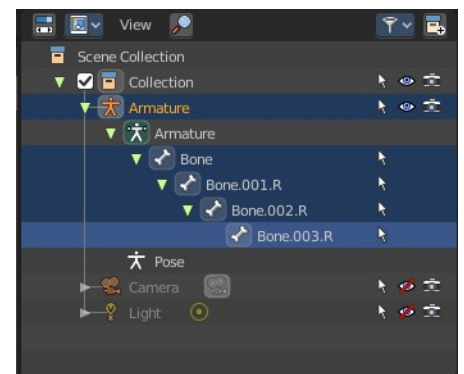
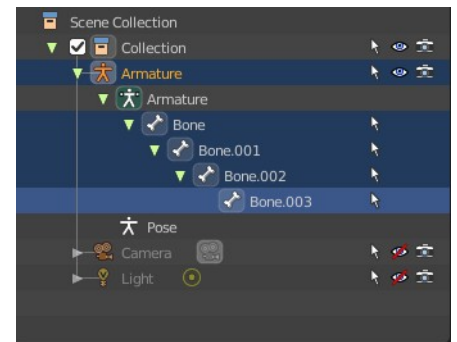

Last operator Autoname by Axis

Axis

Choose the autoname axis again. Left/Right is X axis, Front/Back is Y axis, and Top/Bottom is Z axis.

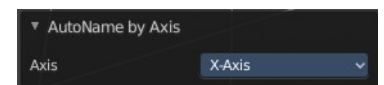

Flip Names

When you mirror a half of an armature you end in names like Bone.001.R.001. But what we need is Bone.001.L for a symmetrical armature. Flip names flips the names to follow the left right name conventions.

Last operator Autoname by Axis

Strip Numbers

Tries to remove the numbers in the names if possible.



Make Parent

Adds a parent relationship.

Select a bone, hold down shift, select the bone that you want to parent it to. Perform Make Parent. In the popup choose the method that you want to use.

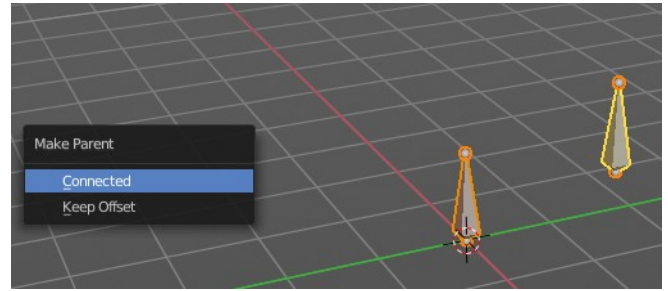

Connected

The child bone will jump to the position of the tail joint of the parent bone.

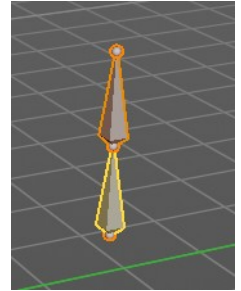

Keep Offset

The bone will remain in its original position. The relationship will be displayed by a black dotted line.

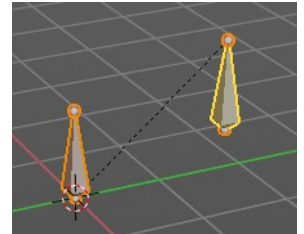

Last Operator Make Parent

Parent Type

Choose between Connected and Keep Offset method again.

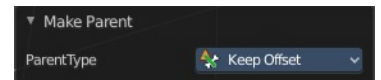

Clear Parent

Clears the parent relationship of the selected bone(s). It calls a popup menu choose between two methods.

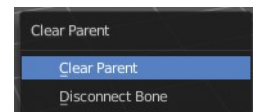

Clear Parent

Clears the parent relationship of the selected bone(s).

Disconnect Bone

The parent-ship is kept. Turns a Connected parent relationship into a Keep Offset parent relationship. You can move the disconnected bone around without to pull the parent with it.

Last Operator Clear Parent

Clear Type

Choose between Clear Parent and Disconnect Bone method again.

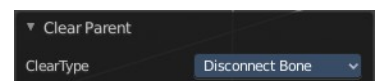

Split

Split splits the selected bone(s) from connected bones. They are still part of the armature. But the bone is now floating. And you can pull this bone(s) around without pulling the rest of the armature around.

The Last operator for Split has no content.

Separate

Separate separates the selected bone(s) from the armature. And creates a new, independent, armature.

The Last operator for Separate has no content.

Show/Hide

Sub-menu with shows or hide selection, unselected or hidden operators.



Show Hidden

Makes all geometry in the scene visible again.

Hide Selected

Hides the selected geometry.

Last Operator Hide Selected

Unselected

Hides the not selected geometry.

Hide Unselected

Hides the not selected geometry. The selected geometry stays visible.



Dissolve selected bones

Merges the selected bone or joint with its hierarchical neighbor bones.

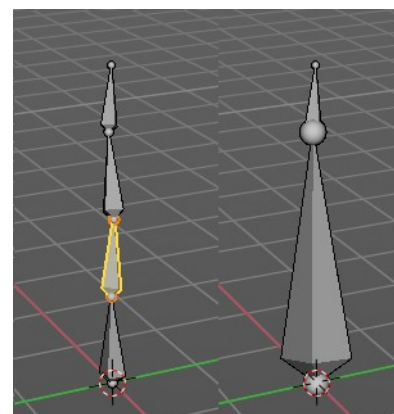

Delete selected bones

Deletes the selected bones. The hierarchy is kept. The involved bones becomes disconnected.

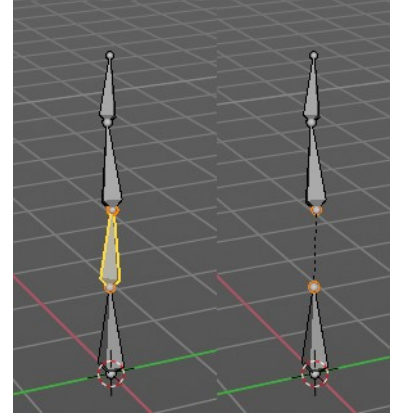



7.0.18 Editors - 3D Viewport - Armature - Pose Mode - Pose context menu

Table of content

Pose Mode - Pose Context Menu.....	3
Insert Key frame.....	3
Copy Pose.....	3
Paste Pose.....	3
Paste X Flipped Pose.....	3
Last Operator Paste Pose.....	3
Flipped on X Axis.....	3
On Selected Only.....	3
Rename active Bone.....	4
Push Pose from Breakdown.....	4
Last Operator Push Pose.....	4
Percentage.....	4
Previous Key frame.....	4
Next Key frame.....	4
Channels.....	4
Axis Lock.....	4
Relax Pose to Breakdown.....	4
Last Operator Relax Pose to Breakdown.....	4
Percentage.....	4
Previous Key frame.....	4
Next Key frame.....	5
Channels.....	5
Axis Lock.....	5
Pose Breakdownner.....	5
Last Operator Pose Breakdownner.....	5
Percentage.....	5
Previous Key frame.....	5
Next Key frame.....	5
Channels.....	5
Axis Lock.....	5
Blend to Neighbour.....	6
Last Operator Blend to Neighbour.....	6
Factor.....	6
Previous Keyframe.....	6
Next Keyframe.....	6
Channels.....	6
Axis Lock.....	6
Calculate Motion Paths.....	6
Last Operator Calculate Object Path.....	7
Start.....	7
End.....	7
Bake Location.....	7
Clear Motion Paths.....	7
Update Armature Motion Paths.....	7

Update All Motion Paths.....	7
Hide Selected.....	7
Show Hidden.....	7
Clear User Transforms.....	7
Show/Hide.....	7
Show Hidden.....	8
Hide Selected.....	8
Hide Unselected.....	8

Pose Mode - Pose Context Menu

Call this menu with double right click in the 3D viewport. You need to be in Edit mode with an armature object.

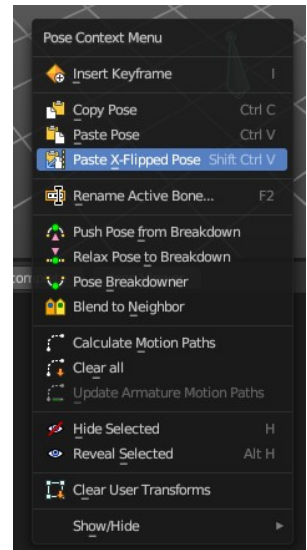

Insert Key frame

Opens a menu where you can insert a key frame with a defined keying set.

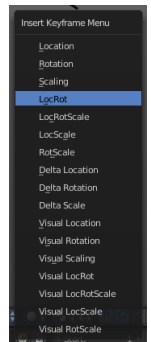

Copy Pose

Copies the current pose. You copy what you have selected.

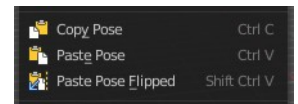

Paste Pose

Pastes a previous copied pose.

Paste X Flipped Pose

Pastes a previous copied pose, but flipped along X axis.

Last Operator Paste Pose

Flipped on X Axis

Paste the pose flipped along X Axis.

On Selected Only

Paste just on the selected bones. Not on the unselected.

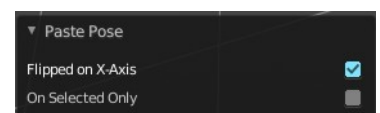

Rename active Bone

Calls a dialog where you can rename the active bone.



Push Pose from Breakdown

Exaggerates the current pose. Pushes the current pose further away from the previous pose.

Last Operator Push Pose

Percentage

The percentage of exaggeration.

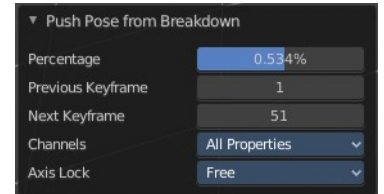

Previous Key frame

The key frame position before the current frame.

Next Key frame

The key frame position after the current frame.

Channels

Limit the push effect to specific channels.

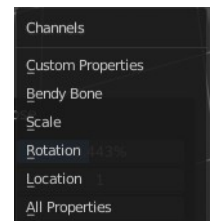

Axis Lock

Limit the push effect to specific axis.

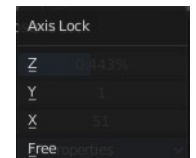

Relax Pose to Breakdown

Relaxes the current pose.

Last Operator Relax Pose to Breakdown

Percentage

The percentage of relaxing.

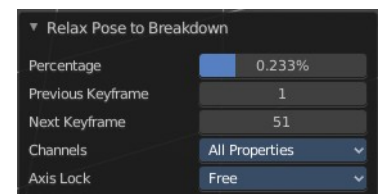

Previous Key frame

The key frame position before the current frame.

Next Key frame

The key frame position after the current frame.

Channels

Limit the relax effect to specific channels.

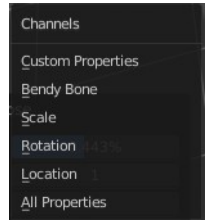

Axis Lock

Limit the relax effect to specific axis.



Pose Breakdowner

Creates a suitable breakdowner pose on the current frame.

When you perform the tool then you will see a per cent slider in the header where you can read the percentual influence of the blending. Move the mouse to position the blend pose where you need it.



Last Operator Pose Breakdowner

Percentage

The percentage of exaggeration.

Previous Key frame

The key frame position before the current frame.

Next Key frame

The key frame position after the current frame.

Channels

Limit the breakdowner pose to specific channels.

Axis Lock

Limit the breakdowner pose to specific axis.

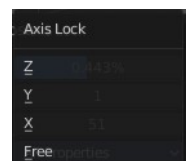
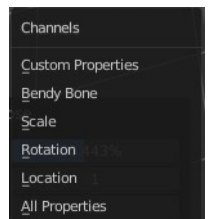
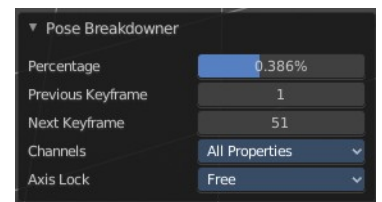

Blend to Neighbour

Blends the current pose with the neighbouring poses.

When you perform the tool then you will see a per cent slider in the header where you can read the percentual influence of the blending. Move the mouse to position the blend pose where you need it.



Last Operator Blend to Neighbour



Factor

The blend factor.

Previous Keyframe

The keyframe to calculate from before the current position.

Next Keyframe

The keyframe to calculate from after the current position.

Channels

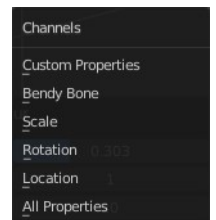

Axis Lock

Lock the transformation along an axis.

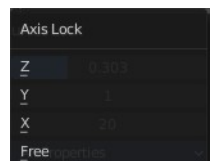

Calculate Motion Paths

Objects can be animated. Let's say you send them from a to b to c. The object will move to b, then to c. Some kind of a path. This path is not visible by default.

With motion paths you can calculate this path, and make it visible.

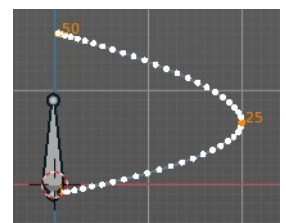

Last Operator Calculate Object Path

Start

Defines the start frame of the calculation.

End

Defines the end frame of the calculation.

Bake Location

Where to draw the curve. At the head or at the tail of the bone(s)

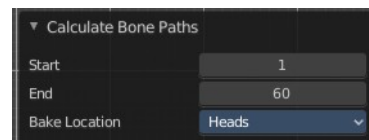

Clear Motion Paths

Clear remove the motion path from the object.

Update Armature Motion Paths

Updates the motion paths for the armature object.

Update All Motion Paths

Updates the motion paths for all objects.

Hide Selected

Hides the selected geometry.

Show Hidden

Makes all hidden geometry visible again.

Clear User Transforms

Resets Pose of selected bones back to key frame state.



7.0.19 Editors - 3D Viewport - Armature - Edit Mode - Lattice context menu

Table of content

Edit Mode - Lattice Context Menu.....	1
Mirror.....	1
Interactive Mirror.....	1
X Global, Y Global etc.....	1
Last Operator Mirror.....	1
Orientation.....	2
Constraint Axis.....	2
Proportional editing.....	2
Proportional Falloff.....	2
Proportional Size.....	2
Connected.....	2
Projected(2D).....	2
Flip.....	2
Last Operator Flip (Distortion Free).....	2
Flip Axis.....	2
Snap.....	2
Last Operator Snap.....	3
Offset.....	3
Make Regular.....	3

Edit Mode - Lattice Context Menu

Call this menu with double right click in the 3D viewport. You need to be in Edit mode with a armature object.

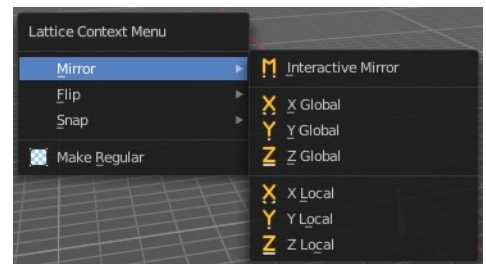

Mirror

Mirror mirrors the selected geometry along the defined axis.

Interactive Mirror

Mirror by hotkeys. You activate the tool, type in x for x global for example, or x x for x local. And the selection gets mirrored.

X Global, Y Global etc.

Mirrors the selection around the chosen axis.

Last Operator Mirror

The Last Operator Mirror panel gives you tools to adjust the mirror action.

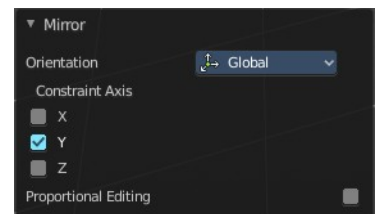

Orientation

Orientation is a drop-down box choose the type of orientation for the mirroring action.

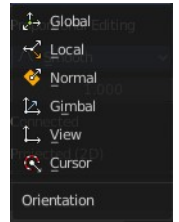

Constraint Axis

Constraint Axis gives you again the possibility to define the mirror axis. You can choose more than one axis here.

Proportional editing

Enables proportional editing. Activating proportional editing reveals further settings.

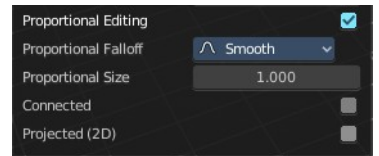

Proportional Falloff

Adjust the falloff methods.

Proportional Size

See and adjust the falloff radius.

Connected

The proportional falloff gets calculated for connected parts only.

Projected(2D)

The proportional falloff gets calculated in the screen space. Depth doesn't play a role. When it's in the radius, then it gets calculated.

Flip

Flips the lattice object along the world axis X, Y or Z .

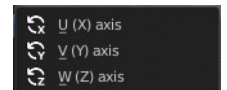

Last Operator Flip (Distortion Free)

Flip Axis

Flip the lattice object along the world axis X, Y or Z .



Snap

Choose several methods to snap one element to another. The menu items should be self explaining.

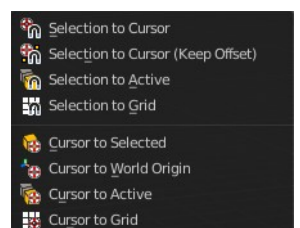

Last Operator Snap

Some snap operations shows a last operation panel, some not.

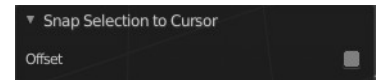

Offset

If the selection should snap as a whole, or if each individual element of the selection should snap.

Make Regular

Set the UVW control points by a uniform distance apart.

7.0.2 Editors - 3D View - Mesh Object - Edit Mode - Vertex Context Menu

Table of content

Detailed table of content.....	1
Vertex Context Menu.....	5
Subdivide.....	5
Extrude Vertices.....	6
Bevel Vertices.....	7
Make Edge/Face.....	9
Connect Vertex Path.....	9
Connect Vertex Pair.....	10
Push/Pull.....	10
Shrink/Fatten.....	10
Shear.....	11
Randomize Vertices.....	12
Smooth Laplacian.....	13
Snap Vertices.....	13
Last Operator Snap.....	13
Mirror Vertices.....	14
Merge Vertices.....	14
Split.....	15
Separate.....	15
Dissolve Vertices.....	15
Delete Vertices.....	16

Detailed table of content

Detailed table of content

Detailed table of content.....	1
Vertex Context Menu.....	5
Subdivide.....	5
Last Operator Subdivide.....	5
Number of Cuts.....	5
Smoothness.....	5
Create N-Gons.....	5
Quad Corner Type.....	5
Fractal.....	6
Along Normal.....	6
Random Seed.....	6
Extrude Vertices.....	6
Last Operator Extrude Only Vertices and Move.....	6
Move X Y Z.....	6
Orientation.....	6
Constraint Axis.....	6
Proportional editing.....	6
Proportional Falloff.....	6

Proportional Size.....	6
Connected.....	6
Projected(2D).....	6
Bevel Vertices.....	7
Last Operator Bevel.....	7
Offset.....	7
Width type.....	7
Vertex only.....	7
Clamp Overlap.....	7
Loop Slide.....	7
Mark Seams.....	7
Mark Sharp.....	7
Harden Normals.....	7
Segments.....	7
Profile.....	8
Material.....	8
Miter Type.....	8
Outer Miter.....	8
Sharp.....	8
Patch.....	8
Arc.....	8
Inner Miter.....	8
Sharp.....	8
Arc.....	8
Spread.....	8
Face Strength Mode.....	9
None.....	9
New.....	9
Affected.....	9
All.....	9
Intersection type.....	9
Make Edge/Face.....	9
Connect Vertex Path.....	9
Connect Vertex Pair.....	10
Push/Pull.....	10
Last Operator Push/Pull.....	10
Factor.....	10
Proportional editing.....	10
Proportional Falloff.....	10
Proportional Size.....	10
Connected.....	10
Projected(2D).....	10
Shrink/Fatten.....	10
Last Operator Shrink/Fatten.....	11
Offset.....	11
Offset Even.....	11
Proportional editing.....	11
Proportional Falloff.....	11
Proportional Size.....	11
Connected.....	11
Projected(2D).....	11
Shear.....	11
Last Operator Shear.....	11

Offset.....	11
Shear Axis.....	11
Axis.....	12
Axis Ortho.....	12
Orientation.....	12
Proportional editing.....	12
Proportional Falloff.....	12
Proportional Size.....	12
Connected.....	12
Projected(2D).....	12
Randomize Vertices.....	12
Last Operator Randomize.....	12
Amount.....	12
Uniform.....	12
Normal.....	12
Random Seed.....	13
Smooth Laplacian.....	13
Last Operator Laplacian Smooth Vertex.....	13
Number of Iterations.....	13
Lambda Factor.....	13
Lambda Factor in border.....	13
Smooth Axis.....	13
Preserve Volume.....	13
Snap Vertices.....	13
Last Operator Snap.....	13
Offset.....	13
Mirror Vertices.....	14
Last Operator Mirror.....	14
Orientation.....	14
Constraint Axis.....	14
Proportional editing.....	14
Proportional Falloff.....	14
Proportional Size.....	14
Connected.....	14
Projected(2D).....	14
Merge Vertices.....	14
At Center, At Cursor, Collapse.....	14
Last Operator Merge.....	15
Type.....	15
UV's.....	15
By Distance.....	15
Last Operator Merge by Distance.....	15
Merge Distance.....	15
Split.....	15
Separate.....	15
Selection.....	15
By Material.....	15
By Loose Parts.....	15
Dissolve Vertices.....	15
Last Operator Dissolve Vertices.....	16
Face Split.....	16
Tear Boundary.....	16
Delete Vertices.....	16

Vertex Context Menu

Call this menu with double right click in the 3D viewport. You need to be in Edit mode with a Mesh object. And in selection mode Vertice.

Select geometry to reveal all content.

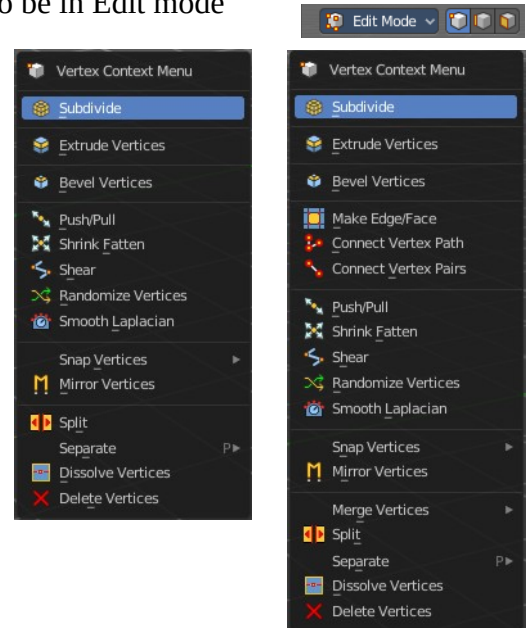

Subdivide

Subdivide divides the selected edges. It subdivides the involved faces too, and can create new vertices.

A more unknown functionality is that it can also randomize the result with the Fractal slider in the Last operator panel.

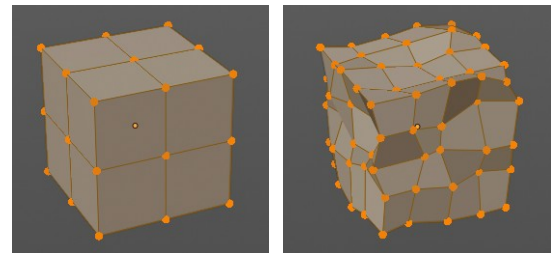

Last Operator Subdivide

Number of Cuts

The number of cuts defines the amount of subdivisions.

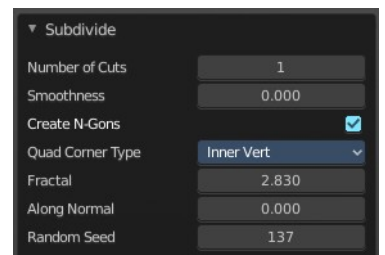

Smoothness

This value defines how smooth the subdivision result is. From flat to bent.

Create N-Gons

Create N-Gons if required. Else subdividing N-Gons creates Tris.

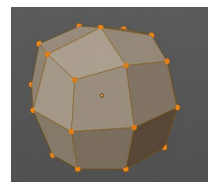

Quad Corner Type

Adjust the corner type.

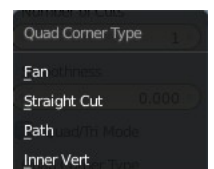

Fractal

Randomize the selected vertices.

Along Normal

When randomized, this value defines how strong the subdivision follows the normals of the initial vertices.

Random Seed

Randomizing value for fractal randomizing.

Extrude Vertices

Extrudes out the selected vertices by moving the mouse.

Last Operator Extrude Only Vertices and Move

Move X Y Z

The coordinates for the extruded geometry.

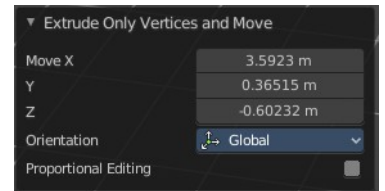

Orientation

Choose the type of orientation, in which coordinate system the action should happen.

Constraint Axis

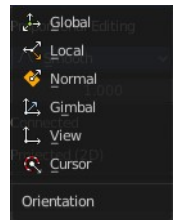

Proportional editing

Enables proportional editing. Activating proportional editing reveals further settings.

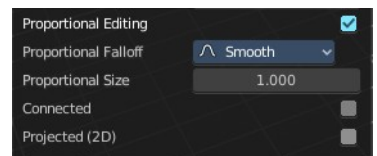

Proportional Falloff

Adjust the falloff methods.

Proportional Size

See and adjust the falloff radius.

Connected

The proportional falloff gets calculated for connected parts only.

Projected(2D)

The proportional falloff gets calculated in the screen space. Depth doesn't play a role. When it's in the radius, then it gets calculated.

Bevel Vertices

Adds a bevel at the selected vertices.

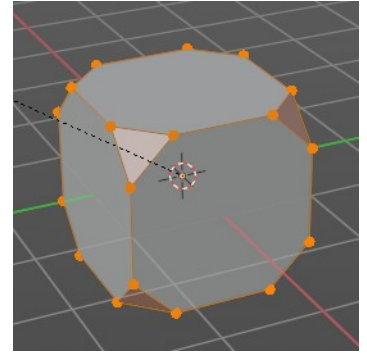

Last Operator Bevel

Offset

The Bevel amount. This text changes, dependent of the chosen width type.

Width type

Which measure type to choose for the bevel action. Offset, Width, Depth or Percent.

Vertex only

Bevel Vertices only.

Clamp Overlap

Do not allow beveled geometry to overlap each other.

Loop Slide

Prefer slide along edge to even widths.

Mark Seams

Mark the edges of the new created geometry as seams.

Mark Sharp

Mark the edges of the new created geometry sharp.

Harden Normals

When enabled, the per-vertex face normals of the bevel faces are adjusted to match the surrounding faces, and the normals of the surrounding faces are not affected. This will keep the surrounding faces flat (if they were before), with the bevel faces shading smoothly into them. For this effect to work, custom split normals need to be enabled, which requires Auto Smooth to be enabled (see Normals). As a convenience, that option will be enabled for you if it is not already when you enable Harden Normals here.

Segments

How many segments gets created.

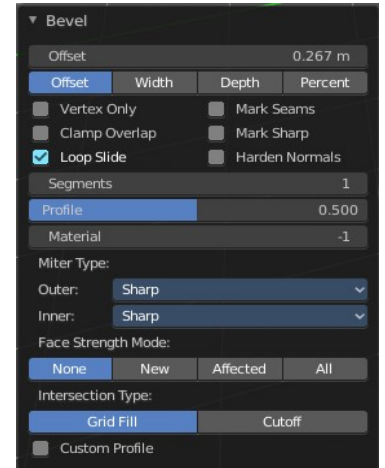

Profile

Controls the Profile shape. 0.5 means round.

Material

Material for beveled faces. -1 is the surrounding material.

Miter Type

Outer Miter

How the outer miter is set. Miter is how the bevel rounding at a corner is done.

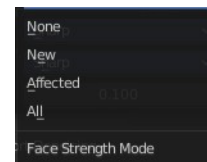

Sharp

Creates a sharp miter.

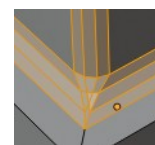

Patch

This replaces the outside vertex of a miter with 3 vertices. And uses a patch pattern there.

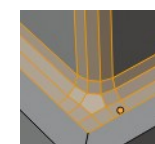

Arc

This replaces the vertex of a miter with 2 vertices, joined by an arc. A separate Spread parameter says how far to move the vertices away from their original position.

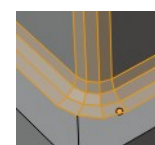

Inner Miter

How the inner miter is set. Miter is how the bevel rounding at a corner is done.

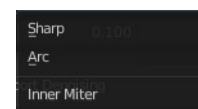

Sharp

Creates a sharp miter.

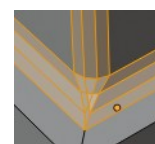

Arc

This replaces the vertex of a miter with 2 vertices, joined by an arc. A separate Spread parameter says how far to move the vertices away from their original position.

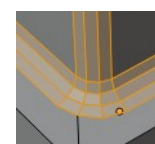

Spread

Belongs to inner miter method Arc. Adjust how strong the inner radius is bent.

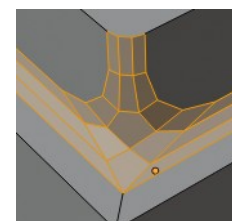

Face Strength Mode

Set Face Strength on the faces involved in the bevel, according to the specified mode. This can be used in conjunction with a Weight Normals Modifier (with the Face Influence option checked).

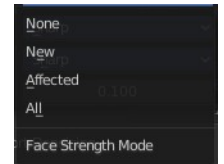

None

Do not set face strength.

New

Set the face strength of new faces along edges to Medium, and the face strength of new faces at vertices to Weak.

Affected

In addition to those set for the New case, also set the faces adjacent to new faces to have strength Strong.

All

In addition to those set for the Affected option, also set all the rest of the faces of the model to have strength Strong.

Intersection type

The method to use to create meshes at intersections. Bevel can create self intersecting geometry.

Make Edge/Face

Adds a face when you have edges selected. And Edges when you have Vertices selected. It's a Bridge tool.

You can have either the one method or the other. When you select two adjacent vertices, then you select the edge too. And the tool works in edge mode then. In this case just the possible faces gets created. Not edges between single vertices.

First select the edges or Vertices that you want to bridge. Then click the New Edge/Face from Vertices Button.



Connect Vertex Path

Connect Vertex path connects selected vertices, but takes the vertex order into account in which you selected the vertices. It just creates edges between vertices that are not connected in this order.

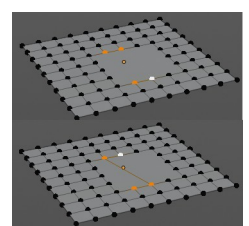

Connect Vertex Pair

Connect Vertex pair connects selected vertices and makes a face of the pairs.

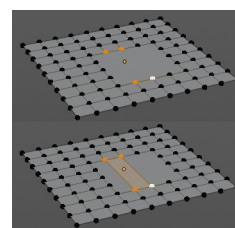

Push/Pull

It pushes or pulls the object positions relative to the center of the selection.

In Object mode this tool requires to have more than one object selected.

Last Operator Push/Pull

Factor

Adjust the strength of influence of the tool.

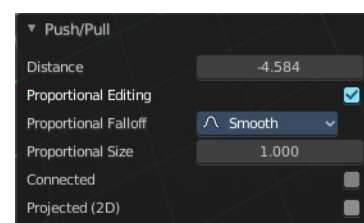

Proportional editing

Enables proportional editing. Activating proportional editing reveals further settings.

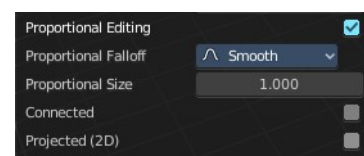

Proportional Falloff

Adjust the falloff methods.

Proportional Size

See and adjust the falloff radius.

Connected

The proportional falloff gets calculated for connected parts only.

Projected(2D)

The proportional falloff gets calculated in the screen space. Depth doesn't play a role. When it's in the radius, then it gets calculated.

Shrink/Fatten

Shrink/Fatten scales the selected geometry along its normals. Transform orientation and Pivot point gets ignored.

A positive value pushes the vertices outwards. A negative value pushes the vertices inwards.

Last Operator Shrink/Fatten

The Last Operator Shrink/Fatten panel gives you tools to adjust the Shrink/Fatten operation. Here you have numeric input for the strength and a few more options.

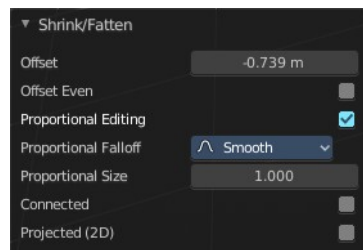

Offset

Offset is the strength of the offset for Shrink/Fatten.

Offset Even

Offset Even scales the selection to give more thickness in even areas.

Proportional editing

Enables proportional editing. Activating proportional editing reveals further settings.

Proportional Falloff

Adjust the falloff methods.

Proportional Size

See and adjust the falloff radius.

Connected

The proportional falloff gets calculated for connected parts only.

Projected(2D)

The proportional falloff gets calculated in the screen space. Depth doesn't play a role. When it's in the radius, then it gets calculated.

Shear

Shear shears the selection.

Last Operator Shear

Offset

Adjust an offset.

Shear Axis

The shear tool works along a imaginary 2d plane. The shear axis controls if the items are sheared along the x or the y axes of this plane. This is the plane along which the transformation happens. You can shear along the x or the y axis of this plane.

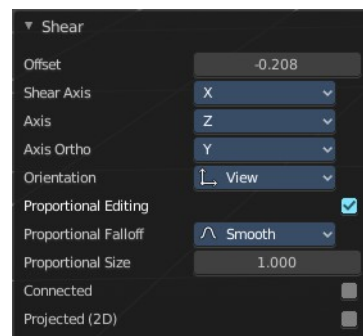

To make things even more complicated, the orientation of this imaginary plane is defined by the Axis and Axis Ortho items below.

Axis

Defines one axis of the imaginary shear axis plane.

Axis Ortho

Defines the other axis of the imaginary shear axis plane.

Orientation

Choose the orientation for the shear action.

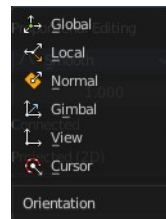

Proportional editing

Enables proportional editing. Activating proportional editing reveals further settings.

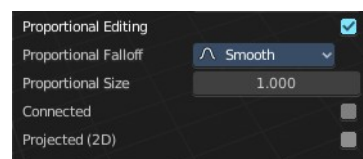

Proportional Falloff

Adjust the falloff methods.

Proportional Size

See and adjust the falloff radius.

Connected

The proportional falloff gets calculated for connected parts only.

Projected(2D)

The proportional falloff gets calculated in the screen space. Depth doesn't play a role. When it's in the radius, then it gets calculated.

Randomize Vertices

This tool allows randomizes the positions of the selected vertices.

Last Operator Randomize

Amount

Adjust the amount.



Uniform

The uniform offset distance.

Normal

Align the offset direction to the normals.

Random Seed

The seed value for randomization.

Smooth Laplacian

Laplacian Smooth Vertex smooths out the angles between the selected vertices. It is a tool to reduce noise at the mesh. It works a bit different than the normal Smooth Vertex tool. And gives a different result. The Laplacian method allows you to preserve the volume, and to adjust border smoothing.

Last Operator Laplacian Smooth Vertex

Number of Iterations

Number of Iterations is the number of iterations that the smoothing action gets repeated. With 1 the smoothing is just performed once. With 10 it is performed ten times.

Lambda Factor

Lambda Factor is the strength of the smoothing.

Lambda Factor in border

Lambda Factor is the strength of the smoothing in border areas.

Smooth Axis

The Smooth Axis check boxes allows you to limit the smoothing to specific world axis.

Preserve Volume

Preserve Volume preserves the volume of the object.

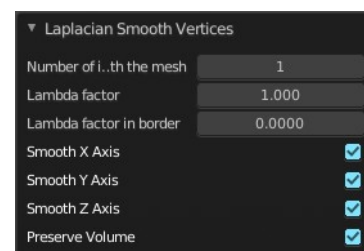

Snap Vertices

Choose several methods to snap one element to another. The menu items should be self explaining.

Last Operator Snap

Some snap operations shows a last operation panel, some not.

Offset

If the selection should snap as a whole, or if each individual element of the selection should snap.

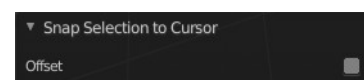
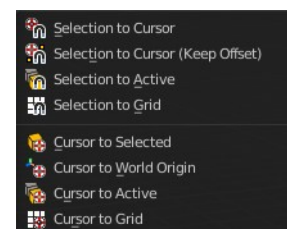

Mirror Vertices

Mirror by hotkeys. You activate the tool, type in x for x global for example, or x x for x local. And the selection gets mirrored.

Last Operator Mirror

The Last Operator Mirror panel gives you tools to adjust the mirror action.

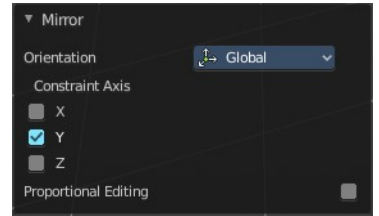

Orientation

Orientation is a drop-down box choose the type of orientation for the mirroring action.

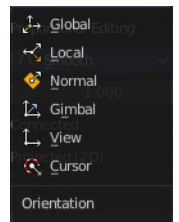

Constraint Axis

Constraint Axis gives you again the possibility to define the mirror axis. You can choose more than one axis here.

Proportional editing

Enables proportional editing. Activating proportional editing reveals further settings.

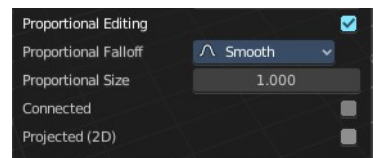

Proportional Falloff

Adjust the falloff methods.

Proportional Size

See and adjust the falloff radius.

Connected

The proportional falloff gets calculated for connected parts only.

Projected(2D)

The proportional falloff gets calculated in the screen space. Depth doesn't play a role. When it's in the radius, then it gets calculated.

Merge Vertices

Merges the geometry.

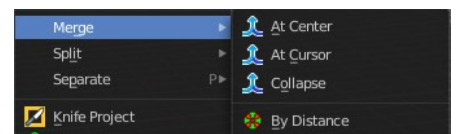

At Center, At Cursor, Collapse

Merges the geometry with the given methods.

Last Operator Merge

Type

Choose the merge method again.

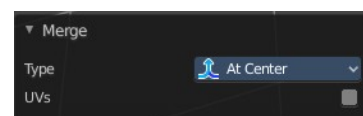

UV's

Move the UV's according to the merge.

By Distance

Merge the vertices by their distance to each other. This tool is meant to remove double vertices at the same location.

Last Operator Merge by Distance

Merge Distance

Adjust the distance below which the vertices gets merged.

Merge selected vertices to unselected vertices.

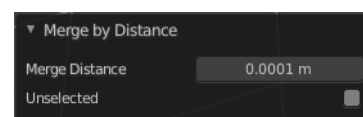

Split

Splits the edges between the selected vertices. It creates two edges out of one. And splits the edge by that.

Separate

Separate separates the selected geometry, and creates a new object. The geometry becomes uneditable, since it is now a new object. You will have to leave the Edit mode, select the new object, and re-enter Edit mode when you want to edit it.

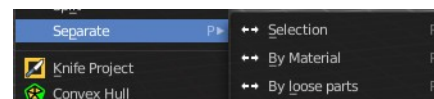

Selection

Selection separates the current selection.

By Material

By Material separates all geometry that has the same material than the current selection.

By Loose Parts

By Loose parts separates all geometry that is connected by edges to the current selection.

Dissolve Vertices

Dissolve Vertices dissolves the selected Vertices.

Note that pressing DEL in Vertice select mode calls Dissolve Vertices already. It's the same operator. But you don't get the Last operator that way.

Last Operator Dissolve Vertices

Face Split

Split off Face corners to maintain surrounding geometry

Tear Boundary

Split off Face corners instead of merging faces.



Delete Vertices

Deletes the selected vertices.

7.0.3 Editors - 3D View - Mesh Object - Edit Mode - Edge Context Menu

Table of content

Detailed table of content.....	1
Edge Context Menu.....	5
Subdivide.....	5
Extrude Edges.....	6
Bevel Edges.....	7
Make Edge/Face.....	9
Bridge Edge loops.....	10
Fill.....	10
Loop Cut and Slide.....	11
Offset Edge Slide.....	12
Knife Topology.....	12
Rotate Edge CW.....	13
Edge Split.....	13
Edge Crease.....	14
Edge Bevel Weight.....	14
Mark Sharp.....	15
Clear Sharp.....	15
Mark Freestyle Edge.....	15
Clear Freestyle Edge.....	15
Un-Subdivide.....	16
Split.....	16
Separate submenu.....	16
Dissolve Vertices.....	16
Dissolve.....	17
Delete Edges.....	17
Show/Hide.....	17

Detailed table of content

Detailed table of content

Detailed table of content.....	1
Edge Context Menu.....	5
Subdivide.....	5
Last Operator Subdivide.....	5
Number of Cuts.....	5
Smoothness.....	5
Create N-Gons.....	6
Quad Corner Type.....	6
Fractal.....	6
Along Normal.....	6
Random Seed.....	6
Extrude Edges.....	6
Last Operator Extrude Only Edges and Move.....	6

Flip Normals.....	6
Move X Y Z.....	6
Orientation.....	6
Constraint Axis.....	6
Proportional editing.....	6
Proportional Falloff.....	6
Proportional Size.....	7
Connected.....	7
Projected(2D).....	7
Bevel Edges.....	7
Last Operator Bevel.....	7
Offset.....	7
Width type.....	7
Vertex only.....	7
Clamp Overlap.....	7
Loop Slide.....	7
Mark Seams.....	7
Mark Sharp.....	7
Harden Normals.....	8
Segments.....	8
Profile.....	8
Material.....	8
Miter Type.....	8
Outer Miter.....	8
Sharp.....	8
Patch.....	8
Arc.....	8
Inner Miter.....	8
Sharp.....	8
Arc.....	8
Spread.....	9
Face Strength Mode.....	9
None.....	9
New.....	9
Affected.....	9
All.....	9
Intersection type.....	9
Make Edge/Face.....	9
Bridge Edge loops.....	10
Last Operator Bridge Edge loops.....	10
Connect Loops.....	10
Merge.....	10
Merge Factor.....	10
Twist.....	10
Number of Cuts.....	10
Interpolation.....	10
Smoothness.....	10
Profile Factor.....	10
Profile shape.....	10
Fill.....	10
Last Operator Fill.....	11
Beauty.....	11
Loop Cut and Slide.....	11

Last Operator Loop Cut and Slide.....	11
Number of Cuts.....	11
Smoothness.....	11
Falloff.....	11
Factor.....	11
Even.....	11
Flipped.....	11
Clamp.....	12
Correct UV's.....	12
Offset Edge Slide.....	12
Last Operator Offset Edge Slide.....	12
Cap Endpoint.....	12
Factor.....	12
Even.....	12
Flipped.....	12
Clamp.....	12
Correct UV's.....	12
Knife Topology.....	13
Hotkey functionality in the footer text.....	13
Rotate Edge CW.....	13
Last Operator Rotate Selected Edge.....	13
Counter Clockwise.....	13
Edge Split.....	14
Last Operator Edge Split.....	14
Type.....	14
Edge Crease.....	14
Last Operator Edge Crease.....	14
Factor.....	14
Edge Bevel Weight.....	14
Last Operator Edge Bevel Weight.....	15
Factor.....	15
Mark Sharp.....	15
Last Operator Mark Sharp.....	15
Vertices.....	15
Clear Sharp.....	15
Last Operator Mark Sharp.....	15
Vertices.....	15
Mark Freestyle Edge.....	15
Clear Freestyle Edge.....	16
Un-Subdivide.....	16
Last Operator Un-Subdivide.....	16
Iterations.....	16
Split.....	16
Separate submenu.....	16
Selection.....	16
By Material.....	16
By Loose Parts.....	16
Dissolve Vertices.....	16
Last Operator Dissolve Vertices.....	17
Face Split.....	17
Tear Boundary.....	17
Dissolve.....	17
Delete Edges.....	17

Show/Hide.....	17
Show Hidden.....	17
Hide Selected.....	17
Last Operator Hide Selected.....	17
Unselected.....	17
Hide Unselected.....	17

Edge Context Menu

Call this menu with double right click in the 3D viewport. You need to be in Edit mode with a Mesh object. And in selection mode Edge.

Select geometry to reveal all content.

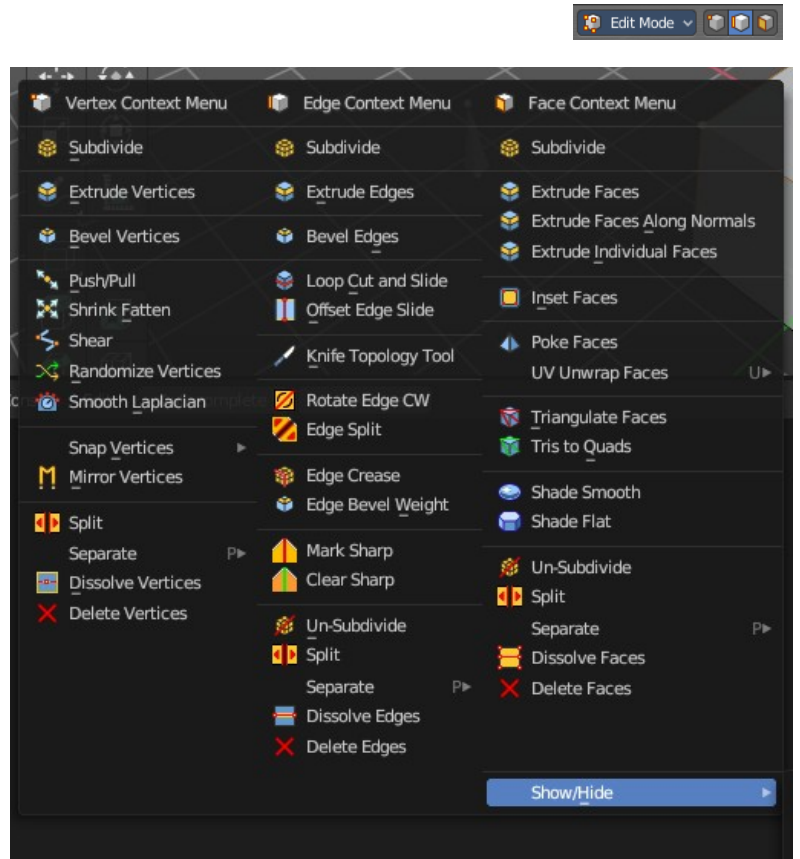

Subdivide

Subdivide divides the selected edges. It subdivides the involved faces too, and can create new vertices.

A more unknown functionality is that it can also randomize the result with the Fractal slider in the Last operator panel.

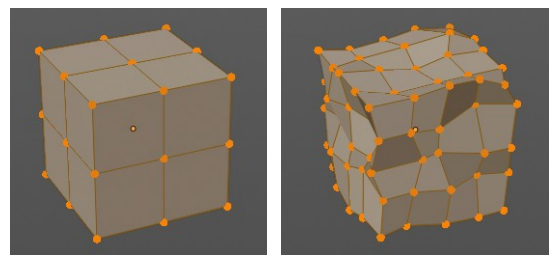

Last Operator Subdivide

Number of Cuts

The number of cuts defines the amount of subdivisions.

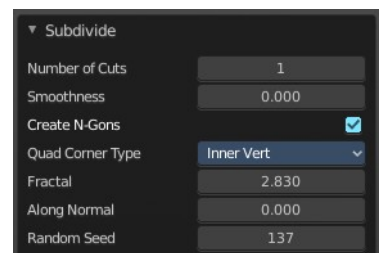

Smoothness

This value defines how smooth the subdivision result is. From flat to bent.

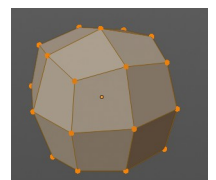

Create N-Gons

Create N-Gons if required. Else subdividing N-Gons creates Tris.

Quad Corner Type

Adjust the corner type.



Fractal

Randomize the selected vertices.

Along Normal

When randomized, this value defines how strong the subdivision follows the normals of the initial vertices.

Random Seed

Randomizing value for fractal randomizing.

Extrude Edges

Extrudes out the selected edges by moving the mouse.

Last Operator Extrude Only Edges and Move

Flip Normals

Flip the normals at the involved faces.

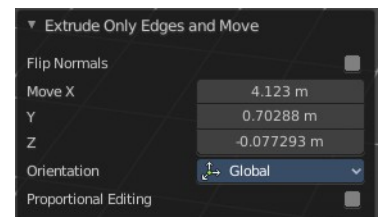

Move X Y Z

The coordinates for the extruded geometry.

Orientation

Choose the type of orientation, in which coordinate system the action should happen.

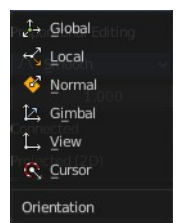

Constraint Axis

Proportional editing

Enables proportional editing. Activating proportional editing reveals further settings.

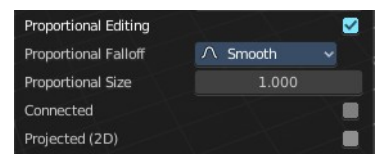

Proportional Falloff

Adjust the falloff methods.

Proportional Size

See and adjust the falloff radius.

Connected

The proportional falloff gets calculated for connected parts only.

Projected(2D)

The proportional falloff gets calculated in the screen space. Depth doesn't play a role. When it's in the radius, then it gets calculated.

Bevel Edges

Adds a bevel at the selected edges.

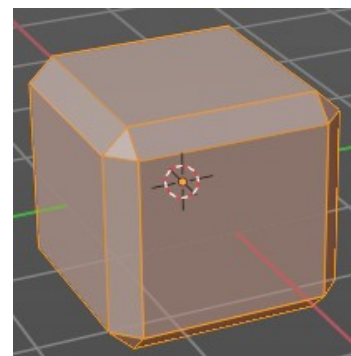

Last Operator Bevel

Offset

The Bevel amount. This text changes, dependent of the chosen width type.

Width type

Which measure type to choose for the bevel action. Offset, Width, Depth or Percent.

Vertex only

Bevel Vertices only.

Clamp Overlap

Do not allow beveled geometry to overlap each other.

Loop Slide

Prefer slide along edge to even widths.

Mark Seams

Mark the edges of the new created geometry as seams.

Mark Sharp

Mark the edges of the new created geometry sharp.

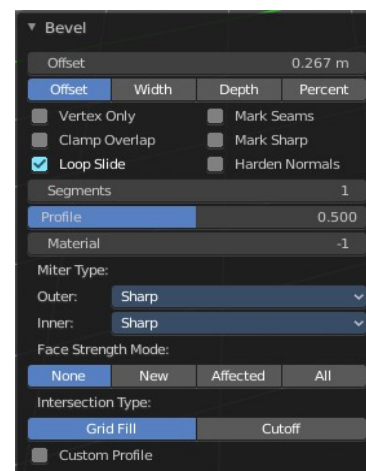

Harden Normals

When enabled, the per-vertex face normals of the bevel faces are adjusted to match the surrounding faces, and the normals of the surrounding faces are not affected. This will keep the surrounding faces flat (if they were before), with the bevel faces shading smoothly into them. For this effect to work, custom split normals need to be enabled, which requires Auto Smooth to be enabled (see Normals). As a convenience, that option will be enabled for you if it is not already when you enable Harden Normals here.

Segments

How many segments gets created.

Profile

Controls the Profile shape. 0.5 means round.

Material

Material for beveled faces. -1 is the surrounding material.

Miter Type

Outer Miter

How the outer miter is set. Miter is how the bevel rounding at a corner is done.

Sharp

Creates a sharp miter.

Patch

This replaces the outside vertex of a miter with 3 vertices. And uses a patch pattern there.

Arc

This replaces the vertex of a miter with 2 vertices, joined by an arc. A separate Spread parameter says how far to move the vertices away from their original position.

Inner Miter

How the inner miter is set. Miter is how the bevel rounding at a corner is done.

Sharp

Creates a sharp miter.

Arc

This replaces the vertex of a miter with 2 vertices, joined by an arc. A separate Spread parameter says how far to move the vertices away from their original position.

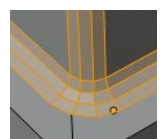
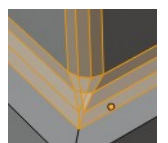
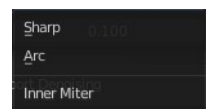
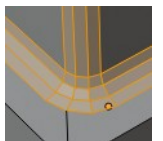
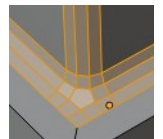
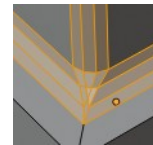

Spread

Belongs to inner miter method Arc. Adjust how strong the inner radius is bent.

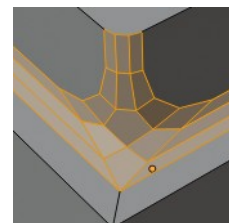

Face Strength Mode

Set Face Strength on the faces involved in the bevel, according to the specified mode. This can be used in conjunction with a Weight Normals Modifier (with the Face Influence option checked).

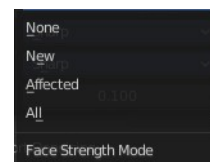

None

Do not set face strength.

New

Set the face strength of new faces along edges to Medium, and the face strength of new faces at vertices to Weak.

Affected

In addition to those set for the New case, also set the faces adjacent to new faces to have strength Strong.

All

In addition to those set for the Affected option, also set all the rest of the faces of the model to have strength Strong.

Intersection type

The method to use to create meshes at intersections. Bevel can create self intersecting geometry.

Make Edge/Face

Adds a face when you have edges selected. And Edges when you have Vertices selected. It's a Bridge tool.

You can have either the one method or the other. When you select two adjacent vertices, then you select the edge too. And the tool works in edge mode then. In this case just the possible faces gets created. Not edges between single vertices.

First select the edges or Vertices that you want to bridge. Then click the New Edge/Face from Vertices Button.

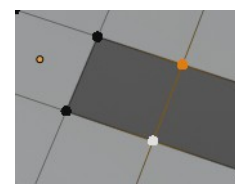
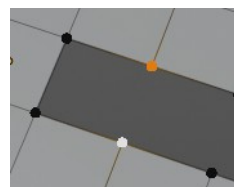
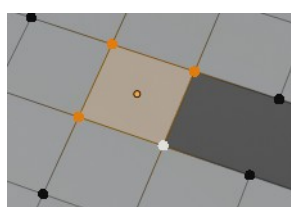
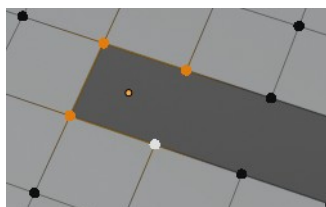

Bridge Edge loops

The Bridge edge loops tool bridges selected edges, and adds a polygon between them. You need to have at least two edges selected.

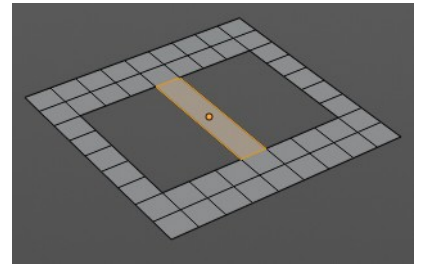

Last Operator Bridge Edge loops

Connect Loops

Choose the method how to deal with bridging multiple loops.

Merge

With merge ticked it will not create a bridge face, but merge the selected edges.

Merge Factor

The merge factor determines at which distance between the selected edges the merge happens. 0.5 is the middle of the selected edges.

Twist

The twist offset for closed loops.

Number of Cuts

Adds cuts to the bridge face.

Interpolation

Choose the interpolation mode for the cuts.

Smoothness

Adjust the smoothness for the cuts.

Profile Factor

Adjust the profile factor for the cuts.

Profile shape

Adjust the profile shape for the cuts.

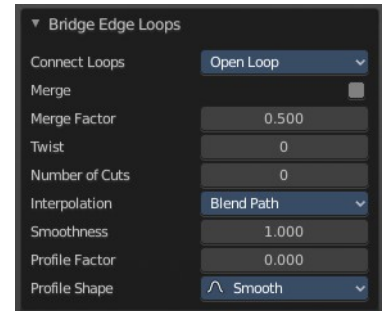

Fill

Fill closes holes in the selected mesh geometry, and triangulates the faces.

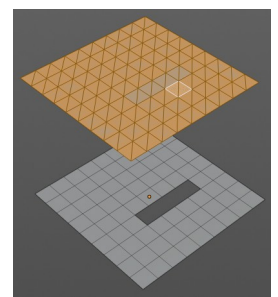

Last Operator Fill

Beauty

Uses the best possible triangulation.



Loop Cut and Slide

Loop Cut and Slide adds edge loops to divide faces

When you click once, then this edge gets created.

When you click and hold, then you can move this edge to a new location.

Loop cut and Slide ignores selections. It will try to divide the face under the mouse, and continue the loop until it is closed, or until it cannot continue.

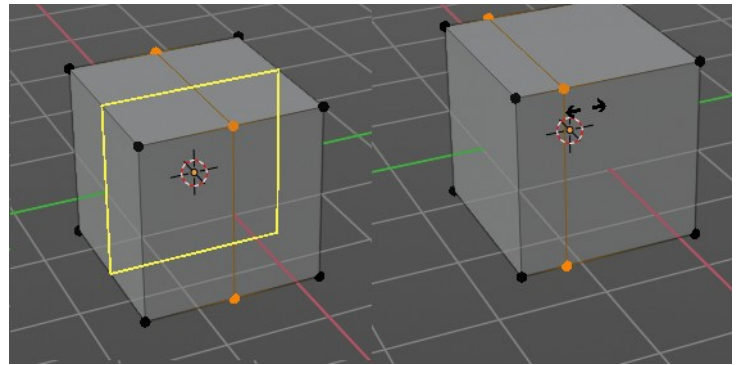

Last Operator Loop Cut and Slide

Note that all settings here just changes the latest added loop. Not all added loops in the current session.

Number of Cuts

The number of cuts that gets added. It can be more than one loop at once.

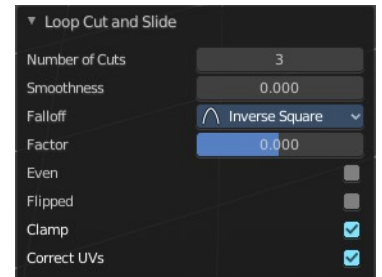

Smoothness

This value defines how smooth the loop cut gets added. From flat to bent.

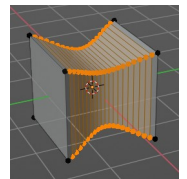

Falloff

Adjust the Falloff type for smoothness.

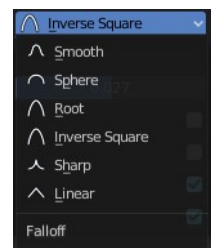

Factor

Change the center of the added loop.

Even

Make the edge loop match the shape of the adjacent edge loop

Flipped

When Even mode is active, flips between the two adjacent edge loops.

Clamp

Clamp within the edge extend.

Correct UV's

Corrects the UV's when modifying the geometry.

Offset Edge Slide

Adds left and right an edge from the selected edge and slides it outwards.

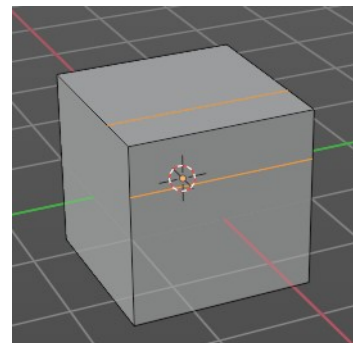

Last Operator Offset Edge Slide

Cap Endpoint

Connects the endpoints of the slided edges.

Factor

The amount of sliding.

Even

Make the edge loop match the shape of the adjacent edge loop

Flipped

Connected with Even. When even mode is active then flips between the two adjacent edge loops.

Clamp

Clamp within the edge extends.

Correct UV's

Correct UV coordinates when transforming.

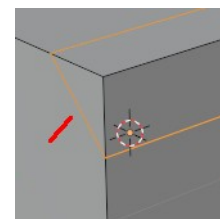
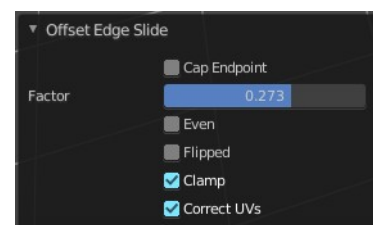

Knife Topology

The Knife tool cuts the geometry, and adds edges. When it crosses existing

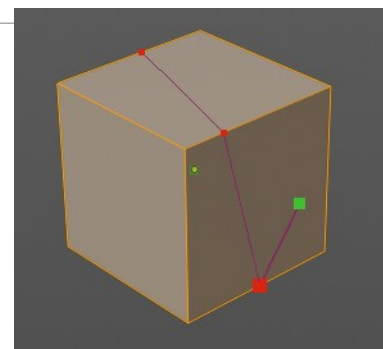

geometry then it adds a vertice at the crossing point.

Usage: activate the tool, left click to define the starting point. This can also be a point in the middle of a face. But ideally you choose an existing vertice or an edge as the start and endpoints. The knife tool tries to snap to them when you get close with the mouse cursor.

When done press Enter or Space bar to confirm. Right click abandons the operation.

When you create a vertice in the middle of a face, then the knife tool will try to connect this vertice by an existing vertice of this face when you confirm with space bar.

Hotkey functionality in the footer text

Have a look at the footer when you work with this tool. Here you will find further instructions and hotkeys.

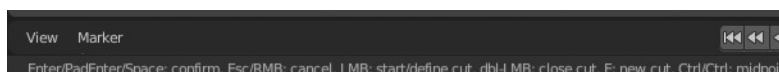

Enter, Pad Enter, Space bar - confirm

Esc key, RMB - cancel the operation

LMB start the cut

Double LMB - close the cut

E - create new cut

Ctrl or Shift while dragging - Snap to the middle of an edge

Z - cut through the whole geometry, also the back faces.

MMB - pan the view.

Alt MMB - rotate the view.

Rotate Edge CW

Rotate Edge rotates the selected edge clockwise.

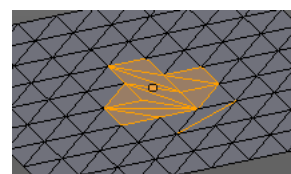

Last Operator Rotate Selected Edge

Counter Clockwise

Rotate selected edges counter clockwise.

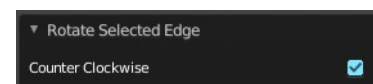

Edge Split

Splits selected edges so that each neighbor face gets its own copy. You have two methods here.

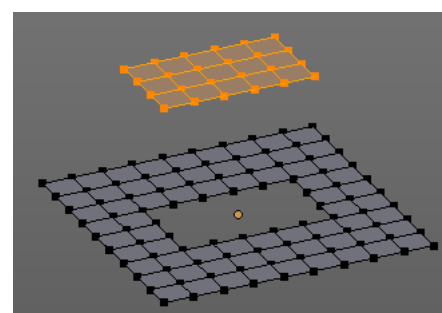

Last Operator Edge Split

Type

Choose the method again.

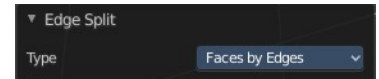

Edge Crease

When you use a Subdivision Surface Modifier, then you can define the sharpness of selected edges with this tool. Crease edges will be marked colored in edit mode.

You will see a value in the header that indicates the current strength when you activate the tool. Move with the mouse to increase or decrease the value. Or type in a value while you are in this mode. You can also scale into negative range.

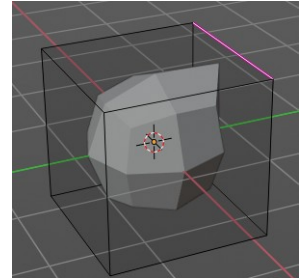

A negative crease value will subtract from the current active crease value in case it exists already from a former crease operation. A Crease value of -1 removes the crease from this edge.

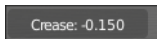

Last Operator Edge Crease

Factor

Adjust the crease factor.



Edge Bevel Weight

This tool adjusts the edge bevel weight for selected edges when you use the Bevel modifier at the mesh.

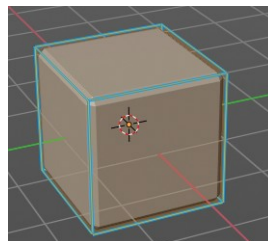

You need to have set the limit method to Weight. This way you can achieve a bevel weight for every individual selected edge if you want, and achieve different bevel strengths at the mesh.

You will see a value in the header that indicates the current strength when you activate the tool. Move with the mouse to increase or decrease the value. Or type in a value while you are in this mode. You can also scale into negative range.

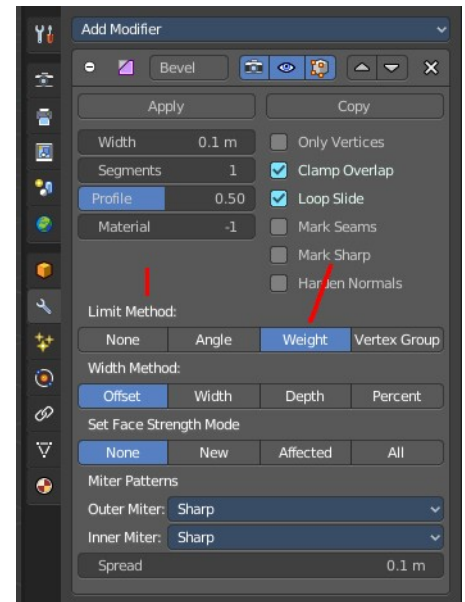

A negative Edge Bevel Weight value will subtract from the current active crease value in case it exists already from a former crease operation. An Edge Bevel Weight value of -1 removes the weight from this edge.



Last Operator Edge Bevel Weight

Factor

Adjust the Edge Bevel Weight factor.

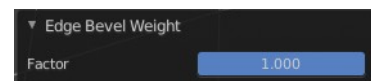

Mark Sharp

Mark Sharp is a tool that you need for the Edge Split modifier. Marked edges are displayed and rendered as sharp edges.

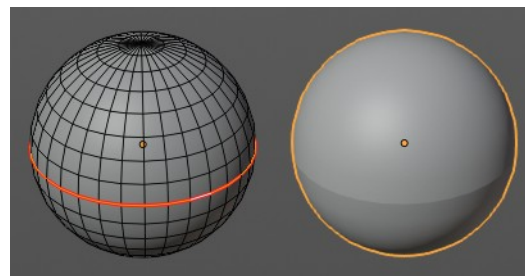
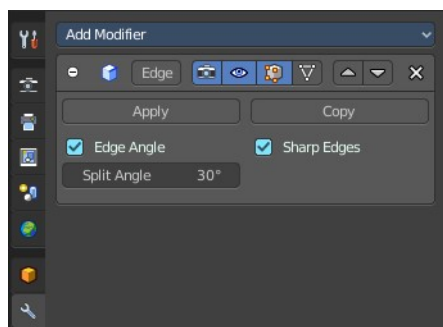

Last Operator Mark Sharp

Vertices

Calculate by the selected vertices instead of edges to mark the edges.



Clear Sharp

Clears formerly as sharp marked selected edges.

Last Operator Mark Sharp

Vertices

Calculate by the selected vertices instead of edges to mark the edges.



Mark Freestyle Edge

Mark the selected edges as a Freestyle feature edges.

Clear Freestyle Edge

Clears formerly as freestyle feature edges marked edges.

Un-Subdivide

Decimates the geometry by trying to make one quad out of four quads. But can also end in Tris where this is not possible.

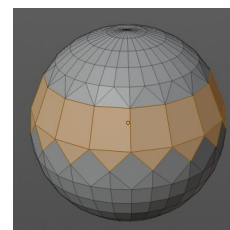

Last Operator Un-Subdivide

Iterations

Number of iterations. This means how deep the calculation should go. One level of SDS, two levels, three levels, etc. . Down to the point where you cannot decimate any geometry anymore.

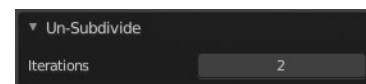

Split

Splits the edges between the selected vertices. It creates two edges out of one. And splits the edge by that.

Separate submenu

Separate separates the selected geometry, and creates a new object. The geometry becomes uneditable, since it is now a new object. You will have to leave the Edit mode, select the new object, and re-enter Edit mode when you want to edit it.

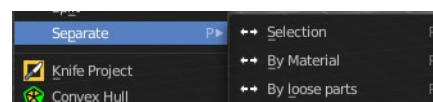

Selection

Selection separates the current selection.

By Material

By Material separates all geometry that has the same material than the current selection.

By Loose Parts

By Loose parts separates all geometry that is connected by edges to the current selection.

Dissolve Vertices

Dissolve Vertices dissolves the selected Vertices.

Note that pressing DEL in Vertice select mode calls Dissolve Vertices already. It's the same operator. But you don't get the Last operator that way.

Last Operator Dissolve Vertices

Face Split

Split off Face corners to maintain surrounding geometry

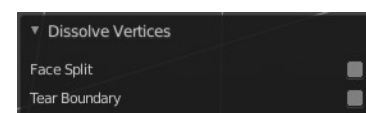

Tear Boundary

Split off Face corners instead of merging faces.

Dissolve

Dissolves the selected edges, which unions the involved faces to one.

Delete Edges

Deletes the selected Edges.

Show/Hide

Sub-menu with shows or hide selection, unselected or hidden operators.

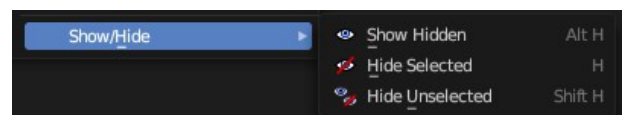

Show Hidden

Makes all geometry in the scene visible again.

Hide Selected

Hides the selected geometry.

Last Operator Hide Selected

Unselected

Hides the not selected geometry.

Hide Unselected

Hides the not selected geometry. The selected geometry stays visible.





7.0.4 Editors - 3D Viewport - Mesh Object - Edit Mode - Face Context Menu

Table of content

Detailed table of content.....	1
Face Context Menu.....	5
Subdivide.....	5
Extrude Faces.....	6
Extrude Along Normals.....	7
Extrude Individual.....	8
Inset Faces.....	9
Bridge Faces.....	10
Poke Faces.....	11
UV Unwrap Faces submenu.....	11
Triangulate Faces.....	16
Tris to Quads.....	17
Shade Smooth.....	18
Shade Flat.....	18
Un-Subdivide.....	18
Split.....	18
Separate submenu.....	19
Dissolve Faces.....	19
Delete Faces.....	19

Detailed table of content

Detailed table of content

Detailed table of content.....	1
Face Context Menu.....	5
Subdivide.....	5
Last Operator Subdivide.....	5
Number of Cuts.....	5
Smoothness.....	5
Create N-Gons.....	5
Quad Corner Type.....	5
Fractal.....	6
Along Normal.....	6
Random Seed.....	6
Extrude Faces.....	6
Last Operator Extrude Region and Move.....	6
Flip Normals.....	6
Move X, Y Z.....	6
Orientation.....	6
Proportional editing.....	6
Proportional Falloff.....	6
Proportional Size.....	6
Connected.....	7

Projected(2D).....	7
Extrude Along Normals.....	7
Header Value.....	7
Last Operator Extrude Region and Shrink/Fatten.....	7
Flip Normals.....	7
Offset.....	7
Offset Even.....	7
Proportional editing.....	7
Proportional Falloff.....	7
Proportional Size.....	7
Connected.....	8
Projected(2D).....	8
Extrude Individual.....	8
Header Value.....	8
Last Operator Extrude Individual Faces and Move.....	8
Offset.....	8
Offset Even.....	8
Proportional editing.....	8
Proportional Falloff.....	8
Proportional Size.....	8
Connected.....	8
Projected(2D).....	9
Inset Faces.....	9
Last Operator Inset Faces.....	9
Boundary.....	9
Offset Even.....	9
Offset Relative.....	9
Edge Rail.....	9
Thickness.....	9
Depth.....	9
Outset.....	9
Select Outer.....	10
Individual.....	10
Interpolate.....	10
Bridge Faces.....	10
Last Operator Bridge Edge loops.....	10
Connect Loops.....	10
Merge.....	10
Merge Factor.....	10
Twist.....	10
Number of Cuts.....	10
Interpolation.....	10
Smoothness.....	10
Profile Factor.....	10
Profile shape.....	11
Poke Faces.....	11
Last Operator Poke Faces.....	11
Poke Offset.....	11
Offset Relative.....	11
Poke Center.....	11
UV Unwrap Faces submenu.....	11
Unwrap ABF.....	11
Unwrap Conformal.....	12

Last Operator Unwrap.....	12
Method.....	12
Fill Holes.....	12
Correct Aspect.....	12
Use Subsurf Modifier.....	12
Margin.....	12
Smart UV Project.....	12
Smart UV Project Settings dialogue.....	12
Angle Limit.....	12
Island Margin.....	12
Area Weight.....	12
Correct Aspect.....	12
Last Operator Smart UV Project.....	13
Light map Pack.....	13
Settings.....	13
Selection.....	13
Share Tex Space.....	13
New UV Map.....	13
New Image.....	13
Image Size.....	13
Pack Quality.....	13
Margin.....	13
Follow Active Quads.....	13
Settings.....	14
Edge Length Mode.....	14
Last Operator Follow Active Quads.....	14
Cube Projection.....	14
Last Operator Cube Projection.....	14
Cube Size.....	14
Correct Aspect.....	14
Clip to Bounds.....	14
Scale to Bounds.....	14
Cylinder Projection.....	14
Last Operator Cylinder Projection.....	14
Direction.....	14
Align.....	14
Radius.....	14
Correct Aspect.....	14
Clip to Bounds.....	15
Scale to Bounds.....	15
Sphere Projection.....	15
Last Operator Sphere Projection.....	15
Direction.....	15
Align.....	15
Correct Aspect.....	15
Clip to Bounds.....	15
Scale to Bounds.....	15
Project from View.....	15
Last Operator Project from View.....	15
Orthographic.....	15
Camera Bounds.....	15
Correct Aspect.....	15
Clip to Bounds.....	15

Scale to Bounds.....	16
Project from View (Bounds).....	16
Mark Seam.....	16
Clear Seam.....	16
Reset.....	16
Triangulate Faces.....	16
Last Operator Triangulate Faces.....	16
Quad Method.....	16
Shortest diagonal.....	16
Fixed Alternate.....	17
Fixed.....	17
Beauty.....	17
Polygon Method.....	17
Clip.....	17
Beauty.....	17
Tris to Quads.....	17
Last Operator Tris to Quads.....	17
Max Face Angle.....	17
Max Shape Angle.....	17
Compare UV's.....	17
Compare VCols.....	17
Compare Seam.....	17
Compare Sharp.....	17
Compare Materials.....	18
Shade Smooth.....	18
Shade Flat.....	18
Un-Subdivide.....	18
Last Operator Un-Subdivide.....	18
Iterations.....	18
Split.....	18
Separate submenu.....	19
Selection.....	19
By Material.....	19
By Loose Parts.....	19
Dissolve Faces.....	19
Last Operator Dissolve Vertices.....	19
Dissolve Verts.....	19
Delete Faces.....	19

Face Context Menu

Call this menu with double right click in the 3D viewport. You need to be in Edit mode with a Mesh object. And in selection mode Edge.



Select geometry to reveal all content.

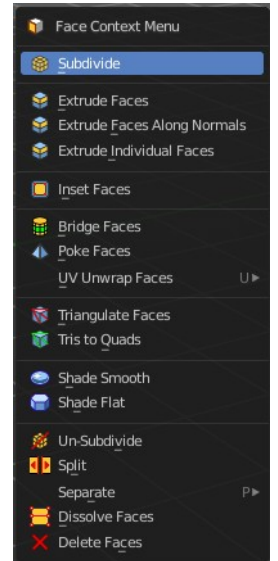
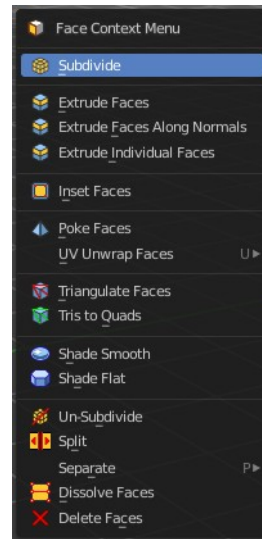

Subdivide

Subdivide divides the selected edges. It subdivides the involved faces too, and can create new vertices.

A more unknown functionality is that it can also randomize the result with the Fractal slider in the Last operator panel.

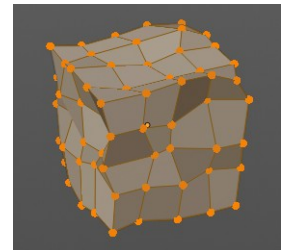
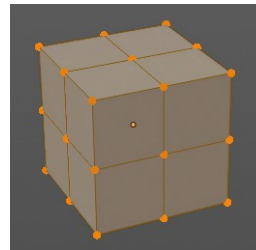

Last Operator Subdivide

Number of Cuts

The number of cuts defines the amount of subdivisions.

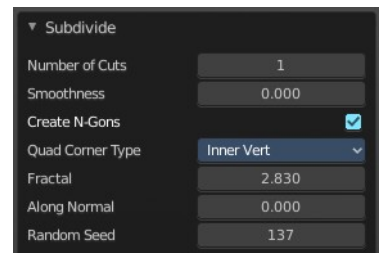

Smoothness

This value defines how smooth the subdivision result is. From flat to bent.

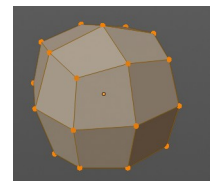

Create N-Gons

Create N-Gons if required. Else subdividing N-Gons creates Tris.

Quad Corner Type

Adjust the corner type.

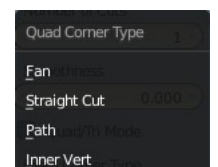

Fractal

Randomize the selected vertices.

Along Normal

When randomized, this value defines how strong the subdivision follows the normals of the initial vertices.

Random Seed

Randomizing value for fractal randomizing.

Extrude Faces

Extrudes out the selected faces into the face direction by moving the mouse. When it's more than one face, then the middle will be used.

Last Operator Extrude Region and Move

Flip Normals

Flips the normals of the extruded faces.

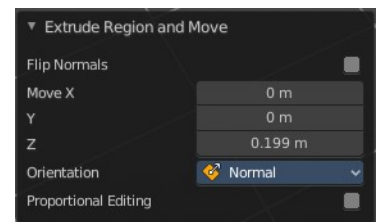

Move X, Y Z

The position. Attention, the actual world orientation and rotation does not matter here. It always starts with a value of zero, and moves relative to this zero then. For the actual location values have a look in the sidebar in the transform panel.

Orientation

The widget can have different orientations. The menu items should be self explaining.

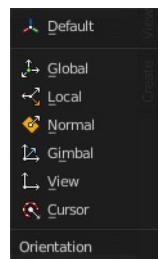

Proportional editing

Enables proportional editing. Activating proportional editing reveals further settings.

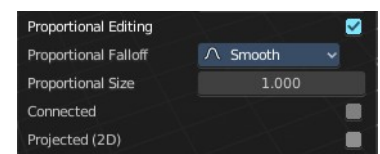

Proportional Falloff

Adjust the falloff methods.

Proportional Size

See and adjust the falloff radius.

Connected

The proportional falloff gets calculated for connected parts only.

Projected(2D)

The proportional falloff gets calculated in the screen space. Depth doesn't play a role. When it's in the radius, then it gets calculated.

Extrude Along Normals

Extrudes the selection along local normals.

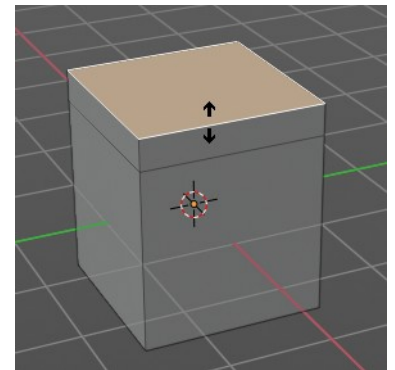

Shrink/Fatten: 0.3453, (R or Alt) Even Thickness OFF

Header Value

This tool works like a shrink fatten extrude. And so you will see a corresponding set of values in the header.

Last Operator Extrude Region and Shrink/Fatten

Flip Normals

Flips the normals of the extruded faces.

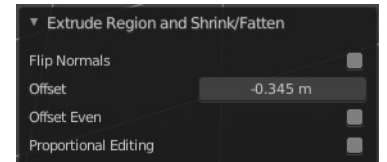

Offset

The current extrude amount.

Offset Even

Scales the offset to give more even thickness. Without this checked the farer away faces will have a bigger extrude amount.

Proportional editing

Enables proportional editing. Activating proportional editing reveals further settings.

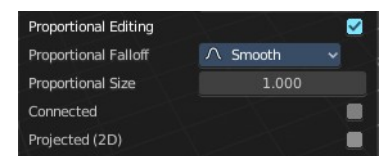

Proportional Falloff

Adjust the falloff methods.

Proportional Size

See and adjust the falloff radius.

Connected

The proportional falloff gets calculated for connected parts only.

Projected(2D)

The proportional falloff gets calculated in the screen space. Depth doesn't play a role. When it's in the radius, then it gets calculated.

Extrude Individual

Extrudes the selection along local normals of each individual face.

The method works the same in all Mesh select modes. Vertice, Edge and Face Mode.

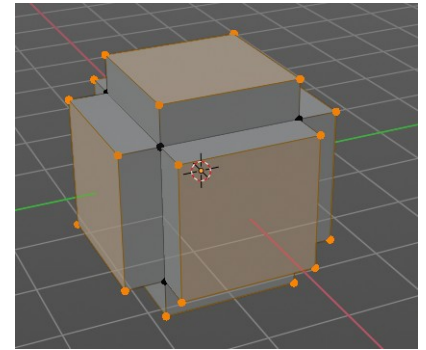

Shrink/Fatten: 0.3453, (R or Alt) Even Thickness OFF

Header Value

This tool works like a shrink fatten extrude. And so you will see a corresponding set of values in the header.

Last Operator Extrude *Individual Faces and Move*

Offset

The current extrude amount.

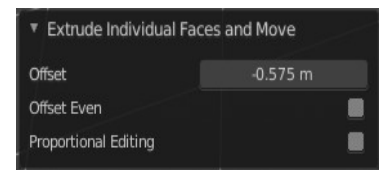

Offset Even

Scales the offset to give more even thickness. Without this checked the farer away faces will have a bigger extrude amount.

Proportional editing

Enables proportional editing. Activating proportional editing reveals further settings.

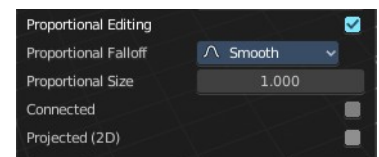

Proportional Falloff

Adjust the falloff methods.

Proportional Size

See and adjust the falloff radius.

Connected

The proportional falloff gets calculated for connected parts only.

Projected(2D)

The proportional falloff gets calculated in the screen space. Depth doesn't play a role. When it's in the radius, then it gets calculated.

Inset Faces

Inset insets edges into the selected faces. Think of it as an extrude inwards the face.

Activate the tool, drag the mouse. But carefully. The control is not the best. You better adjust the amount in the last operator.

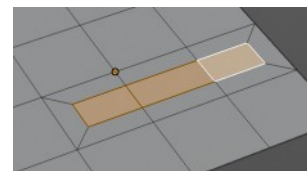

Last Operator Inset Faces

Boundary

With Boundary ticked you will get the connect edges in the corners. Without the edges ends straight.

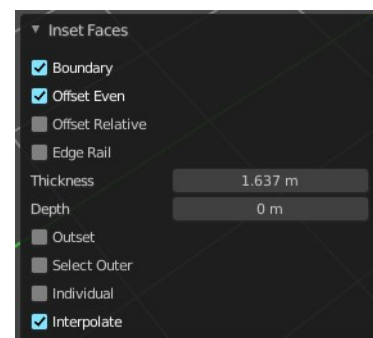
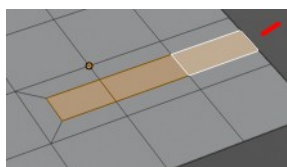

Offset Even

Scales the offset to give more even thickness.

Offset Relative

Scales the offset by surrounding geometry.

Edge Rail

Inset the region along existing edges.

Thickness

Thickness adjusts the thickness of the inset geometry.

Depth

With depth you can bevel the inset geometry. It is then not longer co planar to the initial face.

Outset

With outset ticked the Inset will not extrude inwards but outwards.

Select Outer

With Select Outer the outer ring will be selected after the Inset.

Individual

Inset every face individually.

Interpolate

Blend Face Data across the inset.

Bridge Faces

The Bridge Faces tool bridges selected faces, and adds polygons between them. You need to have at least two faces selected.

This tool is basically the Bridge Edge Loops tool, just that it operates in Face mode.

Note that this tool just shows when you are in Face Select Mode.

Last Operator Bridge Edge loops

Connect Loops

Choose the method how to deal with bridging multiple loops.

Merge

With merge ticked it will not create a bridge face, but merge the selected edges.

Merge Factor

The merge factor determines at which distance between the selected edges the merge happens. 0.5 is the middle of the selected edges.

Twist

The twist offset for closed loops.

Number of Cuts

Adds cuts to the bridge face.

Interpolation

Choose the interpolation mode for the cuts.

Smoothness

Adjust the smoothness for the cuts.

Profile Factor

Adjust the profile factor for the cuts.

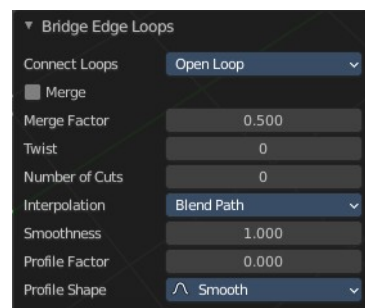

Profile shape

Adjust the profile shape for the cuts.

Poke Faces

Splits the selected faces to create a triangulated geometry.

Last Operator Poke Faces

Poke Offset

Normally the center vertice of the poke operation is planar with the rest. Adjust an offset.

Offset Relative

Scale the offset by surrounding geometry.

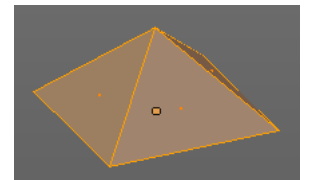
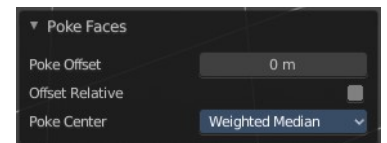
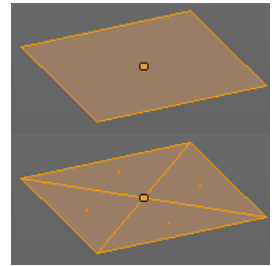

Poke Center

Poke Center is a drop-down box choose what the center of the poke operation should be. You can choose between weighted mean, mean and bounds.



UV Unwrap Faces submenu

The UV menu from the header.

Here you find the UV mapping methods and some further functionality. You use it best in the U Editing layout. There you can see the result in the UV Editor then.

The UV menu is just available for Mesh objects

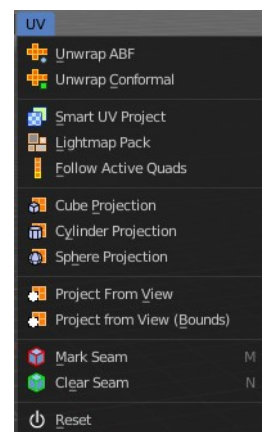

Unwrap ABF

Unwrap ABF unwraps the selected geometry with the method Angle based. ABF stands for Angle Based Flattening. ABF can give a bit better result than LSCM when unwrapping organic shapes.

Unwrap Conformal

Unwrap Conformal unwraps the selected geometry with the method LSCM, which is the short for Least Square Conformal Mapping. LSCM can give a bit better results than ABF with geometric shapes.

Last Operator Unwrap

Unwrap ABF and Unwrap LSCM shares the same Last Operator.

Method

Method is a drop down box where you can choose between Unwrap method Angle Based and Conformal.

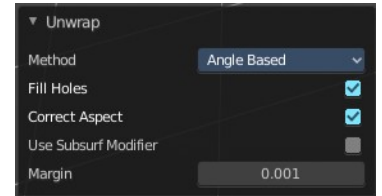

Fill Holes

Fill holes in the mesh before unwrapping.

Correct Aspect

Take the Image Aspect Ratio into account.

Use Subsurf Modifier

Unwraps an existing Subsurf Modifier. You need to add a Subsurf Modifier first.

Margin

The distance between the single UV patches.

Smart UV Project

Smart UV Project projects the UV mapping from different angles.

Smart UV Project Settings dialogue

Angle Limit

The Angle Limit defines after which angle the mapping happens from the next side. With an angle of 66 you have around six sides to map from. The calculation is $360/66$.

Island Margin

Island Margin defines the distance between the UV patches.

Area Weight

Weight Projection Vector by faces with larger areas.

Correct Aspect

Take the Image Aspect Ratio into account.

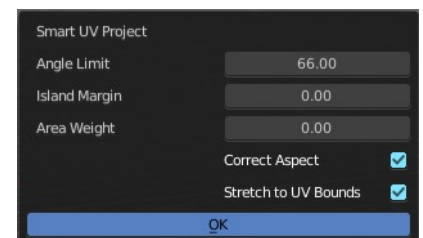

Last Operator Smart UV Project

The Last Operator for Smart UV Project contains the same settings than the Smart UV Project Settings dialogue.

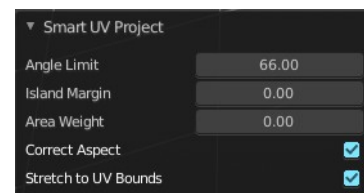

Light map Pack

Light map Pack maps each face individually, and puts the result into the UV space. Without margin.

Light map Pack has no Last Operator.

Settings

Selection

Selection is a drop-down box where you can choose what will be packed.

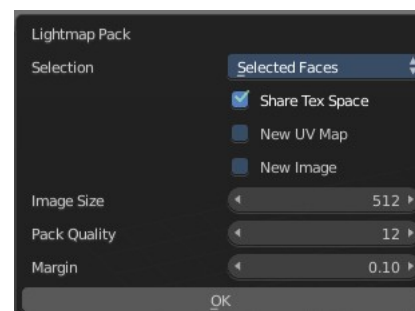

Share Tex Space

Map all objects into one light map.

New UV Map

Create a new UV map for every new mesh.

New Image

Assign new Image to every new mesh.

Image Size

The size for new images.

Pack Quality

The pack quality.

Margin

The distance between the single UV patches.

Follow Active Quads

Follow Active quads maps UV coordinates starting from an active face, and maps all adjacent faces in quad shape then. This way you can for example unwrap a pipe or a road. You first need to have a face selected. Then select everything. And then click at Follow Active Quads.

Settings

Edge Length Mode

Edge Length Mode is a drop-down box where you can choose the Length method.

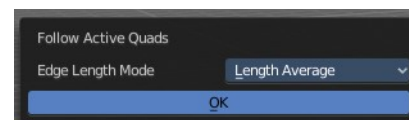

Last Operator Follow Active Quads

The Last Operator contains the same settings than the Settings dialogue.

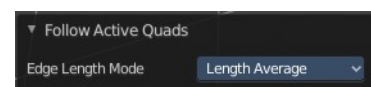

Cube Projection

Cube Projection maps the mesh from six sides, means cubic.

Last Operator Cube Projection

Cube Size

Cube Size defines the size of the UV mesh in the UV space.

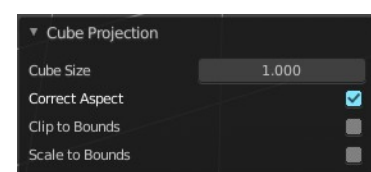

Correct Aspect

Take Image Aspect ratio into account.

Clip to Bounds

Clip UV Coordinates to bounds after unwrapping.

Scale to Bounds

Scale UV Coordinates to bounds after unwrapping.

Cylinder Projection

Cylinder Projection tries to map the geometry cylindric.

Last Operator Cylinder Projection

Direction

Direction is a drop-down box where you can choose in which direction the cylindric projection will be mapped.

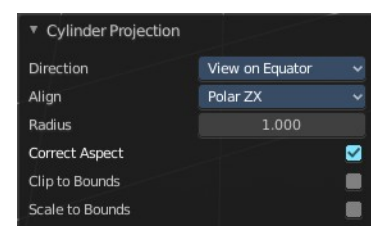

Align

Align is a drop-down box where you can choose the Align method.

Radius

Radius defines the Polar size of the UV mesh in the UV space.

Correct Aspect

Take Image Aspect ratio into account.

Clip to Bounds

Clip UV Coordinates to bounds after unwrapping.

Scale to Bounds

Scale UV Coordinates to bounds after unwrapping.

Sphere Projection

Sphere Projection tries to map the geometry spherical.

Last Operator Sphere Projection

Direction

Direction is a drop-down box where you can choose in which direction the spherical projection will be mapped.

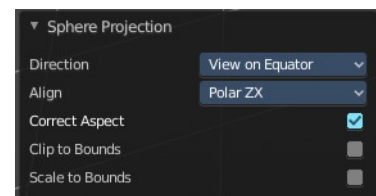

Align

Align is a drop-down box where you can choose the Align method.

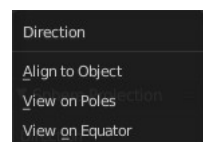

Correct Aspect

Take Image Aspect ratio into account.

Clip to Bounds

Clip UV Coordinates to bounds after unwrapping.



Scale to Bounds

Scale UV Coordinates to bounds after unwrapping.

Project from View

Project from View projects the UV from the current 3D view.

Last Operator Project from View

Orthographic

User orthographic projection.

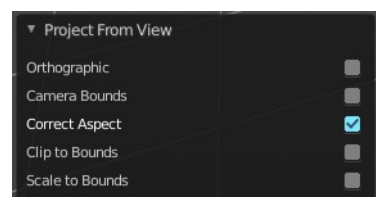

Camera Bounds

Map UV's to the camera region taking resolution and aspect into account.

Correct Aspect

Take Image Aspect ratio into account.

Clip to Bounds

Clip UV Coordinates to bounds after unwrapping.

Scale to Bounds

Scale UV Coordinates to bounds after unwrapping.

Project from View (Bounds)

Project from View projects the UV from the current 3D view.

Same as Project from View, but with Scale to Bounds ticked in the Last operator. And so it scales to the bounds.

Mark Seam

The unwrap algorithms Angle based and Conformal requires to have edges marked as seams. Think of it as a cutting pattern for a trouser for example. Such a trouser is also made of fabric patterns.

Same goes for the UV patches when you use Angle based or conformal unwrapping. You need to cut your mesh into parts and mark edges as seams, so that the algorithm knows where the seams are.

Mark seam marks the currently selected edge(s) as a seam. Seam edges will be displayed as red in the 3D viewport.

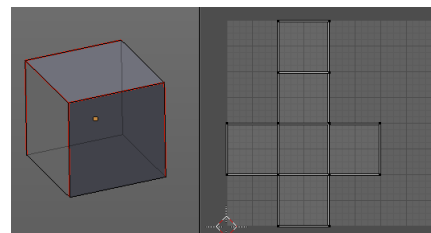

Clear Seam

Clear seam removes the seam from the currently selected edge(s).

Reset

Resets the UV Projection.

Triangulate Faces

Triangulate Faces triangulates the faces of the selected geometry.

Last Operator Triangulate Faces

Quad Method

Choose how quads should be triangulated.

Shortest diagonal

Splits the quads based on their distance between vertices.

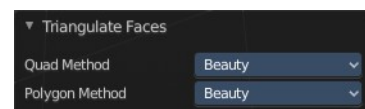
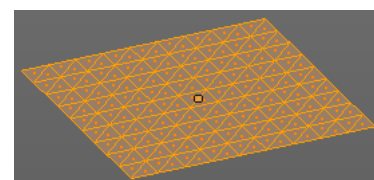

Fixed Alternate

Splits the quads on the second and fourth vertice.

Fixed

Splits the quads on the first and third vertice.

Beauty

Tries to optimize the triangulation.

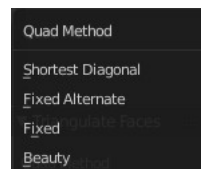

Polygon Method

Choose how N-Gons should be triangulated.

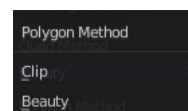

Clip

Splits the polygons with an ear clipping algorithm.

Beauty

Tries to optimize the triangulation.

Tris to Quads

Tris to quads tries to convert triangulated geometry back to a quad geometry by removing the edges inside of the quads.

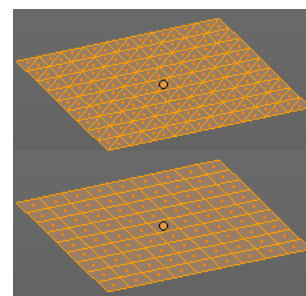

Last Operator Tris to Quads

Max Face Angle

Adjust the threshold to adjacent triangles.

Max Shape Angle

Adjust the shape angle limit.

Compare UV's

Takes the UV patches for the calculation into account. Border geometry will not be calculated.

Compare VCols

Takes the Vertex colors for the calculation into account. Border geometry will not be calculated.

Compare Seam

Takes the Vertex colors for the calculation into account. Border geometry will not be calculated.

Compare Sharp

Takes the as sharp marked edges for the calculation into account. Border geometry will not be calculated.

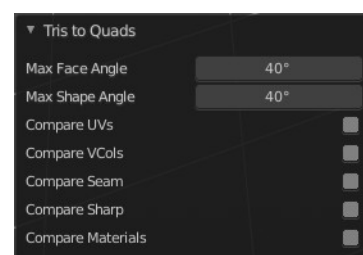

Compare Materials

Takes the Materials colors for the calculation into account. Border geometry will not be calculated.

Shade Smooth

Sets the shading for the object to smooth. Flat means that every face of the object shows facettet, with a sharp edge. Smooth means that the edges are not longer to see.

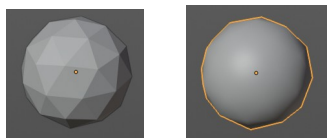

Shade Flat

Sets the shading for the object to flat. Flat means that every face of the object shows facettet, with a sharp edge. Smooth means that the edges are not longer to see.

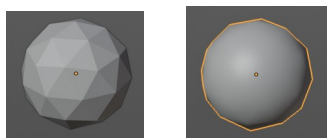

Un-Subdivide

Decimates the geometry by trying to make one quad out of four quads. But can also end in Tris where this is not possible.

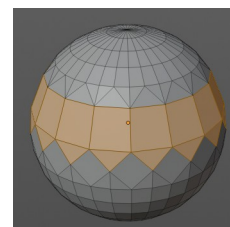

Last Operator Un-Subdivide

Iterations

Number of iterations. This means how deep the calculation should go. One level of SDS, two levels, three levels, etc. . Down to the point where you cannot decimate any geometry anymore.

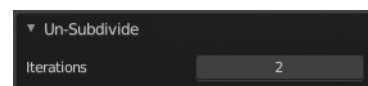

Split

Splits the edges between the selected vertices. It creates two edges out of one. And splits the edge by that.

Separate submenu

Separate separates the selected geometry, and creates a new object. The geometry becomes uneditable, since it is now a new object. You will have to leave the Edit mode, select the new object, and re-enter Edit mode when you want to edit it.

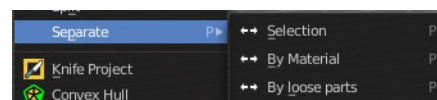

Selection

Selection separates the current selection.

By Material

By Material separates all geometry that has the same material than the current selection.

By Loose Parts

By Loose parts separates all geometry that is connected by edges to the current selection.

Dissolve Faces

Dissolves the selected faces, which unions the involved faces to one.

Last Operator Dissolve Vertices

Dissolve Verts

Dissolve remaining vertices.

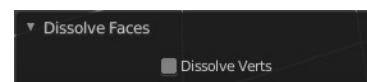

Delete Faces

Deletes the selected faces.

7.0.5 Editors - 3D View - Mesh Object - Sculpt Mode - Brushes context menus

Brushes context menus.....	1
Radius.....	1
Size Pressure.....	1
Use Unified Radius.....	2
Strength.....	2
Size Pressure.....	2
Use Unified Radius.....	2
Auto smooth.....	2
Tablet Pressure.....	2
Plane Offset.....	2
Distance.....	2
Height.....	2
Magnify.....	3
Pinch.....	3
Normal Weight.....	3
Magnify.....	3
Rake.....	3



7.0.5 Editors - 3D Viewport - Mesh Object - Sculpt Mode - Brushes context menus

Brushes context menus

Call this menu with double right click in the 3D viewport. You need to be in Sculpt mode with a mesh object.

In Sculpt mode you will call a context menu with the sliders from the Brush settings. The content depends of the chosen brush. Every brush has different settings. We just cover the usual ones here. For the brush specific settings see the chapter Editors - 3D View - Tool Shelf - Mesh - Sculpt Mode

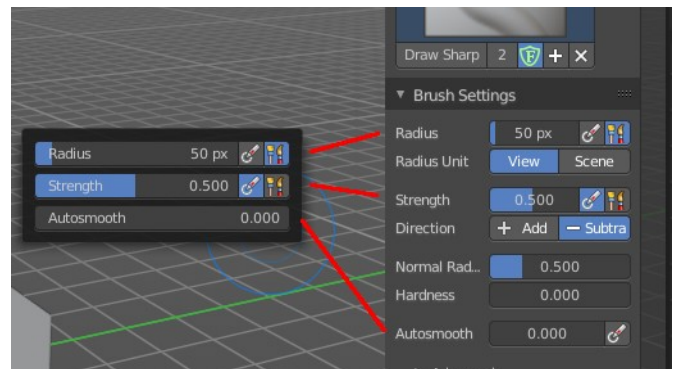

Radius

The Radius edit box allows you to adjust the radius of the brush.

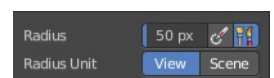

Size Pressure

The first button behind the edit box enables tablet pressure sensitivity for radius.

Use Unified Radius

The second button behind the edit box enables global radius size. Any modification at the radius will also modify the radius value for other paint tools.

Strength

The Strength edit box allows you to adjust the strength of the brush.



Size Pressure

The first button behind the edit box enables tablet pressure sensitivity for radius.

Use Unified Radius

The second button behind the edit box enables global radius size. Any modification at the radius will also modify the radius value for other paint tools.

Auto smooth

The auto smooth edit box allows you to adjust the amount of smoothing that gets automatically applied to each stroke.

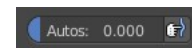

Tablet Pressure

The button behind the edit box enables tablet pressure sensitivity for auto smooth.

Plane Offset

Clay brush setting. Adjust the plane on which the brush acts towards or away from the objects surface. Sculpting with the Clay brush happens in a plane defined by the view you are in and the first vertices hit by the brush.



Distance

Adjust the plane trim distance.



Height

Layer brush setting. The height that can be affected by the layer brush.

Magnify



Blob Brush setting. The Crease Brush Pinch Factor.

Pinch



Crease Brush setting. The Crease Brush Pinch Factor.

Normal Weight



Various brushes like Grab or Elastic Deform. How much grab will pull vertexes out of surface during grab.

Magnify



Blob Brush setting. The Crease Brush Pinch Factor.

Rake



Snake Hook brush setting. How much grab will follow cursor rotation.

7.0.6 Editors - 3D Viewport - Mesh Object - Vertex Paint Mode - Brushes context menus

Table of content

Brushes context menus.....	1
Color dialog.....	1
Blend.....	2
Radius.....	2
Size Pressure.....	2
Use Unified Radius.....	2
Strength.....	2
Size Pressure.....	2
Use Unified Radius.....	2

Brushes context menus

Call this menu with double right click in the 3D viewport. You need to be in Vertex Paint mode with a mesh object.

In Vertex Paint mode you will call a context menu with the sliders from the Brush settings and the color dialog.

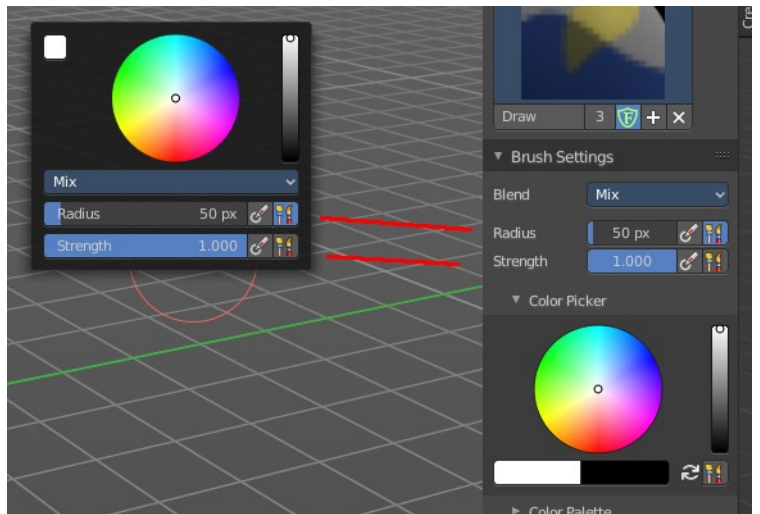

Color dialog

Define the color for your brush.

Up left is the active color. Change the color in the color dialog.

Blend

Define how the stroke will blend. You can choose between various blend modes.

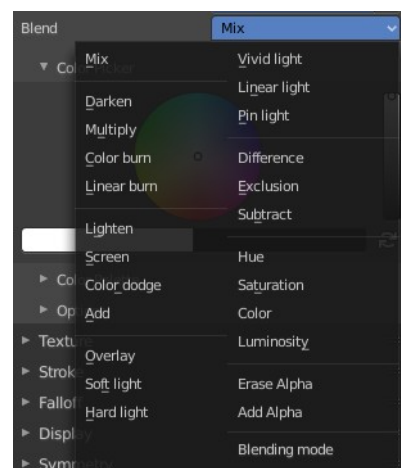

Radius

The Radius edit box allows you to adjust the radius of the brush.

Size Pressure

The first button behind the edit box enables tablet pressure sensitivity for radius.

Use Unified Radius

The second button behind the edit box enables global radius size. Any modification at the radius will also modify the radius value for other paint tools.

Strength

The Strength edit box allows you to adjust the strength of the brush.

Size Pressure

The first button behind the edit box enables tablet pressure sensitivity for radius.

Use Unified Radius

The second button behind the edit box enables global radius size. Any modification at the radius will also modify the radius value for other paint tools.

7.0.7 Editors - 3D Viewport - Mesh Object - Weight Paint Mode - Brushes context menus

Table of content

Brushes context menus.....	1
Weight.....	1
Size Pressure.....	1
Radius.....	1
Size Pressure.....	1
Use Unified Radius.....	2
Strength.....	2
Size Pressure.....	2
Use Unified Radius.....	2

Brushes context menus

Call this menu with double right click in the 3D viewport. You need to be in Weight Paint mode with a mesh object.

In Weight Paint mode you will call a context menu with the sliders from the Brush settings.

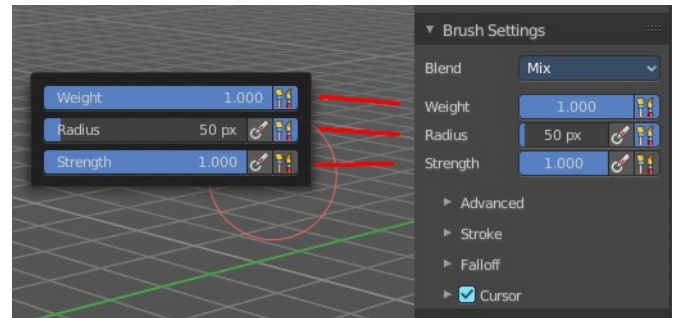

Weight

Adjust the strength of the weight painting.

Size Pressure

The first button behind the edit box enables tablet pressure sensitivity for radius.

Radius

The Radius edit box allows you to adjust the radius of the brush.

Size Pressure

The first button behind the edit box enables tablet pressure sensitivity for radius.

Use Unified Radius

The second button behind the edit box enables global radius size. Any modification at the radius will also modify the radius value for other paint tools.

Strength

The Strength edit box allows you to adjust the strength of the brush.

Size Pressure

The first button behind the edit box enables tablet pressure sensitivity for radius.

Use Unified Radius

The second button behind the edit box enables global radius size. Any modification at the radius will also modify the radius value for other paint tools.

7.0.8 Editors - 3D Viewport - Mesh Object - Texture Paint Mode - Brushes context menus

Table of content

Brushes context menus.....	1
Radius.....	1
Size Pressure.....	1
Use Unified Radius.....	1
Strength.....	1
Size Pressure.....	1
Use Unified Radius.....	2
Color dialog.....	2
Blend.....	2

Brushes context menus

Call this menu with double right click in the 3D viewport. You need to be in Vertex Paint mode with a mesh object.

In Vertex Paint mode you will call a context menu with the sliders from the Brush settings

And the fill tool comes with a color dialog.

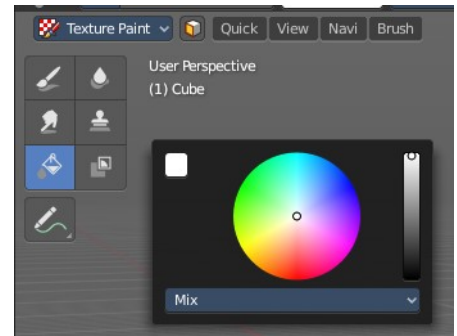
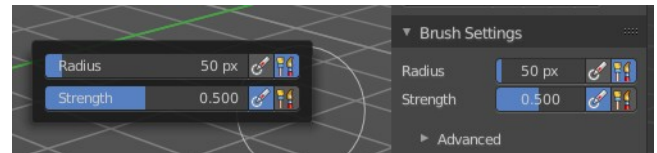

Radius

The Radius edit box allows you to adjust the radius of the brush.

Size Pressure

The first button behind the edit box enables tablet pressure sensitivity for radius.

Use Unified Radius

The second button behind the edit box enables global radius size. Any modification at the radius will also modify the radius value for other paint tools.

Strength

The Strength edit box allows you to adjust the strength of the brush.

Size Pressure

The first button behind the edit box enables tablet pressure sensitivity for radius.

Use Unified Radius

The second button behind the edit box enables global radius size. Any modification at the radius will also modify the radius value for other paint tools.

Color dialog

Define the color for the fill brush.

Up left is the active color. Change the color in the color dialog.

Blend

Define how the stroke will blend. You can choose between various blend modes.

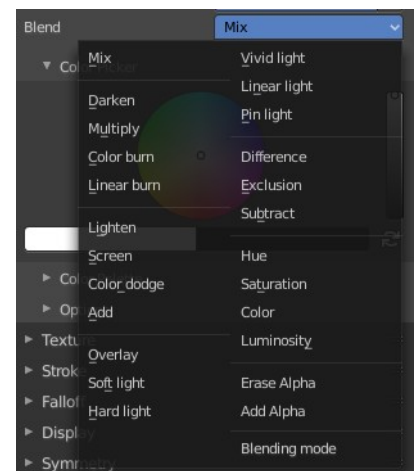



7.0.9 Editors - 3D Viewport - Curve + Surface Object - Edit Mode - Curves context menus

Table of content

Curve context menus.....	3
Subdivide.....	3
Last Operator Subdivide.....	3
Number of Cuts.....	3
Extrude Curve.....	3
Last operator Extrude Curve and Move.....	3
Mode.....	4
Move X , Y , Z.....	4
Orientation.....	4
Proportional editing.....	4
Proportional Falloff.....	4
Proportional Size.....	4
Connected.....	4
Projected(2D).....	4
Make Segment.....	4
Duplicate.....	4
Last Operator Duplicate.....	5
Move X , Y , Z.....	5
Orientation.....	5
Proportional editing.....	5
Proportional Falloff.....	5
Proportional Size.....	5
Connected.....	5
Projected(2D).....	5
Radius.....	5
Last Operator Shrink/Fatten.....	5
Offset.....	6
Offset Even.....	6
Proportional editing.....	6
Proportional Falloff.....	6
Proportional Size.....	6
Connected.....	6
Projected(2D).....	6
Tilt.....	6
Last Operator Tilt.....	6
Angle.....	6
Proportional editing.....	6
Proportional Falloff.....	6
Proportional Size.....	7
Connected.....	7
Projected(2D).....	7
Clear Tilt.....	7
Smooth.....	7
Smooth Curve Tilt.....	7
Smooth Curve Radius.....	7

Mirror.....	7
Interactive Mirror.....	7
X Global, Y Global etc.....	7
Last Operator Mirror.....	8
Orientation.....	8
Constraint Axis.....	8
Proportional editing.....	8
Proportional Falloff.....	8
Proportional Size.....	8
Connected.....	8
Projected(2D).....	8
Snap.....	8
Last Operator Snap.....	8
Offset.....	8
Set Spline Type.....	9
Last Operator Set Spline Type.....	9
Type.....	9
Handles.....	9
Set Handle Type.....	9
Auto.....	9
Vector.....	9
Align.....	9
Free.....	9
Toggle Free/Aligned.....	9
Last Operator Set Handle Type.....	9
Type.....	9
Toggle Cyclic.....	10
Last Operator Toggle Cyclic.....	10
Direction.....	10
Switch Direction.....	10
Recalc Normals.....	10
Last Operator Recalc Normals.....	10
Length.....	10
Set Goal Weight.....	10
Set Curve Radius.....	11
Split.....	11
Decimate Curve.....	11
Last Operator Decimate Curve.....	11
Ratio.....	11
Separate.....	11
Dissolve Vertices.....	11
1Delete Segment.....	11
Delete Point.....	12
Delete.....	12
Show/Hide.....	12
Show Hidden.....	12
Hide Selected.....	12
Last Operator Hide Selected.....	12
Unselected.....	12
Hide Unselected.....	12

Curve context menus

Call this menu with double right click in the 3D viewport. You need to be in Edit mode with a Curve or a Surface object.

With a surface object some options are greyed out.



Subdivide

Subdivides the selected curve geometry, and adds more control points.

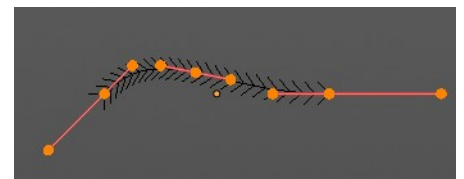
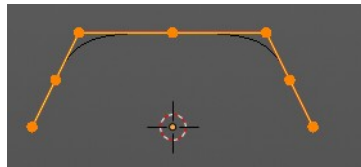

Last Operator Subdivide

Number of Cuts

Number of subdivision cuts.



Extrude Curve

Extrudes the selected curve point(s).

Last operator Extrude Curve and Move

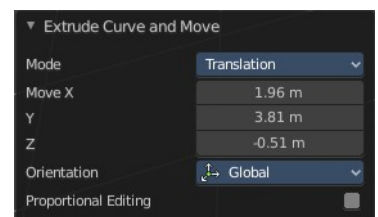

Mode

A drop-down box where you can choose between different extrude modes.

Default is Translation. Most other methods has no effect.



Move X , Y , Z

The position of the extruded point(s).

Orientation

Adjust the orientation of the extrusion. It usually starts with Normal.

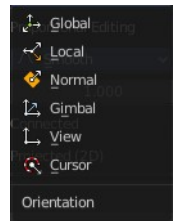

Proportional editing

Enables proportional editing. Activating proportional editing reveals further settings.

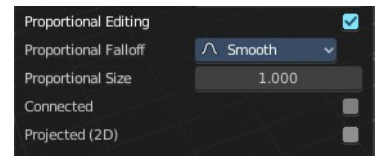

Proportional Falloff

Adjust the falloff methods.

Proportional Size

See and adjust the falloff radius.

Connected

The proportional falloff gets calculated for connected parts only.

Projected(2D)

The proportional falloff gets calculated in the screen space. Depth doesn't play a role. When it's in the radius, then it gets calculated.

Make Segment

Joins two curves by adding a segment between the end of the one and the beginning of the other. You can also create a closed curve that way.

Duplicate

Duplicates the current selection. This can be a single control point or a whole curve.

The copy sticks to the mouse until you release it. A Right click while moving will reset the position of the duplicate. The duplicated part will be part of the same object.

When you drag the duplicate around you will see the position values in the header.

Last Operator Duplicate

Move X , Y , Z

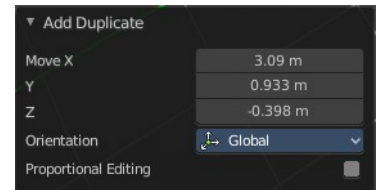

Orientation

Choose the orientation.

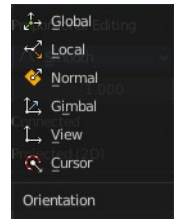

Proportional editing

Enables proportional editing. Activating proportional editing reveals further settings.

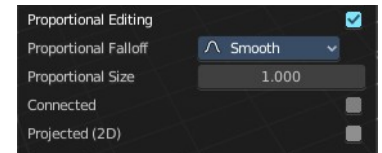

Proportional Falloff

Adjust the falloff methods.

Proportional Size

See and adjust the falloff radius.

Connected

The proportional falloff gets calculated for connected parts only.

Projected(2D)

The proportional falloff gets calculated in the screen space. Depth doesn't play a role. When it's in the radius, then it gets calculated.

Radius

Scales the selected geometry along its normals. Transform orientation and Pivot point gets ignored.

A positive value pushes the vertices outwards. A negative value pushes the vertices inwards.

Last Operator Shrink/Fatten

The Last Operator Shrink/Fatten panel gives you tools to adjust the Shrink/Fatten operation. Here you have numeric input for the strength and a few more options.

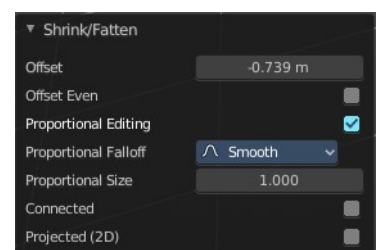

Offset

Offset is the strength of the offset for Shrink/Fatten.

Offset Even

Offset Even scales the selection to give more thickness in even areas.

Proportional editing

Enables proportional editing. Activating proportional editing reveals further settings.

Proportional Falloff

Adjust the falloff methods.

Proportional Size

See and adjust the falloff radius.

Connected

The proportional falloff gets calculated for connected parts only.

Projected(2D)

The proportional falloff gets calculated in the screen space. Depth doesn't play a role. When it's in the radius, then it gets calculated.

Tilt

Modifies the Mean Tilt.

Activate the tool, and drag the mouse. You will see a value in the header now. The selected curve path will rotate by dragging the mouse.

The Tilt angle always starts at zero. It is relative. To modify the Mean Tilt use the edit box in the Transform panel.

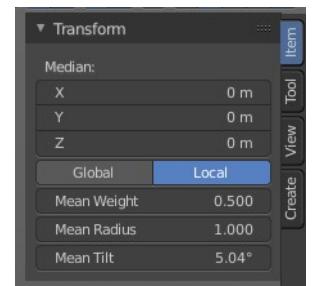

Last Operator Tilt

Angle

The Tilt angle.

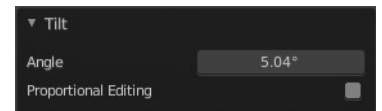

Proportional editing

Enables proportional editing. Activating proportional editing reveals further settings.

Proportional Falloff

Adjust the falloff methods.

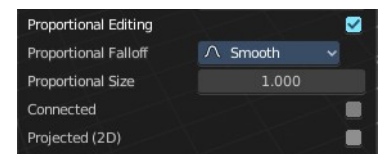

Proportional Size

See and adjust the falloff radius.

Connected

The proportional falloff gets calculated for connected parts only.

Projected(2D)

The proportional falloff gets calculated in the screen space. Depth doesn't play a role. When it's in the radius, then it gets calculated.

Clear Tilt

Sets the Mean Tilt to zero.

Smooth

Flattens the angles of the selected control point(s).

Smooth Curve Tilt

Smooths the curve tilt of the selected control point(s).

Smooth Curve Radius

Smooths the curve radius of the selected control point(s).

Mirror

Mirror mirrors the selected geometry along the defined axis.

Interactive Mirror

Mirror by hotkeys. You activate the tool, type in x for x global for example, or x x for x local. And the selection gets mirrored.



X Global, Y Global etc.

Mirrors the selection around the chosen axis.

Last Operator Mirror

The Last Operator Mirror panel gives you tools to adjust the mirror action.

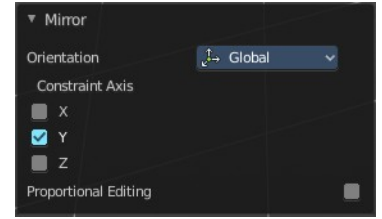

Orientation

Orientation is a drop-down box choose the type of orientation for the mirroring action.

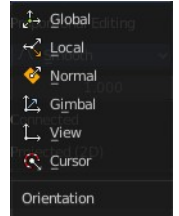

Constraint Axis

Constraint Axis gives you again the possibility to define the mirror axis. You can choose more than one axis here.

Proportional editing

Enables proportional editing. Activating proportional editing reveals further settings.

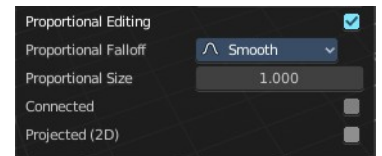

Proportional Falloff

Adjust the falloff methods.

Proportional Size

See and adjust the falloff radius.

Connected

The proportional falloff gets calculated for connected parts only.

Projected(2D)

The proportional falloff gets calculated in the screen space. Depth doesn't play a role. When it's in the radius, then it gets calculated.

Snap

Choose several methods to snap one element to another. The menu items should be self explaining.

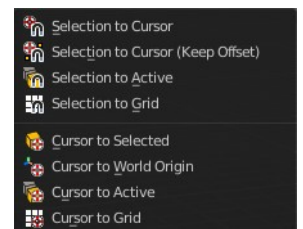

Last Operator Snap

Some snap operations shows a last operation panel, some not.

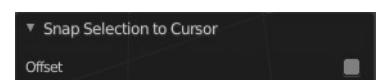

Offset

If the selection should snap as a whole, or if each individual element of the selection should snap.

Set Spline Type

With set Spline Type you can set the type of the curve.

Poly is a straight line between the control points. Bezier has curve handlers. A nurbs curve has a control cage.

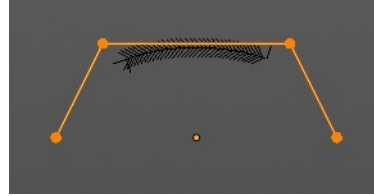
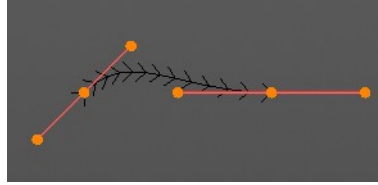
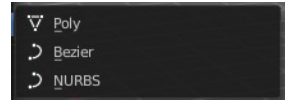

Last Operator Set Spline Type

Type

Type is a drop-down box choose the spline type

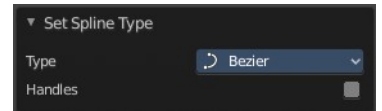

Handles

Use Handles when converting Bezier curves into polygons.

Set Handle Type

Handles defines the type of handle for the knots of the curve. You have the choice between Auto, Vector, Align and Free. And the Last Operator gives you a fifth possibility to toggle between Free and Align.

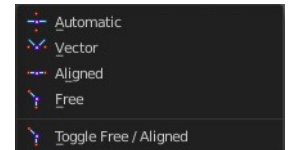

Auto

Auto aligns the handles automatically.

Vector

Set Handle type to Vector.

Align

Set Handle type to Align.

Free

Set Handle type to Free.

Toggle Free/Aligned

Toggle Free/Aligned.

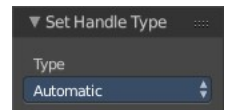

Last Operator Set Handle Type

Type

Type is a drop-down box where you can set the handle type. You have the choice between Auto, Vector, Align,



Free. And the fifth possibility toggles between Free and Align.

Toggle Cyclic

Toggle Cyclic closes or opens the curve.

Last Operator Toggle Cyclic

Direction

Direction is a drop-down box choose the direction in which the curve gets closed.

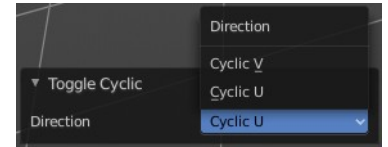

Switch Direction

Just for Bezier Curve object type. Surface Nurbs curves doesn't have a direction. Switches the direction in which the curve is pointing.

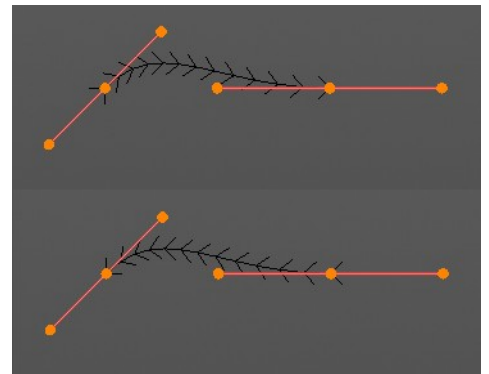

Recalc Normals

Recalculates the normals of the selected curve.

Last Operator Recalc Normals

Length

Recalculates the handle length too.

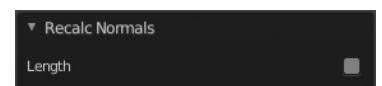

Set Goal Weight

Sets the curve's Weight for the selected control point to the specified value. If more than one control point is selected this will set the Mean Weight.

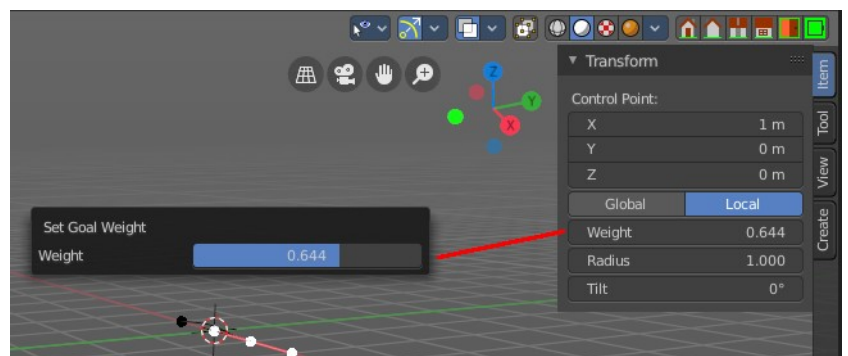

Set Curve Radius

Sets the curve radius for the selected curve point to the specified value.

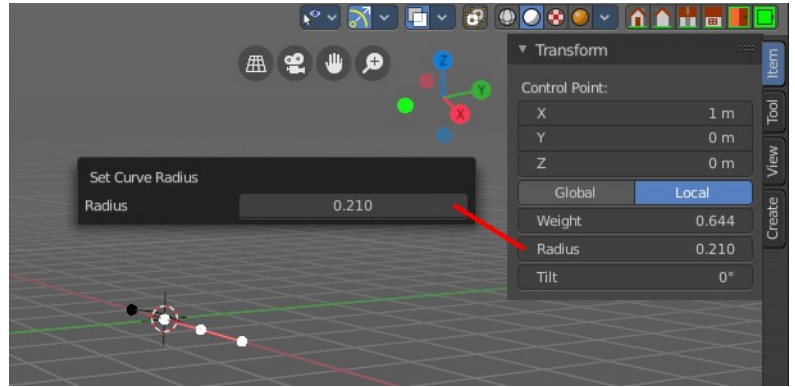

Split

Splits the curve at the selected control point(s). You need to select two control points to select the segment between it.

Decimate Curve

Decimates the currently selected geometry. It starts with a Ratio of 1. Which means no decimation. The lower the ratio the more decimation you will get.

Last Operator Decimate Curve

Ratio

Adjust the strength of decimation.

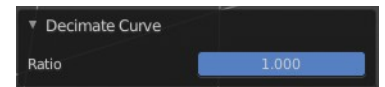

Separate

Separates the selected control points, and creates a new curve object out of it. You need to select two control points to select the segment between it.

Dissolve Vertices

Dissolves the selected vertices. When removing vertices in between then the curve stays intact and connected.

1Delete Segment

Removes the segment between the selected vertices.

Delete Point

Dissolves the selected vertices. When removing vertices in between then the curve stays intact and connected.



Delete

Deletes the current selection.

Show/Hide

Sub-menu with shows or hide selection, unselected or hidden operators.



Show Hidden

Makes all geometry in the scene visible again.

Hide Selected

Hides the selected geometry.

Last Operator Hide Selected

Unselected

Hides the not selected geometry.

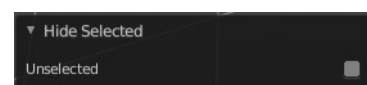

Hide Unselected

Hides the not selected geometry. The selected geometry stays visible.



7.1 Editors - 3D Viewport - Header

Table of content

Introduction.....	1
Header.....	2
Header right click menus.....	2
Editortype Menu.....	2

Introduction

The 3D View editor is the editor where you edit your 3D data. Here you can display and modify all the scene data like meshes, curves, metalballs, etc.

It has by default a grid in the middle. And you can navigate around in this view.

The 3D View has several areas. In this chapter we will cover the header area. Pink color.

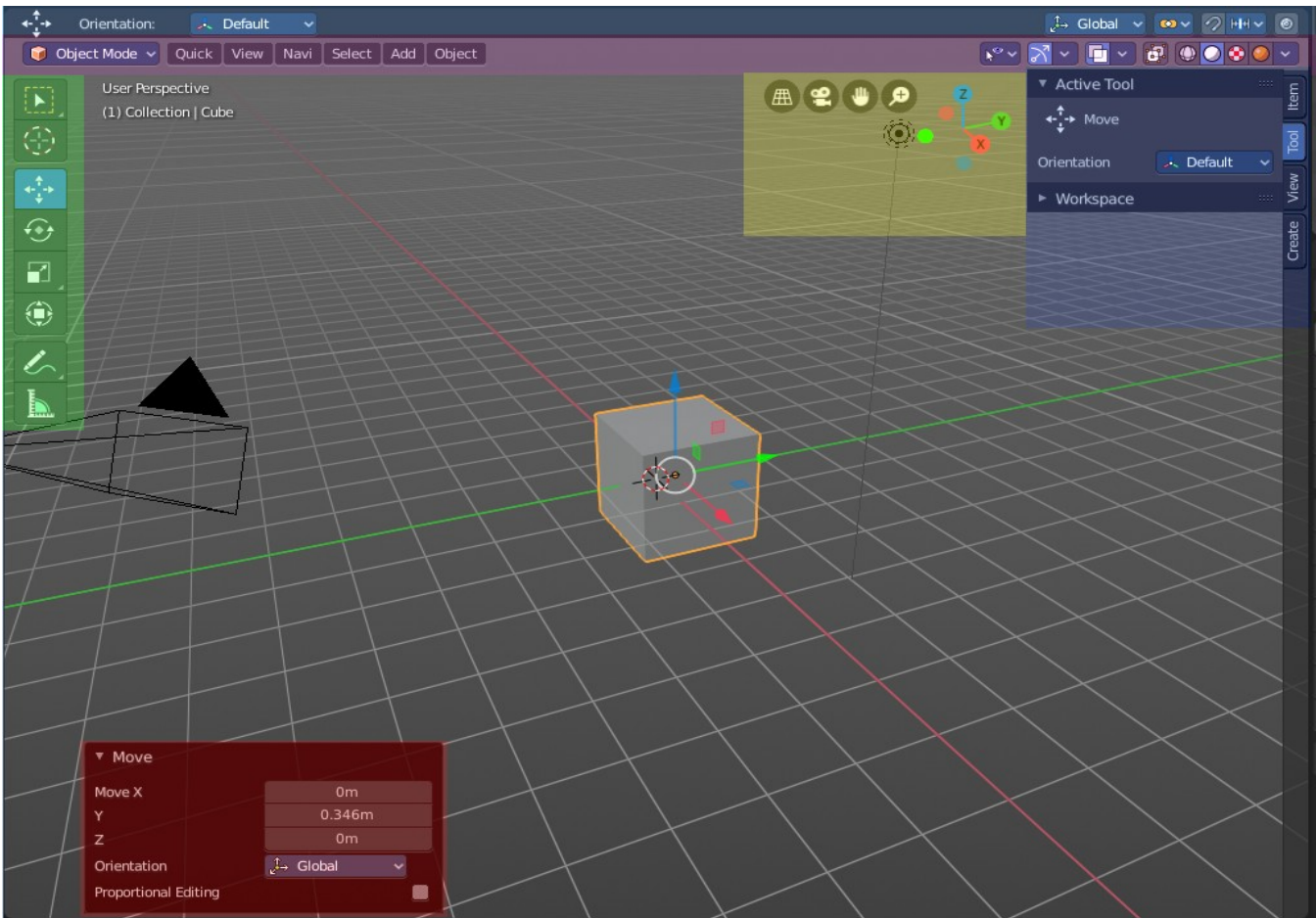

Header

The Header contains various menus, navigation elements and tools for the 3d view. This content vary, dependent of mode and object type. The Mesh menu just exists with a mesh object in Edit mode. The Object menu exists just in Object mode and so on.

The header is divided into three areas. Left is the mode drop down box. At the right of it is the text menus. And at the right side you will find some scene related settings.



When the Tool Settings are hidden, the area above the header, then you will also see some object related settings from there.



The header not only provides tools and menus. It is also the place where you will see specific informations when you perform an operation. When you move an object for example, then the menus hides, and you will see the actual transformation values in the header in real time.

Dx: -0.1421m Dy: 0.3069m Dz: 0.5101m (0.612m)

The text menus will be explained one by one and mode by mode in their own chapters.

Header right click menus

The general right click menu functionality is explained in chapter 6 Editors introduction.

Editortype Menu

Bforartists is made of several editor types. Headers can display a menu where you can switch to other editor types.

This menu is hidden by default. It is meant to edit the layouts, and should not be necessary for regular work. You can reveal it in the header right click menu.

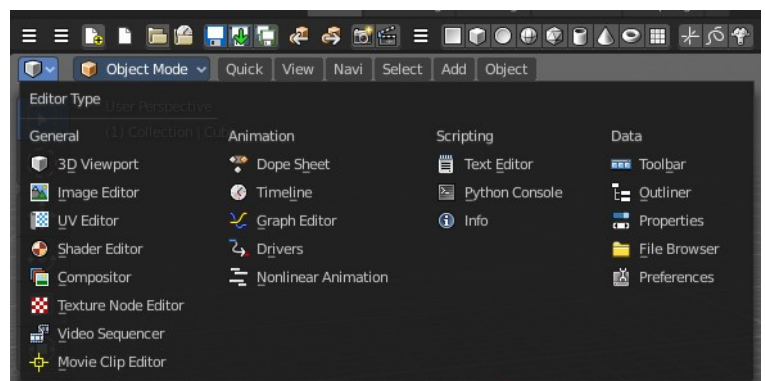

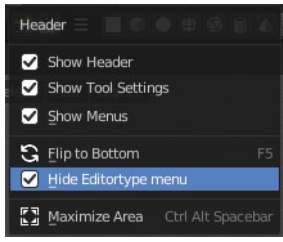



7.1.1 Editors - 3D Viewport - Header tools and Options

Table of content

Detailed Table of content.....	1
Introduction.....	11
Mode Drop-down Box.....	11
Mesh Object Sub Modes.....	12
Grease Pencil Sub Modes.....	15
Object settings.....	19
Object Types Visibility.....	25
Viewport Gizmo.....	25
Show Overlays - all modes.....	28
Show Overlays - Mesh Object - Edit Mode.....	32
Show Overlays - Mesh Object - Sculpt Mode.....	36
Show Overlays - Mesh Object - Vertex Paint Mode.....	36
Show Overlays - Mesh Object - Weight Paint Mode.....	36
Show Overlays - Mesh Object - Texture Paint Mode.....	37
Show Overlays - Hair Object - Sculpt Mode.....	37
Show Overlays - Pose Mode.....	38
Show Overlays - Grease Pencil.....	38
Viewport Shading.....	43
Align View Buttons.....	57
Grease Pencil - all modes - Layer Panel.....	57
Grease Pencil - Edit mode - Options Panel.....	59
Grease Pencil - Sculpt mode - Auto-masking Panel.....	59

Detailed Table of content

Detailed table of content

Detailed Table of content.....	1
Introduction.....	11
Mode Drop-down Box.....	11
Object Mode.....	11
Edit Mode.....	11
Sculpt Mode.....	11
Vertex Paint.....	11
Weight Paint.....	12
Texture Paint.....	12
Edit Strokes.....	12
Particle Edit.....	12
Draw.....	12
Mesh Object Sub Modes.....	12
Edit Mode - Mesh Select Modes.....	12
Vertex Paint - Mask and Vertex Selection.....	13
Paint Mask.....	13
Vertex Selection.....	13
Weight Paint - Mask and Vertex Selection.....	13

Paint Mask.....	14
Vertex Selection.....	14
Texture Paint - Mask Selection.....	14
Paint Mask.....	14
Particle Edit - Select Modes.....	15
Mesh Object with a particle system. You can just have one method active at a time.....	15
Path.....	15
Point.....	15
Tip.....	15
Grease Pencil Sub Modes.....	15
Edit Mode.....	15
Select Modes.....	15
Select Only Points.....	15
Select all Stroke Points.....	15
Select all Stroke Points between other strokes.....	16
Curve Editing.....	16
Curve Editing panel.....	16
Curve Resolution.....	16
Threshold.....	16
Corner Angle.....	16
Adaptive Resolution.....	16
Multi frame.....	16
Use Falloff.....	16
Sculpt Mode.....	16
Selection Mask.....	16
Multi frame.....	17
Use Falloff.....	17
View.....	17
Draw Mode.....	17
Multi frame.....	17
Origin.....	17
View.....	17
Use Guides.....	17
Circular.....	17
Radial.....	18
Angle.....	18
Parallel.....	18
Grid.....	18
Isometric.....	18
Use Snapping.....	18
Spacing.....	18
Reference Point.....	18
Draw Strokes on Back.....	18
Add Weight Data for new strokes.....	18
Use Additive Drawing.....	18
Automerge.....	18
Weight Paint Mode.....	19
Multi frame.....	19
Use Falloff.....	19
Vertex Paint Mode.....	19
Select Modes.....	19
Select Only Points.....	19
Select all Stroke Points.....	19

Select all Stroke Points between other strokes.....	19
Multi frame.....	19
Use Falloff.....	19
Object settings.....	19
Transform Orientations.....	20
View.....	20
Gimbal.....	20
Normal.....	20
Local.....	20
Global.....	20
Cursor.....	20
Parent.....	20
Create Orientation.....	21
Last Operator Create Orientation.....	21
Name.....	21
Use View.....	21
Use after creation.....	21
Overwrite Previous.....	21
Pivot Point.....	21
Only Origins.....	21
Snapping.....	22
Multiple Snap Targets.....	22
Snap With.....	22
Closest.....	22
Center.....	22
Median.....	22
Active.....	22
Snap to.....	23
Increment.....	23
Vertex.....	23
Edge.....	23
Face.....	23
Volume.....	23
Edge Center.....	23
Edge Perpendicular.....	23
Sbap Individual Elements to.....	23
Face Project.....	23
Face Nearest.....	23
Absolute Grid Snap.....	23
Snap Peel Object.....	23
Back face Culling.....	24
Align Rotation to Target.....	24
Affect.....	24
Proportional Editing.....	24
Settings.....	24
Proportional Size.....	24
Last Operator Proportional Editing.....	24
Proportional Editing.....	24
Proportional Falloff.....	25
Proportional Size.....	25
Connected.....	25
Projected(2D).....	25
Object Types Visibility.....	25

Viewport Gizmo.....	25
Show Gizmo.....	25
Gizmo Options.....	25
Viewport Gizmos.....	26
Navigate.....	26
Navigation Controls.....	26
3D Viewport Axis.....	26
Off.....	26
Simple Axis.....	26
Interactive Navigation.....	26
Active Tools.....	26
Active Object.....	26
Object Gizmos.....	27
Transformation Orientation.....	27
Move.....	27
Rotate.....	27
Scale.....	27
Empty.....	27
Image.....	27
Force Field.....	27
Light.....	27
Size.....	27
Look At.....	27
Camera.....	28
Lens.....	28
Focus Distance.....	28
Show Overlays - all modes.....	28
Guides.....	28
Grid.....	28
Floor.....	28
Axes.....	29
Scale.....	29
Subdivisions.....	29
Options.....	29
Text Info.....	29
Annotations.....	29
Statistics.....	29
3D Cursor.....	29
Objects.....	30
Extras.....	30
Relationship Lines.....	30
Outline Selected.....	30
Bones.....	30
Motion Paths.....	30
Origins.....	30
Origins(All).....	30
Geometry.....	30
Wire frame.....	31
Wireframe Threshold.....	31
Opacity.....	31
Face Orientation.....	31
Fade inactive Geometry.....	31
Motion Tracking.....	31

Camera Path.....	31
Marker Names.....	31
Track display type.....	31
Track size.....	31
Show Overlays - Mesh Object - Edit Mode.....	32
Mesh Edit Mode.....	32
Edges.....	32
Faces.....	32
Center.....	32
Creases.....	32
Sharp.....	32
Bevel.....	32
Seams.....	32
Developer.....	32
Indices.....	32
Shading.....	33
Hidden Wire.....	33
Vertex Groups Weights.....	33
Zero Weights.....	33
None.....	33
Active.....	33
All.....	33
Mesh Analysis.....	33
Overhang.....	33
Minimum/Maximum.....	33
Axis.....	33
Thickness.....	33
Minimum/Maximum.....	34
Samples.....	34
Intersections.....	34
Distortion.....	34
Minimum/Maximum.....	34
Sharp Edges.....	34
Minimum/Maximum.....	34
Measurement.....	35
Edge Length.....	35
Edge Angle.....	35
Face Area.....	35
Face Angle.....	35
Normals.....	35
Display vertex normals.....	35
Display split normals.....	35
Display normals.....	35
Constant Screen Size Normals.....	35
Size.....	35
Freestyle.....	36
Edge Marks.....	36
Face Marks.....	36
Show Overlays - Mesh Object - Sculpt Mode.....	36
Show Mask.....	36
Show Face Sets.....	36
Show Overlays - Mesh Object - Vertex Paint Mode.....	36
Opacity.....	36

Show Wire.....	36
Show Overlays - Mesh Object - Weight Paint Mode.....	36
Opacity.....	36
Zero Weights.....	36
None.....	36
Active.....	37
All.....	37
Show Weight Contours.....	37
Show Wire.....	37
Show Bone X Ray.....	37
Show Overlays - Mesh Object - Texture Paint Mode.....	37
Stencil Opacity.....	37
Show Overlays - Hair Object - Sculpt Mode.....	37
Selection Opacity.....	37
Curves Cage.....	37
Cage Opacity.....	37
Show Overlays - Pose Mode.....	38
Show Bone X Ray.....	38
Opacity.....	38
Bone Wireframe Opacity.....	38
Show Overlays - Grease Pencil.....	38
In Object Mode.....	38
Onion Skin.....	38
Canvas.....	38
Canvas X Ray.....	38
Fade Layers.....	39
Fade Objects.....	39
Fade Grease Pencil Objects.....	39
In Edit Mode.....	39
Onion Skin.....	39
Canvas.....	39
Canvas X Ray.....	39
Fade Layers.....	39
Fade Objects.....	39
Fade Grease Pencil Objects.....	40
Edit Lines.....	40
Stroke Direction.....	40
Only in multi frame.....	40
Material Name.....	40
Vertex Opacity.....	40
In Sculpt and Weight paint Mode.....	40
Onion Skin.....	40
Canvas.....	40
Canvas X Ray.....	40
Fade Layers.....	40
Fade Objects.....	41
Fade Grease Pencil Objects.....	41
Edit Lines.....	41
Only in multi frame.....	41
Vertex Opacity.....	41
In Draw Mode.....	41
Onion Skin.....	41
Canvas.....	41

Canvas X Ray.....	41
Fade Layers.....	41
Fade Objects.....	42
Fade Grease Pencil Objects.....	42
Vertex Opacity.....	42
In Vertex Paint mode.....	42
Onion Skin.....	42
Use Grid.....	42
Canvas X Ray.....	42
Fade Layers.....	42
Fade Objects.....	42
Fade Grease Pencil Objects.....	42
Edit Lines.....	43
Only in multi frame.....	43
Vertex Opacity.....	43
Opacity.....	43
Viewport Shading.....	43
Show X Ray.....	43
Viewport Shading.....	43
Wire frame.....	43
Solid.....	43
Material.....	43
Rendered.....	43
Viewport Shading Settings.....	44
Viewport Shading Settings with Wire frame.....	44
Color.....	44
Single.....	44
Object.....	44
Random.....	44
Background.....	44
Theme.....	44
World.....	44
Viewport.....	44
Options.....	44
Show X Ray.....	44
X Ray Alpha.....	45
Outline.....	45
Outline Color.....	45
Viewport shading Settings with Solid.....	45
Lighting.....	45
Studio.....	45
World Space Lighting.....	45
Rotation.....	45
Show Light Preferences.....	45
Color.....	46
Material.....	46
Object.....	46
Vertex.....	46
Single.....	46
Random.....	46
Texture.....	46
Background.....	46
Theme.....	46

World.....	46
Viewport.....	46
Options.....	46
Back face Culling.....	46
Show X Ray.....	47
X Ray Alpha.....	47
Shadow.....	47
Shadow Intensity.....	47
Light Settings.....	47
Light Direction.....	47
Shadow Shift.....	47
Shadow Focus.....	47
Cavity.....	47
Type.....	47
World.....	47
World Space / Ridge Valley.....	47
Shading Options.....	47
Screen.....	48
Screen Space / Ridge Valley.....	48
Both.....	48
Depth of Field.....	48
Outline.....	48
Outline Color.....	48
Specular Lighting.....	48
Matcap.....	48
Show Light Preferences.....	49
Flip Matcap.....	49
Color.....	49
Material.....	49
Object.....	49
Vertex.....	49
Single.....	49
Random.....	49
Texture.....	49
Background.....	49
Theme.....	49
World.....	49
Viewport.....	50
Options.....	50
Back face Culling.....	50
Show X Ray.....	50
X Ray Alpha.....	50
Shadow.....	50
Shadow Intensity.....	50
Light Settings.....	50
Light Direction.....	50
Shadow Shift.....	50
Shadow Focus.....	50
Cavity.....	51
Type.....	51
World.....	51
World Space / Ridge Valley.....	51
Shading Options.....	51

Screen.....	51
Screen Space / Ridge Valley.....	51
Both.....	51
Outline.....	51
Outline Color.....	51
Specular Lighting.....	51
Flat.....	51
Color.....	51
Material.....	52
Object.....	52
Vertex.....	52
Single.....	52
Random.....	52
Texture.....	52
Background.....	52
Theme.....	52
World.....	52
Viewport.....	52
Options.....	52
Back face Culling.....	52
Show X Ray.....	52
X Ray Alpha.....	53
Shadow.....	53
Shadow Intensity.....	53
Light Settings.....	53
Light Direction.....	53
Shadow Shift.....	53
Shadow Focus.....	53
Cavity.....	53
Type.....	53
World.....	53
World Space / Ridge Valley.....	53
Shading Options.....	53
Screen.....	53
Screen Space / Ridge Valley.....	53
Both.....	54
Outline.....	54
Outline Color.....	54
Specular Lighting.....	54
Viewport Shading with Material Preview.....	54
Lighting.....	54
Scene Lights.....	54
Scene World.....	54
hdr file browser.....	54
Show light preferences.....	55
World Space Lighting.....	55
Rotation.....	55
Background.....	55
World Opacity.....	55
Blur.....	55
Viewport Shading with Rendered.....	55
Lighting.....	55
Scene Lights.....	55

Scene World.....	55
Studiolight Preview.....	56
Show Light preferences.....	56
Rotation.....	56
Strength.....	56
World Opacity.....	56
Blur.....	56
Render Pass.....	56
Pause Preview.....	56
Align View Buttons.....	57
Align View Buttons.....	57
Grease Pencil - all modes - Layer Panel.....	57
Layer list.....	57
Layer name.....	57
Mask Layer.....	57
Onion Skinning.....	57
Viewport/Render Visibility.....	57
Lock.....	57
Search Field.....	58
Add new layer.....	58
Remove layer.....	58
Layer Specials.....	58
Duplicate Layer.....	58
Duplicate Empty Keyframes.....	58
Show All.....	58
Hide Others.....	58
Lock All.....	58
Unlock All.....	58
Autolock inactive layer.....	58
Merge Down.....	58
Copy Layer to Object.....	58
Isolate Layer.....	59
Isolate Layer.....	59
Blend.....	59
Opacity.....	59
Use Lights.....	59
Grease Pencil - Edit mode - Options Panel.....	59
Scale Stroke Thickness.....	59
Grease Pencil - Sculpt mode - Auto-masking Panel.....	59
Stroke.....	59
Layer.....	59
Material.....	59
Active Layer.....	60
Active material.....	60

Introduction

The header in the 3D view contains various menus and tools. This chapter here is about the tools, modes and options elements in the header.

The text menus are covered in a own chapter each. They vary too much, dependent of mode and object type.

Mode Drop-down Box

The Mode drop-down box allows you to switch between the different modes.

Modes are object states that allows you to edit and manipulate objects at different levels with different tool sets and goals. The sculpt mode for example allows you to sculpt a mesh object. Edit Mode allows to manipulate the mesh of the object, and so on.

The available modes can differ from object to object. An armature for example has an additional pose mode. And when you work with a grease pencil object, then several grease pencil modes becomes available.

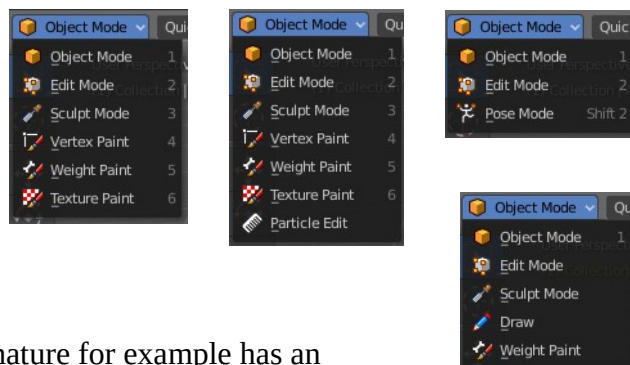

Object Mode

This mode allows to manipulate objects at Object level. Like move it around, rotate it, etc. This mode is available for all object types.

Edit Mode

The edit mode allows to edit the object. With a mesh object this means that you are able to modify and to change the geometry. With an armature you build your skeleton. And with a text object you can type in text, and choose the font etc.

Not all objects has an edit mode.

Sculpt Mode

In this mode you can sculpt the mesh. This mode is available for mesh and grease pencil objects.

Vertex Paint

Vertex Paint is a mesh object only mode. In this mode you can paint vertices with colors.

Weight Paint

In this mode you can adjust weight painting for an armature for example. But Weight Painted mesh objects can also be used in conjunction with particles. Also a grease pencil stroke can be weight painted.

Texture Paint

Weight Paint is a mesh object only mode. In this mode you can paint at the texture of a mesh directly. This mode requires to have a working UV mapping and a texture at the mesh object.

Edit Strokes

Edit Strokes is a Grease Pencil only mode. It allows to manipulate the curves at a mesh level.

Particle Edit

Particle edit is a Particle System mode only. When you apply a particle system to a mesh object then this mode becomes available. It allows you to manipulate the particle system at a mesh level. You can comb hair particles for example.

Draw

Draw is a grease pencil object only mode. In this mode you draw grease pencil strokes.

Mesh Object Sub Modes

The different modes can have some sub modes. For example different selection methods in mesh edit mode. Or a mask mode for texture painting. The sub mode settings can be found right from the Modes drop down box.

Edit Mode - Mesh Select Modes

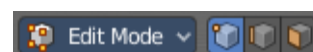

When you enter the edit mode with a mesh object then you will see the mesh select modes. They allows you to switch between the three available selection modes Vertex select, Edge Select and Face Select.

Vertex Select allows you to select vertices.

Edge Select allows you to select edges.

Face select allows you to select faces.

The mesh display changes, dependent of the mode. When you have for example select vertices active, then the vertices highlights at the mesh.

You can have more than one mode active by shift clicking at the other mesh select modes.

The standard Bforartists has hotkeys to switch between the modes. X, C

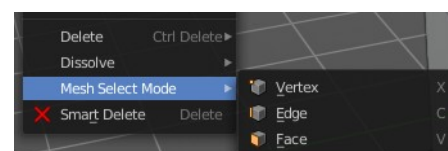

and V. You cannot see or edit them at the header element. There is however a sub menu in the mesh menu, called Mesh Select Mode. Here you can see and edit the hotkeys.

Vertex Paint - Mask and Vertex Selection

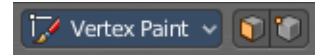

Paint Mask

When you activate this tool then you reveal a Select menu in the header. And you can select the mesh parts that you want to manipulate. Note that you may first want to deselect all. By default everything is selected ...

The select menu is explained in the chapter Vertex Paint modes. The menu items should be pretty self explaining though.

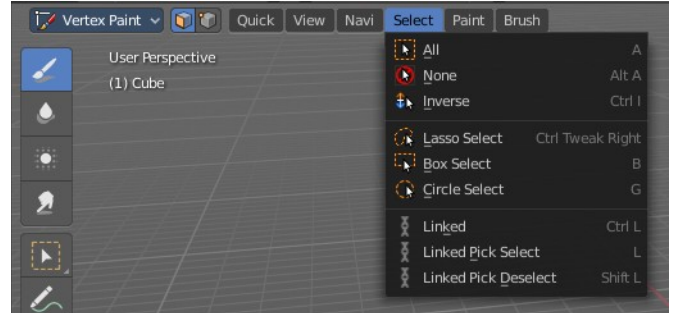

When you have selected a part of the mesh, then you can just paint the faces at this selected part. The edges are the border.

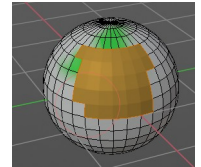

Vertex Selection

When you activate this tool then you reveal a Select menu in the header. And you can select the mesh parts that you want to manipulate. This tool is meant for Weight Painting. And so the mesh displays the vertices too.

Note that you may first want to deselect all. By default everything is selected ...

The select menu is explained in the chapter Vertex Paint modes. The menu items should be pretty self explaining though.

When you have selected a part of the mesh, then you can just paint the vertices at this selected part. The difference to the Paint mask method is that here the edges are not the border of the color. But there is a gradient between the vertices.

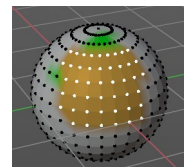
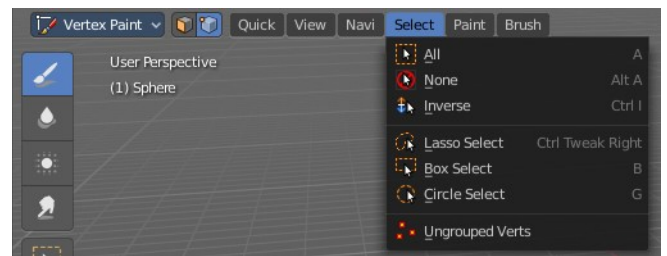

Weight Paint - Mask and Vertex Selection

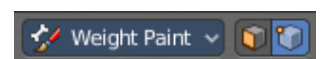

Paint Mask

Mesh Object.

When you activate this tool then you reveal a Select menu in the header. And you can select the mesh parts that you want to manipulate. Note that you may first want to deselect all. By default everything is selected ...

The select menu is explained in the chapter Vertex Paint modes. The menu items should be pretty self explaining though.

When you have selected a part of the mesh, then you can just paint the faces at this selected part. The edges are the border.

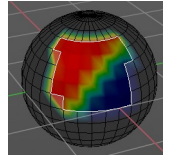
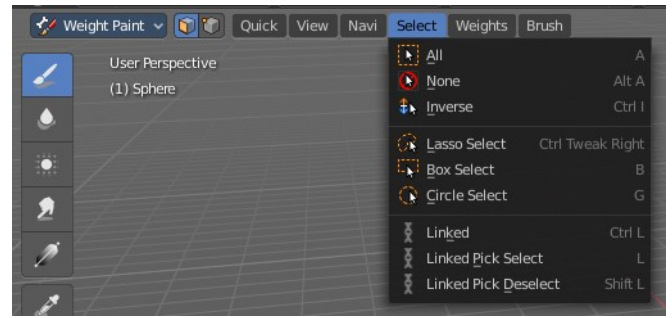

Vertex Selection

Mesh Object.

When you activate this tool then you reveal a Select menu in the header. And you can select the mesh parts that you want to manipulate. This tool is meant for Weight Painting. And so the mesh displays the vertices too.

Note that you may first want to deselect all. By default everything is selected ...

The select menu is explained in the chapter Vertex Paint modes. The menu items should be pretty self explaining though.

When you have selected a part of the mesh, then you can just paint the vertices at this selected part. There is no real difference to the faces method. The selection is the same.

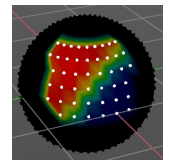
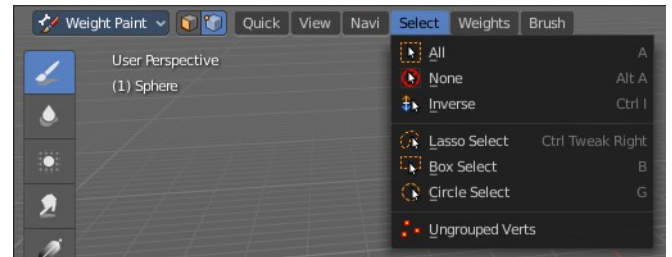

Texture Paint - Mask Selection

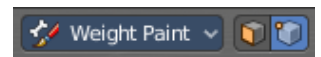

Paint Mask

Mesh Object.

When you activate this tool then you reveal a Select menu in the header. And you can select the mesh parts that you want to manipulate. Note that you may first want to deselect all. By default everything is selected ...

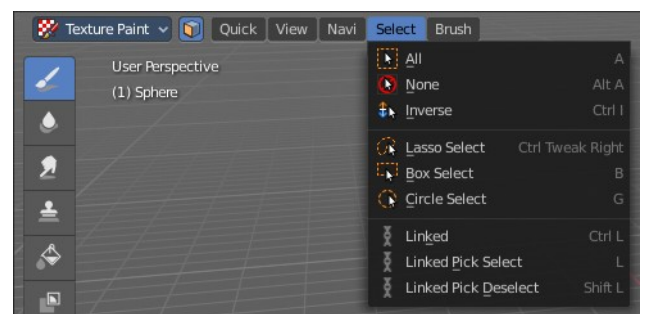

The select menu is explained in the chapter Vertex Paint modes. The menu items should be pretty self explaining though.

When you have selected a part of the mesh, then you can just paint the faces at this selected part. The edges are the border.

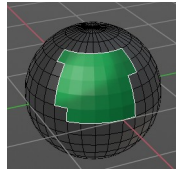

Particle Edit - Select Modes



Mesh Object with a particle system. You can just have one method active at a time.

Path

No key points are visible, you can select/deselect only all particles.

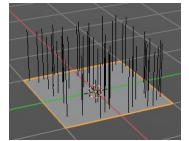

Point

You can see, select and edit all key points of the particle paths.

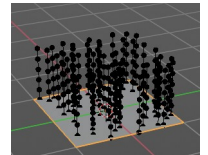

Tip

You can only see, select and edit the tip of the particles. This includes the brushes. The comb brush is a special case here. The other part key points bends of course still in this mode. But affected by the brush is just the tip key.

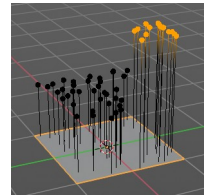

Grease Pencil Sub Modes

The different modes can have some sub modes. For example different selection methods in mesh edit mode. Or a mask mode for texture painting. The sub mode settings can be found right from the Modes drop down box.

Edit Mode



The edit mode allows you to edit the grease pencil strokes.

Select Modes

You can only have one method active at a time.

Select Only Points

When you for example border select some points of the stroke, then just this points gets selected.



Select all Stroke Points

When you for example border select some points of the stroke, then the whole stroke gets



selected.

Select all Stroke Points between other strokes

When you for example border select some points of the stroke, and this stroke crosses another stroke, then the part of the stroke up to the crossing point gets selected.

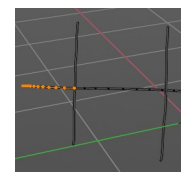

Curve Editing

Edit Strokes by using Curve handles.

Curve Editing panel

The settings for Curve Editing.

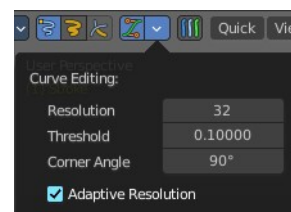

Curve Resolution

Number of segments generated between control points

Threshold

The curve conversion error threshold

Corner Angle

Angle threshold to be treated as corners. The resolution is the number of points generated per unit distance.

Adaptive Resolution

Set the resolution for each segment dynamically based on its length.

Multi frame

When this mode is active, then you can edit strokes from multiple grease pencil frames at once. The key frames must be selected to be included.

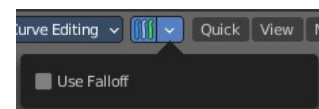

Use Falloff

Multi frame has a setting, which becomes visible when the mode is active.

Use Falloff when edit in Multi frame mode to compute brush effect by frame.

Sculpt Mode

The sculpt mode allows you to sculpt the grease pencil strokes.

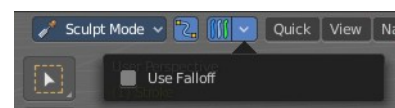

Selection Mask

When you activate this mode, then just the selected parts gets sculpted.

Multi frame

When this mode is active, then you can edit strokes from multiple grease pencil frames at once. The key frames must be selected to be included.

Use Falloff

Multi frame has a setting, which becomes visible when the mode is active.

Use Falloff when edit in Multi frame mode to compute brush effect by frame.

View

Relative to which plane to draw the strokes. Default orientation is view.

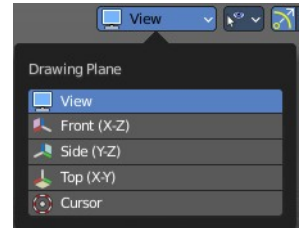

Draw Mode

The draw mode is the mode in which you draw the grease pencil strokes.



Multi frame

When this mode is active, then you can edit strokes from multiple grease pencil frames at once. The key frames must be selected to be included.

Origin

Where the stroke is placed.

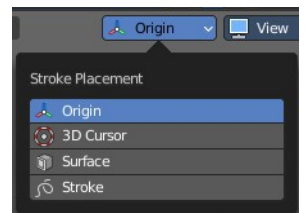

View

Relative to which plane to draw the strokes. Default orientation is view.

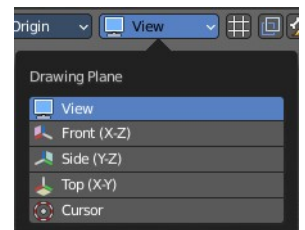

Use Guides

Guides allows you to draw geometric shapes with the grease pencil.

Circular

Draw a circle around the origin.

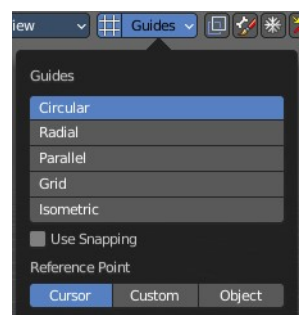

Radial

Draw a straight line through the origin.

Angle

Doesn't do anything.

Parallel

Draw parallel horizontal lines.

Grid

Draw parallel horizontal and vertical lines.

Isometric

Draw parallel lines in an specific angle.

Use Snapping

Enable snapping to guides angles or spacing options.

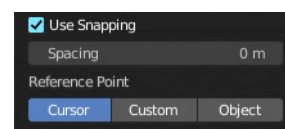

Spacing

The guide spacing. This is the distance between the strokes.

Reference Point

What point to use as the reference for the strokes.

Draw Strokes on Back

Usually a new stroke is drawn on top of existing strokes. Draw Strokes on Back adds the new strokes below the existing strokes.

Add Weight Data for new strokes

Add Weight data for new strokes, according to the current vertex group and weight. When no vertex group is selected, then no weight is added.

Use Additive Drawing

When creating new frames, then the strokes from the previous or active frame gets included as the base for the new stroke.

Automerge

Join last drawn strokes by distance with previous strokes in the active layer.

Weight Paint Mode

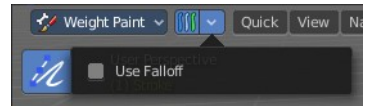

Multi frame

When this mode is active, then you can edit strokes from multiple grease pencil frames at once. The key frames must be selected to be included.

Use Falloff

Multi frame has a setting, which becomes visible when the mode is active.

Use Falloff when edit in Multi frame mode to compute brush effect by frame.

Vertex Paint Mode



Select Modes

You can only have one method active at a time.

Select Only Points

When you for example border select some points of the stroke, then just this points gets selected.



Select all Stroke Points

When you for example border select some points of the stroke, then the whole stroke gets selected.

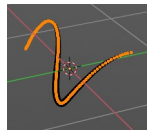

Select all Stroke Points between other strokes

When you for example border select some points of the stroke, and this stroke crosses another stroke, then the part of the stroke up to the crossing point gets selected.

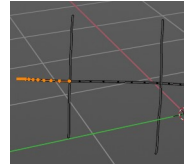

Multi frame

When this mode is active, then you can edit strokes from multiple grease pencil frames at once. The key frames must be selected to be included.

Use Falloff

Multi frame has a setting, which becomes visible when the mode is active.

Use Falloff when edit in Multi frame mode to compute brush effect by frame.

Object settings



The object settings just appears when the Tool Settings are hidden. This can be done in the View menu. Parts of the object settings are just visible in Object and Edit Mode. Parts in other modes.

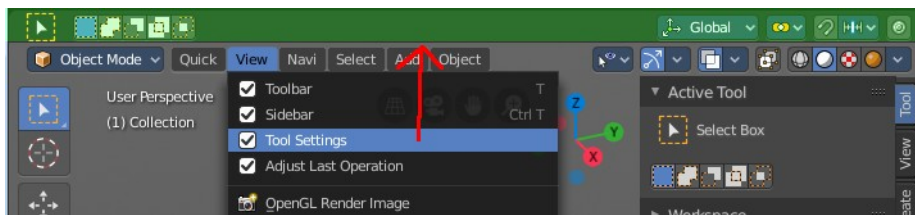

Transform Orientations

You can display Transform Manipulators at your object or selection by activating them in the tool shelf. They allow you to scale, rotate or move objects by grabbing their controls, and moving your mouse in the corresponding axis. The widget can be oriented in different ways by using another method in this drop down box. The names should be self explaining.

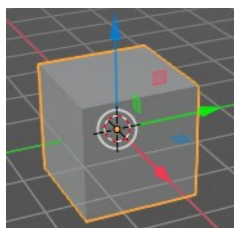

View

The transform orientation aligns to the current view.

Gimbal

Aligns each axis to the Euler rotation axis as used for input.

Normal

This is of interest for bones for example. Aligns the transformation axis to average normal of the selected elements. Bone Y axis for Pose mode.

Local

Uses the local orientation of the selected elements.

Global

Uses the global orientation for the selected elements.

Cursor

Uses the orientation of the 3D cursor.

Parent

Uses the orientation of the parent object.

Create Orientation

The create orientation button at the right adds a new orientation from the current mode and view. You can rename it.

This view is scene specific only. It does save and load with the current scene. But you cannot transfer it into another scene. When you create a new scene then this custom orientation is gone.

You can create more than one user orientation.

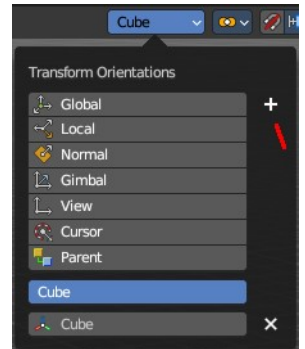

Last Operator Create Orientation

Create Orientation has some settings.

Name

Rename the orientation.

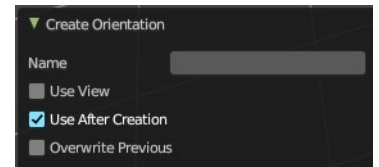

Use View

Use the current view instead of the active object to create the new orientation.

Use after creation

Use this orientation after creation.

Overwrite Previous

Overwrite previous created orientation in case it has the same name.

Pivot Point

The Pivot Point is the center of your object or your selection. When you rotate or scale an object, or a group of vertices/edges/faces, you may want to shift the pivot point in 3D space. The names should be self explaining.

Only Origins

When this option is enabled, then the transformation will change the positions of the object's origins, but will not affect the object itself.

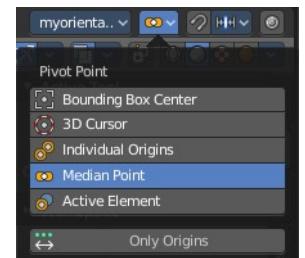

Snapping

Activate snapping when transforming an element.

Snapping can be temporarily activated by holding CTRL key. So no need to turn snapping on and off all the time.

You can snap to various scene elements in Object, Edit and Pose mode. And you can activate more than one snapping method by holding down CTRL and clicking at the next snapping element.

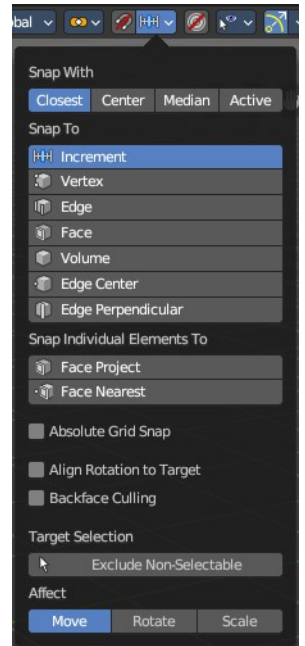

Multiple Snap Targets

When you move the mouse with snapping on and the element to snap selected (This does not work with holding Ctrl), then you can press hotkey A to mark the current snapping point, then proceed to mark as many other snapping points as you wish. And the element that you want to snap will then be in the center of these marked snapping points. Marked snapping points will have a circle around.

Marking a point more than once will give it more weight in the averaged location.

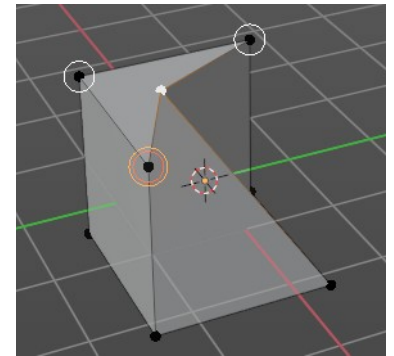

Snap With

Which part to snap onto the target.

Closest

Snap closest point onto the target.

Center

Snap transformation center onto the target.

Median

Snap median onto the target.

Active

Snap active onto the target.

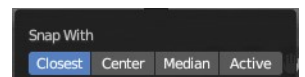

Snap to

To which part of the target to snap.

Increment

Incremental grid snapping. In Orthographic view the snapping increment changes depending on zoom level.

Vertex

Snap to a vertice.

Edge

Snap to an edge.

Face

Snap to a face.

Volume

Snaps to regions within the volume of the first object found below the mouse cursor.

Edge Center

Snaps to the center of an edge.

Edge Perpendicular

Snap to the nearest point of an edge.

Sbap Individual Elements to

Type of element for individual transformed elements to snap to.

Face Project

Snap by projecting onto faces.

Face Nearest

Snap to nearest point on faces.

Absolute Grid Snap

Only available with the Snap to Method Increment. Snap to the world grid, instead of snapping in increments relative to the current location.

Snap Peel Object

Only available with the Snap to Method Volume. Consider objects as whole when finding a volume center.

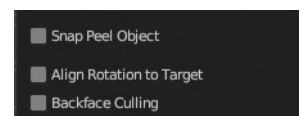
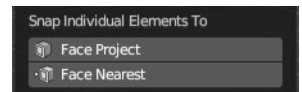
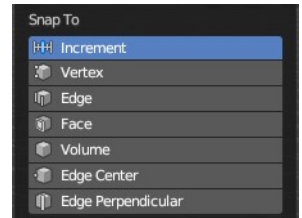

Back face Culling

Exclude back facing geometry from snapping.

Align Rotation to Target

Align rotation with the snapping target.

Affect

Adjust what transform methods should be affected by snapping.

Proportional Editing

Enables proportional editing.

Proportional Editing is a way of transforming selected elements (such as vertices) while having that transformation affect other nearby elements with a falloff. For example, moving a single vertex will move unselected vertices within a given range. And the falloff means that selected vertices that are closer to the selected vertex will move more than those farther from it.



Settings

The settings appears when you activate Proportional Editing. Choose between different falloff methods for the proportional editing.

Proportional Size

The influence of the proportional editing is defined by a radius. It is by default one standard unit.

You can change the influence radius for proportional editing with the mouse wheel or the Page up Page down arrows **while keeping the mouse button pressed down** and do the translation.

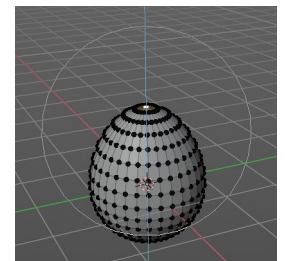

The exact radius value can be read in the header while transformation.

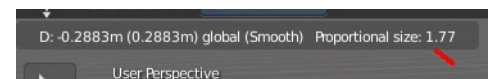

And it can also be read and edited at the Proportional Size slider in the Proportional Editing panel.

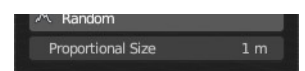

Last Operator Proportional Editing

When you translate an object, move it around or rotate or scale it, then the last operator contains also proportional editing settings.

Proportional Editing

Enable proportional editing.

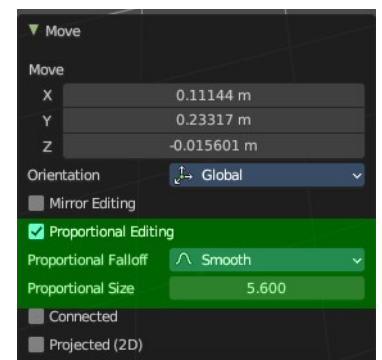

Proportional Falloff

Adjust the falloff methods again.

Proportional Size

Adjust the falloff radius. Note that the white circle is not displayed when using this slider.

Connected

The proportional falloff gets calculated for connected parts only.

Projected(2D)

In depth direction along the view the radius is ignored. It selects as deep as there is something to select.

Object Types Visibility

In this drop down box you can set specific elements in the scene to either not selectable or invisible.

When the elements are invisible then they are also not selectable.

When you have set some objects to not selectable or invisible, then the icon in the menu header changes.

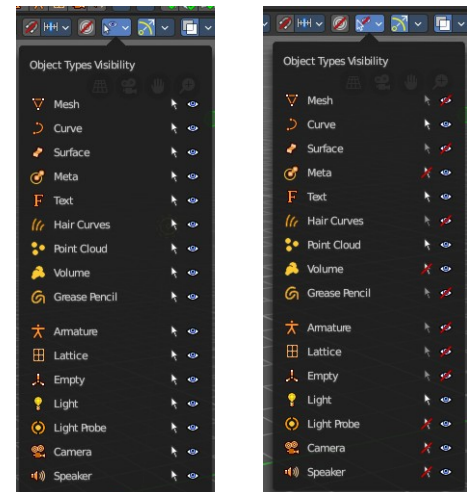

Viewport Gizmo

This menu allows you to adjust what gizmos shows. The button at the left turns off or on all of them.

Show Gizmo

Shows or hides all available gizmos at once.

Gizmo Options

Turn on or off specific widgets.

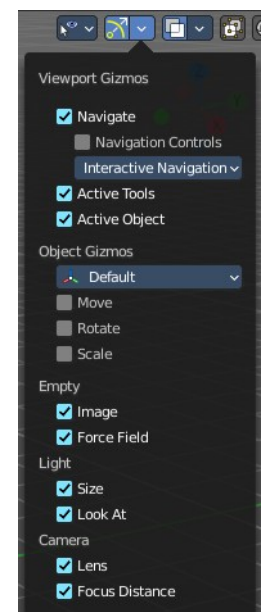

Viewport Gizmos

Navigate

Turn on or off the navigate widget. The navigate gizmo is the block of buttons and the widget up right.

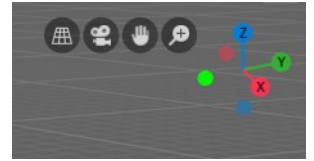

Navigation Controls

Display the navigation controls in the 3D view.



3D Viewport Axis

Adjust the appearance of the 3D Viewport mini axis widget.

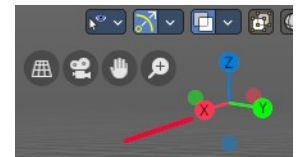
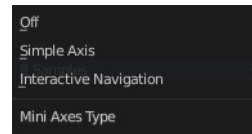

Off

Hides the Mini axis widget.

Simple Axis

Shows simple axis. This widget type is not interactive. It just shows the state of the viewport rotation.

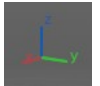

Interactive Navigation

The default mini axis widget. This widget is interactive. Clicking and dragging will rotate the viewport. Clicking at one of the colored spots at the end of the axis will snap to the nearest orthographic view.

Active Tools

Turn on or off the active tool widget. When you activate one of the transformation buttons in the tool shelf, then a gizmo will appear at the object.

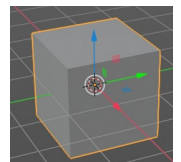

Active Object

Turn on or off the Object Gizmos. The Object Gizmos is an extra set of translate gizmos, similar to the active tool widget that shows when you activate one of the transform buttons in the tool shelf. But it shows permanent as long as you don't have another tool selected that overrides this widget.

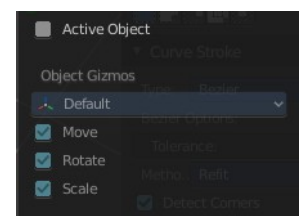

Object Gizmos

Transformation Orientation

Adjust the orientation of the widget. By default it uses the transform orientation from the viewport. This set can override the transform orientation.

You can have all transform methods on at once.

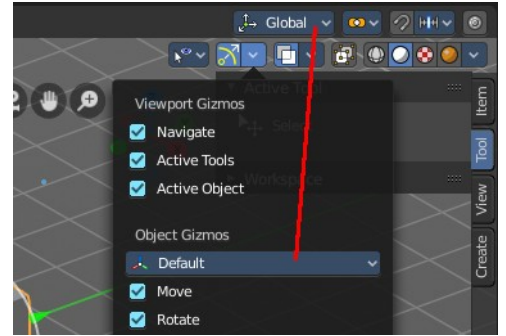
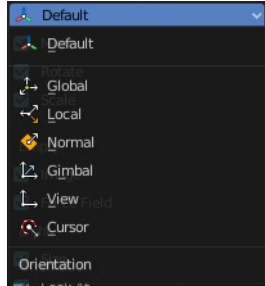

Move

Shows the move part of the widget.

Rotate

Shows the rotate part of the widget.

Scale

Shows the scale part of the widget.

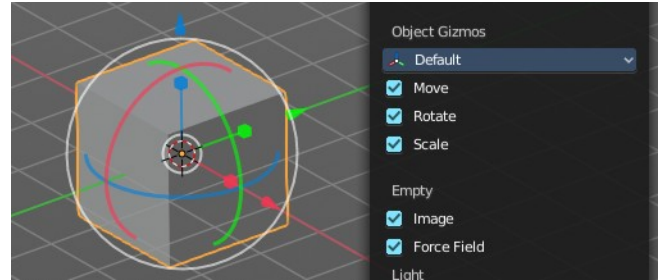

Empty

Image

Shows the transform gizmo at an empty of type Image. You need to hover with the mouse over the object to reveal the yellow gizmo.

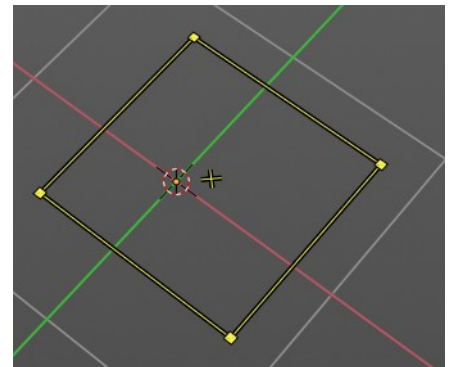

Force Field

Some force field types have a gizmo. Shows the transform gizmo at a force field.

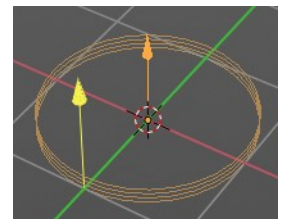

Light

Size

Show the gizmo to adjust the size of lights. That's the blue arrow here.

Look At

Show the gizmo to adjust the direction of the light. That's the yellow dot in the

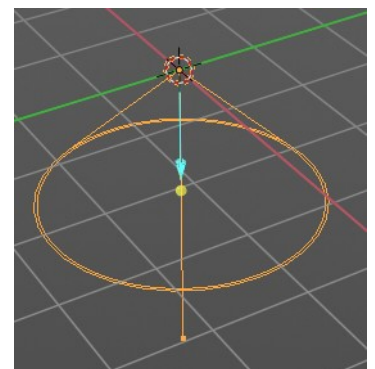

middle of the circle.

Camera

Lens

Show the gizmo to adjust the lens and orthographic size. The yellow square.

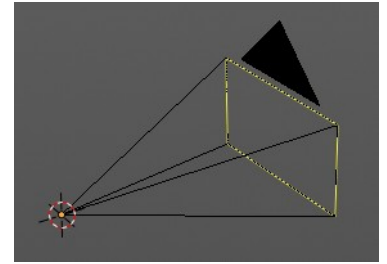

Focus Distance

Show to gizmo to adjust the focus distance.

You first need to turn on the Limits gizmo in the camera settings in the Viewport Display panel. Then you can turn off the focus distance gizmo part with Focus Distance.

Note that this feature is currently broken!

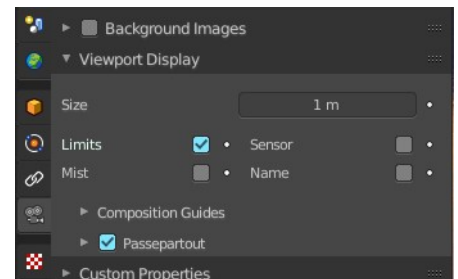

Show Overlays - all modes

Turn on or off all overlays. This includes the ground grid, things like relationship lines, and several other elements in the viewport. Some content is available in all modes. Some content is changing, dependent of the mode you are in. In Edit mode with a mesh object you will get some normal functionality for example.

Guides

Grid

Show the whole ground grid, including axes.

Floor

Show the ground grid, the white part of it.

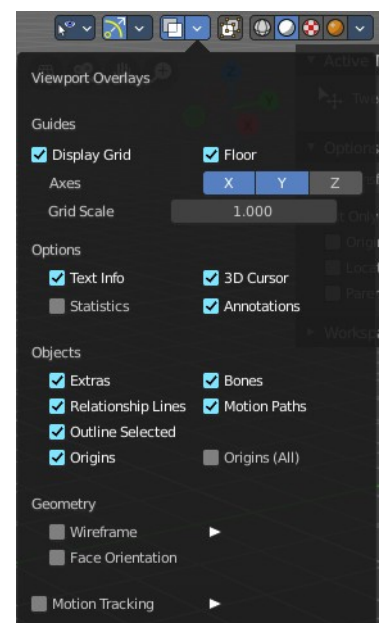

Axes

Show the colored axis lines in the 3d view. This feature just works in perspective view.

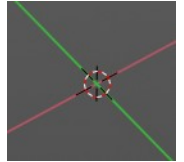

In orthographic view this lines cannot be hidden separately. The buttons are greyed out.

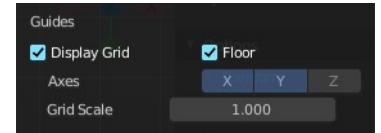

Scale

Scale the ground grid. This works in perspective and orthographic view.

Subdivisions

Subdivisions just shows with a Unit system of None. It allows you to subdivide the ground grid.

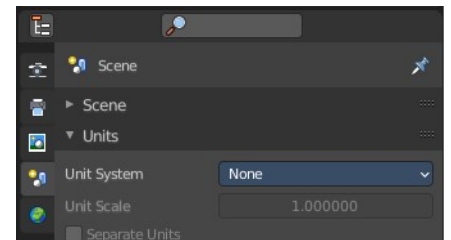

Options

Text Info

In the upper left corner of the 3D view there is a text info string, which can be hidden here. It tells you in what view you are, what is selected, and things like frames per second when you play an animation



Annotations

Show or hide annotations. Annotations can be drawn at the 3D View with the annotation tool in the tool shelf.



Statistics

Displays statistical informations in the upper left corner of the 3d viewport. Object count, vertices, and so on.

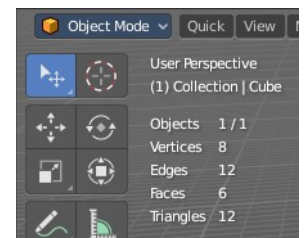

3D Cursor

Show or hide the 3D cursor. That's the white red circle in the center of the viewport.



Objects

Extras

Show or hide object details. Including things like empty wires like lights, cameras, and other visual guides.

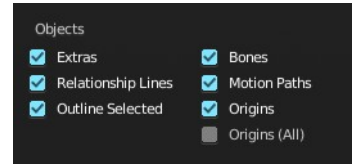

Relationship Lines

Show or hide relationship lines. When you for example parent one object to another then you will see a dotted line. The relationship line.

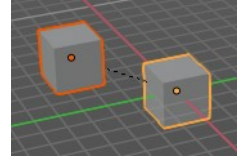

Outline Selected

Show the selected object with an outline

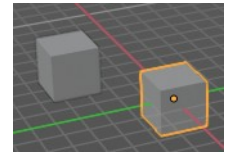

Bones

Show or hide bones.

Motion Paths

Show or hide motion paths. Motion paths can be calculated in the Motion Paths panel. You need an animation for that.

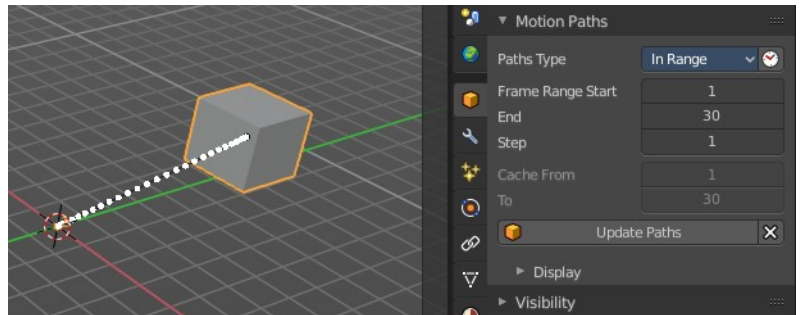

Origins

Show or hide the origin of the selected object. The origin is the center point of the object, and represented by an orange dot.

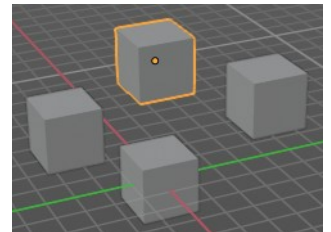

Origins(All)

Show or hide the origin of all objects. Even from hidden ones. The not selected objects shows the center point with a white dot.

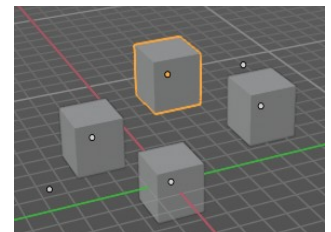

Geometry

Geometry related settings.



Wire frame

Show the wire frame in object mode.

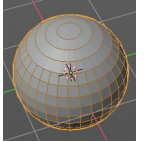

Wireframe Threshold

With a wire frame value of 1 all edges are drawn. The lower the value, the more edges will disappear.

Opacity

The opacity of the displayed edges.

Face Orientation

This mode allows to check for faces with flipped normals, which cannot be seen with the defaults. Blue is pointing outwards, red is pointing inwards.

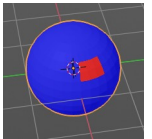

Fade inactive Geometry

Edit mode feature. Fades the not active geometry, the not selected scene objects, towards a plain grey. In Object mode this setting has no effect.

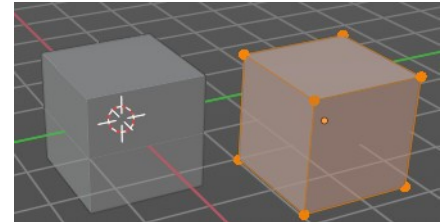

Motion Tracking

Motion tracking related settings. When you turn it on, then some further options appears. These features just shows before you bake the solution. Not with the resolved solution.

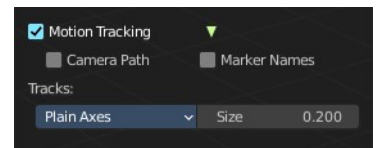

Camera Path

Shows the camera path.

Marker Names

Shows the marker names.

Track display type

How to display the tracks.

Track size

Adjust the display size of the tracks of reconstructed data.

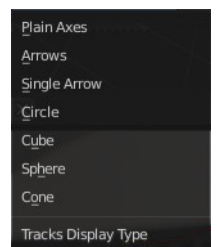

Show Overlays - Mesh Object - Edit Mode

The Show overlays panel shows different content, dependent of mode and object type. This is with mesh object in edit mode.

Mesh Edit Mode

Edges

Highlight selected and partially selected edges.

This only affects vertex and face selection mode (as edges are always highlighted in edge-selection mode).

Faces

Highlight faces by using a face overlay that applies to both selected and unselected faces.

This affects all selection modes.

Center

Show face-center points in solid shading modes.

Only affects face-select mode.

Creases

Display edges marked with a crease for the Subdivision Surface Modifier.

Sharp

Display sharp edges, used with the edge split modifier.

Bevel

Display weights created for the Bevel Modifier.

Seams

Display the UV unwrapping seams.

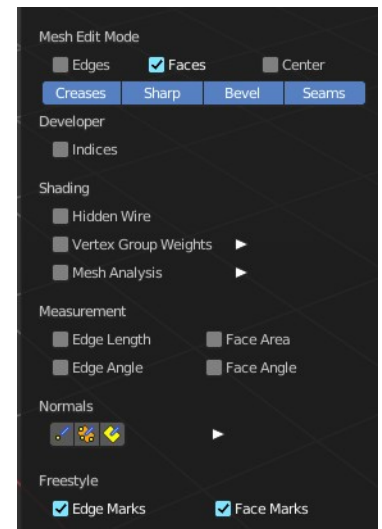

Developer

Indices

Display the indices of selected vertices, edges and faces at the mesh.

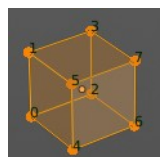

Shading

Hidden Wire

Show only front-facing wire frames.

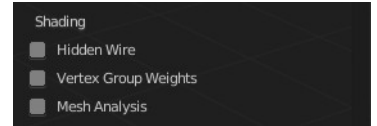

Vertex Groups Weights

Display weights in Edit Mode. When you activate this feature then further options appears.

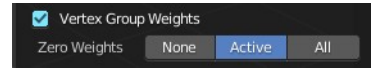

Zero Weights

None

Don't show the vertices with zero weights with a specific color. They appear blue like vertices with a very low weighting.

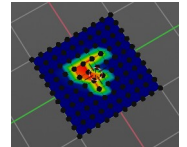

Active

Zero weights vertices are shown with a black color in the active vertex group.

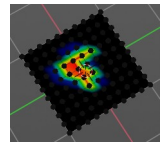

All

Zero weights vertices are shown with a black color in all vertex groups of the mesh.

Mesh Analysis

Show the mesh analysis overlay and settings. Note that editing may be slow with mesh analysis tools on. And modifiers can make trouble.

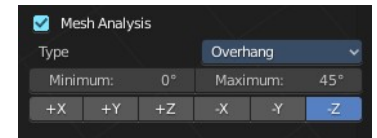

Overhang

Extrusion 3D printers have a physical limit to the overhang that can be printed. Overhang mode shows the overhang. Angle and axis can be adjusted.

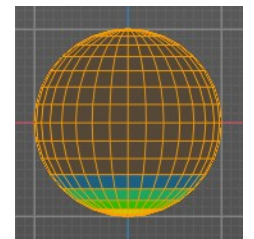

Minimum/Maximum

Minimum/Maximum angle to display.

Axis

Choose which angle to calculate.

Thickness

3D Printers have a limited wall-thickness. Too thin areas cannot be printed. This mode displays thin areas as red.

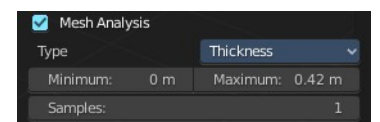

Minimum/Maximum

Minimum/Maximum thickness to display.

Samples

The number of samples to use to calculate the thickness.

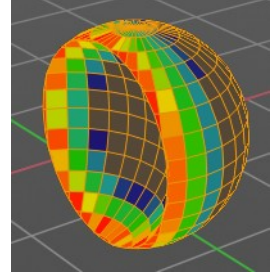

Intersections

A mesh can be made of more than one closed sub mesh. Join two spheres and you have one mesh with two closed sub meshes. Such intersections can be a problem with printing. Intersect marks intersecting areas with red.

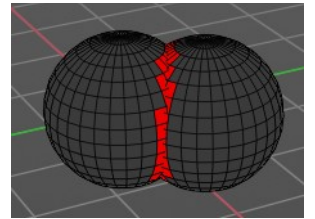
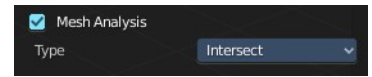

Distortion

Marks distorted faces.

Distorted geometry, means uneven quads or N-gons, can cause problems with printing. Since the triangulation of a distorted quad or N-gon is undefined. And printing works with tris. With a quad there are already two solutions in which direction the edge to triangulate the face can point.

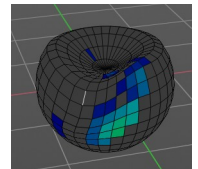
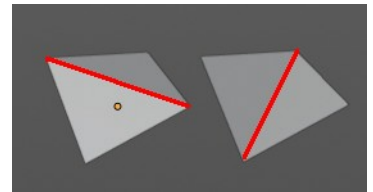
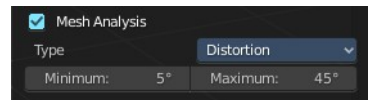

Minimum/Maximum

Adjust the minimum and maximum values after which a face gets displayed as distorted.

Sharp Edges

Similar to wall-thickness, sharp edges can be too thin to be able to print.

Minimum/Maximum

Adjust the minimum and maximum values after which an edge gets displayed as sharp.

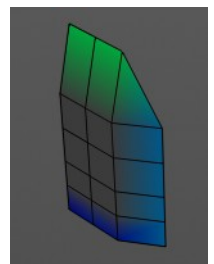
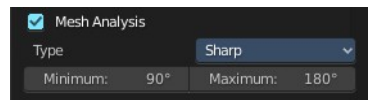

Measurement

Shows measure values at the selected elements. The units are displayed as chosen in the preferences. These values respects global/ local in the transform panel. And so the values can differ when you have scaled the mesh in object mode, and the scaling is not applied yet. Use Global to take the object scale into account.

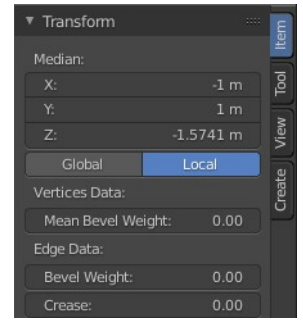
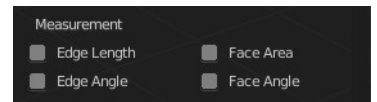

Edge Length

Shows the length of selected edges.

Edge Angle

Shows the angle of selected edges between two faces.

Face Area

Show the area of selected faces.

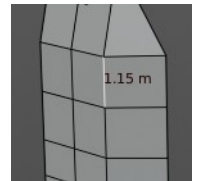

Face Angle

Show the angle of selected face corners.

Normals

Show the normals for the chosen elements. They will be displayed as lines.

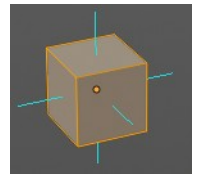
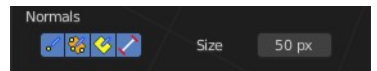

Display vertex normals

Displays the normals of the vertices

Display split normals

Displays the per vertex face normals

Display normals

Displays the face normals.

Constant Screen Size Normals

Display the normals either in size relative to the object. Or constant to the screen size.

Relative to the object is measured in object units. Absolute to the screen size is measured in pixels.

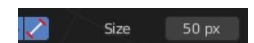
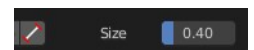

Size

Adjust the length of the line that represents the normal.

Freestyle

Freestyle is the line renderer integrated into Bforartists. For freestyle you can mark edges and faces.

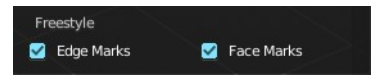

Edge Marks

Display Freestyle edge marks, used with the Freestyle renderer.

Face Marks

Display Freestyle face marks, used with the Freestyle renderer.

Show Overlays - Mesh Object - Sculpt Mode

Show Mask

Show mask as overlay on object. The opacity of the overlay can be controlled by the slider.

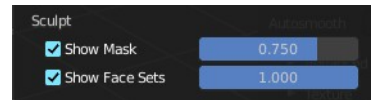

Show Face Sets

Show face sets as overlay on object. The opacity of the overlay can be controlled by the slider.

Show Overlays - Mesh Object - Vertex Paint Mode

Opacity

How strong the painted color gets shown.

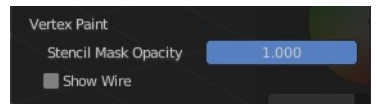

Show Wire

Display the wire at the mesh. Normally the wire is hidden.

Show Overlays - Mesh Object - Weight Paint Mode

Opacity

The opacity of the color overlay.



Zero Weights

None

Don't show the vertices with zero weights with a specific color. They appear blue like vertices with a very low weighting.

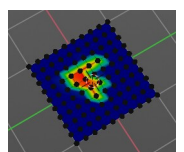

Active

Zero weights vertices are shown with a black color in the active vertex group.

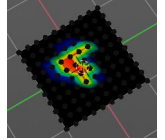

All

Zero weights vertices are shown with a black color in all vertex groups of the mesh.

Show Weight Contours

Show contour lines formed by points with the same interpolated weight.

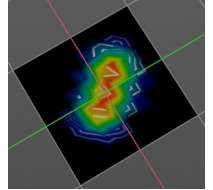

Show Wire

Display the wire at the mesh. Normally the wire is hidden.

Show Bone X Ray

This prop just shows when you have both, the bone and the mesh object selected by holding down shift.

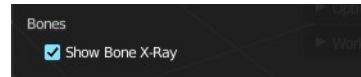

This has in general nearly the same effect than draw in front. It shows the bones on top of the mesh geometry. But you can fade the mesh geometry to black.

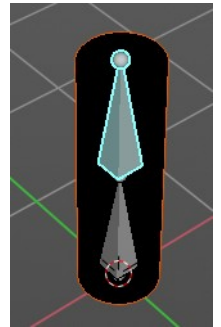

Show Overlays - Mesh Object - Texture Paint Mode

Stencil Opacity

How strong the painted color gets shown.

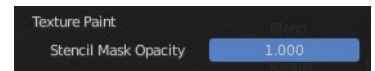

Show Overlays - Hair Object - Sculpt Mode

Selection Opacity

How solid not selected curves are displayed. Note that you can't make them fully transparent.



Curves Cage

Highlight the selected curves.

Cage Opacity

How strong selected curves are highlighted.

Show Overlays - Pose Mode

Show Bone X Ray

This has in general nearly the same effect than draw in front. It shows the bones on top of the mesh geometry. But you can fade the mesh geometry to black.

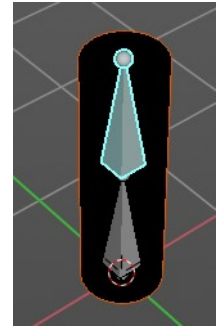
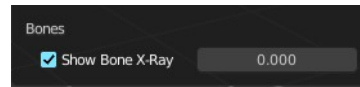

Opacity

The opacity of the object in the background.

Bone Wireframe Opacity

This property just shows when you have the viewport display method Display As set to Wire.



It allows you to make the bones semitransparent up to completely transparent. For weight painting for example where it could disturb.

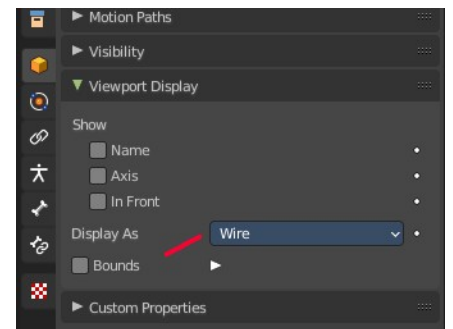

Show Overlays - Grease Pencil

In Object Mode



Onion Skin

Show ghosts of the key frames before and after the current frame.

Canvas

Display a grid over Grease Pencil drawing plane. The opacity of the grid can be controlled with a slider.

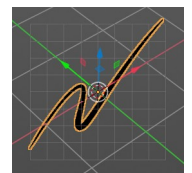

Canvas X Ray

Show the grid in front of the stroke.

Fade Layers

Controls the opacity of the not selected layers in the current grease pencil object.

I have set the fade layers opacity to 1 here. When you select the other layer, then the inner part becomes visible again, and the black outlines hides.

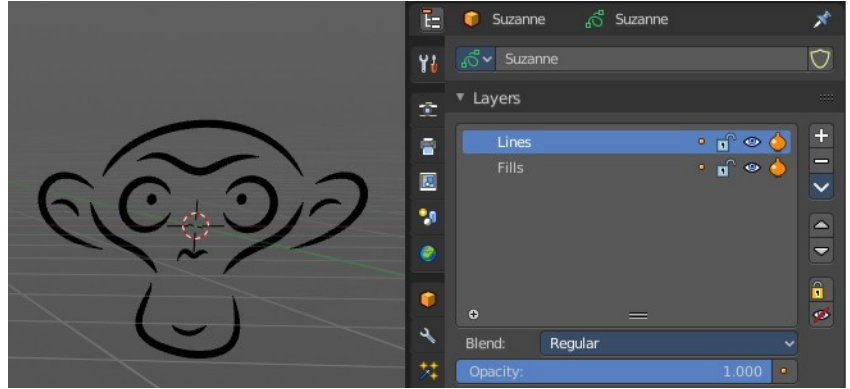

Fade Objects

Fades everything in the viewport but the grease pencil color to black.



Fade Grease Pencil Objects

Fades the not active grease pencil objects to black too.

In Edit Mode

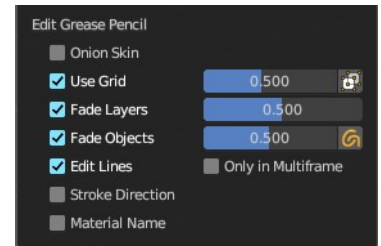

Onion Skin

Show ghosts of the key frames before and after the current frame.

Canvas

Display a grid over Grease Pencil drawing plane. The opacity of the grid can be controlled with a slider.

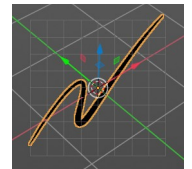

Canvas X Ray

Show the grid in front of the stroke.

Fade Layers

Control the opacity of the not selected layers in the current grease pencil object.

I have set the fade layers opacity to 1 here. When you select the other layer, then the inner part becomes visible again, and the black outlines hides.

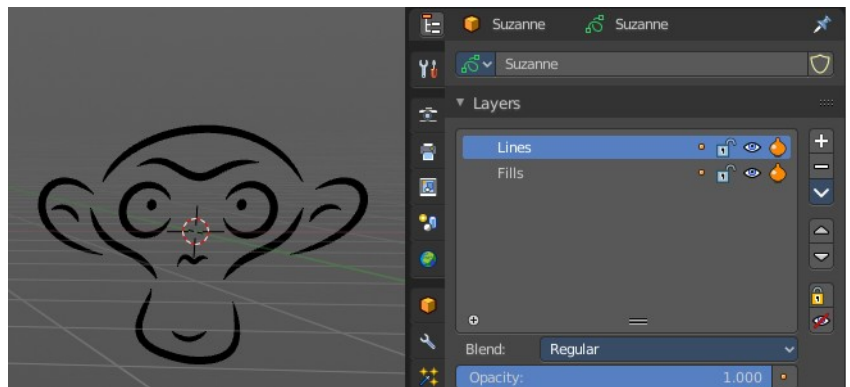

Fade Objects

Fades everything in the viewport but the grease pencil color to black.



Fade Grease Pencil Objects

Fades the not active grease pencil objects to black too.

Edit Lines

Show the edges of the curve when editing strokes.

Stroke Direction

Shows a red and a green dot at the end of the stroke. Green dot is start. Red dot is end.



Only in multi frame

Only show edges of the curve while in multi frame edition.

Material Name

Displays the material name at the start of the stroke.

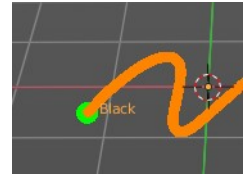

Vertex Opacity

How strong the selected vertices of the stroke shows.

In Sculpt and Weight paint Mode

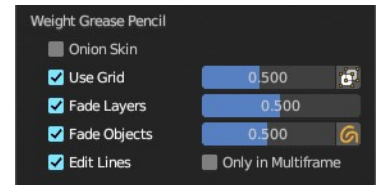

Onion Skin

Show ghosts of the key frames before and after the current frame.

Canvas

Display a grid over Grease Pencil drawing plane. The opacity of the grid can be controlled with a slider.

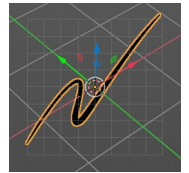

Canvas X Ray

Show the grid in front of the stroke.

Fade Layers

Control the opacity of the not selected layers in the current grease pencil object.

I have set the fade layers opacity to 1 here. When you select the other layer, then the inner part becomes visible again, and the black outlines hides.

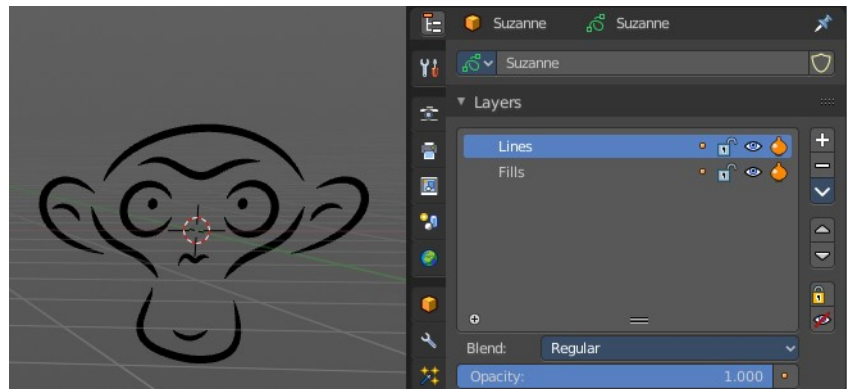

Fade Objects

Fades everything in the viewport but the grease pencil color to black.

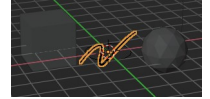

Fade Grease Pencil Objects

Fades the not active grease pencil objects to black too.

Edit Lines

Show the edges of the curve when editing strokes.

Only in multi frame

Only show edges of the curve while in multi frame edition.

Vertex Opacity

Sculpt mode only. How strong the selected vertices of the stroke shows.

In Draw Mode

Onion Skin

Show ghosts of the key frames before and after the current frame.

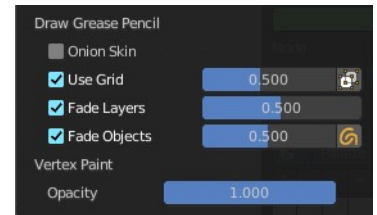

Canvas

Display a grid over Grease Pencil drawing plane. The opacity of the grid can be controlled with a slider.

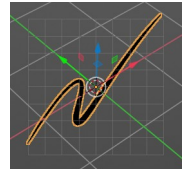

Canvas X Ray

Show the grid in front of the stroke.

Fade Layers

Control the opacity of the not selected layers in the current grease pencil object.

I have set the fade layers opacity to 1 here. When you select the other layer, then the inner part becomes visible again, and the black outlines hides.

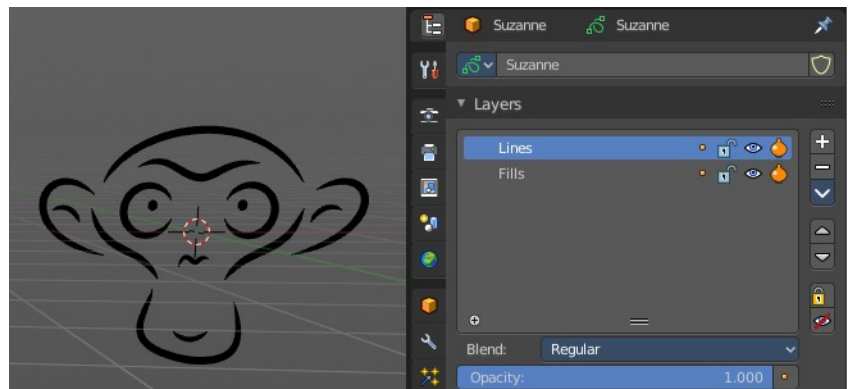

Fade Objects

Fades everything in the viewport but the grease pencil color to black.

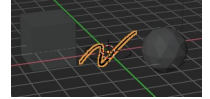

Fade Grease Pencil Objects

Fades the not active grease pencil objects to black too.

Vertex Opacity

How strong the selected vertices of the stroke shows.

In Vertex Paint mode

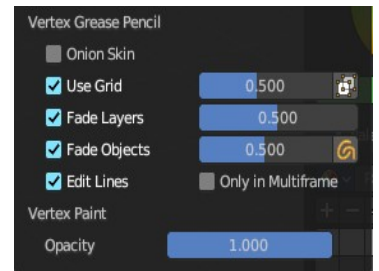

Onion Skin

Show ghosts of the key frames before and after the current frame.

Use Grid

Display a grid over Grease Pencil drawing plane. The opacity of the grid can be controlled with a slider.

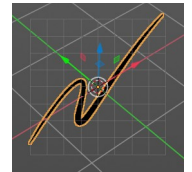

Canvas X Ray

Show the grid in front of the stroke.

Fade Layers

Control the opacity of the not selected layers in the current grease pencil object.

I have set the fade layers opacity to 1 here. When you select the other layer, then the inner part becomes visible again, and the black outlines hides.

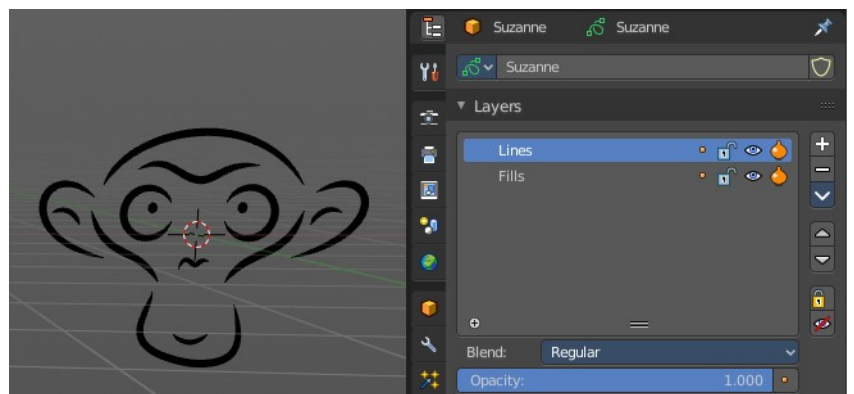

Fade Objects

Fades everything in the viewport but the grease pencil color to black.



Fade Grease Pencil Objects

Fades the not active grease pencil objects to black too.

Edit Lines

Show the edges of the curve when editing strokes.

Only in multi frame

Only show edges of the curve while in multi frame edition.

Vertex Opacity

How strong the selected vertices of the stroke shows.

Opacity

The vertex paint opacity.

Viewport Shading

At the very right of the header you can find the viewport shading settings. Here you adjust the display of the viewport. The order goes from left to right.



Show X Ray

This viewport setting is connected with the viewport shading. It allows you to show and edit the back geometry. Or hide it, so that you can just edit the geometry that points forwards.

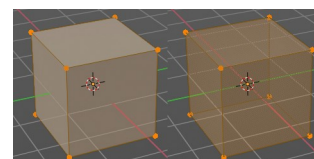

Viewport Shading

Defines how geometry gets displayed in the viewport.

Wire frame

Displays the content in the viewport as Wire frame.

Solid

Displays the content in the viewport with a solid white color.

Material

Displays the content in the viewport with all material settings and with OpenGL rendering. Note that this does not exist when you choose the Workbench renderer.

Rendered

Displays the content in the viewport like you would have rendered it. This mode is dependent of what render engine you have currently active.

Viewport Shading Settings

The viewport shading panel. Its settings changes, dependent of which viewport shading mode you have activated. And provides you with further settings for it.

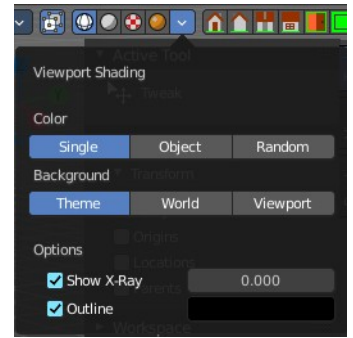

Viewport Shading Settings with Wire frame

Color

Single

The selected object gets highlighted. The wire frame is the color of the selection outline. The not selected objects shows a black wire frame.

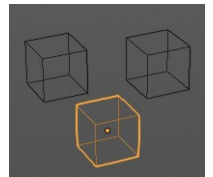

Object

The selected object gets highlighted. The wire frame is white. The not selected objects shows a Grey wire frame.

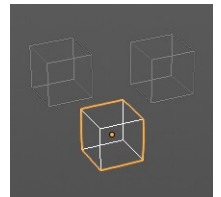

Random

The selected object gets highlighted. The wire frame is a random wire frame color. The not selected objects shows a random wire frame color. You cannot influence this random color. It is random.

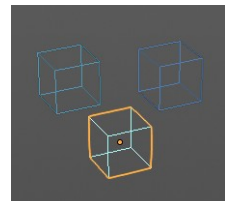

Background

Theme

Uses the viewport background color as defined in the theme.

World

Uses the world background color as the viewport background color.

Viewport

Defines a custom color for the viewport background color.

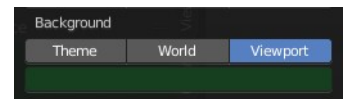

Options

Show X Ray

This viewport setting is connected with the viewport shading. It allows you to show and edit the back geometry. Or hide it, so that you can just edit the geometry that points forwards.

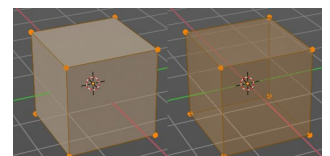

X Ray Alpha

Adjust the amount of transparency.

Outline

Show the not selected objects with an outline.

Outline Color

Defines the color of the outline for not selected objects.

Viewport shading Settings with Solid

Lighting

Choose between different lighting methods.

Note that this methods are not for rendering the scene. This lighting methods are meant to light the viewport.

Studio

Uses a studio setup lighting. You can choose between several studio light setups in the library menu below. This library menu is a box with a preview of the currently active light setup.

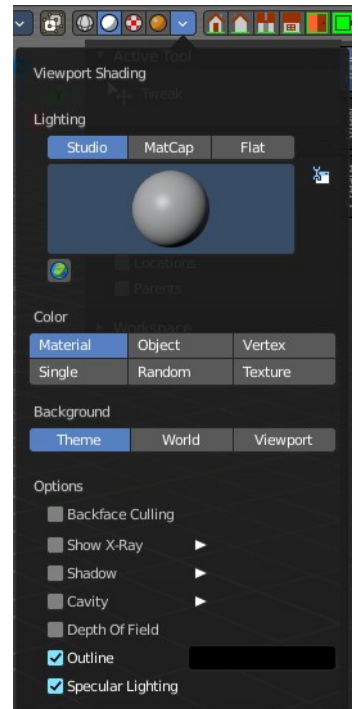

World Space Lighting

Make the lighting fixed to the world. And not follow the camera when you rotate around the scene.

Rotation

The rotation of the light setup. This edit box is just active when you use World Space Lighting.

Show Light Preferences

At the right of the drop down box you will see a tiny button. It will open the preferences, where you can edit the existing studio light setups, or add new Studio light setups. This chapter is explained in the preferences manual part.

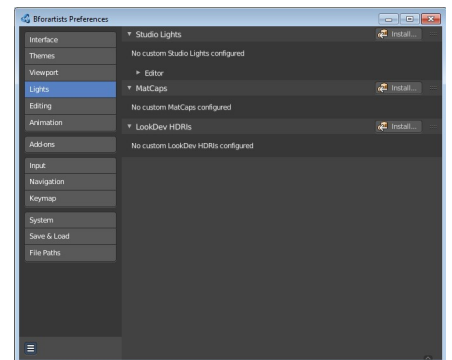

Color

Influence how the objects in the scene are colored. Just one setting can be active at one time.

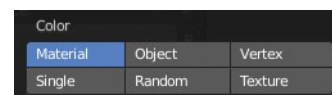

Material

Uses the color of the material, in case a material is assigned to the object(s).

Object

Uses the Object color.

Vertex

Shows the vertex colors in case vertex colors exists.

Single

Define a custom color. A color picker box appears when you activate single.



Random

Colors the objects with a random color

Texture

Shows the texture in case a material with a texture is assigned to the object(s).

Background

Define the look of the viewport background

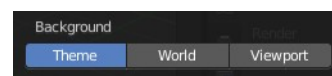

Theme

Uses the background as defined in the theme.

World

Uses the background as defined in the world settings of the scene.

Viewport

Use a custom color. When you activate this setting, then a color picker field appears, adjust a custom color.

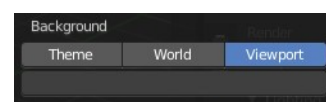

Options

Back face Culling

Use back face culling to hide backsides of faces.

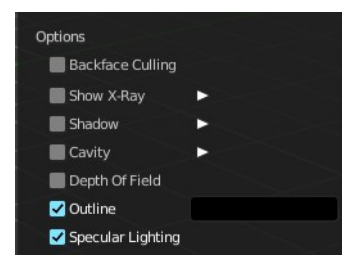

Show X Ray

This viewport setting is connected with the viewport shading. It allows you to show and edit the back geometry. Or hide it, so that you can just see and edit the geometry that points forwards.

Note that you can either have Show X Ray active. Or Shadow and Cavity.

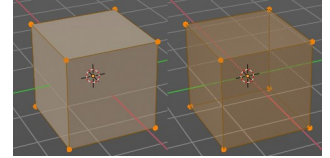

X Ray Alpha

Adjust the strength of the transparency effect.

Shadow

Cast a shadow. Note that the shadow casting light is not part of the chosen studio light. It is an independent light.

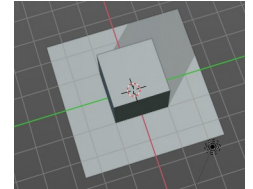

Shadow Intensity

Here you adjust the strength of the shadow. Higher value means darker shadow.

Light Settings

Adjust some settings of the light.

Light Direction

Click into the field and drag the mouse to change the direction of the light that casts the shadow.



Shadow Shift

The shadow termination angle. This can be used to minimize self shadowing artifacts.

Shadow Focus

The shadow hardness. It controls the falloff near the edge of the shadow.

Cavity

Show Cavity. Cavity highlights ridges and valleys in the scene geometry. When you activate this setting, then further settings appears.

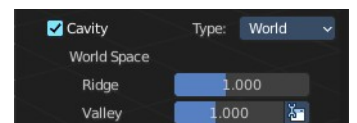

Type

The method how to calculate the cavity. In worlds pace, in screen space. Or in both.

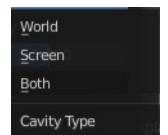

World

Draw the cavity shading in world space.

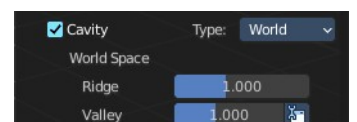

World Space / Ridge Valley

Factor for the cavity ridges and valleys.

Shading Options

Adjust samples, distance and attenuation for the cavity ridges and valleys.

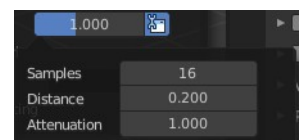

Screen

Draw the cavity shading in Screen space.

Screen Space / Ridge Valley

Factor for the curvature ridges and valleys.



Both

Draw the cavity shading in both, World Space and Screen space.

Settings see above.



Depth of Field

Use depth of field for the viewport. It uses the values from the active camera.

Outline

Show the not selected objects with an outline.

Outline Color

Define the color of the outline for not selected objects.

Specular Lighting

Render specular highlights.

Matcap

Matcap stands for material capture. With Matcap you use a special matcap shader at the mesh. This shader is usually something colorful, which makes for example sculpting easier.

You can choose between several matcap setups in the library menu below. This library menu is a box with a preview of the currently active matcap setup.

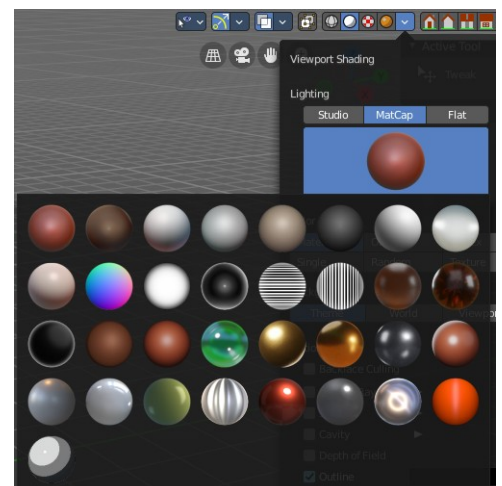

Show Light Preferences

At the right of the library menu box you will see a tiny button. It will open the preferences, where you can edit the existing studio light setups, or add new Studio light setups. This chapter is explained in the preferences manual part.

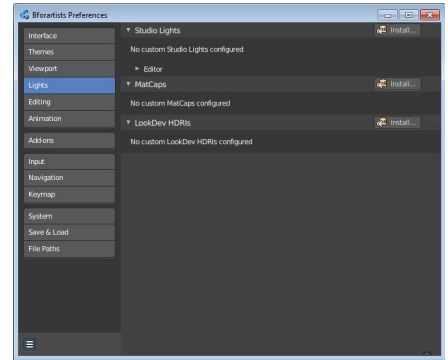

Flip Matcap

Some matcaps have a direction from which the light comes. With Flip Matcap you can flip this direction.



Color

Influence how the objects in the scene are colored. Just one setting can be active at one time.

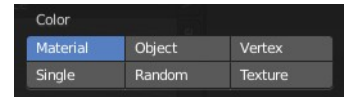

Material

Uses the color of the material, in case a material is assigned to the object(s).

Object

Uses the Object color.

Vertex

Shows the vertex colors in case vertex colors exists.

Single

Define a custom color. A color picker box appears when you activate single.

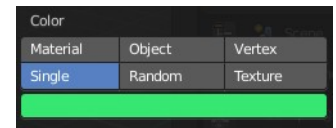

Random

Colors the objects with a random color

Texture

Shows the texture in case a material with a texture is assigned to the object(s).

Background

This defines the look of the viewport background

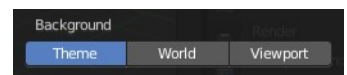

Theme

Uses the background as defined in the theme.

World

Uses the background as defined in the world settings of the scene.

Viewport

Use a custom color. When you activate this setting, then a color picker field appears, adjust a custom color.

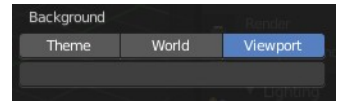

Options

Back face Culling

Use back face culling to hide backsides of faces.

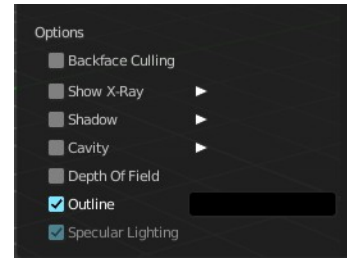

Show X Ray

This viewport setting is connected with the viewport shading. It allows you to show and edit the back geometry. Or hide it, so that you can just see and edit the geometry that points forwards.

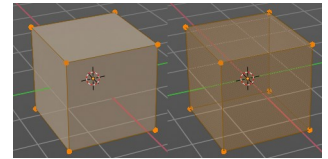

Note that you can either have Show X Ray active. Or Shadow and Cavity. When activating Show X Ray, the other two options will be hidden.

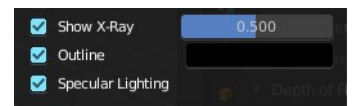

X Ray Alpha

Adjust the strength of the transparency effect.

Shadow

Cast a shadow. Note that the shadow casting light is not part of the chosen studio light. It is an independent light.

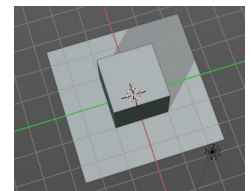

Shadow Intensity

Here you adjust the strength of the shadow. Higher value means darker shadow.

Light Settings

Adjust some settings of the light.

Light Direction

Click into the field and drag the mouse to change the direction of the light that casts the shadow.



Shadow Shift

The shadow termination angle. This can be used to minimize self shadowing artifacts.

Shadow Focus

The shadow hardness. It controls the falloff near the edge of the shadow.

Cavity

Show Cavity. Cavity highlights ridges and valleys in the scene geometry. When you activate this setting, then further settings appears.



Type

The method how to calculate the cavity. In worlds pace, in screen space. Or in both.



World

Draw the cavity shading in world space.



World Space / Ridge Valley

Factor for the cavity ridges and valleys.

Shading Options

Adjust samples, distance and attenuation for the cavity ridges and valleys.

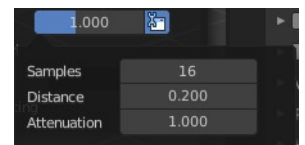

Screen

Draw the cavity shading in Screen space.



Screen Space / Ridge Valley

Factor for the curvature ridges and valleys.

Both

Draw the cavity shading in both, World Space and Screen space.

Settings see above.



Outline

Show the not selected objects with an outline.

Outline Color

Define the color of the outline for not selected objects.

Specular Lighting

Render specular highlights.

Flat

Lights the objects plain white.

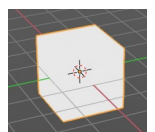
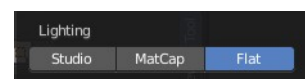

Color

Influence how the objects in the scene are colored. Just one setting can be active at one time.



Material

Uses the color of the material, in case a material is assigned to the object(s).

Object

Uses the Object color.

Vertex

Shows the vertex colors in case vertex colors exists.

Single

Define a custom color. A color picker box appears when you activate single.

Random

Colors the objects with a random color

Texture

Shows the texture in case a material with a texture is assigned to the object(s).

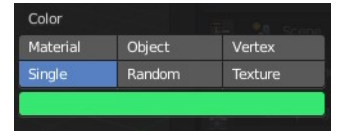

Background

Define the look of the viewport background.

Theme

Uses the background as defined in the theme.

World

Uses the background as defined in the world settings of the scene.

Viewport

Use a custom color. When you activate this setting, then a color picker field appears, adjust a custom color.

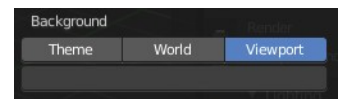
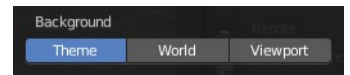

Options

Back face Culling

Use back face culling to hide backsides of faces.

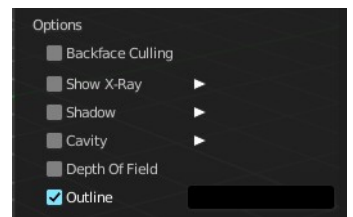

Show X Ray

This viewport setting is connected with the viewport shading. It allows you to show and edit the back geometry. Or hide it, so that you can just see and edit the geometry that points forwards.

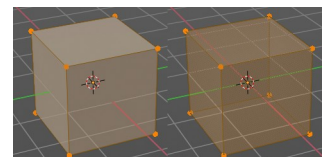

Note that you can either have Show X Ray active.

Or Shadow and Cavity. When activating Show X Ray, the other two options will be hidden.

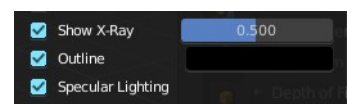

X Ray Alpha

Adjust the strength of the transparency effect.

Shadow

Cast a shadow. Note that the shadow casting light is not part of the chosen studio light. It is an independent light.

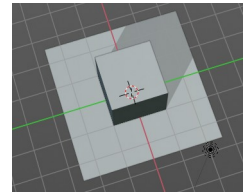

Shadow Intensity

Here you adjust the strength of the shadow. Higher value means darker shadow.

Light Settings

Adjust some settings of the light.

Light Direction

Click into the field and drag the mouse to change the direction of the light that casts the shadow.



Shadow Shift

The shadow termination angle. This can be used to minimize self shadowing artifacts.

Shadow Focus

The shadow hardness. It controls the falloff near the edge of the shadow.

Cavity

Show Cavity. Cavity highlights ridges and valleys in the scene geometry. When you activate this setting, then further settings appears.

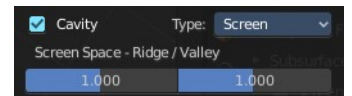

Type

The method how to calculate the cavity. In worlds pace, in screen space. Or in both.

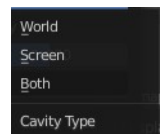

World

Draw the cavity shading in world space.

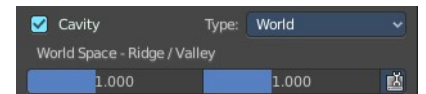

World Space / Ridge Valley

Factor for the cavity ridges and valleys.

Shading Options

Adjust samples, distance and attenuation for the cavity ridges and valleys.

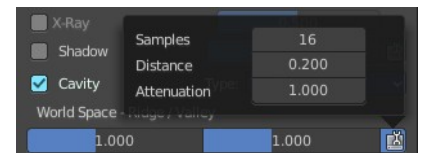

Screen

Draw the cavity shading in Screen space.

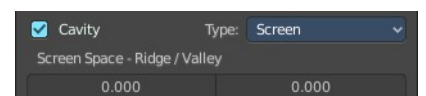

Screen Space / Ridge Valley

Factor for the curvature ridges and valleys.

Both

Draw the cavity shading in both, World Space and Screen space.

Settings see above.

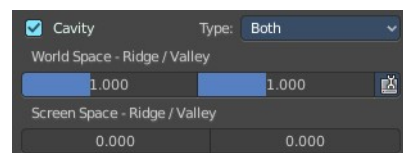

Outline

Show the not selected objects with an outline.

Outline Color

This defines the color of the outline for not selected objects.

Specular Lighting

Render specular highlights.

Viewport Shading with Material Preview

In this mode you can use a hdr file to light the scene.

This mode is just available with Cycles and Eevee renderer. Workspace renderer does not have this mode.

Lighting

Scene Lights

Use the scene lights instead of the hdr to light the scene.

Scene World

Use the scene world to light the scene. This turns off the hdr. And the further options are not longer available.

hdr file browser

Pick a hdr file to light the world with.

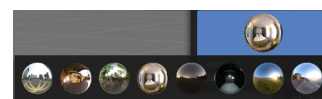
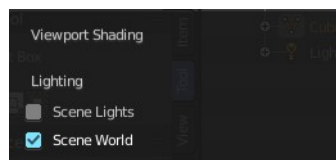
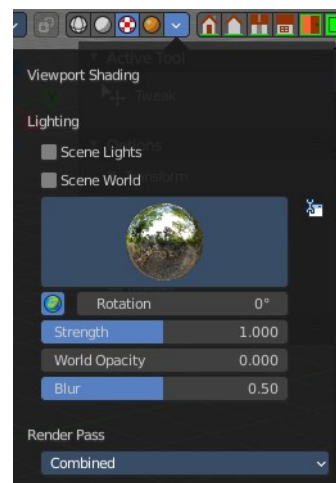

Show light preferences

At the right of the library menu box you will see a tiny button. It will open the preferences, where you can edit the existing studio light setups, or add new Studio light setups. This chapter is explained in the preferences manual part.

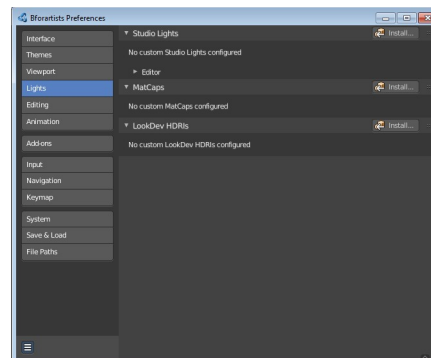

World Space Lighting

Make the hdr rotation fixed, and not follow the camera.

Rotation

The rotation of the hdr file.

Background

Show the studio light in the background. The higher the value the more the studio light gets mixed into the hdr.

World Opacity

Show the studio light in the background

Blur

The blur factor.

Viewport Shading with Rendered

With rendered shading the viewport uses the renderer settings of the chosen render engine. Workbench has no specific shading settings here. And the panel is empty. Cycles and Eevee have some further settings.

Lighting

Scene Lights

Render lights and light probes in the scene.

Scene World

Use scene world for lighting. When you turn off Scene World then you reveal further settings.

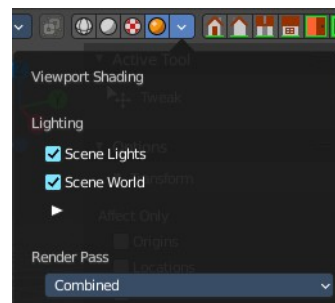

Studiolight Preview

Displays the current active hdri file to light the scene. A click at the display allows you to pick another hdri file.

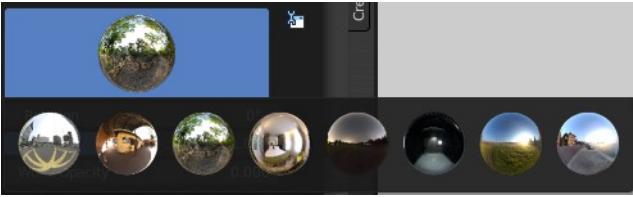

Show Light preferences

Opens the light preferences in the preferences where you can pick more hdri files.

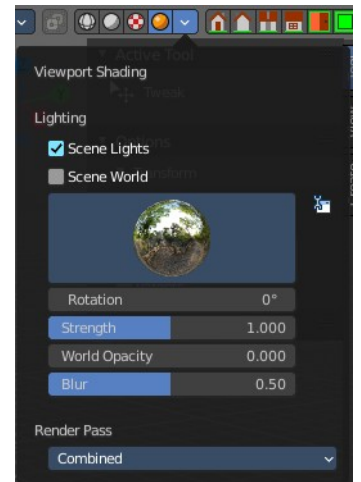

Rotation

The rotation of the studio light.

Strength

The strength of the studio light.

World Opacity

The opacity of the hdri.

Blur

Eevee. Blur the studiolight in the background.

Render Pass

Choose what render passes to calculate.

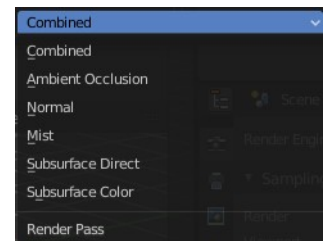

Pause Preview

When you choose the Cycles renderer and set the viewport shading mode to rendered, then it reveals one more button at the right. Pause Preview pauses the rendering in the viewport when Cycles is chosen as the viewport renderer.



Align View Buttons

Align View Buttons

Align View Buttons is an addon. The buttons allows you to align the view to the orthographic views. And brings further functionality from the View menu and other hard to reach locations.

The content is all a double entry by purpose, to have these buttons at the top hierarchical position for quick access. And it is already described at the original UI position. So we won't go into detail here.

This addon can be turned off in the Preferences.

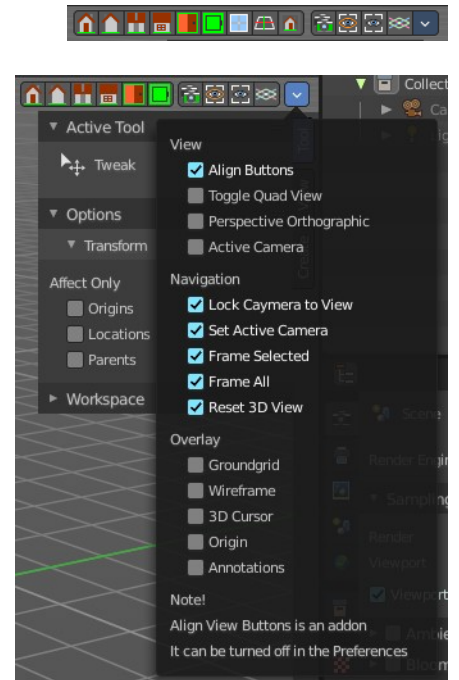

Grease Pencil - all modes - Layer Panel

This panel shows in most of the modes. It is the same content than the Layers panel in the Object Data Properties.

Layer list

Layer name

The name of the layer.

Mask Layer

Toggle the Masks visibility in the layer.

Onion Skinning

Toggle the use the layer for Onion Skinning.

Viewport/Render Visibility

Toggle layer visibility in the viewport and in render.

Lock

Toggle layer from being editable.



Search Field

You can expand a search field at the bottom of the list. Type in your term and hit enter to filter for your term.



Add new layer

Adds a new layer.

Remove layer

Removes the selected layer.

Layer Specials

Duplicate Layer

Makes an exact copy of the selected layer appending a number to differentiate its name.

Duplicate Empty Keyframes

Makes a copy of the active grease pencil layer.

Show All

Turns on the visibility of every layer in the list.

Hide Others

Turns off the visibility of every layer in the list except the active one.

Lock All

Locks edition of all the layers in the list

Unlock All

Unlocks edition of all the layers in the list.

Autolock inactive layer

Locks automatically the edition of every layer in the list except the active one. This way you avoid to make unwanted changes in other layers without the need to lock them every time.

Merge Down

Merge the selected layer with the layer below, the new layer keeps the name of the lower layer.

Copy Layer to Object

Makes a copy of the layer and move it to the selected Grease Pencil object.

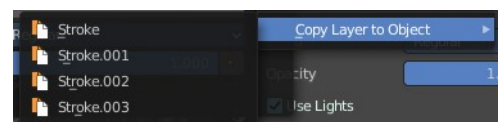
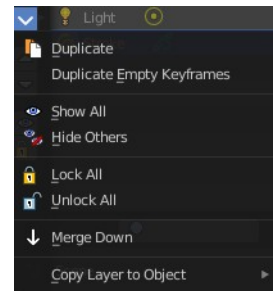

Isolate Layer

Hide and lock the layer.

Isolate Layer

Lock the layer.

Blend

The layer blending operation to perform. See Color Blend Modes.

Opacity

Used to set the opacity of the layer.



Use Lights

When enabled, the layer is affected by lights.

Grease Pencil - Edit mode - Options Panel

Scale Stroke Thickness

Scale the stroke thickness when transforming strokes.

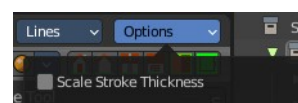

Grease Pencil - Sculpt mode - Auto-masking Panel

Automasking settings.

Stroke

Affect only strokes below the cursor that are the same stroke.

Layer

Affect only strokes below the cursor that are at the same layer.

Material

Affect only strokes below the cursor that have the same material.

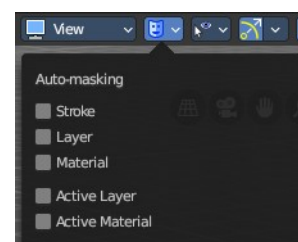

Active Layer

Affect only the active layer.

Active material

Affect only strokes with the active material.

7.1.10 Editors - 3D Viewport - Header - Mesh - Edit Mode - Vertex Menu

Table of content

Detailed table of content.....	1
Edit Mode - Vertex Menu.....	4
Legacy.....	4
Extrude to Cursor or Add.....	9
Make Edge/Face.....	9
Connect Vertex Path.....	10
Connect Vertex Pair.....	10
Smooth Laplacian.....	10
Vertex Crease.....	11
Merge Vertices.....	12
By Distance.....	12
Vertex Groups.....	13
Hooks.....	14
Make Vertex Parent.....	15

Detailed table of content

Detailed table of content

Detailed table of content.....	1
Edit Mode - Vertex Menu.....	4
Legacy.....	4
Bevel.....	4
Last Operator Bevel.....	4
Affect.....	4
Width type.....	4
Segments.....	4
Shape.....	4
Material Index.....	5
Harden Normals.....	5
Clamp Overlap.....	5
Loop Slide.....	5
Mark Seams.....	5
Mark Sharp.....	5
Outer Miter.....	5
Sharp.....	5
Patch.....	5
Arc.....	5
Inner Miter.....	5
Sharp.....	5
Arc.....	5
Spread.....	6
Intersections.....	6
Face Strength Mode.....	6
None.....	6

New.....	6
Affected.....	6
All.....	6
Rip Vertices.....	6
Last Operator Rip.....	6
Move X , Y , Z.....	6
Constraint Axis.....	7
Orientation.....	7
Proportional editing.....	7
Proportional Falloff.....	7
Proportional Size.....	7
Connected.....	7
Projected(2D).....	7
Rip Vertices and Fill.....	7
Rip Vertices and Extend.....	7
Last Operator Extend Vertices.....	7
Move X , Y , Z.....	7
Constraint Axis.....	7
Orientation.....	7
Proportional editing.....	8
Proportional Falloff.....	8
Proportional Size.....	8
Connected.....	8
Projected(2D).....	8
Vertex Slide.....	8
Last Operator Vertex Slide.....	8
Factor.....	8
Even.....	8
Flipped.....	8
Clamp.....	8
Correct UV's.....	8
Smooth.....	9
Last Operator Smooth Vertices.....	9
Smoothing.....	9
Repeat.....	9
X Axis, Y Axis, Z Axis.....	9
Extrude to Cursor or Add.....	9
Last Operator Extrude to Cursor or Add.....	9
Location X Y Z.....	9
Make Edge/Face.....	9
Connect Vertex Path.....	10
Connect Vertex Pair.....	10
Smooth Laplacian.....	10
Last Operator Laplacian Smooth Vertex.....	10
Number of Iterations.....	10
Lambda Factor.....	10
Lambda Factor in border.....	10
Smooth Axis.....	10
Preserve Volume.....	10
Vertex Crease.....	11
Last Operator Vertex Crease.....	11
Factor.....	11
Blend from Shape.....	11

Last Operator Blend from Shape.....	11
Drop-down box.....	11
Blend edit box.....	11
Add.....	11
Propagate to Shapes.....	11
Merge Vertices.....	12
At First.....	12
At Last.....	12
At Center.....	12
At Cursor.....	12
Collapse.....	12
Last Operator Merge.....	12
Type.....	12
UV's.....	12
By Distance.....	12
Last Operator Merge by Distance.....	12
Merge Distance.....	12
Unselected.....	12
Vertex Groups.....	13
Assign to New Group.....	13
Assign to active Group.....	13
Remove from Active Group.....	13
Remove from All.....	13
Set Active Group.....	13
Remove Active Group.....	13
Remove All Groups.....	14
Hooks.....	14
Hook to New Object.....	14
Hook to Selected Object.....	14
Last Operator Hook to Selected Object.....	14
Active Bone.....	14
Hook to Selected Object Bone.....	14
Assign to Hook.....	14
Remove Hook.....	15
Select Hook.....	15
Reset Hook.....	15
Recenter Hook.....	15
Make Vertex Parent.....	15
Workflow:.....	15

Edit Mode - Vertex Menu

The Vertex menu just exists for mesh objects. It provides you with tools that are designed to modify vertices.

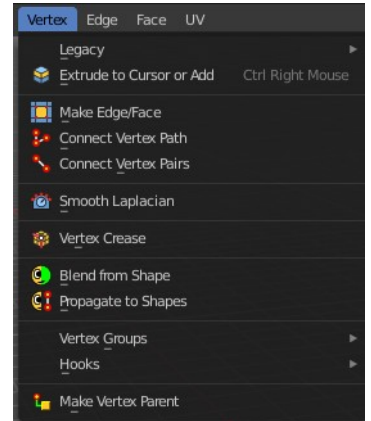

Legacy

The legacy sub menu contains tools that exists in the tool shelf already. It's the old way to do things. Different to the tools in the tool shelf, these tools are usually modal. And performs once. You have to call them again in case you want to repeat the tool.

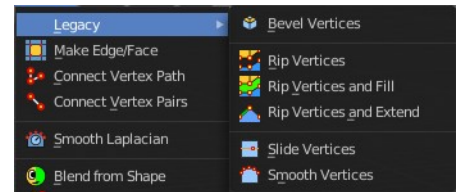

Bevel

The Bevel Tool adds a bevel to the selected geometry.

Usage: first select the geometry that you want to bevel. Then activate the tool. Don't wonder that the mouse movement does nothing until you move the mouse really really far away. That's by design. Best is to adjust the amount in the Last Operator Bevel panel.

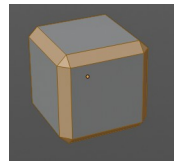

Last Operator Bevel

Affect

What geometry to bevel. Vertices or Edges.

Width type

Which measure type to choose for the bevel action. Offset, Width, Depth or Percent.

Segments

How many segments gets created.

Shape

Controls the profile shape strength. A value close to 0 bends the roundness to inside. A value towards 1 bends the curve to outside. A value of 0.5 defines a radius around the center point of the bevel.

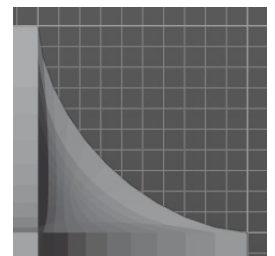
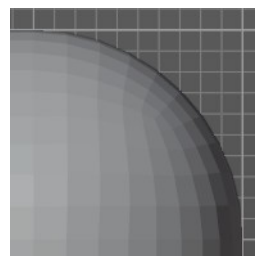
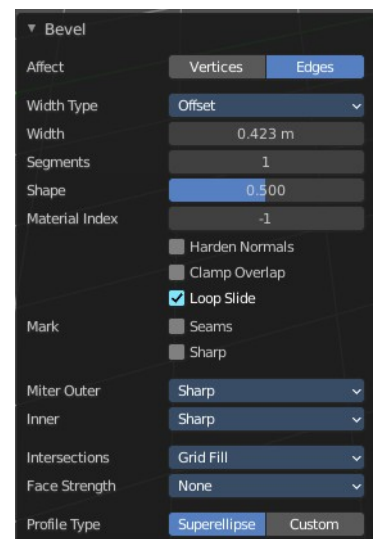

Material Index

The material for bevel faces. -1 means to use the material from the adjacent faces.

Harden Normals

Match normals of new faces to adjacent faces.

Clamp Overlap

Do not allow beveled geometry to overlap each other.

Loop Slide

Prefer slide along edge to even widths.

Mark Seams

Mark the edges of the new created geometry as seams.

Mark Sharp

Mark the edges of the new created geometry sharp.

Outer Miter

How the outer miter is set. Miter is how the bevel rounding at a corner is done.



Sharp

Creates a sharp miter.

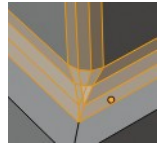

Patch

This replaces the outside vertex of a miter with 3 vertices. And uses a patch pattern there.

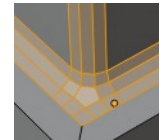

Arc

This replaces the vertex of a miter with 2 vertices, joined by an arc. A separate Spread parameter says how far to move the vertices away from their original position.

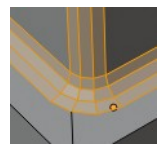

Inner Miter

How the inner miter is set. Miter is how the bevel rounding at a corner is done.

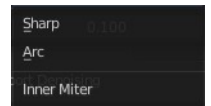

Sharp

Creates a sharp miter.

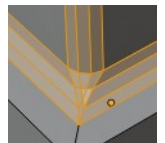

Arc

This replaces the vertex of a miter with 2 vertices, joined by an arc. A separate Spread parameter says how far to move the vertices away from their original position.

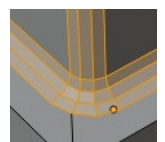

Spread

Belongs to inner miter method Arc. Adjust how strong the inner radius is bent.

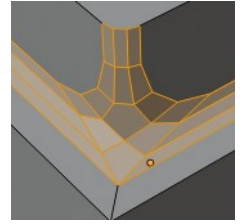

Intersections

The method to use to create meshes at intersections. Bevel can create self intersecting geometry.



Face Strength Mode

Set Face Strength on the faces involved in the bevel, according to the specified mode. This can be used in conjunction with a Weight Normals Modifier (with the Face Influence option checked).

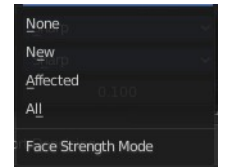

None

Do not set face strength.

New

Set the face strength of new faces along edges to Medium, and the face strength of new faces at vertices to Weak.

Affected

In addition to those set for the New case, also set the faces adjacent to new faces to have strength Strong.

All

In addition to those set for the Affected option, also set all the rest of the faces of the model to have strength Strong.

Rip Vertices

Rip splits the edges between the selected vertices. It creates two edges out of one.

This tool works similar to the Edge Split tool. It also selects the outer edges so that you immediately move them. Right click will snap them back to the initial space.

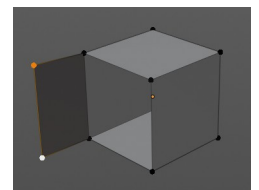

Last Operator Rip

Move X , Y , Z

Adjust the position.

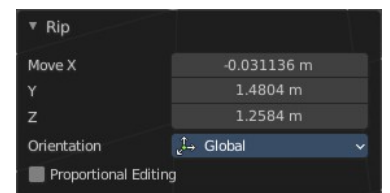

Constraint Axis

Limit the position relative to the source object.

Orientation

Orientation is a drop-down box. Choose the type of orientation for the mirroring action.

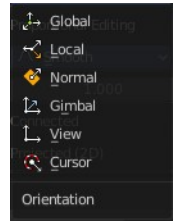

Proportional editing

Enables proportional editing. Activating proportional editing reveals further settings.

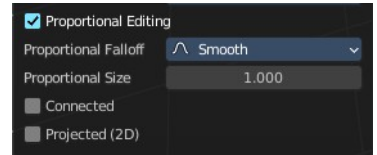

Proportional Falloff

Adjust the falloff methods.

Proportional Size

See and adjust the falloff radius.

Connected

The proportional falloff gets calculated for connected parts only.

Projected(2D)

The proportional falloff gets calculated in the screen space. Depth doesn't play a role. When it's in the radius, then it gets calculated.

Rip Vertices and Fill

Rip splits the edges between the selected vertices. It creates two edges out of one. But fills the gap.

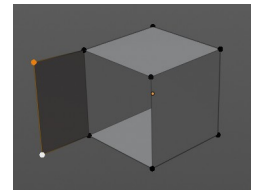

The last operator is the same than for the rip vertices tool above.

Rip Vertices and Extend

This tool is the same tool than the Rip Edge tool from the tool shelf.

Rip Vertices and Extend extrudes out the selected vertices. When you do this operation at an edge then you will create N-Gons that way.

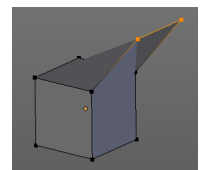

Last Operator Extend Vertices

Move X , Y , Z

Adjust the position.

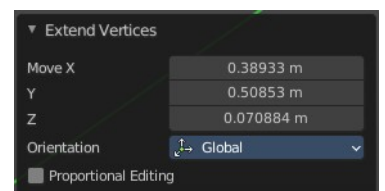

Constraint Axis

Limit the position relative to the source object.

Orientation

Orientation is a drop-down box. Choose the type of orientation for the mirroring action.

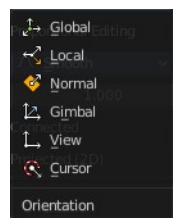

Proportional editing

Enables proportional editing. Activating proportional editing reveals further settings.

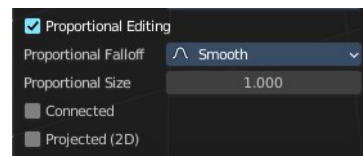

Proportional Falloff

Adjust the falloff methods.

Proportional Size

See and adjust the falloff radius.

Connected

The proportional falloff gets calculated for connected parts only.

Projected(2D)

The proportional falloff gets calculated in the screen space. Depth doesn't play a role. When it's in the radius, then it gets calculated.

Vertex Slide

Same tool than the Vertex Slide in the Tool Shelf. Vertex Slide slides the selected vertice along the edge that it is part of. This is for the corner vertice at a cube into three possible directions.

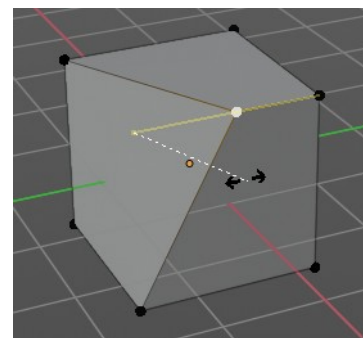

Last Operator Vertex Slide

Factor

Factor is a sliding box Adjust the slide strength numerically. The width of the face is the 0-1 range.

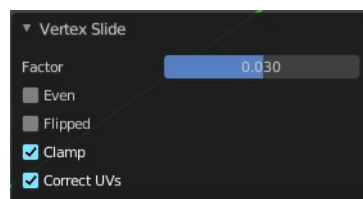

Even

Make the Edge loop match the shape of the adjacent edge loop.

Flipped

When Even Mode is active, flips between the two adjacent edge loops.

Clamp

Clamp within the edge extend.

Correct UV's

Correct UV's corrects the UV's while editing the geometry.

Smooth

Same tool than in the tool shelf. Smoothens the selected vertices.

Last Operator Smooth Vertices

Smoothing

The smoothing factor.

Repeat

How often the smoothing should be applied.

X Axis, Y Axis, Z Axis

Which axis to affect.

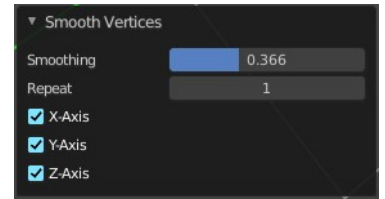

Extrude to Cursor or Add

Hotkey only tool. Extrude to the mouse position.

Last Operator Extrude to Cursor or Add

Location X Y Z

The location to extrude to.

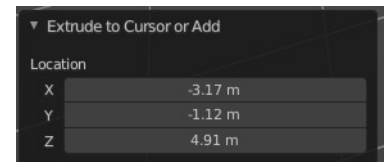

Make Edge/Face

Adds a face when you have edges selected. And Edges when you have Vertices selected. It's a Bridge tool.

You can have either the one method or the other. When you select two adjacent vertices, then you select the edge too. And the tool works in edge mode then. In this case just the possible faces gets created. Not edges between single vertices.

First select the edges or Vertices that you want to bridge. Then click the New Edge/Face from Vertices Button.

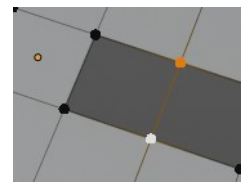
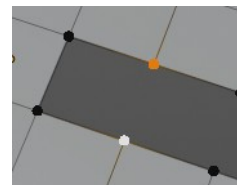
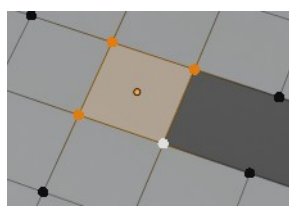
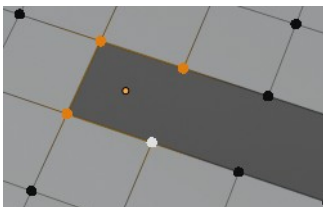

Connect Vertex Path

Connect Vertex path connects selected vertices, but takes the vertex order into account in which you selected the vertices. It just creates edges between vertices that are not connected in this order.

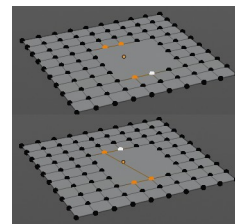

Connect Vertex Pair

Connect Vertex pair connects selected vertices and makes a face of the pairs.

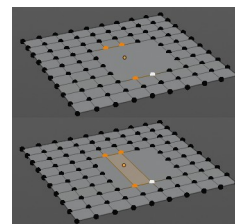

Smooth Laplacian

Laplacian Smooth Vertex smooths out the angles between the selected vertices. It is a tool to reduce noise at the mesh. It works a bit different than the normal Smooth Vertex tool. And gives a different result. The Laplacian method allows you to preserve the volume, and to adjust border smoothing.

Last Operator Laplacian Smooth Vertex

Number of Iterations

Number of Iterations is the number of iterations that the smoothing action gets repeated. With 1 the smoothing is just performed once. With 10 it is performed ten times.

Lambda Factor

Lambda Factor is the strength of the smoothing.

Lambda Factor in border

Lambda Factor is the strength of the smoothing in border areas.

Smooth Axis

The Smooth Axis check boxes allows you to limit the smoothing to specific world axis.

Preserve Volume

Preserve Volume preserves the volume of the object.

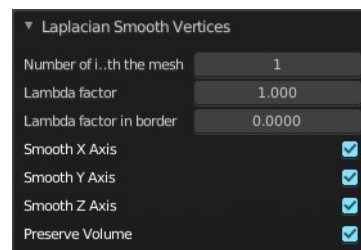

Vertex Crease

When you use a Subdivision Surface Modifier, then you can define the sharpness of selected vertices with this tool. Crease vertices will be marked colored in edit mode.

You will see a value in the header that indicates the current strength when you activate the tool. Move with the mouse to increase or decrease the value. Or type in a value while you are in this mode. You can also scale into negative range.

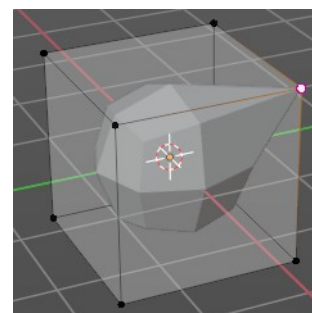

A negative crease value will subtract from the current active crease value in case it exists already from a former crease operation. A Crease value of -1 removes the crease from this edge.

Crease: -0.150

Last Operator Vertex Crease

Factor

Adjust the crease factor.



Blend from Shape

This tool requires to have a shape key at the mesh. It blends the selected shape key into the mesh.

Last Operator Blend from Shape

Drop-down box

Define which shape key should be used.

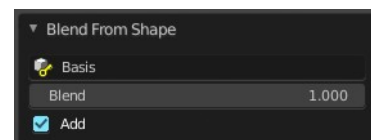
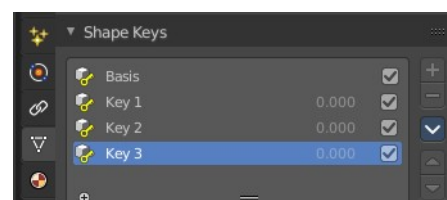

Blend edit box

Adjust the blend factor between the current shape and the shape that you want to blend here.

Add

Add to blend shape instead of blending in.

Propagate to Shapes

This tool requires to have a shape key at the mesh. It applies the current vertex locations for the selected vertices to all other shape keys at the mesh.

Merge Vertices

Merge vertices together. When you pick a vertice, and add more vertices to the selection, then you get two more tools, to merge to the first or last vertice. When you box select, or use select all, then you get just the other three tools.



At First

Merges the current selected vertices at the first selected vertice.

At Last

Merges the current selected vertices at the last selected vertice.

At Center

Merges the geometry at the center of the selected vertices.

At Cursor

Merges the geometry at the 3D Cursor.

Collapse

Merges the geometry at the center of the selected vertices.

Last Operator Merge

Type

Type is the drop-down box again where you can choose what method to use for merge.

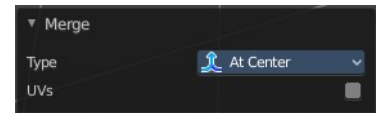

UV's

With UV's ticked the UV mapping will update with changes at the geometry.

By Distance

Merges vertices that are very close to each other. The merge happens at the center. When you need more control then you should use the Merge Vertices tool.

Last Operator Merge by Distance

Merge Distance

Adjust the distance in which the vertices gets merged.

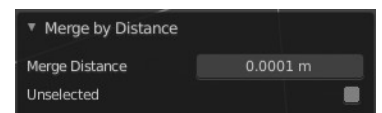

Unselected

Merge selected vertices also with other unselected vertices.

Vertex Groups

Vertex groups is a menu around vertex group functionality. The vertex groups can be found in the Object data tab in the Properties editor.

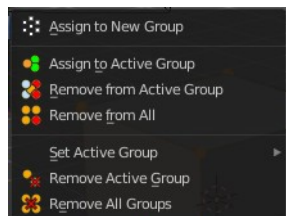

When there is no vertex group assigned yet then you can only see one menu item. The Assign To New Group button.

Once you have a vertex group assigned you will see the full functionality.

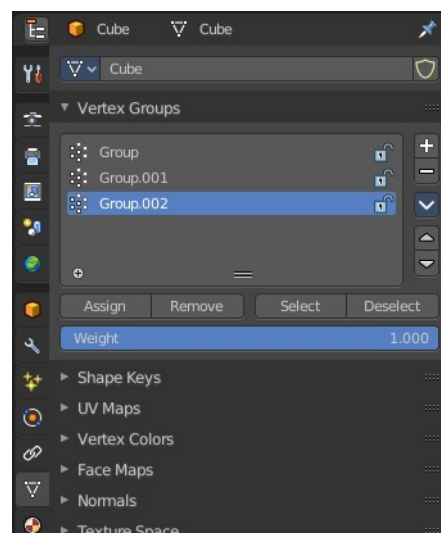

Assign to New Group

Assigns the mesh selection to a new vertex group.

Assign to active Group

Assigns the mesh selection to the currently active vertex group.

Remove from Active Group

Removes the mesh selection from the currently active vertex group.

Remove from All

Removes the mesh selection from all vertex groups.

Set Active Group

Select a vertex group to be the active one.

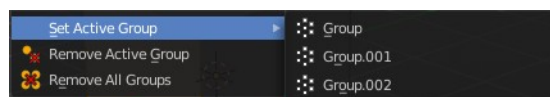

Remove Active Group

Removes the currently active vertex group.

Remove All Groups

Removes all vertex groups from the mesh.

Hooks

Hooks is a menu with tools around the hook modifier. You could also adjust the hook modifier from the Properties editor. But the menu items are more accessible.

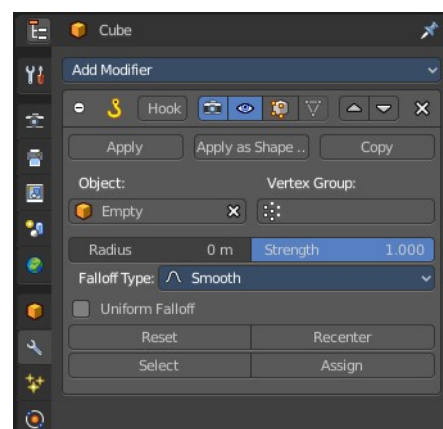
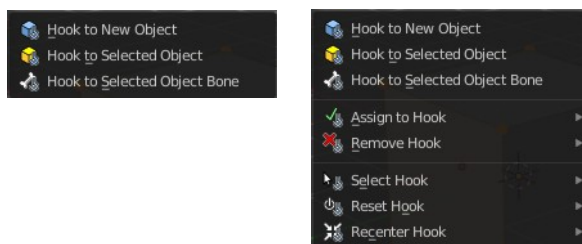

When there is no hook modifier at the mesh then you just see three menu items. When there is minimum one hook modifier applied, then you will see an extended menu.

Hook to New Object

Creates a new Hook Modifier for the active object and assigns it to the selected vertices. It also creates an empty at the center of those vertices, which are hooked to it.

Hook to Selected Object

Does the same as *Hook to New Object*, but instead of hooking the vertices to a new empty, it hooks them to the selected object (if it exists). There should be only one selected object (besides the mesh being edited).

Last Operator Hook to Selected Object

Active Bone

Hook to the object(s) of the active bone.

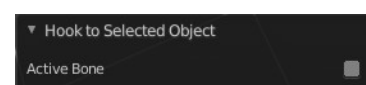

Hook to Selected Object Bone

Does the same as *Hook to New Object*. But it sets the last selected bone in the also selected armature as a target.

Assign to Hook

Assign the selected vertices to the chosen hook modifier. Existing hooks gets overwritten. One vertex can be

assigned to more than one hook.

Remove Hook

Removes the chosen Hook Modifier from the object.

Select Hook

Selects all vertices assigned to the chosen Hook Modifier.

Reset Hook

Resets the chosen Hook Modifier.

Recenter Hook

Recenter the Hook Modifier.

Make Vertex Parent

Parents another object to the selected vertice(s).

Workflow:

In Object mode select the object that you want to parent to a vertex. Shift select the parent object so that both are selected. Enter Edit mode. Then select one vertex for a single point. Or three for an area. Then click the Make Vertex Parent button to make the relation.

7.1.11 Editors - 3D Viewport - Header - Mesh - Edit mode - Edge Menu

Table of content

Detailed Table of content.....	1
Edit Mode - Edge Menu.....	3
Legacy.....	3
Bridge Edge loops.....	7
Subdivide.....	8
Un-Subdivide.....	10
Rotate Edge CW.....	10
Rotate Edge CCW.....	10
Edge Crease.....	11
Edge Bevel Weight.....	11
Mark Sharp.....	12
Clear Sharp.....	12
Mark Sharp from Vertices.....	12
Clear Sharp from Vertice.....	12
Mark Freestyle Edge.....	12
Clear Freestyle Edge.....	13

Detailed Table of content

Detailed table of content

Detailed Table of content.....	1
Edit Mode - Edge Menu.....	3
Legacy.....	3
Bevel Edges.....	4
Last Operator Bevel.....	4
Width type.....	4
Width.....	4
Segments.....	4
Profile.....	4
Vertex only.....	4
Clamp Overlap.....	4
Loop Slide.....	4
Mark Seams.....	4
Mark Sharp.....	5
Material.....	5
Harden Normals.....	5
Face Strength Mode.....	5
None.....	5
New.....	5
Affected.....	5
All.....	5
Outer Miter.....	5
Sharp.....	5

Patch.....	5
Arc.....	5
Inner Miter.....	5
Sharp.....	6
Arc.....	6
Spread.....	6
Edge Slide.....	6
Header Values.....	6
Last Operator Edge Slide.....	6
Factor.....	6
Even.....	6
Flipped.....	6
Clamp.....	6
Correct UV's.....	7
Offset Edge Slide.....	7
Last Operator Offset Edge Slide.....	7
Cap Endpoint.....	7
Edge Slide Factor.....	7
Even.....	7
Flipped.....	7
Clamp.....	7
Correct UV's.....	7
Bridge Edge loops.....	7
Last Operator Bridge Edge loops.....	7
Connect Loops.....	7
Merge.....	8
Merge Factor.....	8
Twist.....	8
Number of Cuts.....	8
Interpolation.....	8
Smoothness.....	8
Profile Factor.....	8
Profile shape.....	8
Subdivide.....	8
Last Operator Subdivide.....	8
Number of Cuts.....	8
Smoothness.....	9
Create N-Gons.....	9
Quad Corner Type.....	9
Fractal.....	9
Along Normal.....	9
Random Seed.....	9
Subdivide Edge ring.....	9
Last Operator Subdivide Edge ring.....	9
Number of Cuts.....	9
Interpolation.....	9
Smoothness.....	9
Profile Factor.....	10
Profile Shape.....	10
Un-Subdivide.....	10
Last Operator Un-Subdivide.....	10
Iterations.....	10
Rotate Edge CW.....	10

Last Operator Rotate Selected Edge.....	10
Counter Clockwise.....	10
Rotate Edge CCW.....	10
Last Operator Rotate Selected Edge.....	10
Counter Clockwise.....	10
Edge Crease.....	11
Last Operator Edge Crease.....	11
Factor.....	11
Edge Bevel Weight.....	11
Last Operator Edge Bevel Weight.....	11
Factor.....	11
Mark Sharp.....	12
Last Operator Mark Sharp.....	12
Vertices.....	12
Clear Sharp.....	12
Last Operator Mark Sharp.....	12
Vertices.....	12
Mark Sharp from Vertices.....	12
Clear Sharp from Vertice.....	12
Mark Freestyle Edge.....	12
Clear Freestyle Edge.....	13

Edit Mode - Edge Menu



Legacy

The legacy sub menu contains tools that exists in the tool shelf already. It's the old way to do things. Different to the tools in the tool shelf, these tools are usually modal. And performs once. You have to call them again in case you want to repeat the tool.

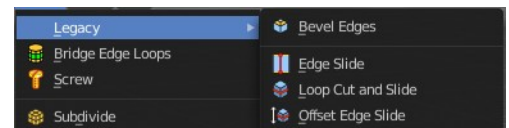

Bevel Edges

The Bevel Tool adds a bevel to the selected Edges.

Usage: first select the geometry that you want to bevel. Then activate the tool and drag the mouse. You need to drag quite a bit outwards until you see an effect. So don't wonder when the mouse movement seem to do nothing. You can also adjust the amount in the Last Operator Bevel panel afterwards.

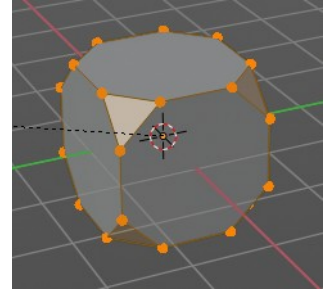

In the header you can see further advice. And the current values for the bevel.

```
Enter/PadEnter/LMB: confirm, Esc/RMB: cancel, M: mode (Offset), A: width (0.172 m), S: segments (1), P: profile (0.500)
```

Last Operator Bevel

Width type

Width Type is a drop-down box choose the Amount type for the bevel action.

Width

The Bevel amount.

Segments

How many segments gets created

Profile

Controls the Profile shape. 0.5 means round.

Vertex only

Bevel Vertices only.

Clamp Overlap

Do not allow beveled geometry to overlap each other.

Loop Slide

Prefer slide along edge to even widths.

Mark Seams

Mark seams along the beveled edges.

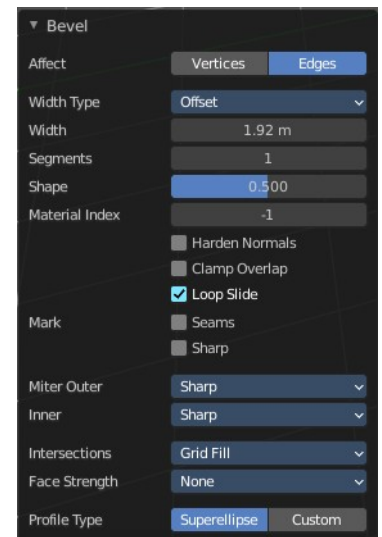
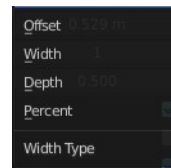

Mark Sharp

Mark the beveled edges sharp.

Material

Material for beveled faces. -1 is the surrounding material.

Harden Normals

Match the normals of the new faces to the adjacent faces.

Face Strength Mode

Face Strength Mode can be used in conjunction with Weight Normals Modifier (with the 'Face Influence' option checked). Set if and how the face strength at creation gets set.



None

Don't set face strength.

New

Set the face strength of new faces along edges to Medium. And the face strength of new edges at vertices to Weak.

Affected

In addition to those set for the New case, also set the faces adjacent to new faces to have strength Strong.

All

In addition to those set for the Affected case, also set all the rest of the faces of the model to have strength Strong.

Outer Miter

How the outer miter is set. Miter is how the bevel rounding at a corner is done.



Sharp

Creates a sharp miter.

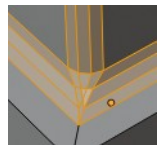

Patch

This replaces the outside vertex of a miter with 3 vertices. And uses a patch pattern there.

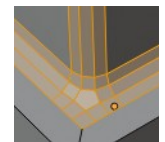

Arc

This replaces the vertex of a miter with 2 vertices, joined by an arc. A separate Spread parameter says how far to move the vertices away from their original position.

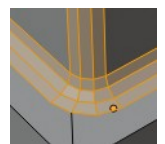

Inner Miter

How the inner miter is set. Miter is how the bevel rounding at a corner is done.

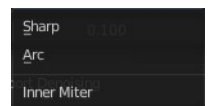

Sharp

Creates a sharp miter.

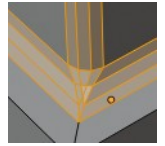

Arc

This replaces the vertex of a miter with 2 vertices, joined by an arc. A separate Spread parameter says how far to move the vertices away from their original position.

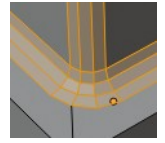

Spread

Belongs to inner miter method Arc. Adjust how strong the inner radius is bent.

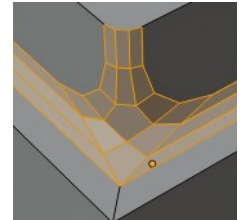

Edge Slide

Same tool than in the tool shelf. Edge Slide slides the selected edge along the face that it is part of. This is for the edge at a cube into two possible directions.

This tool requires to have at least one edge selected.

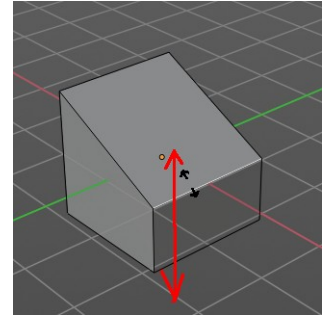
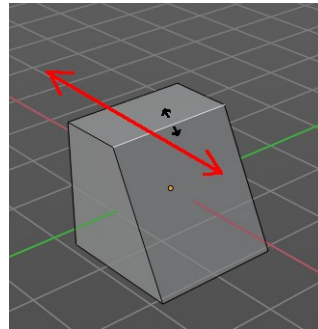

Header Values

The header values shows you the current transformation. But also hints towards a hotkey.

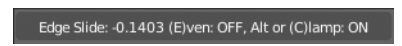

Holding down ALT will allow you to slide the edges behind the limits of the guide edge. Yellow infinite guide lines appears.

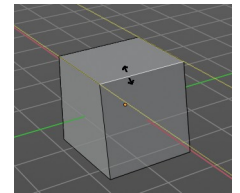

Last Operator Edge Slide

Factor

Factor is a sliding box Adjust the slide strength numerically. The width of the face is the 0-1 range.



Even

Make the Edge loop match the shape of the adjacent edge loop.

Flipped

When Even Mode is active, flips between the two adjacent edge loops.

Clamp

Clamp within the edge extend.

Correct UV's

Correct UV's corrects the UV's while editing the geometry.

Offset Edge Slide

The tool is called Offset Edge Loop Cut in the tool shelf. Slides the selected edge(s).

Usage: select the edges that you want to slide. Click to confirm.

You can adjust the sliding amount in the Last Operator Offset Edge Slide.

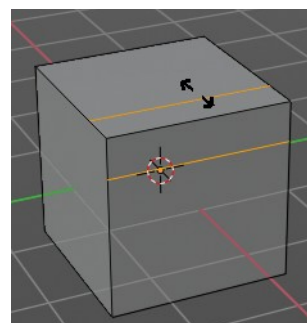

Last Operator Offset Edge Slide

Cap Endpoint

Cap Endpoint caps the loose edges.

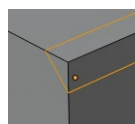

Edge Slide Factor

Adjust the slide amount.

Even

Make the edge loop match the shape of the adjacent edge loop

Flipped

When Even mode is active, flips between the two adjacent edge loops.

Clamp

Clamp within the edge extend.

Correct UV's

Corrects the UV's when modifying the geometry.

Bridge Edge loops

The Bridge edge loops tool bridges selected edges, and adds a polygon between them. You need to have at least two edges selected.

Last Operator Bridge Edge loops

Connect Loops

Choose the method how to deal with bridging multiple loops.

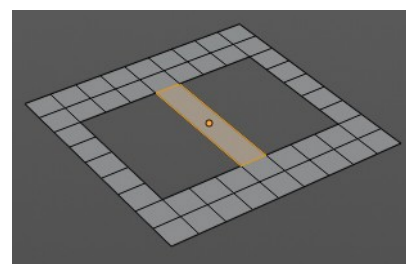

Merge

With merge ticked it will not create a bridge face, but merge the selected edges.

Merge Factor

The merge factor determines at which distance between the selected edges the merge happens. 0.5 is the middle of the selected edges.

Twist

The twist offset for closed loops.

Number of Cuts

Adds cuts to the bridge face.

Interpolation

Choose the interpolation mode for the cuts.

Smoothness

Adjust the smoothness for the cuts.

Profile Factor

Adjust the profile factor for the cuts.

Profile shape

Adjust the profile shape for the cuts.

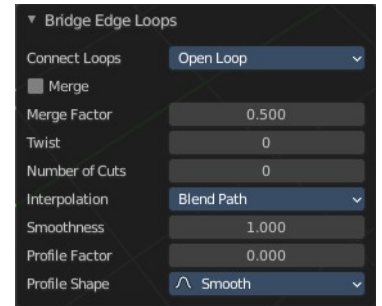

Subdivide

Subdivide divides the selected edges. It subdivides the involved faces too, and can create new vertices.

A more unknown functionality is that it can also randomize the result with the Fractal slider in the Last operator panel.

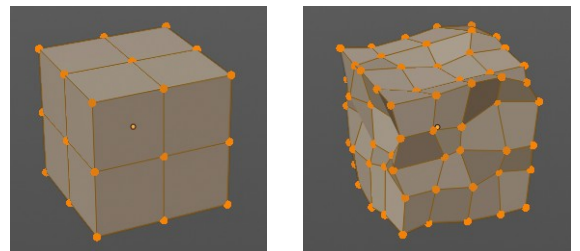

Last Operator Subdivide

Number of Cuts

The number of cuts defines the amount of subdivisions.

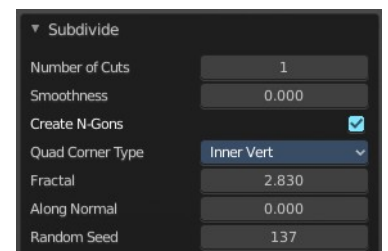

Smoothness

This value defines how smooth the subdivision result is. From flat to bent.

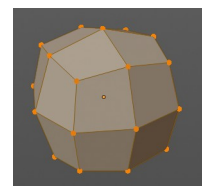

Create N-Gons

Create N-Gons if required. Else subdividing N-Gons creates Tris.

Quad Corner Type

Adjust the corner type.

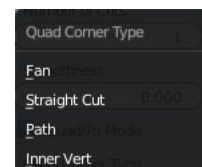

Fractal

Randomize the selected vertices.

Along Normal

When randomized, this value defines how strong the subdivision follows the normals of the initial vertices.

Random Seed

Randomizing value for fractal randomizing.

Subdivide Edge ring

Subdivides the selected edge ring(s).

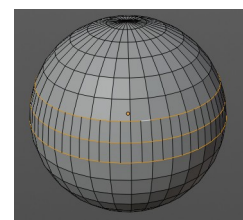

Last Operator Subdivide Edge ring

Number of Cuts

Adjust the number of cuts for the subdivision.

Interpolation

Choose an interpolation method for the new geometry.

Linear ends in an equal division and a flat result. Blend Surface interpolates the surrounding geometry. And can end in a curvy result.

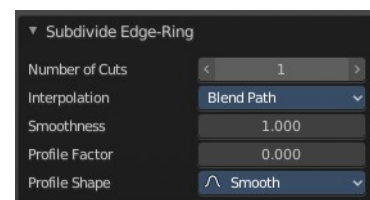

Smoothness

The Smoothness factor for the interpolation.



Profile Factor

The profile strength.

Profile Shape

A drop-down box where you can define a profile for the generated geometry.

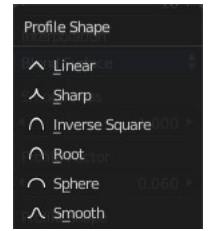

Un-Subdivide

Decimates the geometry by trying to make one quad out of four quads. But can also end in Tris where this is not possible.

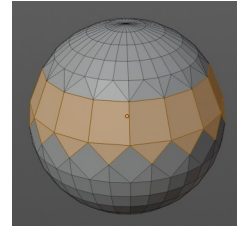

Last Operator Un-Subdivide

Iterations

Number of iterations. This means how deep the calculation should go. One level of SDS, two levels, three levels, etc.. Down to the point where you cannot decimate any geometry anymore.



Rotate Edge CW

Rotate Edge rotates the selected edge clockwise.

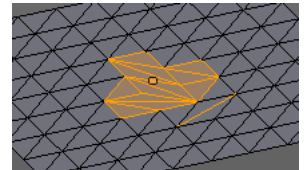

Last Operator Rotate Selected Edge

Counter Clockwise

Rotate selected edges counter clockwise.

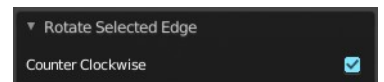

Rotate Edge CCW

Rotate Edge rotates the selected edge counter clockwise.

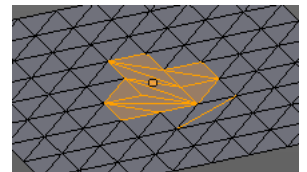

Last Operator Rotate Selected Edge

Counter Clockwise

Rotate selected edges counter clockwise.

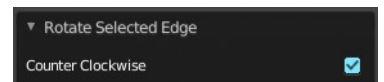

Edge Crease

When you use a Subdivision Surface Modifier, then you can define the sharpness of selected edges with this tool. Crease edges will be marked colored in edit mode.

You will see a value in the header that indicates the current strength when you activate the tool. Move with the mouse to increase or decrease the value. Or type in a value while you are in this mode. You can also scale into negative range.

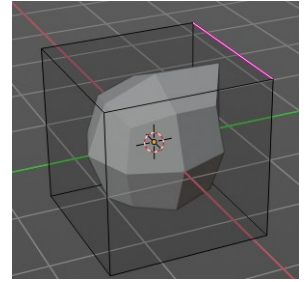

A negative crease value will subtract from the current active crease value in case it exists already from a former crease operation. A Crease value of -1 removes the crease from this edge.

Crease: -0.150

Last Operator Edge Crease

Factor

Adjust the crease factor.



Edge Bevel Weight

This tool adjusts the edge bevel weight for selected edges when you use the Bevel modifier at the mesh.

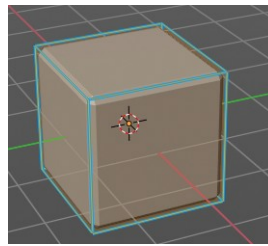

You need to have set the limit method to Weight. This way you can achieve a bevel weight for every individual selected edge if you want, and achieve different bevel strengths at the mesh.

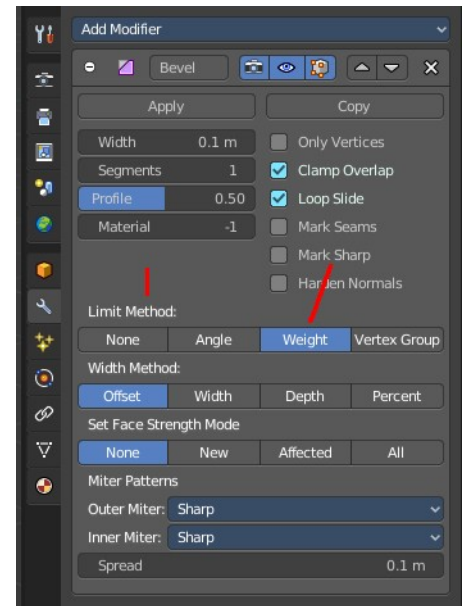

You will see a value in the header that indicates the current strength when you activate the tool. Move with the mouse to increase or decrease the value. Or type in a value while you are in this mode. You can also scale into negative range.

A negative Edge Bevel Weight value will subtract from the current active crease value in case it exists already from a former crease operation. An Edge Bevel Weight value of -1 removes the weight from this edge.

Bevel Weight: -0.329

Last Operator Edge Bevel Weight

Factor

Adjust the Edge Bevel Weight factor.

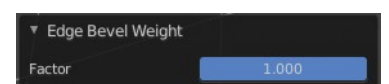

Mark Sharp

Mark Sharp is a tool that you need for the Edge Split modifier. Marked edges are displayed and rendered as sharp edges.

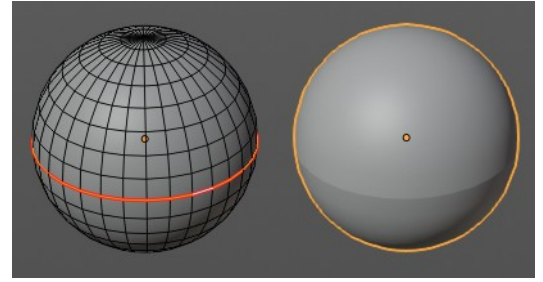
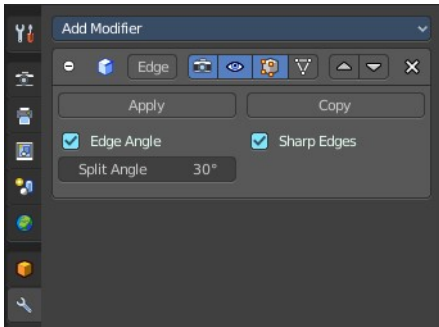

Last Operator Mark Sharp

Vertices

Calculate by the selected vertices instead of edges to mark the edges.



Clear Sharp

Clears formerly as sharp marked selected edges.

Last Operator Mark Sharp

Vertices

Calculate by the selected vertices instead of edges to mark the edges.

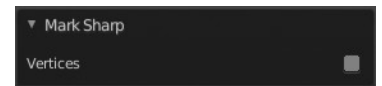

Mark Sharp from Vertices

Same as Mark Sharp, but with Vertices already ticked in the Adjust Last Operation panel. The calculation happens from the selected vertices instead of the selected edges.

Clear Sharp from Vertice

Same as Clear Sharp, but with Vertices already ticked in the Adjust Last Operation panel. The calculation happens from the selected vertices instead of the selected edges.

Mark Freestyle Edge

Freestyle is a comic renderer that is included in Bforartists. Mark Freestyle Edges marks the selected edges as Freestyle feature edges.

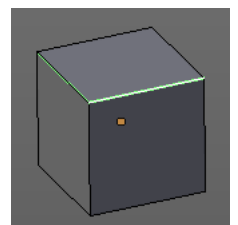

Clear Freestyle Edge

Freestyle is a comic renderer that is included in Bforartists. Clear Freestyle Edges unmarks the selected edges as Freestyle feature edges.

7.1.12 Editors - 3D Viewport - Header - Mesh - Edit mode - Faces menu

Table of content

Detailed Table of content.....	1
Edit Mode - Faces menu.....	4
Legacy.....	4
Poke Faces.....	6
Triangulate Faces.....	6
Tris to Quads.....	7
Solidify Faces.....	8
Wire Frame.....	8
Fill.....	9
Grid Fill.....	9
Beautify Faces.....	10
Intersect (Knife).....	10
Intersect (Boolean).....	11
Weld Edges into Faces.....	12
Face Data.....	12

Detailed Table of content

Detailed table of content

Detailed Table of content.....	1
Edit Mode - Faces menu.....	4
Legacy.....	4
Inset Faces.....	4
Last Operator Inset Faces.....	4
Boundary.....	4
Offset Even.....	4
Offset Relative.....	5
Edge Rail.....	5
Thickness.....	5
Depth.....	5
Outset.....	5
Select Outer.....	5
Individual.....	5
Interpolate.....	5
Bridge Faces.....	5
Last Operator Bridge Edge loops.....	5
Connect Loops.....	5
Merge.....	5
Merge Factor.....	5
Twist.....	5
Number of Cuts.....	6
Interpolation.....	6
Smoothness.....	6

Profile Factor.....	6
Profile shape.....	6
Poke Faces.....	6
Last Operator Poke Faces.....	6
Poke Offset.....	6
Offset Relative.....	6
Poke Center.....	6
Triangulate Faces.....	6
Last Operator Triangulate Faces.....	7
Quad Method.....	7
Shortest diagonal.....	7
Fixed Alternate.....	7
Fixed.....	7
Beauty.....	7
Polygon Method.....	7
Clip.....	7
Beauty.....	7
Tris to Quads.....	7
Last Operator Tris to Quads.....	7
Max Face Angle.....	7
Max Shape Angle.....	7
Compare UV's.....	7
Compare VCols.....	7
Compare Seam.....	8
Compare Sharp.....	8
Compare Materials.....	8
Solidify Faces.....	8
Last Operator Solidify.....	8
Thickness.....	8
Wire Frame.....	8
Last Operator Wire Frame.....	8
Boundary.....	8
Offset Even.....	8
Offset Relative.....	8
Replace.....	8
Thickness.....	8
Offset.....	9
Crease.....	9
Crease Weight.....	9
Fill.....	9
Last Operator Fill.....	9
Beauty.....	9
Grid Fill.....	9
Last Operator Grid Fill.....	9
Span.....	9
Offset.....	9
Simple Blending.....	9
Beautify Faces.....	10
Last Operator Beautify Faces.....	10
Max Angle.....	10
Intersect (Knife).....	10
Last Operator Intersect.....	10
Source.....	10

Separate Mode.....	10
Merge Threshold.....	10
Intersect (Boolean).....	11
Last Operator Intersect (Boolean).....	11
Boolean.....	11
Swap.....	11
Merge Threshold.....	11
Weld Edges into Faces.....	12
Face Data.....	12
Rotate Colors.....	12
Last Operator Rotate Colors.....	12
Counter Clockwise.....	12
Reverse Colors.....	12
Rotate UV's.....	13
Last Operator Rotate UV's.....	13
Reverse UV's.....	13
Mark Freestyle Face.....	13
Clear Freestyle Face.....	13

Edit Mode - Faces menu

The faces menu is just visible for Mesh objects. It provides tools to work with faces.

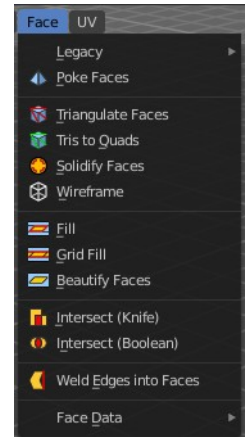

Legacy

The legacy sub menu contains tools that exists in the tool shelf already.

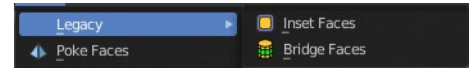

It's the old way to do things. Different to the tools in the tool shelf, these tools are usually modal. And performs once. You have to call them again in case you want to repeat the tool.

Or, in case of the Bridge Faces tool, is a double to another existing tool. The Bridge Faces tool is nothing else than the Bridge Edge Loops tool from the Edge menu. Just with another name, and working in Face selection mode. We promised to provide the same functionality than Blender. And so we have to provide this tool too.

Inset Faces

Inset insets edges into the selected faces. Think of it as an extrude inwards the face.

Activate the tool, drag the mouse. But carefully. The control is not the best. You better adjust the amount in the last operator.

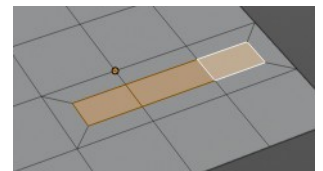

Last Operator Inset Faces

Boundary

With Boundary ticked you will get the connect edges in the corners. Without the edges ends straight.

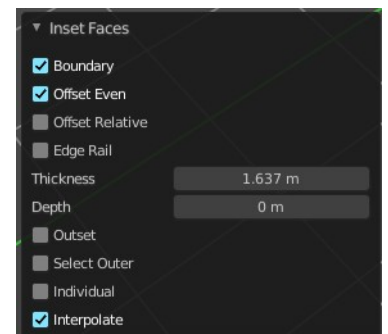
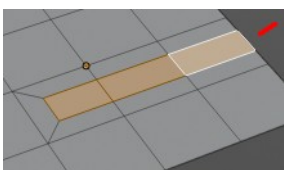

Offset Even

Scales the offset to give more even thickness.

Offset Relative

Scales the offset by surrounding geometry.

Edge Rail

Inset the region along existing edges.

Thickness

Thickness adjusts the thickness of the inset geometry.

Depth

With depth you can bevel the inset geometry. It is then not longer co planar to the initial face.

Outset

With outset ticked the Inset will not extrude inwards but outwards.

Select Outer

With Select Outer the outer ring will be selected after the Inset.

Individual

Inset every face individually.

Interpolate

Blend Face Data across the inset.

Bridge Faces

The Bridge Faces tool bridges selected faces, and adds polygons between them. You need to have at least two faces selected.

This tool is basically the Bridge Edge Loops tool, just that it operates in Face mode.

Note that this tool just shows when you are in Face Select Mode.

Last Operator Bridge Edge loops

Connect Loops

Choose the method how to deal with bridging multiple loops.

Merge

With merge ticked it will not create a bridge face, but merge the selected edges.

Merge Factor

The merge factor determines at which distance between the selected edges the merge happens. 0.5 is the middle of the selected edges.

Twist

The twist offset for closed loops.

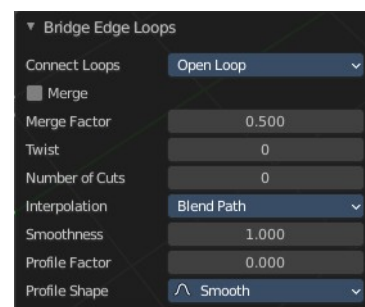

Number of Cuts

Adds cuts to the bridge face.

Interpolation

Choose the interpolation mode for the cuts.

Smoothness

Adjust the smoothness for the cuts.

Profile Factor

Adjust the profile factor for the cuts.

Profile shape

Adjust the profile shape for the cuts.

Poke Faces

Splits the selected faces to create a triangulated geometry.

Last Operator Poke Faces

Poke Offset

Normally the center vertice of the poke operation is planar with the rest. Adjust an offset.

Offset Relative

Scale the offset by surrounding geometry.

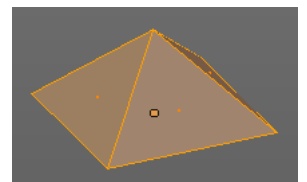
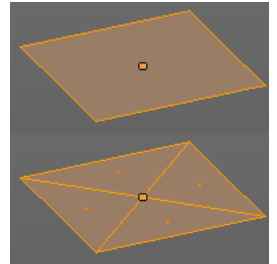

Poke Center

Poke Center is a drop-down box choose what the center of the poke operation should be. You can choose between weighted mean, mean and bounds.

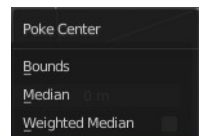

Triangulate Faces

Triangulate Faces triangulates the faces of the selected geometry.

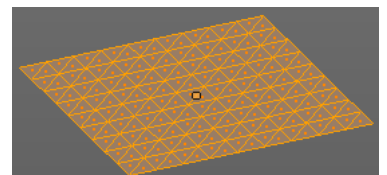

Last Operator Triangulate Faces

Quad Method

Choose how quads should be triangulated.

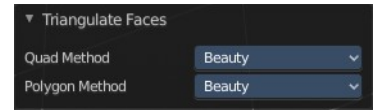

Shortest diagonal

Splits the quads based on their distance between vertices.

Fixed Alternate

Splits the quads on the second and fourth vertice.

Fixed

Splits the quads on the first and third vertice.

Beauty

Tries to optimize the triangulation.

Polygon Method

Choose how N-Gons should be triangulated.



Clip

Splits the polygons with an ear clipping algorithm.

Beauty

Tries to optimize the triangulation.

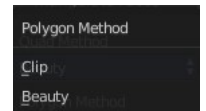

Tris to Quads

Tris to quads tries to convert triangulated geometry back to a quad geometry by removing the edges inside of the quads.

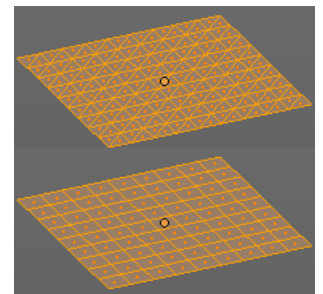

Last Operator Tris to Quads

Max Face Angle

Adjust the threshold to adjacent triangles.

Max Shape Angle

Adjust the shape angle limit.

Compare UV's

Takes the UV patches for the calculation into account. Border geometry will not be calculated.

Compare VCols

Takes the Vertex colors for the calculation into account. Border geometry will not be calculated.

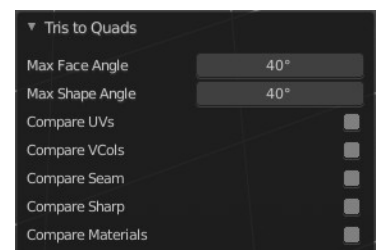

Compare Seam

Takes the Vertex colors for the calculation into account. Border geometry will not be calculated.

Compare Sharp

Takes the as sharp marked edges for the calculation into account. Border geometry will not be calculated.

Compare Materials

Takes the Materials colors for the calculation into account. Border geometry will not be calculated.

Solidify Faces

Gives the selected faces a thickness, and makes it solid.

There is also a Solidify modifier available.

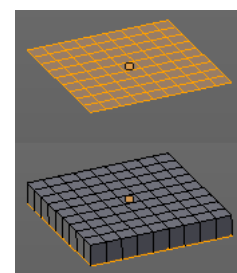

Last Operator Solidify

Thickness

Adjust the thickness. You can scale also into the negative range.



Wire Frame

Wire frame grabs the edges of the faces and turns them into tubes.

Last Operator Wire Frame

Boundary

Inset Face Boundaries.

Offset Even

Scales the offset to give more even thickness.

Offset Relative

Scales the offset by surrounding geometry.

Replace

Removes the source geometry.

Thickness

Adjust the thickness of the tubes.

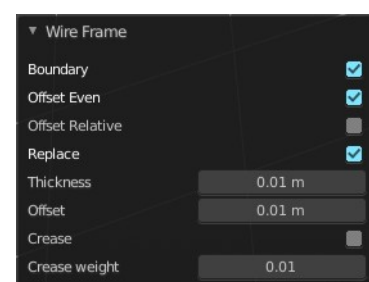
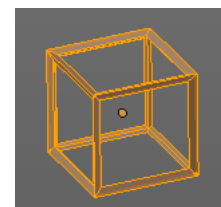

Offset

Adjust the offset of the tubes.

Crease

Crease adds close edges so that you have sharp corners when you use Subdivision Surface.

Crease Weight

Adjust the crease weight.

Fill

Fill closes holes in the selected mesh geometry, and triangulates the faces.

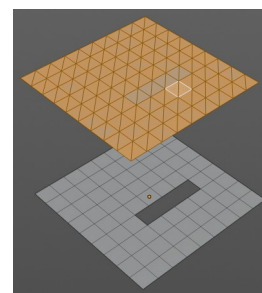

Last Operator Fill

Beauty

Uses the best possible triangulation.



Grid Fill

Grid Fill allows you to fill two edge loops with quad geometry that follows the surrounding geometry.

Usage: select two opposite edge loops. Then perform the tool.

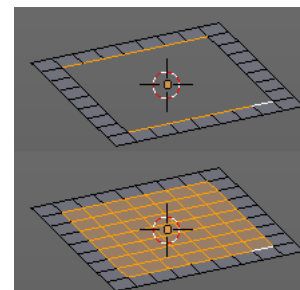

Last Operator Grid Fill

Span

Number of sides.

Offset

Define an offset

Simple Blending

Uses a simple interpolation. Faster but less accurate.

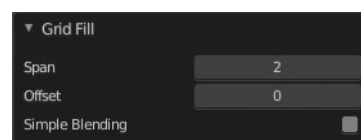

Beautify Faces

Beautify faces tries to optimize triangulation.



Last Operator Beautify Faces

Max Angle

Set an angle limit.



Intersect (Knife)

Intersect creates edges where geometry intersects.

This operation happens in Edit mode, and so all parts must be in the same mesh.

Last Operator Intersect

Source

Source is a drop-down box choose at which mesh part you want to operate.

Selected/Unselected works between the selected and unselected geometry.

Self Intersect works on the overlapping geometry of the mesh.

Separate Mode

Separate mode is a drop-down box choose the separation mode.

All splits the geometry at the new edge.

Cut keeps each side of the intersection separate without splitting the faces in half.

Merge merges all the geometry from the intersection.

Merge Threshold

Adjust the merge threshold. Increase it when some geometry is not calculated. But keep it small for fast calculation.

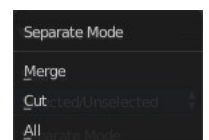
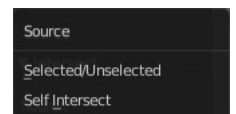
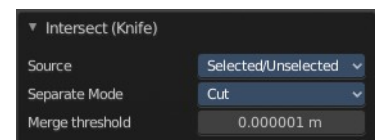
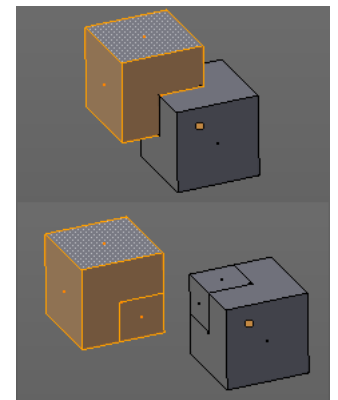

Intersect (Boolean)

Intersect (Boolean) performs a Boolean operation between the selected and unselected mesh parts.

This operation happens in Edit mode, and so all parts must be in the same mesh.

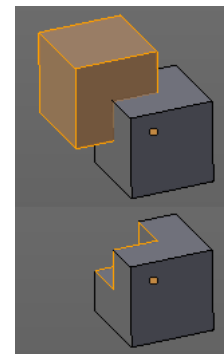

Last Operator Intersect (Boolean)

Boolean

Choose the Boolean method.

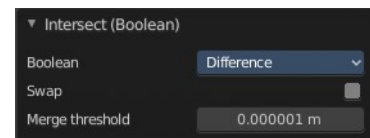

Difference subtracts the source geometry from the target geometry.

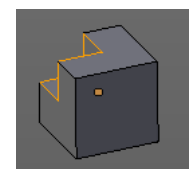

Union unions the source geometry with the target geometry. Geometry inside the source and target geometry gets removed.

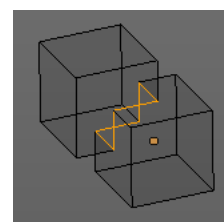

Intersect removes all geometry but the overlapping geometry.

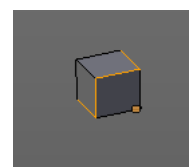

Swap

Inverts source and target geometry.

Merge Threshold

Adjust the tolerance for the Boolean operation. Increase it when some geometry is not calculated. But keep it small for fast calculation.

Weld Edges into Faces

This tool incorporates loose wire edges into selected faces.

You need a loose edge geometry to get it to work. By converting a curve to a Mesh geometry for example. You need to join the edge into the mesh where you want to use it. The operation happens in Edit mode.

In edit mode select the edge and the face where you want it to join. And then perform the tool.

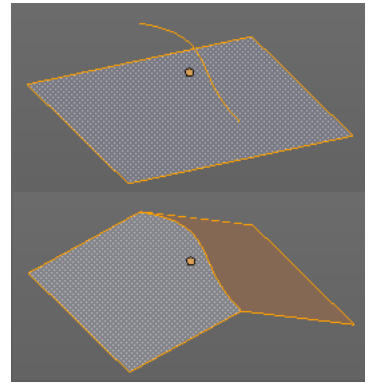

Face Data

Rotate Colors

Rotates the vertex colors for the selected geometry. This tool requires to have vertex colors painted at the mesh.

Note that there is no way to display vertex colors in Edit mode. So you need to switch to Vertex paint mode to see the result.

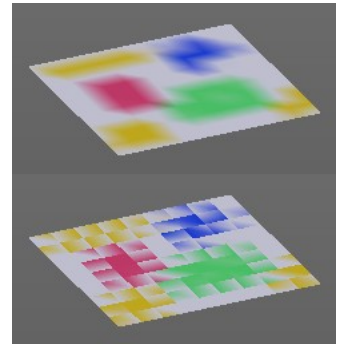
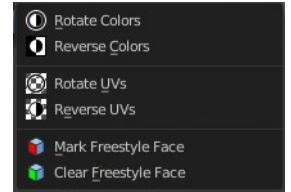

Last Operator Rotate Colors

Counter Clockwise

The tool rotates clockwise by default. With this option ticked the rotation happens counter clockwise.



Reverse Colors

Reverses the vertex colors.

Note that there is no way to display vertex colors in Edit mode. So you need to switch to Vertex paint mode to see the result.

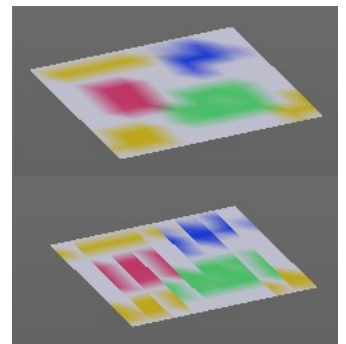

Rotate UV's

Rotates the UV space for the selected geometry by 90 degrees. This tool requires to have a working UV mapping.

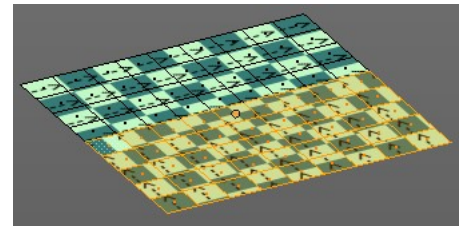

Last Operator Rotate UV's

The tool rotates clockwise by default. With this option ticked the rotation happens counter clockwise.



Reverse UV's

Reverses the UV Space for the selected geometry. This tool requires to have a working UV mapping.

Mark Freestyle Face

Mark selected Faces for exclusion from Freestyle Feature edge detection. Freestyle is a cartoon renderer that is also included in Bforartists.

Clear Freestyle Face

Unmark selected Faces for exclusion from Freestyle Feature edge detection. Freestyle is a cartoon renderer that is also included in Bforartists.



7.1.13 Editors - 3D Viewport - Header - Mesh - Edit mode - UV menu

Table of content

Detailed Table of content.....	1
Edit Mode - UV Menu.....	3
Unwrap ABF.....	3
Unwrap Conformal.....	3
Smart UV Project.....	4
Lightmap Pack.....	4
Follow Active Quads.....	5
Cube Projection.....	5
Cylinder Projection.....	6
Sphere Projection.....	6
Project from View.....	7
Project from View (Bounds).....	7
Mark Seam.....	7
Clear Seam.....	8
Reset.....	8

Detailed Table of content

Detailed table of content

Detailed Table of content.....	1
Edit Mode - UV Menu.....	3
Unwrap ABF.....	3
Unwrap Conformal.....	3
Last Operator Unwrap.....	3
Method.....	3
Fill Holes.....	3
Correct Aspect.....	3
Use Subsurf Modifier.....	3
Margin.....	3
Smart UV Project.....	4
Smart UV Project Settings dialogue.....	4
Angle Limit.....	4
Island Margin.....	4
Area Weight.....	4
Correct Aspect.....	4
Last Operator Smart UV Project.....	4
Lightmap Pack.....	4
Settings.....	4
Selection.....	4
Share Tex Space.....	4
New UV Map.....	4
New Image.....	4
Image Size.....	5

Pack Quality.....	5
Margin.....	5
Follow Active Quads.....	5
Settings.....	5
Edge Length Mode.....	5
Last Operator Follow Active Quads.....	5
Cube Projection.....	5
Last Operator Cube Projection.....	5
Cube Size.....	5
Correct Aspect.....	5
Clip to Bounds.....	5
Scale to Bounds.....	5
Cylinder Projection.....	6
Last Operator Cylinder Projection.....	6
Direction.....	6
Align.....	6
Radius.....	6
Correct Aspect.....	6
Clip to Bounds.....	6
Scale to Bounds.....	6
Sphere Projection.....	6
Last Operator Sphere Projection.....	6
Direction.....	6
Align.....	6
Correct Aspect.....	6
Clip to Bounds.....	6
Scale to Bounds.....	7
Project from View.....	7
Last Operator Project from View.....	7
Orthographic.....	7
Camera Bounds.....	7
Correct Aspect.....	7
Clip to Bounds.....	7
Scale to Bounds.....	7
Project from View (Bounds).....	7
Mark Seam.....	7
Clear Seam.....	8
Reset.....	8

Edit Mode - UV Menu

Here you find the uv mapping methods and some further functionality. You use it best in the U Editing layout. There you can see the result in the UV Editor then.

The UV menu is just available for Mesh objects.

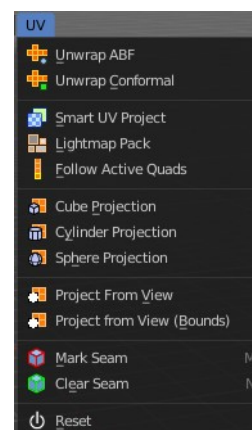

Unwrap ABF

Unwrap ABF unwraps the selected geometry with the method Angle based. ABF stands for Angle Based Flattening. ABF can give a bit better result than LSCM when unwrapping organic shapes.

Unwrap Conformal

Unwrap Conformal unwraps the selected geometry with the method LSCM, which is the short for Least Square Conformal Mapping. LSCM can give a bit better results than ABF with geometric shapes.

Last Operator Unwrap

Unwrap ABF and Unwrap LSCM shares the same Last Operator.

Method

Method is a drop down box where you can choose between Unwrap method Angle Based and Conformal.

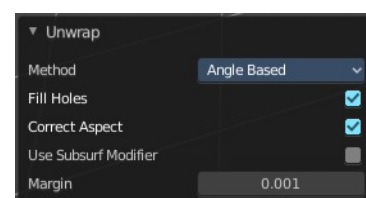

Fill Holes

Fill holes in the mesh before unwrapping.

Correct Aspect

Take the Image Aspect Ratio into account.

Use Subsurf Modifier

Unwraps an existing Subsurf Modifier. You need to add a Subsurf Modifier first.

Margin

The distance between the single UV patches.

Smart UV Project

Smart UV Project projects the UV mapping from different angles.

Smart UV Project Settings dialogue

Angle Limit

The Angle Limit defines after which angle the mapping happens from the next side. With an angle of 66 you have around six sides to map from. The calculation is $360/66$.

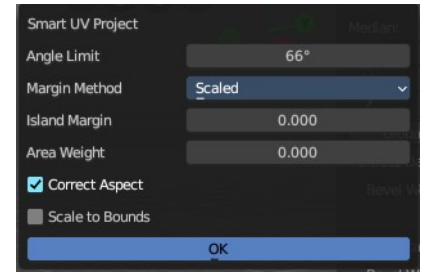

Margin Method

Scaled

Use the scale of existing UV to multiply margin.

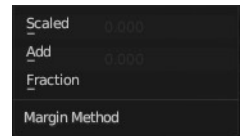

Add

Just add the margin and ignore any existing UV.

Fraction

Specify a precise fraction of specific UV.

Island Margin

Island Margin defines the distance between the UV patches.

Area Weight

Weight Projection Vector by faces with larger areas.

Correct Aspect

Take the Image Aspect Ratio into account.

Last Operator Smart UV Project

The Last Operator for Smart UV Project contains the same settings than the Smart UV Project Settings dialogue.

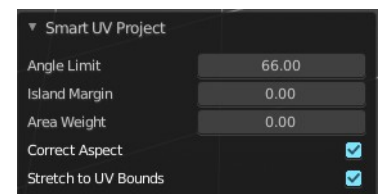

Lightmap Pack

Lightmap Pack maps each face individually, and puts the result into the UV space. Without margin.

Lightmap Pack has no Last Operator.

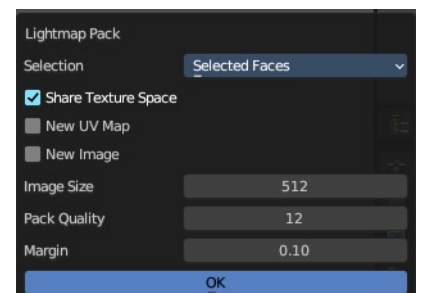

Settings

Selection

Selection is a drop-down box where you can choose what will be packed.

Share Tex Space

Map all objects into one lightmap.

New UV Map

Create a new UV map for every new mesh.

New Image

Assign new Image to every new mesh.

Image Size

The size for new images.

Pack Quality

The pack quality.

Margin

The distance between the single UV patches.

Follow Active Quads

Follow Active quads maps UV coordinates starting from an active face, and maps all adjacent faces in quad shape then. This way you can for example unwrap a pipe or a road. You first need to have a face selected. Then select everything. And then click at Follow Active Quads.

Settings

Edge Length Mode

Edge Length Mode is a drop-down box where you can choose the Length method.

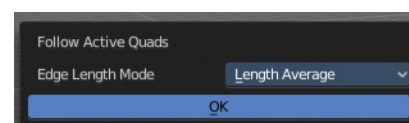

Last Operator Follow Active Quads

The Last Operator contains the same settings than the Settings dialogue.

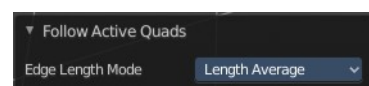

Cube Projection

Cube Projection maps the mesh from six sides, means cubic.

Last Operator Cube Projection

Cube Size

Cube Size defines the size of the UV mesh in the UV space.

Correct Aspect

Take Image Aspect ratio into account.

Clip to Bounds

Clip UV Coordinates to bounds after unwrapping.

Scale to Bounds

Scale UV Coordinates to bounds after unwrapping.

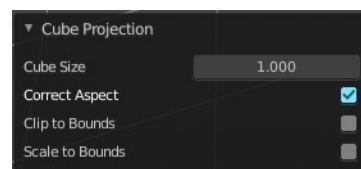

Cylinder Projection

Cylinder Projection tries to map the geometry cylindric.

Last Operator Cylinder Projection

Direction

Direction is a drop-down box where you can choose in which direction the cylindric projection will be mapped.

Align

Align is a drop-down box where you can choose the Align method.

Radius

Radius defines the Polar size of the UV mesh in the UV space.

Correct Aspect

Take Image Aspect ratio into account.

Clip to Bounds

Clip UV Coordinates to bounds after unwrapping.

Scale to Bounds

Scale UV Coordinates to bounds after unwrapping.

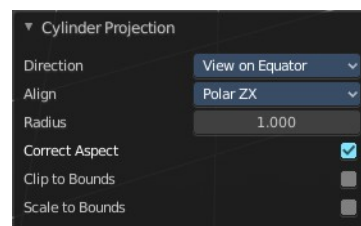

Sphere Projection

Sphere Projection tries to map the geometry spherical.

Last Operator Sphere Projection

Direction

Direction is a drop-down box where you can choose in which direction the spherical projection will be mapped.

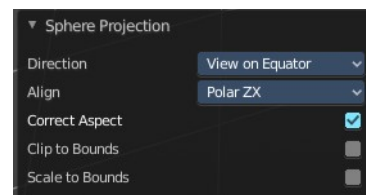

Align

Align is a drop-down box where you can choose the Align method.

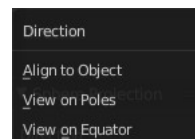

Correct Aspect

Take Image Aspect ratio into account.

Clip to Bounds

Clip UV Coordinates to bounds after unwrapping.



Scale to Bounds

Scale UV Coordinates to bounds after unwrapping.

Project from View

Project from View projects the UV from the current 3D view.

Last Operator Project from View

Orthographic

User orthographic projection.

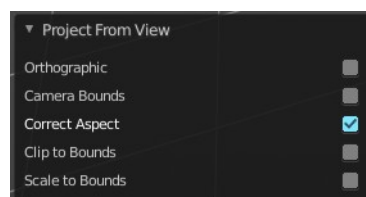

Camera Bounds

Map UV's to the camera region taking resolution and aspect into account.

Correct Aspect

Take Image Aspect ratio into account.

Clip to Bounds

Clip UV Coordinates to bounds after unwrapping.

Scale to Bounds

Scale UV Coordinates to bounds after unwrapping.

Project from View (Bounds)

Project from View projects the UV from the current 3D view.

Same as Project from View, but with Scale to Bounds ticked in the Last operator. And so it scales to the bounds.

Mark Seam

The unwrap algorithms Angle based and Conformal requires to have edges marked as seams. Think of it as a cutting pattern for a trouser for example. Such a trouser is also made of fabric patterns.

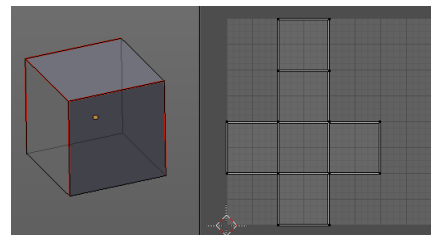

Same goes for the UV patches when you use Angle based or conformal unwrapping. You need to cut your mesh into parts and mark edges as seams, so that the algorithm knows where the seams are.

Mark seam marks the currently selected edge(s) as a seam. Seam edges will be displayed as red in the 3D viewport.

Clear Seam

Clear seam removes the seam from the currently selected edge(s).

Reset

Resets the UV Projection.



7.1.14 Editors - 3D Viewport - Header - Mesh - Sculpt mode - Sculpt menu

Table of content

Sculpt Mode - Sculpt Menu.....	3
Legacy submenu.....	3
Move.....	3
Snapping.....	3
Precision movement.....	4
Header Values.....	4
Numerical Input.....	4
Limit Axis.....	4
Orientation.....	4
Last Operator Move.....	5
Move X, Y Z.....	5
Axis Ortho.....	5
Orientation.....	5
Proportional editing.....	5
Proportional Falloff.....	5
Proportional Size.....	5
Connected.....	5
Projected(2D).....	5
Rotate.....	5
Snapping.....	6
Precision rotation.....	6
Header Values.....	6
Numerical Input.....	6
Limit Axis.....	6
Orientation.....	6
Last Operator Rotate.....	7
Angle.....	7
Axis.....	7
Orientation.....	7
Mirror Editing.....	7
Proportional editing.....	7
Proportional Falloff.....	7
Proportional Size.....	7
Connected.....	7
Projected(2D).....	7
Scale.....	7
Snapping.....	7
Precision Scale.....	7
Header Values.....	8
Numerical Input.....	8
Limit Axis.....	8
Orientation.....	8
Last Operator Resize.....	8
Angle.....	8
Axis.....	9

Orientation.....	9
Mirror Editing.....	9
Proportional editing.....	9
Proportional Falloff.....	9
Proportional Size.....	9
Connected.....	9
Projected(2D).....	9
Transform submenu.....	9
Sphere.....	9
Last operator Filter Mesh.....	9
Strength.....	9
Repeat.....	9
Orientation.....	9
Axis.....	10
Box Hide.....	10
Box Show.....	10
Box Trim.....	10
Lasso Trim.....	10
Box Add.....	10
Lasso Add.....	10
Line Project.....	10
Fair Positions.....	10
Fair Tangency.....	10
Last Operator Edit Face Sets.....	11
Mode.....	11
Strength.....	11
Modify Hidden.....	11
Smooth.....	11
Surface Smooth.....	11
Inflate.....	11
Relax Topology.....	11
Relax Face Sets.....	11
Sharpen.....	11
Enhance Details.....	11
Erase Multires Displacement.....	11
Randomize.....	12
Last operator Filter Mesh.....	12
Strength.....	12
Repeat.....	12
Orientation.....	12
Axis.....	12
Subdivide submenu.....	12
.....	12
Last Operator Subdivision Set.....	12
Level.....	12
Relative.....	12
Set Pivot.....	13
Show / Hide submenu.....	13
Toggle Visibility.....	13
Last operator Face Sets Visibility.....	13
Mode.....	13
Hide active Face Sets.....	13
Last operator Face Sets Visibility.....	13

Mode.....	13
Show All.....	13
Invert Visible.....	13
Last operator Face Sets Visibility.....	13
Mode.....	13
Hide Masked.....	13
Rebuild BVH.....	13
Transfer Sculpt Mode.....	14

Sculpt Mode - Sculpt Menu

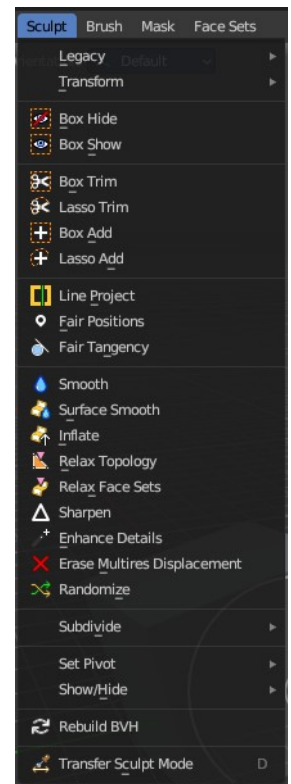

Legacy submenu

The legacy menu contains operators from the old tool system that already exists in the tool shelf and uses the new tool system.



Move

Activates the old move tool. The old move tool does not show a widget!

Note that the hotkey for this tool is not displayed correctly. But can't be fixed by us. The hotkey is ctrl W

Snapping

Holding down Ctrl activates temporary global snapping.

Precision movement

When you hold down shift, then you will have a much slower but also much preciser movement.

Header Values

When you move your object then you will see some values in the header, which defines the current position of the object.



The value m stands for the default metric system. Meters. You can change the units in the Properties editor in the Scene properties in the Units panel. When you choose kilometers here then you will see a km instead m.

The value D stands for the distance of the current selected axis. This can also be two axis. Then you have two d values. The value in the brackets is then the direct distance to the starting point.



These values are always relative to the starting point. You always start with zero, regardless of the real world position.

Numerical Input

When you move the object, and hold down the mouse and type in a value, like 20, then the movement will be performed by the value that you have typed in. In this case by 20 units in direction of the selected axis.

Limit Axis

When you want to rotate a specific axis, then press X or Y or Z to limit the rotation to this axis. You usually start in global orientation. But you can change this in the Orientation settings.



By holding down the mouse button and pressing the X, Y or Z key twice you can toggle this to local. But also to other orientations. This depends in what orientation you start. With normal you can toggle that way between Normal and global.

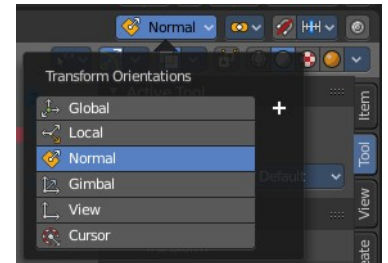

This can be combined with the numerical input. Type in X, type in X again to use the local space, type in 20 to move by 20 units in local orientation. Release the mouse to confirm.

Orientation

The widget can have different orientations. The menu items should be self explaining.

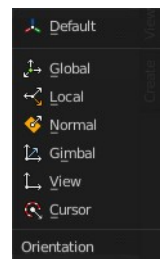

Last Operator Move

Move X, Y Z

The position. Attention, the actual world orientation and rotation does not matter here. It always starts with a value of zero, and moves relative to this zero then. For the actual location values have a look in the sidebar in the transform panel.

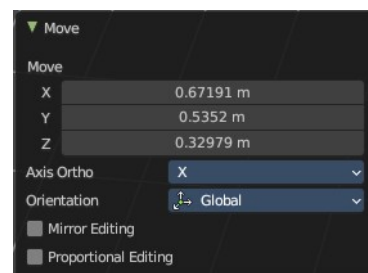

Axis Ortho

Defines the other axis of the imaginary shear axis plane.

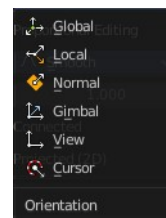

Orientation

The widget can have different orientations. The menu items should be self explaining.

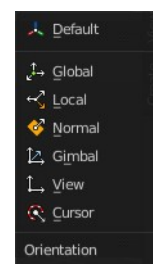

Proportional editing

Enables proportional editing. Activating proportional editing reveals further settings.

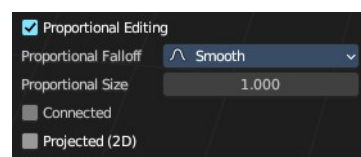

Proportional Falloff

Adjust the falloff methods.

Proportional Size

See and adjust the falloff radius.

Connected

The proportional falloff gets calculated for connected parts only.

Projected(2D)

The proportional falloff gets calculated in the screen space. Depth doesn't play a role. When it's in the radius, then it gets calculated.

Rotate

Activates the old Rotate tool. This tool has no widget!

Snapping

Holding down Ctrl activates temporary global snapping. It snaps then by 5 degrees steps.

When you use the white circle to rotate, then the widget also shows a division circle around the widget. This divisions shows even finer when

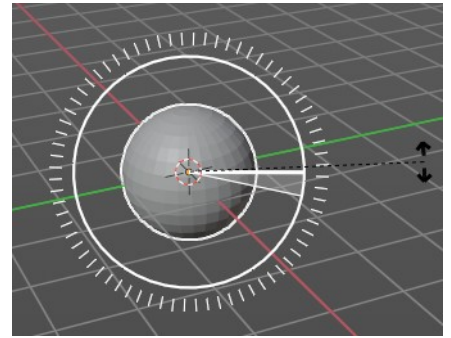

you do precision rotation.

Precision rotation

When you hold down shift, then you will have a much slower but also much preciser rotation.

Header Values

When you rotate your object then you will see some values in the header, which defines the current rotation of the object. The rotation is shown in degrees.

Rot: -3.57 global

Numerical Input

When you rotate the object, and hold down the mouse and type in a value, like 20, then the rotation will be performed by the value that you have typed in. In this case by 20 degree around the selected axis.

Limit Axis

When you want to rotate a specific axis, then press X or Y or Z to limit the rotation to this axis. You usually start in global orientation. But you can change this in the Orientation settings.

Rot: -0.08 along normal X

By holding down the mouse button and pressing the X, Y or Z key twice you can toggle this to local. But also to other orientations. This depends in what orientation you start. With normal you can toggle that way between Normal and Global.

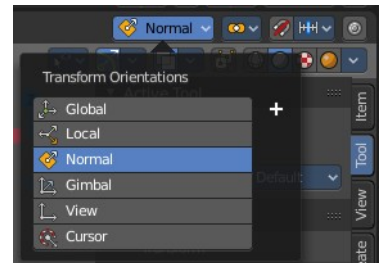

This can be combined with the numerical input. Type in X, type in X again to use the local space, type in 20 to rotate by 20 degree. Release the mouse to confirm.

Orientation

The 3d cursor can have different orientations. The menu items should be self explaining.

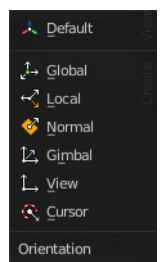

Last Operator Rotate

Angle

The rotation. Attention, the actual world orientation and rotation does not matter here. It always starts with a value of zero, and rotates relative to this zero then. For the actual rotation values have a look in the sidebar in the transform panel.

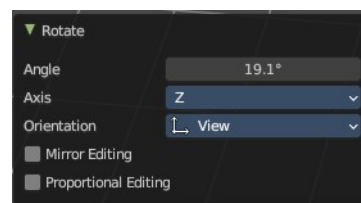

Axis

Which axis to rotate.

Orientation

The widget can have different orientations. The menu items should be self explaining.

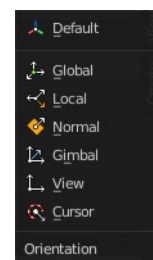

Mirror Editing

Enable mirror editing.

Proportional editing

Enables proportional editing. Activating proportional editing reveals further settings.

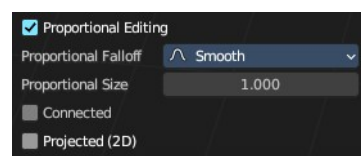

Proportional Falloff

Adjust the falloff methods.

Proportional Size

See and adjust the falloff radius.

Connected

The proportional falloff gets calculated for connected parts only.

Projected(2D)

The proportional falloff gets calculated in the screen space. Depth doesn't play a role. When it's in the radius, then it gets calculated.

Scale

Activates the old Scale tool. This tool has no widget!

Snapping

Holding down Ctrl activates temporary global snapping.

Precision Scale

When you hold down shift, then you will have a much slower but also much preciser scale.

Header Values

When you scale your object then you will see some values in the header, which defines the current scale of the object.

Scale: 1.1996 global

These values are always relative to the starting point. You always start with 1, regardless of the real world scale.

Numerical Input

When you scale the object, and hold down the mouse and type in a value, like 20, then the scale will be performed by the value that you have typed in. In this case by factor 20 along the selected axis.

Limit Axis

When you want to rotate a specific axis, then press X or Y or Z to limit the scale to this axis. You usually start in global orientation. But you can change this in the Orientation settings.

Rot: -0.08 along normal X

By holding down the mouse button and pressing the X, Y or Z key twice you can toggle this to local. But also to other orientations. This depends in what orientation you start. With normal you can toggle that way between Normal and Global.

This can be combined with the numerical input. Hold down mouse, type in X, type in X again to use the local space, type in 20 to scale by 20 units. Release the mouse to confirm.

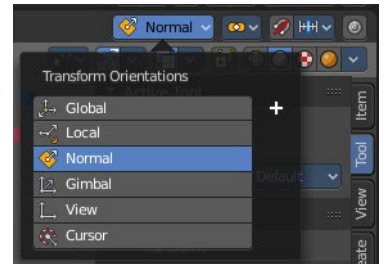

Orientation

The 3d cursor can have different orientations. The menu items should be self explaining.

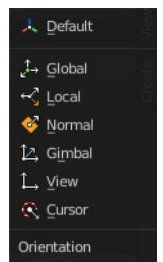

Last Operator Resize

Angle

The rotation. Attention, the actual world orientation and rotation does not matter here. It always starts with a value of zero, and rotates relative to this zero then. For the actual rotation values have a look in the sidebar in the transform panel.

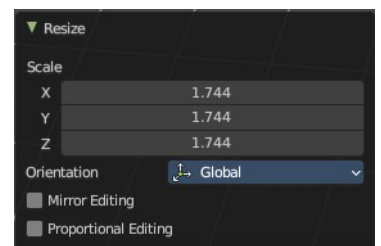

Axis

Which axis to rotate.

Orientation

The widget can have different orientations. The menu items should be self explaining.

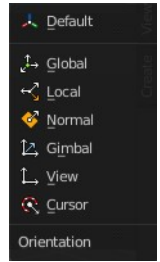

Mirror Editing

Enable mirror editing.

Proportional editing

Enables proportional editing. Activating proportional editing reveals further settings

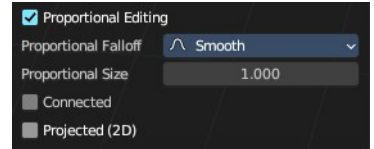

Proportional Falloff

Adjust the falloff methods.

Proportional Size

See and adjust the falloff radius.

Connected

The proportional falloff gets calculated for connected parts only.

Projected(2D)

The proportional falloff gets calculated in the screen space. Depth doesn't play a role. When it's in the radius, then it gets calculated.

Transform submenu

Sphere

Adds a mesh filter that casts the mesh to a sphere shape.

Activate the tool, click at the mesh, and adjust the sphere shape in the last operator panel.

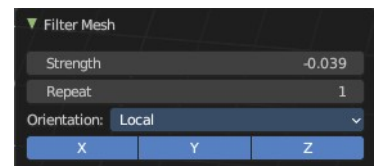

Last operator Filter Mesh

Strength

The strength of the sphere casting

Repeat

How often to repeat the casting.

Orientation

The orientation of the tool.

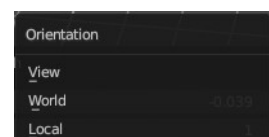
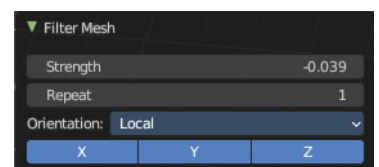

Axis

Which axis to affect.

Box Hide

Calls a rectangle tool that allows you to hide away mesh parts.

Box Show

Calls a rectangle tool that allows you to reveal hidden mesh parts.

Box Trim

Calls a rectangle tool that cuts away mesh parts, dependant of the view.

Lasso Trim

Calls a rectangle tool that cuts away mesh parts, dependant of the view.

Box Add

Calls a rectangle tool that adds mesh parts, dependant of the view.

Lasso Add

Calls a rectangle tool that adds mesh parts, dependant of the view.

Line Project

Calls a rectangle tool that cuts away mesh parts, dependant of the view.

Fair Positions

Edits the current active face set.

Creates a smooth as possible geometry patch from the face set, miniming changes in vertex positions.

Fair Tangency

Edits the current active face set.

Creates a smooth as possible geometry patch from the face set, miniming changes in vertex tangents.

Last Operator Edit Face Sets



Mode

The face set modification mode.

Strength

How strong the operation should be applied.

Modify Hidden

Also modify hidden geometry.



Smooth

Smoothens the object.

Surface Smooth

Smoothens the surface.

Inflate

Inflates the surface

Relax Topology

Relaxes the mesh.

Relax Face Sets

Relaxes the face sets.

Sharpen

Sharpens the face sets.

Enhance Details

Enhances the details

Erase Multires Displacement

Erases multiresolution displacement.

Randomize

Randomizes the mesh.

Last operator Filter Mesh

Strength

The strength of the sphere casting

Repeat

How often to repeat the casting.

Orientation

The orientation of the tool.

Axis

Which axis to affect.

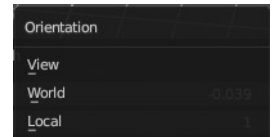
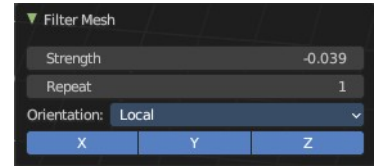

Subdivide submenu

Subdivide is a menu where you can quickly set the subdivision level of the selection. What it does is to add a SDS modifier in the Properties Editor if required. And set the SDS level to the needed value. Ctrl 0 sets SDS to level 0. Ctrl 1 sets SDS level to 1, and so on.

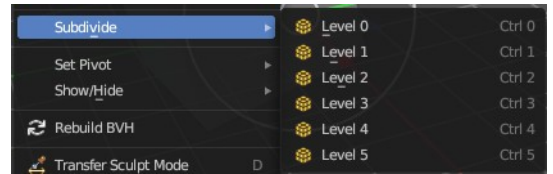

SDS happens at Object mode level. Even when you apply it in the Sculpt Mode! And it happens at the whole object. The sculpting though still happens at the base mesh.

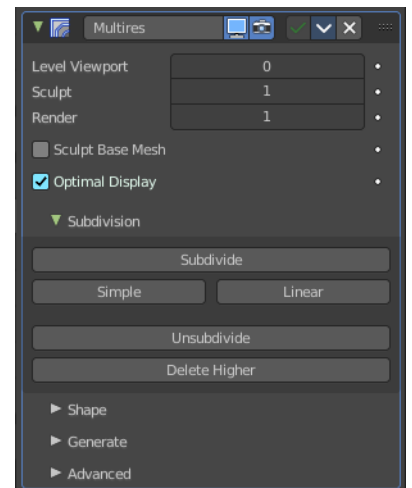

Last Operator Subdivision Set

Level

Adjust the SDS level.

Relative

Applies the Subsurf Level as an offset relative to the current level.

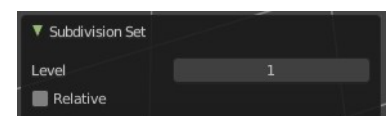

Set Pivot

Sets the pivot to the chosen location. The menu items should be self explaining. So we don't repeat them here.

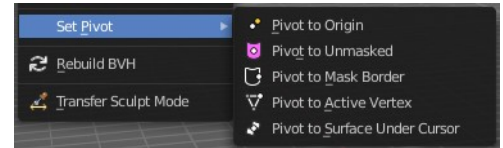

Show / Hide submenu

Toggle Visibility

Toggles the visibility of face sets.

Last operator Face Sets Visibility

Mode

The show hide modes for face sets.

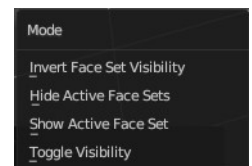
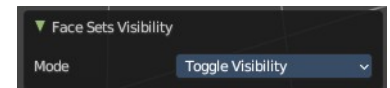

Hide active Face Sets

Makes the active face sets invisible.

Last operator Face Sets Visibility

Mode

The show hide modes for face sets.

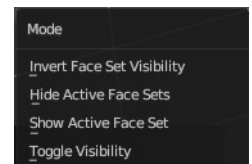
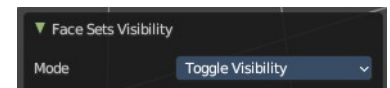

Show All

Makes all invisible mesh parts visible again.

Invert Visible

Toggles the visibility of the selected face sets.

Last operator Face Sets Visibility

Mode

The show hide modes for face sets.

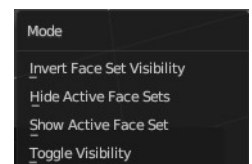
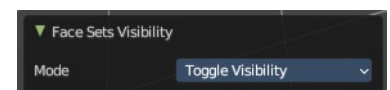

Hide Masked

Hides the masked mesh part.

Rebuild BVH

Recalculate the sculpt BVH to improve performance.

Transfer Sculpt Mode

Switch to another object in Sculpt mode. The tool calls an object picker with which you can choose the object that you want to switch to.



There is also a hardcoded hotkey D, which works directly. Hover with the mouse over the object, and press D



7.1.15 Editors - 3D Viewport - Header - Mesh - Sculpt mode - Brush menu

Table of content

Sculpt Mode - Brush Menu.....	1
Reset Brush.....	1
Brush Radius.....	1
Brush Strength.....	1
Texture Brush Angle.....	1

Sculpt Mode - Brush Menu

Reset Brush

Resets the brush in case you have customized it.

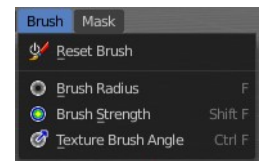

Brush Radius

Adjust the brush size. Hotkey tool! This menu entry is just there so that you are able to change the hotkey if you want, and to remind you that this hotkey exists.

Brush Strength

Adjust the brush strength. Hotkey tool! This menu entry is just there so that you are able to change the hotkey if you want, and to remind you that this hotkey exists.

Texture Brush Angle

Adjust the texture brush angle when you work with stencil maps and textures. Hotkey tool! This menu entry is just there so that you are able to change the hotkey if you want, and to remind you that this hotkey exists.



7.1.16 Editors - 3D Viewport - Header - Mesh - Sculpt mode - Mask menu

Table of content

Sculpt Mode - Mask Menu.....	1
Invert Mask.....	1
Fill Mask.....	1
Clear Mask.....	1
Smooth Mask.....	1
Sharpen Mask.....	2
Grow Mask.....	2
Shrink Mask.....	2
Increase Contrast.....	2
Decrease Contrast.....	2
Expand Mask by Topology.....	2
Expand Mask by Curvature.....	2
Mask Extract.....	2
Threshold.....	2
Add Boundary Loop.....	2
Smooth Iterations.....	2
Project to Sculpt.....	3
Extract as Solid.....	3
OK.....	3
Mask Slice.....	3
Mask Slice and fill Holes.....	3
Mask Slice to new Object.....	3
Mask from Cavity.....	3
Random Mask.....	3

Sculpt Mode - Mask Menu

Invert Mask

Inverts the mask.

Fill Mask

Fills the mask with a given value, or inverts its values.

Clear Mask

Clears the mask.

Smooth Mask

Smoothens the mask selection.

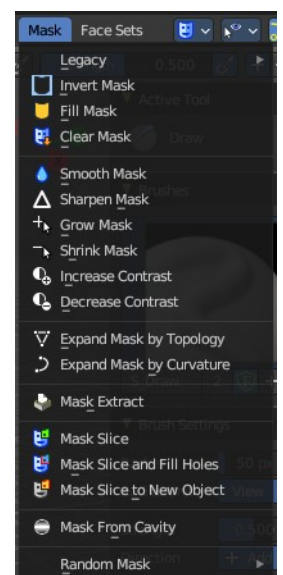

Sharpen Mask

Sharpens the mask selection.

Grow Mask

Grows the mask

Shrink Mask

Shrinks the mask.

Increase Contrast

Increases the contrast between masked parts and not masked parts.

Decrease Contrast

Decreases the contrast between masked parts and not masked parts.

Expand Mask by Topology

Expands the mask from the initial active vertex under the mouse. Starts with a new mask.

Watch the tool tip in the footer for further instructions.

Expand Mask by Curvature

Expands the mask from the initial active vertex under the mouse. Keeps the previous mask.

Watch the tool tip in the footer for further instructions.

Mask Extract

Creates a new object out of the masked mesh part.

This operation cannot be undone!

Threshold

The sharpness of the mask border.

Add Boundary Loop

Add a boundary loop at the border of the new created geometry. This can help to make the geometry more stable.

Smooth Iterations

How many iterations to smooth the new created geometry.

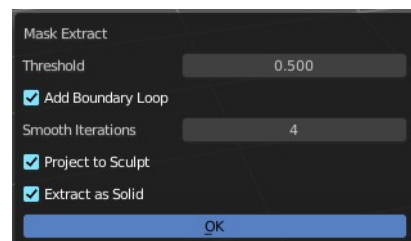

Project to Sculpt

Project the extracted mesh into the original sculpt.

Extract as Solid

Extract the new created mesh as a solid mesh.

OK

Apply the Mask Extract tool.

Mask Slice

Slices the paint mask from the mesh.

Mask Slice and fill Holes

Slices the paint mask from the mesh. And fills existing holes.

Mask Slice to new Object

Slices the paint mask from the mesh, and creates a new object out of it.

Mask from Cavity

Creates a mask based on cavity and pointiness of the mesh.

Random Mask

Masks out random parts of the mesh by the chosen method.



7.1.16 Editors - 3D Viewport - Header - Mesh - Sculpt mode - Face Sets menu

Table of content

Sculpt Mode - Face Sets Menu.....	1
Face Sets from Mask.....	1
Face Sets from Visible.....	1
Face Sets from Edit Mode Selection.....	2
Grow Face Sets.....	2
Shrink Face Sets.....	2
Extract Face Set.....	2
Initialize Face Sets.....	2
Invert visible Face Sets.....	2
Last Operator Face Sets Visibility.....	2
Mode.....	2
Invert Face Set Visibility.....	2
Hide Active Face Set.....	2
Show Active Face Set.....	2
Toggle Visibility.....	2
Show all Face Sets.....	3
Randomize Colors.....	3

Sculpt Mode - Face Sets Menu

Face Sets is a kind of a mask that shows in different colors to assist in sculpting regions and running different sculpt brush effect. The colors are random.

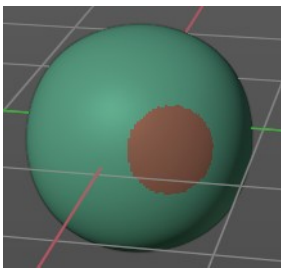

In the Face Sets menu you can create and manage Face Sets.

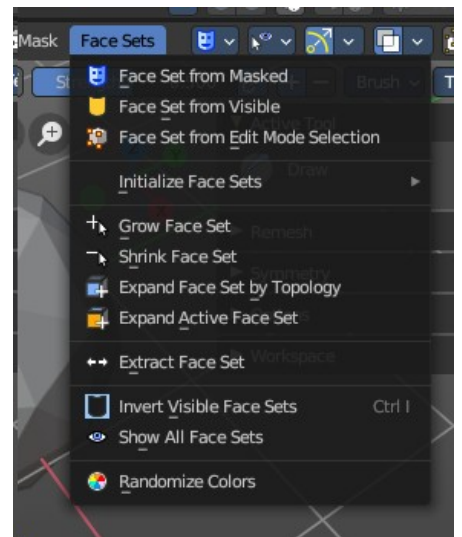

Face Sets from Mask

Creates a face set from the current mask.

Face Sets from Visible

Creates a face set from the visible geometry.

Face Sets from Edit Mode Selection

Creates a face set from the selection that you do in edit mode.

Grow Face Sets

Grows the face sets.

Shrink Face Sets

Shrinks the face sets.

Expand Face Set by Topology

Expands a face set from a starting point on the topology. Click and drag on the mesh once you start the operator.

Expand Active Face Set

Expands a face set from the active face set under the mouse cursor. Click and drag on the face set once you start the operator.

Extract Face Set

Creates a new mesh object from the selected face set. The mouse turns into a color picker to pick the face set when you activate this too.

Initialize Face Sets

A menu with various methods to initialize the face sets. These methods include the following:

- By Loose Parts
- By Face Set Boundaries
- By Materials
- By Normals
- By UV Seams
- By Edge Creases
- By Edge Bevel Weight
- By Sharp Edges

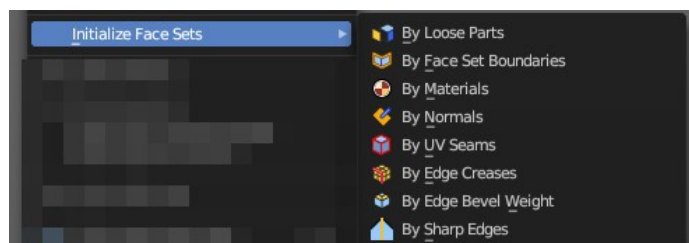

Invert visible Face Sets

Inverts the visible face sets to be invisible.

Last Operator Face Sets Visibility

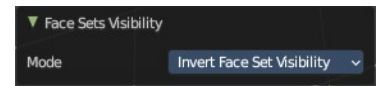

Mode

Invert Face Set Visibility

Inverts the visibility.

Hide Active Face Set

Hides the active face set.

Show Active Face Set

Shows the active face set.

Toggle Visibility

Toggles the visibility on or off.

Show all Face Sets

Show all face sets.

Randomize Colors

Generates a new set of random colors to render the face sets.

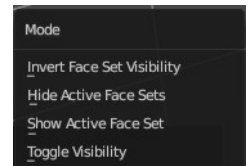



7.1.18 Editors - 3D Viewport - Header - Mesh - Vertex Paint mode - Paint menu

Table of content

Vertex paint Mode - Paint Menu.....	2
Set Vertex Colors.....	2
Affect Alpha.....	2
Smooth Vertex Colors.....	2
Dirty Vertex Colors.....	2
Last Operator Dirty Vertex Colors.....	2
Blur strength.....	2
Blur Iterations.....	2
Highlight Angle.....	2
Dirt Angle.....	2
Dirt only.....	3
Vertex Color from Weight.....	3
Invert.....	3
Levels.....	3
Last Operator Vertex Paint Levels.....	3
Offset.....	3
Gain.....	3
Hue Saturation Value.....	3
Last Operator Vertex Paint Hue Saturation Value.....	3
Hue.....	3
Saturation.....	3
Value.....	4
Bright / Contrast.....	4
Last Operator Vertex Paint Bright/Contrast.....	4
Brightness.....	4
Contrast.....	4

Vertex paint Mode - Paint Menu

The Paint menu contains tools for vertex painting in Vertex paint mode.

Set Vertex Colors

Flood fills the vertex colors with the current vertex color value.

Affect Alpha

Set color to completely opaque instead of reusing existing alpha.

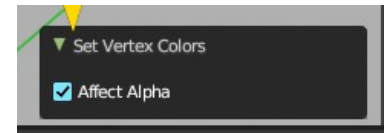
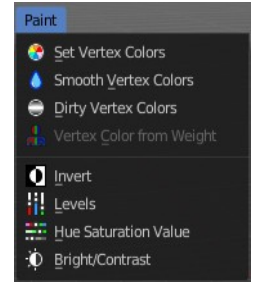

Smooth Vertex Colors

Smooths out the vertex colors.

Dirty Vertex Colors

Dirty vertex colors is a special tool for aging meshes. Let's for example imagine we have a relief. Edges that are outstanding are often touched, and tends to become brighter. While areas in the inner side of a relief are not so often touched. And here the relief collects dirt too. So this areas becomes darker.

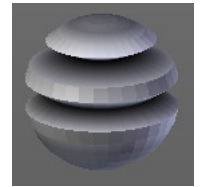

And that's what the tool simulates. It makes the outer edges brighter, and the inner edges darker. This calculation is somehow similar to Ambient Occlusion. Ambient Occlusion makes corners darker. The dirty tool makes edges brighter too. And it calculates with the vertices. Not Texel positions like AO.

You need to convert this result to a texture to use it in your texturing, as a mask for example. This conversion can be done by baking.

The tessellation of the mesh should not be too high for this operation. Since it calculates the angles of the mesh edges.

Last Operator Dirty Vertex Colors

Blur strength

How strong the result should be blurred

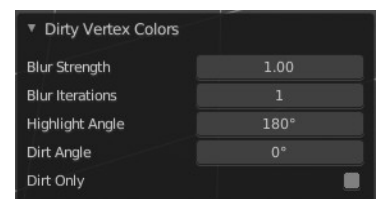

Blur Iterations

The number of iterations for the blur.

Highlight Angle

The angle for the bright areas. Angles higher as this value will not be recognized as an edge to highlight.

Dirt Angle

The angle for the dark areas. Angles lower as this value will not be recognized as a corner to darken.

Dirt only

Ignore the highlight areas, just calculate the dirt angles.

Vertex Color from Weight

This tool requires to have Weight Painting at the mesh. It converts the weight paint colors into greyscale vertex colors.

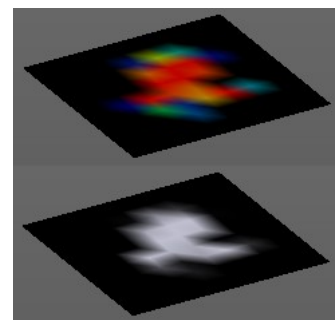

Invert

Inverts the vertex colors.

Levels

This tool allows you to level the values of the vertex painting. You adjust the settings in the last operator.

Last Operator Vertex Paint Levels

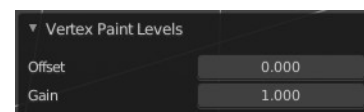

Offset

Adjust the Offset of the vertex colors.

Gain

Adjust the Gain of the vertex colors.

Hue Saturation Value

This tool allows you to adjust the hue, saturation and value values of the vertex painting. You adjust the settings in the last operator.

Last Operator Vertex Paint Hue Saturation Value

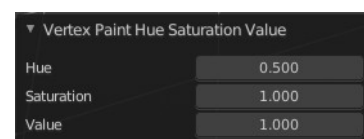

Hue

Adjust the Hue of the vertex colors.

Saturation

Adjust the Saturation of the vertex colors.

Value

Adjust the Value of the vertex colors.

Bright / Contrast

This tool allows you to adjust the brightness and the contrast of the vertex painting. You adjust the settings in the last operator.

Last Operator Vertex Paint Bright/Contrast

Brightness

Adjust the brightness of the vertex colors.



Contrast

Adjust the contrast of the vertex colors.

7.1.19 Editors - 3D Viewport - Header - Mesh - Vertex Paint mode - Brush menu

Table of content

Vertex Paint Mode - Brush Menu.....	1
Color Picker.....	1

Vertex Paint Mode - Brush Menu

Color Picker

Allows you to pick a color in the 3D view. Hotkey tool!

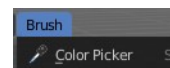



7.1.2 Editors - 3D Viewport - Header - Quick Menu

Table of content

- Quick Menu.....1
- Adding an operator to the Quick menu.....1
- Adding a menu to the Quick menu.....1
- Order.....2
- Removing an operator from the Quick menu.....2
- Context and mode dependent content.....2

Quick Menu

The quick menu, or in long Quick Favorites menu, is a menu that can be customized to your needs. Here you can add operators for quick access.

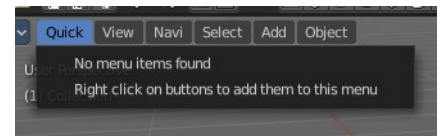

It is located in the header of the 3D view, But it can be called by hotkey Q directly under the mouse. This hotkey works in other editors too.

When the menu is empty, then you will see the message "No Menu Items found". This means that you first have to add some tools to the menu. It is a user configurable menu.

Note that added operators in this menu does not have icons. Just text.

Adding an operator to the Quick menu

Open the panel or the menu where your operator is that you want to add.

Let's add the open command from the File menu. Open the File menu, right click at open, and choose Add to Quick Favorites.

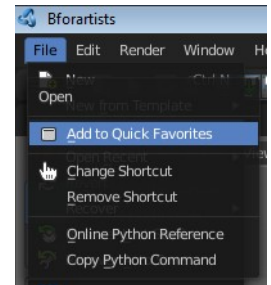

Do the same with Save As. We should now have two new menu items in the Quick menu, which you can use now.

As a rule of thumb, when the right click menu has an Add to Quick Favorites, then you can add it to the quick menu.

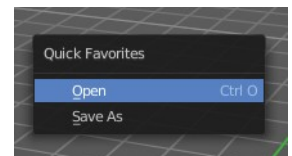

Note that you can also add operators from the tool shelf at the left. And also operators from other editor types. Some other editors have their own quick menu though. The Image Editor for example. These operators gets added in the quick menu of the image editor then. And does not show in the quick menu in the header of the 3D view.

Adding a menu to the Quick menu

It is also possible to add a menu to the Quick menu. For example the whole Add menu. The way is the same. Right click at it, and choose Add to Quick Favorites.

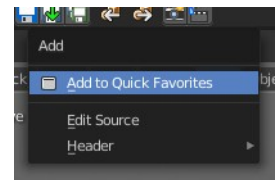

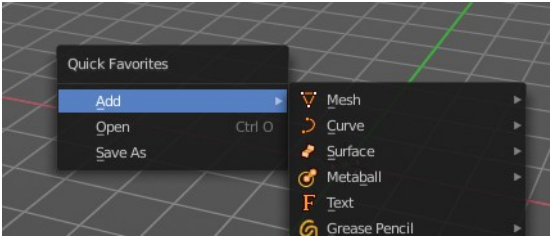

Order

You might notice that the add menu adds at the top of the menu, and not at the bottom as you would expect. First comes menus, then comes operators. And they get added in the order in which you add them.

Besides that, operators and menus gets added in the order that you add them. They cannot be sorted afterwards. So be careful how you add them. You can of course always remove operators and menus, and re-add them at the end of the list.

Removing an operator from the Quick menu

Removing is as simple as adding. Right click at the operators in the Quick menu, and choose Remove from Quick favorites.

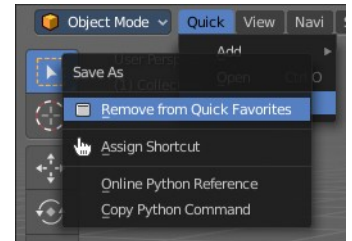

Context and mode dependent content

The quick favorites. menu exists in nearly all editors. But it is just in the 3D view available in the header. So that you know this functionality exists. In the other editors you call it with hotkey Q.

The content of the quick favorites. menu changes, dependent over which editor you are, and in what mode you are. When you add for example an operator from the image editor, then this operator just shows in the quick menu when you call the menu from the image editor. Same goes for the modes. Edit mode tools will just show in edit mode. And so on.



7.1.20 Editors - 3D Viewport - Header - Mesh - Weight Paint mode - Weights menu

Table of content

Weight Paint Mode - Weights Menu.....	3
Legacy submenu.....	3
Sample Weight.....	3
Sample Group.....	3
Gradient (Linear).....	3
Gradient(Radial).....	3
Assign from Bone Envelopes.....	3
Assign Automatic from Bones.....	3
Last Operator Weight from Bones.....	4
Type.....	4
Normalize All.....	4
Last Operator Normalize all.....	4
Subset.....	4
Lock Active.....	4
Normalize.....	4
Mirror.....	4
Last Operator Mirror Vertex Group.....	4
Mirror Weights.....	4
Flip Group Names.....	4
All Groups.....	4
Topology Mirror.....	5
Invert.....	5
Last Operator Invert Vertex Group.....	5
Subset.....	5
Add Weights.....	5
Remove Weights.....	5
Clean.....	5
Last Operator Clean Vertex Group.....	5
Subset.....	5
Limit.....	5
Keep Single.....	5
Quantize.....	5
Last Operator Quantize Vertex Weights.....	6
Subset.....	6
Steps.....	6
Levels.....	6
Last Operator Levels.....	6
Subset.....	6
Offset.....	6
Gain.....	6
Smooth.....	6
Last Operator Smooth Vertex Weights.....	6
Subset.....	6
Factor.....	6
Iterations.....	6

Expand/Contract.....	6
Transfer Weights.....	7
Usage.....	7
Last Operator Transfer Mesh Data.....	7
Freeze Operator.....	7
Data Type.....	7
Create Data.....	8
Vertex Mapping.....	8
Auto Transform.....	8
Object Transform.....	8
Only Neighbor Geometry.....	8
Ray Radius.....	8
Source Layers Selection.....	8
Destination Layers Matching.....	8
Mix Mode.....	8
Mix Factor.....	8
Limit Total.....	8
Last Operator Limit Number of Weights.....	9
Subset.....	9
Limit.....	9
Set Weight.....	9
Locks.....	9
Last Operator Change Lock.....	10
Action.....	10
Mask.....	10

Weight Paint Mode - Weights Menu

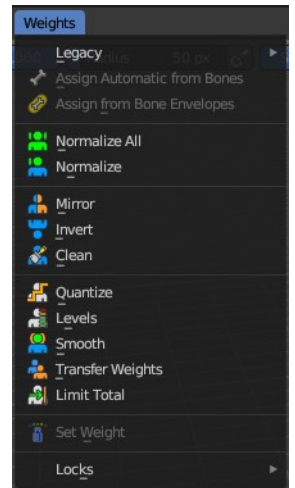

Legacy submenu

The legacy sub menu contains legacy menu items. These tools exists in the toolbar.

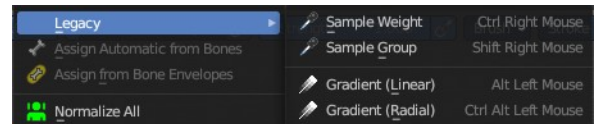

Sample Weight

Pick the weight under the mouse by a click.

Sample Group

Pick the group under the mouse by a click.

Gradient (Linear)

Allows you to draw a gradient at the mesh. Click, drag the mouse, release. The gradient will be applied linear in drag direction.

Gradient(Radial)

Allows you to draw a gradient at the mesh. Click, drag the mouse, release. The gradient will be applied radial from the mouse position.

Assign from Bone Envelopes

Weights the vertices from the connected bone envelopes. And takes the distance to the bone envelope into account.

Assign Automatic from Bones

Weights the vertices connected with the bone. And takes the distance to the bone into account.

Last Operator Weight from Bones

This last operator is the same for both tools. Assign Automatic from Bones, and Assign from Bone Envelopes.

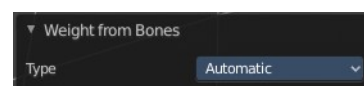

Type

Choose if you want to Assign from Bone Envelopes, or from Bones.

Normalize All

Normalize all normalizes the weight of all Vertex groups so that the values for the single vertices in the sum is 1.

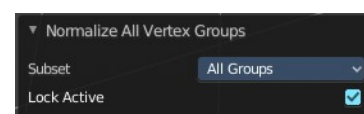

Last Operator Normalize all

Subset

Subset is a drop-down menu choose the Subset method.

Lock Active

Normalize just the other groups. Not the active group.

Normalize

Normalize normalizes the weight of the current selected Vertex group so that the values for the single vertices in the sum is 1. Means when there is influence from other groups, then those values are kept, but the one for the current group gets lowered so that the sum is 1.

Mirror

Mirror Vertex Group mirrors Vertex Groups and flips weights and/or names. It only edits selected Vertices. It flips when both sides are selected. Otherwise it copies from Unselected.

Last Operator Mirror Vertex Group

Mirror Weights

With Mirror Weights ticked it mirrors the weights.



Flip Group Names

With Flip Group Names ticked it flips the Group names

All Groups

Mirrors all Vertex Groups.

Topology Mirror

Uses topology based mirroring. This requires matching mirrored topology.

Invert

Invert inverts the weight painting for the selected vertex group.

Last Operator Invert Vertex Group

Subset

Subset is a drop-down menu choose the Subset method.

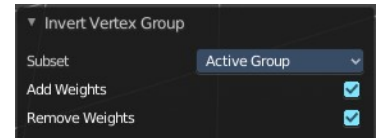

Add Weights

Add Vertices from Groups that have zero Weighting before inverting.

Remove Weights

Remove Vertices from Groups that have zero weight after inverting.

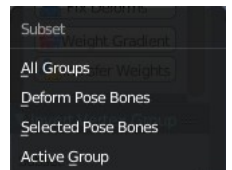

Clean

Removes Vertex group assignments that are not required from the active vertex group.

Last Operator Clean Vertex Group

Subset

Subset is a drop-down menu choose the Subset method.

Limit

Remove weights that are below or equal to the limit value.

Keep Single

Keep Vertices assigned to at least one vertex group when cleaning.

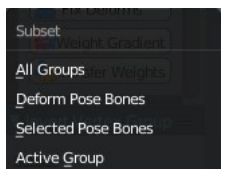
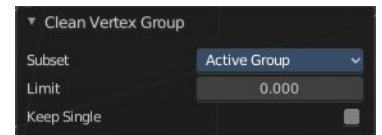

Quantize

Quantize quantizes the weight paint values. It starts with 4 steps. With a step of 1 you have a single vertex color, no matter how you have painted it before.

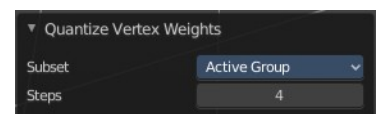

Last Operator Quantize Vertex Weights

Subset

Subset is a drop-down menu choose the Subset method.

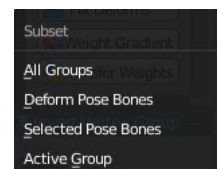

Steps

Here you adjust in how many steps the weight paint colors should be divided.

Levels

Adds some offset to the Weight paint, and multiplies it with some gain.

Last Operator Levels

Subset

Subset is a drop-down menu choose the Subset method.

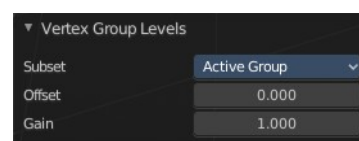

Offset

Here you adjust the offset.

Gain

Here you adjust the gain.

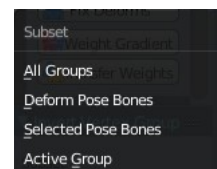

Smooth

Smooths the weight for selected vertices.

Last Operator Smooth Vertex Weights

Subset

Subset is a drop-down menu choose the Subset method.

Factor

Here you adjust the factor.

Iterations

Here you adjust how many iterations you use.

Expand/Contract

Expand or contract the weights.

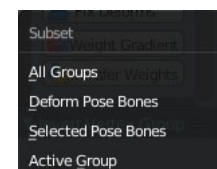
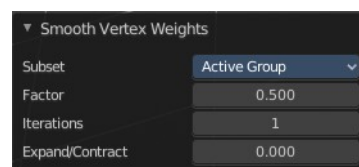

Transfer Weights

Transfer weights allows you to transfer weights from one object to another object in the same space. For example to copy the weight of a body shape to a covering cloth.

Usage

Make sure the target part is at its location.

In Object mode Select the source object(s). Then shift click to select the target object too. This makes the target object the active object

Switch to Weight Paint mode.

Click the Transfer Weight Button, and the weighting should be transferred to the target object.

You can adjust the result in the Last Operator Transfer Mesh Data panel.

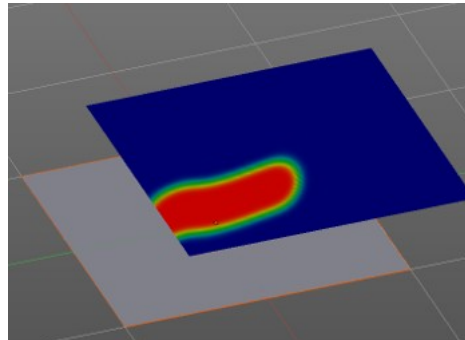
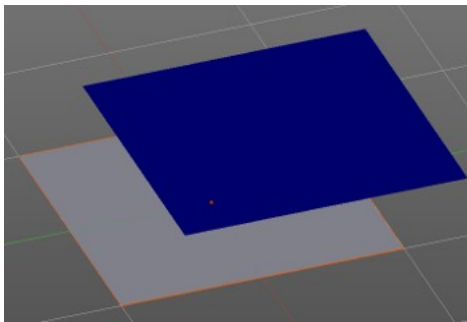
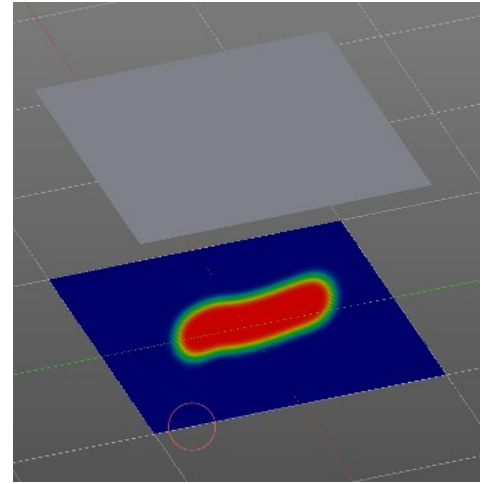

Last Operator Transfer Mesh Data

Freeze Operator

Prevent the operator to rerun when you tweak the settings. So that you can tweak many settings at once, then untick to run the operator again.

Data Type

A drop down box choose the data type to work with.

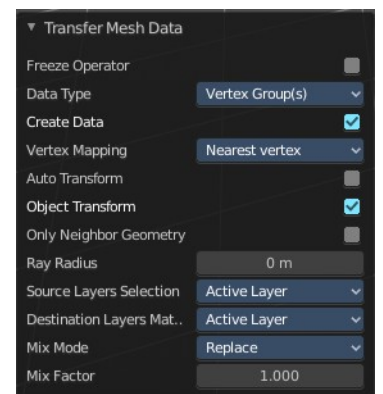
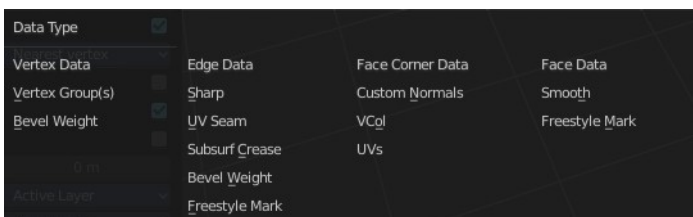

Create Data

Add Data layers on target object if needed.

Vertex Mapping

A drop down box choose the vertex mapping method.

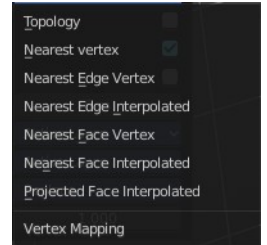

Auto Transform

Automatically compute transformation to get the best possible match between source and target object.

Object Transform

Calculate the objects in Global space. Unticked means the transfer happens from and to the origin of the objects.

Only Neighbor Geometry

Source Objects must be closer than given distance to the target objects.

Ray Radius

The ray distance for Only Neighbor Geometry.

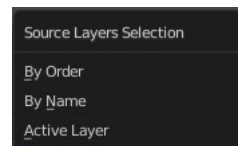

Source Layers Selection

A drop down box choose the Source Layer selection method.

Destination Layers Matching

A drop down box choose the Destination Layers matching.

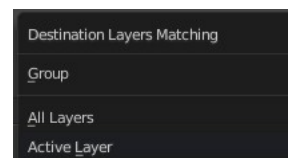

Mix Mode

A drop down box choose the mix mode. That's how the mapping gets transferred into the target object.

Mix Factor

The strength of the chosen mix mode.

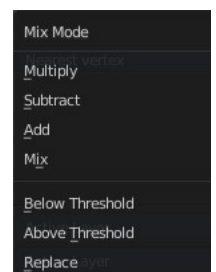

Limit Total

Limit the number of deform weights for a vertex by removing the lowest weights. For example when five vertex groups are assigned to one vertice, and you set the limit to 4, then the vertice will just be assigned to the

four vertex groups with the highest weight. This is useful for game content where the game engine has a limit for how much bones can be connected to one vertice.

Last Operator Limit Number of Weights

Subset

A drop down box choose to work with the Active Group or All Groups.

Limit

Set the limit.



Set Weight

This tool is just active when you have either Face Selection Masking or Vertex Selection Masking activated.

The tool fills the selection with the current active weight color that you have adjusted in the Brush panel in the Tools tab in the Tool shelf.

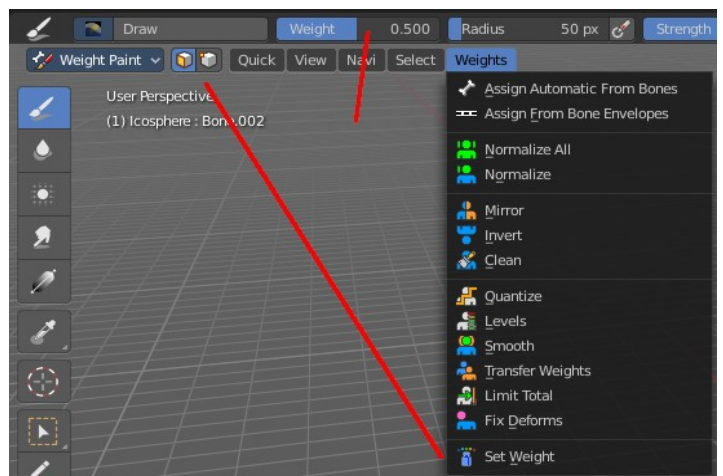

Locks

Locks is a sub menu with which you can modify the vertex group locks in the properties editor.

The names should be self explaining.

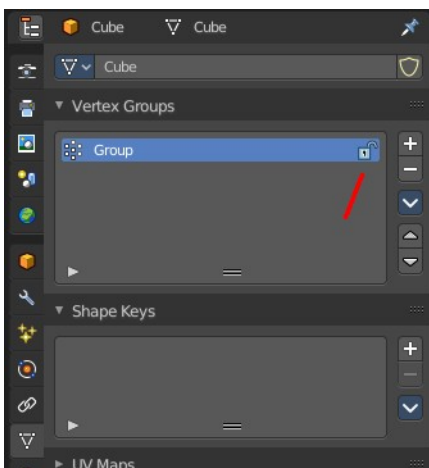
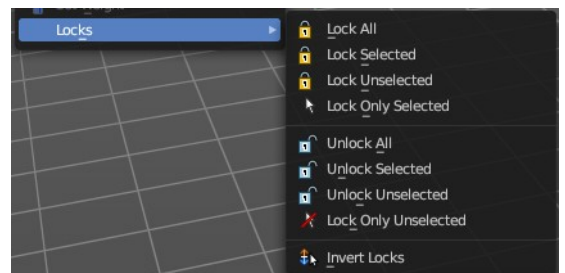

Last Operator Change Lock

Action

Choose the locking method again.

Mask

Choose what vertex groups should be affected.

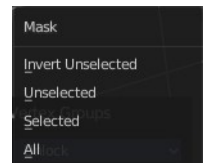
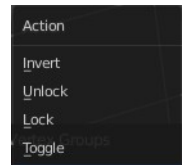

7.1.22 Editors - 3D Viewport - Header - Mesh - Texture Paint mode - Brush menu

Table of content

Texture Paint Mode - Brush Menu.....	1
Color Picker.....	1

Texture Paint Mode - Brush Menu

With texture mapping type stencil you will see the navigation controls to navigate the stencil map. Same for the texture mask mapping type stencil. These navigation types are hotkey only tools.

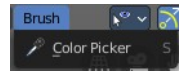

Color Picker

Allows you to pick a color in the 3D view. Hotkey tool!

Move, Rotate Scale Stencil Texture.

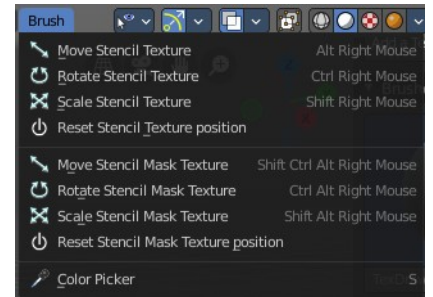



7.1.23 Editors - 3D View - Header - Curve - Edit mode - Curve menu

Table of content

Detailed Table of content.....	1
Edit Mode - Curve Menu.....	5
Transform.....	5
To Sphere.....	5
Shear.....	6
Bend.....	7
Push/Pull.....	7
Warp.....	8
Randomize Transform.....	8
Radius.....	9
Move Texture Space.....	9
Scale Texture Space.....	11
Set Dimensions.....	12
Mirror.....	12
Interactive Mirror.....	12
X Global, Y Global etc.....	12
Snap.....	13
Last Operator Snap.....	13
Operators.....	14
Duplicate.....	14
Split.....	14
Separate.....	15
Toggle Cyclic.....	15
Decimate Curve.....	15
Set Spline Type.....	15
Tilt.....	16
Clear Tilt.....	16
Set Handle Type.....	16
Recalc Normals.....	17
Show / Hide.....	17
Delete.....	18
Dissolve Vertices.....	18

Detailed Table of content

Detailed table of content

Detailed Table of content.....	1
Edit Mode - Curve Menu.....	5
Transform.....	5
To Sphere.....	5
Usage.....	5
Last Operator To Sphere.....	5
Factor.....	5

Proportional editing.....	6
Proportional Falloff.....	6
Proportional Size.....	6
Connected.....	6
Projected(2D).....	6
Shear.....	6
Last Operator Shear.....	6
Offset.....	6
Shear Axis.....	6
Axis.....	6
Axis Ortho.....	6
Orientation.....	6
Proportional editing.....	7
Proportional Falloff.....	7
Proportional Size.....	7
Connected.....	7
Projected(2D).....	7
Bend.....	7
Push/Pull.....	7
Last Operator Push/Pull.....	7
Factor.....	7
Proportional editing.....	7
Proportional Falloff.....	7
Proportional Size.....	7
Connected.....	8
Projected(2D).....	8
Warp.....	8
Last operator Warp.....	8
Warp Angle.....	8
Offset Angle.....	8
Min.....	8
Max.....	8
Randomize Transform.....	8
Last Operator Randomize Transform.....	8
Amount.....	8
Uniform.....	8
Normal.....	8
Random Seed.....	8
Radius.....	9
Last Operator Shrink/Fatten.....	9
Offset.....	9
Offset Even.....	9
Proportional editing.....	9
Proportional Falloff.....	9
Proportional Size.....	9
Connected.....	9
Projected(2D).....	9
Move Texture Space.....	9
Last Operator Translate.....	10
Move X, Y Z.....	10
Orientation.....	10
Proportional editing.....	10
Proportional Falloff.....	10

Proportional Size.....	10
Connected.....	10
Projected(2D).....	10
Scale Texture Space.....	11
Last Operator Resize Texture.....	11
Move X, Y Z.....	11
Orientation.....	11
Proportional editing.....	11
Proportional Falloff.....	11
Proportional Size.....	12
Connected.....	12
Projected(2D).....	12
Set Dimensions.....	12
Last Operator Set Dimensions.....	12
New Dimensions.....	12
Mirror.....	12
Interactive Mirror.....	12
X Global, Y Global etc.....	12
Last Operator Mirror.....	13
Orientation.....	13
Constraint Axis.....	13
Proportional editing.....	13
Proportional Falloff.....	13
Proportional Size.....	13
Connected.....	13
Projected(2D).....	13
Snap.....	13
Last Operator Snap.....	13
Offset.....	13
Operators.....	14
Duplicate.....	14
Last Operator Duplicate.....	14
Move X , Y , Z.....	14
Orientation.....	14
Proportional editing.....	14
Proportional Falloff.....	14
Proportional Size.....	14
Connected.....	14
Projected(2D).....	14
Split.....	14
Separate.....	15
Toggle Cyclic.....	15
Last Operator Toggle Cyclic.....	15
Direction.....	15
Decimate Curve.....	15
Last Operator Decimate Curve.....	15
Ratio.....	15
Set Spline Type.....	15
Last Operator Set Spline Type.....	15
Type.....	15
Handles.....	15
Tilt.....	16
Last Operator Tilt.....	16

Angle.....	16
Proportional editing.....	16
Proportional Falloff.....	16
Proportional Size.....	16
Connected.....	16
Projected(2D).....	16
Clear Tilt.....	16
Set Handle Type.....	16
Auto.....	17
Vector.....	17
Align.....	17
Free.....	17
Toggle Free/Aligned.....	17
Last Operator Set Handle Type.....	17
Type.....	17
Recalc Normals.....	17
Last Operator Recalc Normals.....	17
Length.....	17
Show / Hide.....	17
Show Hidden.....	17
Hide Selected.....	17
Last Operator Hide Selected.....	18
Unselected.....	18
Hide Unselected.....	18
Delete.....	18
Vertices.....	18
Segment.....	18
Dissolve Vertices.....	18

Edit Mode - Curve Menu

The curve menu just exists for curve objects.

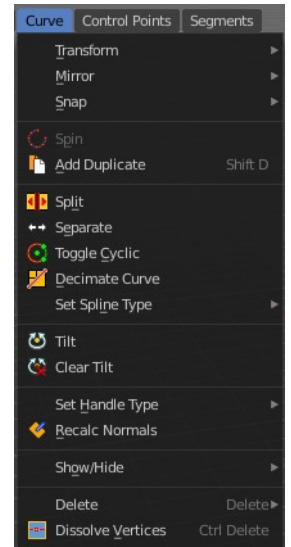

Transform

To Sphere

Shapes a selection of objects into the shape of a sphere. The calculation happens with the object origins.

In Object mode this tool requires to have more than one object selected.

Usage

Select the vertices, activate the tool, then drag the mouse in the 3D viewport. In the header you will read the current factor then. Which tells you how close you are towards the sphere shape. This also works with curves in the same way.

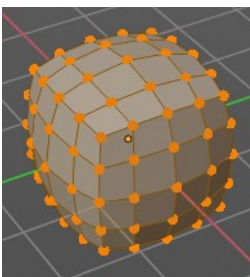
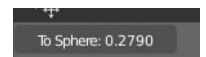
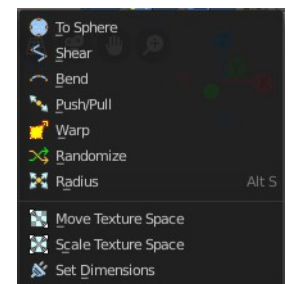

Last Operator To Sphere

Factor

The factor to transform the selection into a shape form.

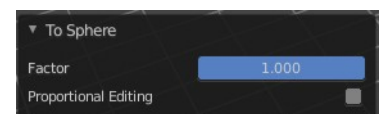

Proportional editing

Enables proportional editing. Activating proportional editing reveals further settings.

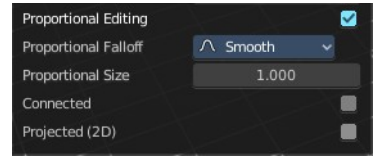

Proportional Falloff

Adjust the falloff methods.

Proportional Size

See and adjust the falloff radius.

Connected

The proportional falloff gets calculated for connected parts only.

Projected(2D)

The proportional falloff gets calculated in the screen space. Depth doesn't play a role. When it's in the radius, then it gets calculated.

Shear

Shear shears the selection.

Last Operator Shear

Offset

Adjust an offset.

Shear Axis

The shear tool works along an imaginary 2d plane. The shear axis controls if the items are sheared along the x or the y axes of this plane. This is the plane along which the transformation happens. You can shear along the x or the y axis of this plane.

To make things even more complicated, the orientation of this imaginary plane is defined by the Axis and Axis Ortho items below.

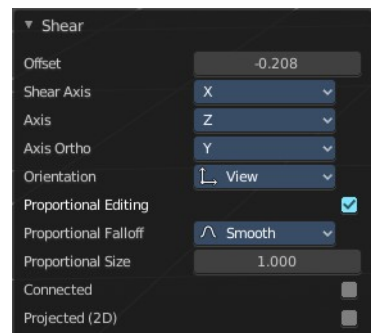

Axis

Defines one axis of the imaginary shear axis plane.

Axis Ortho

Defines the other axis of the imaginary shear axis plane.

Orientation

Choose the orientation for the shear action.

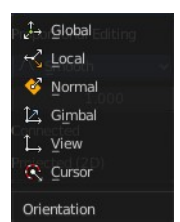

Proportional editing

Enables proportional editing. Activating proportional editing reveals further settings.

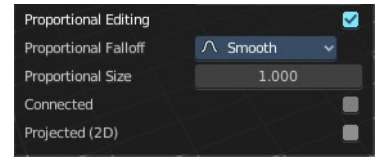

Proportional Falloff

Adjust the falloff methods.

Proportional Size

See and adjust the falloff radius.

Connected

The proportional falloff gets calculated for connected parts only.

Projected(2D)

The proportional falloff gets calculated in the screen space. Depth doesn't play a role. When it's in the radius, then it gets calculated.

Bend

Bends the selection.

Push/Pull

It pushes or pulls the object positions relative to the center of the selection.

In Object mode this tool requires to have more than one object selected.

Last Operator Push/Pull

Factor

Adjust the strength of influence of the tool.

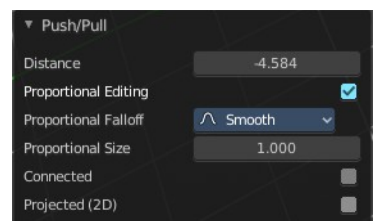

Proportional editing

Enables proportional editing. Activating proportional editing reveals further settings.

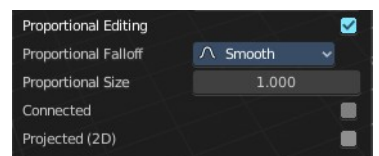

Proportional Falloff

Adjust the falloff methods.

Proportional Size

See and adjust the falloff radius.

Connected

The proportional falloff gets calculated for connected parts only.

Projected(2D)

The proportional falloff gets calculated in the screen space. Depth doesn't play a role. When it's in the radius, then it gets calculated.

Warp

Warp a mesh selection between two defined points. This also works with curves.

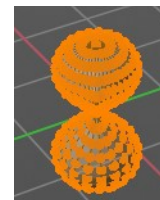

Last operator Warp

Warp Angle

The strength of the warp effect.

Offset Angle

An offset angle to bend side wards.

Min

The start point.

Max

The end point.



Randomize Transform

This tool allows randomizes the positions of the selected vertices.

Last Operator Randomize Transform

Amount

Adjust the amount.

Uniform

The uniform offset distance.

Normal

Align the offset direction to the normals.

Random Seed

The seed value for randomization.



Radius

Scales the selected geometry along its normals. Transform orientation and Pivot point gets ignored.

A positive value pushes the vertices outwards. A negative value pushes the vertices inwards.

Last Operator Shrink/Fatten

The Last Operator Shrink/Fatten panel gives you tools to adjust the Shrink/Fatten operation. Here you have numeric input for the strength and a few more options.

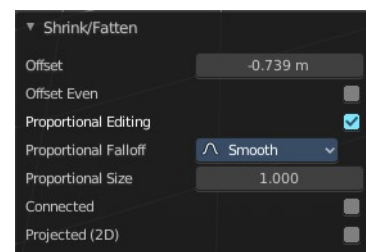

Offset

Offset is the strength of the offset for Shrink/Fatten.

Offset Even

Offset Even scales the selection to give more thickness in even areas.

Proportional editing

Enables proportional editing. Activating proportional editing reveals further settings.

Proportional Falloff

Adjust the falloff methods.

Proportional Size

See and adjust the falloff radius.

Connected

The proportional falloff gets calculated for connected parts only.

Projected(2D)

The proportional falloff gets calculated in the screen space. Depth doesn't play a role. When it's in the radius, then it gets calculated.

Move Texture Space

Move Texture space is meant for mesh objects, but has also functionality with a curve object.

This tool relies at the move tool. With the difference that it moves the texture space

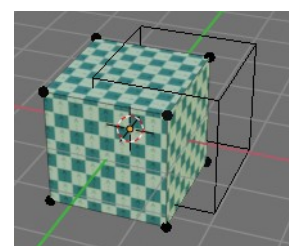

instead of the object. It has also a very special use case, and just works with a material with a Texture Coordinate / Generated node. And requires to have the shading at Material or Rendered to see a result in the viewport.

In the viewport you will see the UV cage in black color. In the header you will see the values for the current position of the UV cage.

Dx: -0.1501 m Dy: 0.05851 m Dz: 0.2117 m (0.2661 m)

Note that once done and applied, there is no way to reset the UV cage back to zero. When you repeat the operation, then the values will start at 0 again. Even when the UV cage is already offset.

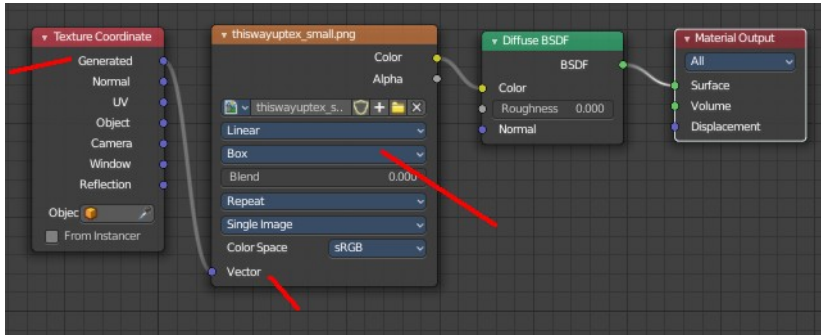

Last Operator Translate

Move X, Y Z

Limit the position relative to the source object.

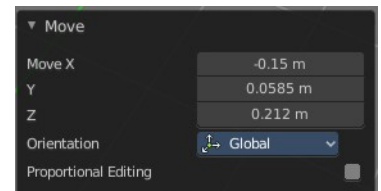

Orientation

Orientation is a drop-down box . Choose the type of orientation for the mirroring action.

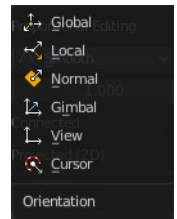

Proportional editing

Enables proportional editing. Activating proportional editing reveals further settings.

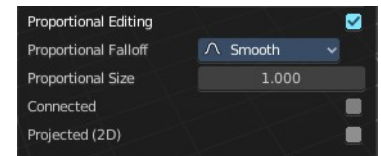

Proportional Falloff

Adjust the falloff methods.

Proportional Size

See and adjust the falloff radius.

Connected

The proportional falloff gets calculated for connected parts only.

Projected(2D)

The proportional falloff gets calculated in the screen space. Depth doesn't play a role. When it's in the radius, then it gets calculated.

Scale Texture Space

Scale Texture space is meant for mesh objects, but has also functionality with a curve object.

This tool relies at the scale tool. With the difference that it scales the texture space instead of the object. It has also a very special use case, and just works with a material with a Texture Coordinate / Generated node. And requires to have the shading at Material or Rendered to see a result in the viewport.

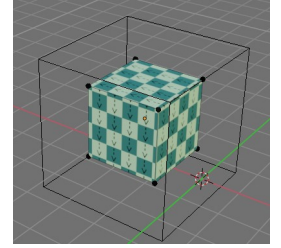

In the viewport you will see the UV cage in black color. In the header you will see the values for the current position of the UV cage.

Dx: -0.1501 m Dy: 0.05851 m Dz: 0.2117 m (0.2661 m)

Note that once done and applied, there is no way to reset the UV cage back to zero. When you repeat the operation, then the values will start at 0 again. Even when the UV cage is already offset.

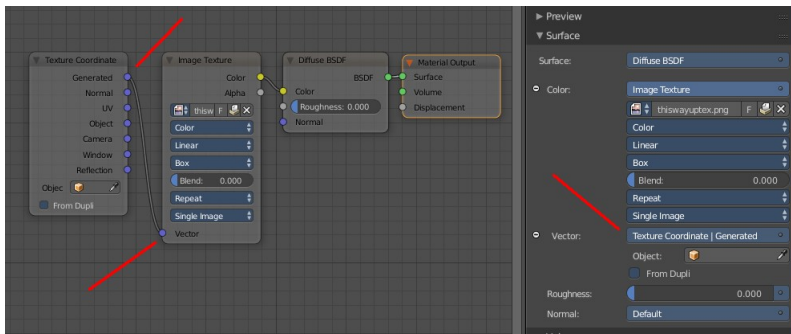

Last Operator Resize Texture

Move X, Y Z

Limit the position relative to the source object.

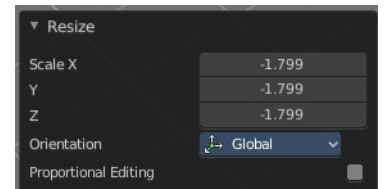

Orientation

Orientation is a drop-down box . Choose the type of orientation for the mirroring action.

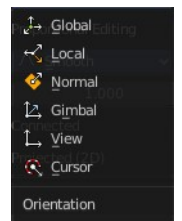

Proportional editing

Enables proportional editing. Activating proportional editing reveals further settings.

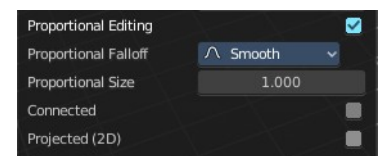

Proportional Falloff

Adjust the falloff methods.

Proportional Size

See and adjust the falloff radius.

Connected

The proportional falloff gets calculated for connected parts only.

Projected(2D)

The proportional falloff gets calculated in the screen space. Depth doesn't play a role. When it's in the radius, then it gets calculated.

Set Dimensions

Edit Mode Only!

Normally all scale operations in Bforartists are relative to the current selection and dimensions. And you always start with a relative value of 1.

Set dimensions allows to scale mesh selections in absolute world values. No matter how the initial values are. The new values gets set in the Last Operator.

Set dimensions is an add-on. You can turn it off in the add-ons section of the user preferences when you want.

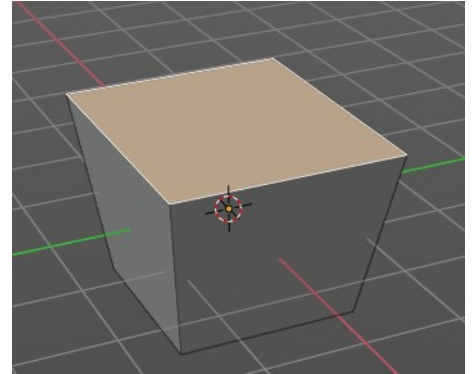

Last Operator Set Dimensions

New Dimensions

When you activate the tool then you will see the world coordinates of the selection. Change the values to other world coordinates.

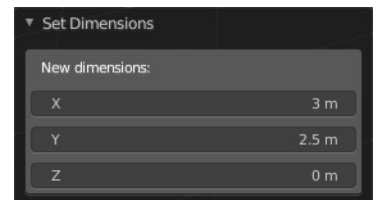

Mirror

Mirror mirrors the selected geometry along the defined axis.

Interactive Mirror

Mirror by hotkeys. You activate the tool, type in x for x global for example, or x x for x local. And the selection gets mirrored



X Global, Y Global etc.

Mirrors the selection around the chosen axis.

Last Operator Mirror

The Last Operator Mirror panel gives you tools to adjust the mirror action.

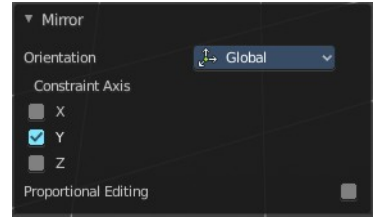

Orientation

Orientation is a drop-down box . Choose the type of orientation for the mirroring action.

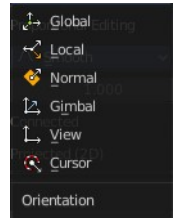

Constraint Axis

Constraint Axis gives you again the possibility to define the mirror axis. You can choose more than one axis here.

Proportional editing

Enables proportional editing. Activating proportional editing reveals further settings.

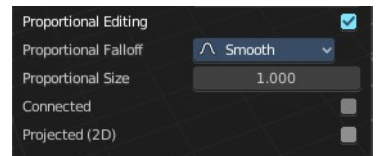

Proportional Falloff

Adjust the falloff methods.

Proportional Size

See and adjust the falloff radius.

Connected

The proportional falloff gets calculated for connected parts only.

Projected(2D)

The proportional falloff gets calculated in the screen space. Depth doesn't play a role. When it's in the radius, then it gets calculated.

Snap

Choose several methods to snap one element to another. The menu items should be self explaining.

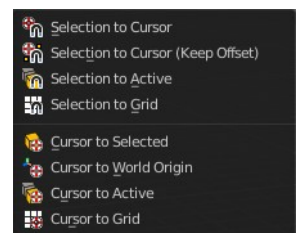

Last Operator Snap

Some snap operations shows a last operation panel, some not.

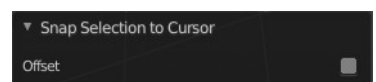

Offset

If the selection should snap as a whole, or if each individual element of the selection should snap.

Operators

Duplicate

Duplicates the current selection. This can be a single control point or a whole curve.

The copy sticks to the mouse until you release it. A Right click while moving will reset the position of the duplicate. The duplicated part will be part of the same object.

When you drag the duplicate around you will see the position values in the header.

Last Operator Duplicate

Move X , Y , Z

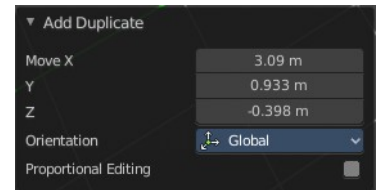

Orientation

Choose the orientation.

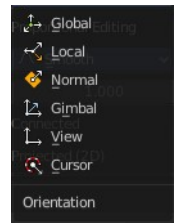

Proportional editing

Enables proportional editing. Activating proportional editing reveals further settings.

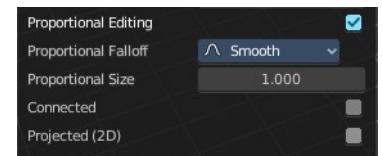

Proportional Falloff

Adjust the falloff methods.

Proportional Size

See and adjust the falloff radius.

Connected

The proportional falloff gets calculated for connected parts only.

Projected(2D)

The proportional falloff gets calculated in the screen space. Depth doesn't play a role. When it's in the radius, then it gets calculated.

Split

Splits the curve at the selected control point(s). You need to select two control points to select the segment between it.

Separate

Separates the selected control points, and creates a new curve object out of it. You need to select two control points to select the segment between it.

Toggle Cyclic

Toggle Cyclic closes or opens the curve.

Last Operator Toggle Cyclic

Direction

Direction is a drop-down box . Choose the direction in which the curve gets closed.

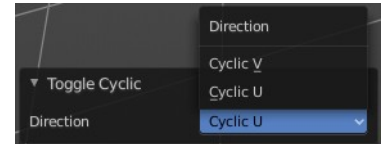

Decimate Curve

Decimates the currently selected geometry. It starts with a Ratio of 1. Which means no decimation. The lower the ratio the more decimation you will get.

Last Operator Decimate Curve

Ratio

Adjust the strength of decimation.

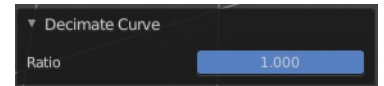

Set Spline Type

With set Spline Type you can set the type of the curve.

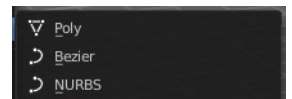

Poly is a straight line between the control points. Bezier has curve handlers. A nurbs curve has a control cage.

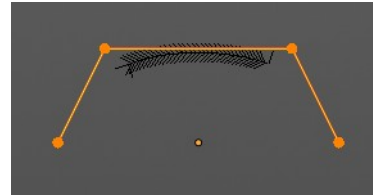
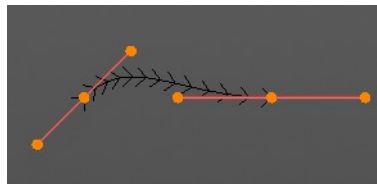
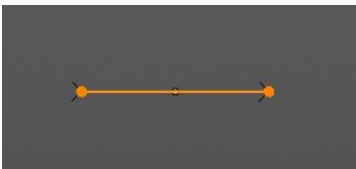

Last Operator Set Spline Type

Type

Type is a drop-down box . Choose the spline type

Handles

Use Handles when converting Bezier curves into polygons.

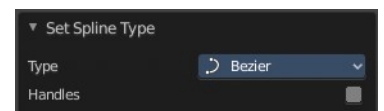

Tilt

Modifies the Mean Tilt.

Activate the tool, and drag the mouse. You will see a value in the header now. The selected curve path will rotate by dragging the mouse.

The Tilt angle always starts at zero. It is relative. To modify the Mean Tilt use the edit box in the Transform panel.

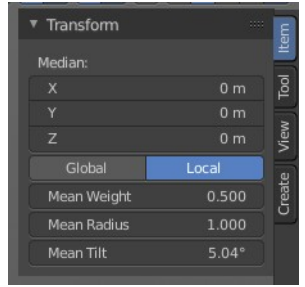

Last Operator Tilt

Angle

The Tilt angle.

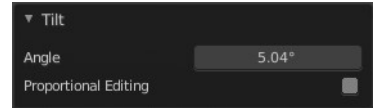

Proportional editing

Enables proportional editing. Activating proportional editing reveals further settings.

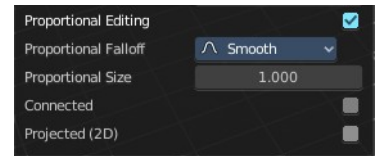

Proportional Falloff

Adjust the falloff methods.

Proportional Size

See and adjust the falloff radius.

Connected

The proportional falloff gets calculated for connected parts only.

Projected(2D)

The proportional falloff gets calculated in the screen space. Depth doesn't play a role. When it's in the radius, then it gets calculated.

Clear Tilt

Sets the Mean Tilt to zero.

Set Handle Type

Handles defines the type of handle for the knots of the curve. You have the choice between Auto, Vector, Align and Free. And the Last Operator gives you a fifth possibility to toggle between Free and Align.

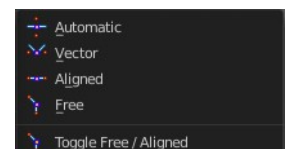

Auto

Auto aligns the handles automatically.

Vector

Set Handle type to Vector.

Align

Set Handle type to Align.

Free

Set Handle type to Free.

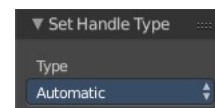

Toggle Free/Aligned

Toggle Free/Aligned.

Last Operator Set Handle Type

Type

Type is a drop-down box where you can set the handle type. You have the choice between Auto, Vector, Align, Free. And the fifth possibility toggles between Free and Align.

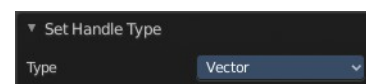

Recalc Normals

Recalculates the normals of the selected curve.

Last Operator Recalc Normals

Length

Recalculates the handle length too.

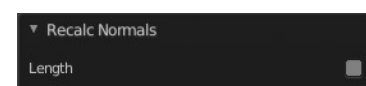

Show / Hide

Show Hidden

Makes all curve geometry in the scene visible again.

Hide Selected

Hides the selected curve geometry.

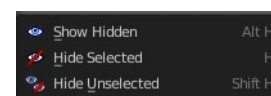

Last Operator Hide Selected

Unselected

Hides the not selected curve geometry.



Hide Unselected

Hides the not selected curve geometry. The selected geometry stays visible.

Delete

Vertices

Dissolves the selected vertices. When removing vertices in between then the curve stays intact and connected.



Segment

Removes the segment between the selected vertices.

Dissolve Vertices

Dissolves the selected vertices. When removing vertices in between then the curve stays intact and connected.



7.1.24 Editors - 3D Viewport - Header - Surface - Edit mode - Surface menu

Table of content

Detailed Table of content.....	1
Edit Mode - Curve Menu.....	5
Transform.....	5
To Sphere.....	5
Shear.....	6
Bend.....	7
Push/Pull.....	7
Warp.....	8
Randomize Transform.....	8
Shrink/Fatten.....	9
Move Texture Space.....	9
Scale Texture Space.....	11
Set Dimensions.....	12
Mirror.....	12
Interactive Mirror.....	12
X Global, Y Global etc.....	12
Snap.....	13
Last Operator Snap.....	13
Operators.....	13
Duplicate.....	14
Split.....	14
Separate.....	15
Toggle Cyclic.....	15
Set Spline Type.....	15
Set Handle Type.....	15
Show / Hide.....	16
Delete.....	16

Detailed Table of content

Detailed table of content

Detailed Table of content.....	1
Edit Mode - Curve Menu.....	5
Transform.....	5
To Sphere.....	5
Usage.....	5
Last Operator Add Ico Sphere Panel.....	5
Factor.....	5
Proportional editing.....	6
Proportional Falloff.....	6
Proportional Size.....	6
Connected.....	6
Projected(2D).....	6

Shear.....	6
Last Operator Shear.....	6
Offset.....	6
Shear Axis.....	6
Axis.....	6
Axis Ortho.....	6
Orientation.....	6
Proportional editing.....	7
Proportional Falloff.....	7
Proportional Size.....	7
Connected.....	7
Projected(2D).....	7
Bend.....	7
Push/Pull.....	7
Last Operator Push/Pull.....	7
Factor.....	7
Proportional editing.....	7
Proportional Falloff.....	7
Proportional Size.....	7
Connected.....	8
Projected(2D).....	8
Warp.....	8
Last operator Warp.....	8
Warp Angle.....	8
Offset Angle.....	8
Min.....	8
Max.....	8
Randomize Transform.....	8
Last Operator Randomize Transform.....	8
Amount.....	8
Uniform.....	8
Normal.....	8
Random Seed.....	8
Shrink/Fatten.....	9
Last Operator Shrink/Fatten.....	9
Offset.....	9
Offset Even.....	9
Proportional editing.....	9
Proportional Falloff.....	9
Proportional Size.....	9
Connected.....	9
Projected(2D).....	9
Move Texture Space.....	9
Last Operator Translate.....	10
Move X, Y Z.....	10
Orientation.....	10
Proportional editing.....	10
Proportional Falloff.....	10
Proportional Size.....	10
Connected.....	10
Projected(2D).....	10
Scale Texture Space.....	11
Last Operator Resize Texture.....	11

Move X, Y Z.....	11
Orientation.....	11
Proportional editing.....	11
Proportional Falloff.....	11
Proportional Size.....	11
Connected.....	12
Projected(2D).....	12
Set Dimensions.....	12
Last Operator Set Dimensions.....	12
New Dimensions.....	12
Mirror.....	12
Interactive Mirror.....	12
X Global, Y Global etc.....	12
Last Operator Mirror.....	12
Orientation.....	13
Constraint Axis.....	13
Proportional editing.....	13
Proportional Falloff.....	13
Proportional Size.....	13
Connected.....	13
Projected(2D).....	13
Snap.....	13
Last Operator Snap.....	13
Offset.....	13
Operators.....	13
Duplicate.....	14
Last Operator Duplicate.....	14
Move X , Y , Z.....	14
Orientation.....	14
Proportional editing.....	14
Proportional Falloff.....	14
Proportional Size.....	14
Connected.....	14
Projected(2D).....	14
Split.....	14
Separate.....	15
Toggle Cyclic.....	15
Last Operator Toggle Cyclic.....	15
Direction.....	15
Set Spline Type.....	15
Last Operator Set Spline Type.....	15
Type.....	15
Handles.....	15
Set Handle Type.....	15
Auto.....	15
Vector.....	16
Align.....	16
Free.....	16
Toggle Free/Aligned.....	16
Last Operator Set Handle Type.....	16
Type.....	16
Show / Hide.....	16
Show Hidden.....	16

Hide Selected.....	16
Last Operator Hide Selected.....	16
Unselected.....	16
Hide Unselected.....	16
Delete.....	16
Vertices.....	16
Segment.....	17

Edit Mode - Curve Menu

The Surface menu just exists for Surface objects.

Greyed out menu items are not available for surface objects. They are meant for curve objects of type Bezier. Those menu items are not covered here.

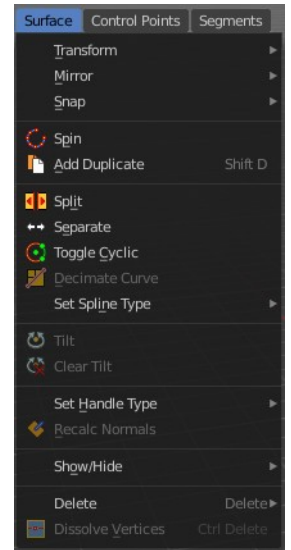

Transform

To Sphere

Shapes a selection of objects into the shape of a sphere. The calculation happens with the object origins.

In Object mode this tool requires to have more than one object selected.

Usage

Select the vertices, activate the tool, then drag the mouse in the 3D viewport. In the header you will read the current factor then. Which tells you how close you are towards the sphere shape. This also works with curves in the same way.

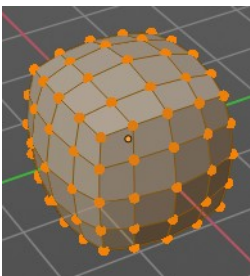
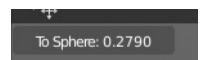
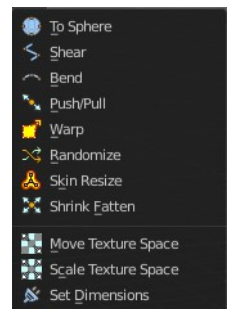

Last Operator Add Ico Sphere Panel

Factor

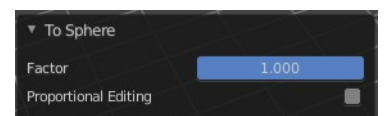

The factor to transform the selection into a shape form.

Proportional editing

Enables proportional editing. Activating proportional editing reveals further settings.

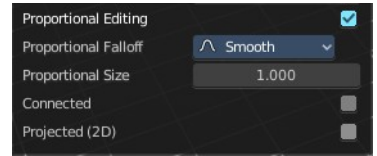

Proportional Falloff

Adjust the falloff methods.

Proportional Size

See and adjust the falloff radius.

Connected

The proportional falloff gets calculated for connected parts only.

Projected(2D)

The proportional falloff gets calculated in the screen space. Depth doesn't play a role. When it's in the radius, then it gets calculated.

Shear

Shear shears the selection.

Last Operator Shear

Offset

Adjust an offset.

Shear Axis

The shear tool works along a imaginary 2d plane. The shear axis controls if the items are sheared along the x or the y axes of this plane. This is the plane along which the transformation happens. You can shear along the x or the y axis of this plane.

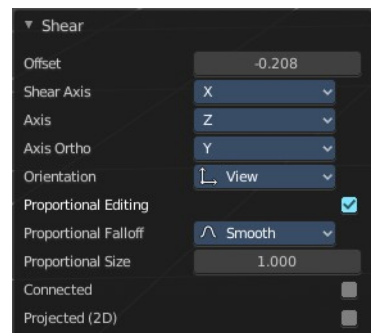

To make things even more complicated, the orientation of this imaginary plane is defined by the Axis and Axis Ortho items below.

Axis

Defines one axis of the imaginary shear axis plane.

Axis Ortho

Defines the other axis of the imaginary shear axis plane.

Orientation

Choose the orientation for the shear action.

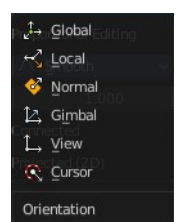

Proportional editing

Enables proportional editing. Activating proportional editing reveals further settings.

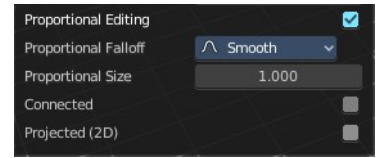

Proportional Falloff

Adjust the falloff methods.

Proportional Size

See and adjust the falloff radius.

Connected

The proportional falloff gets calculated for connected parts only.

Projected(2D)

The proportional falloff gets calculated in the screen space. Depth doesn't play a role. When it's in the radius, then it gets calculated.

Bend

Bends the selection.

Push/Pull

It pushes or pulls the object positions relative to the center of the selection.

In Object mode this tool requires to have more than one object selected.

Last Operator Push/Pull

Factor

Adjust the strength of influence of the tool.

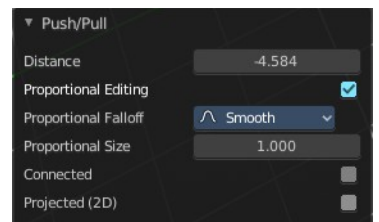

Proportional editing

Enables proportional editing. Activating proportional editing reveals further settings.

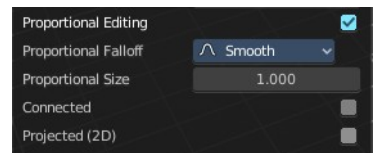

Proportional Falloff

Adjust the falloff methods.

Proportional Size

See and adjust the falloff radius.

Connected

The proportional falloff gets calculated for connected parts only.

Projected(2D)

The proportional falloff gets calculated in the screen space. Depth doesn't play a role. When it's in the radius, then it gets calculated.

Warp

Warp a mesh selection between two defined points. This also works with curves.

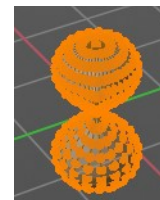

Last operator Warp

Warp Angle

The strength of the warp effect.

Offset Angle

An offset angle to bend side wards.

Min

The start point.

Max

The end point.



Randomize Transform

This tool allows randomizes the positions of the selected vertices.

Last Operator Randomize Transform

Amount

Adjust the amount.

Uniform

The uniform offset distance.

Normal

Align the offset direction to the normals.

Random Seed

The seed value for randomization.



Shrink/Fatten

Shrink/Fatten scales the selected geometry along its normals. Transform orientation and Pivot point gets ignored.

A positive value pushes the vertices outwards. A negative value pushes the vertices inwards.

Last Operator Shrink/Fatten

The Last Operator Shrink/Fatten panel gives you tools to adjust the Shrink/Fatten operation. Here you have numeric input for the strength and a few more options.

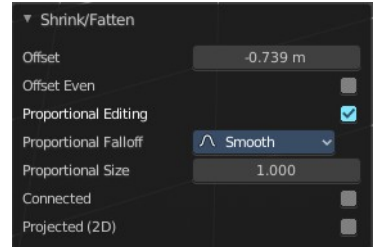

Offset

Offset is the strength of the offset for Shrink/Fatten.

Offset Even

Offset Even scales the selection to give more thickness in even areas.

Proportional editing

Enables proportional editing. Activating proportional editing reveals further settings.

Proportional Falloff

Adjust the falloff methods.

Proportional Size

See and adjust the falloff radius.

Connected

The proportional falloff gets calculated for connected parts only.

Projected(2D)

The proportional falloff gets calculated in the screen space. Depth doesn't play a role. When it's in the radius, then it gets calculated.

Move Texture Space

Move Texture space is meant for mesh objects, but has also functionality with a curve object.

This tool relies at the move tool. With the difference that it moves the texture space instead of the object. It has also a very special use case, and just works with a material with a Texture Coordinate / Generated node. And requires to have the shading at Material or Rendered to see a result in the viewport.

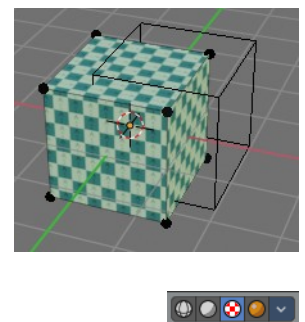

In the viewport you will see the UV cage in black color. In the header you will see the values for the current position of the UV cage.

Dx: -0.1501 m Dy: 0.05851 m Dz: 0.2117 m (0.2661 m)

Note that once done and applied, there is no way to reset the UV cage back to zero. When you repeat the operation, then the values will start at 0 again. Even when the UV cage is already offset.

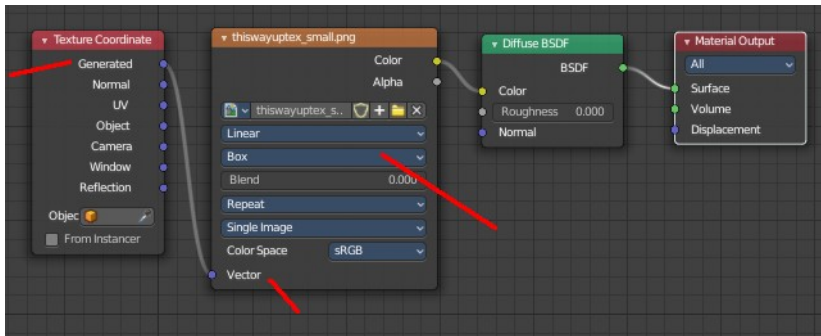

Last Operator Translate

Move X, Y Z

Limit the position relative to the source object.

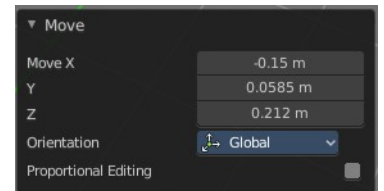

Orientation

Orientation is a drop-down box. Choose the type of orientation for the mirroring action.

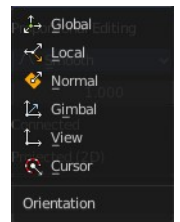

Proportional editing

Enables proportional editing. Activating proportional editing reveals further settings.

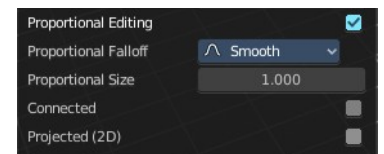

Proportional Falloff

Adjust the falloff methods.

Proportional Size

See and adjust the falloff radius.

Connected

The proportional falloff gets calculated for connected parts only.

Projected(2D)

The proportional falloff gets calculated in the screen space. Depth doesn't play a role. When it's in the radius, then it gets calculated.

Scale Texture Space

Scale Texture space is meant for mesh objects, but has also functionality with a curve object.

This tool relies at the scale tool. With the difference that it scales the texture space instead of the object. It has also a very special use case, and just works with a material with a Texture Coordinate / Generated node. And requires to have the shading at Material or Rendered to see a result in the viewport.

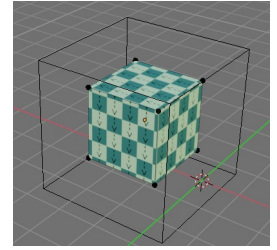

In the viewport you will see the UV cage in black color. In the header you will see the values for the current position of the UV cage.

Dx: -0.1501 m Dy: 0.05851 m Dz: 0.2117 m (0.2661 m)

Note that once done and applied, there is no way to reset the UV cage back to zero. When you repeat the operation, then the values will start at 0 again. Even when the UV cage is already offset.

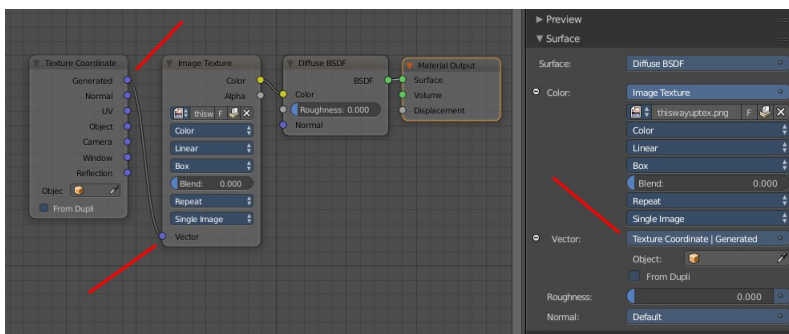

Last Operator Resize Texture

Move X, Y Z

Limit the position relative to the source object.

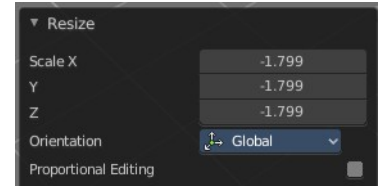

Orientation

Orientation is a drop-down box. Choose the type of orientation for the mirroring action.

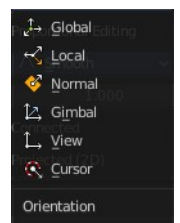

Proportional editing

Enables proportional editing. Activating proportional editing reveals further settings.

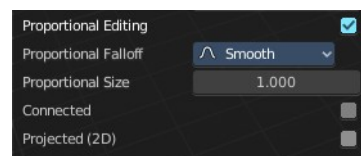

Proportional Falloff

Adjust the falloff methods.

Proportional Size

See and adjust the falloff radius.

Connected

The proportional falloff gets calculated for connected parts only.

Projected(2D)

The proportional falloff gets calculated in the screen space. Depth doesn't play a role. When it's in the radius, then it gets calculated.

Set Dimensions

Edit Mode Only!

Normally all scale operations in Bforartists are relative to the current selection and dimensions. And you always start with a relative value of 1.

Set dimensions allows to scale mesh selections in absolute world values. No matter how the initial values are. The new values gets set in the Last Operator.

Set dimensions is an add-on. You can turn it off in the add-ons section of the user preferences when you want.

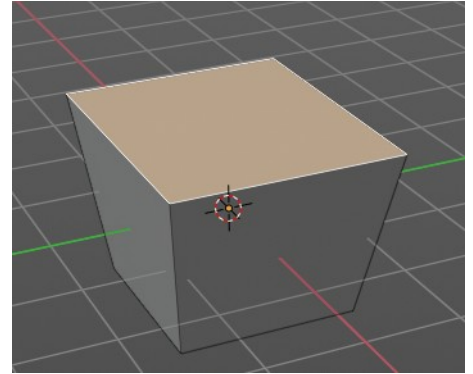

Last Operator Set Dimensions

New Dimensions

When you activate the tool then you will see the world coordinates of the selection. Change the values to other world coordinates.



Mirror

Mirror mirrors the selected geometry along the defined axis.

Interactive Mirror

Mirror by hotkeys. You activate the tool, type in x for x global for example, or x x for x local. And the selection gets mirrored



X Global, Y Global etc.

Mirrors the selection around the chosen axis.

Last Operator Mirror

The Last Operator Mirror panel gives you tools to adjust the mirror action.

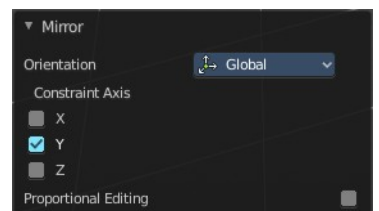

Orientation

Orientation is a drop-down box. Choose the type of orientation for the mirroring action.

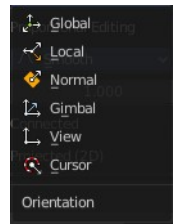

Constraint Axis

Constraint Axis gives you again the possibility to define the mirror axis. You can choose more than one axis here.

Proportional editing

Enables proportional editing. Activating proportional editing reveals further settings.

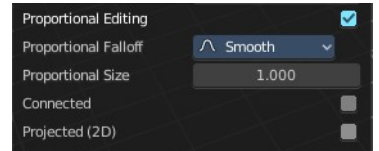

Proportional Falloff

Adjust the falloff methods.

Proportional Size

See and adjust the falloff radius.

Connected

The proportional falloff gets calculated for connected parts only.

Projected(2D)

The proportional falloff gets calculated in the screen space. Depth doesn't play a role. When it's in the radius, then it gets calculated.

Snap

Choose several methods to snap one element to another. The menu items should be self explaining.

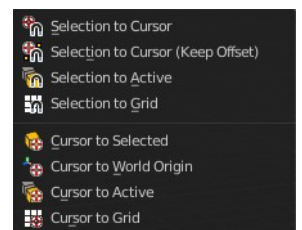

Last Operator Snap

Some snap operations shows a last operation panel, some not.

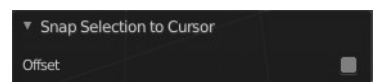

Offset

If the selection should snap as a whole, or if each individual element of the selection should snap.

Operators

Duplicate

Duplicates the current selection. This can be a single control point or a whole curve.

The copy sticks to the mouse until you release it. A Right click while moving will reset the position of the duplicate. The duplicated part will be part of the same object.

When you drag the duplicate around you will see the position values in the header.

Last Operator Duplicate

Move X , Y , Z

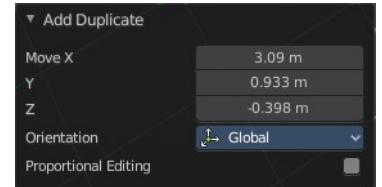

Orientation

Choose the orientation.

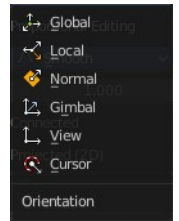

Proportional editing

Enables proportional editing. Activating proportional editing reveals further settings.

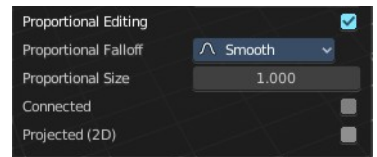

Proportional Falloff

Adjust the falloff methods.

Proportional Size

See and adjust the falloff radius.

Connected

The proportional falloff gets calculated for connected parts only.

Projected(2D)

The proportional falloff gets calculated in the screen space. Depth doesn't play a role. When it's in the radius, then it gets calculated.

Split

Splits the curve at the selected control point(s). You need to select two control points to select the segment between it.

Separate

Separates the selected control points, and creates a new curve object out of it. You need to select two control points to select the segment between it.

Toggle Cyclic

Toggle Cyclic closes or opens the curve.

Last Operator Toggle Cyclic

Direction

Direction is a drop-down box. Choose the direction in which the curve gets closed.

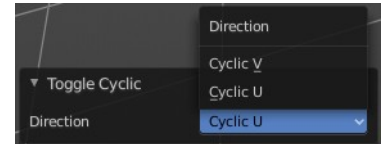

Set Spline Type

With set Spline Type you can set the type of the curve.

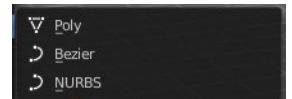

Poly is a straight line between the control points. Bezier has curve handlers. A nurbs curve has a control cage.

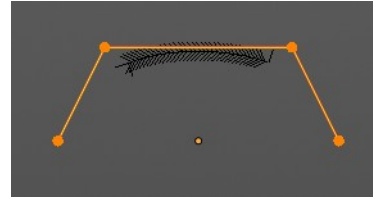
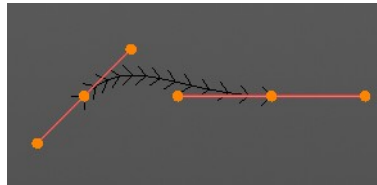
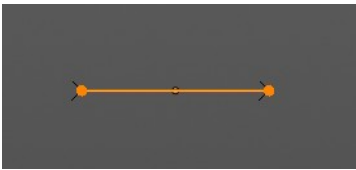

Last Operator Set Spline Type

Type

Type is a drop-down box. Choose the spline type

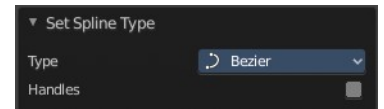

Handles

Use Handles when converting Bezier curves into polygons.

Set Handle Type

Handles defines the type of handle for the knots of the curve. You have the choice between Auto, Vector, Align and Free. And the Last Operator gives you a fifth possibility to toggle between Free and Align.

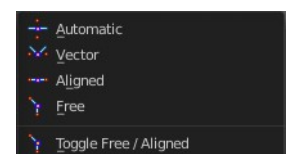

Auto

Auto aligns the handles automatically.

Vector

Set Handle type to Vector.

Align

Set Handle type to Align.

Free

Set Handle type to Free.

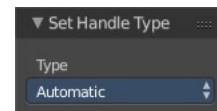

Toggle Free/Aligned

Toggle Free/Aligned.

Last Operator Set Handle Type

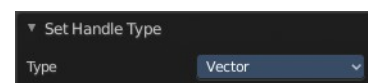

Type

Type is a drop-down box where you can set the handle type. You have the choice between Auto, Vector, Align, Free. And the fifth possibility toggles between Free and Align.

Show / Hide

Show Hidden

Makes all curve geometry in the scene visible again.

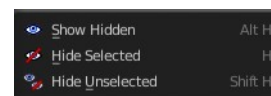

Hide Selected

Hides the selected curve geometry.

Last Operator Hide Selected

Unselected

Hides the not selected curve geometry.



Hide Unselected

Hides the not selected curve geometry. The selected geometry stays visible.

Delete

Vertices

Dissolves the selected vertices. When removing vertices in between then the curve stays intact and connected.

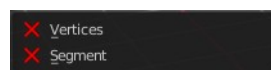

Segment

Removes the segment between the selected vertices.



7.1.25 Editors - 3D Viewport - Header - Curve & Surface - Edit mode - Control points menu

Table of content

Detailed Table of content.....	1
Edit Mode - Control Points menu.....	3
Extrude Curve.....	3
Extrude to Cursor or Add.....	4
Make Segment.....	4
Tilt.....	4
Clear Tilt.....	5
Set Handle Type.....	5
Recalc Normals.....	6
Smooth.....	6
Smooth Curve Tilt.....	6
Smooth Curve Radius.....	6
Smooth Curve Weight.....	6
Hooks.....	6
Make Vertex Parent.....	8

Detailed Table of content

Detailed table of content

Detailed Table of content.....	1
Edit Mode - Control Points menu.....	3
Extrude Curve.....	3
Last operator Extrude Curve and Move.....	3
Mode.....	3
Move X , Y , Z.....	3
Orientation.....	3
Proportional editing.....	3
Proportional Falloff.....	4
Proportional Size.....	4
Connected.....	4
Projected(2D).....	4
Extrude to Cursor or Add.....	4
Last Operator Extrude to Cursor or Add.....	4
Location X Y Z.....	4
Make Segment.....	4
Tilt.....	4
Last Operator Tilt.....	4
Angle.....	4
Proportional editing.....	5
Proportional Falloff.....	5
Proportional Size.....	5
Connected.....	5
Projected(2D).....	5
Clear Tilt.....	5

Set Handle Type.....	5
Auto.....	5
Vector.....	5
Align.....	5
Free.....	5
Toggle Free/Aligned.....	5
Last Operator Set Handle Type.....	6
Type.....	6
Recalc Normals.....	6
Last Operator Recalc Normals.....	6
Length.....	6
Smooth.....	6
Smooth Curve Tilt.....	6
Smooth Curve Radius.....	6
Smooth Curve Weight.....	6
Hooks.....	6
Hook to New Object.....	7
Hook to Selected Object.....	7
Last Operator Hook to Selected Object.....	7
Active Bone.....	7
Hook to Selected Object Bone.....	7
Assign to Hook.....	7
Remove Hook.....	7
Select Hook.....	7
Reset Hook.....	7
Recenter Hook.....	7
Make Vertex Parent.....	8
Workflow:.....	8

Edit Mode - Control Points menu

The control points menu exists for Curve and Surface objects in edit mode.

For the surface object type there are not this much operators available. Left the menu with a surface object. Right the menu with a curve object.

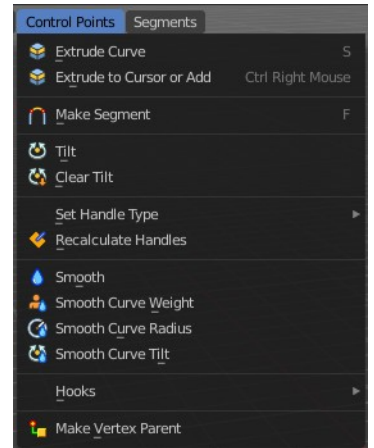
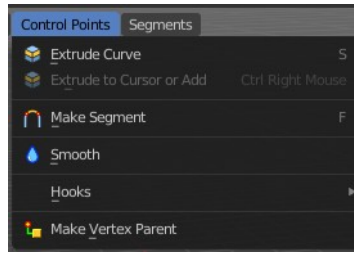

Extrude Curve

Extrudes the selected curve point(s).

Last operator Extrude Curve and Move

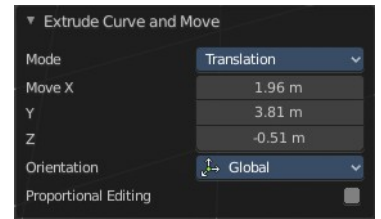

Mode

A drop-down box where you can choose between different extrude modes.

Default is Translation. Most other methods has no effect.



Move X , Y , Z

The position of the extruded point(s).

Orientation

Adjust the orientation of the extrusion. It usually starts with Normal.

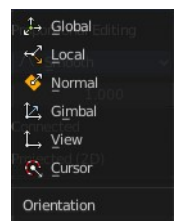

Proportional editing

Enables proportional editing. Activating proportional editing reveals further settings.

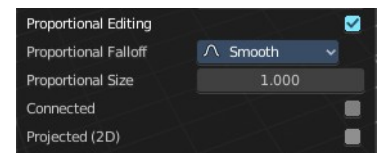

Proportional Falloff

Adjust the falloff methods.

Proportional Size

See and adjust the falloff radius.

Connected

The proportional falloff gets calculated for connected parts only.

Projected(2D)

The proportional falloff gets calculated in the screen space. Depth doesn't play a role. When it's in the radius, then it gets calculated.

Extrude to Cursor or Add

Hotkey only tool. Extrude to the mouse position.

Last Operator Extrude to Cursor or Add

Location X Y Z

The location to extrude to.

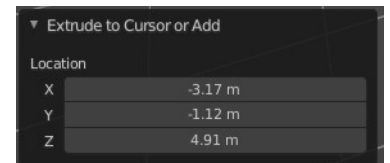

Make Segment

Joins two curves by adding a segment between the end of the one and the beginning of the other. You can also create a closed curve that way.

Tilt

Modifies the Mean Tilt.

Activate the tool, and drag the mouse. You will see a value in the header now. The selected curve path will rotate by dragging the mouse.

The Tilt angle always starts at zero. It is relative. To modify the Mean Tilt use the edit box in the Transform panel.

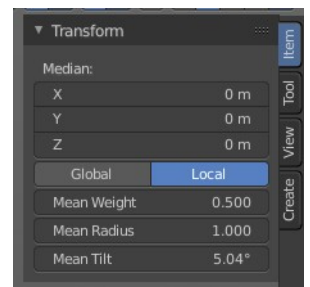

Last Operator Tilt

Angle

The Tilt angle.

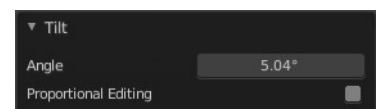

Proportional editing

Enables proportional editing. Activating proportional editing reveals further settings.

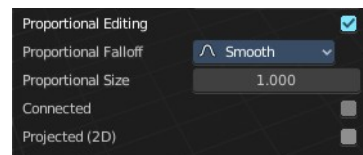

Proportional Falloff

Adjust the falloff methods.

Proportional Size

See and adjust the falloff radius.

Connected

The proportional falloff gets calculated for connected parts only.

Projected(2D)

The proportional falloff gets calculated in the screen space. Depth doesn't play a role. When it's in the radius, then it gets calculated.

Clear Tilt

Sets the Mean Tilt to zero.

Set Handle Type

Handles defines the type of handle for the knots of the curve. You have the choice between Auto, Vector, Align and Free. And the Last Operator gives you a fifth possibility to toggle between Free and Align.

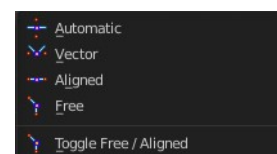

Auto

Auto aligns the handles automatically.

Vector

Set Handle type to Vector.

Align

Set Handle type to Align.

Free

Set Handle type to Free.

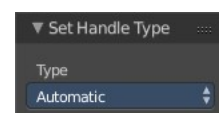

Toggle Free/Aligned

Toggle Free/Aligned.

Last Operator Set Handle Type

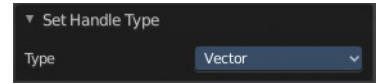

Type
Type is a drop-down box where you can set the handle type. You have the choice between Auto, Vector, Align, Free. And the fifth possibility toggles between Free and Align.

Recalc Normals

Recalculates the normals of the selected curve.

Last Operator Recalc Normals

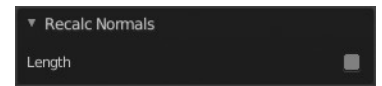

Length

Recalculates the handle length too.

Smooth

Flattens the angles of the selected control point(s).

Smooth Curve Tilt

Smooths the curve tilt of the selected control point(s).

Smooth Curve Radius

Smooths the curve radius of the selected control point(s).

Smooth Curve Weight

Interpolates the weight of the selected control point(s).

Hooks

Hooks is a menu with tools around the hook modifier. You could also adjust the hook modifier from the Properties editor. But the menu items are more accessible.

When there is no hook modifier at the mesh then you just see three menu items. When there is minimum one hook modifier applied, then you

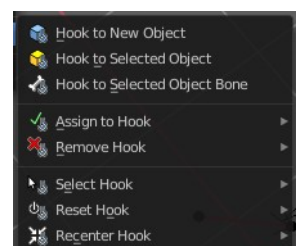
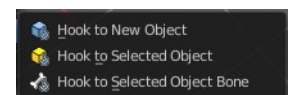
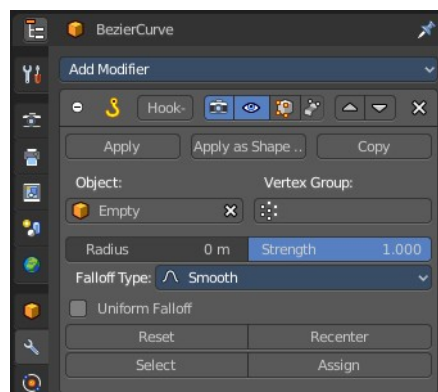

will see an extended menu.

Hook to New Object

Creates a new Hook Modifier for the active object and assigns it to the selected vertices. It also creates an empty at the center of those vertices, which are hooked to it.

Hook to Selected Object

Does the same as *Hook to New Object*, but instead of hooking the vertices to a new empty, it hooks them to the selected object (if it exists). There should be only one selected object (besides the mesh being edited).

Last Operator Hook to Selected Object

Active Bone

Hook to the object(s) of the active bone.

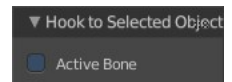

Hook to Selected Object Bone

Does the same as *Hook to New Object*. But it sets the last selected bone in the also selected armature as a target.

Assign to Hook

Assign the selected vertices to the chosen hook modifier. Existing hooks gets overwritten. One vertex can be assigned to more than one hook.

Remove Hook

Removes the chosen Hook Modifier from the object.

Select Hook

Selects all vertices assigned to the chosen Hook Modifier.

Reset Hook

Resets the chosen Hook Modifier.

Recenter Hook

Recenter the Hook Modifier.

Make Vertex Parent

Parents another object to the selected vertice(s).

Workflow:

In Object mode select the object that you want to parent to a vertex. Shift select the parent object so that both are selected. Enter Edit mode. Then select one vertex for a single point. Then click the Make Vertex Parent button to make the relation.



7.1.26 Editors - 3D Viewport - Header - Curve & Surface - Edit mode - Segments menu

Table of content

Edit Mode - Segments Menu.....	1
Subdivide.....	1
Last Operator Subdivide.....	1
Number of Cuts.....	1
Switch Direction.....	1

Edit Mode - Segments Menu

The Segments menu exists for Curve and Surface object types. They are both curve types, but of different kind.

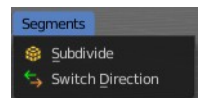

The added objects in edit mode becomes part of the current object geometry.

Subdivide

Subdivides the selected curve geometry, and adds more control points.

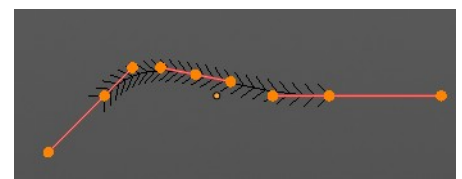
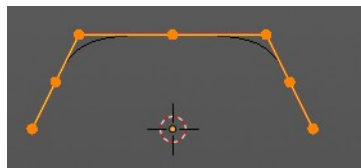

Last Operator Subdivide



Number of Cuts

Number of subdivision cuts.

Switch Direction

Just for Bezier Curve object type. Surface Nurbs curves doesn't have a direction. Switches the direction in which the curve is pointing.

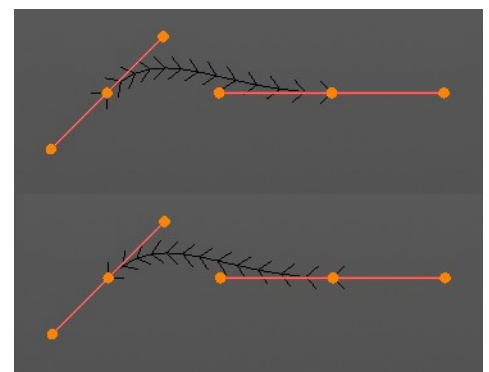



7.1.27 Editors - 3D Viewport - Header - Metaball - Edit mode - Metaball menu

Table of content

Detailed Table of content.....	1
Edit Mode - Metaball Menu.....	4
Transform.....	4
To Sphere.....	4
Shear.....	5
Bend.....	6
Push/Pull.....	6
Warp.....	7
Randomize Transform.....	7
Shrink/Fatten.....	7
Move Texture Space.....	8
Scale Texture Space.....	9
Set Dimensions.....	11
Mirror.....	11
Interactive Mirror.....	11
X Global, Y Global etc.....	11
Snap.....	12
Last Operator Snap.....	12
Operators.....	12
Duplicate.....	12
Show / Hide.....	13
Delete.....	14

Detailed Table of content

Detailed table of content

Detailed Table of content.....	1
Edit Mode - Metaball Menu.....	4
Transform.....	4
To Sphere.....	4
Usage.....	4
Last Operator To Sphere.....	4
Factor.....	4
Proportional editing.....	4
Proportional Falloff.....	4
Proportional Size.....	5
Connected.....	5
Projected(2D).....	5
Shear.....	5
Last Operator Shear.....	5
Offset.....	5
Shear Axis.....	5
Axis.....	5

Axis Ortho.....	5
Orientation.....	5
Proportional editing.....	5
Proportional Falloff.....	6
Proportional Size.....	6
Connected.....	6
Projected(2D).....	6
Bend.....	6
Push/Pull.....	6
Last Operator Push/Pull.....	6
Factor.....	6
Proportional editing.....	6
Proportional Falloff.....	6
Proportional Size.....	6
Connected.....	6
Projected(2D).....	6
Warp.....	7
Last operator Warp.....	7
Warp Angle.....	7
Offset Angle.....	7
Min.....	7
Max.....	7
Randomize Transform.....	7
Last Operator Randomize Transform.....	7
Amount.....	7
Uniform.....	7
Normal.....	7
Random Seed.....	7
Shrink/Fatten.....	7
Last Operator Shrink/Fatten.....	8
Offset.....	8
Offset Even.....	8
Proportional editing.....	8
Proportional Falloff.....	8
Proportional Size.....	8
Connected.....	8
Projected(2D).....	8
Move Texture Space.....	8
Last Operator Translate.....	9
Move X, Y Z.....	9
Orientation.....	9
Proportional editing.....	9
Proportional Falloff.....	9
Proportional Size.....	9
Connected.....	9
Projected(2D).....	9
Scale Texture Space.....	9
Last Operator Resize Texture.....	10
Move X, Y Z.....	10
Orientation.....	10
Proportional editing.....	10
Proportional Falloff.....	10
Proportional Size.....	10

Connected.....	10
Projected(2D).....	10
Set Dimensions.....	11
Last Operator Set Dimensions.....	11
New Dimensions.....	11
Mirror.....	11
Interactive Mirror.....	11
X Global, Y Global etc.....	11
Last Operator Mirror.....	11
Orientation.....	11
Constraint Axis.....	11
Proportional editing.....	12
Proportional Falloff.....	12
Proportional Size.....	12
Connected.....	12
Projected(2D).....	12
Snap.....	12
Last Operator Snap.....	12
Offset.....	12
Operators.....	12
Duplicate.....	12
Last Operator Duplicate.....	13
Move X , Y , Z.....	13
Orientation.....	13
Proportional editing.....	13
Proportional Falloff.....	13
Proportional Size.....	13
Connected.....	13
Projected(2D).....	13
Show / Hide.....	13
Show Hidden.....	13
Hide Selected.....	13
Last Operator Hide Selected.....	13
Unselected.....	13
Hide Unselected.....	13
Delete.....	14

Edit Mode - Metaball Menu

The Metaball menu just exists for Metaball objects.

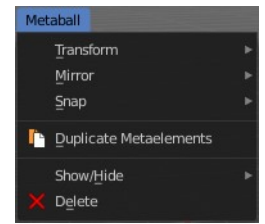

Transform

To Sphere

Shapes a selection of Meta elements into the shape of a sphere. The calculation happens with the object origins.

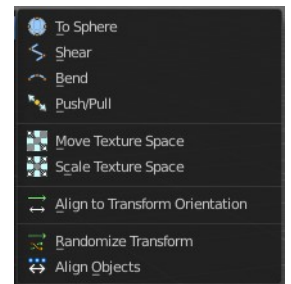

Usage

Select the elements, activate the tool, then drag the mouse in the 3D viewport. In the header you will read the current factor then. Which tells you how close you are towards the sphere shape. This also works with meta elements in the same way.

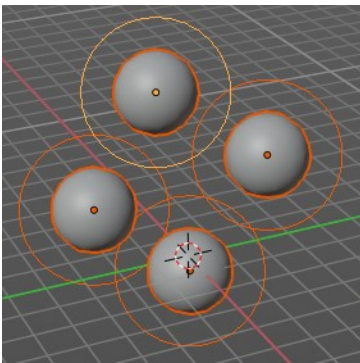
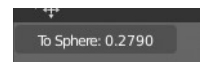

Last Operator To Sphere

Factor

The factor to transform the selection into a sphere form.

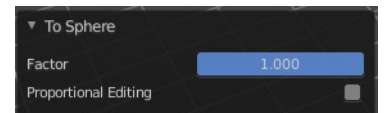

Proportional editing

Enables proportional editing. Activating proportional editing reveals further settings.

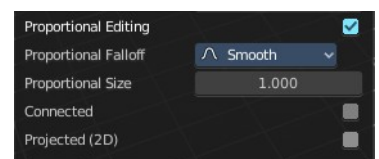

Proportional Falloff

Adjust the falloff methods.

Proportional Size

See and adjust the falloff radius.

Connected

The proportional falloff gets calculated for connected parts only.

Projected(2D)

The proportional falloff gets calculated in the screen space. Depth doesn't play a role. When it's in the radius, then it gets calculated.

Shear

Shear shears the selection. You need more than one meta element.

Last Operator Shear

Offset

Adjust an offset.

Shear Axis

The shear tool works along a imaginary 2d plane. The shear axis controls if the items are sheared along the x or the y axes of this plane. This is the plane along which the transformation happens. You can shear along the x or the y axis of this plane.

To make things even more complicated, the orientation of this imaginary plane is defined by the Axis and Axis Ortho items below.

Axis

Defines one axis of the imaginary shear axis plane.

Axis Ortho

Defines the other axis of the imaginary shear axis plane.

Orientation

Choose the orientation for the shear action.

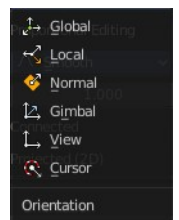
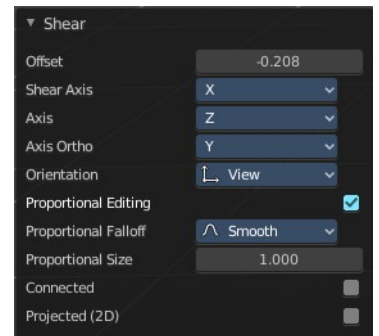

Proportional editing

Enables proportional editing. Activating proportional editing reveals further settings.

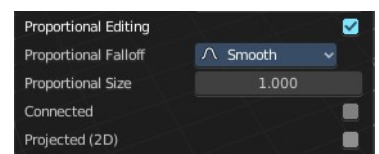

Proportional Falloff

Adjust the falloff methods.

Proportional Size

See and adjust the falloff radius.

Connected

The proportional falloff gets calculated for connected parts only.

Projected(2D)

The proportional falloff gets calculated in the screen space. Depth doesn't play a role. When it's in the radius, then it gets calculated.

Bend

Bends the selection. You need more than one meta element.

Push/Pull

It pushes or pulls the object positions relative to the center of the selection.

You need more than one meta element.

Last Operator Push/Pull

Factor

Adjust the strength of influence of the tool.

Proportional editing

Enables proportional editing. Activating proportional editing reveals further settings.

Proportional Falloff

Adjust the falloff methods.

Proportional Size

See and adjust the falloff radius.

Connected

The proportional falloff gets calculated for connected parts only.

Projected(2D)

The proportional falloff gets calculated in the screen space. Depth doesn't play a role. When it's in the radius, then it gets calculated.

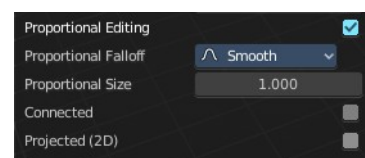
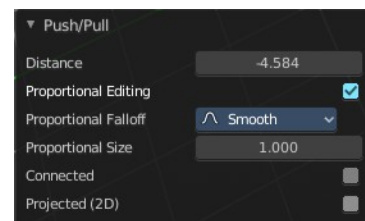

Warp

Warp a selection between two defined points. This also works with Metaballs. You need more than one metaball element.

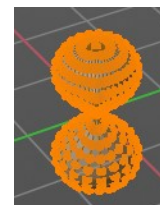

Last operator Warp

Warp Angle

The strength of the warp effect.

Offset Angle

An offset angle to bend side-wards.

Min

The start point.

Max

The end point.



Randomize Transform

This tool allows randomizes the positions of the selected meta elements.

Last Operator Randomize Transform

Amount

Adjust the amount.

Uniform

The uniform offset distance.

Normal

Align the offset direction to the normals.

Random Seed

The seed value for randomization.



Shrink/Fatten

Shrink/Fatten scales the selected geometry along its normals. Transform orientation and Pivot point gets ignored.

A positive value pushes the vertices outwards. A negative value pushes the vertices inwards.

Last Operator Shrink/Fatten

The Last Operator Shrink/Fatten panel gives you tools to adjust the Shrink/Fatten operation. Here you have numeric input for the strength and a few more options.

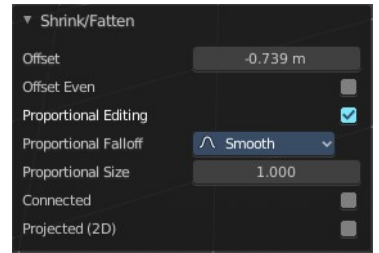

Offset

Offset is the strength of the offset for Shrink/Fatten.

Offset Even

Offset Even scales the selection to give more thickness in even areas.

Proportional editing

Enables proportional editing. Activating proportional editing reveals further settings.

Proportional Falloff

Adjust the falloff methods.

Proportional Size

See and adjust the falloff radius.

Connected

The proportional falloff gets calculated for connected parts only.

Projected(2D)

The proportional falloff gets calculated in the screen space. Depth doesn't play a role. When it's in the radius, then it gets calculated.

Move Texture Space

Move Texture space is meant for mesh objects, but has also functionality with a meta object.

This tool relies at the move tool. With the difference that it moves the texture space instead of the object. It has also a very special use case, and just works with a material with a Texture Coordinate / Generated node. And requires to have the shading at Material or Rendered to see a result in the viewport.

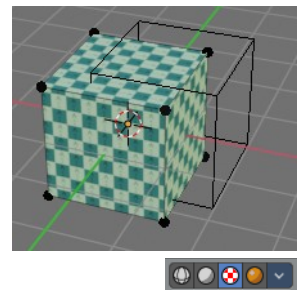

In the viewport you will see the UV cage in black color. In the header you will see the values for the current position of the UV cage.

Dx: -0.1501 m Dy: 0.05851 m Dz: 0.2117 m (0.2661 m)

Note that once done and applied, there is no way to reset the UV cage back to zero. When you repeat the operation, then the values will start at 0 again. Even when the UV cage is already offset.

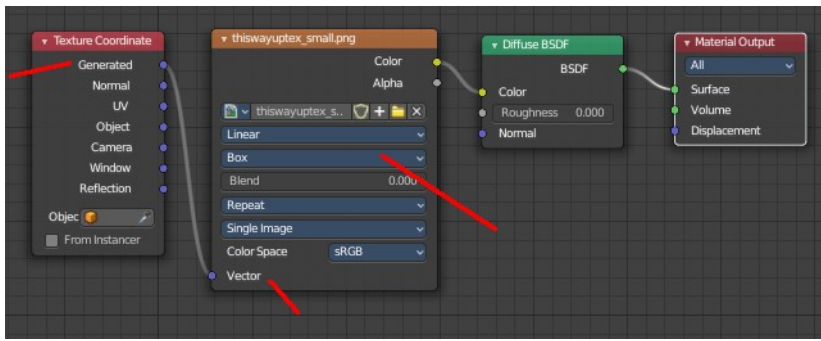

Last Operator Translate

Move X, Y Z

Limit the position relative to the source object.

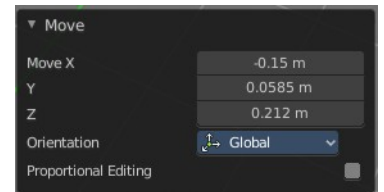

Orientation

Orientation is a drop-down box. Choose the type of orientation for the mirroring action.

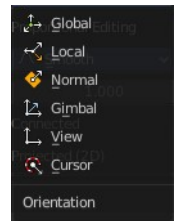

Proportional editing

Enables proportional editing. Activating proportional editing reveals further settings.

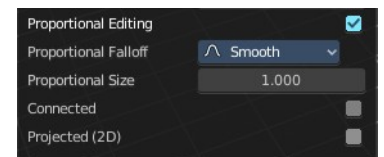

Proportional Falloff

Adjust the falloff methods.

Proportional Size

See and adjust the falloff radius.

Connected

The proportional falloff gets calculated for connected parts only.

Projected(2D)

The proportional falloff gets calculated in the screen space. Depth doesn't play a role. When it's in the radius, then it gets calculated.

Scale Texture Space

Scale Texture space is meant for mesh objects, but has also functionality with a meta object.

This tool relies at the scale tool. With the difference that it scales the texture space instead of the object. It has also a very special use case, and just works with a material

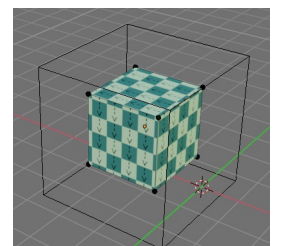

with a Texture Coordinate / Generated node. And requires to have the shading at Material or Rendered to see a result in the viewport.

In the viewport you will see the UV cage in black color. In the header you will see the values for the current position of the UV cage.

Dx: -0.1501 m Dy: 0.05851 m Dz: 0.2117 m (0.2661 m)

Note that once done and applied, there is no way to reset the UV cage back to zero. When you repeat the operation, then the values will start at 0 again. Even when the UV cage is already offset.

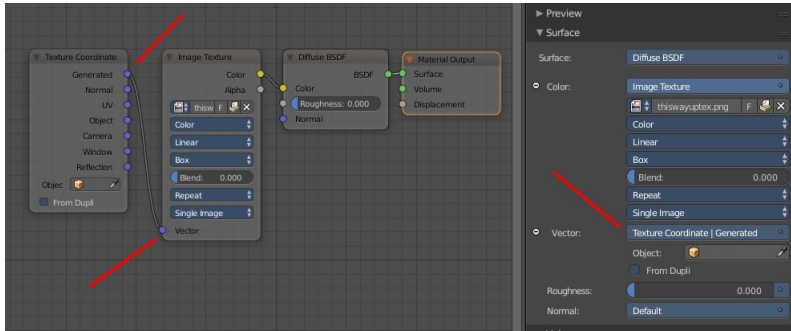

Last Operator Resize Texture

Move X, Y Z

Limit the position relative to the source object.

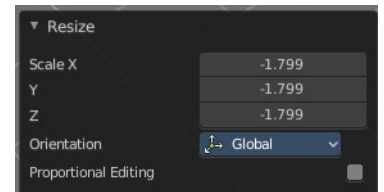

Orientation

Orientation is a drop-down box. Choose the type of orientation for the mirroring action.

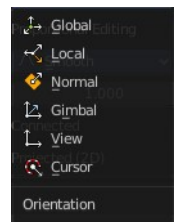

Proportional editing

Enables proportional editing. Activating proportional editing reveals further settings.

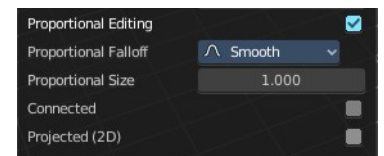

Proportional Falloff

Adjust the falloff methods.

Proportional Size

See and adjust the falloff radius.

Connected

The proportional falloff gets calculated for connected parts only.

Projected(2D)

The proportional falloff gets calculated in the screen space. Depth doesn't play a role. When it's in the radius, then it gets calculated.

Set Dimensions

Edit Mode Only!

Normally all scale operations in Bforartists are relative to the current selection and dimensions. And you always start with a relative value of 1.

Set dimensions allows to scale object selections in absolute world values. No matter how the initial values are. The new values gets set in the Last Operator.

Set dimensions is an add-on. You can turn it off in the add-ons section of the user preferences when you want.

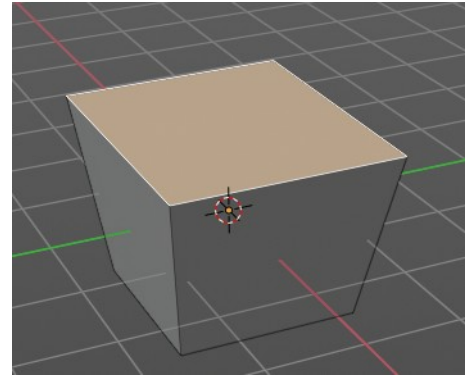

Last Operator Set Dimensions

New Dimensions

When you activate the tool then you will see the world coordinates of the selection. Change the values to other world coordinates.

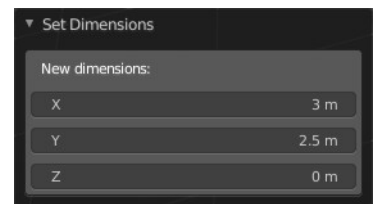

Mirror

Mirror mirrors the selected geometry along the defined axis.

Interactive Mirror

Mirror by hotkeys. You activate the tool, type in x for x global for example, or x x for x local. And the selection gets mirrored



X Global, Y Global etc.

Mirrors the selection around the chosen axis.

Last Operator Mirror

The Last Operator Mirror panel gives you tools to adjust the mirror action.

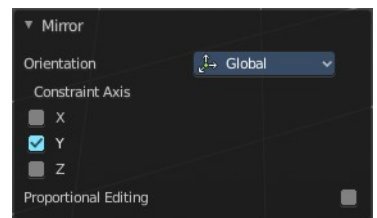

Orientation

Orientation is a drop-down box. Choose the type of orientation for the mirroring action.

Constraint Axis

Constraint Axis gives you again the possibility to define the mirror axis. You can choose more than one axis here.

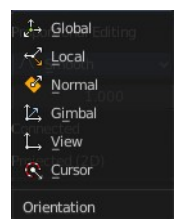

Proportional editing

Enables proportional editing. Activating proportional editing reveals further settings.

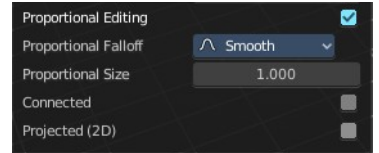

Proportional Falloff

Adjust the falloff methods.

Proportional Size

See and adjust the falloff radius.

Connected

The proportional falloff gets calculated for connected parts only.

Projected(2D)

The proportional falloff gets calculated in the screen space. Depth doesn't play a role. When it's in the radius, then it gets calculated.

Snap

Choose several methods to snap one element to another. The menu items should be self explaining.



Last Operator Snap

Some snap operations shows a last operation panel, some not.

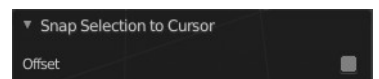

Offset

If the selection should snap as a whole, or if each individual element of the selection should snap.

Operators

Duplicate

Duplicates the current selection.

The copy sticks to the mouse until you release it. A Right click while moving will reset the position of the duplicate. The duplicated part will be part of the same object.

When you drag the duplicate around you will see the position values in the header.

Last Operator Duplicate

Move X , Y , Z

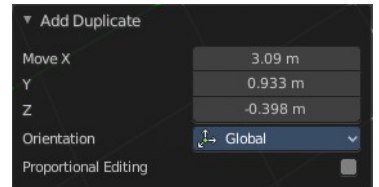

Orientation

Choose the orientation.

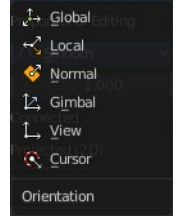

Proportional editing

Enables proportional editing. Activating proportional editing reveals further settings.

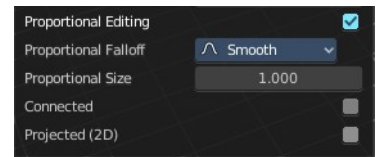

Proportional Falloff

Adjust the falloff methods.

Proportional Size

See and adjust the falloff radius.

Connected

The proportional falloff gets calculated for connected parts only.

Projected(2D)

The proportional falloff gets calculated in the screen space. Depth doesn't play a role. When it's in the radius, then it gets calculated.

Show / Hide

Show Hidden

Makes all geometry in the scene visible again.



Hide Selected

Hides the selected geometry.

Last Operator Hide Selected

Unselected

Hides the not selected geometry.



Hide Unselected

Hides the not selected geometry. The selected geometry stays visible.

Delete

Deletes the current selection.

7.1.29 Editors - 3D View - Header - Text - Edit mode - Text menu

Edit Mode - Text Menu.....	2
Cut.....	2
Copy.....	2
Paste.....	2
Paste File.....	2
To Uppercase.....	2
To Lowercase.....	2
Last Operator Set Case.....	2
Special Characters.....	2
Move Cursor.....	3
Toggle Bold.....	3
Toggle Italic.....	3
Toggle Underline.....	3
Toggle Small Caps.....	3
Kerning.....	3
Decrease Kerning.....	3
Increase Kerning.....	3
Reset Kerning.....	3
Last Operator Change Spacing.....	3
Delta.....	3
Delete.....	3

Edit Mode - Text Menu

Cut

Cuts the selection.

Copy

Copies the selection.

Paste

Pastes a copied selection.

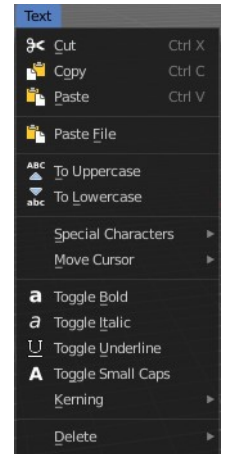

Paste File

Opens the file browser where you can choose a text file to paste the text from. It needs to be UTF8.

To Uppercase

Sets the selected text to be uppercase letters.

To Lowercase

Sets the selected text to be lowercase letters.

Last Operator Set Case

Set Case has one Last Operator for all items.

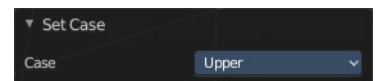

Special Characters

Special characters is a sub menu that contains some special text characters, like copyright, which you can insert into the text.



Move Cursor

Set the cursor at specific positions in the text.

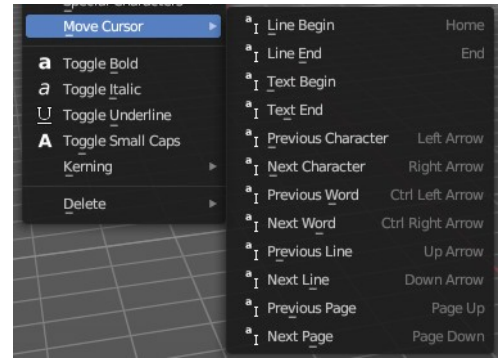

Toggle Bold

Bold sets the selected letters to be displayed as bold letters.

Toggle Italic

Italic sets the selected letters to be displayed as italic letters.

Toggle Underline

Underline sets the selected letters to be displayed as underlined letters.

Toggle Small Caps

Toggle small caps sets the selected letters to be displayed as if they were upper case letters, but with lower case size.

Kerning

Kerning is the distance between letters. Increase, decrease and reset the kerning.



Decrease Kerning

Decreases the distance between the letters.

Increase Kerning

Increases the distance between the letters.

Reset Kerning

Resets the distance between the letters to the default values from the font.

Last Operator Change Spacing

Delta

Adjust the spacing. The range goes from -20 to 20.

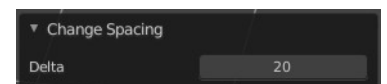

Delete

Deletes the selected text.

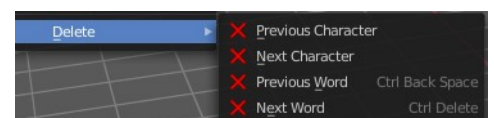



7.1.3 Editors - 3D Viewport - Header - View Menu

Table of content

View Menu.....	3
Toolbar.....	3
Sidebar.....	3
Tool Settings.....	3
Adjust Last Operation.....	3
Tool Shelf Tabs.....	3
Legacy.....	4
Set 3D Cursor.....	4
Annotations (Legacy).....	4
Draw Annotation.....	4
Draw Line Annotation.....	4
Draw Polyline Annotation.....	4
Erase Annotation.....	4
Add Annotation Layer.....	4
Erase Annotation Active Keyframe.....	5
OpenGL Render Animation.....	5
OpenGL Render Image.....	5
Clipping Border.....	5
Render Region.....	5
Clear Render Region.....	6
Cameras sub menu.....	6
Set Active Object as Camera.....	6
Set Active Camera.....	6
Active Camera.....	6
View Camera Center.....	6
Align View.....	7
Align Active Camera to View.....	7
Align Active Camera to Selected.....	7
Center View to Cursor.....	7
View Lock to Active.....	7
View Lock Center.....	7
View Lock Clear.....	7
Perspective/Orthographic.....	8
Top, Bottom, etc.....	8
Align View to Active.....	8
Toggle Local View.....	8
Remove from local View.....	8
Frame Selected.....	8
Frame Selected (Quad View).....	8
Frame All.....	8
Frame All (Quad View).....	9
Center Cursor and Frame All.....	9
Area.....	9
Toggle Quad view.....	9
Horizontal Split.....	9
Vertical Split.....	9
Duplicate Area into New Window.....	9

Toggle Maximize Area.....	9
Toggle Full screen Area.....	10
Close Area.....	10
Pie menus.....	10
Reset 3D View.....	10

View Menu

The View menu contains all View related tools. The range goes from tools to maximize the current window across align view tools up to rendering related tools for the viewport like Render Border.

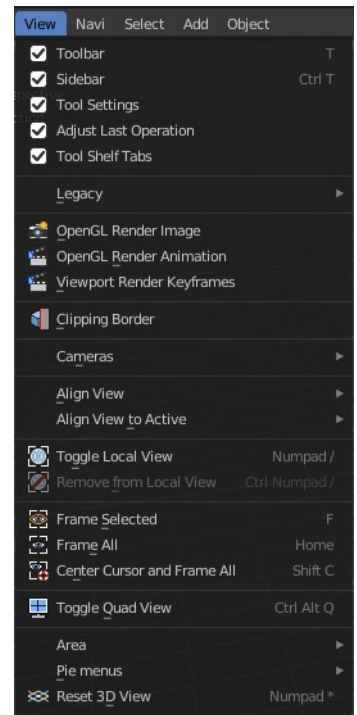

Toolbar

Shows or hides the toolbar at the left in the 3D view.



Sidebar

Shows or hides the sidebar at the right in the 3D view.

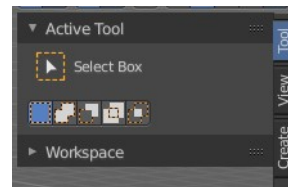

Tool Settings

Shows or hides the tool settings above the header in the 3D view.



Adjust Last Operation

Shows or hides the Adjust Last Operation panel down left in the 3D view.

Note that the Adjust Last Operation panel can also be called from the edit menu at the top. And from the toolbar at the right. Here you can also add a hotkey to call it with a hotkey.

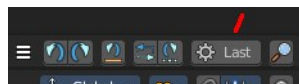
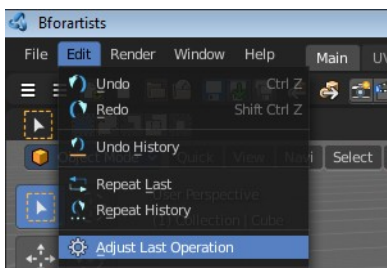
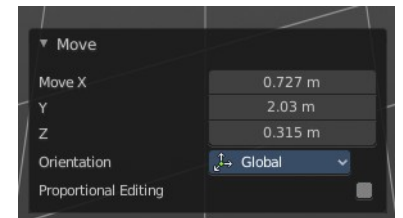

Tool Shelf Tabs

Shows or hides the tool shelf tabs. This tool shelf tabs contains tools from the header menus, and are a double menu entry by design. Here you can turn them off if you don't want to work

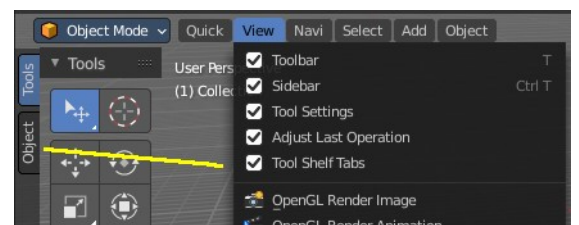

with this tool set.

Note that you need to adjust the width of the tool shelf manually afterwards since it does not automatically update the width of the tool shelf area.

Note that you need to save the startup.blend to save the state of this checkbox.

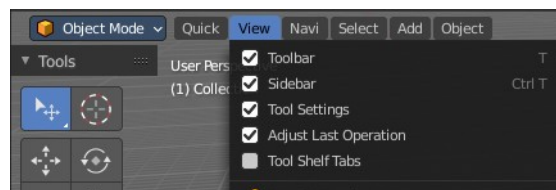

Legacy



Set 3D Cursor

The old legacy operator to set the position of the 3D cursor in the viewport. This method is especially with rigging the much faster method. So we keep this operator. It is up to you if you want to work with the old operator or with the tool in the tool shelf.

Hotkey only tool. The menu entry just exists to show that this operator exists!

Annotations (Legacy)

This group of operators is useful to take notes without changing tool-shelf operators. These notes can be colored in the View tab of the Property Shelf. Each layer is a single color. You can also animate the notes with keyframes, editable in the dopesheet. d

Note: *These are legacy operators, meaning they are equally available in the Toolshelf as a modal operator.*

Draw Annotation

Starts the annotation free hand draw tool in the editor.

Draw Line Annotation

Starts the annotation line draw tool to draw straight lines in the editor.

Draw Polyline Annotation

Starts the annotation Polyline draw tool in the editor which allows to draw multiple connected straight lines in the editor.

Erase Annotation

Starts the annotation erase tool in the editor which erases any strokes in the editor.

Add Annotation Layer

Starts a new annotation layer.

Erase Annotation Active Keyframe

Erases the active keyframe of the annotation.

OpenGL Render Animation

Renders an animation, using the Viewport OpenGL renderer. This can be useful for preview renderings.

Note

Note that this menu item is a double menu entry. The same menu item exists in the Render menu in the Info Header. But this is required when you work with more than one 3D view. When you use the entry in the Render menu, then it picks an arbitrary 3D view. When you use the menu entry in the 3D view, then it renders from this 3D view.

OpenGL Render Image

Renders an Image, using the Viewport OpenGL renderer. This can be useful for preview renderings.

Note

Note that this menu item is a double menu entry. The same menu item exists in the Render menu in the Info Header. But this is required when you work with more than one 3D view. When you use the entry in the Render menu, then it picks an arbitrary 3D view. When you use the menu entry in the 3D view, then it renders from this 3D view.

Clipping Border

With clipping you can draw a rectangle that excludes the display of everything outside of this rectangle. That way you can look inside the geometry when you rotate the viewport. To clear the clipping use the tool again. It is a toggle.

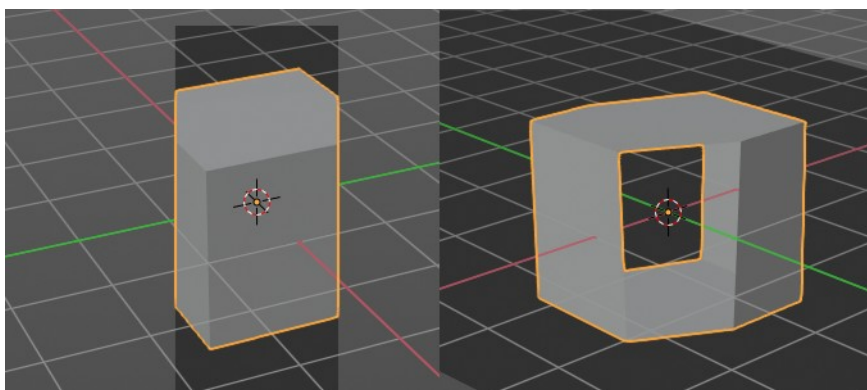

Render Region

Cycles only!

With the Render Region tool you can drag a rectangle at the viewport to define a portion of the screen to render.

The benefit here is to have much faster preview renderings. You just render what you want to judge, and not the whole image.

It has two use cases. The one is with the rendering through the camera. Just what is marked gets rendered. The other is directly in the viewport, with the Viewport shading method Rendered. Render border works with all renderers.

You can have both render border cases active at the same time. When you remove it then just the render border from the current case gets deleted. Either you are in camera view, or you are in viewport view.

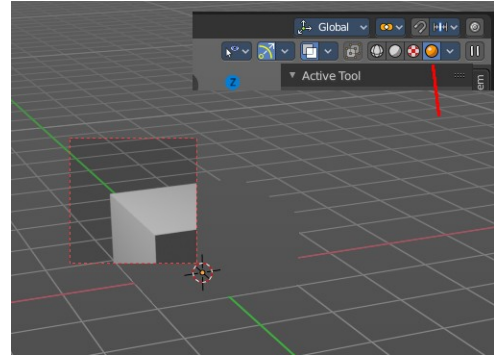
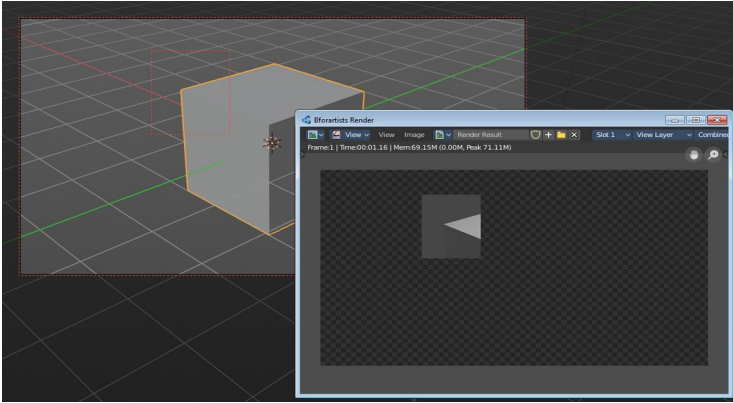

Clear Render Region

Removes the Render Region rectangle from the viewport.

Cameras sub menu

Set Active Object as Camera

With this tool you can set any object to be the active camera where you render from.

Set Active Camera

Set the current camera as the active camera.

Active Camera

Switches to Camera view and back to Viewport Camera.

View Camera Center

This tool is of use when you are in camera view. Else it is greyed out and inactive. There is a Grey passepartout around the camera view. It can be that this passepartout does not fit into the viewport. It can be too big or too small. And so you might want to zoom out or in.

Normally when you are in camera view, then you zoom in or out the view with the zoom tool. Not this passepartout. But with lock camera off you can zoom the

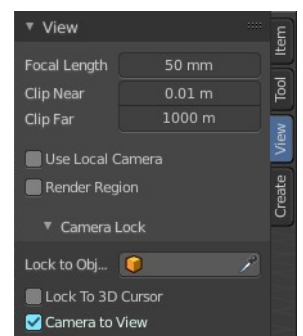

passthrough to reach geometry that is not in the camera view.

The other way is View Camera Center. It fits the camera view into the viewport.

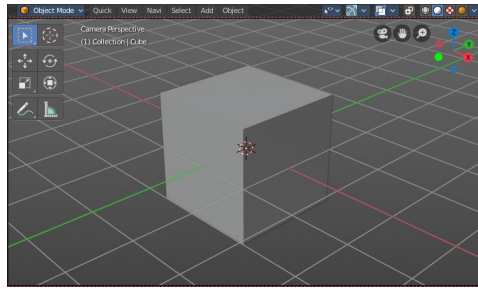
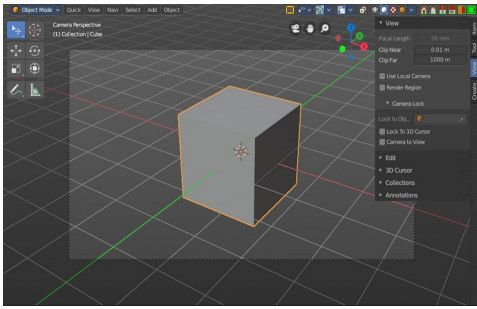

Align View

Align View is a menu where you can choose between different view align methods. The view gets aligned at the world coordinates. Here we also find a few more align methods.

Align Active Camera to View

Aligns the active camera to the current view. This means you can navigate with the viewport camera, select the render camera, and align it with this tool, so that the render camera has the same position and angle than the viewport camera.

Align Active Camera to Selected

Aligns the active camera to the current selected object. This means you can navigate with the viewport camera, select the render camera, and align it with this tool, so that the render camera has the same position and angle than the selected object.

Center View to Cursor

Centers the view at the 3D cursor position.

View Lock to Active

Locks the view to the currently active object.

View Lock Center

Centers the view to the currently active and locked object. This tool is just active when you have performed a View Lock to Active before.

View Lock Clear

Removes the View Lock to Active from the object.

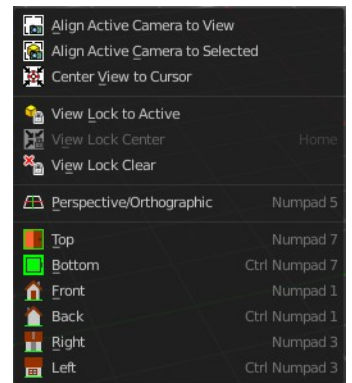

Perspective/Orthographic

Toggles between perspective and orthographic view in the 3D viewport. Perspective view acts like a real camera with the perspective distortions. Orthographic view acts like a mathematical display of an object, without distortions.

Top, Bottom, etc.

Switches to Top view, Bottom View, etc.

Align View to Active

Align View to Active is a menu where you can choose between different view align methods. The view gets aligned relative to the rotation of the currently active object. Not in World coordinates. The menu items should be self explaining. So we won't list them one by one.

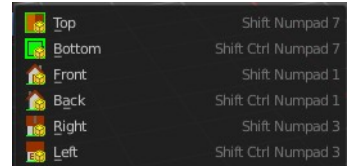

Toggle Local View

Toggle Local View zooms in or out until the Selection is displayed fitting in the viewport. And hides all other objects but the Selection.

Remove from local View

It can be that you select more than one object, and switch to local view. Then you decide that one of the objects is in the way. With remove from local view you can remove this object without to leave the local view.

This menu item is greyed out when you are not in local view.

Frame Selected

Zooms in or out in the 3d viewport until the Selection is displayed fitting in the viewport.

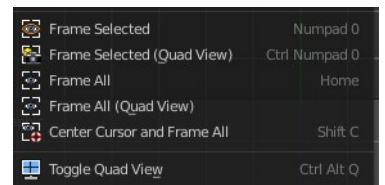

Frame Selected (Quad View)

Just with Quad view. Zooms in or out in the 3d viewport until the Selection is displayed fitting in the viewport of all four views.

Frame All

Zooms in or out in the 3d viewport until all objects in the scene are displayed fitting in the viewport.

Frame All (Quad View)

Just with Quad view. Zooms in or out in the 3d viewport until all objects in the scene are displayed fitting in the

viewport of all four views.

Center Cursor and Frame All

Center Cursor and View all centers the 3D Cursor at 0/0/0, and zooms in or out in the 3d viewport until all objects in the scene are displayed fitting in the viewport.

Area

This menu contains general view functionality. And exists in most other editor types too.

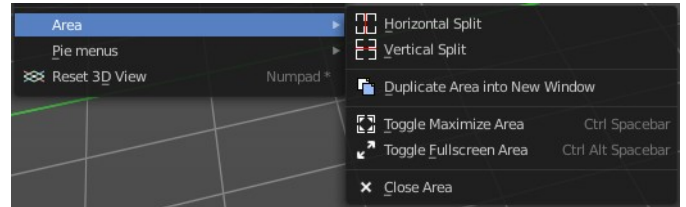

Toggle Quad view

Displays the 3D View divided into four split screen parts. Note that the orthographic views cannot be switched in this mode. They remain orthographic, you cannot rotate them.

To return to single view reuse the menu item in the View menu.

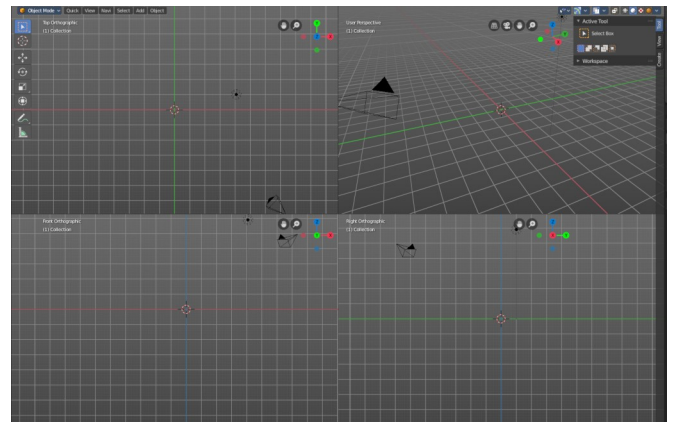

Horizontal Split

Splits the current view horizontally into two independent editor windows.

Vertical Split

Splits the current view vertically into two independent editor windows.

Duplicate Area into New Window

Duplicate Area into New Window makes the selected editor window floating. You can then drag it around at the monitor. It is not connected with the rest of the UI anymore.

A separated window cannot be merged into the main window again. You have to close it when not longer needed.

Toggle Maximize Area

Displays the editor maximized with menus.

To return from the maximized view press hotkey ctrl + space bar. Or reuse the menu item in the area menu.

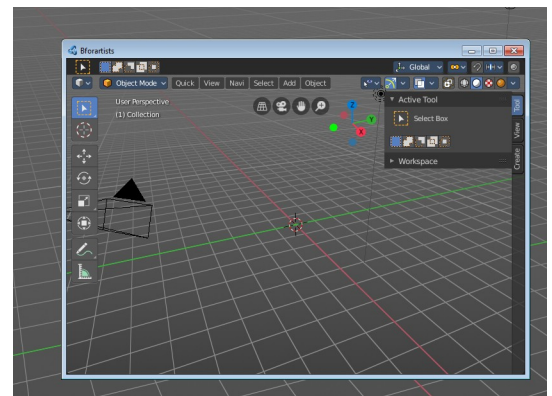

Toggle Full screen Area

Displays the editor maximized without menus.

To return from the full screen view press hotkey ctrl + alt + space bar.

Close Area

Closes the area window.

Pie menus

Lists the available pie menus, and gives you the ability to read the hotkeys and assign own hotkeys.

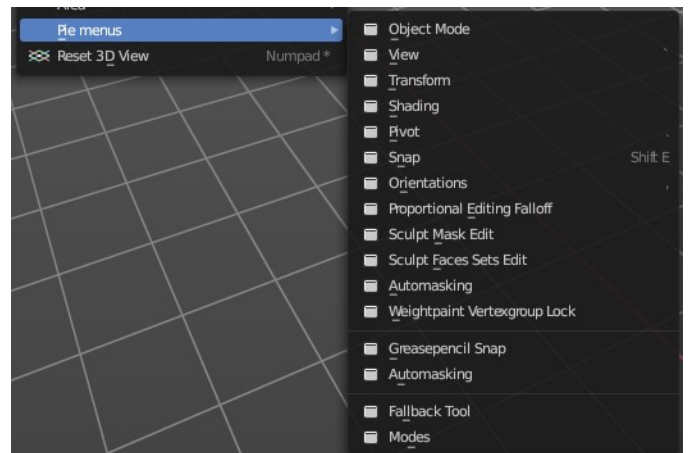

Reset 3D View

Resets the 3D view to the defaults.

Note that this is an add-on, and can be turned off in the addons section of the preferences.

7.1.30 Editors - 3D Viewport - Header - Grease Pencil - Edit mode - Grease Pencil menu

Table of content

Detailed table of content.....	1
Edit Mode - Grease Pencil Menu.....	5
Transform.....	5
Bend.....	5
Shear.....	5
To Sphere.....	6
Shrink/Fatten.....	7
Mirror.....	8
Interactive Mirror.....	8
X Global, Y Global etc.....	8
Snap.....	9
Last Operator Snap.....	9
Animation.....	9
Insert Blank Key frame (Active Layer).....	9
Insert Blank Key frame (All Layers).....	9
Last Operator Insert Blank Frame.....	9
Duplicate Active Key frame (Active Layer).....	10
Duplicate Active Key frame (All Layers).....	10
Last Operator Insert Blank Frame.....	10
Delete Active Key frame (Active Layer).....	10
Delete Active Key frame (All Layers).....	10
Single Operators.....	10
Interpolate Sequence.....	10
Duplicate.....	10
Duplicate Active Frame.....	11
Duplicate Active Frame All Layers.....	11
Split.....	12
Copy.....	12
Paste.....	12
Paste by Layer.....	12
Delete.....	12
Dissolve.....	13
Cleanup.....	13
Show / Hide.....	15
Separate.....	15

Detailed table of content

Detailed table of content

Detailed table of content.....	1
Edit Mode - Grease Pencil Menu.....	5
Transform.....	5
Bend.....	5
Shear.....	5

Last Operator Shear.....	5
Offset.....	5
Shear Axis.....	5
Axis.....	6
Axis Ortho.....	6
Orientation.....	6
Proportional editing.....	6
Proportional Falloff.....	6
Proportional Size.....	6
Connected.....	6
Projected(2D).....	6
To Sphere.....	6
Usage.....	6
Last Operator To Sphere Panel.....	7
Factor.....	7
Proportional editing.....	7
Proportional Falloff.....	7
Proportional Size.....	7
Connected.....	7
Projected(2D).....	7
Shrink/Fatten.....	7
Last Operator Shrink/Fatten.....	7
Offset.....	7
Offset Even.....	7
Proportional editing.....	7
Proportional Falloff.....	8
Proportional Size.....	8
Connected.....	8
Projected(2D).....	8
Mirror.....	8
Interactive Mirror.....	8
X Global, Y Global etc.....	8
Last Operator Mirror.....	8
Orientation.....	8
Constraint Axis.....	8
Proportional editing.....	8
Proportional Falloff.....	9
Proportional Size.....	9
Connected.....	9
Projected(2D).....	9
Snap.....	9
Last Operator Snap.....	9
Offset.....	9
Animation.....	9
Insert Blank Key frame (Active Layer).....	9
Insert Blank Key frame (All Layers).....	9
Last Operator Insert Blank Frame.....	9
All Layers.....	9
Duplicate Active Key frame (Active Layer).....	10
Duplicate Active Key frame (All Layers).....	10
Last Operator Insert Blank Frame.....	10
Mode.....	10
Delete Active Key frame (Active Layer).....	10

Delete Active Key frame (All Layers).....	10
Single Operators.....	10
Interpolate Sequence.....	10
Duplicate.....	10
Last Operator Duplicate.....	11
Mode.....	11
Move X, Y, Z.....	11
Orientation.....	11
Constraint Axis.....	11
Proportional editing.....	11
Proportional Falloff.....	11
Proportional Size.....	11
Connected.....	11
Projected(2D).....	11
Duplicate Active Frame.....	11
Duplicate Active Frame All Layers.....	11
Last Operator Duplicate Frame.....	12
Mode.....	12
Split.....	12
Copy.....	12
Paste.....	12
Paste by Layer.....	12
Last operator Paste Strokes.....	12
Type.....	12
Delete.....	12
Points.....	12
Strokes.....	12
Frame.....	12
Last Operator Delete.....	13
Type.....	13
Delete Active Key frame(Active Layer).....	13
Delete Active Key frame(All Layers).....	13
Dissolve.....	13
Dissolve.....	13
Dissolve Between.....	13
Dissolve Unselect.....	13
Last Operator Dissolve.....	13
Type.....	13
Cleanup.....	13
Boundary Strokes.....	13
Boundary Strokes all Frames.....	14
Last Operator Clean Fill Boundaries.....	14
Mode.....	14
Delete Loose Points.....	14
Last Operator Clean Loose Points.....	14
Limit.....	14
Merge by Distance.....	14
Last Operator Clean Loose Points.....	14
Threshold.....	14
Unselected.....	14
Delete Duplicated Frames.....	14
Last Operator Clean Duplicated Frames.....	14
Type.....	14

Recalculate Geometry.....	14
Re project Strokes.....	15
Re project Strokes menu.....	15
Last Operator Re project Strokes.....	15
Projection Type.....	15
Show / Hide.....	15
Show Hidden Layer.....	15
Hide Selected Layer.....	15
Last Operator Hide Layers.....	15
Unselected.....	15
Hide Unselected.....	15
Toggle Opacity.....	15
Separate.....	15
Selected Points.....	15
Selected Strokes.....	16
Active Layer.....	16
Last Operator Separate Strokes.....	16
Mode.....	16
Active Layer.....	16
Selected Strokes.....	16
Selected Points.....	16

Edit Mode - Grease Pencil Menu

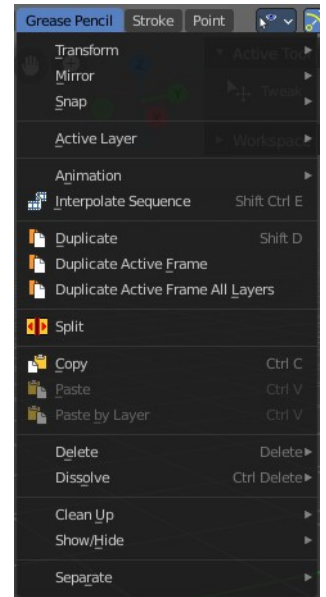

Transform

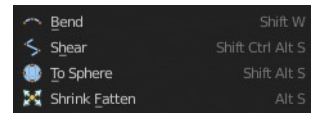

Bend

Bends the selection.

Shear

Shear shears the selection.

Last Operator Shear

Offset

Adjust an offset.

Shear Axis

The shear tool works along a imaginary 2d plane. The shear axis controls if the items are sheared along the x or the y axes of this plane. This is the plane along which the transformation happens. You can shear along the x or the y axis of this plane.

To make things even more complicated, the orientation of this imaginary plane is defined by the Axis and Axis

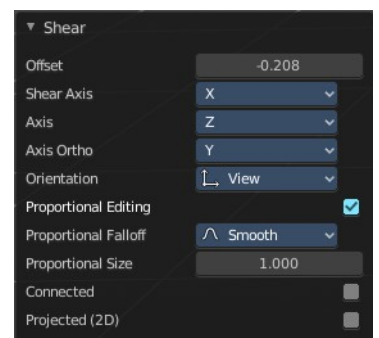

Ortho items below.

Axis

Defines one axis of the imaginary shear axis plane.

Axis Ortho

Defines the other axis of the imaginary shear axis plane.

Orientation

Choose the orientation for the shear action.

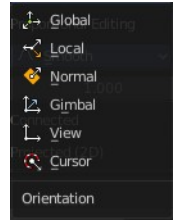

Proportional editing

Enables proportional editing. Activating proportional editing reveals further settings.

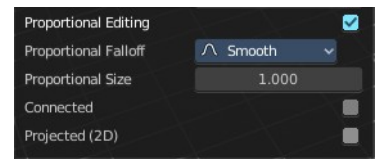

Proportional Falloff

Adjust the falloff methods.

Proportional Size

See and adjust the falloff radius.

Connected

The proportional falloff gets calculated for connected parts only.

Projected(2D)

The proportional falloff gets calculated in the screen space. Depth doesn't play a role. When it's in the radius, then it gets calculated.

To Sphere

Shapes a selection of objects into the shape of a sphere. The calculation happens with the object origins.

Usage

Select the vertices, activate the tool, then drag the mouse in the 3D viewport. In the header you will read the current factor then. Which tells you how close you are towards the sphere shape.

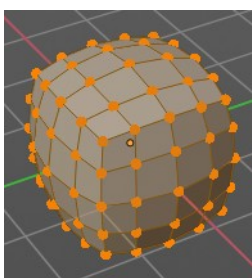
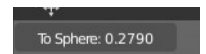

Last Operator To Sphere Panel

Factor

The factor to transform the selection into a shape form.

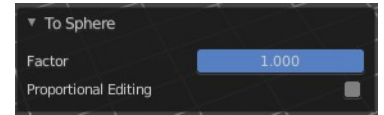

Proportional editing

Enables proportional editing. Activating proportional editing reveals further settings.

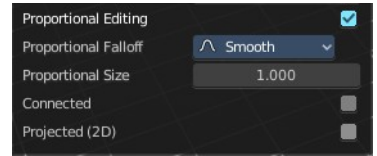

Proportional Falloff

Adjust the falloff methods.

Proportional Size

See and adjust the falloff radius.

Connected

The proportional falloff gets calculated for connected parts only.

Projected(2D)

The proportional falloff gets calculated in the screen space. Depth doesn't play a role. When it's in the radius, then it gets calculated.

Shrink/Fatten

Shrink/Fatten scales the selected geometry along its normals. Transform orientation and Pivot point gets ignored.

A positive value pushes the vertices outwards. A negative value pushes the vertices inwards.

Last Operator Shrink/Fatten

The Last Operator Shrink/Fatten panel gives you tools to adjust the Shrink/Fatten operation. Here you have numeric input for the strength and a few more options.

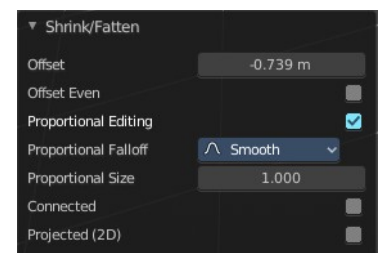

Offset

Offset is the strength of the offset for Shrink/Fatten.

Offset Even

Offset Even scales the selection to give more thickness in even areas.

Proportional editing

Enables proportional editing. Activating proportional editing reveals further settings.

Proportional Falloff

Adjust the falloff methods.

Proportional Size

See and adjust the falloff radius.

Connected

The proportional falloff gets calculated for connected parts only.

Projected(2D)

The proportional falloff gets calculated in the screen space. Depth doesn't play a role. When it's in the radius, then it gets calculated.

Mirror

Mirror mirrors the selected geometry along the defined axis.

Interactive Mirror

Mirror by hotkeys. You activate the tool, type in x for x global for example, or x x for x local. And the selection gets mirrored.



X Global, Y Global etc.

Mirrors the selection around the chosen axis.

Last Operator Mirror

The Last Operator Mirror panel gives you tools to adjust the mirror action.

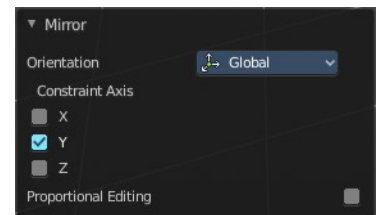

Orientation

Orientation is a drop-down box. Choose the type of orientation for the mirroring action.

Constraint Axis

Constraint Axis gives you again the possibility to define the mirror axis. You can choose more than one axis here.

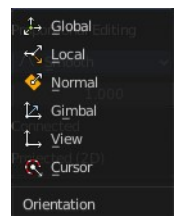

Proportional editing

Enables proportional editing. Activating proportional editing reveals further settings.

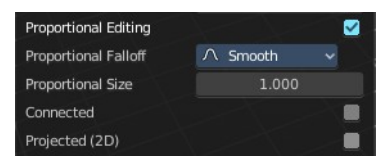

Proportional Falloff

Adjust the falloff methods.

Proportional Size

See and adjust the falloff radius.

Connected

The proportional falloff gets calculated for connected parts only.

Projected(2D)

The proportional falloff gets calculated in the screen space. Depth doesn't play a role. When it's in the radius, then it gets calculated.

Snap

Choose several methods to snap one element to another. The menu items should be self explaining.

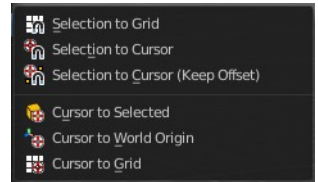

Last Operator Snap

Some snap operations shows a last operation panel, some not.

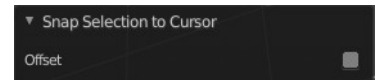

Offset

If the selection should snap as a whole, or if each individual element of the selection should snap.

Animation

Insert Blank Key frame (Active Layer)

Inserts a key frame into the active layer.



Insert Blank Key frame (All Layers)

Inserts a key frame into all layers.

Last Operator Insert Blank Frame

Some snap operations shows a last operation panel, some not.

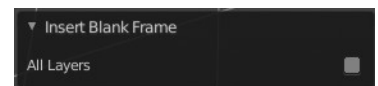

All Layers

Insert into active layer or into all layers.

Duplicate Active Key frame (Active Layer)

Duplicates the active key frame in the active layer.

Duplicate Active Key frame (All Layers)

Duplicates the active key frame in all layers.

Last Operator Insert Blank Frame

Some snap operations shows a last operation panel, some not.

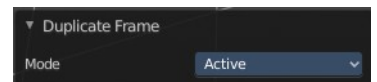

Mode

Duplicate the active key frame in the active layer or in all layers.

Delete Active Key frame (Active Layer)

Deletes the active key frame in the active layer.

Delete Active Key frame (All Layers)

Deletes the active key frame in all layers

Single Operators

Interpolate Sequence

Interpolate strokes between the previous and next keyframe by adding multiple keyframes. When you are on a frame between two keyframes and click the sequence button, then a breakdown keyframe will be added on every frame between the previous and next keyframe.

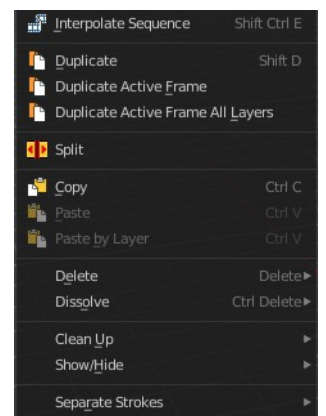

Duplicate

Duplicates the current selection.

When you duplicate a selection, then it sticks to the mouse until you left click. And moves around. A right click repositions the duplicated geometry at its original location.

Last Operator Duplicate

Mode

Not to find out. No tool tip, no entry in the Blender manual. Good Job Blender Developers.

Move X, Y, Z

Adjust the position.

Orientation

Orientation is a drop-down box. Choose the type of orientation for the mirroring action.

Constraint Axis

Constraint Axis gives you again the possibility to define the mirror axis. You can choose more than one axis here.

Proportional editing

Enables proportional editing. Activating proportional editing reveals further settings.

Proportional Falloff

Adjust the falloff methods.

Proportional Size

See and adjust the falloff radius.

Connected

The proportional falloff gets calculated for connected parts only.

Projected(2D)

The proportional falloff gets calculated in the screen space. Depth doesn't play a role. When it's in the radius, then it gets calculated.

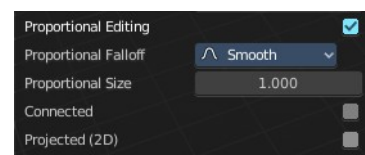
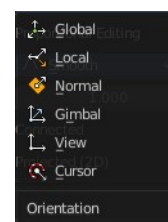
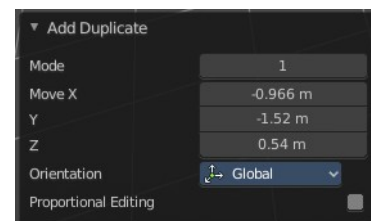

Duplicate Active Frame

Duplicates the active frame in the active layer.

Duplicate Active Frame All Layers

Duplicates the active frame in all layers.

Last Operator Duplicate Frame

Mode

Choose between Duplicate Active Frame and Duplicate Active Frame All Layers.

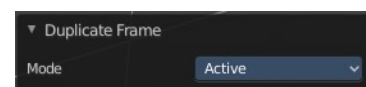

Split

Splits the selection.

Copy

Copies the selection.

Paste

Pastes a copied selection to active layer. You can have more than one layer.

Paste by Layer

Pastes a copied selection to same, original layer. You can have more than one layer.

Last operator Paste Strokes

Type

Choose between the paste methods again.

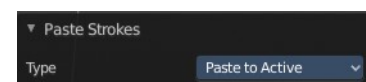

Delete

Points

Delete selected stroke points.

Strokes

Delete the stroke where the current selection belongs to.

Frame

Delete the grease pencil frame where the current selection belongs to.

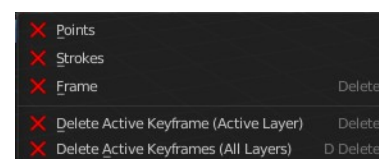

Last Operator Delete

Type

Choose what you want to delete.

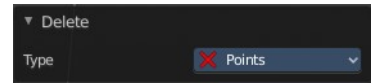

Delete Active Key frame(Active Layer)

Deletes the active key frame in the current active layer.

Delete Active Key frame(All Layers)

Deletes the active key frame in all layers.

Dissolve

Dissolve is a union operation. Two edges becomes one edge by removing the vertice in between.

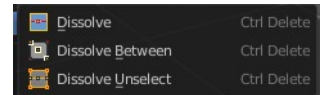

Dissolve

Dissolves the selection.

Dissolve Between

Dissolves the vertices between the selected vertices.

Dissolve Unselect

Dissolves the vertices that are not selected.

Last Operator Dissolve

Type

Choose how you want to dissolve.

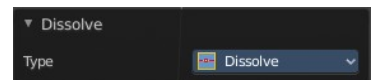

Cleanup

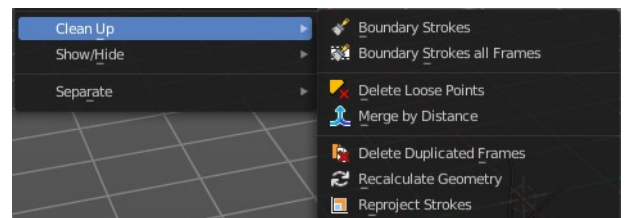

Boundary Strokes

Removes boundary "No Fill" strokes in the current active frame.

Boundary Strokes all Frames

Removes boundary "No Fill" strokes in the all frames.

Last Operator Clean Fill Boundaries

Mode

Current active frame or all frames.

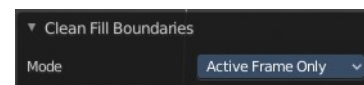

Delete Loose Points

Deletes not connected stroke geometry that is made of loose points.

Last Operator Clean Loose Points

Limit

The number of vertices below which a stroke gets counted as a loose point.

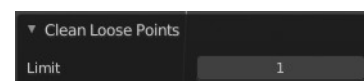

Merge by Distance

Merges vertices that are close to each other.

Last Operator Clean Loose Points

Threshold

The distance.

Unselected

Merge also unselected geometry.

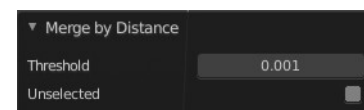

Delete Duplicated Frames

Deletes all duplicated frames.

Last Operator Clean Duplicated Frames

Type

Delete just in the selected frames or in all frames.

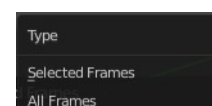
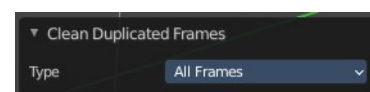

Recalculate Geometry

Update all internal geometry data.

Re project Strokes

Re project the selected strokes onto a new plane from the current viewport. So that all strokes are on one plane.

Re project Strokes menu

Using this tool opens a popup menu. Choose the projection type method.

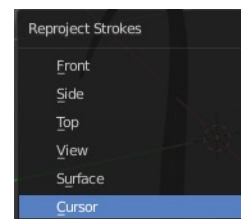

Last Operator Re project Strokes

Projection Type

A popup menu. Choose the projection type method.

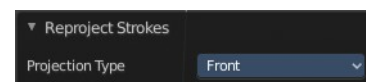

Show / Hide

Show Hidden Layer

Makes all layers in the scene visible again.



Hide Selected Layer

Hides the selected layer.

Last Operator Hide Layers

Unselected

Hides the not selected layers.



Hide Unselected

Hides the not selected layers. The selected layers stays visible.

Toggle Opacity

Toggles the opacity of the stroke. With opaque stroke the vertices are hidden behind the stroke, and can't be seen.

Separate

Separates the selection into a new grease pencil object.

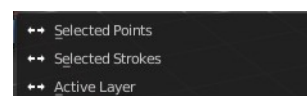

Selected Points

Separate the selected points with its edges.

Selected Strokes

Separate the whole stroke of the current selection.

Active Layer

Separate all the strokes at the current active layer.

Last Operator Separate Strokes

Mode

Active Layer

Separate all the strokes at the current active layer.

Selected Strokes

Separate the whole stroke of the current selection.

Selected Points

Separate the selected points with its edges.

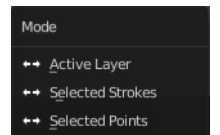

7.1.31 Editors - 3D Viewport - Header - Grease Pencil - Edit mode - Stroke menu

Table of content

Edit Mode - Stroke Menu.....	2
Subdivide.....	2
Last Operator Subdivide.....	3
Number of Cuts.....	3
Smooth.....	3
Repeat.....	3
Selected Points.....	3
Position.....	3
Thickness.....	3
Strength.....	3
UV.....	3
Simplify.....	3
Fixed.....	3
Last Operator Simplify Fixed Stroke.....	3
Steps.....	3
Adaptive.....	3
Last Operator Simplify Stroke.....	4
Factor.....	4
Sample.....	4
Last Operator Sample Stroke.....	4
Factor.....	4
Trim.....	4
Join.....	4
Join and copy.....	4
Last Operator Join Strokes.....	4
Type.....	4
Leave Gaps.....	4
Move to Layer.....	5
New Layer.....	5
Last Operator Move Strokes to Layer.....	5
Grease Pencil Layer.....	5
Assign Material.....	5
Last Operator Change Stroke Color.....	6
Material.....	6
Set as active material.....	6
Arrange.....	6
Bring Forward.....	6
Send Backward.....	6
Bring to Front.....	6
Send to Back.....	6
Last Operator Arrange Stroke.....	6
Direction.....	6
Close.....	6
Toggle Cyclic.....	6
Last Operator Set Cyclical State.....	7

Type.....	7
Close all.....	7
Open all.....	7
Toggle.....	7
Create geometry.....	7
Toggle Caps.....	7
Default.....	7
Both.....	7
Start.....	7
End.....	7
Last Operator Set Caps Mode.....	7
Type.....	7
Switch Direction.....	8
Set Start Point.....	8
Re project Strokes.....	8
Last Operator Re project Strokes.....	8
Projection Type.....	8
Normalize Thickness.....	8
Normalize Opacity.....	8
Last operator Normalize Stroke.....	8
Mode.....	8
Value.....	8
Reset Fill Transform.....	9
Outline.....	9
Last operator Convert Stroke to Outline.....	9
View.....	9
Material Mode.....	9
Thickness.....	9
Keep Shape.....	9
Subdivisions.....	10
Sample Length.....	10

Edit Mode - Stroke Menu

In Edit Mode you will also see a add menu for some object types. The number of objects that you can add is limited to the same object type that you are in edit mode with. You can just add mesh geometry to a mesh geometry. And just curve geometry to curve geometry.

The added objects in edit mode becomes part of the current object geometry.

Subdivide

Subdivides the selected grease pencil geometry.

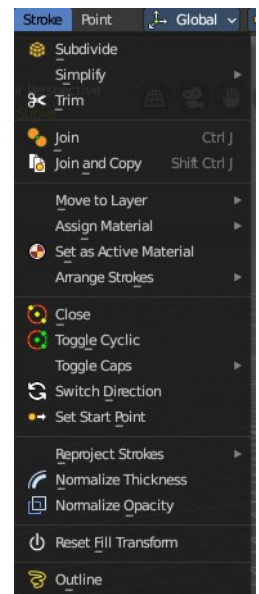

Last Operator Subdivide

Number of Cuts

Number of subdivision cuts.

Smooth

Smoothen the stroke, not just the new added vertices

Repeat

The number of times to repeat the procedure.

Selected Points

Limits the effect to only the selected points within the stroke.

Position

The operator affects the points location.

Thickness

The operator affect the points thickness.

Strength

The operator affect the points strength (alpha).

UV

The operator affect the UV rotation on the points.

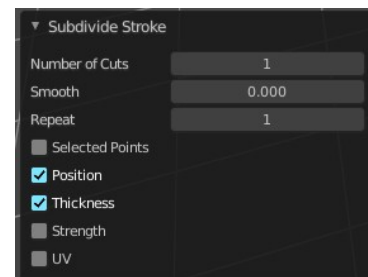

Simplify

Simplifies the stroke.

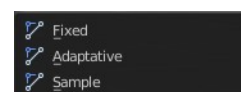

Fixed

Deletes every second point in the stroke, except the start and end points.

Last Operator Simplify Fixed Stroke

Steps

How much levels of simplifying.

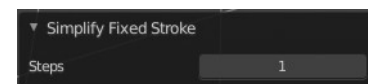

Adaptive

This method uses an algorithm called RDP algorithm (Ramer-Douglas-Peucker algorithm) for points deletion. The algorithm tries to keep the shape with the remaining points.

Last Operator Simplify Stroke

Factor

How strong the simplification should be performed.

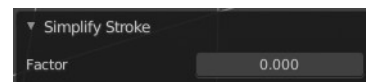

Sample

Samples points along the shape of the stroke, and increases the length of the edges.

Last Operator Sample Stroke

Factor

How long the edges between the points should be.

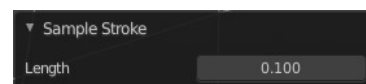

Trim

Trims down selected stroke geometry to first loop or intersection.

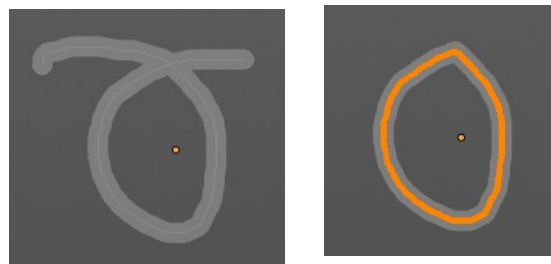

Join

Join selected strokes by connecting points.

Join and copy

Join selected strokes by connecting points in a new stroke.

Last Operator Join Strokes

Type

Join or Join and Copy.

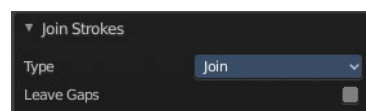

Leave Gaps

Don't connect the strokes by geometry.

Move to Layer

Move the current selected stroke to another grease pencil layer. It lists the current layers.

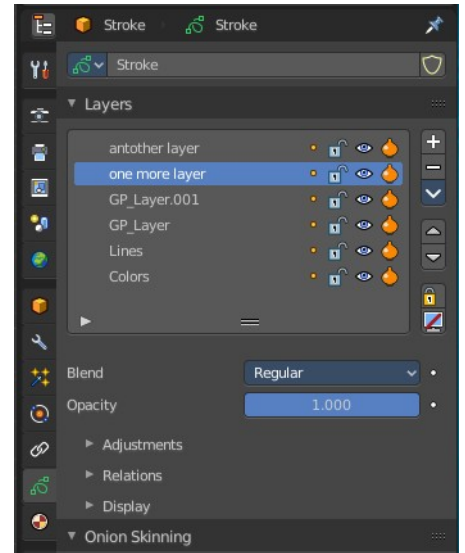
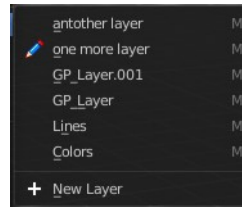

New Layer

New Layer button adds a new grease pencil layer.

Last Operator Move Strokes to Layer

Grease Pencil Layer

Internal the layers are enumerated. So here you move by number.

The number of a layer can be found out in the tool tip, in the Python part of it.

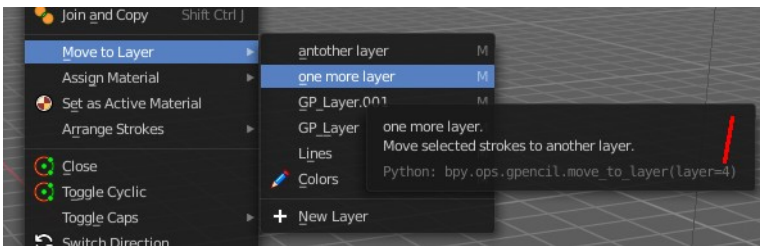
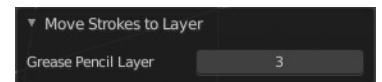

Assign Material

Assign a new material to the current selected stroke geometry.

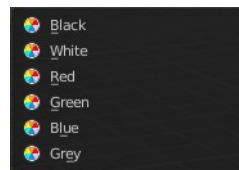

The materials can be found and edited in the Properties editor. Here you can also create new materials.

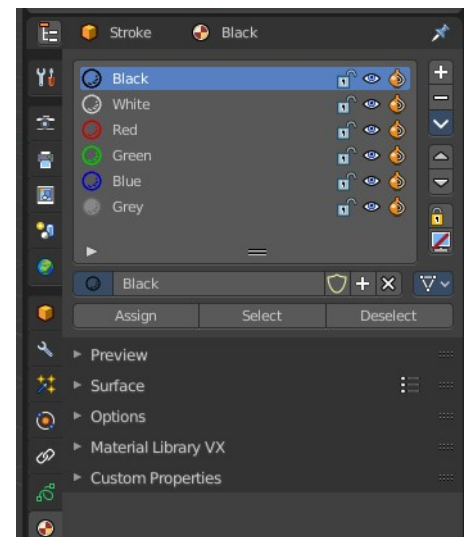

Last Operator Change Stroke Color

Material

The materials are defined by its name. So when you want to use another material, then change the name here.

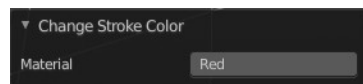

Set as active material

Sets the current selected material as the active material.

Arrange

Changes the drawing order of the strokes in the 2D layer.

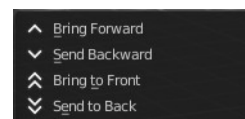

Bring Forward

Moves the selected points/strokes upper the next one in the drawing order.

Send Backward

Moves the selected points/strokes below the previous one in the drawing order.

Bring to Front

Moves to the top the selected points/strokes.

Send to Back

Moves to the bottom the selected points/strokes.

Last Operator Arrange Stroke

Direction

Choose the method again.

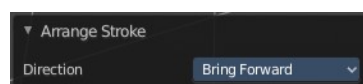

Close

Closes the current stroke by connecting the first vertice with the last vertice by a stroke. See also Toggle Cyclic.

Toggle Cyclic

When the curve is open, then it Closes the current stroke by connecting the first vertice with the last vertice by a stroke. When the curve is closed, then it removes the connection between first and last vertice, and makes the curve open.

Last Operator Set Cyclical State

Type

Choose the method again.

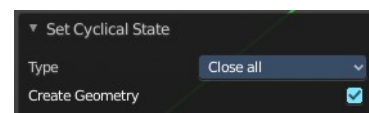

Close all

Close all open selected strokes.

Open all

Open all closed selected strokes.

Toggle

Close or Open selected strokes as required.

Create geometry

When enabled, points are added for closing the strokes like when using the Close tool. If disabled, the stroke is closed with just one edge.

Toggle Caps

Toggles if the start and endpoints of the strokes are rounded or flat.

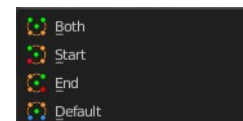
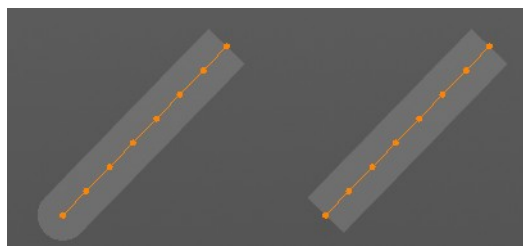

Default

Sets stroke start and end points to rounded (default).

Both

Toggle stroke start and end points caps to flat or rounded.

Start

Toggle stroke start point cap to flat or rounded.

End

Toggle stroke end point cap to flat or rounded.

Last Operator Set Caps Mode

Type

Choose the method again.

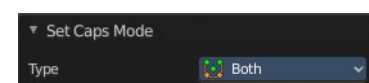

Switch Direction

Switches the direction of the stroke geometry.

Set Start Point

Just for cyclic strokes. Sets the start point of the cyclic stroke.

How to: select the vertice that should be the new start point. Then perform tool.

Re project Strokes

Re projects the selected stroke points in the selected view method.

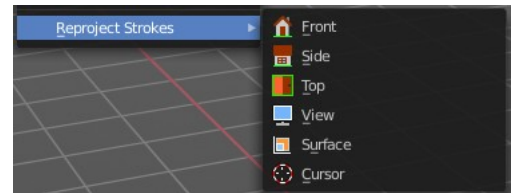

Last Operator Re project Strokes

Projection Type

Choose the method again.

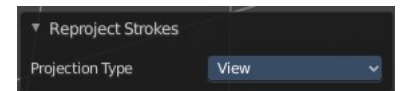

Normalize Thickness

Adjust the thickness of the stroke.

Normalize Opacity

Adjust the opacity of the stroke.

Last operator Normalize Stroke

This last operator works for both tools, Normalize Thickness and Normalize Opacity.

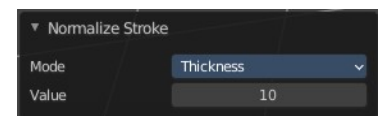

Mode

Adjust thickness or opacity.



Value

The value to adjust the opacity or thickness.

Reset Fill Transform

Reset any UV transformation back to default values.

Outline

Converts the outline of the stroke to a new stroke and removes the original stroke.



This tool requires to have a **ACTIVE** camera in the scene, since the outline is created from this active camera. And the outline is created from exact this view of the camera. So better switch to camera view to check if the view fits.

The active camera has the active orange triangle above the widget. You can also see the active camera in the Scene properties.

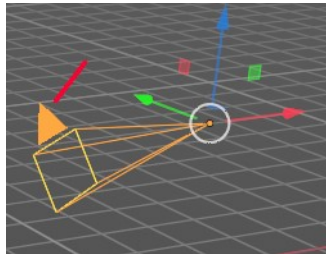
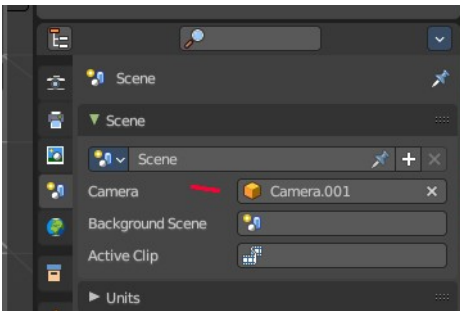

Last operator Convert Stroke to Outline

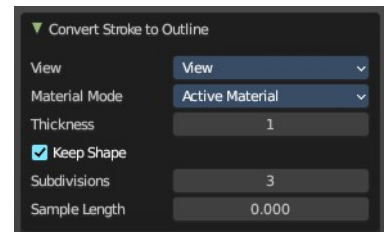

View

From which view to calculate the outline.

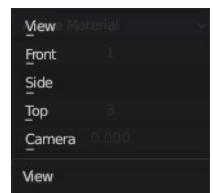

Material Mode

What material to assign to the new stroke.



Thickness

The thickness of the new stroke

Keep Shape

Try to keep global shape when the stroke thickness changes.

Subdivisions

How many subdivisions the new stroke has

Sample Length

Sample length of the stroke.

7.1.32 Editors - 3D Viewport - Header - Grease Pencil - Edit mode - Points menu

Table of content

- Edit Mode - Points Menu.....1
- Extrude.....1
- Smooth.....1
- Last Operator Smooth Stroke.....1
- Repeat.....1
- Factor.....2
- Selected points.....2
- Position.....2
- Thickness.....2
- Strength.....2
- UV's.....2
- Merge.....2
- Last Operator Merge Strokes.....2
- Mode.....2
- Draw on back.....2
- Additive drawing.....2
- Cyclic.....2
- Dissolve Points.....2
- Delete Strokes.....3
- Vertex Groups.....3
- Add New Group.....3
- Assign.....3
- Remove.....3
- Select.....3
- Deselect.....3

Edit Mode - Points Menu

Extrude

Extrudes out the selected points. The new points stay connected with the original points of the stroke.

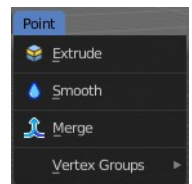

Smooth

Smoothens out the selected geometry.

Last Operator Smooth Stroke

Repeat

How often to repeat the procedure.

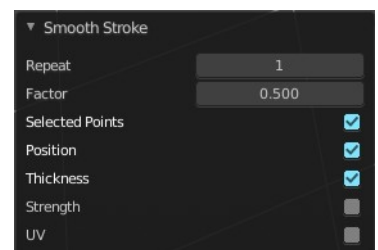

Factor

The amount of the smoothness to apply.

Selected points

When enabled, limits the effect to only the selected points within the stroke.

Position

When enabled, the operator affect the points location.

Thickness

When enabled, the operator affect the points thickness.

Strength

When enabled, the operator affect the points strength (alpha).

UV's

When enabled, the operator affect the UV rotation on the points.

Merge

Allows you to paint a new stroke between the selected vertices. The selected points are not merged though, but a new stroke is created.

Last Operator Merge Strokes

Mode

Choose between stroke or point mode.

This feature is not documented in the Blender manual, there is no explanation in the tool tip, and it is not to find out what the difference is. Both do the same.

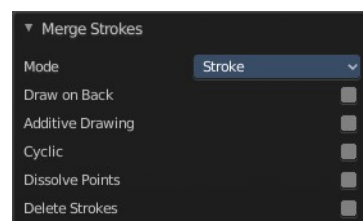

Draw on back

Draw the new stroke below all other strokes.

Additive drawing

Add to previous drawing

Cyclic

Close the new stroke

Dissolve Points

Dissolve the old selected points.

Delete Strokes

Deletes the old selected strokes.

Vertex Groups

This menu contains just the Add New Group button as long as no vertex group exists.

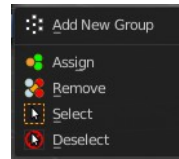

Add New Group

Adds a new group.

Assign

Assign the current selected geometry to the current active group.

Remove

Removes the current selected geometry from the current active group.

Select

Select the geometry of the current active group.

Deselect

Deselect the geometry of the current active group.

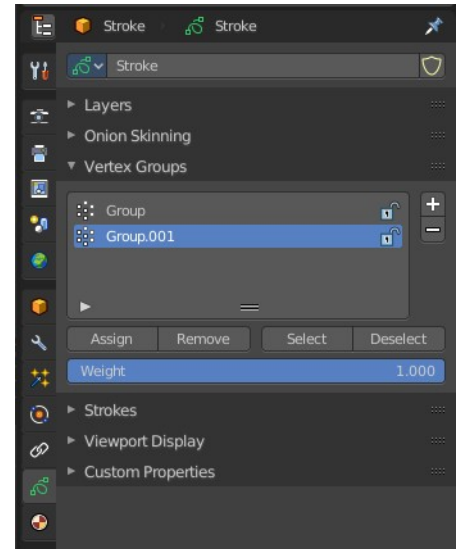



7.1.33 Editors - 3D Viewport - Header - Grease Pencil - Draw mode - Draw menu

Table of content

Draw Mode - Draw Menu.....	2
Active Layer.....	2
New Layer.....	2
Interpolate.....	2
Interpolate Sequence.....	2
Animation.....	2
Insert Blank Keyframe (Active Layer).....	2
Insert Blank Keyframe (All Layers).....	2
Last Operator Insert Blank Frame.....	2
All Layers.....	2
Duplicate Active Keyframe (Active Layer).....	3
Duplicate Active Keyframe (All Layers).....	3
Last Operator Insert Blank Frame.....	3
Mode.....	3
Delete Active Keyframe (Active Layer).....	3
Delete Active Keyframe (All Layers).....	3
Show/Hide.....	3
Show all Layers.....	3
Last Operator Hide Layers.....	3
Select.....	3
Hide Active Layer.....	3
Hide inactive Layers.....	3
Last Operator Hide Layers.....	3
Unselected.....	3
Clean Up.....	4
Boundary Strokes.....	4
Boundary Strokes all Frames.....	4
Last Operator Clean Fill Boundaries.....	4
Mode.....	4
Delete loose Points.....	4
Last Operator Clean loose points.....	4
Limit.....	4
Delete Duplicated Frames.....	4
Last Operator Clean Duplicated Frames.....	4
Type.....	4
Recalculate Geometry.....	4

Draw Mode - Draw Menu

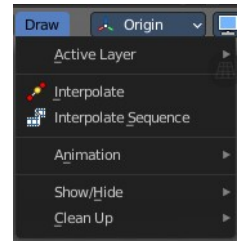

Active Layer

Set and show the active grease pencil layer. The layer with the pencil is the active layer for drawing.

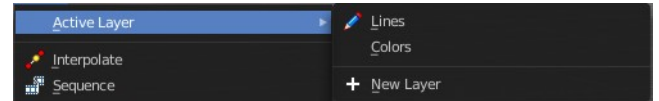

New Layer

Add a new draw layer.

Interpolate

Interpolates strokes between the previous and next keyframe by adding a single keyframe. When you are on a frame between two keyframes and click the Interpolate button a new breakdown keyframe will be added. This way you define the final interpolation for the new stroke.

Interpolate Sequence

Interpolate strokes between the previous and next keyframe by adding multiple keyframes. When you are on a frame between two keyframes and click the sequence button, then a breakdown keyframe will be added on every frame between the previous and next keyframe.

Animation

Insert Blank Keyframe (Active Layer)

Inserts a keyframe into the active layer.

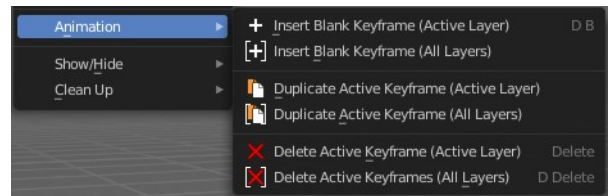

Insert Blank Keyframe (All Layers)

Inserts a keyframe into all layers.

Last Operator Insert Blank Frame

Some snap operations shows a last operation panel, some not.

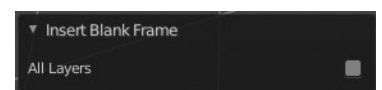

All Layers

Insert into active layer or into all layers.

Duplicate Active Keyframe (Active Layer)

Duplicates the active keyframe in the active layer.

Duplicate Active Keyframe (All Layers)

Duplicates the active keyframe in all layers.

Last Operator Insert Blank Frame

Some snap operations shows a last operation panel, some not.

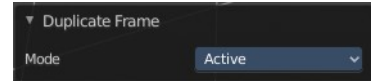

Mode

Duplicate the active keyframe in the active layer or in all layers.

Delete Active Keyframe (Active Layer)

Deletes the active keyframe in the active layer.

Delete Active Keyframe (All Layers)

Deletes the active keyframe in all layers

Show/Hide

Show all Layers

Makes all layers in the scene visible .

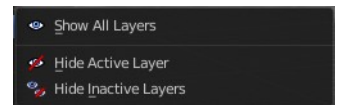

Last Operator Hide Layers

Select

Shows just selected layers.

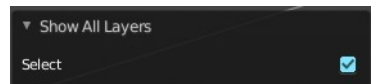

Hide Active Layer

Hides the active layer.

Hide inactive Layers

Hides the not selected layers. The selected layers stays visible.

Last Operator Hide Layers

Unselected

Hides the not selected layers.



Clean Up

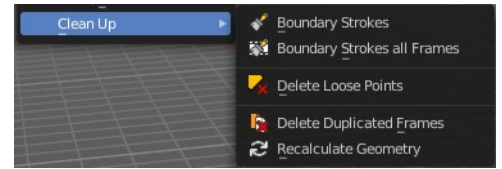

Boundary Strokes

Remove "no fill" boundary strokes from the active frame.

Boundary Strokes all Frames

Remove "no fill" boundary strokes from all frames.

Last Operator Clean Fill Boundaries

Mode

Choose if you want to remove the "no fill" boundary strokes just from the active frame, or from all frames.

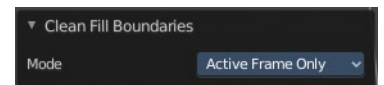

Delete loose Points

Deletes loose stroke points.

Last Operator Clean loose points

Limit

Adjust with how much vertices a stroke gets count as loose geometry.

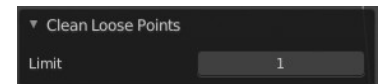

Delete Duplicated Frames

Deletes all duplicated frames.

Last Operator Clean Duplicated Frames

Type

Delete just in the selected frames or in all frames.

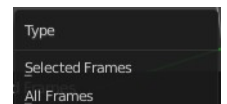
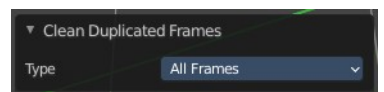

Recalculate Geometry

Update all internal geometry data.



7.1.34 Editors - 3D Viewport - Header - Grease Pencil - Vertex Paint mode - Animation menu

Table of content

Animation Menu.....	1
Animation.....	1
Insert Blank Keyframe (Active Layer).....	1
Insert Blank Keyframe (All Layers).....	1
Last Operator Insert Blank Frame.....	1
All Layers.....	1
Duplicate Active Keyframe (Active Layer).....	1
Duplicate Active Keyframe (All Layers).....	1
Last Operator Insert Blank Frame.....	1
Mode.....	2
Delete Active Keyframe (Active Layer).....	2
Delete Active Keyframe (All Layers).....	2

Animation Menu

Animation

Insert Blank Keyframe (Active Layer)

Inserts a keyframe into the active layer.

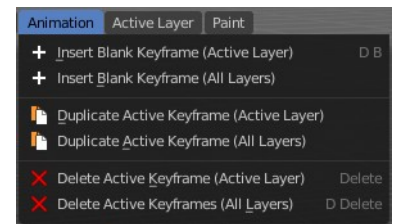

Insert Blank Keyframe (All Layers)

Inserts a keyframe into all layers.

Last Operator Insert Blank Frame

Some snap operations shows a last operation panel, some not.

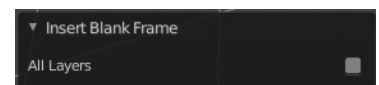

All Layers

Insert into active layer or into all layers.

Duplicate Active Keyframe (Active Layer)

Duplicates the active keyframe in the active layer.

Duplicate Active Keyframe (All Layers)

Duplicates the active keyframe in all layers.

Last Operator Insert Blank Frame

Some snap operations shows a last operation panel, some not.

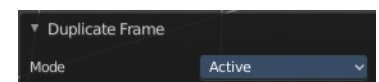

Mode

Duplicate the active keyframe in the active layer or in all layers.

Delete Active Keyframe (Active Layer)

Deletes the active keyframe in the active layer.

Delete Active Keyframe (All Layers)

Deletes the active keyframe in all layers



7.1.35 Editors - 3D Viewport - Header - Grease Pencil - Vertex Paint mode - Active Layer menu

Table of content

Active Layer Menu.....	1
New Layer.....	1

Active Layer Menu

Set and show the active grease pencil layer. The layer with the pencil is the active layer for drawing.

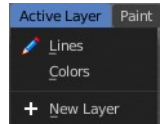

New Layer

Add a new draw layer.



7.1.36 Editors - 3D Viewport - Header - Grease Pencil - Draw mode - Draw menu

Table of content

Paint Menu.....	1
Set Vertex Colors.....	1
Last operator Vertex Paint Set Color.....	1
Mode.....	2
Factor.....	2
Reset Vertex Color.....	2
Last operator Reset Vertex Color.....	2
Mode.....	2
Invert.....	2
Last operator Vertex Paint Invert.....	2
Mode.....	2
Levels.....	2
Last operator Vertex Paint Levels.....	2
Mode.....	2
Offset.....	2
Gain.....	2
Hue Saturation Value.....	2
Last operator Vertex Paint Hue Saturation Value.....	3
Mode.....	3
Hue.....	3
Saturation.....	3
Value.....	3
Bright Contrast.....	3
Last operator Vertex Paint Bright/Contrast.....	3
Mode.....	3
Brightness.....	3
Contrast.....	3

Paint Menu

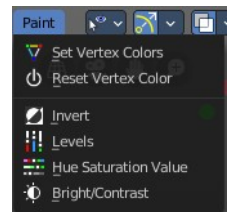

Set Vertex Colors

Sets the color of all selected vertices to the current active vertex color.

Last operator Vertex Paint Set Color

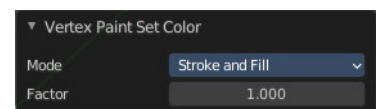

Mode

What vertex colors to affect.

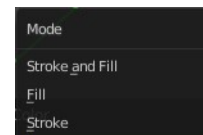

Factor

How strong the color is set compared to the old color.

Reset Vertex Color

Resets all vertex color to white.

Last operator Reset Vertex Color

Mode

What vertex colors to affect.

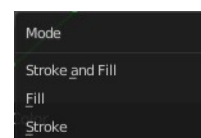
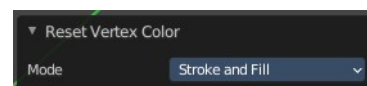

Invert

Inverts the stroke colors.

Last operator Vertex Paint Invert

Mode

What vertex colors to affect.

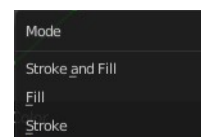
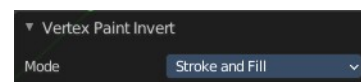

Levels

Adjust the levels of the vertex colors.

Last operator Vertex Paint Levels

Mode

What vertex colors to affect.

Offset

Value to add to the colors.

Gain

Value to multiply colors by.

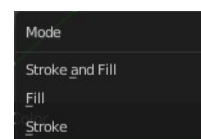
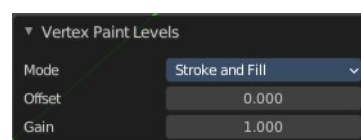

Hue Saturation Value

Adjust the HSV colors of the vertex colors.

Last operator Vertex Paint Hue Saturation Value

Mode

What vertex colors to affect.

Hue

The hue value

Saturation

The saturation value.

Value

The value value.

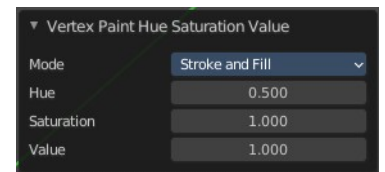
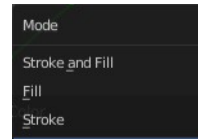

Bright Contrast

Adjust the brightness and contrast of the vertex colors.

Last operator Vertex Paint Bright/Contrast

Mode

What vertex colors to affect.

Brightness

The brightness value

Contrast

The contrast value.

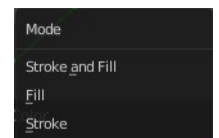
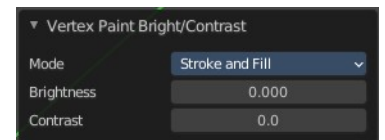

7.1.37 Editors - 3D Viewport - Header - Grease Pencil - Weight Paint Mode - Weights Menu

Table of content

Weight Paint Mode - Weights Menu.....	1
Sample Weight.....	2
Normalize All.....	2
Last Operator Normalize all Vertex Group.....	2
Lock Active.....	2
Normalize.....	2
Invert.....	2
Clean.....	2
Adjust last operator Clean Vertex Group Weights.....	2
Subset.....	2
Limit.....	2
Keep Single.....	2
Quantize.....	3
Adjust last operator Quantize Vertex Group.....	3
Subset.....	3
Steps.....	3
Levels.....	3
Adjust last operator Clean Vertex Group Weights.....	3
Subset.....	3
Offset.....	3
Gain.....	3
Smooth.....	3
Last Operator Smooth Vertex Group.....	3
Factor.....	3
Iterations.....	3
Generate Weights sub menu.....	4
With empty Groups.....	4
With Automatic Weights.....	4
Adjust last operator Generate Automatic Weights.....	4
Mode.....	4
Armature.....	4
Ratio.....	4
Decay.....	4

Weight Paint Mode - Weights Menu

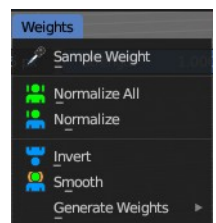

Sample Weight

Pick the weight under the mouse by a click.

Normalize All

Normalizes the weight of all Vertex groups so that the values for the single vertices in the sum is 1.

Last Operator Normalize all Vertex Group

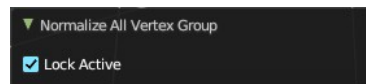

Lock Active

Keep the values of the active group while normalizing others.

Normalize

Normalize normalizes the weight of the current selected Vertex group so that the values for the single vertices in the sum is 1. Means when there is influence from other groups, then those values are kept, but the one for the current group gets lowered so that the sum is 1.

Invert

Invert inverts the weight painting for the selected vertex group.

Clean

Remove vertex group assignments which are not required.

Adjust last operator Clean Vertex Group Weights.

Subset

Which group should be used.

Limit

Add vertices from groups that have zero weight before inverting.

Keep Single

Keep vertices that are assigned to at least one group when cleaning.

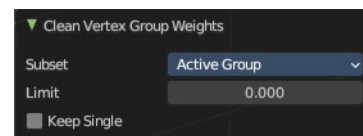

Quantize

Set the weights to a fixed number of steps. Going from 0 to 1.

Adjust last operator Quantize Vertex Group

Subset

Which group should be used.

Steps

The number of steps between 0 and 1.

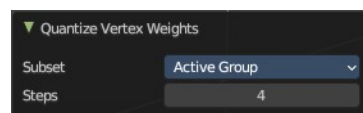

Levels

Add some offset and multiply with some gain the weights of the active vertex group.

Adjust last operator Clean Vertex Group Weights.

Subset

Which group should be used.

Offset

The offset value to add to the weights.

Gain

Value to multiply weights by.



Smooth

Smooths the weight for selected vertices.

Last Operator Smooth Vertex Group

Factor

Here you adjust the factor.

Iterations

Here you adjust how many iterations you use.

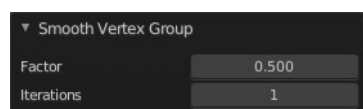

Generate Weights sub menu

The content of this sub menu requires to have the grease pencil object parented to an armature. Which is somehow odd. Since then these operators are not longer needed. The content is already properly parented. And the parenting process needs to happen in object mode anyways.

However, you can change from empty groups to with automatic weights and vice versa here. So this is a convenient way to remove all vertex groups, or to reset the automatic weighting to restart the weight painting.

With empty Groups

Parent the grease pencil to the armature with empty vertex groups.

With Automatic Weights

Parent the grease pencil to the armature with empty vertex groups.

Adjust last operator Generate Automatic Weights



Mode

Add empty vertex groups without any weighting, or assign the vertex groups automatically to the available bones.

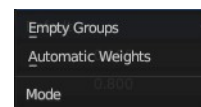

Armature

Which armature to use. A armature can have sub armatures ...

Default means the default armature.

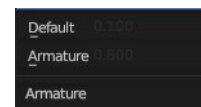

Ratio

The ratio between bone length and influence radius.

Decay

The factor to reduce the influence depending of distance to bone axis.



7.1.38 Editors - 3D Viewport - Header - Armature - Edit mode - Armature menu

Table of content

Detailed Table of content.....	1
Edit Mode - Armature Menu.....	5
Transform.....	5
To Sphere.....	5
Shear.....	6
Bend.....	7
Push/Pull.....	7
Warp.....	8
Randomize Transform.....	8
Align Bones.....	9
Mirror.....	9
Interactive Mirror.....	9
X Global, Y Global etc.....	9
Snap.....	10
Last Operator Snap.....	10
Bone Roll.....	10
Single Operators.....	12
Extrude.....	12
Extrude to Cursor or Add.....	12
Duplicate.....	12
Symmetrize.....	14
Subdivide.....	15
Names.....	15
Change Armature Layers.....	16
Change Bone Layers.....	16
Make Parent.....	16
Clear Parent.....	17
Bone Settings.....	17
Show/Hide.....	18
Delete selected bones.....	18
Dissolve selected bones.....	18

Detailed Table of content

Detailed table of content

Detailed Table of content.....	1
Edit Mode - Armature Menu.....	5
Transform.....	5
To Sphere.....	5
Usage.....	5
Last Operator To Sphere Panel.....	6
Factor.....	6
Proportional editing.....	6

Proportional Falloff.....	6
Proportional Size.....	6
Connected.....	6
Projected(2D).....	6
Shear.....	6
Last Operator Shear.....	6
Offset.....	6
Shear Axis.....	6
Axis.....	6
Axis Ortho.....	7
Orientation.....	7
Proportional editing.....	7
Proportional Falloff.....	7
Proportional Size.....	7
Connected.....	7
Projected(2D).....	7
Bend.....	7
Push/Pull.....	7
Last Operator Push/Pull.....	7
Factor.....	7
Proportional editing.....	7
Proportional Falloff.....	8
Proportional Size.....	8
Connected.....	8
Projected(2D).....	8
Warp.....	8
Last operator Warp.....	8
Warp Angle.....	8
Offset Angle.....	8
Min.....	8
Max.....	8
Randomize Transform.....	8
Last Operator Randomize Transform.....	8
Amount.....	8
Uniform.....	8
Normal.....	9
Random Seed.....	9
Align Bones.....	9
Mirror.....	9
Interactive Mirror.....	9
X Global, Y Global etc.....	9
Last Operator Mirror.....	9
Orientation.....	9
Constraint Axis.....	9
Proportional editing.....	9
Proportional Falloff.....	10
Proportional Size.....	10
Connected.....	10
Projected(2D).....	10
Snap.....	10
Last Operator Snap.....	10
Offset.....	10
Bone Roll.....	10

Last Operator Recalculate Roll.....	11
Type.....	11
Flip Axis.....	11
Shortest Rotation.....	11
Set Bone Roll.....	11
Last Operator Transform.....	11
Clear Roll.....	11
Last Operator Clear Roll.....	11
Roll.....	11
Single Operators.....	12
Extrude.....	12
Last Operator Extrude.....	12
Forked.....	12
Move X , Y, Z.....	12
Orientation.....	12
Proportional editing.....	12
Extrude to Cursor or Add.....	12
Last Operator Extrude to Cursor or Add.....	12
Location X Y Z.....	12
Duplicate.....	12
Last Operator Duplicate.....	13
Duplicate Objects.....	13
Flip Names.....	13
Move X , Y , Z.....	13
Orientation.....	13
Proportional editing.....	13
Merge Bones.....	13
Last Operator Merge Bones.....	13
Type.....	13
Fill between Joints.....	14
Split.....	14
Separate.....	14
Symmetrize.....	14
Last Operator Symmetrize.....	15
Direction.....	15
Subdivide.....	15
Last Operator Subdivide Multi.....	15
Number of Cuts.....	15
Switch Direction.....	15
Names.....	15
Autoname Left/Right.....	15
Autoname Front/Back.....	15
Autoname Top/Bottom.....	15
Last operator Autoname by Axis.....	16
Axis.....	16
Flip Names.....	16
Last operator Flip Names.....	16
Strip Numbers.....	16
Change Armature Layers.....	16
Last Operator Change Armature Layers.....	16
Layer.....	16
Change Bone Layers.....	16
Last Operator Change Bone Layers.....	16

Layer.....	16
Make Parent.....	16
Connected.....	17
Keep Offset.....	17
Last Operator Make Parent.....	17
Parent Type.....	17
Clear Parent.....	17
Clear Parent.....	17
Disconnect Bone.....	17
Last Operator Clear Parent.....	17
Clear Type.....	17
Bone Settings.....	17
Last Operator Collection Boolean Set.....	18
Show/Hide.....	18
Show Hidden.....	18
Hide Selected.....	18
Hide Unselected.....	18
Delete selected bones.....	18
Dissolve selected bones.....	18

Edit Mode - Armature Menu

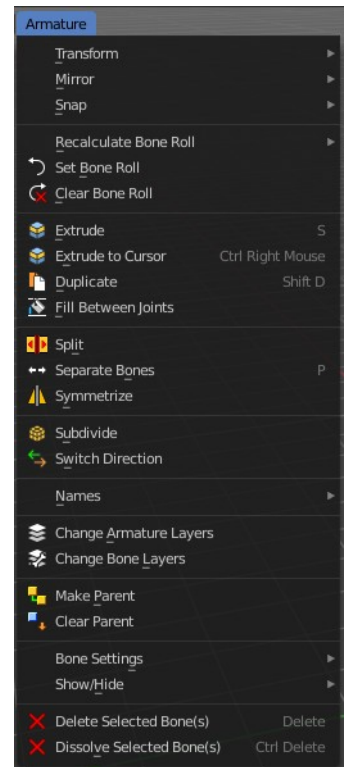

Transform

To Sphere

Shapes a selection of objects into the shape of a sphere. The calculation happens with the object origins.

In Object mode this tool requires to have more than one object selected.

Usage

Select the vertices, activate the tool, then drag the mouse in the 3D viewport. In the header you will read the current factor then. Which tells you how close you are towards the sphere shape. With a skeleton the to sphere operation is everything but accurate though. The bones gets stretched or compressed

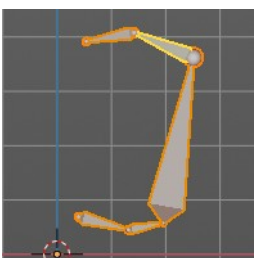
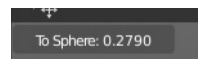
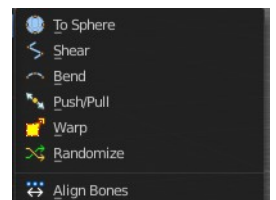

Last Operator To Sphere Panel

Factor

The factor to transform the selection into a shape form.

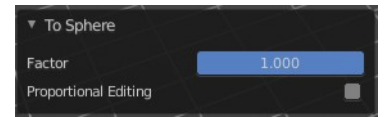

Proportional editing

Enables proportional editing. Activating proportional editing reveals further settings.

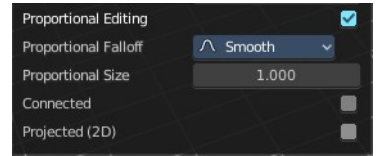

Proportional Falloff

Adjust the falloff methods.

Proportional Size

See and adjust the falloff radius.

Connected

The proportional falloff gets calculated for connected parts only.

Projected(2D)

The proportional falloff gets calculated in the screen space. Depth doesn't play a role. When it's in the radius, then it gets calculated.

Shear

Shear shears the selection.

Last Operator Shear

Offset

Adjust an offset.

Shear Axis

The shear tool works along a imaginary 2d plane. The shear axis controls if the items are sheared along the x or the y axes of this plane. This is the plane along which the transformation happens. You can shear along the x or the y axis of this plane.

To make things even more complicated, the orientation of this imaginary plane is defined by the Axis and Axis Ortho items below.

Axis

Defines one axis of the imaginary shear axis plane.

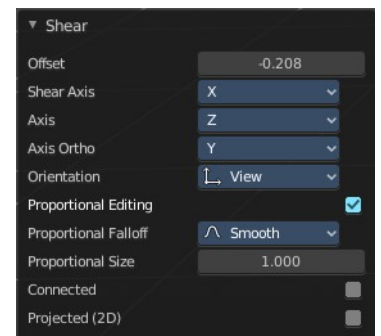

Axis Ortho

Defines the other axis of the imaginary shear axis plane.

Orientation

Choose the orientation for the shear action.

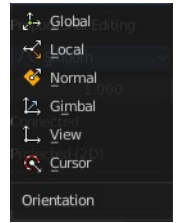

Proportional editing

Enables proportional editing. Activating proportional editing reveals further settings.

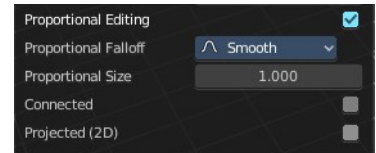

Proportional Falloff

Adjust the falloff methods.

Proportional Size

See and adjust the falloff radius.

Connected

The proportional falloff gets calculated for connected parts only.

Projected(2D)

The proportional falloff gets calculated in the screen space. Depth doesn't play a role. When it's in the radius, then it gets calculated.

Bend

Bends the selection.

Push/Pull

It pushes or pulls the object positions relative to the centre of the selection.

In Object mode this tool requires to have more than one object selected.

Last Operator Push/Pull

Factor

Adjust the strength of influence of the tool.

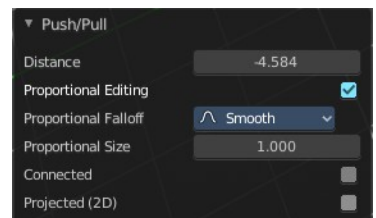

Proportional editing

Enables proportional editing. Activating proportional editing reveals further settings.

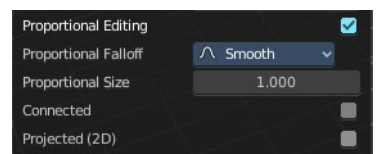

Proportional Falloff

Adjust the falloff methods.

Proportional Size

See and adjust the falloff radius.

Connected

The proportional falloff gets calculated for connected parts only.

Projected(2D)

The proportional falloff gets calculated in the screen space. Depth doesn't play a role. When it's in the radius, then it gets calculated.

Warp

Warp a mesh selection between two defined points.

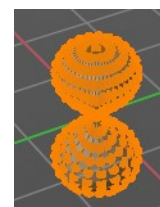

Last operator Warp

Warp Angle

The strength of the warp effect

Offset Angle

An offset angle to bend sideways.

Min

The start point.

Max

The end point.

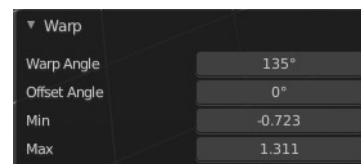

Randomize Transform

This tool allows randomizes the positions of the selected vertices.

Last Operator Randomize Transform

Amount

Adjust the amount.

Uniform

The uniform offset distance.

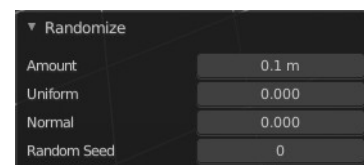

Normal

Align the offset direction to the normals.

Random Seed

The seed value for randomization.

Align Bones

Aligns the selected bones to the orientation of the active bone.

Mirror

Mirror mirrors the selected geometry along the defined axis.

Interactive Mirror

Mirror by hotkeys. You activate the tool, type in x for x global for example, or x x for x local. And the selection gets mirrored



X Global, Y Global etc.

Mirrors the selection around the chosen axis.

Last Operator Mirror

The Last Operator Mirror panel gives you tools to adjust the mirror action.

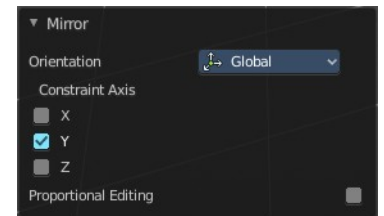

Orientation

Orientation is a drop-down box. Choose the type of orientation for the mirroring action.

Constraint Axis

Constraint Axis gives you again the possibility to define the mirror axis. You can choose more than one axis here.

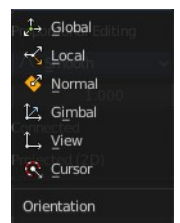

Proportional editing

Enables proportional editing. Activating proportional editing reveals further settings.

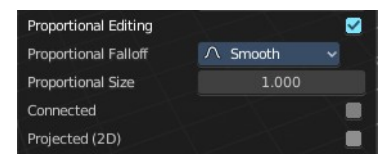

Proportional Falloff

Adjust the falloff methods.

Proportional Size

See and adjust the falloff radius.

Connected

The proportional falloff gets calculated for connected parts only.

Projected(2D)

The proportional falloff gets calculated in the screen space. Depth doesn't play a role. When it's in the radius, then it gets calculated.

Snap

Choose several methods to snap one element to another. The menu items should be self explaining.



Last Operator Snap

Some snap operations shows a last operation panel, some not.

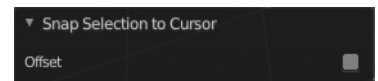

Offset

If the selection should snap as a whole, or if each individual element of the selection should snap.

Bone Roll

Recalculate Bone Roll Recalculate Roll is a menu where you can recalculate the bone roll in various ways.

The menu items are pretty self explaining. So we will not repeat the descriptions here.

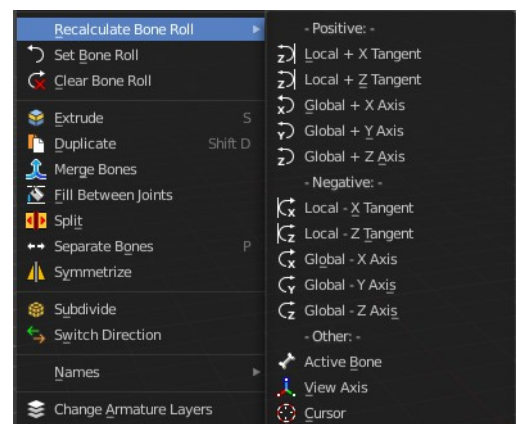

Last Operator Recalculate Roll

Type

Type is a drop-down box. Choose the recalculation method again.

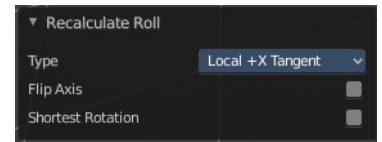

Flip Axis

Negates the alignment axis.

Shortest Rotation

Ignore the axis direction, and use the shortest rotation to align the bone(s)

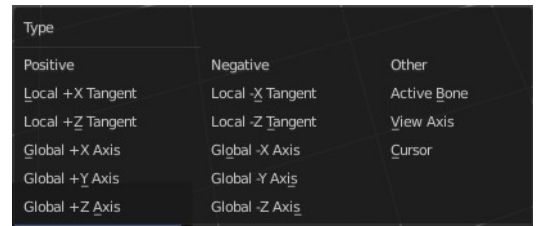

Set Bone Roll

This operation is relative to the starting value, and starts always with zero. It does not display the Bone Roll value from the Transform panel. It adds or subtracts the amount of the operation to/from the Roll value then.

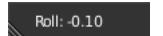

While operating you will see the current relative Roll value in the header.

Last Operator Transform

The only interesting value is the X value right at the top. The other settings here are simply dysfunctional. You cannot turn on proportional editing, axis and orientation doesn't play any role since it always rotates around the bone orientation. And so we will not go into detail here.

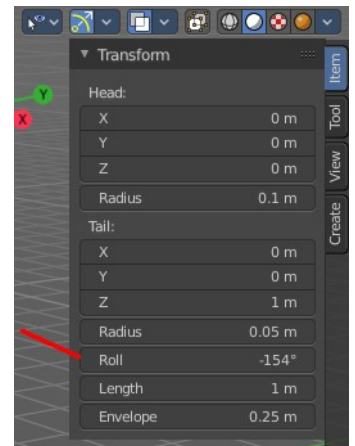
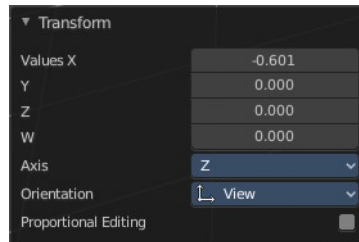

Unfortunately even the X value to display the amount of the roll is broken. It displays the amount in Radians, while the Bone roll is in degrees.

Clear Roll

Set the bone roll value directly.



Last Operator Clear Roll

Roll

Set the bone roll.

Single Operators

Extrude

Extrudes out a bone from the selected joints.

Last Operator Extrude

Forked

You need to tick X Axis Mirror. When you tick Forked, then the bone that you extrude to the one side will now be extruded to the other side too. The extrude gets mirrored along the x axis. This allows you to create a symmetrical armature.

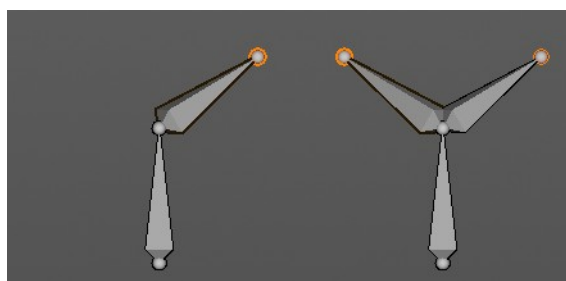
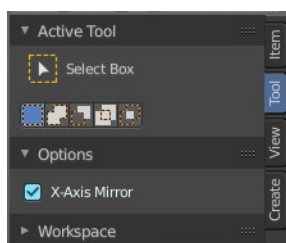
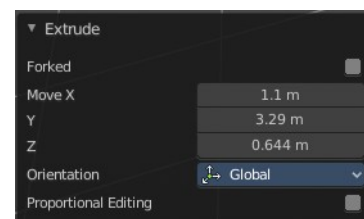

Move X , Y, Z

The transform values for the new created joint(s)

Orientation

Orientation is a drop-down box. Choose the type of orientation for the mirroring action.

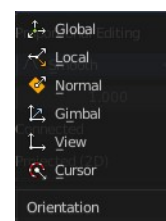

Proportional editing

Proportional editing is dysfunctional. You cannot activate it.

Extrude to Cursor or Add

Hotkey only tool. Extrude to the mouse position.

Last Operator Extrude to Cursor or Add

Location X Y Z

The location to extrude to.

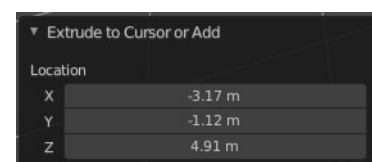

Duplicate

Duplicates selected bones.

You are automatically in grab mode, and so you can easily move the object out of position. Which is sometimes wanted, since you can position the duplicate then. But sometimes this is unwanted. A right click after releasing the mouse lets the object snap back into its creation position.

When you drag the duplicate around you will see the position values in the header.



Last Operator Duplicate

Duplicate Objects

Flip Names

Tries to flip the names of the bones. This is a name convention feature. When you have a bone called mybone.R, then it tries to become mybone.L

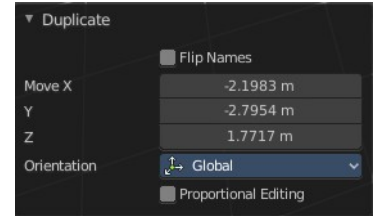

Move X , Y , Z

The Position of the duplicated object.

Orientation

Orientation is a drop-down box. Choose the type of orientation for the duplicate action.

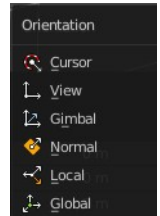

Proportional editing

This checkbox has no use here. You cannot activate it.

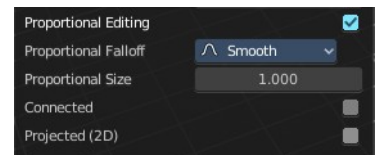

Merge Bones

Merges two connected bones in a chain into one bone.

When you click the Merge Bones button then you will get a pop-up. Choose between exactly nothing since there is one choice. Within chains.

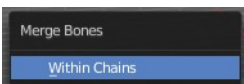

Last Operator Merge Bones

Type

Type is a drop-down box. Choose between exactly nothing since there is one choice. Within chains.

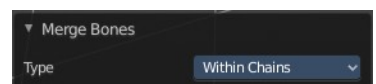

Fill between Joints

Fill between joints fills a bone between two selected joints.

When there is just one joint selected, then the bone is created between this selected joint and the 3D cursor.

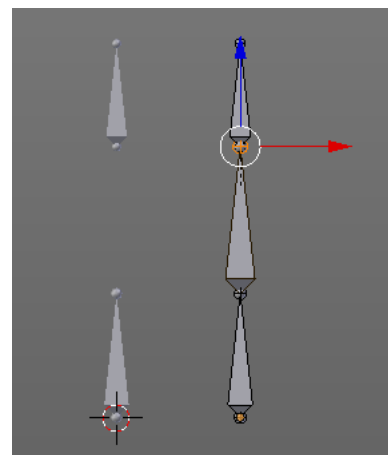

Split

Split splits the selected bone(s) from connected bones. They are still part of the armature. But the bone is now floating. And you can pull this bone(s) around without pulling the rest of the armature around.

The Last operator for Split has no content.

Separate

Separate separates the selected bone(s) from the armature. And creates a new, independent, armature.

The Last operator for Separate has no content.

Symmetrize

Creates a symmetrical mirrored copy of the currently selected bones along the X axis. The mirror centre is the pivot of the armature.

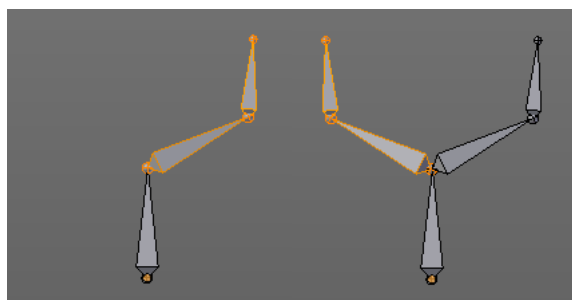

The bones that you want to symmetrize needs to follow the left right name conventions for bones. Bones without this left right naming are not affected by the tool. If there is a lower or upper case “L”, “R”, “left” or “right” with a separating dot in the bone name, then this tool creates and renames the bones names to its counter part. Bone.L becomes Bone.R.

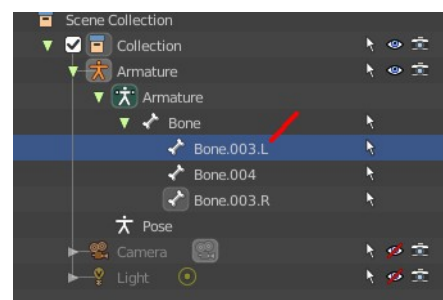

Last Operator Symmetrize

Direction

Define the calculation direction. From -X to + X or from +X to -X



Subdivide

Subdivide subdivides the current selection.

Last Operator Subdivide Multi

Number of Cuts

Adjust the number of subdivisions.

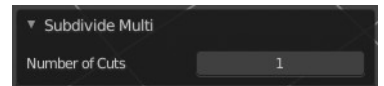

Switch Direction

Switches the direction in which the selected bones are pointing.

Names

Bforartists has some internal name conventions for a symmetrical armature. Bones are for example named mybone.L or mybone.R, dependant at which side of the mirror axis they are. The Names items allows you to rename the bone names to this name convention.



Autoname Left/Right

Renames the bones from left to right.

Autoname Front/Back

Renames the bones from front to back.

Autoname Top/Bottom

Renames the bones from top to bottom.

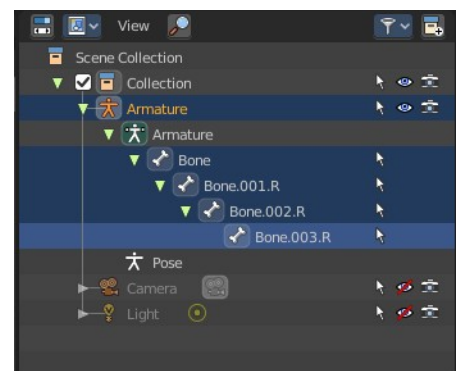
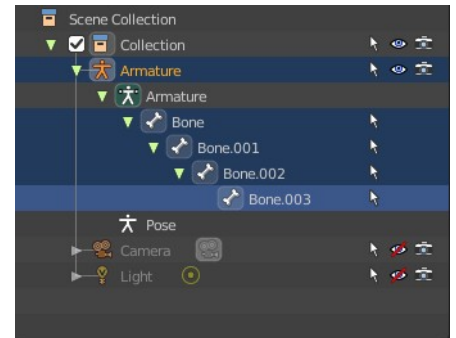

Last operator Autaname by Axis

Axis

Choose the autaname axis again. Left/Right is X axis, Front/Back is Y axis, and Top/Bottom is Z axis.



Flip Names

When you mirror a half of an armature you end in names like Bone.001.R.001. But what we need is Bone.001.L for a symmetrical armature. Flip names flips the names to follow the left right name conventions.

Last operator Flip Names

Strip Numbers

Tries to remove the numbers in the names if possible.



Change Armature Layers

Armatures have its own layer system. This menu item opens a pop-up where you can put the whole armature onto another layer.

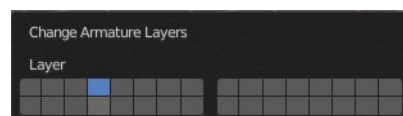

Last Operator Change Armature Layers

Layer

Put the armature onto another layer.

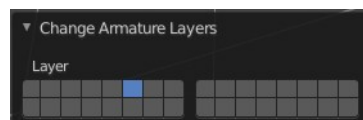

Change Bone Layers

Armatures have its own layer system. This menu item opens a pop-up where you can put single selected bone(s) onto another layer.



Last Operator Change Bone Layers

Layer

Put the selected bones onto another layer.



Make Parent

Adds a parent relationship.

Select a bone, hold down shift, select the bone that you want to parent it to. Perform Make Parent. In the pop-up choose the method that you want to use.

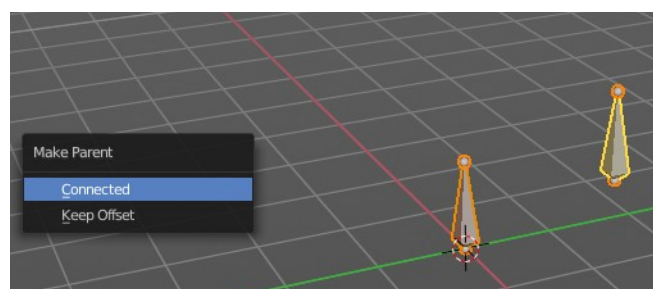

Connected

The child bone will jump to the position of the tail joint of the parent bone.

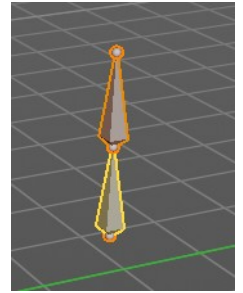

Keep Offset

The bone will remain in its original position. The relationship will be displayed by a black dotted line.

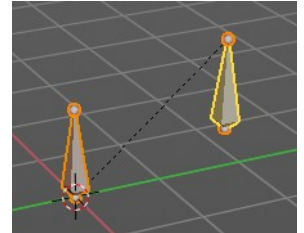

Last Operator Make Parent

Parent Type

Choose between Connected and Keep Offset method again.

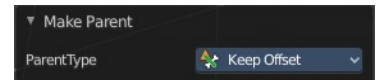

Clear Parent

Clears the parent relationship of the selected bone(s). It calls a pop-up menu. Choose between two methods.

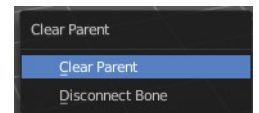

Clear Parent

Clears the parent relationship of the selected bone(s).

Disconnect Bone

The parent ship is kept. Turns a Connected parent relationship into a Keep Offset parent relationship. You can move the disconnected bone around without to pull the parent with it.

Last Operator Clear Parent

Clear Type

Choose between Clear Parent and Disconnect Bone method again.

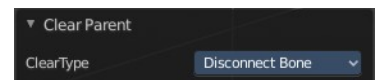

Bone Settings

Bone Settings is a menu with menu items to toggle special checkboxes in the Properties editor. But here you can do it for a selection too, and not just one object.



Last Operator Collection Boolean Set

Each of the menu items uses the same Last Operator. With different strings for the booleans.

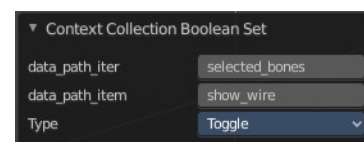

Show/Hide

Show or hide the selected bones in the viewport.



Show Hidden

Makes all bones visible again.

Hide Selected

Hides the selected bones.

Hide Unselected

Hides the not selected bones. The selected bones stays visible.

Delete selected bones

Deletes the selected bones. The hierarchy is kept. The involved bones becomes disconnected.

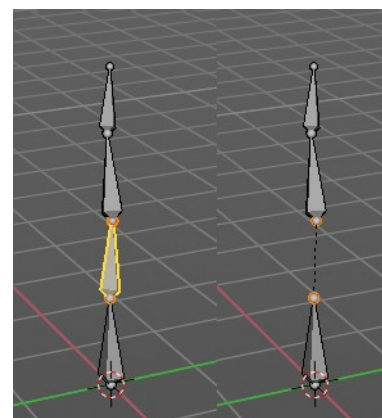

Dissolve selected bones

Merges the selected bone or joint with its hierarchical neighbour bones.

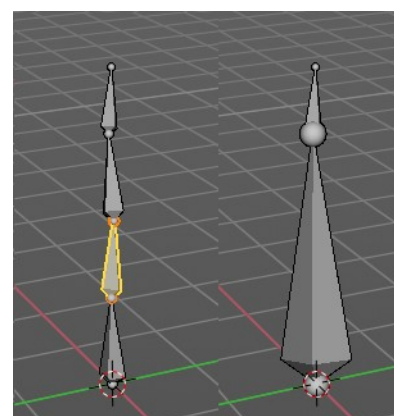

7.1.39 Editors - 3D Viewport - Header - Armature - Pose mode - Pose menu

Table of content

Detailed Table of content.....	1
Pose Mode - Pose Menu.....	4
Clear Transform.....	5
Clear Transform.....	5
Apply.....	6
Apply Pose as Rest Pose.....	6
Apply Selected as Rest Pose.....	6
Apply Visual Transform to Pose.....	6
Assign Custom Property Values as Default.....	6
Snap.....	6
Last Operator Snap.....	7
Animation.....	7
In-Between.....	7
Header values.....	8
Footer hotkey display.....	8
Push Pose from Rest Pose.....	8
Relax Pose to Rest Pose.....	9
Push Pose from Breakdown.....	9
Relax Pose to Breakdown.....	10
Blend to Neighbour.....	11
Propagate.....	12
Last Operator Propagate Pose.....	12
Single Operators.....	13
Copy Pose.....	13
Paste Pose.....	13
Paste Pose Flipped.....	13
Motion Paths.....	14
Bone Groups.....	14
Parent.....	15
Inverse Kinematics.....	16
Constraints.....	17
Names.....	18
Flip Quats.....	19
Change Armature Layers.....	19
Change Bone Layers.....	19
Show/Hide.....	20
Bone Settings.....	20

Detailed Table of content

Detailed table of content

Detailed Table of content.....	1
Pose Mode - Pose Menu.....	4

Clear Transform.....	5
Clear Transform.....	5
All.....	5
Clear User Transforms.....	5
Location.....	5
Rotation.....	5
Scale.....	5
Reset Unkeyed.....	5
Last Operator Clear User Transforms.....	6
Only Selected.....	6
Apply.....	6
Apply Pose as Rest Pose.....	6
Apply Selected as Rest Pose.....	6
Last Operator Apply Pose as Rest Pose.....	6
Selected only.....	6
Apply Visual Transform to Pose.....	6
Assign Custom Property Values as Default.....	6
Last Operator Assign Custom Property Values as Default.....	6
Process data properties.....	6
Process bone properties.....	6
Snap.....	6
Last Operator Snap.....	7
Offset.....	7
Animation.....	7
Insert Keyframe.....	7
Delete Keyframes.....	7
Clear Keyframes.....	7
Change Keying Set.....	7
In-Between.....	7
In Between.....	7
Header values.....	8
Footer hotkey display.....	8
Push Pose from Rest Pose.....	8
Last Operator Push Pose from Rest Pose.....	8
Percentage.....	8
Previous Keyframe.....	8
Next Keyframe.....	8
Channels.....	8
Axis Lock.....	8
Relax Pose to Rest Pose.....	9
Last Operator Relax Pose to Rest Pose.....	9
Percentage.....	9
Previous Keyframe.....	9
Next Keyframe.....	9
Channels.....	9
Axis Lock.....	9
Push Pose from Breakdown.....	9
Last Operator Push Pose.....	9
Percentage.....	9
Previous Keyframe.....	9
Next Keyframe.....	9
Channels.....	9
Axis Lock.....	10

Relax Pose to Breakdown.....	10
Last Operator Relax Pose to Breakdown.....	10
Percentage.....	10
Previous Keyframe.....	10
Next Keyframe.....	10
Channels.....	10
Axis Lock.....	10
Pose Breakdowner.....	10
Last Operator Pose Breakdowner.....	10
Percentage.....	10
Previous Keyframe.....	11
Next Keyframe.....	11
Channels.....	11
Axis Lock.....	11
Blend to Neighbour.....	11
Last Operator Blend to Neighbour.....	11
Factor.....	11
Previous Keyframe.....	11
Next Keyframe.....	11
Channels.....	11
Axis Lock.....	12
Propagate.....	12
Last Operator Propagate Pose.....	12
Terminate Mode.....	12
While Held.....	12
To Next Keyframe.....	12
To Last Keyframe.....	13
Before Frame.....	13
Before Last Keyframe.....	13
On Selected Keyframes.....	13
On Selected Markers.....	13
End Frame.....	13
Single Operators.....	13
Copy Pose.....	13
Paste Pose.....	13
Paste Pose Flipped.....	13
Last Operator Paste Pose.....	13
Flipped on X Axis.....	13
On Selected Only.....	13
Motion Paths.....	14
Calculate.....	14
Last Operator Calculate Object Path.....	14
Start.....	14
End.....	14
Bake Location.....	14
Clear.....	14
Update Armature Motion Paths.....	14
Update All Motion Paths.....	14
Bone Groups.....	14
Assign to New Group.....	15
Assign to Group.....	15
Last operator Add Selected to Bone Group.....	15
Bone Group Index.....	15

- Remove selected from Bone Groups.....15
- Remove Bone Group.....15
- Parent.....15
- Inverse Kinematics.....16
 - Add IK to Bone.....16
 - Last Operator Add IK to Bone.....17
 - With Targets.....17
 - Remove IK.....17
- Constraints.....17
 - Add (With Targets).....17
 - Copy Constraints to selected Bones.....18
 - Clear Pose Constraints.....18
- Names.....18
 - Autoname Left/Right.....18
 - Autoname Front/Back.....18
 - Autoname Top/Bottom.....18
 - Last operator Autoname by Axis.....18
 - Axis.....18
 - Flip Names.....19
 - Last operator Flip Names.....19
 - Strip Numbers.....19
- Flip Quats.....19
- Change Armature Layers.....19
 - Last Operator Change Armature Layers.....19
 - Layer.....19
- Change Bone Layers.....19
 - Last Operator Change Bone Layers.....20
 - Layer.....20
- Show/Hide.....20
 - Show Hidden.....20
 - Hide Selected.....20
 - Hide Unselected.....20
- Bone Settings.....20
 - Last Operator Collection Boolean Set.....20

Pose Mode - Pose Menu

The Pose menu contains the tools to work with Armature objects in Pose mode. This means here you find all the tools that you need to pose and animate your armature.

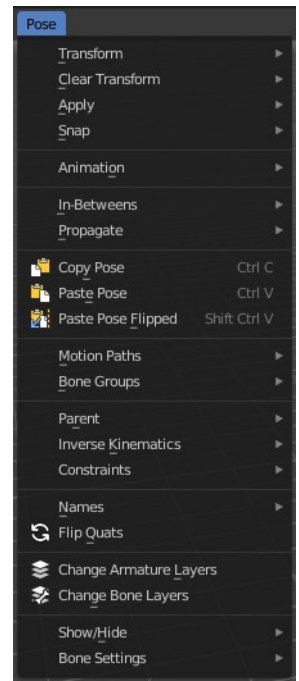

Clear Transform

Clear Transform

Clear transform is a menu with some Clear functionality. You need to have the bones selected where you want to perform the operation. Unselected bones will not be calculated.

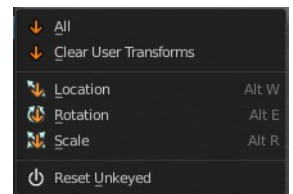

All

Resets location, rotation and scale back to the Rest pose.

Clear User Transforms

Resets Pose of selected bones back to keyframe state.

Location

Resets location back to the Rest pose.

Rotation

Resets rotation back to the Rest pose.

Scale

Resets scale back to the Rest pose.

Reset Unkeyed

Resets the pose for the selected bones back to the state of the latest keyframe.

Last Operator Clear User Transforms

Only Selected

Clear User transform for selected armature part, or for the whole armature.

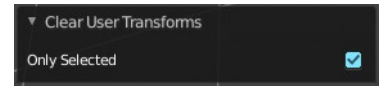

Apply

Apply is a menu with some Apply functionality.

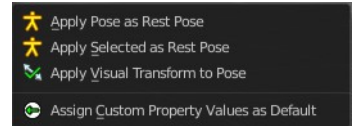

Apply Pose as Rest Pose

You need a rest pose where you can reset the pose back to. With this tool you can set the current pose to be the new Rest pose.

Apply Selected as Rest Pose

You need a rest pose where you can reset the pose back to. With this tool you can set the current pose of the selected bones to be the new Rest pose.

Last Operator Apply Pose as Rest Pose

Selected only

Just apply the pose to the selected part.

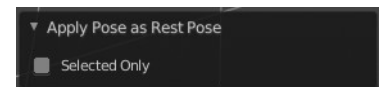

Apply Visual Transform to Pose

Apply final constrained position of posed bones to their transform.

Assign Custom Property Values as Default

Assigns the current values of custom properties as their defaults. This allows to use them as part of the rest pose state in NLA track mixing.

Last Operator Assign Custom Property Values as Default

Process data properties

Include the process data properties.

Process bone properties

Include the process bone properties.



Snap

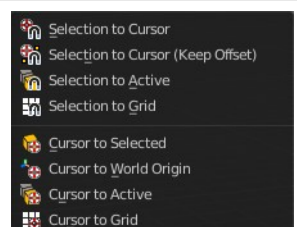

Choose several methods to snap one element to another. The menu items should be self explaining.

Last Operator Snap

Some snap operations shows a last operation panel, some not.

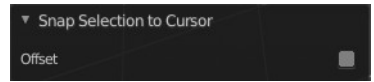

Offset

If the selection should snap as a whole, or if each individual element of the selection should snap.

Animation

Animation is a sub menu around animation functionality. You need to have an object in the scene.



Insert Keyframe

Opens a menu where you can insert a keyframe with a defined keying set.

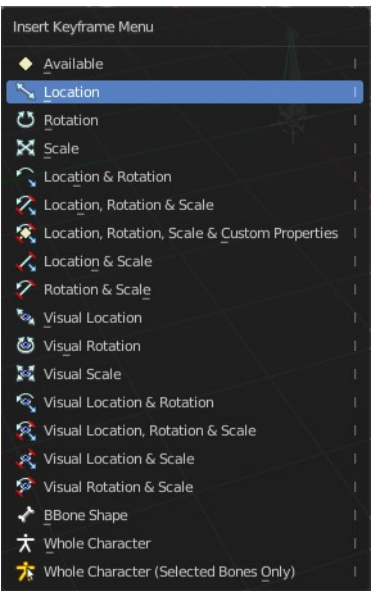

Delete Keyframes

Deletes keyframes at the current frame.

Clear Keyframes

Deletes all keyframes.

Change Keying Set

Opens a menu where you can change the keying set. It is basically the same than the insert keyframe menu.

In-Between

In Between

In Between are tools to influence the look of the pose between the keyframes.

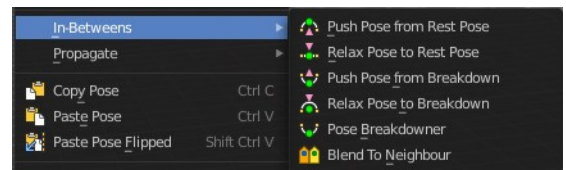

For example, record a keyframe at frame 1, then record a keyframe at frame 20. Then go to frame 10, and activate one of the tools. Now you can play around with the settings. And when you are satisfied with the result then you can record a keyframe at this position.

Header values

When you activate one of the tools, then you will see a percentage slider in the header. This slider is not interactive. It just displays the percentage of the exaggeration.



Footer hotkey display

In the footer you will see some hotkeys for further options. These hotkeys are hard coded, and cannot be changed in the input manager.

Breakdown: W/E/R/B/C - Limit to Transform/Property Set | S - Enable overshoot | Shift - Hold for precision | Ctrl - Hold for 10% increments | [H] - Toggle bone visibility

The hotkeys W, E and R stands for the usual transform modes move, rotate or scale. Hotkey B stands for Bendy Bones. And C is for a custom property.

Overshoot allows you to go over the 0 -100 per cent range. The header values shows a bigger range then.



The rest of the hotkeys should be self explaining.

Push Pose from Rest Pose

Exaggerates the current pose. Pushes the current pose further away from the rest pose.

Last Operator Push Pose from Rest Pose

Percentage

The percentage of exaggeration.

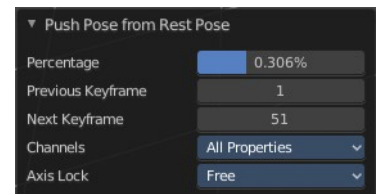

Previous Keyframe

The keyframe position before the current frame.

Next Keyframe

The keyframe position after the current frame.

Channels

Limit the push effect to specific channels.

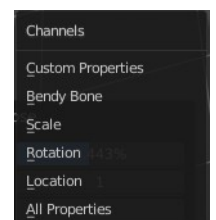

Axis Lock

Limit the push effect to specific axis.

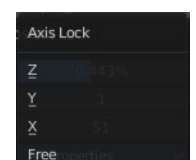

Relax Pose to Rest Pose

Relaxes the current pose towards the Rest pose.

Last Operator Relax Pose to Rest Pose

Percentage

The percentage of relaxing.

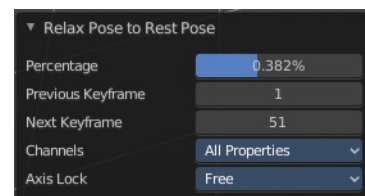

Previous Keyframe

The keyframe position before the current frame.

Next Keyframe

The keyframe position after the current frame.

Channels

Limit the relax effect to specific channels.

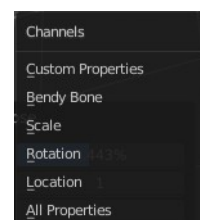

Axis Lock

Limit the relax effect to specific axis.

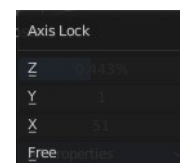

Push Pose from Breakdown

Exaggerates the current pose. Pushes the current pose further away from the previous pose.

Last Operator Push Pose

Percentage

The percentage of exaggeration.

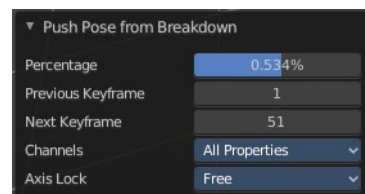

Previous Keyframe

The keyframe position before the current frame.

Next Keyframe

The keyframe position after the current frame.

Channels

Limit the push effect to specific channels.

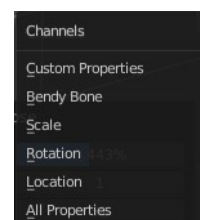

Axis Lock

Limit the push effect to specific axis.

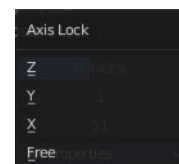

Relax Pose to Breakdown

Relaxes the current pose.

Last Operator Relax Pose to Breakdown

Percentage

The percentage of relaxing.

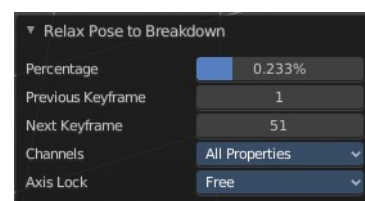

Previous Keyframe

The keyframe position before the current frame.

Next Keyframe

The keyframe position after the current frame.

Channels

Limit the relax effect to specific channels.

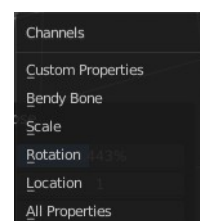

Axis Lock

Limit the relax effect to specific axis.

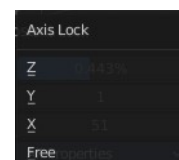

Pose Breakdowner

Creates a suitable breakdowner pose on the current frame.

Last Operator Pose Breakdowner

Percentage

The percentage of exaggeration.

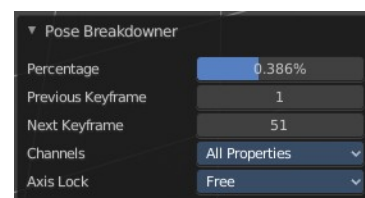

Previous Keyframe

The keyframe position before the current frame.

Next Keyframe

The keyframe position after the current frame.

Channels

Limit the breakdownner pose to specific channels.

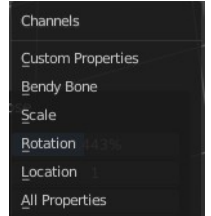

Axis Lock

Limit the breakdownner pose to specific axis.

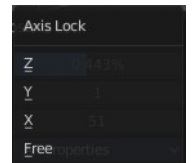

Blend to Neighbour

Blends the current pose with the neighbouring poses.

When you perform the tool then you will see a per cent slider in the header where you can read the percentual influence of the blending. Move the mouse to position the blend pose where you need it.



Last Operator Blend to Neighbour



Factor

The blend factor.

Previous Keyframe

The keyframe to calculate from before the current position.

Next Keyframe

The keyframe to calculate from after the current position.

Channels

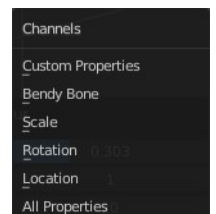

Axis Lock

Lock the transformation along an axis.

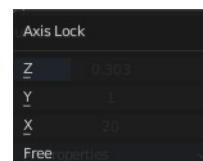

Propagate

The Propagate tool automates the process of copying and pasting between keyframes. It copies the pose of the selected bones on the current frame over to the keyframes by the chosen Termination mode in the Last Operator Propagate Pose.

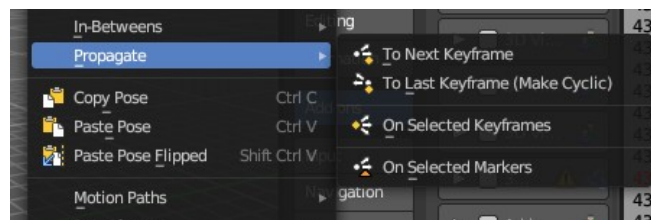

The different Propagate methods can be adjusted in the Last operator too. Here you will find even more methods. The menu just lists the common ones.

The methods are quite self explaining, but are explained in the last operator section.

Usage example with Termination mode "On Selected Keyframes".

1. Create a little armature.
2. Set a keyframe at frame 0.
3. Set a keyframe at frame 20.
4. Pose frame 20.
5. Set a keyframe at frame 40. It will most probably be identical with Frame 20.
6. Now select those Keyframes at position 40 in the Dope Sheet Editor.
7. Set position to Frame 0.
8. Press Propagate, and in the Last operator Propagate Pose choose On Selected Keyframes.
The selected keyframes at frame 40 will now turn into the corresponding keyframes from position 0.

Last Operator Propagate Pose

Terminate Mode

A drop down box where you can choose between different termination modes for Propagate.

To Next Keyframe

Copies the pose to the first keyframe after the current frame.

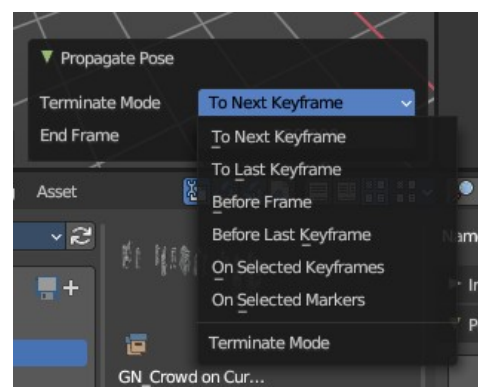

To Last Keyframe

Replaces the last keyframe.

Before Frame

Copies to all keyframes between current frame and the End frame option.

Before Last Keyframe

To all keyframes from current frame until no more are found.

On Selected Keyframes

Applies the pose of the selected bones to all selected keyframes.

On Selected Markers

Copies to all keyframes on frames with Scene Markers after the current frame.

End Frame

Defines the end frame for the Propagate.

Single Operators

Copy Pose

Copies the current pose. You copy what you have selected.



Paste Pose

Pastes a previous copied pose.

Paste Pose Flipped

Pastes a previous copied pose, but flipped along X axis.

Last Operator Paste Pose

Flipped on X Axis

Paste the pose flipped along X Axis.

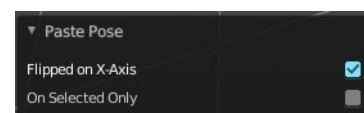

On Selected Only

Paste just on the selected bones. Not on the unselected.

Motion Paths

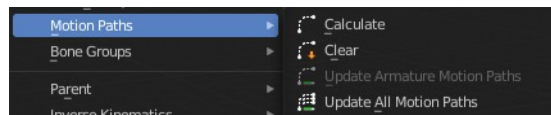

Objects can be animated. Let's say you send them from a to b to c. The object will move to b, then to c. Some kind of a path. This path is not visible by default.

With motion paths you can calculate this path, and make it visible.

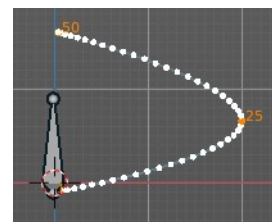

Calculate

Calculates the motion path of the selected object. It opens a panel to define the start and end frame of the calculation.

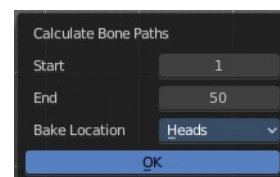

Last Operator Calculate Object Path

Start

Defines the start frame of the calculation.

End

Defines the end frame of the calculation.

Bake Location

Where to draw the curve. At the head or at the tail of the bone(s)

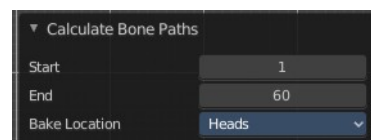

Clear

Clear remove the motion path from the object.

Update Armature Motion Paths

Updates the motion paths of the armature.

Update All Motion Paths

Updates the motion paths of all objects.

Bone Groups

Bone Groups is a menu to handle bone group functionality from within a menu in the 3D view. The bone groups themselves can be found in the Properties editor.

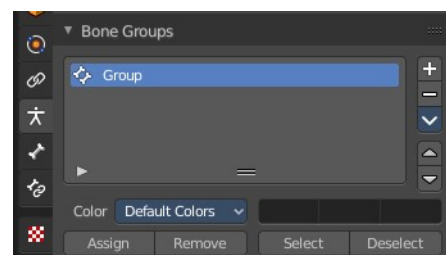
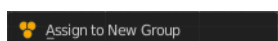

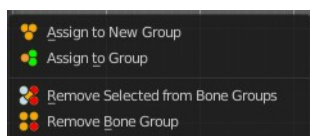

Assign to New Group

Assigns the selected bone(s) to a new group.

Assign to Group

Assigns the selected bone(s) to an existing group.

Last operator Add Selected to Bone Group

This last operator belongs to both tools. Assign to New Group, and Assign to Group.

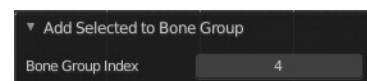

Bone Group Index

Adjust the Bone Group Index. An Index of 0 creates a new bone group. Higher values tries to assign the bone to existing bone groups instead.

Remove selected from Bone Groups

Removes the selected bone(s) from the assigned bone groups.

Remove Bone Group

Removes the currently active bone group.

Parent

Parenting the skin or other armatures happens in Object mode. You can also parent in Pose Mode. It just does not make much sense since you need to enter Object mode for one of the objects anyways. The only somehow relevant settings in the parenting menu here is clear parent. But even this is better done in Object Mode.

The parenting menu is already explained in the Object menu in Object mode. So we won't repeat the whole description here.

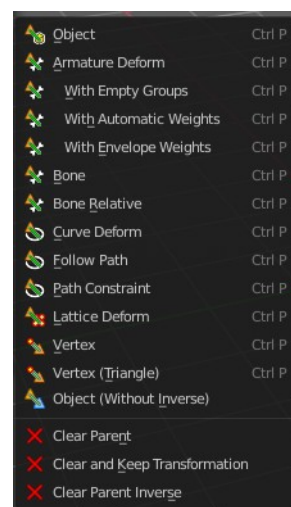

Inverse Kinematics

Inverse Kinematics is a menu with two isolated items from the whole bone constraints menu. The Inverse Kinematics. You could also add an Inverse Kinematics bone constraint by the Constraints / Add (With Targets) menu item from above. It is in the list. But this menu allows quick access without big search.

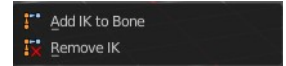

Add IK to Bone

Add IK to bone adds an IK bone constraint to the selected bone. When you add an IK constraints with just the bone selected, then it adds an empty as a handler too, and fills it in as a target.

Add IK calls a popup. When you have just one bone selected then you can choose between adding an empty as the target or to create the bone constraint without target.

When you have more than one bone selected then you can just add the constraint to the active bone.

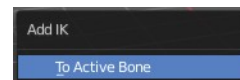
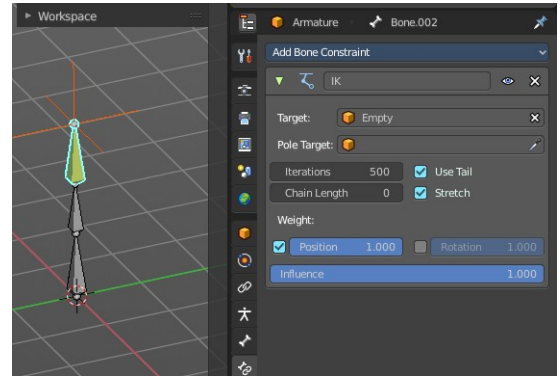

You can define an own target object too. The armature needs to be in pose mode. Let's create a cube or another primitive. Select it. Now hold down Shift, and click at the bone where you want to add the constraint too. Then choose Add (with Targets), and choose your constraint method. The cube will now be chosen as the target object.

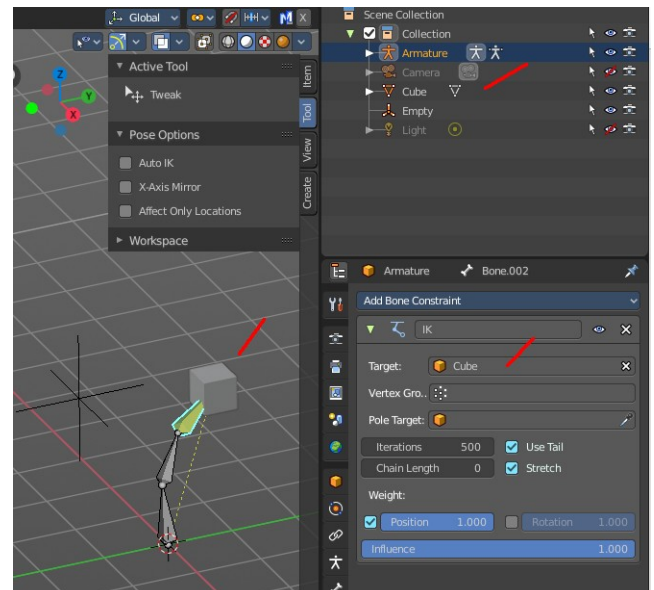

Last Operator Add IK to Bone

With Targets

Define if you want to add the IK constraints with or without a target.



Remove IK

Removes all IK bone constraint(s) at the selected bone(s).

Constraints

Constraints is a menu that contains some tools around constraints.

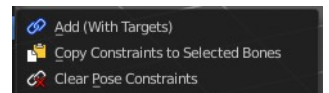

Add (With Targets)

Add (With Targets) calls the Constraints menu where you can choose the constraint that you want to add. When you add an IK constraints with just the bone selected, then it adds an empty as a handler too, and fills it in as a target. Which is similar to what you can do with the Add IK to Bone from the IK menu.

But you can add more than just the IK constraint. It is the same menu that you can open by clicking at the Add Bone Constraint drop down menu in the Properties editor.

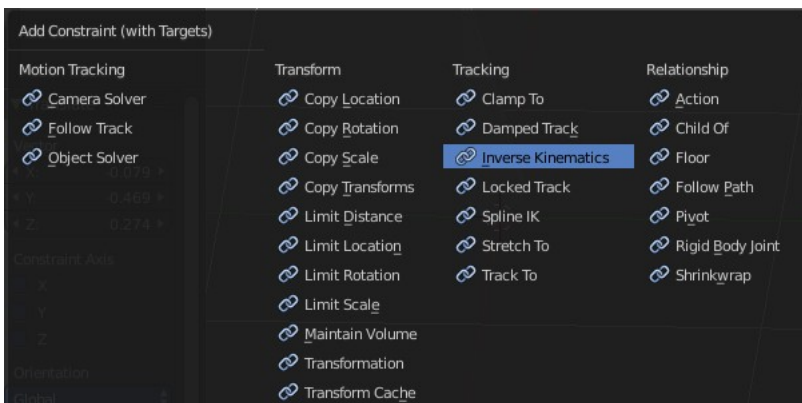
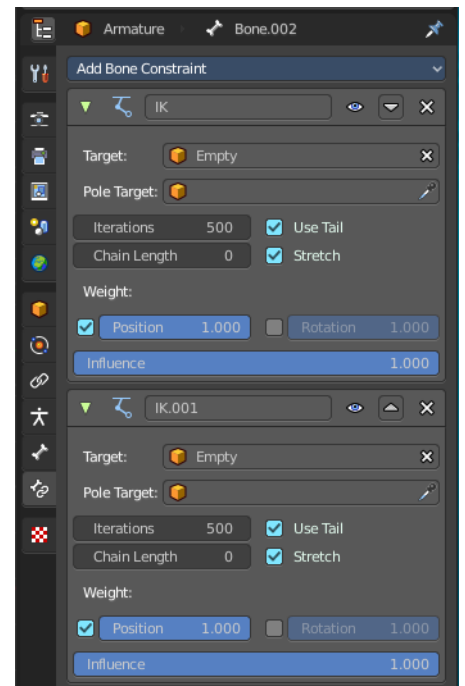

You can define an own target object too. The armature needs to be in pose mode. Let's create a cube or another primitive. Select it. Now hold down Shift, and click at the bone where you want to add the constraint too. Then choose Add (with Targets), and choose your constraint method. The cube will now be chosen

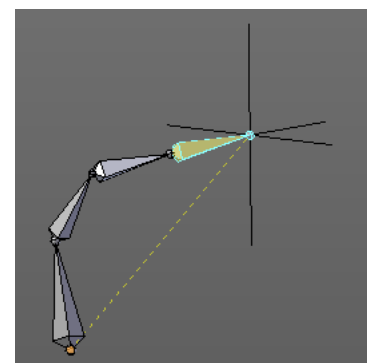

as the target object.

Copy Constraints to selected Bones

Copies the constraints with all its settings to the selected bone.

Usage:

Select the bone where you want to copy the constraints to. Hold down shift, then select the bone that contains the constraints. Then perform the tool. The constraints will be copied.

Clear Pose Constraints

Removes all bone constraints modifiers from the bone.

Names

Bforartists has some internal name conventions for a symmetrical armature. Bones are for example named mybone.L or mybone.R, dependant at which side of the mirror axis they are. The Names items allows you to rename the bone names to this name convention.

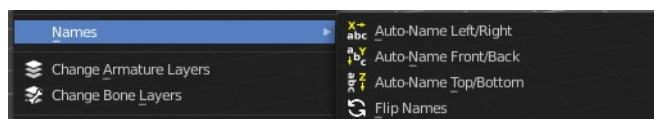

Autoname Left/Right

Renames the bones from left to right.

Autoname Front/Back

Renames the bones from front to back.

Autoname Top/Bottom

Renames the bones from top to bottom.

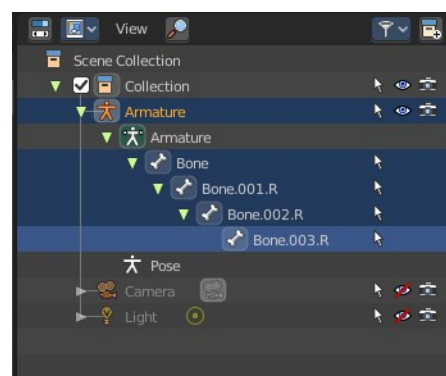
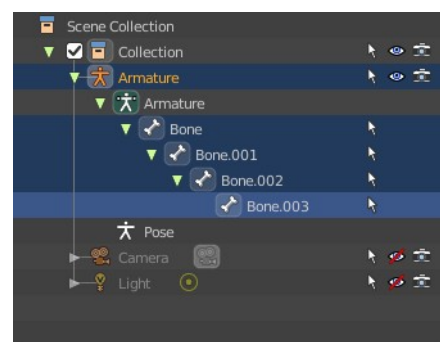

Last operator Autoname by Axis

Axis

Choose the autoname axis again. Left/Right is X axis, Front/Back is Y axis, and Top/Bottom is Z axis.

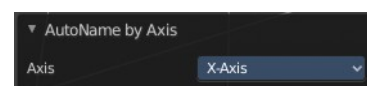

Flip Names

When you mirror a half of an armature you end in names like Bone.001.R.001. But what we need is Bone.001.L for a symmetrical armature. Flip names flips the names to follow the left right name conventions.

Last operator Flip Names

Strip Numbers

Tries to remove the numbers in the names if possible.



Flip Quats

This feature flips the quaternion rotation values of the currently selected bone(s). Positive values becomes negative, and negative values becomes positive.

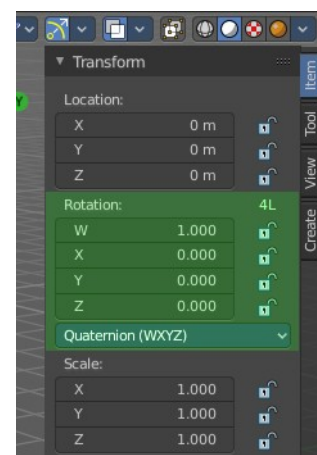

Change Armature Layers

Armature and bones has its own layer system. This menu item opens a popup where you can put the whole armature onto another layer.



Last Operator Change Armature Layers

Layer

Put the armature onto another layer.



Change Bone Layers

Armature and bones has its own layer system. This menu item opens a popup where you can put single selected bone(s) onto another layer.

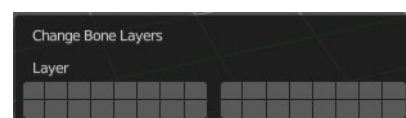

Last Operator Change Bone Layers

Layer

Put the selected bones onto another layer.

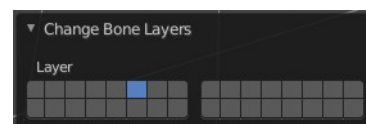

Show/Hide

Show or hide the selected geometry

Show Hidden

Makes all hidden geometry visible again.

Hide Selected

Hides the selected geometry.

Hide Unselected

Hides the not selected geometry. The selected geometry stays visible.

Bone Settings

Bone Settings is a menu with menu items to toggle special check boxes in the Properties editor. But here you can do it for a selection too, and not just one object.

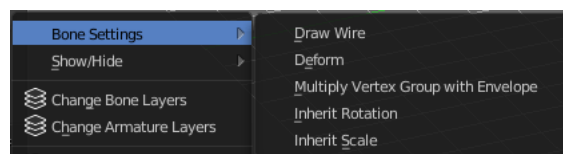

Last Operator Collection Boolean Set

Each of the menu items uses the same Last Operator. With different strings for the booleans.

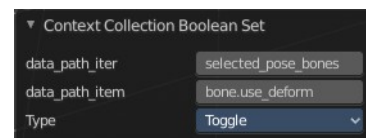



7.1.4 Editors - 3D Viewport - Header - Navigation Menu

Table of content

All Modes - Navigation Menu.....	2
Legacy.....	2
Move.....	3
Snapping.....	3
Precision movement.....	3
Header Values.....	3
Numerical Input.....	3
Limit Axis.....	3
Orientation.....	3
Last Operator Move.....	4
Move X, Y Z.....	4
Orientation.....	4
Proportional editing.....	4
Proportional Falloff.....	4
Proportional Size.....	4
Connected.....	4
Projected(2D).....	4
Rotate.....	4
Snapping.....	4
Precision rotation.....	5
Header Values.....	5
Numerical Input.....	5
Limit Axis.....	5
Orientation.....	5
Last Operator Rotate.....	5
Angle.....	5
Axis.....	5
Orientation.....	6
Proportional editing.....	6
Proportional Falloff.....	6
Proportional Size.....	6
Connected.....	6
Projected(2D).....	6
Scale.....	6
Snapping.....	6
Precision Scale.....	6
Header Values.....	6
Numerical Input.....	6
Limit Axis.....	7
Orientation.....	7
Last Operator Resize.....	7
Angle.....	7
Axis.....	7
Orientation.....	7
Proportional editing.....	7
Proportional Falloff.....	8
Proportional Size.....	8

Connected.....	8
Projected(2D).....	8
Orbit Down.....	8
Orbit Up.....	8
Orbit Right.....	8
Orbit Left.....	8
Orbit Opposite.....	8
Roll Left.....	8
Roll Right.....	8
Pan Down.....	9
Pan Up.....	9
Pan Right.....	9
Pan Left.....	9
Zoom Region.....	9
Zoom In.....	9
Zoom Out.....	9
Zoom Camera 1:1.....	9
Dolly View.....	9
Center View to Mouse.....	9
Fly Navigation.....	9
Walk Navigation.....	10
View Navigation.....	10
Playback Animation.....	10

All Modes - Navigation Menu

The Navigation menu provides you with all tools around viewport navigation. It is available in all modes.

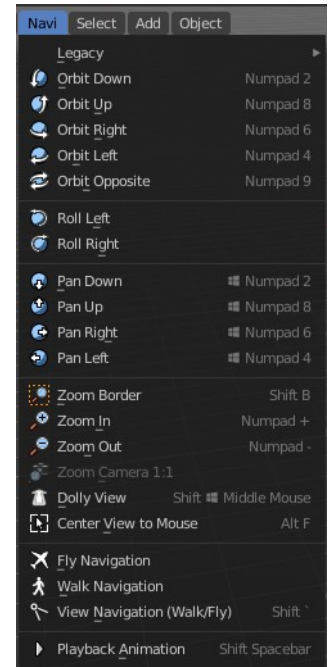

Legacy

The legacy menu contains operators from the old tool system that already exists in the tool shelf and uses the new tool system.

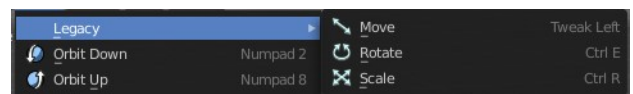

Move

Activates the old move tool. The old move tool does not show a widget!

Note that the hotkey for this tool is not displayed correctly. But can't be fixed by us. The hotkey is ctrl W

Snapping

Holding down Ctrl activates temporary global snapping.

Precision movement

When you hold down shift, then you will have a much slower but also much preciser movement.

Header Values

When you move your object then you will see some values in the header, which defines the current position of the object.



The value m stands for the default metric system. Meters. You can change the units in the Properties editor in the Scene properties in the Units panel. When you choose kilometers here then you will see a km instead m.

The value D stands for the distance of the current selected axis. This can also be two axis. Then you have two d values. The value in the brackets is then the direct distance to the starting point.



These values are always relative to the starting point. You always start with zero, regardless of the real world position.

Numerical Input

When you move the object, and hold down the mouse and type in a value, like 20, then the movement will be performed by the value that you have typed in. In this case by 20 units in direction of the selected axis.

Limit Axis

When you want to rotate a specific axis, then press X or Y or Z to limit the rotation to this axis. You usually start in global orientation. But you can change this in the Orientation settings.



By holding down the mouse button and pressing the X, Y or Z key twice you can toggle this to local. But also to other orientations. This depends in what orientation you start. With normal you can toggle that way between Normal and global.

This can be combined with the numerical input. Type in X, type in X again to use the local space, type in 20 to move by 20 units in local orientation. Release the mouse to confirm.

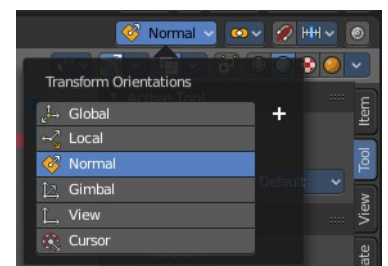

Orientation

The widget can have different orientations. The menu items should be self explaining.

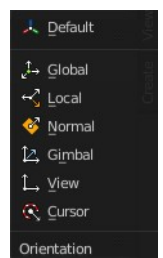

Last Operator Move

Move X, Y Z

The position. Attention, the actual world orientation and rotation does not matter here. It always starts with a value of zero, and moves relative to this zero then. For the actual location values have a look in the sidebar in the transform panel.

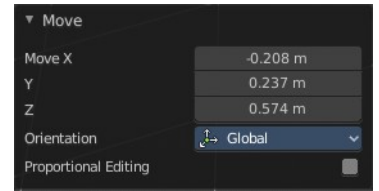

Orientation

The widget can have different orientations. The menu items should be self explaining.

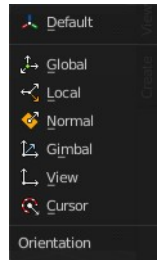

Proportional editing

Enables proportional editing. Activating proportional editing reveals further settings.

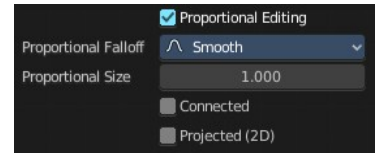

Proportional Falloff

Adjust the falloff methods.

Proportional Size

See and adjust the falloff radius.

Connected

The proportional falloff gets calculated for connected parts only.

Projected(2D)

The proportional falloff gets calculated in the screen space. Depth doesn't play a role. When it's in the radius, then it gets calculated.

Rotate

Activates the old Rotate tool. This tool has no widget!

Snapping

Holding down Ctrl activates temporary global snapping. It snaps then by 5 degrees steps.

When you use the white circle to rotate, then the widget also shows a division circle around the widget. This divisions shows even finer when

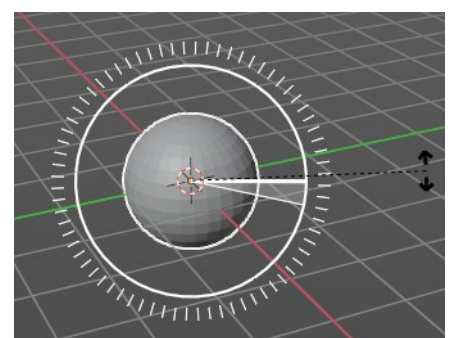

you do precision rotation.

Precision rotation

When you hold down shift, then you will have a much slower but also much preciser rotation.

Header Values

When you rotate your object then you will see some values in the header, which defines the current rotation of the object. The rotation is shown in degrees.



Numerical Input

When you rotate the object, and hold down the mouse and type in a value, like 20, then the rotation will be performed by the value that you have typed in. In this case by 20 degree around the selected axis.

Limit Axis

When you want to rotate a specific axis, then press X or Y or Z to limit the rotation to this axis. You usually start in global orientation. But you can change this in the Orientation settings.

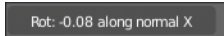

By holding down the mouse button and pressing the X, Y or Z key twice you can toggle this to local. But also to other orientations. This depends in what orientation you start. With normal you can toggle that way between Normal and Global.

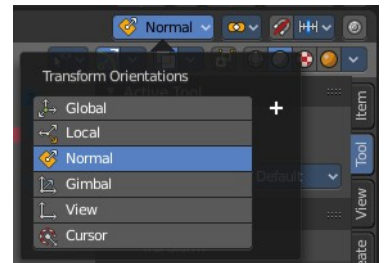

This can be combined with the numerical input. Type in X, type in X again to use the local space, type in 20 to rotate by 20 degree. Release the mouse to confirm.

Orientation

The 3d cursor can have different orientations. The menu items should be self explaining.

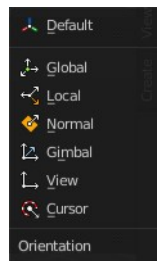

Last Operator Rotate

Angle

The rotation. Attention, the actual world orientation and rotation does not matter here. It always starts with a value of zero, and rotates relative to this zero then. For the actual rotation values have a look in the sidebar in the transform panel.

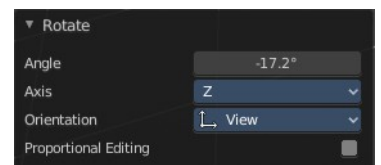

Axis

Which axis to rotate.

Orientation

The widget can have different orientations. The menu items should be self explaining.

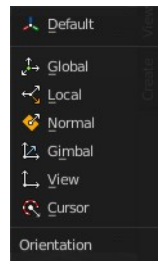

Proportional editing

Enables proportional editing. Activating proportional editing reveals further settings.

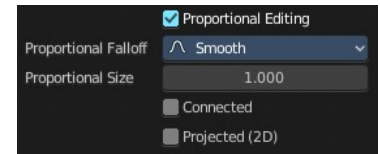

Proportional Falloff

Adjust the falloff methods.

Proportional Size

See and adjust the falloff radius.

Connected

The proportional falloff gets calculated for connected parts only.

Projected(2D)

The proportional falloff gets calculated in the screen space. Depth doesn't play a role. When it's in the radius, then it gets calculated.

Scale

Activates the old Scale tool. This tool has no widget!

Snapping

Holding down Ctrl activates temporary global snapping.

Precision Scale

When you hold down shift, then you will have a much slower but also much preciser scale.

Header Values

When you scale your object then you will see some values in the header, which defines the current scale of the object.



These values are always relative to the starting point. You always start with 1, regardless of the real world scale.

Numerical Input

When you scale the object, and hold down the mouse and type in a value, like 20, then the scale will be performed by the value that you have typed in. In this case by factor 20 along the selected axis.

Limit Axis

When you want to rotate a specific axis, then press X or Y or Z to limit the scale to this axis. You usually start in global orientation. But you can change this in the Orientation settings.

Rot: -0.08 along normal X

By holding down the mouse button and pressing the X, Y or Z key twice you can toggle this to local. But also to other orientations. This depends in what orientation you start. With normal you can toggle that way between Normal and Global.

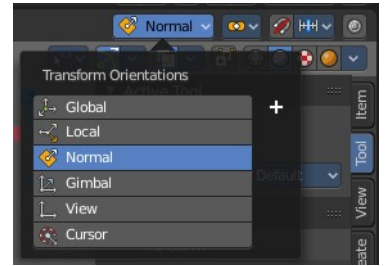

This can be combined with the numerical input. Hold down mouse, type in X, type in X again to use the local space, type in 20 to scale by 20 units. Release the mouse to confirm.

Orientation

The 3d cursor can have different orientations. The menu items should be self explaining.

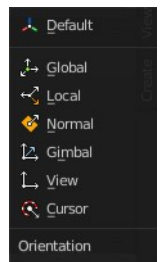

Last Operator Resize

Angle

The rotation. Attention, the actual world orientation and rotation does not matter here. It always starts with a value of zero, and rotates relative to this zero then. For the actual rotation values have a look in the sidebar in the transform panel.

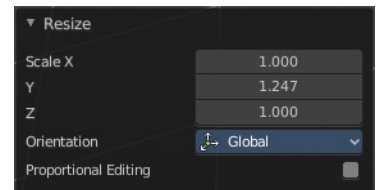

Axis

Which axis to rotate.

Orientation

The widget can have different orientations. The menu items should be self explaining.

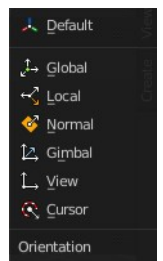

Proportional editing

Enables proportional editing. Activating proportional editing reveals further settings.

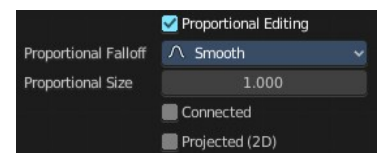

Proportional Falloff

Adjust the falloff methods.

Proportional Size

See and adjust the falloff radius.

Connected

The proportional falloff gets calculated for connected parts only.

Projected(2D)

The proportional falloff gets calculated in the screen space. Depth doesn't play a role. When it's in the radius, then it gets calculated.

Orbit Down

Orbits downwards.

Orbit Up

Orbits upwards.

Orbit Right

Orbits to the right.

Orbit Left

Orbits to the left.

Orbit Opposite

Rotates the view by 180 degree.

Roll Left

Rolls the viewport counter clockwise.

Roll Right

Rolls the viewport clockwise.

Pan Down

Pans the viewpoint downwards. The scene moves up.

Pan Up

Pans the viewpoint upwards. The scene moves down.

Pan Right

Pans the viewpoint to the right. The scene moves to the left.

Pan Left

Pans the viewpoint to the left. The scene moves to the right.

Zoom Region

Draws a rectangle and zooms then to fit the size of this rectangle.

Zooming in is done with drawing the rectangle with left mouse button. Zooming out is done with drawing the rectangle with middle mouse button.

Zoom In

Zooms into the viewport. Works also in camera view.

Zoom Out

Zooms out of the viewport. Works also in camera view.

Zoom Camera 1:1

Zooms the camera fitting to match the render output size by factor 1:1

Dolly View

Dolly View is a special zoom mode.

Be careful with this navigation method, you can easily trap yourself to not zoom able anymore!

Center View to Mouse

Centers the view to the current mouse position.

Fly Navigation

Switches to Fly navigation. In this view mode the camera acts like an air plane. Right click leaves the fly mode.

Walk Navigation

Switches to Walk Navigation. In this view mode the camera acts like a player in a first person shooter. Gravity will pull you down, The ground grid is the ground. And you can move around with WASD keys. Right click leaves the walk mode.

View Navigation

Switches to View Navigation Mode. In this view mode the view gets rotated moved and scaled from the Camera view point. Right Click leaves the view mode.

Playback Animation

Plays back an existing animation.



7.1.40 Editors - 3D Viewport - Header - Lattice - Edit mode - Lattice menu

Table of content

Detailed Table of content.....	1
Edit Mode - Lattice Menu.....	4
Transform.....	4
To Sphere.....	4
Shear.....	5
Bend.....	6
Push/Pull.....	6
Warp.....	7
Randomize Transform.....	7
Move Texture Space.....	7
Scale Texture Space.....	9
Set Dimensions.....	10
Mirror.....	10
Interactive Mirror.....	10
X Global, Y Global etc.....	10
Snap.....	11
Last Operator Snap.....	11
Flip.....	12
Last Operator Flip (Distortion Free).....	12
Single Operators.....	12
Make Regular.....	12
Hooks.....	12
Make Vertex Parent.....	13

Detailed Table of content

Detailed table of content

Detailed Table of content.....	1
Edit Mode - Lattice Menu.....	4
Transform.....	4
To Sphere.....	4
Usage.....	4
Last Operator To Sphere Panel.....	4
Factor.....	4
Proportional editing.....	4
Proportional Falloff.....	4
Proportional Size.....	5
Connected.....	5
Projected(2D).....	5
Shear.....	5
Last Operator Shear.....	5
Offset.....	5
Shear Axis.....	5

Axis.....	5
Axis Ortho.....	5
Orientation.....	5
Proportional editing.....	5
Proportional Falloff.....	5
Proportional Size.....	6
Connected.....	6
Projected(2D).....	6
Bend.....	6
Push/Pull.....	6
Last Operator Push/Pull.....	6
Factor.....	6
Proportional editing.....	6
Proportional Falloff.....	6
Proportional Size.....	6
Connected.....	6
Projected(2D).....	6
Warp.....	7
Last operator Warp.....	7
Warp Angle.....	7
Offset Angle.....	7
Min.....	7
Max.....	7
Randomize Transform.....	7
Last Operator Randomize Transform.....	7
Amount.....	7
Uniform.....	7
Normal.....	7
Random Seed.....	7
Move Texture Space.....	7
Last Operator Translate.....	8
Move X, Y Z.....	8
Orientation.....	8
Proportional editing.....	8
Proportional Falloff.....	8
Proportional Size.....	8
Connected.....	8
Projected(2D).....	8
Scale Texture Space.....	9
Last Operator Resize Texture.....	9
Move X, Y Z.....	9
Orientation.....	9
Proportional editing.....	9
Proportional Falloff.....	9
Proportional Size.....	9
Connected.....	9
Projected(2D).....	10
Set Dimensions.....	10
Last Operator Set Dimensions.....	10
New Dimensions.....	10
Mirror.....	10
Interactive Mirror.....	10
X Global, Y Global etc.....	10

Last Operator Mirror.....	11
Orientation.....	11
Constraint Axis.....	11
Proportional editing.....	11
Proportional Falloff.....	11
Proportional Size.....	11
Connected.....	11
Projected(2D).....	11
Snap.....	11
Last Operator Snap.....	11
Offset.....	11
Flip.....	12
Last Operator Flip (Distortion Free).....	12
Flip Axis.....	12
Single Operators.....	12
Make Regular.....	12
Hooks.....	12
Hook to New Object.....	12
Hook to Selected Object.....	12
Last Operator Hook to Selected Object.....	13
Active Bone.....	13
Hook to Selected Object Bone.....	13
Assign to Hook.....	13
Remove Hook.....	13
Select Hook.....	13
Reset Hook.....	13
Recenter Hook.....	13
Make Vertex Parent.....	13

Edit Mode - Lattice Menu

In Edit Mode you will also see a add menu for some object types. The number of objects that you can add is limited to the same object type that you are in edit mode with. You can just add mesh geometry to a mesh geometry. And just curve geometry to curve geometry.

The added objects in edit mode becomes part of the current object geometry.

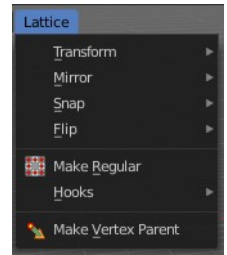

Transform

To Sphere

Shapes a selection of objects into the shape of a sphere. The calculation happens with the object origins.

In Object mode this tool requires to have more than one object selected.

Usage

Select the vertices, activate the tool, then drag the mouse in the 3D viewport. In the header you will read the current factor then. Which tells you how close you are towards the sphere shape.

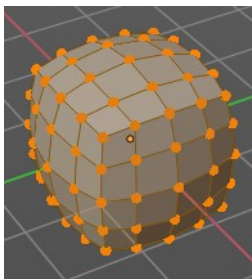
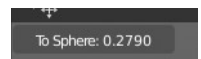
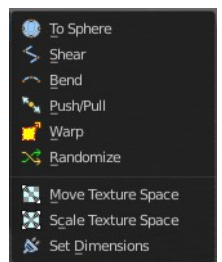
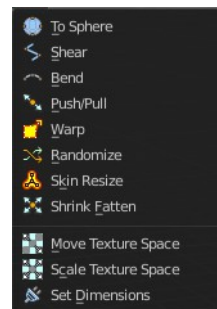

Last Operator To Sphere Panel

Factor

The factor to transform the selection into a sphere form.

Proportional editing

Enables proportional editing. Activating proportional editing reveals further settings.

Proportional Falloff

Adjust the falloff methods.

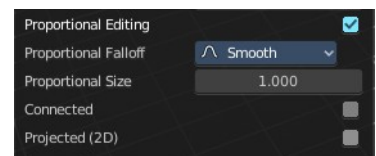
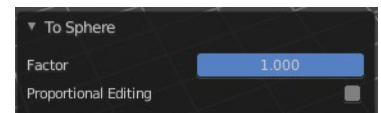

Proportional Size

See and adjust the falloff radius.

Connected

The proportional falloff gets calculated for connected parts only.

Projected(2D)

The proportional falloff gets calculated in the screen space. Depth doesn't play a role. When it's in the radius, then it gets calculated.

Shear

Shear shears the selection.

Last Operator Shear

Offset

Adjust an offset.

Shear Axis

The shear tool works along a imaginary 2d plane. The shear axis controls if the items are sheared along the x or the y axes of this plane. This is the plane along which the transformation happens. You can shear along the x or the y axis of this plane.

To make things even more complicated, the orientation of this imaginary plane is defined by the Axis and Axis Ortho items below.

Axis

Defines one axis of the imaginary shear axis plane.

Axis Ortho

Defines the other axis of the imaginary shear axis plane.

Orientation

Choose the orientation for the shear action.

Proportional editing

Enables proportional editing. Activating proportional editing reveals further settings.

Proportional Falloff

Adjust the falloff methods.

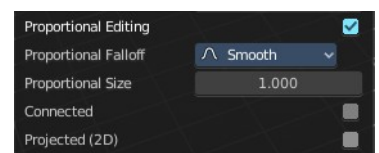
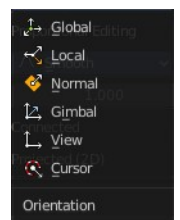
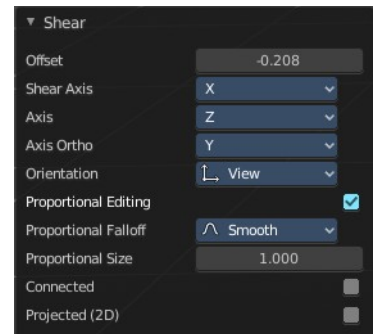

Proportional Size

See and adjust the falloff radius.

Connected

The proportional falloff gets calculated for connected parts only.

Projected(2D)

The proportional falloff gets calculated in the screen space. Depth doesn't play a role. When it's in the radius, then it gets calculated.

Bend

Bends the selection.

Push/Pull

It pushes or pulls the object positions relative to the center of the selection.

In Object mode this tool requires to have more than one object selected.

Last Operator Push/Pull

Factor

Adjust the strength of influence of the tool.

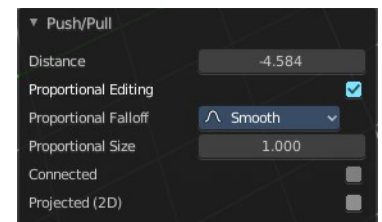

Proportional editing

Enables proportional editing. Activating proportional editing reveals further settings.

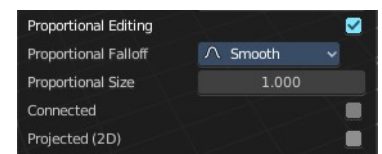

Proportional Falloff

Adjust the falloff methods.

Proportional Size

See and adjust the falloff radius.

Connected

The proportional falloff gets calculated for connected parts only.

Projected(2D)

The proportional falloff gets calculated in the screen space. Depth doesn't play a role. When it's in the radius, then it gets calculated.

Warp

Warp a mesh selection between two defined points.

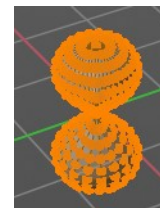

Last operator Warp

Warp Angle

The strength of the warp effect

Offset Angle

An offset angle to bend sideways.

Min

The start point.

Max

The end point.



Randomize Transform

This tool allows randomizes the positions of the selected vertices.

Last Operator Randomize Transform

Amount

Adjust the amount.

Uniform

The uniform offset distance.

Normal

Align the offset direction to the normals.

Random Seed

The seed value for randomization.

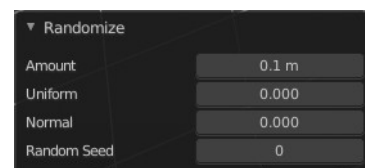

Move Texture Space

This tool relies at the move tool. With the difference that it moves the texture space instead of the object. It has also a very special use case, and just works with a material with a Texture Coordinate / Generated node. And requires to have the shading at Material or Rendered to see a result in the viewport.

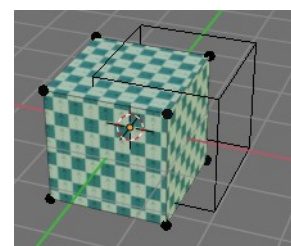

In the viewport you will see the UV cage in black color. In the header you will see the values for the current position of the UV cage.



Note that once done and applied, there is no way to reset the UV cage back to zero. When you repeat the operation, then the values will start at 0 again. Even when the UV cage is already offset.

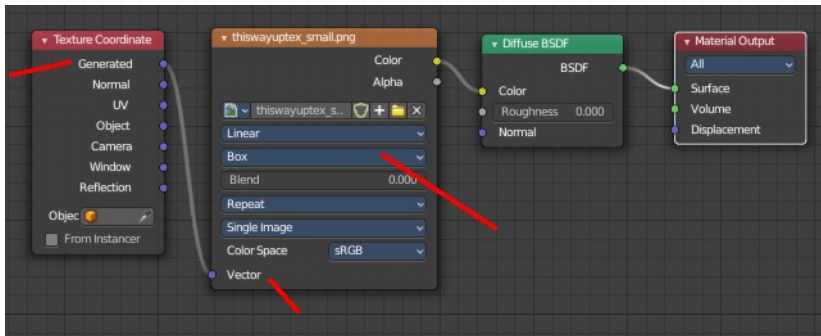

Last Operator Translate

Move X, Y Z

Limit the position relative to the source object.

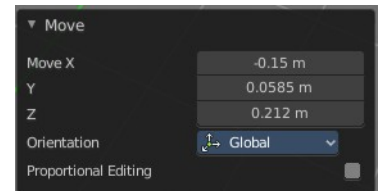

Orientation

Orientation is a drop-down box. Choose the type of orientation for the mirroring action.

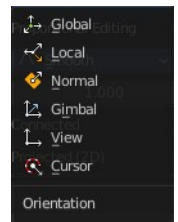

Proportional editing

Enables proportional editing. Activating proportional editing reveals further settings.

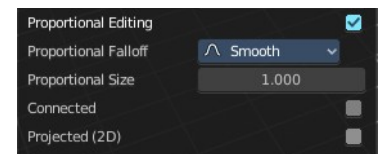

Proportional Falloff

Adjust the falloff methods.

Proportional Size

See and adjust the falloff radius.

Connected

The proportional falloff gets calculated for connected parts only.

Projected(2D)

The proportional falloff gets calculated in the screen space. Depth doesn't play a role. When it's in the radius, then it gets calculated.

Scale Texture Space

This tool relies at the scale tool. With the difference that it scales the texture space instead of the object. It has also a very special use case, and just works with a material with a Texture Coordinate / Generated node. And requires to have the shading at Material or Rendered to see a result in the viewport.

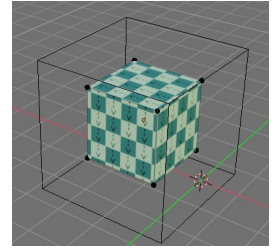
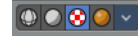

In the viewport you will see the UV cage in black color. In the header you will see the values for the current position of the UV cage.

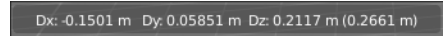

Note that once done and applied, there is no way to reset the UV cage back to zero. When you repeat the operation, then the values will start at 0 again. Even when the UV cage is already offset.

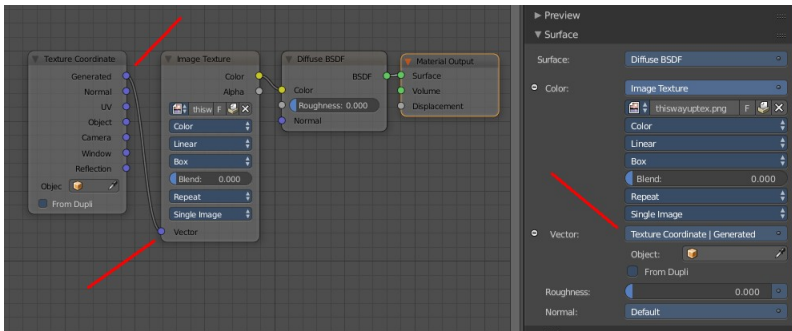

Last Operator Resize Texture

Move X, Y Z

Limit the position relative to the source object.

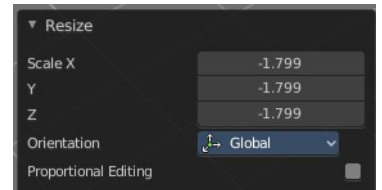

Orientation

Orientation is a drop-down box. Choose the type of orientation for the mirroring action.

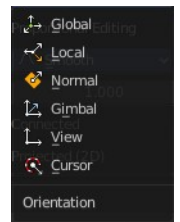

Proportional editing

Enables proportional editing. Activating proportional editing reveals further settings.

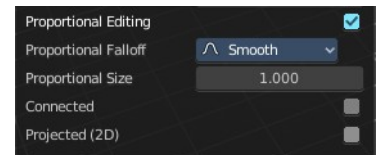

Proportional Falloff

Adjust the falloff methods.

Proportional Size

See and adjust the falloff radius.

Connected

The proportional falloff gets calculated for connected parts only.

Projected(2D)

The proportional falloff gets calculated in the screen space. Depth doesn't play a role. When it's in the radius, then it gets calculated.

Set Dimensions

Edit Mode Only!

Normally all scale operations in Bforartists are relative to the current selection and dimensions. And you always start with a relative value of 1.

Set dimensions allows to scale mesh selections in absolute world values. No matter how the initial values are. The new values gets set in the Last Operator.

Set dimensions is an add-on. You can turn it off in the add-ons section of the user preferences when you want.

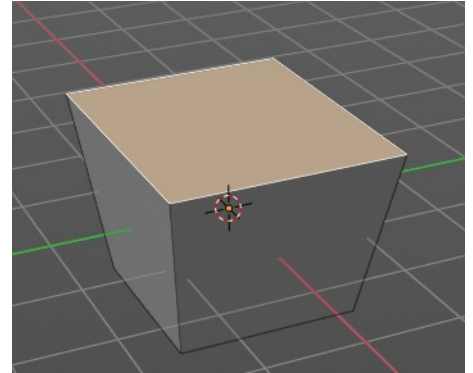

Last Operator Set Dimensions

New Dimensions

When you activate the tool then you will see the world coordinates of the selection. Change the values to other world coordinates.



Mirror

Mirror mirrors the selected geometry along the defined axis.

Interactive Mirror

Mirror by hotkeys. You activate the tool, type in x for x global for example, or x x for x local. And the selection gets mirrored



X Global, Y Global etc.

Mirrors the selection around the chosen axis.

Last Operator Mirror

The Last Operator Mirror panel gives you tools to adjust the mirror action.

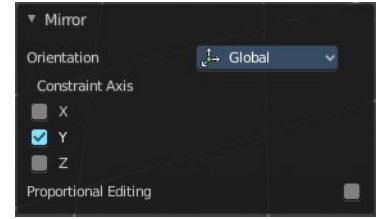

Orientation

Orientation is a drop-down box. Choose the type of orientation for the mirroring action.

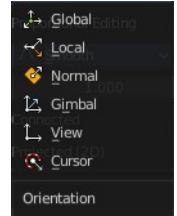

Constraint Axis

Constraint Axis gives you again the possibility to define the mirror axis. You can choose more than one axis here.

Proportional editing

Enables proportional editing. Activating proportional editing reveals further settings.

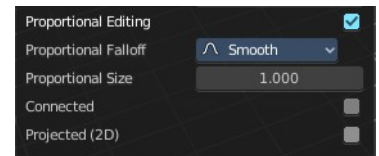

Proportional Falloff

Adjust the falloff methods.

Proportional Size

See and adjust the falloff radius.

Connected

The proportional falloff gets calculated for connected parts only.

Projected(2D)

The proportional falloff gets calculated in the screen space. Depth doesn't play a role. When it's in the radius, then it gets calculated.

Snap

Choose several methods to snap one element to another. The menu items should be self explaining.

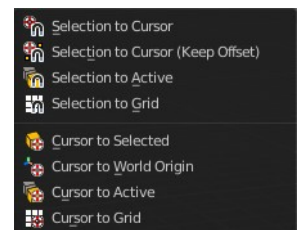

Last Operator Snap

Some snap operations shows a last operation panel, some not.

Offset

If the selection should snap as a whole, or if each individual element of the selection should snap.

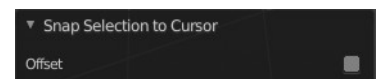

Flip

the lattice object along the world axis X, Y or Z .



Last Operator Flip (Distortion Free)

Flip Axis

Flip the lattice object along the world axis X, Y or Z .



Single Operators

Make Regular

Set the UVW control points by a uniform distance apart.

Hooks

Hooks is a menu with tools around the hook modifier. You could also adjust the hook modifier from the Properties editor. But the menu items are more accessible.

You need to have at least one vertice of the lattice object selected.

When there is no hook modifier at the mesh then you just see three menu items. When there is minimum one hook modifier applied, then you will see an extended menu.

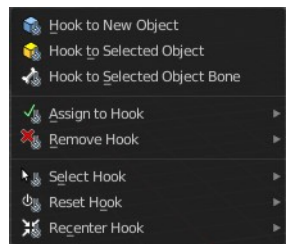
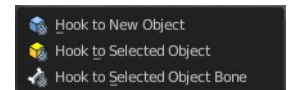
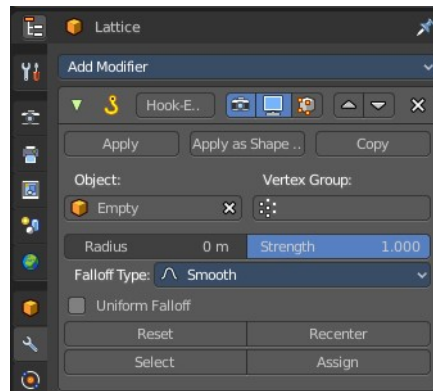

Hook to New Object

Creates a new Hook Modifier for the active object and assigns it to the selected vertices. It also creates an empty at the center of those vertices, which are hooked to it.

Hook to Selected Object

Does the same as *Hook to New Object*, but instead of hooking the vertices to a new empty, it hooks them to the selected object (if it exists). There should be only one selected object (besides the mesh being edited).

Last Operator Hook to Selected Object

Active Bone

Hook to the object(s) of the active bone.

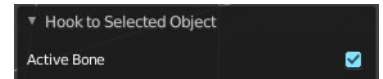

Hook to Selected Object Bone

Does the same as Hook to New Object. But it sets the last selected bone in the also selected armature as a target.

Assign to Hook

Assign the selected vertices to the chosen hook modifier. Existing hooks gets overwritten. One vertex can be assigned to more than one hook.

Remove Hook

Removes the chosen Hook Modifier from the object.

Select Hook

Selects all vertices assigned to the chosen Hook Modifier.

Reset Hook

Resets the chosen Hook Modifier.

Recenter Hook

Recenter the Hook Modifier.

Make Vertex Parent

Parents an object to the selected vertice(s)

In Object mode select the object that you want to parent to a vertex. Shift select the Lattice object so that both are selected. Enter Edit mode. Then select one vertex for a single point. Or three for an area. Then click the Make Vertex Parent button to make the relation.

7.1.41 Editors - 3D Viewport - Header - Particle - Particle mode - Particle menu

Table of content

Particle Mode - Particle Menu.....	1
Mirror.....	1
Remove Doubles.....	2
Unify Length.....	2
Rekey.....	2
Weight Set.....	2
Last Operator Weight Set.....	2
Factor.....	2
Delete.....	2
Show/Hide.....	2
Show Hidden.....	2
Hide Selected.....	3
Hide Unselected.....	3

Particle Mode - Particle Menu

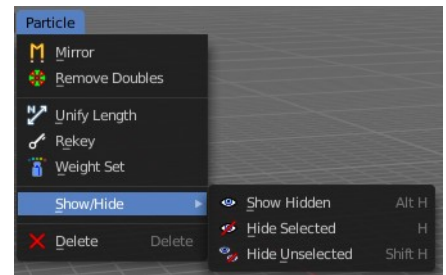

Mirror

Mirrors the selected particles.

If you want a symmetrical haircut, first select all particles, then mirror the particles, then tick X Mirror in the Particle panel.

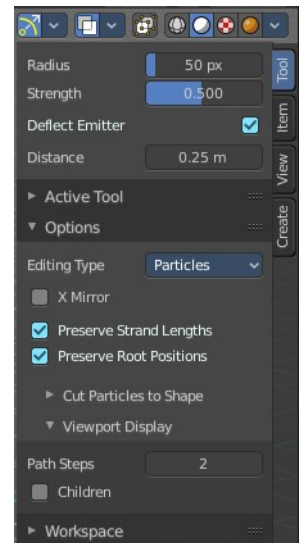

Remove Doubles

Remove double vertices that are very close to each other. This can for example happen when you mirror the particles.

Unify Length

Unifies the length of the selected hair particles. The length is calculated by the average length of the selection.

Rekey

You need to have some hair particles selected.

Rekey changes the number of keys for the selected particles, including root and tip keys. This tool brings up a popup where you can adjust the number of keys. Two means you have only a root and a tip key. Everything more subdivides the selected hair particle with more keys.



Weight Set

Manually set a weight for the selected keys to interpolate between the current key weight and the brushes weight.

Last Operator Weight Set

Factor

The strength of the keys weighting.



Delete

Delete either the whole particle, or just the selected key of the particle.

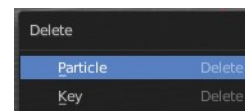

Show/Hide

Show or hide the selected geometry

Show Hidden

Makes all hidden geometry visible again.

Hide Selected

Hides the selected geometry.

Hide Unselected

Hides the not selected geometry. The selected geometry stays visible.

7.1.42 Editors - 3D Viewport - Header - Hair Curve - Edit mode - Curves menu

Table of content

Edit mode - Curves menu.....	1
Transform.....	1
To Sphere.....	1
Usage.....	2
Last Operator To Sphere.....	2
Factor.....	2
Proportional editing.....	2
Proportional Falloff.....	2
Proportional Size.....	2
Connected.....	2
Projected(2D).....	2
Shear.....	2
Last Operator Shear.....	2
Offset.....	2
Axis.....	3
Axis Ortho.....	3
Orientation.....	3
Proportional editing.....	3
Proportional Falloff.....	3
Proportional Size.....	3
Connected.....	3
Projected(2D).....	3
Bend.....	3
Push/Pull.....	3
Last Operator Push/Pull.....	3
Distance.....	3
Mirror Editing.....	4
Proportional editing.....	4
Proportional Falloff.....	4
Proportional Size.....	4
Connected.....	4
Projected(2D).....	4
Delete.....	4

Edit mode - Curves menu

Transform

To Sphere

Shapes a selection of objects into the shape of a sphere. The calculation happens with the object origins.

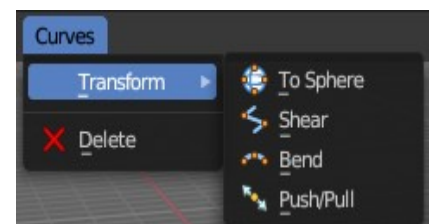

In Object mode this tool requires to have more than one object selected.

Usage

Select the objects, activate the tool, then drag the mouse in the 3D viewport. In the header you will read the current factor then. Which tells you how close you are towards the sphere shape.

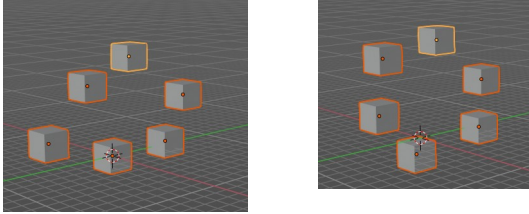
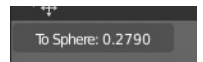

Last Operator To Sphere

Factor

The factor to transform the selection into a shape form.

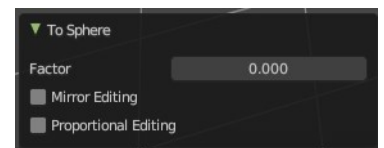

Proportional editing

Enables proportional editing. Activating proportional editing reveals further settings.

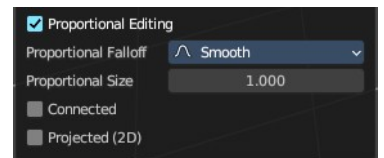

Proportional Falloff

Adjust the falloff methods.

Proportional Size

See and adjust the falloff radius.

Connected

The proportional falloff gets calculated for connected parts only.

Projected(2D)

The proportional falloff gets calculated in the screen space. Depth doesn't play a role. When it's in the radius, then it gets calculated.

Shear

Shear shears the selection.

In Object mode this tool requires to have more than one object selected.

Last Operator Shear

Offset

Adjust an offset.

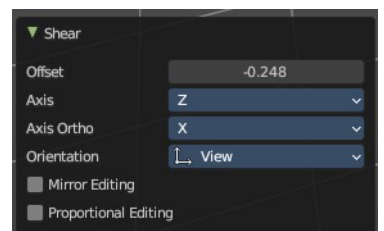

Axis

Defines one axis of the imaginary shear axis plane.

Axis Ortho

Defines the other axis of the imaginary shear axis plane.

Orientation

Choose the orientation for the shear action.

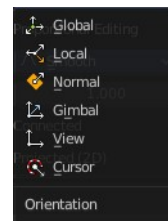

Proportional editing

Enables proportional editing. Activating proportional editing reveals further settings.

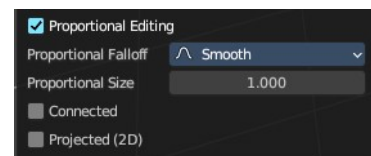

Proportional Falloff

Adjust the falloff methods.

Proportional Size

See and adjust the falloff radius.

Connected

The proportional falloff gets calculated for connected parts only.

Projected(2D)

The proportional falloff gets calculated in the screen space. Depth doesn't play a role. When it's in the radius, then it gets calculated.

Bend

Bends the selection.

In Object mode this tool requires to have more than one object selected.

Push/Pull

It pushes or pulls the object positions relative to the center of the selection.

In Object mode this tool requires to have more than one object selected.

Last Operator Push/Pull

Distance

Adjust the strength of influence of the tool.

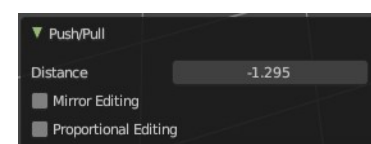

Mirror Editing

Enables mirror editing.

Proportional editing

Enables proportional editing. Activating proportional editing reveals further settings.

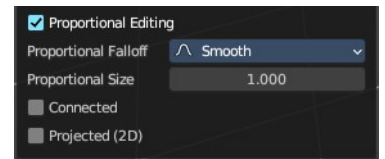

Proportional Falloff

Adjust the falloff methods.

Proportional Size

See and adjust the falloff radius.

Connected

The proportional falloff gets calculated for connected parts only.

Projected(2D)

The proportional falloff gets calculated in the screen space. Depth doesn't play a role. When it's in the radius, then it gets calculated.

Delete

Deletes the selected hair curves.

7.1.43 Editors - 3D Viewport - Header - Hair Curve - Sculpt mode - Curves menu

Table of content

Sculpt mode - Curves menu.....	1
Snap to Deformed Surface.....	1
Snap to Nearest Surface.....	1
Convert to Particle System.....	1

Sculpt mode - Curves menu

Snap to Deformed Surface

Move curves to the nearest deformed surface so that the first point is exactly on the surface mesh. This re-attaches the curves to a deformed surface using the existing attachment information.

This only works when the topology of the surface mesh has not changed.

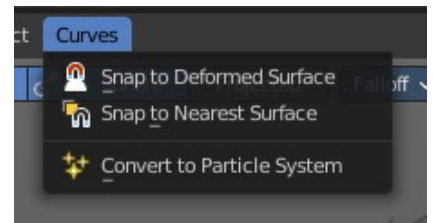

Snap to Nearest Surface

Move curves to the nearest surface so that the first point is exactly on the surface mesh. This finds the closest point of the surface of the root point of every curve and moves the root there.

Convert to Particle System

Add a new or update an existing hair particle system on the surface object. The new Particle System is the legacy hair system. This does not remove the hair curve object, but creates/updates a new Particle System.



7.1.5 Editors - 3D Viewport - Header - Select Menu

Table of content

Detailed Table of content.....	4
Select menu.....	12
Object Mode - Select menu.....	12
Legacy.....	12
Lasso Select.....	12
All.....	12
None.....	13
Inverse.....	13
Grouped.....	13
Linked.....	13
All by Type.....	14
Random.....	14
Mirror Selection.....	15
By Pattern.....	15
Active Camera.....	15
More/ Less.....	16
Mesh - Edit Mode.....	17
Legacy.....	17
Lasso Select.....	17
All.....	18
None.....	18
Inverse.....	18
Linked.....	18
Linked Flat Faces.....	18
Linked Pick Select.....	18
Linked Pick Deselect.....	18
Select Similar.....	19
Random.....	19
Checker Deselect.....	20
Mirror selection.....	20
Side of Active.....	20
Shortest Path.....	21
Sharp Edges.....	22
Edge Loop.....	22
Edge Ring.....	22
Loop Inner-Region.....	22
Boundary Loop.....	23
Ungrouped Verts.....	23
Select all by Trait sub menu.....	23
Loose Geometry.....	23
Interior Faces.....	24
Faces by Sides.....	24
More / Less.....	24
Mesh Object - Vertex and Weight Paint Mode.....	25
Legacy.....	25
Lasso Select.....	25
All.....	26

None.....	26
Invert.....	26
Ungrouped Vertices.....	26
Select Linked.....	26
Linked.....	26
Linked Pick Select.....	26
Linked Pick Deselect.....	26
More/Less submenu.....	26
Mesh Object - Texture Paint Mode.....	27
Legacy.....	27
Lasso Select.....	27
All.....	27
None.....	27
Invert.....	28
Ungrouped Vertices.....	28
Select Linked.....	28
Linked.....	28
Linked Pick Select.....	28
Linked Pick Deselect.....	28
Select Loop.....	28
Add Loop to Selection.....	28
Remove Loop from Selection.....	29
More/Less submenu.....	29
Curve Object - Edit Mode.....	29
Legacy.....	29
Lasso Select.....	30
All.....	30
None.....	30
Invert.....	30
Linked.....	30
Linked Pick Select.....	30
Linked Pick Deselect.....	30
Similar.....	31
Random.....	31
Checker Deselect.....	31
De/Select First.....	32
De/Select Last.....	32
Next Active.....	32
Previous Active.....	32
More.....	32
Less.....	32
Surface Object - Edit Mode.....	32
Legacy.....	33
Lasso Select.....	33
All.....	33
None.....	33
Inverse.....	33
Linked.....	33
Similar.....	34
Random.....	34
Checker Deselect.....	34
Control Point Row.....	35
More.....	35

Less.....	35
Metaball Object - Edit Mode.....	35
Legacy.....	35
Lasso Select.....	36
All.....	36
None.....	36
Inverse.....	36
Similar.....	36
Random.....	36
Text Object - Edit Mode.....	37
All.....	37
Line End, Line Begin, etc.....	37
Grease Pencil Object - Edit Mode, Sculpt Mode, Vertex Paint Mode.....	37
Legacy.....	37
Lasso Select.....	38
All.....	38
None.....	38
Inverse.....	38
Linked.....	38
Alternated.....	38
Grouped.....	39
Color Attribute.....	39
First.....	39
Last.....	39
More.....	40
Less.....	40
Armature Object - Edit Mode.....	40
Legacy.....	41
Lasso Select.....	41
All.....	41
None.....	41
Inverse.....	41
Similar.....	41
Mirror Selection.....	42
By Pattern.....	42
Armature Object - Pose Mode.....	43
Legacy.....	44
Lasso Select.....	44
All.....	44
None.....	44
Inverse.....	44
Grouped.....	44
Constraint Targets.....	44
By Pattern.....	45
Flip Active.....	45
Lattice Object - Edit Mode.....	46
Legacy.....	46
Lasso Select.....	47
All.....	47
None.....	47
Inverse.....	47
Mirror.....	47
Ungrouped Verts.....	47

More.....	48
Less.....	48
Particles - Particle Mode.....	48
Legacy.....	48
Lasso Select.....	48
All.....	48
None.....	49
Inverse.....	49
More.....	49
Less.....	49
Linked.....	49
Random.....	49
Hair Curve – Edit Mode.....	49
All.....	50
None.....	50
Invert.....	50
Random.....	50
Endpoints.....	50
Linked.....	50
Select More/Less submenu.....	50
Hair Curve – Sculpt Mode.....	50
All.....	50
None.....	51
Invert.....	51
Random.....	51
Endpoints.....	51
Grow.....	51

Detailed Table of content

Detailed table of content

Detailed Table of content.....	4
Select menu.....	12
Object Mode - Select menu.....	12
Legacy.....	12
Box select.....	12
Circle select.....	12
Lasso Select.....	12
All.....	12
None.....	13
Inverse.....	13
Grouped.....	13
Last Operator Select Grouped.....	13
Extend.....	13
Type.....	13
Linked.....	13
Object Data.....	13
Material.....	13
Instanced Collection.....	13
Particle System.....	13

Library.....	14
Library (Object Data).....	14
All by Type.....	14
Last Operator Select By Type.....	14
Extend.....	14
Type.....	14
Random.....	14
Last Operator Select Random.....	14
Percent.....	14
Random Seed.....	14
Action.....	14
Mirror Selection.....	15
Last Operator Select Mirror.....	15
Extend.....	15
By Pattern.....	15
Pattern.....	15
Case Sensitive.....	15
Extend.....	15
Last Operator Select Pattern.....	15
Active Camera.....	15
More/ Less.....	16
More.....	16
Less.....	16
Parent.....	16
Child.....	16
Parent extended.....	16
Child Extended.....	16
Mesh - Edit Mode.....	17
Legacy.....	17
Box select.....	17
Circle select.....	17
Lasso Select.....	17
All.....	18
None.....	18
Inverse.....	18
Linked.....	18
Last Operator Select Linked All.....	18
Delimit.....	18
Linked Flat Faces.....	18
Last Operator Select Linked Flat Faces.....	18
Linked Pick Select.....	18
Linked Pick Deselect.....	18
Last Operator Select Linked.....	19
Deselect.....	19
Delimit.....	19
Select Similar.....	19
Last Operator Select Similar.....	19
Type.....	19
Compare.....	19
Threshold.....	19
Random.....	19
Last Operator Select Random.....	19
Percent.....	19

Random Seed.....	20
Action.....	20
Checker Deselect.....	20
Last Operator Checker Deselect.....	20
Nth Element.....	20
Skip.....	20
Offset.....	20
Mirror selection.....	20
Last Operator Select Mirror.....	20
Axis.....	20
Extend.....	20
Side of Active.....	20
Last Operator Side of Active.....	20
Axis mode.....	21
Axis Sign.....	21
Axis.....	21
Threshold.....	21
Shortest Path.....	21
Last Operator Select shortest path.....	21
Face Stepping.....	21
Topology Distance.....	21
Fill Region.....	21
Nth Element.....	22
Skip.....	22
Offset.....	22
Sharp Edges.....	22
Last Operator Select Sharp Edges.....	22
Sharpness.....	22
Edge Loop.....	22
Last Operator Multi Select Loops.....	22
Ring.....	22
Edge Ring.....	22
Last Operator Multi Select Loops.....	22
Ring.....	22
Loop Inner-Region.....	22
Last Operator Select Loop Inner-Region.....	23
Select Bigger.....	23
Boundary Loop.....	23
Ungrouped Verts.....	23
Last Operator Select Ungrouped.....	23
Extend.....	23
Select all by Trait sub menu.....	23
Non Manifold.....	23
Last Operator Select Faces by Side.....	23
Loose Geometry.....	23
Last Operator Select Loose Geometry.....	24
Extend.....	24
Interior Faces.....	24
Faces by Sides.....	24
Last Operator Select Faces by Side.....	24
Sharpness.....	24
Number of vertices.....	24
Type.....	24

Extend.....	24
More / Less.....	24
More.....	24
Less.....	24
Next Active.....	25
Previous Active.....	25
Mesh Object - Vertex and Weight Paint Mode.....	25
Legacy.....	25
Box select.....	25
Circle select.....	25
Lasso Select.....	25
All.....	26
None.....	26
Invert.....	26
Ungrouped Vertices.....	26
Select Linked.....	26
Last Operator Select Linked All.....	26
Delimit.....	26
Linked.....	26
Linked Pick Select.....	26
Linked Pick Deselect.....	26
More/Less submenu.....	26
More.....	26
Less.....	27
Mesh Object - Texture Paint Mode.....	27
Legacy.....	27
Box select.....	27
Circle select.....	27
Lasso Select.....	27
All.....	27
None.....	27
Invert.....	28
Ungrouped Vertices.....	28
Select Linked.....	28
Last Operator Select Linked All.....	28
Delimit.....	28
Linked.....	28
Linked Pick Select.....	28
Linked Pick Deselect.....	28
Select Loop.....	28
Add Loop to Selection.....	28
Remove Loop from Selection.....	29
More/Less submenu.....	29
More.....	29
Less.....	29
Curve Object - Edit Mode.....	29
Legacy.....	29
Box select.....	29
Circle select.....	29
Lasso Select.....	30
All.....	30
None.....	30
Invert.....	30

Linked.....	30
Last Operator Select Linked All.....	30
Delimit.....	30
Linked Pick Select.....	30
Linked Pick Deselect.....	30
Last Operator Select Linked.....	30
Deselect.....	30
Delimit.....	30
Similar.....	31
Last Operator Select Similar.....	31
Type.....	31
Compare.....	31
Threshold.....	31
Random.....	31
Last Operator Select Random.....	31
Percent.....	31
Random Seed.....	31
Action.....	31
Checker Deselect.....	31
Last Operator Checker Deselect.....	31
Nth Element.....	31
Skip.....	32
Offset.....	32
De/Select First.....	32
De/Select Last.....	32
Next Active.....	32
Previous Active.....	32
More.....	32
Less.....	32
Surface Object - Edit Mode.....	32
Legacy.....	33
Box select.....	33
Circle select.....	33
Lasso Select.....	33
All.....	33
None.....	33
Inverse.....	33
Linked.....	33
Last Operator Select Linked All.....	33
Delimit.....	33
Similar.....	34
Last Operator Select Similar.....	34
Type.....	34
Compare.....	34
Threshold.....	34
Random.....	34
Last Operator Select Random.....	34
Percent.....	34
Random Seed.....	34
Action.....	34
Checker Deselect.....	34
Last Operator Checker Deselect.....	34
Nth Element.....	34

Skip.....	34
Offset.....	35
Control Point Row.....	35
More.....	35
Less.....	35
Metaball Object - Edit Mode.....	35
Legacy.....	35
Box select.....	35
Circle select.....	35
Lasso Select.....	36
All.....	36
None.....	36
Inverse.....	36
Similar.....	36
Last Operator Select Similar.....	36
Type.....	36
Compare.....	36
Threshold.....	36
Random.....	36
Last Operator Select Random.....	36
Percent.....	36
Random Seed.....	36
Action.....	36
Text Object - Edit Mode.....	37
All.....	37
Line End, Line Begin, etc.....	37
Grease Pencil Object - Edit Mode, Sculpt Mode, Vertex Paint Mode.....	37
Legacy.....	37
Box select.....	37
Circle select.....	38
Lasso Select.....	38
All.....	38
None.....	38
Inverse.....	38
Linked.....	38
Last Operator Select Linked All.....	38
Delimit.....	38
Alternated.....	38
Last Operator Alternated.....	39
Unselect Ends.....	39
Grouped.....	39
Last Operator Select Grouped.....	39
Type.....	39
Color Attribute.....	39
Last Operator Select Vertex Color.....	39
Threshold.....	39
First.....	39
Last Operator Select First.....	39
Selected Strokes only.....	39
Extend.....	39
Last.....	39
Last Operator Select Last.....	40
Selected Strokes only.....	40

Extend.....	40
More.....	40
Less.....	40
Armature Object - Edit Mode.....	40
Legacy.....	41
Box select.....	41
Circle select.....	41
Lasso Select.....	41
All.....	41
None.....	41
Inverse.....	41
Similar.....	41
Last Operator Select Similar.....	42
Type.....	42
Compare.....	42
Threshold.....	42
Mirror Selection.....	42
Last Operator Select Mirror.....	42
Extend.....	42
By Pattern.....	42
Pattern.....	42
Case Sensitive.....	42
Extend.....	43
Last Operator Select Pattern.....	43
Parent.....	43
Child.....	43
Extend Parent.....	43
Extend Child.....	43
More.....	43
Less.....	43
Armature Object - Pose Mode.....	43
Legacy.....	44
Box select.....	44
Circle select.....	44
Lasso Select.....	44
All.....	44
None.....	44
Inverse.....	44
Grouped.....	44
Constraint Targets.....	44
By Pattern.....	45
Pattern.....	45
Case Sensitive.....	45
Extend.....	45
Last Operator Select Pattern.....	45
Flip Active.....	45
Last Operator Flip Active/Selected Bone.....	45
Active Only.....	45
Extend.....	45
Parent.....	46
Child.....	46
Extend Parent.....	46
Extend Child.....	46

Lattice Object - Edit Mode.....	46
Legacy.....	46
Box select.....	46
Circle select.....	46
Lasso Select.....	47
All.....	47
None.....	47
Inverse.....	47
Mirror.....	47
Last Operator Select Mirror.....	47
Axis.....	47
Extend.....	47
Ungrouped Verts.....	47
Last Operator Select Ungrouped.....	47
Extend.....	47
More.....	48
Less.....	48
Particles - Particle Mode.....	48
Legacy.....	48
Box select.....	48
Circle select.....	48
Lasso Select.....	48
All.....	48
None.....	49
Inverse.....	49
More.....	49
Less.....	49
Linked.....	49
Random.....	49
Last Operator Select Random.....	49
Percent.....	49
Random Seed.....	49
Action.....	49
Type.....	49
Hair Curve – Edit Mode.....	49
All.....	50
None.....	50
Invert.....	50
Random.....	50
Endpoints.....	50
Linked.....	50
Select More/Less submenu.....	50
Hair Curve – Sculpt Mode.....	50
All.....	50
None.....	51
Invert.....	51
Random.....	51
Endpoints.....	51
Grow.....	51

Select menu

The Select menu provides you with all functionality around selecting. The content differs, dependent in which mode you are, and what object type you have selected. Some select functionality is very special for just one object type in one special mode. But not every mode has a select menu.

Object Mode - Select menu

The select menu in Object mode is for all object types equal. It provides you with several selection methods.

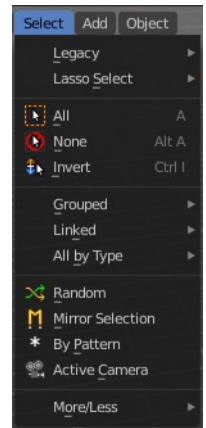

Legacy

The legacy sub menu contains tools that exists in the tool shelf already. It's the old way to do things. Different to the tools in the tool shelf, these tools are usually modal. And performs once. You have to call them again in case you want to repeat the tool.



Box select

Draw a rectangle to select everything inside of the rectangle.

It automatically adds to the current selection. Holding down shift subtracts from the selection.

Circle select

Brush select content. The radius of the brush can be adjusted by holding down left mouse button and using the scroll wheel or the + or - button at the numpad.

It automatically adds to the current selection. Holding down shift subtracts from the selection. To exit the circle select tool click with the right mouse button.

Lasso Select

A sub menu with the available lasso select modes.

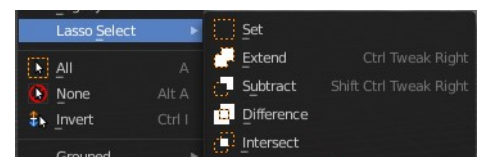

All

Select everything.

None

Select nothing.

Inverse

Invert the current selection.

Grouped

Select different types of objects within the group. It requires to have a group selected.

The menu items are pretty self explaining. So we won't go into detail here.

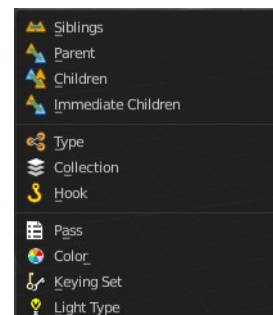

Last Operator Select Grouped

Extend

Extends existing selection instead of deselecting everything first.

Type

Type is a drop-down list choose the Linked type again.

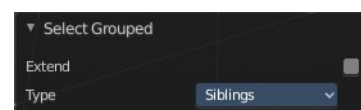

Linked

Linked is a menu select different types.

Select all objects that shares a common data-block with the active object. *Select Linked* uses the active object as a basis to select all others.

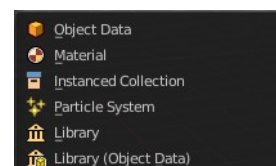

Object Data

Selects every object that is linked to the same Object Data.

Material

Selects every object that is linked to the same material data-block.

Instanced Collection

Selects every object that is linked to the instanced collection.

Particle System

Selects all objects that use the same Particle System.

Library

Selects all objects that are in the same Library.

Library (Object Data)

Selects all objects that are in the same Library and limited to object data.

All by Type

Select objects of a specific type.

The menu items are pretty self explaining. So we won't cover every single menu item here.

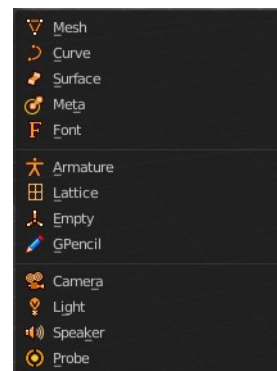

Last Operator Select By Type

Extend

With this option activated the selection does not clear before performing the selection operation, but extends. This means when you have a mesh object selected, and want to select all objects by type curve, then the mesh object is still selected. Without Extend just the curve objects are selected. The mesh object gets deselected.

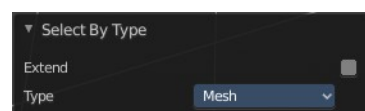

Type

Type is a drop-down box choose the object type to select again.

Random

Selects random objects.

Last Operator Select Random

Percent

The Percentage of objects that should be selected randomly.

Random Seed

The Seed for the random number generator.

Action

Action is a drop-down box choose if you want to select or to deselect random.



Mirror Selection

Select the mirrored parts of an object. For example for L.Sword it selects R.Sword.

Last Operator Select Mirror

Extend

Extends existing selection instead of deselecting everything first.



By Pattern

Selects all objects whose name matches the entered string. For missing parts you need to add an asterix.

For example, you have four cubes in the scene. Cube, Cube.001, Cube.002 and mycube3. Then the term " Cube " will just select the first cube. While the term " Cube* " will select the first three. And " *cube* " will select all four.

Supported wild-cards:

* matches everything

? matches any single character

[abc] matches characters in "abc"

[!abc] match any character not in "abc"

The tool operates immediately at entering the string.

Pattern

Type in your string.

Case Sensitive

When ticked then the string comparison happens by taking upper and lower letters into account.

Extend

Extends existing selection instead of deselecting everything first.

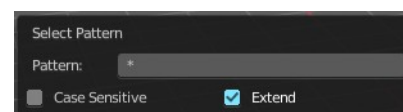

Last Operator Select Pattern

The Last Operator Select Pattern contains the same menu items than the pop-up. So see above. Also, it does not appear in the 3D view. But when you call it from the edit menu or with hotkey.

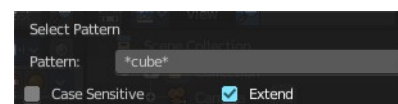

Active Camera

Selects the active camera.

More/ Less

More

More requires to have a parent or child relationship. It expands the selection.

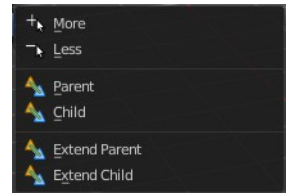

Less

Less requires to have a parent or child relationship. It reduces the selection.

Parent

Parent requires to have a parent or child relationship. It selects the parent object of the currently selected object(s).

Child

Child requires to have a parent or child relationship. It selects the child object(s) of the currently selected object(s).

Parent extended

Parent extended requires to have a parent or child relationship. It selects the parent object of the currently selected object(s). But keeps the active object in the selection, even when it's not currently selected.

Child Extended

Child Extended requires to have a parent or child relationship. It selects the child object(s) of the currently selected object(s). But keeps the active object in the selection, even when it's not currently selected.

Mesh - Edit Mode

The select menu for a mesh object in Edit mode.

A few tools here acts different, dependent in which mesh select mode you are. For example, when you are in mesh select method vertices, then the Random operator picks random vertices.

So you might want to check the mesh select mode when something does not work in an expected way.

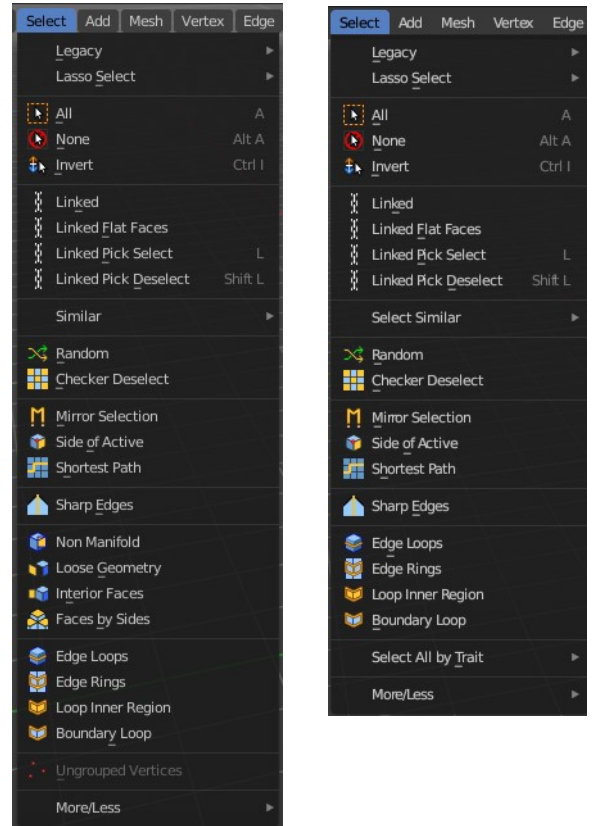

Legacy

The legacy sub menu contains tools that exists in the tool shelf already. It's the old way to do things. Different to the tools in the tool shelf, these tools are usually modal. And performs once. You have to call them again in case you want to repeat the tool.



Box select

Draw a rectangle to select everything inside of the rectangle.

It automatically adds to the current selection. Holding down shift subtracts from the selection.

Circle select

Brush select content. The radius of the brush can be adjusted by holding down left mouse button and using the scroll wheel or the + or - button at the numpad.

It automatically adds to the current selection. Holding down shift subtracts from the selection. To exit the circle select tool click with the right mouse button.

Lasso Select

A sub menu with the available lasso select modes.

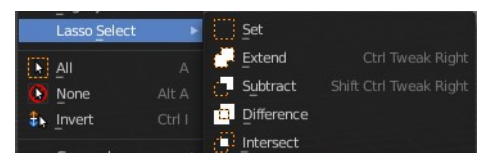

All

Select everything.

None

Select nothing.

Inverse

Invert the current selection.

Linked

Select the geometry that is directly linked with the current geometry. You can for example have a mesh with several closed sub meshes. Those sub meshes. are not linked together, but are part of the object.

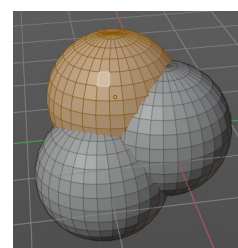

Last Operator Select Linked All

Delimit

Add a limit to the selection. For example, just select up to the next seam.

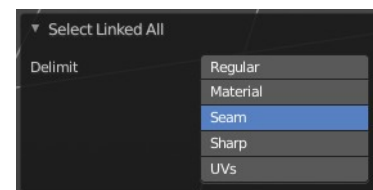

Linked Flat Faces

Select the geometry that is co planar to the current selection. It works also in other selection modes, but you need to have face geometry selected.

Last Operator Select Linked Flat Faces

Adjust the angle up to which a face counts as co planar.

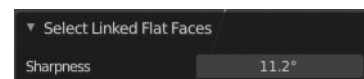

Linked Pick Select

Same as with Linked. But works with what is under the mouse cursor.

Linked Pick Deselect

Same as with Linked. But works with what is under the mouse cursor. And deselects the selection.

Last Operator Select Linked

Deselect

Select or deselect.

Delimit

Add a limit to the selection. For example, just select up to the next seam.

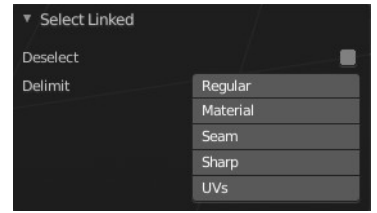

Select Similar

Select geometry based on how similar certain properties are to it. The methods changes, dependent in which mesh selection mode you are. There is a pitfall with having more than one mesh selection method selected. Then you just get the face regions type presented. Vertices, Edges, Faces, more than one ...

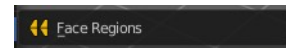
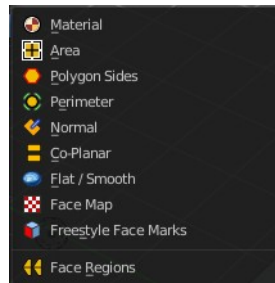
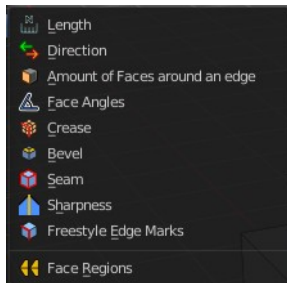
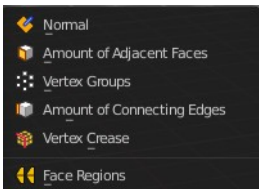

Last Operator Select Similar

Type

Choose the select similar method again.

Compare

Compare with method less, greater or equal.

Threshold

Adjust the threshold value after which the element counts as similar.



Random

Selects a random group of vertices, edges, or faces, dependent of the mesh selection method.

Last Operator Select Random

Percent

How much percent will be random selected.

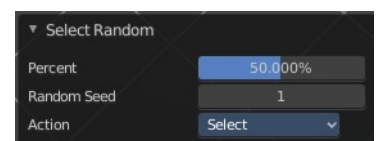

Random Seed

The random seed value.

Action

Select or deselect.

Checker Deselect

Deselect alternating faces, edges or vertices to create a checker like pattern. The result is dependent of the mesh selection method.

Last Operator Checker Deselect

Nth Element

Define how much elements gets unchecked. With 2 you have a checker board pattern. Every second element gets deselected.



Skip

Skip elements before the checker algorithm deselects again.

Offset

Offset the deselected elements.

Mirror selection

Requires to have a symmetrical mesh. Selects the mirrored mesh parts from a selection.

Last Operator Select Mirror

Axis

The world axis to mirror at.

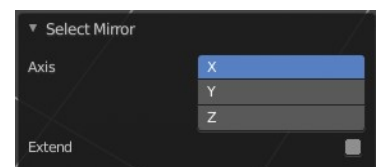

Extend

Keep the current selection. Without extend the current selection gets deselected.

Side of Active

Selects all mesh data in direction of a single axis, starting from the current selection.

Last Operator Side of Active

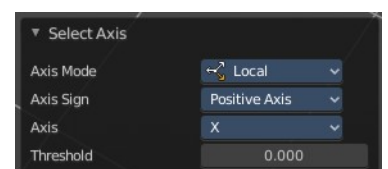

Axis mode

The axis orientation to work with.

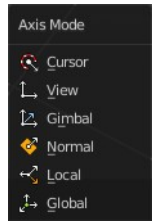

Axis Sign

In which direction to work form the current selection.



Axis

The axis to work with.

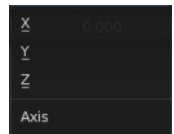

Threshold

Define a threshold to extend the selection.

Shortest Path

Select the shortest edge path between two selected mesh elements. This can be vertices, edges or faces. A start and an end point must be selected.

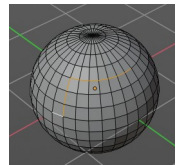

Last Operator Select shortest path

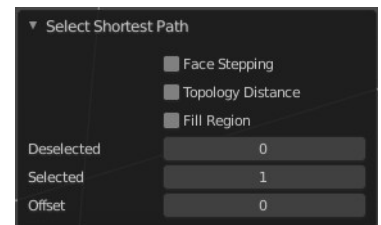

Face Stepping

Traverse connected faces.

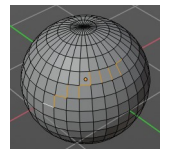

Topology Distance

Find the minimum number of steps instead of the shortest distance.

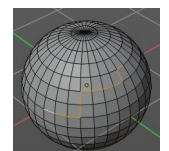

Fill Region

Select the region faces too.

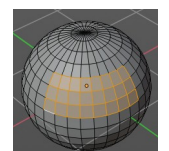

Nth Element

Don't select the whole path, but just every nth element of it.

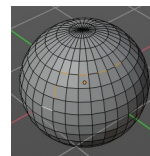

Skip

This is connected to nth element. Number of elements to skip at once.

Offset

This is connected to nth element. Start with an offset.

Sharp Edges

Select all edges that are marked as sharp.

Last Operator Select Sharp Edges

Sharpness

The angle after which a sharp edge gets selected.

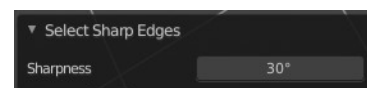

Edge Loop

Selects a loop of edges from a selected edge. The method stops at poles. That's vertices where three or more than four edges comes together. At a UV sphere the north and south pole ...

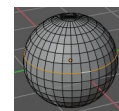

Last Operator Multi Select Loops

Ring

Select edge ring instead of edge loop.

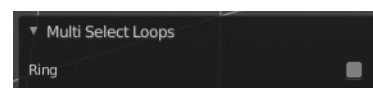

Edge Ring

Selects edges parallel to a selected edge in the same ring of faces. The method stops at poles. That's vertices where three or more than four edges comes together. At a UV sphere the north and south pole ...

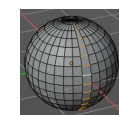

Last Operator Multi Select Loops

Ring

Select edge ring instead of edge loop.

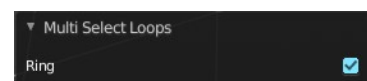

Loop Inner-Region

Select everything that is enclosed by an edge loop. When the loop is not closed, then it might select

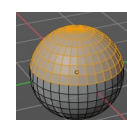

everything ...

By default the smaller enclosed part gets selected. The Inner-Region.

Last Operator Select Loop Inner-Region

Select Bigger

Select the bigger enclosed part instead of the smaller enclosed part.

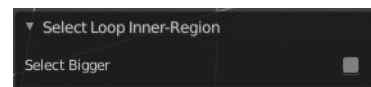

Boundary Loop

Select the edges that encloses a selection of faces.

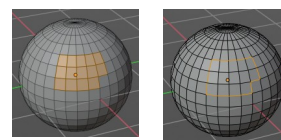

Ungrouped Verts

Selects ungrouped Vertices. Just active in vertex selection mode. And requires to have at least one vertex group assigned.

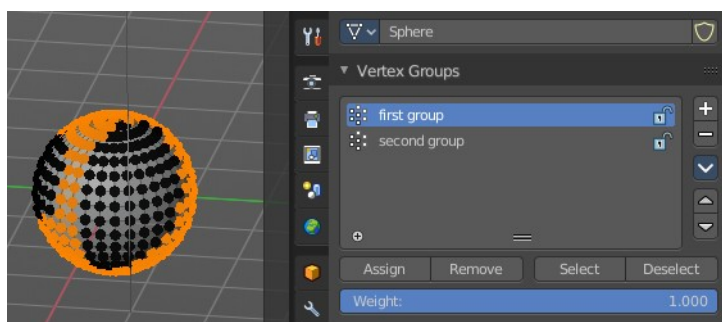

Last Operator Select Ungrouped

Extend

Extends the current selection.

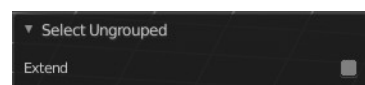

Select all by Trait sub menu

Non Manifold

Select non manifold geometry. Enclosed faces inside of a geometry for example..

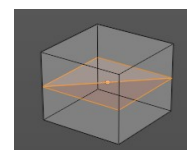

Last Operator Select Faces by Side

What exact kind of non manifold geometry should be selected. The options names should be self explaining.

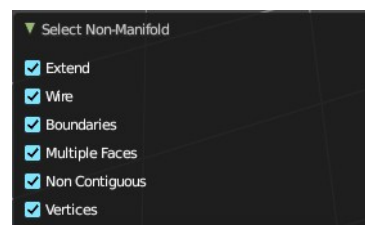

Loose Geometry

Selects loose geometry.

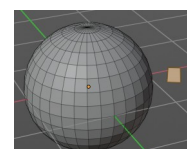

Last Operator Select Loose Geometry

Extend

Extend the current selection.

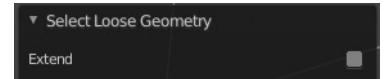

Interior Faces

Select faces where all edges have more than 2 faces. In the picture here we have inlaying faces by joining two cubes together, then merge the vertices by distance. So the two faces from the former two cubes are now interior faces. That's usually unwanted geometry that you want to select and to remove.

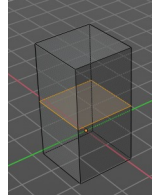

Faces by Sides

Selects faces that has the same number of edges, or better said vertices. Tris, quads, N-gons.

Last Operator Select Faces by Side

Sharpness

Extend the current selection.

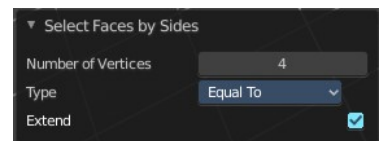

Number of vertices

How many numbers of vertices the face should have. 4 is a quad.

Type

Selection type.

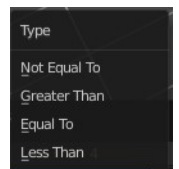

Extend

Extend the current selection.

More / Less

More

Extends the current selection.

Less

Reduces the current selection.

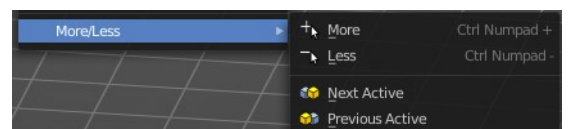

Next Active

Selects the next active element. For example, when you have two vertices selected, then the next vertex in the row with the same distance will be selected as the next active.

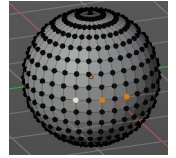

Previous Active

Like next active, but deselects in the other direction down to the first selected vertex with every step.

Mesh Object - Vertex and Weight Paint Mode

This select menu shows with the sub modes Paint Mask and Vertex Selection in vertex paint mode and weight paint mode.

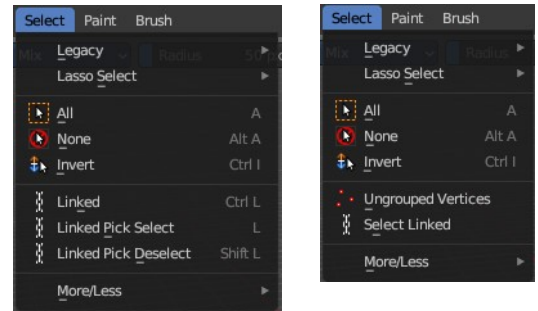
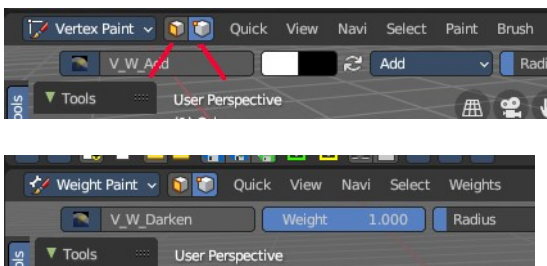

Legacy

The legacy sub menu contains tools that exists in the tool shelf already. It's the old way to do things. Different to the tools in the tool shelf, these tools are usually modal. And performs once. You have to call them again in case you want to repeat the tool.



Box select

Draw a rectangle to select everything inside of the rectangle.

It automatically adds to the current selection. Holding down shift subtracts from the selection.

Circle select

Brush select content. The radius of the brush can be adjusted by holding down left mouse button and using the scroll wheel or the + or - button at the numpad.

It automatically adds to the current selection. Holding down shift subtracts from the selection. To exit the circle select tool click with the right mouse button.

Lasso Select

A sub menu with the available lasso select modes.

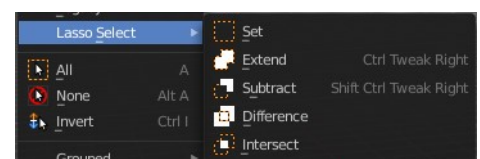

All

Select everything.

None

Select nothing.

Invert

Invert the current selection.

Ungrouped Vertices

Vertex Selection Mode. Select vertices that does not belong to a group.

Select Linked

Vertex Selection Mode. Select the geometry that is directly linked with the current geometry. You can for example have a mesh with several closed sub meshes. Those sub meshes. are not linked together, but are part of the object.

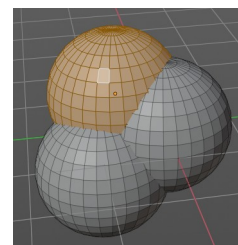

Last Operator Select Linked All

Delimit

Add a limit to the selection. For example, just select up to the next seam.

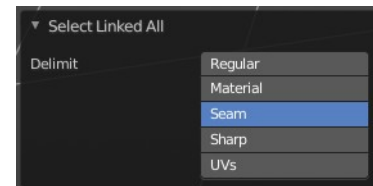

Linked

Paint Mask mode. Select linked faces. Mouse only tool.

Linked Pick Select

Paint Mask mode. Select linked faces. Mouse only tool.

Linked Pick Deselect

Paint Mask mode. Deselect linked faces. Mouse only tool.

More/Less submenu

More

Increase the selection.

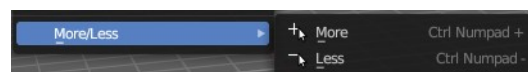

Less

Decrease the selection.

Mesh Object - Texture Paint Mode

This select menu shows with the sub mode Paint Mask.

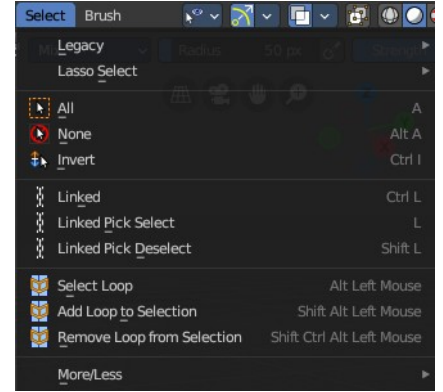

Legacy

The legacy sub menu contains tools that exists in the tool shelf already. It's the old way to do things. Different to the tools in the tool shelf, these tools are usually modal. And performs once. You have to call them again in case you want to repeat the tool.



Box select

Draw a rectangle to select everything inside of the rectangle.

It automatically adds to the current selection. Holding down shift subtracts from the selection.

Circle select

Brush select content. The radius of the brush can be adjusted by holding down left mouse button and using the scroll wheel or the + or - button at the numpad.

It automatically adds to the current selection. Holding down shift subtracts from the selection. To exit the circle select tool click with the right mouse button.

Lasso Select

A sub menu with the available lasso select modes.

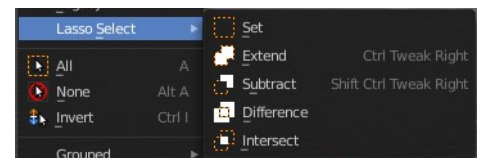

All

Select everything.

None

Select nothing.

Invert

Invert the current selection.

Ungrouped Vertices

Vertex Selection Mode. Select vertices that does not belong to a group.

Select Linked

Vertex Selection Mode. Select the geometry that is directly linked with the current geometry. You can for example have a mesh with several closed sub meshes. Those sub meshes. are not linked together, but are part of the object.

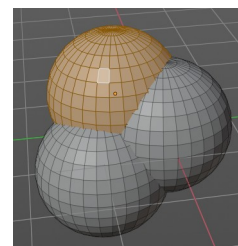

Last Operator Select Linked All

Delimit

Add a limit to the selection. For example, just select up to the next seam.

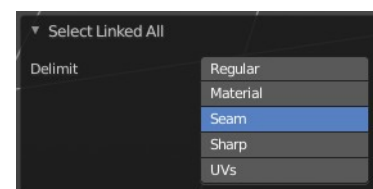

Linked

Paint Mask mode. Select linked faces. Mouse only tool.

Linked Pick Select

Paint Mask mode. Select linked faces. Mouse only tool.

Linked Pick Deselect

Paint Mask mode. Deselect linked faces. Mouse only tool.

Select Loop

Selects a face loop. Mouse operator. The result is dependant of thhe face under the mouse. So please use the mouse.

Add Loop to Selection

Adds a face loop to an existing selection. Mouse operator. The result is dependant of thhe face under the mouse. So please use the mouse.

Remove Loop from Selection

Subtracts a face loop from an existing selection. Mouse operator. The result is dependant of thhe face under the

mouse. So please use the mouse.

More/Less submenu

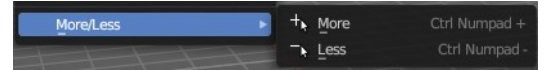

More

Increase the selection.

Less

Decrease the selection.

Curve Object - Edit Mode

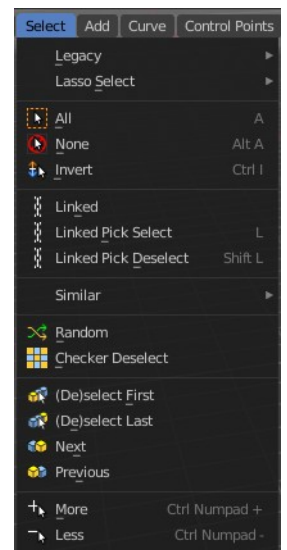

Legacy

The legacy sub menu contains tools that exist in the tool shelf already. It's the old way to do things. Different to the tools in the tool shelf, these tools are usually modal. And performs once. You have to call them again in case you want to repeat the tool.



Box select

Draw a rectangle to select everything inside of the rectangle.

It automatically adds to the current selection. Holding down shift subtracts from the selection.

Circle select

Brush select content. The radius of the brush can be adjusted by holding down left mouse button and using the scroll wheel or the + or - button at the numpad.

It automatically adds to the current selection. Holding down shift subtracts from the selection. To exit the circle select tool click with the right mouse button.

Lasso Select

A sub menu with the available lasso select modes.

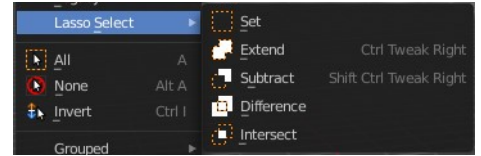

All

Select everything.

None

Select nothing.

Invert

Invert the current selection.

Linked

Select the geometry that is directly linked with the current geometry. You can for example have a mesh with several closed sub meshes. Those sub meshes. are not linked together, but are part of the object.

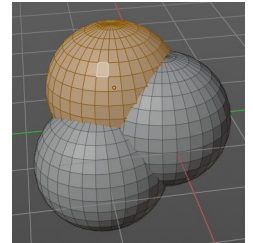

Last Operator Select Linked All

Delimit

Add a limit to the selection. For example, just select up to the next seam.

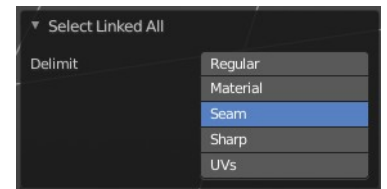

Linked Pick Select

Same as with Linked. But works with what is under the mouse cursor.

Linked Pick Deselect

Same as with Linked. But works with what is under the mouse cursor. And deselects the selection.

Last Operator Select Linked

Deselect

Select or deselect.

Delimit

Add a limit to the selection. For example, just select up to the next seam.

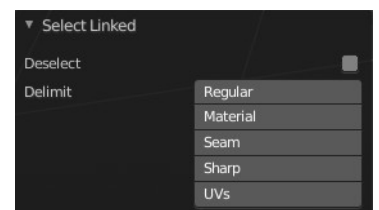

Similar

Select curve geometry based on how similar certain properties are to it.

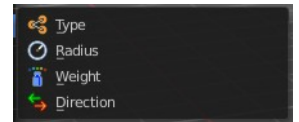

Last Operator Select Similar

Type

Choose the select similar method again.



Compare

Compare with method less, greater or equal.

Threshold

Adjust the threshold value after which the element counts as similar.

Random

Selects a random group of curve points.

Last Operator Select Random

Percent

How much percent will be random selected.

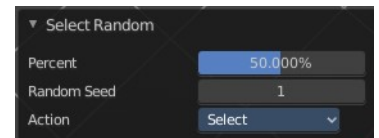

Random Seed

The random seed value.

Action

Select or deselect.

Checker Deselect

Deselect alternating curve points.

Last Operator Checker Deselect

Nth Element

Define how much elements gets unchecked. With 2 you have a checker board pattern. Every second element gets deselected.



Skip

Skip elements before the checker algorithm deselects again.

Offset

Offset the deselected elements.

De/Select First

Select or deselect first curve point.

De/Select Last

Select or deselect last curve point.

Next Active

Selects the next active element. For example, when you have two vertices selected, then the next vertice in the row with the same distance will be selected as the next active.

Previous Active

Like next active, but deselects in the other direction down to the first selected vertice with every step.

More

Extends the current selection.

Less

Reduces the current selection.

Surface Object - Edit Mode

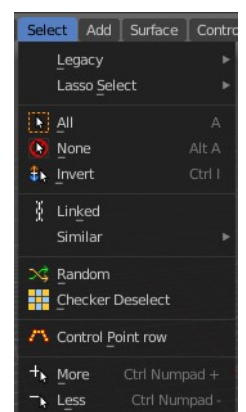

Legacy

The legacy sub menu contains tools that exists in the tool shelf already. It's the old way to do things. Different to the tools in the tool shelf, these tools are usually modal. And performs once. You have to call them again in case you want to repeat the tool.

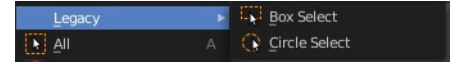

Box select

Draw a rectangle to select everything inside of the rectangle.

It automatically adds to the current selection. Holding down shift subtracts from the selection.

Circle select

Brush select content. The radius of the brush can be adjusted by holding down left mouse button and using the scroll wheel or the + or - button at the numpad.

It automatically adds to the current selection. Holding down shift subtracts from the selection. To exit the circle select tool click with the right mouse button.

Lasso Select

A sub menu with the available lasso select modes.

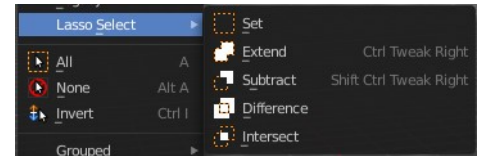

All

Select everything.

None

Select nothing.

Inverse

Invert the current selection.

Linked

Select the geometry that is directly linked with the current geometry. You can for example have a mesh with several closed sub meshes. Those sub meshes are not linked together, but are part of the object.

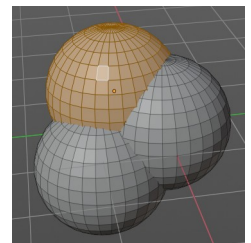

Last Operator Select Linked All

Delimit

Add a limit to the selection. For example, just select up to the next seam.

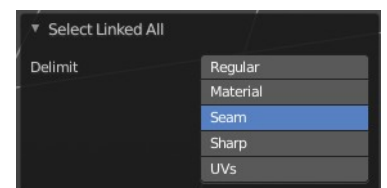

Similar

Select curve geometry based on how similar certain properties are to it.

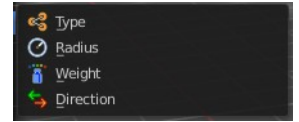

Last Operator Select Similar

Type

Choose the select similar method again.



Compare

Compare with method less, greater or equal.

Threshold

Adjust the threshold value after which the element counts as similar.

Random

Selects a random group of control points.

Last Operator Select Random

Percent

How much percent will be random selected.

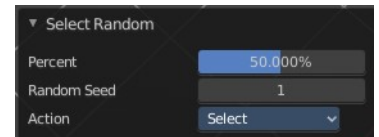

Random Seed

The random seed value.

Action

Select or deselect.

Checker Deselect

Deselect alternating control points.

Last Operator Checker Deselect

Nth Element

Define how much elements gets unchecked. With 2 you have a checker board pattern. Every second element gets deselected.



Skip

Skip elements before the checker algorithm deselects again.

Offset

Offset the deselected elements.

Control Point Row

Selects a row of control points, including the active one.

More

Extends the current selection.

Less

Reduces the current selection.

Metaball Object - Edit Mode

Legacy

The legacy sub menu contains tools that exists in the tool shelf already. It's the old way to do things. Different to the tools in the tool shelf, these tools are usually modal. And performs once. You have to call them again in case you want to repeat the tool.

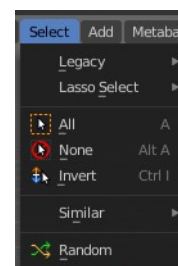

Box select

Draw a rectangle to select everything inside of the rectangle.

It automatically adds to the current selection. Holding down shift subtracts from the selection.

Circle select

Brush select content. The radius of the brush can be adjusted by holding down left mouse button and using the scroll wheel or the + or - button at the numpad.

It automatically adds to the current selection. Holding down shift subtracts from the selection. To exit the circle select tool click with the right mouse button.

Lasso Select

A sub menu with the available lasso select modes.

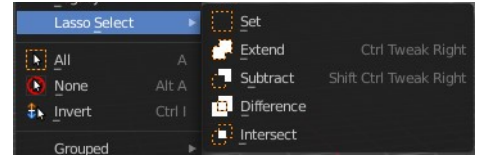

All

Select everything.

None

Select nothing.

Inverse

Invert the current selection.

Similar

Select metaball geometry based on how similar certain properties are to it.

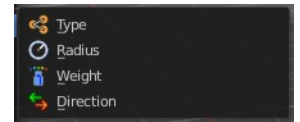

Last Operator Select Similar

Type

Choose the select similar method again.



Compare

Compare with method less, greater or equal.

Threshold

Adjust the threshold value after which the element counts as similar.

Random

Selects a random metaball element.

Last Operator Select Random

Percent

How much percent will be random selected.

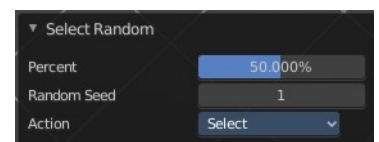

Random Seed

The random seed value.

Action

Select or deselect.

Text Object - Edit Mode

All

Select everything.

Line End, Line Begin, etc.

Select corresponding element.



Grease Pencil Object - Edit Mode, Sculpt Mode, Vertex Paint Mode

This is the select menu for the grease pencil object. You can find this menu in multiple modes.

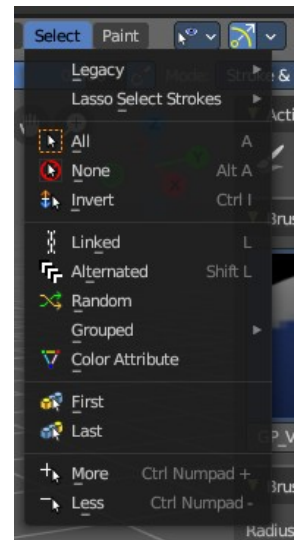

Legacy

The legacy sub menu contains tools that exist in the tool shelf already. It's the old way to do things. Different to the tools in the tool shelf, these tools are usually modal. And performs once. You have to call them again in case you want to repeat the tool.

Box select

Draw a rectangle to select everything inside of the rectangle.

It automatically adds to the current selection. Holding down shift subtracts from the selection.



Circle select

Brush select content. The radius of the brush can be adjusted by holding down left mouse button and using the scroll wheel or the + or - button at the numpad.

It automatically adds to the current selection. Holding down shift subtracts from the selection. To exit the circle select tool click with the right mouse button.

Lasso Select

A sub menu with the available lasso select modes.

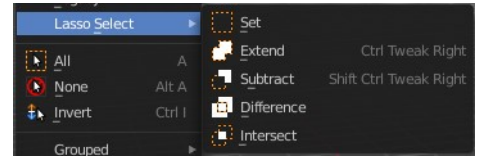

All

Select everything.

None

Select nothing.

Inverse

Invert the current selection.

Linked

Select the geometry that is directly linked with the current geometry. You can for example have a mesh with several closed sub meshes. Those sub meshes are not linked together, but are part of the object.

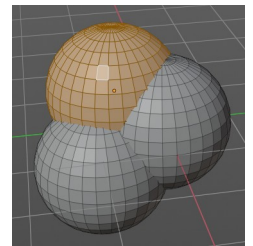

Last Operator Select Linked All

Delimit

Add a limit to the selection. For example, just select up to the next seam.

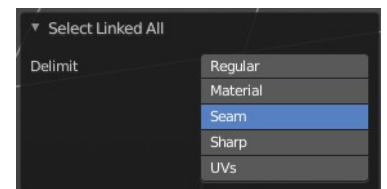

Alternated

Select every second element.

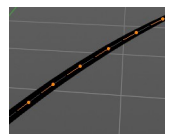

Last Operator Alternated

Unselect Ends

The end points are always unselected.



Grouped

Select grouped strokes by layer or color.



Last Operator Select Grouped

Type

Adjust if you want to select by layer or color.

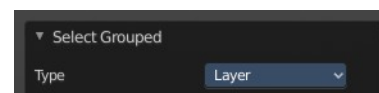

Color Attribute

Select all points with similar vertex color of current selected vertices. You have to create a vertex selection first.

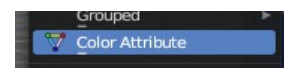

Last Operator Select Vertex Color

Threshold

Tolerance of the selection. Higher values select a wider range of similar colors.



First

Select the first element in the stroke.

Last Operator Select First

Selected Strokes only

Only select the first point of strokes that has already some geometry selected.

Extend

Extend the current selection.

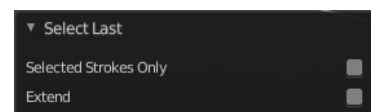

Last

Select the last element in the stroke.

Last Operator Select Last

Selected Strokes only

Only select the last point of strokes that has already some geometry selected.

Extend

Extend the current selection.

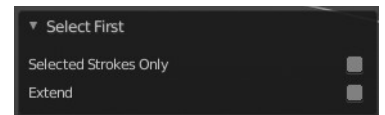

More

Extends the current selection.

Less

Reduces the current selection.

Armature Object - Edit Mode

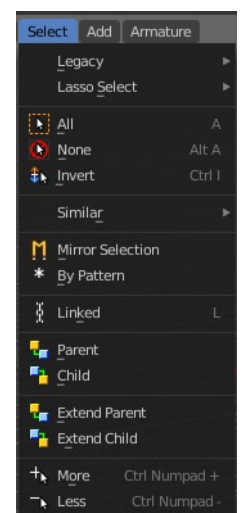

Legacy

The legacy sub menu contains tools that exists in the tool shelf already. It's the old way to do things. Different to the tools in the tool shelf, these tools are usually modal. And performs once. You have to call them again in case you want to repeat the tool.

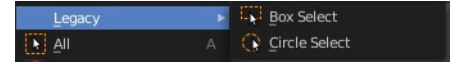

Box select

Draw a rectangle to select everything inside of the rectangle.

It automatically adds to the current selection. Holding down shift subtracts from the selection.

Circle select

Brush select content. The radius of the brush can be adjusted by holding down left mouse button and using the scroll wheel or the + or - button at the numpad.

It automatically adds to the current selection. Holding down shift subtracts from the selection. To exit the circle select tool click with the right mouse button.

Lasso Select

A sub menu with the available lasso select modes.

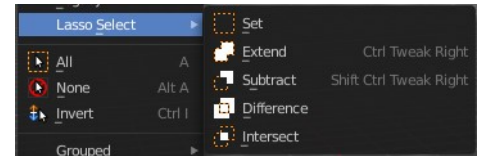

All

Select everything.

None

Select nothing.

Inverse

Invert the current selection.

Similar

Select metaball geometry based on how similar certain properties are to it.

Most methods are self explaining. Immediate children selects just the direct children of the active object, while Children selects everything downwards the hierarchy.

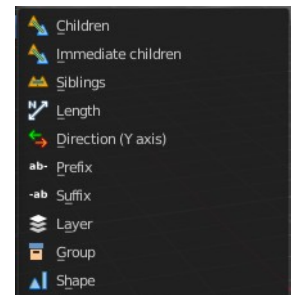

Last Operator Select Similar

Type

Choose the select similar method again.

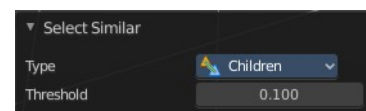

Compare

Compare with method less, greater or equal.

Threshold

Adjust the threshold value after which the element counts as similar.

Mirror Selection

Select the mirrored parts of an object. For example for L.bone it selects R.bone.

Last Operator Select Mirror

Extend

Extends existing selection instead of deselecting everything first.



By Pattern

Selects all objects whose name matches the entered string. For missing parts you need to add an asterix.

For example, you have four cubes in the scene. Cube, Cube.001, Cube.002 and mycube3. Then the term " Cube " will just select the first cube. While the term " Cube* " will select the first three. And " *cube* " will select all four.

Supported wild-cards:

* matches everything

? matches any single character

[abc] matches characters in "abc"

[!abc] match any character not in "abc"

The tool operates immediately at entering the string.

Pattern

Type in your string.

Case Sensitive

When ticked then the string comparison happens by taking upper and lower letters into account.

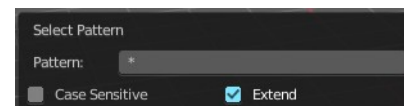

Extend

Extends existing selection instead of deselecting everything first.

Last Operator Select Pattern

The Last Operator Select Pattern contains the same menu items than the pop-up. So see above. Also, it does not appear in the 3D view. But when you call it from the edit menu or with hotkey.

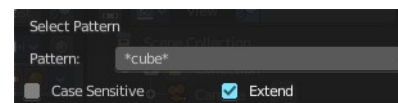

Parent

Parent requires to have a parent or child relationship. It selects the parent object of the currently selected object(s).

Child

Child requires to have a parent or child relationship. It selects the child object(s) of the currently selected object(s).

Extend Parent

Extend Parent requires to have a parent or child relationship. It selects the parent object of the currently selected object(s). But keeps the active object in the selection, even when it's not currently selected.

Extend Child

Extend Child requires to have a parent or child relationship. It selects the child object(s) of the currently selected object(s). But keeps the active object in the selection, even when it's not currently selected.

More

More requires to have a parent or child relationship. It expands the selection.

Less

Less requires to have a parent or child relationship. It reduces the selection.

Armature Object - Pose Mode

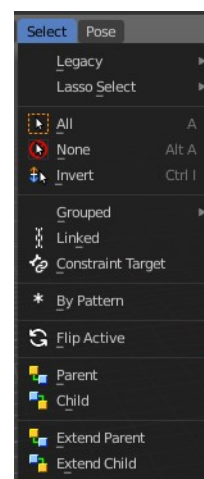

Legacy

The legacy sub menu contains tools that exists in the tool shelf already. It's the old way to do things. Different to the tools in the tool shelf, these tools are usually modal. And performs once. You have to call them again in case you want to repeat the tool.



Box select

Draw a rectangle to select everything inside of the rectangle.

It automatically adds to the current selection. Holding down shift subtracts from the selection.

Circle select

Brush select content. The radius of the brush can be adjusted by holding down left mouse button and using the scroll wheel or the + or - button at the numpad.

It automatically adds to the current selection. Holding down shift subtracts from the selection. To exit the circle select tool click with the right mouse button.

Lasso Select

A sub menu with the available lasso select modes.

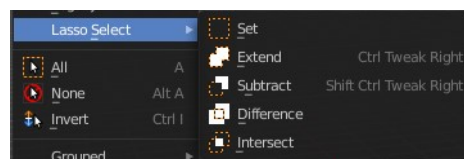

All

Select everything.

None

Select nothing.

Inverse

Invert the current selection.

Grouped

Select grouped bones by type.

Constraint Targets

Select the bones used as targets for the currently selected bone.

By Pattern

Selects all objects whose name matches the entered string. For missing parts you need to add an asterix.

For example, you have four cubes in the scene. Cube, Cube.001, Cube.002 and mycube3. Then the term " Cube " will just select the first cube. While the term " Cube* " will select the first three. And " *cube* " will select all four.

Supported wild-cards:

* matches everything

? matches any single character

[abc] matches characters in "abc"

[!abc] match any character not in "abc"

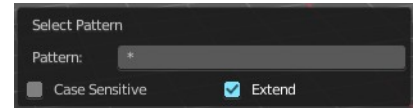

The tool operates immediately at entering the string.

Pattern

Type in your string.

Case Sensitive

When ticked then the string comparison happens by taking upper and lower letters into account.

Extend

Extends existing selection instead of deselecting everything first.

Last Operator Select Pattern

The Last Operator Select Pattern contains the same menu items than the pop-up. So see above. Also, it does not appear in the 3D view. But when you call it from the edit menu or with hotkey.

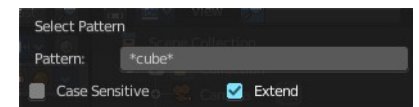

Flip Active

Mirrors the bone selection. Works with an armature with mirrored parts.

Last Operator Flip Active/Selected Bone

Active Only

Only select the mirror part of the active bone.

Extend

Extend the current selection.

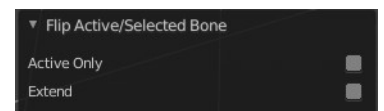

Parent

Parent requires to have a parent or child relationship. It selects the parent object of the currently selected

object(s).

Child

Child requires to have a parent or child relationship. It selects the child object(s) of the currently selected object(s).

Extend Parent

Extend Parent requires to have a parent or child relationship. It selects the parent object of the currently selected object(s). But keeps the active object in the selection, even when it's not currently selected.

Extend Child

Extend Child requires to have a parent or child relationship. It selects the child object(s) of the currently selected object(s). But keeps the active object in the selection, even when it's not currently selected.

Lattice Object - Edit Mode

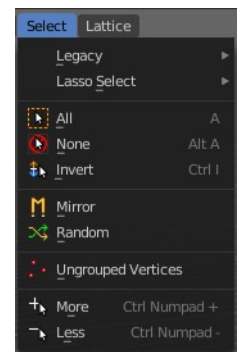

Legacy

The legacy sub menu contains tools that exists in the tool shelf already. It's the old way to do things. Different to the tools in the tool shelf, these tools are usually modal. And performs once. You have to call them again in case you want to repeat the tool.



Box select

Draw a rectangle to select everything inside of the rectangle.

It automatically adds to the current selection. Holding down shift subtracts from the selection.

Circle select

Brush select content. The radius of the brush can be adjusted by holding down left mouse button and using the scroll wheel or the + or - button at the numpad.

It automatically adds to the current selection. Holding down shift subtracts from the selection. To exit the circle select tool click with the right mouse button.

Lasso Select

A sub menu with the available lasso select modes.

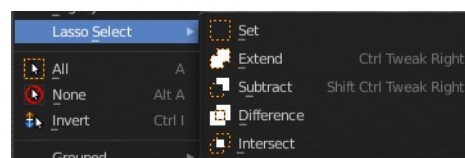

All

Select everything.

None

Select nothing.

Inverse

Invert the current selection.

Mirror

Select the mirrored parts to the current selection.

Last Operator Select Mirror

Axis

Choose the world axis to mirror at.

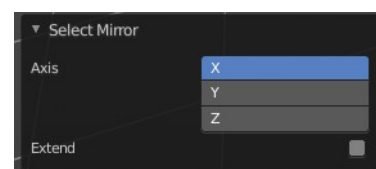

Extend

Extends existing selection instead of deselecting everything first.

Ungrouped Verts

Selects ungrouped Vertices. Requires to have at least one vertex group assigned.

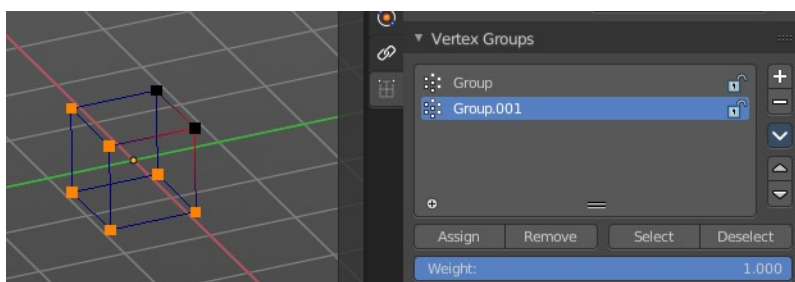

Last Operator Select Ungrouped

Extend

Extends the current selection instead of deselecting everything first.

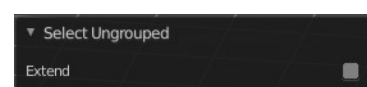

More

Extends the current selection.

Less

Reduces the current selection.

Particles - Particle Mode

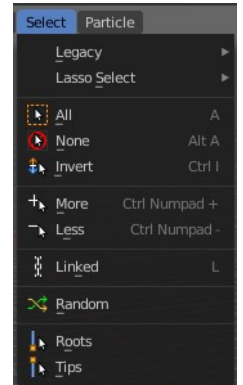

Legacy

The legacy sub menu contains tools that exist in the tool shelf already. It's the old way to do things. Different to the tools in the tool shelf, these tools are usually modal. And performs once. You have to call them again in case you want to repeat the tool.



Box select

Draw a rectangle to select everything inside of the rectangle.

It automatically adds to the current selection. Holding down shift subtracts from the selection.

Circle select

Brush select content. The radius of the brush can be adjusted by holding down left mouse button and using the scroll wheel or the + or - button at the numpad.

It automatically adds to the current selection. Holding down shift subtracts from the selection. To exit the circle select tool click with the right mouse button.

Lasso Select

A sub menu with the available lasso select modes.

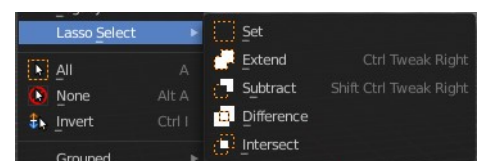

All

Select everything.

None

Select nothing.

Inverse

Invert the current selection.

More

Extends the current selection.

Less

Reduces the current selection.

Linked

Selects the linked particles.

Random

Selects random particles.

Last Operator Select Random

Percent

The Percentage of objects that should be selected randomly.

Random Seed

The Seed for the random number generator.

Action

Action is a drop-down box choose if you want to select or to deselect random.

Type

Select the whole hair, or hair points.

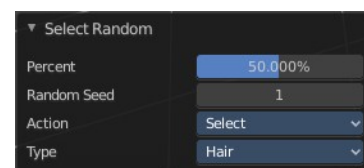

Hair Curve – Edit Mode

The (Empty) Hair Curve object in the Edit mode has a select menu. Here you can select existing curves in different ways to mask selections for tool shelf operators. Selected curves are editable, deselected curves are locked from editing and are visually opaque with dark gray in the 3D View editor.

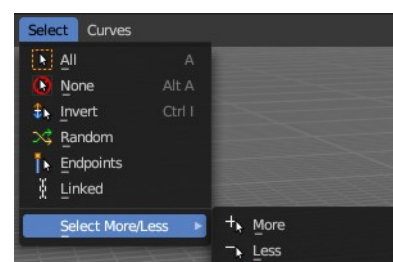

All

Selects all the control points of the hair strands.

If you want a want a symmetrical haircut, tick X Mirror in the Symmetry panel or in the Header to the top right.

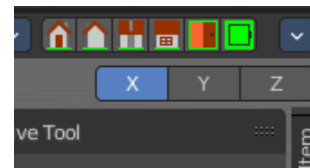

None

Deselects all the control points of the hair curves.

Invert

Deselects all the control points of the hair curves.

Random

Randomizes existing selection or creates a new random selection of control points of the hair curves.

Endpoints

Selects the end points of the control points of the hair curves.

Linked

Select linked control points.

Select More/Less submenu

Grow or shrink the selection.

Hair Curve – Sculpt Mode

The (Empty) Hair Curve object in the Sculpt mode has a select menu. Here you can select existing curves in different ways to mask selections for tool shelf operators. Selected curves are editable, deselected curves are locked from editing and are visually opaque with dark gray in the 3D View editor.

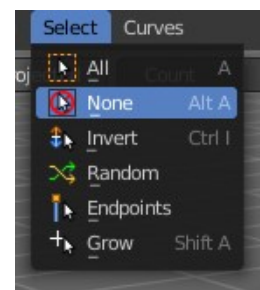

All

Selects all the control points of the hair strands.

If you want a want a symmetrical haircut, tick X Mirror in the Symmetry panel or in the Header to the top right.



None

Deselects all the control points of the hair curves.

Invert

Deselects all the control points of the hair curves.

Random

Randomizes existing selection or creates a new random selection of control points of the hair curves.

Endpoints

Selects the end points of the control points of the hair curves.

Grow

Select curves which are close to curves that are selected already.



7.1.6 Editors - 3D Viewport - Header - Add Menu

Table of content

Add Menu.....	3
Mesh.....	4
Plane.....	4
Last Operator Add Plane Panel.....	4
Cube.....	4
Last Operator Add Cube Panel.....	4
Circle.....	4
Last Operator Add Circle Panel.....	5
UV Sphere.....	5
Last Operator Add UV Sphere Panel.....	5
Ico Sphere.....	5
Last Operator Add Ico Sphere Panel.....	5
Cylinder.....	6
Last Operator Add Circle Panel.....	6
Cone.....	6
Last Operator Add Cone Panel.....	6
Torus.....	7
Last Operator Add Torus Panel.....	7
Grid.....	7
Last Operator Add Grid Panel.....	7
Monkey.....	8
Last Operator Add Monkey Panel.....	8
Curve.....	8
Bezier.....	8
Circle.....	8
Nurbs Curve.....	9
Nurbs Circle.....	9
Path.....	9
Last Operator Add Curve.....	9
Empty Hair.....	9
Quick Fur.....	10
Last operator Quick Fur.....	10
Density.....	10
Length.....	10
Hair Radius.....	10
View Percentage.....	11
Apply hair guides.....	11
Noise.....	11
Frizz.....	11
Surface.....	11
Surface Curve.....	11
Surface Circle.....	11
Surface Surface.....	11
Surface Cylinder.....	11
Surface Sphere.....	11
Surface Torus.....	11
Last Operator Add Surface.....	12

Metaball.....	12
Ball.....	12
Capsule.....	12
Plane.....	12
Ellipsoid.....	12
Cube.....	12
Last Operator Add Meta ball.....	12
Text.....	13
Objects as Fonts.....	13
Editing Text.....	13
Inserting Text.....	14
Accent Characters.....	14
Last Operator Add Text.....	15
Last Operator Move Cursor.....	15
Type.....	15
Point Cloud.....	16
Last Operator Add Point Cloud.....	16
Align.....	16
Location X Y Z.....	16
Rotation X Y Z.....	16
Volume.....	16
Import OpenVDB.....	16
Empty.....	17
Last Operator Add Volume.....	17
Align.....	17
Location X Y Z.....	17
Rotation X Y Z.....	17
Grease Pencil.....	17
Blank.....	17
Stroke.....	18
Monkey.....	18
Scene Line Art.....	18
Collection Line Art.....	18
Object Line Art.....	18
Last Operator Add Grease Pencil.....	18
In Front.....	19
Stroke Depth Order.....	19
Armature.....	19
Last Operator Add Armature.....	19
Lattice.....	20
Usage.....	20
Last Operator Add Lattice object.....	20
Empty.....	20
Last Operator Add Empty.....	21
Image.....	21
Reference.....	21
Background.....	22
Speaker.....	22
Last Operator Add Speaker.....	22
Camera.....	22
Last Operator Add Camera.....	22
Light.....	23
Point.....	23

Sun.....	23
Spot.....	23
Area.....	23
Last Operator Add Light.....	23
Light Probe.....	24
Reflection Cubemap.....	24
Reflection Plane.....	24
Irradiance Volume.....	24
Last Operator Add Light Probe.....	24
Force Field.....	25
Last Operator Add Effector.....	25
Collection Instance.....	25
Last Operator Add Collection Instance.....	26
Create Isocam.....	26
True Isocam.....	26
Game Isocam.....	26
GameIso4to3cam.....	27
Ground plane.....	27

Add Menu

The Add menu contains everything that can be added to the scene. Geometry, camera, lights and so on.

When you create a primitive then the Adjust Last Operator Panel down left shows some settings for this primitive.

Note that the adjust last operator panel does not show when you add a primitive from the toolbar at the top. Then you have to open the adjust last operation panel from the toolbar.



Note also that those settings are not longer available when you perform any operation at the object. And be it to move the primitive. Some of those settings might still be available in the Properties editor. But things like create UV not. So when you want to adjust those settings, then do it immediately after creation.

Several object types can be edited. A Mesh Primitive for example. They have different modes available then. Some not. Like an Empty. There is just the Object mode available for an Empty.

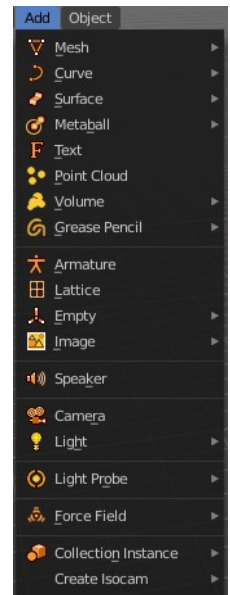

You can add some primitives in edit mode too. In object mode you have the whole range available. In Edit mode you usually just have the object type available with which you are in edit mode.

For example, when you are in edit mode with a mesh, then the add menu just shows the mesh content. When you add geometry in edit mode, then the added geometry becomes part of the current object.



Mesh

The Mesh section contains the primitives that are made of meshes.

Mesh objects are geometrical objects made of vertices, edges and faces. The geometry can be edited in various ways in edit mode. They can be sculpted in sculpt mode. The vertices can be painted in vertex paint mode. They can be used as a skin for a skeleton, and you can weight paint them so that it deforms with the armature. And you can add textures by UV mapping.

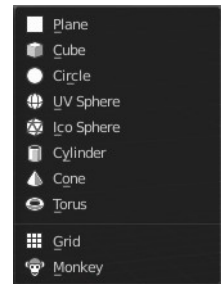

Plane

Plane creates a simple quad face mesh.

Last Operator Add Plane Panel

Size is in real the size of the plane.

Generate UV's creates UV's for this primitive.

Align aligns the geometry to the chosen view. World, View or 3D cursor.

Location Adjust the location of the Plane.

Rotation defines the rotation of the Plane.

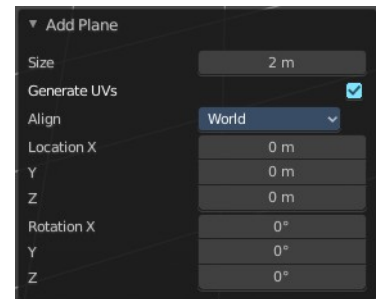

Cube

Cube creates a Cube mesh.

Last Operator Add Cube Panel

Size is in real the size of the Cube.

Generate UV's creates UV's for this primitive.

Align to view aligns the geometry to the chosen view. World, View or 3D cursor.

Note that this option is dysfunctional when you call the Adjust Last Operator panel from the Toolbar editor.

Location defines the location of the Cube.

Rotation defines the rotation of the Cube.

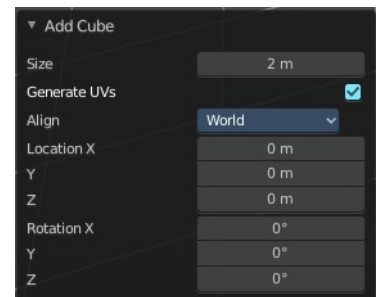

Circle

Circle creates a Circle mesh.

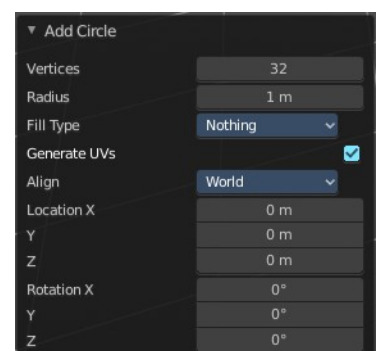

Last Operator Add Circle Panel

Vertices defines of how much vertices the circle is made.

Radius defines the radius of the circle.

Fill Type defines how the Circle mesh is filled.

- Nothing means you have pure edge geometry.
- N-Gon means that the circle face is a N-Gon face.
- Triangle Fan means that the circle face is triangulated.

Generate UV's creates UV's for this primitive.

Align to view aligns the geometry to the chosen view. World, View or 3D cursor.

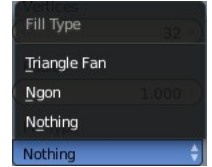

Note that this option is dysfunctional when you call the Adjust Last Operator panel from the Toolbar editor.

Location defines the location of the Circle.

Rotation defines the rotation of the Circle.

UV Sphere

UV Sphere creates a sphere mesh.

Last Operator Add UV Sphere Panel

Segments defines of how much segments the sphere has vertically.

Rings defines how much rings the sphere has horizontally.

Size defines the radius of the UV Sphere.

Generate UV's creates UV's for this primitive.

Align to view aligns the geometry to the chosen view. World, View or 3D cursor.

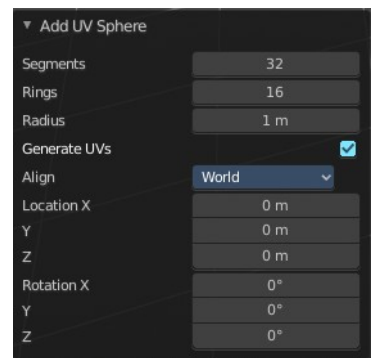

Note that this option is dysfunctional when you call the Adjust Last Operator panel from the Toolbar editor.

Location defines the location of the Sphere.

Rotation defines the rotation of the Sphere.

Ico Sphere

Ico Sphere creates a sphere mesh.

Last Operator Add Ico Sphere Panel

Subdivisions defines the subdivision level of the Ico Sphere.

Size defines the radius of the Ico Sphere.

Generate UV's creates UV's for this primitive.

Align to view aligns the geometry to the chosen view. World, View or 3D cursor.

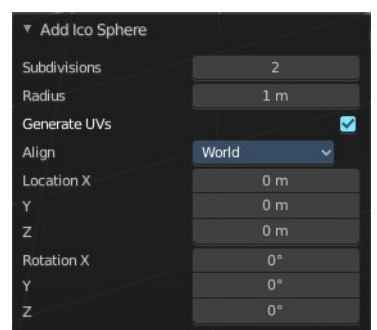

Note that this option is dysfunctional when you call the Adjust Last Operator panel from the Toolbar editor.

Location defines the location of the Sphere.

Rotation defines the rotation of the Sphere.

Cylinder

Cylinder creates a Cylinder mesh.

Last Operator Add Circle Panel

Vertices defines of how much vertices the circle is made.

Radius defines the radius of the Cylinder.

Depth defines the length of the Cylinder.

Cap Fill Type defines how the cap face is filled.

- Nothing means you have no face at the top and the bottom of the Cylinder.
- N-Gon means that the cap face is an N-Gon face.
- Triangle Fan means that the cap face is triangulated.

Generate UV's creates UV's for this primitive.

Align to view aligns the geometry to the chosen view. World, View or 3D cursor.

Note that this option is dysfunctional when you call the Adjust Last Operator panel from the Toolbar editor.

Location defines the location of the Cylinder.

Rotation defines the rotation of the Cylinder.

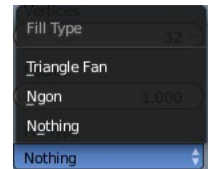
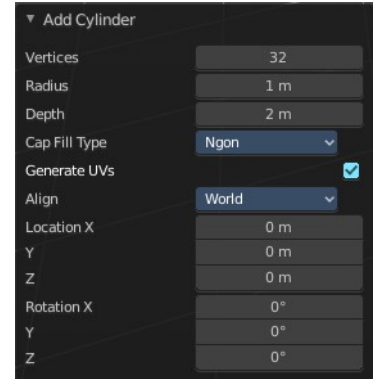

Cone

Cone creates a Cone mesh

Last Operator Add Cone Panel

Vertices defines of how much vertices the circle is made.

Radius 1 defines the base radius of the Cone.

Radius 2 defines the top radius of the Cone.

Depth defines the length of the Cone.

Base Fill Type defines how the Base face is filled.

- Nothing means you have no base face.
- N-Gon means that the base face is an N-Gon face.
- Triangle Fan means that the base face is triangulated.

Generate UV's creates UV's for this primitive.

Align to view aligns the geometry to the chosen view. World, View or 3D cursor.

Note that this option is dysfunctional when you call the Adjust Last Operator panel from the Toolbar editor.

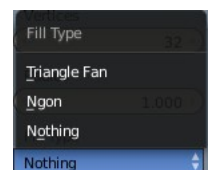
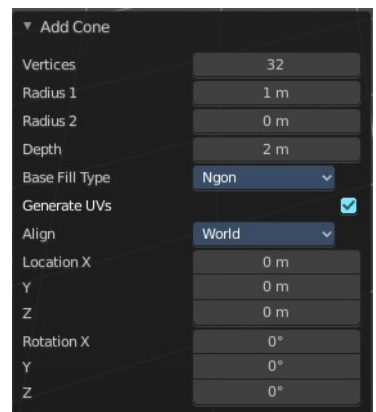

Location defines the location of the Cone.

Rotation defines the rotation of the Cone.

Torus

Torus creates a Torus mesh

Last Operator Add Torus Panel

Operator Presets allows you to store presets for the Torus. So that you don't have to start from scratch when you need different tori with different setup. This presets are temporary. And cannot be stored between sessions.

Align to view aligns the geometry to the chosen view. World, View or 3D cursor.

Note that this option is dysfunctional when you call the Adjust Last Operator panel from the Toolbar editor.

Location defines the location of the Torus.

Rotation defines the rotation of the Torus.

Major segments defines the segment division of the Torus.

Minor segments defines the circle division of the Torus.

Torus Dimensions defines the method to use when changing Major and Minor Radius.

Major Radius changes the radius of the Torus.

Minor Radius changes the thickness of the Torus.

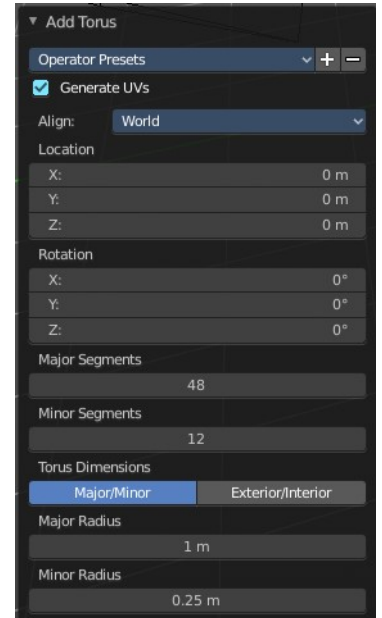

Grid

Grid creates a subdividable plane mesh

Last Operator Add Grid Panel

X Subdivisions defines the number of subdivisions in x direction.

Y Subdivisions defines the number of subdivisions in Y direction.

Size is in real the size of the plane.

Generate UV's creates UV's for this primitive.

Align to view aligns the geometry to the chosen view. World, View or 3D cursor.

Note that this option is dysfunctional when you call the Adjust Last Operator panel from the Toolbar editor.

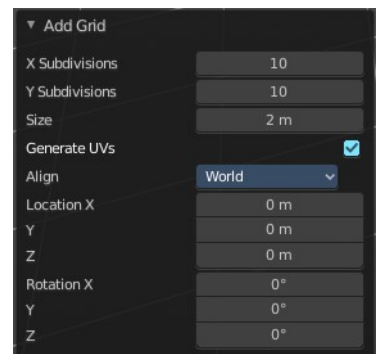

Location Adjust the location of the Plane.

Rotation defines the rotation of the Plane.

Monkey

Monkey creates a monkey head mesh.

Last Operator Add Monkey Panel

Radius is in real the size of the object.

Align to view aligns the geometry to the chosen view. World, View or 3D cursor.

Note that this option is dysfunctional when you call the Adjust Last Operator panel from the Toolbar editor.

Location Adjust the location of the Monkey head mesh.

Rotation defines the rotation of the Monkey head mesh.

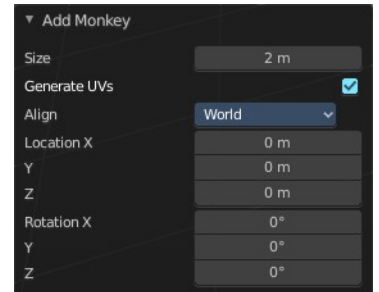

Curve

Add curves primitives.

Curve objects are mathematical curves that are defined by a start and endpoint. You can edit the shape of the curve by handlers. Curves have several purposes. They can be used as a path. Or you use them as the base for a mesh object.

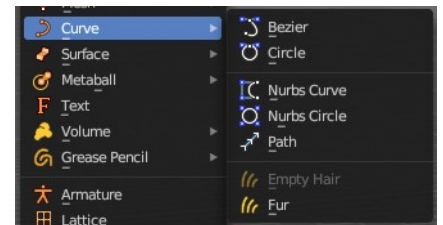

The curve types are very similar. But do have some small differences. The difference between Bezier and Nurbs is that with Bezier you have handlers at the curve. And with a Nurbs you have a control geometry to influence the curve.

Note that Curves is no mesh data. You have to convert the Curves data to Mesh data when you want to work with it like with a mesh. Note also that you cannot convert it back to curve then.

Bezier

Bezier creates a Bezier type curve.

Circle

Circle creates a Bezier circle type curve.

Nurbs Curve

Nurbs Curve creates a Nurbs type curve.

Nurbs Circle

Nurbs Circle creates a Nurbs type circle curve.

Path

Path creates a Nurbs type curve.

Last Operator Add Curve

The Last Operator add panel is for all curves equal.

Radius is in real the size of the object.

Align to view aligns the geometry to the chosen view. World, View or 3D cursor.

Note that this option is dysfunctional when you call the Adjust Last Operator panel from the Toolbar editor.

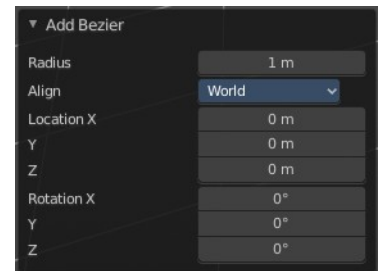

Location Adjust the location of the curve.

Rotation defines the rotation of the curve.

Empty Hair

Adds an empty hair system.

This is the new curve based hair system. The old system works with particles. The tool adds a Curves hair system and the corresponding Surface Deform modifier to a mesh. Which is nothing else than a renamed geometry node. The new hair system is a geometry node solution.

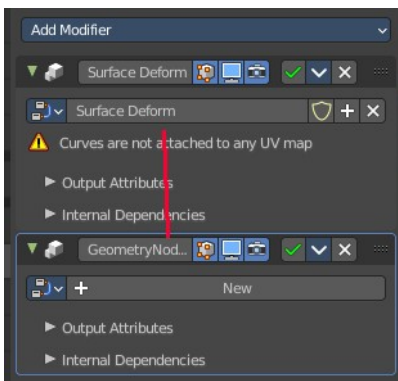
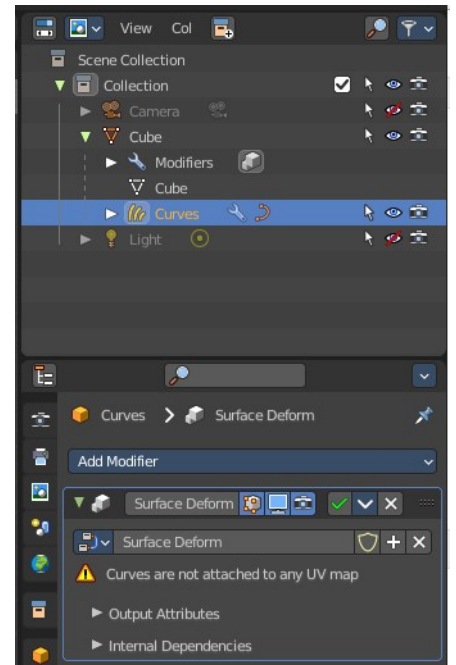

You need to have a mesh object selected to set the menu item active.

The actual hair then gets added and modified in sculpt mode and by geometry nodes.

A curve radius node is for example needed to control the thickness of the hair. Or you add a resample node to make the hair more detailed. And so on. Further settings can also be found in the Properties editor.

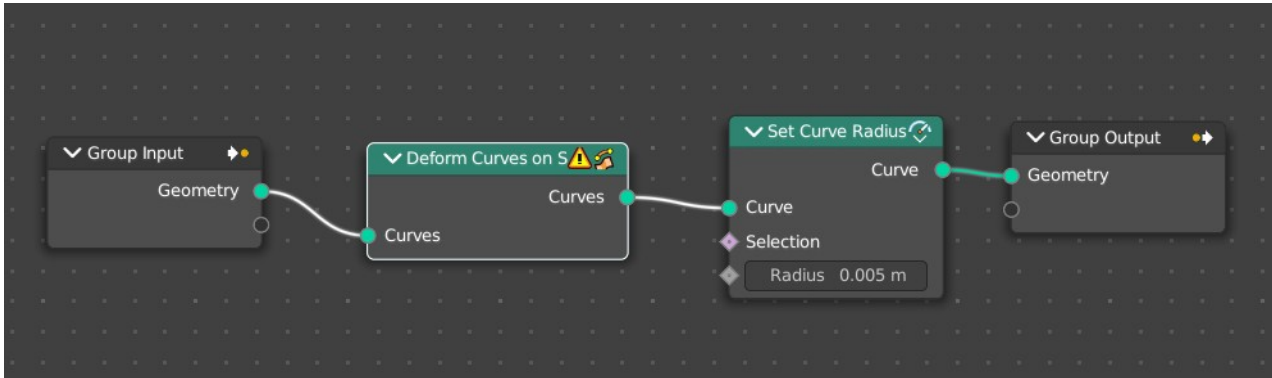

Quick Fur

Adds a quick fur setup. Similar to Empty Hair, but with content. And all required modifiers.

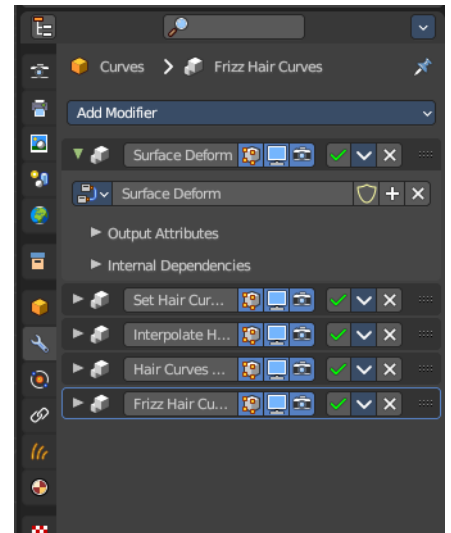
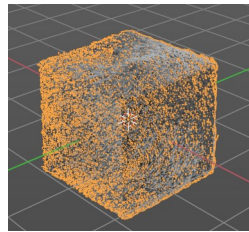

Last operator Quick Fur

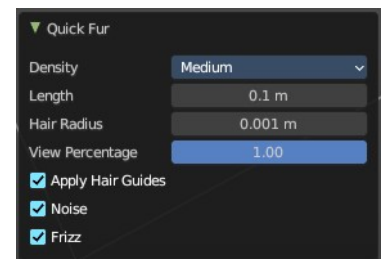

Density

The fur density.

Length

The fur length.

Hair Radius

The hair radius.

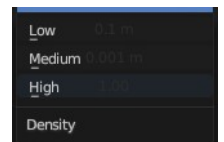

View Percentage

How much percent of the fur to show in the viewport. Does not affect rendering.

Apply hair guides

Apply hair guides if they exist.

Noise

Add some noise to the hair straints.

Frizz

Add some curl to the hair straints.

Surface

Surfaces are some kind of curves. But curves with which you can construct surfaces.

Surfaces are all of type Nurbs curves.

Note that Surfaces similar to Curves is no mesh data. You have to convert the Surfaces data to Mesh data when you want to work with it like with a mesh. Note also that you cannot convert it back to Surface then.



Surface Curve

Surface Curve creates a Nurbs type curve.

Surface Circle

Surface Circle creates a Nurbs type circle.

Surface Surface

Surface Surface creates a Nurbs type Surface.

Surface Cylinder

Surface Cylinder creates a Nurbs type cylinder.

Surface Sphere

Surface Sphere creates a Nurbs type sphere.

Surface Torus

Surface Torus creates a Nurbs type Torus.

Last Operator Add Surface

The Last Operator add panel is for all curves equal.

Radius is in real the size of the object.

Align to view aligns the geometry to the chosen view. World, View or 3D cursor.

Note that this option is dysfunctional when you call the Adjust Last Operator panel from the Toolbar editor.

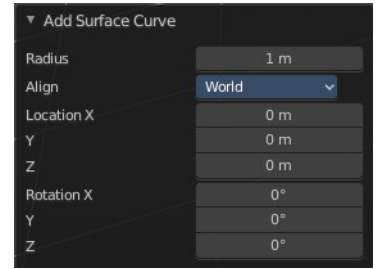

Location Adjust the location of the surface.

Rotation defines the rotation of the surface.

Metaball

Meta-balls are procedural primitives. They are not defined by vertices or curves. The interesting behavior of meta-balls is that you can stick them into each other. And they have one surface then. Like merging two water drops. And this works in Object mode already.

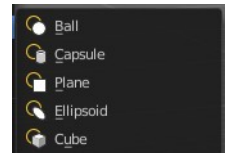

Ball

Ball creates a meta-ball in Sphere shape.

Capsule

Capsule creates a meta-ball in Capsule shape.

Plane

Plane creates a meta-ball in Plane shape.

Ellipsoid

Ellipsoid creates a meta-ball in Ellipsoid shape.

Cube

Cube creates a meta-ball in Cube shape.

Last Operator Add Meta ball

The Last Operator add panel is for all Meta-balls equal.

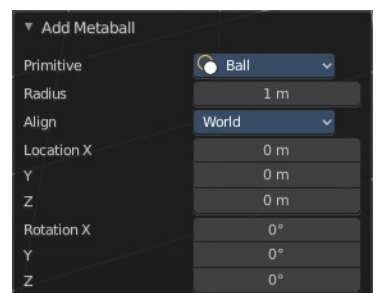

Primitive is a drop-down box where you can change the Meta ball type.

Radius is in real the size of the object.

Align to view aligns the geometry to the chosen view. World, View or 3D cursor.

Note that this option is dysfunctional when you call the Adjust Last Operator panel from the Toolbar editor.

Location Adjust the location of the surface.

Rotation defines the rotation of the surface.

Text

Text creates a text object. With a text object you can create a text in the 3D viewport. Text is not mesh geometry. It is a special curve geometry. But you can convert it to a mesh. See Object menu, Convert to.

Text can be cut, copied and pasted in the usual way by ctrl x, ctrl c and ctrl v

There is a limit of characters, which is by 50.000.

Objects as Fonts

You can also “create” your own “font” inside Bforartists! This is quite a complex process, so let’s detail it:

- First, you must create your chars. Each char is an object *of any type* (mesh, curve, meta...). They all must have a name following the schema: **common prefix** followed by the **char name** (e.g. **ft . a**, **ft . b**, etc.).
- Then, for the *Text* object, you must enable the *Dupli Verts* button (*Object* context - *Anim Settings* panel).
- Back in *Editing* context, in the *Font* panel, fill the *Ob Family* field with the *common prefix* of your “font” objects.

Now, each time a char in your text matches the *suffix part* of a “font” object’s name, this object is duplicated on this char. *The original chars remain visible*. The objects are duplicated so that their center is positioned at the *lower right corner* of the corresponding chars.

Note

You can enter the Edit mode with the standard hotkey. But you cannot switch back to Object mode with the standard hotkey. Since this hotkey gets count as input for the text object in Edit mode. You have to use the mode drop-down box to leave the Edit mode.

Editing Text

Editing text is different from other object types in Bforartists. You edit on the one hand a curve type object, but also a text. And so the text editing standards applies. Like hitting backspace to delete parts of the text.

Inserting Text

You can type in new text. You can also copy text from a text editor and paste it. Or you can load a text file.

To load text from a text file, use the Edit / Paste File tool. This will bring up a *File Browser* window for navigating to a valid UTF-8 file.

Accent Characters

WARNING

Note that this feature is broken by Blender design. A Bug report to fix it was rejected.

The hotkey alone is a challenge. Press the keys in the wrong order and it will not work.

And not all UTF8 characters are supported. The default font just supports a fraction. This can partially be fixed by choosing another font. But the underlying code also just works for a fraction. It can be that not even the listed combinations in the manual here are working for you. There is a conflict with different keyboard layouts involved. And there is no documentation of further possible key combinations available.

When you want to work with special UTF8 characters, then we highly recommend to write this text in a text file and import this text file then.

You have been warned!

Many special characters can be “composed” using a combination of two other characters. The hotkey for it is the character followed by Alt-Backspace followed by the desired key to produce the accent character. Note that the following key combinations works with the US keyboard layout, even when you use the german keyboard layout.

Some examples.

ã - A, Alt-Backspace, ~

á - A, Alt-Backspace, '

à - A, Alt-Backspace, Backslash

â - A, Alt-Backspace, ^

å - A, Alt-Backspace, O

æ - A, Alt-Backspace, E

^a - A, Alt-Backspace, Minus

ë - E, Alt-Backspace, "

ç - C, Alt-Backspace, Comma

¢ - C, Alt-Backspace, |

∅ - O, Alt-Backspace, Slash

§ - S, Alt-Backspace, S

† - |, Alt-Backspace, Minus

‡ - |, Alt-Backspace, =

© - O, Alt-Backspace, C

® - O, Alt-Backspace, R

™ - T, Alt-Backspace, M

½ - 1, Alt-Backspace, 2

÷ - Minus, Alt-Backspace, :

± - Minus, Alt-Backspace, Plus

Last Operator Add Text

Radius is in real the size of the Text object.

Align to view aligns the geometry to the chosen view. World, View or 3D cursor.

Note that this option is dysfunctional when you call the Adjust Last Operator panel from the Toolbar editor.

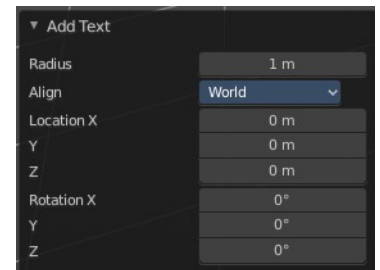

Location Adjust the location of the Text object.

Rotation defines the rotation of the Text object.

You can navigate the cursor with the arrow buttons. Enter adds a new paragraph. When you use the navigator you will see a last operator Move Cursor with further options.

Last Operator Move Cursor

Type

The different methods to set the cursor.

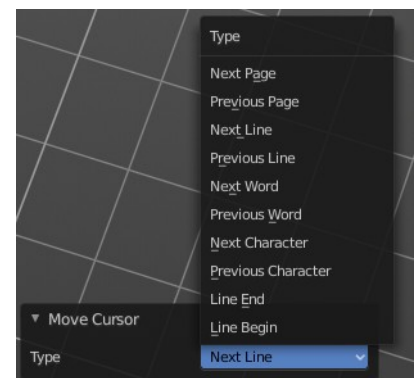

Point Cloud

Creates a object of type Point Cloud. Point clouds can represent 3D scans. It is also planned to represent particles in the future. Each point can store data in a set of Attributes. The attributes can be found in the Properties Editor in the Object Data Properties.

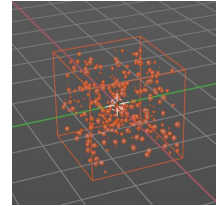

At the moment there is not this much that can be done with Point Clouds. But you can convert a object to a point cloud and vice versa.

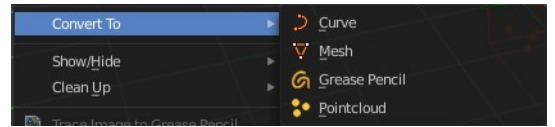

Last Operator Add Point Cloud

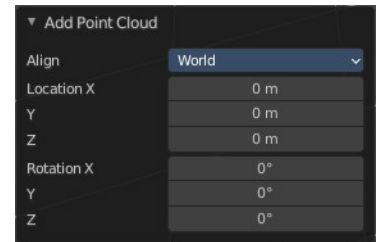

Align

How to orient the point cloud at creation.

Note that this option is dysfunctional when you call the Adjust Last Operator panel from the Toolbar editor.

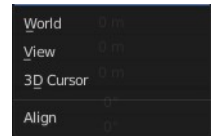

Location X Y Z

The position of the point cloud at creation.

Rotation X Y Z

The rotation of the point cloud at creation.

Volume

Add a volume object.

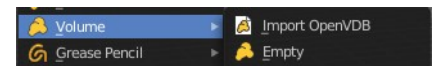

Import OpenVDB

Imports a volume object of type OpenVDB. This button opens a file browser.

Empty

Create an empty Volume object.

Last Operator Add Volume

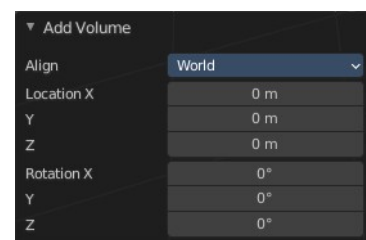

Align

How to orient the point cloud at creation.

Note that this option is dysfunctional when you call the Adjust Last Operator panel from the Toolbar editor.

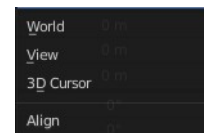

Location X Y Z

The position of the point cloud at creation.

Rotation X Y Z

The rotation of the point cloud at creation.

Grease Pencil

With a grease pencil object you can draw in the 3D viewport.

It starts as an object type. By switching into paint mode it becomes a paint feature. And editing turns it into a curve or a mesh object then.

It can be use to make traditional 2D animation, cut-out animation, motion graphics or use it as storyboard tool among other things.

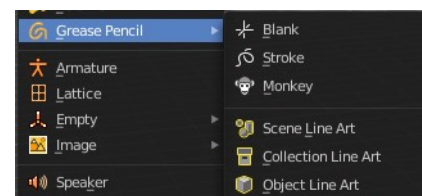

You add a grease pencil object, switch to draw mode, choose the color or add a new one. And when done with drawing you can manipulate the grease pencil object in edit mode or in weight paint mode even further.

The colors are materials.

In the Tools tab you will find all the options and settings for drawing and manipulating the grease pencil object, means your drawing.

Blank

Adds a blank grease pencil object with just one black color and no geometry.

Stroke

Adds a grease pencil stroke with some predefined colors.

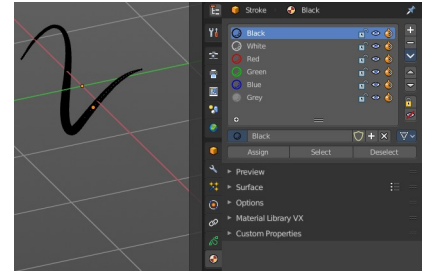

Monkey

Adds the drawing of a monkey as an example with some predefined colors.

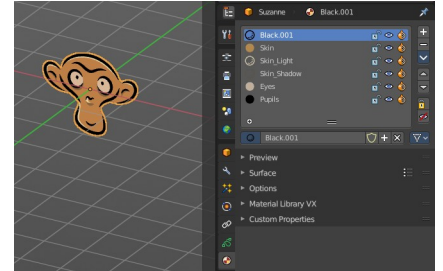

Scene Line Art

Line Art is a modifier for the grease pencil object. Scene Line Art adds a grease pencil object with the Line Art Modifier set up for the whole scene.

Collection Line Art

Line Art is a modifier for the grease pencil object. Scene Line Art adds a grease pencil object with the Line Art Modifier set up for a collection.

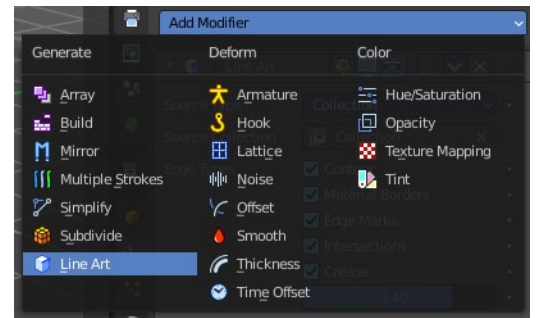

Object Line Art

This menu item just shows when you have a mesh object selected. Line Art is a modifier for the grease pencil object. Scene Line Art adds a grease pencil object with the Line Art Modifier set up for the selected mesh object.

Last Operator Add Grease Pencil

The Last Operator add Grease Pencil panel is for all grease pencil objects equal.

Radius is in real the size of the object.

Align aligns the geometry to the chosen view. World, View or 3D cursor.

Note that this option is dysfunctional when you call the Adjust Last Operator panel from the Toolbar editor.

Location Adjust the location of the surface.

Rotation defines the rotation of the surface.

Type Choose the grease pencil type.

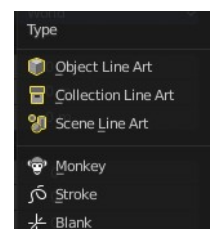
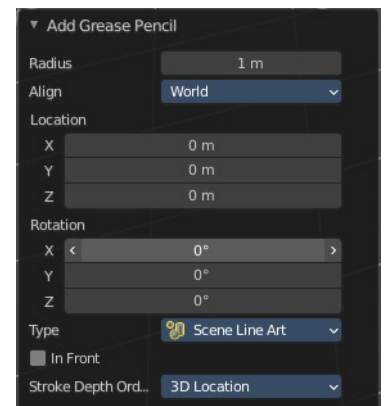

Line art types gives you further options.

In Front

Show the grease pencil line art in front of everything.

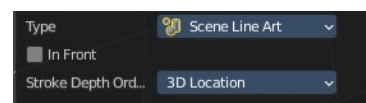

Stroke Depth Order

How to order the strokes.

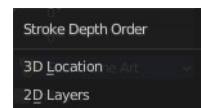

Armature

Armature adds the first bone of a skeleton. This bone can be further extended in edit mode. And you can animate the created skeleton in pose mode.

A bone has three elements. The start joint is called root or head. The body is called body. And the end joint is called tip or tail.

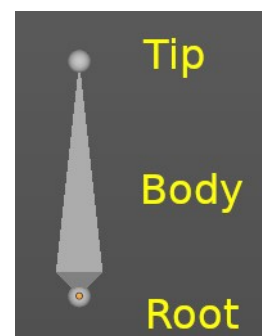

A bone can also have an influence area. The so called envelope.

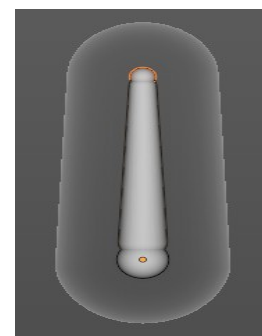

The bones of an armature can be edited in Edit mode. And posed in Pose mode.

Last Operator Add Armature

Radius is in real the size of the Armature object.

Align aligns the geometry to the chosen view. World, View or 3D cursor.

Note that this option is dysfunctional when you call the Adjust Last Operator panel from the Toolbar editor.

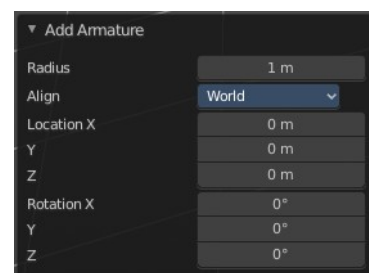

Location Adjust the location of the Armature object.

Rotation defines the rotation of the Armature object.

Lattice

A lattice object is a control cage to control deforming at another object.

Usage

Create a Lattice object.

Make sure it is bigger than the object that you want to deform, and is around this object.

Add a Lattice Modifier to the object that you want to deform.

In the Object box of the Lattice Modifier add our created Lattice object.

Select Lattice Object. Enter Edit mode. And here you can deform the Lattice Object now, and the object to deform will follow.

Last Operator Add Lattice object

Radius is in real the size of the Lattice object.

Type is a drop-down box choose any other object type to create.

Align aligns the geometry to the chosen view. World, View or 3D cursor.

Note that this option is dysfunctional when you call the Adjust Last Operator panel from the Toolbar editor.

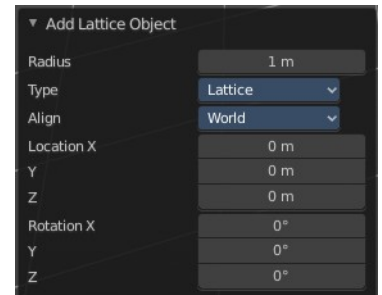

Location Adjust the location of the Lattice object.

Rotation defines the rotation of the Lattice object.

Empty

An Empty is an object without any data attached. It is basically just a container. It is empty. Empties can be used as anchor objects. Or as visible handlers at a skeleton for example.

The empty types differs just by how they gets displayed in the viewport.

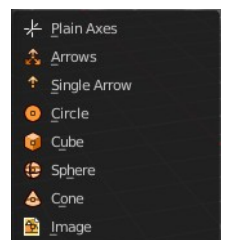

The empty of type image allows you to load an image to display the empty. This image can be adjusted and loaded in the object data panel of the empty object.

The image empty has also a transform widget, presented by the yellow color. It becomes visible when you hover with the mouse over the object.

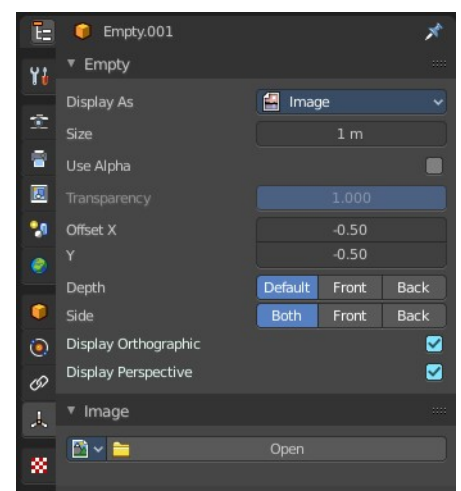
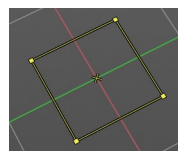

Empties, no matter what shape, does not render to file.

Last Operator Add Empty

Type is a drop-down box where you can define the type of Empty object.

Radius is in real the size of the Empty object.

Align aligns the geometry to the chosen view. World, View or 3D cursor.

Note that this option is dysfunctional when you call the Adjust Last Operator panel from the Toolbar editor.

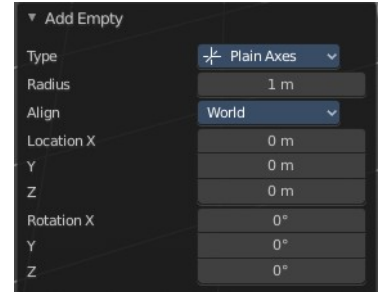

Location Adjust the location of the Empty object.

Rotation defines the rotation of the Empty object.

Image

Image objects allows you to import and display images in the viewport. Image objects are nothing else than Empties of type Image. So in the outliner they will show up as empties.

When you create an image object, then the file browser opens, choose the image that you want to use as the reference image. It loads with the correct ratio.

Neither reference images nor background images does render to file. They are just meant to display images in the viewport.

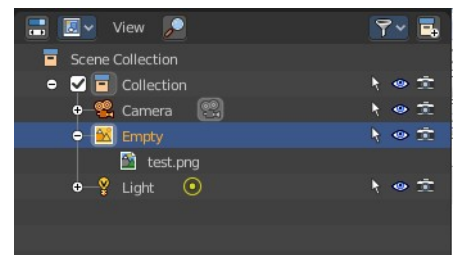
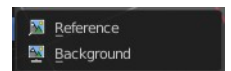

Reference

A reference image is for example used to model along the shape of a car at an image.

The image has also a transform widget, presented by the yellow color. It becomes visible when you hover with the mouse over the object.

Important, the reference image loads oriented in the current screen orientation. So when you need the image in the side view, then you should be in the side view when you create a reference image.

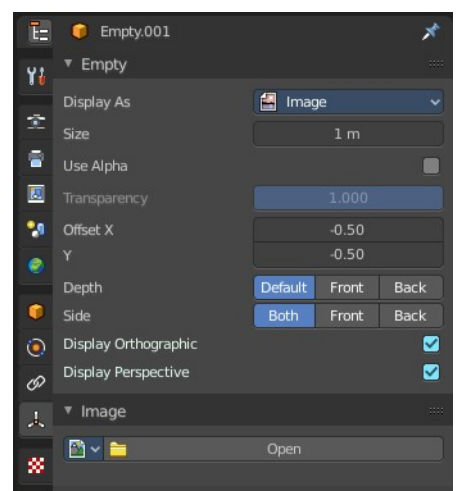
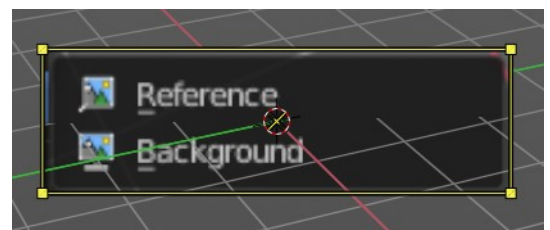

This image can be adjusted and changed in the object data panel of the object. Don't wonder about the panel name, which is Empty. As told above, the reference image is in fact nothing else than a special form of the image empty.

Background

Background images are meant to display images in the background of the viewport, while rendering.

There is just one difference between a Reference and a Background image.

A reference image is double sided. A background image not. When you look from the back side, then it is transparent.

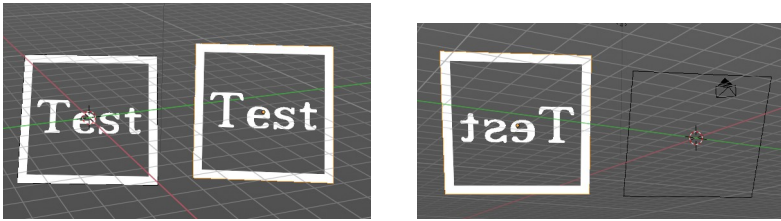

Speaker

A speaker object allows you to add a sound source to the scene. This can be used in a movie for example.

Last Operator Add Speaker

Align aligns the geometry to the chosen view. World, View or 3D cursor.

Note that this option is dysfunctional when you call the Adjust Last Operator panel from the Toolbar editor.

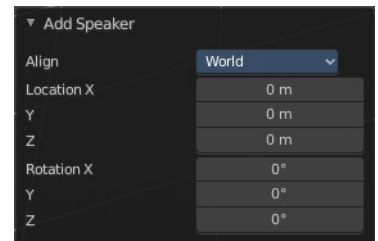

Location Adjust the location of the Speaker object.

Rotation defines the rotation of the Speaker object.

Camera

A camera object allows you to render your scene.

Camera objects can be further adjusted in the properties editor.

Last Operator Add Camera

Location Adjust the location of the Camera object.

Rotation defines the rotation of the Camera object.



Light

Lights lights the scene.

The lights that you add here lights the rendered scene. Not the scene in the viewport. Viewport lighting is managed in the viewport shading panel.



Lights can be further adjusted in the properties editor.

Point

Point creates a Point Light. A point light shines into all directions.

Sun

Sun creates a light that behaves like a sun. It's a directional light.

Spot

Spot creates a Spot light. It's a directional light.

Area

Area creates an Area light. It's a directional light.

Last Operator Add Light

The Last Operator add panel is for all lights equal.

Type is a drop-down box where you can change the light type.

Radius is in real the size of the lamp.

Align aligns the geometry to the chosen view. World, View or 3D cursor.

Note that this option is dysfunctional when you call the Adjust Last Operator panel from the Toolbar editor.

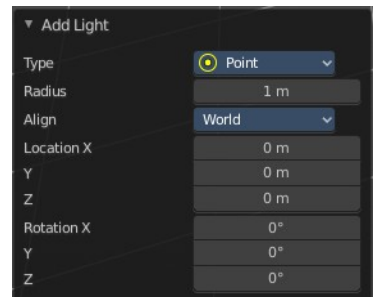

Location Adjust the location of the object.

Rotation defines the rotation of the object.

Light Probe

Light Probe objects are used by the Eevee render engine as support objects. They precompute lighting information locally in order to light the scene using indirect lighting. Which speeds things up.

There are three different light probe types. One for diffuse light lighting, two for specular lighting.

Light probes are a feature for real time render engines. This means Light probes does not work for the other renderers in Bforartists. Just in Eevee.

The light probes can be further adjusted in the Properties Editor.

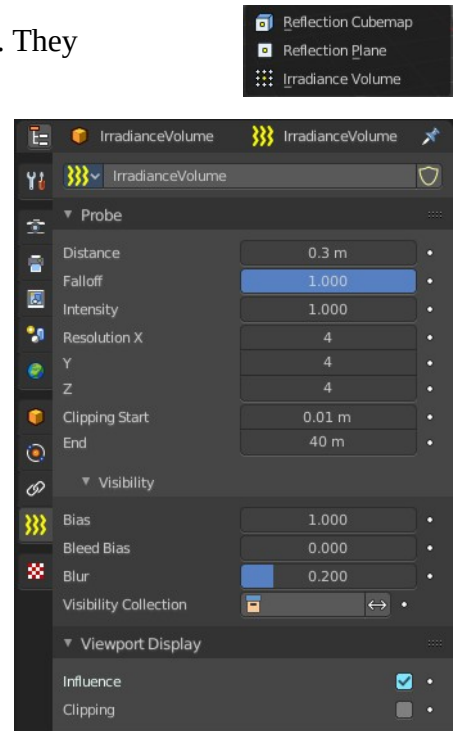

To work with the light probes you need to bake them. Baking lightprobes happens in the render properties tab in the indirect lighting panel.

Reflection Cubemap

Adds a reflective light probe in cubemap shape.

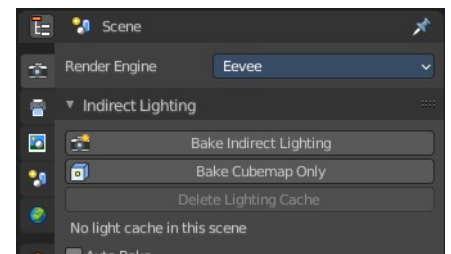

Reflection Plane

Adds a reflective light probe in plane shape.

Irradiance Volume

Adds a volumetric array light probe.

Last Operator Add Light Probe

The Last Operator add panel is for all light probes equal.

Type is a drop-down box where you can change the light type.

Radius is in real the size of the light probe.

Align aligns the geometry to the chosen view. World, View or 3D cursor.

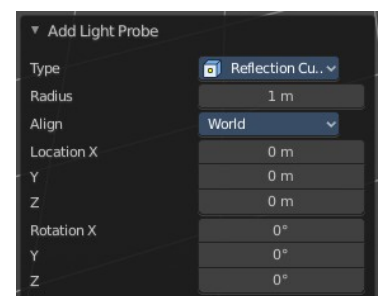

Note that this option is dysfunctional when you call the Adjust Last Operator panel from the Toolbar editor.

Location Adjust the location of the object.

Rotation defines the rotation of the object.

Force Field

A Force Field is for physical simulations. It provides you with tools to add different forces to objects. Wind, Smoke, Gravity, Magnetic, etc. .

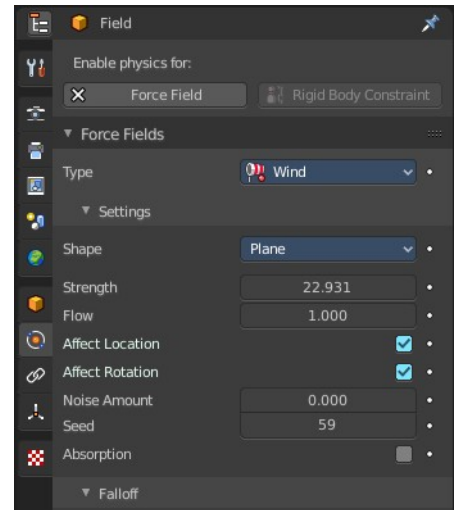

The added Force Fields can be further adjusted in the Properties panel.

A Force Field is internally also called Effector. So our Last Operator panel has the title Add Effector.

Last Operator Add Effector

Type is a drop-down box where you can define the type of Effector.

Radius is in real the size of the Effector.

Align aligns the geometry to the chosen view. World, View or 3D cursor.

Note that this option is dysfunctional when you call the Adjust Last Operator panel from the Toolbar editor.

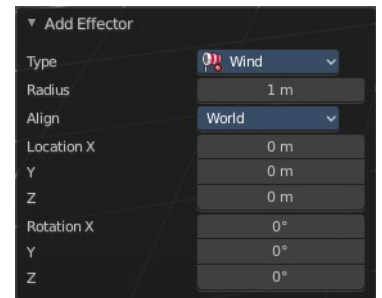

Location Adjust the location of the Effector.

Rotation defines the rotation of the Effector.

Collection Instance

Add an instance of an existing collection. By default it is just one. But the menu lists all available collections in the scene.

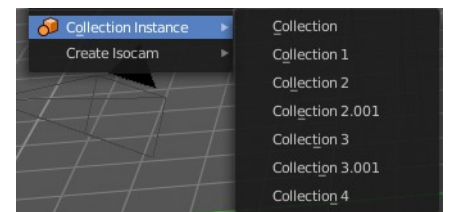

Last Operator Add Collection Instance

Name Name your new collection.

Radius A drop down box choose the collection.

Align aligns the geometry to the chosen view. World, View or 3D cursor.

Note that this option is dysfunctional when you call the Adjust Last Operator panel from the Toolbar editor.

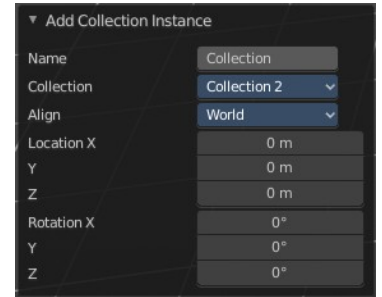

Location Adjust the location of the collection.

Rotation defines the rotation of the collection.

Create Isocam

The add menu is also a common menu where addons adds their entries. Create Isocam is such an add-on. It comes with Bforartists, and is activated by default.

Create Isocam is a script that creates an orthographic camera with which you can render isometric views for 2d isometric games. You can of course set the whole thing up by hand. This script saves you the work though.

True Isocam

Creates a camera that has the mathematical isometric angles compared to the ground plane.

The camera has a rotation of 54.736 degrees.

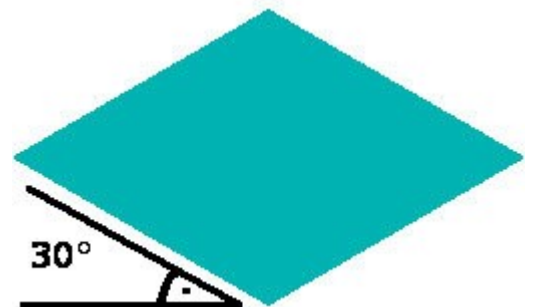

Game Isocam

Creates a camera that has the isometric angles for a 2d isometric game. This angle differs a bit from the mathematical angle. With the mathematical angle we would get some not fitting stairs.



With the angle of 60 degrees for the camera we get a fitting result for an isometric game tile with the common 2:1 ratio.



GameIso4to3cam

There is another special view that fits together like the one with the 2:1 ratio . Here we don't have a base tile of 64×32 and a ratio of 2:1, but one with 64×48 and a ratio of 4:3. It is of course not a power of two graphics anymore.

And far away from the true isometric view. But the old graphics card limits are long gone. And when you need a more top down view, then this is perfect.

For that the camera has a rotation of 41.5 Grad.



Ground plane

Adds a ground plane that fits into the camera view of the iso cams.



7.1.7 Editors - 3D Viewport - Header - Edit mode - Add menu

Table of content

Edit Mode - Add Menu.....1
 Last Operator.....1

Edit Mode - Add Menu

In Edit Mode you will see a add menu for some object types. The number of objects that you can add in edit mode is limited to the same object type that you are in edit mode with. You can just add mesh geometry to a mesh geometry. And just curve geometry to curve geometry.

The added objects in edit mode becomes part of the current object geometry. It is one object.

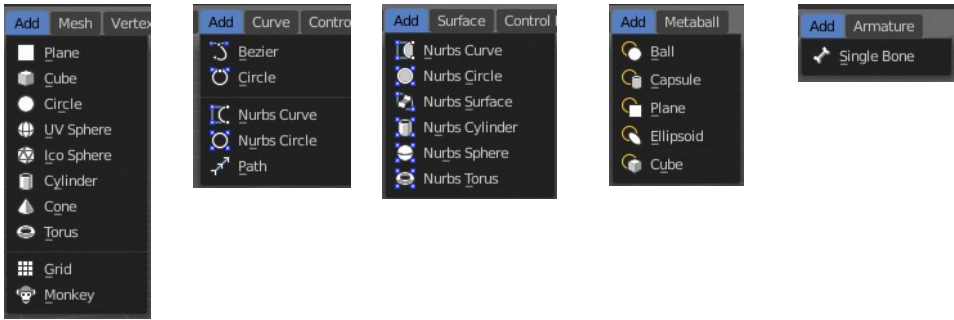

Last Operator

The last operators are the same than in object mode. Please read the add menu chapter in object mode.

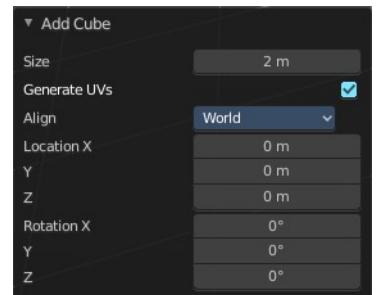



7.1.8 Editors - 3D Viewport - Header - Object menu

Table of content

Detailed Table of content.....	3
Object menu.....	9
Transform.....	10
To Sphere.....	10
Shear.....	11
Bend.....	12
Push/Pull.....	12
Move Texture Space.....	13
Scale Texture Space.....	14
Align to Transform Orientation.....	15
Randomize Transform.....	16
Align Objects.....	16
Set Origin.....	17
Geometry to Origin.....	17
Origin to Geometry.....	17
Origin to 3D cursor.....	17
Origin to Center of Mass(Surface).....	17
Origin to Center of Mass(Volume).....	17
Mirror.....	18
Interactive Mirror.....	18
X Y Z Global.....	18
X Y Z Local.....	18
Clear.....	19
Clear.....	19
Apply.....	19
Apply.....	20
Visual Transform.....	21
Make Instances Real.....	21
Parent Inverse.....	21
Snap.....	21
Selection to Cursor.....	21
Selection to Cursor(Keep Offset).....	21
Selection to Active.....	22
Selection to Grid.....	22
Cursor to Selected.....	22
Cursor to World Origin.....	22
Cursor to Active.....	22
Cursor to Grid.....	22
From Duplicate ... to Paste.....	22
Duplicate Objects.....	22
Duplicate Linked.....	23
Join.....	25
Delete.....	25
Delete Global.....	25
Copy.....	26
Paste.....	26
Asset.....	26

Mark as asset.....	26
Clear Asset.....	26
Clear Asset(Set Fake User).....	26
Parent.....	26
Object.....	27
Object (Keep Transform).....	27
Object (Without Inverse).....	27
Object (Keep Transform Without Inverse).....	27
Armature Deform.....	27
With empty Groups.....	27
With automatic Weights.....	28
Bone.....	28
Bone Relative.....	28
Curve Deform.....	28
Follow Path.....	29
Path Constraint.....	29
Lattice Deform.....	29
Vertex.....	30
Vertex (Triangle).....	30
Last Operator Make Parent.....	31
Object (Without Inverse).....	31
Object (Keep Transform Without Inverse).....	31
Clear Parent.....	31
Clear and Keep Transformation.....	31
Clear Parent Inverse.....	31
Relations.....	32
Make Library Override.....	32
Make Instance Face.....	32
Make Local.....	33
Make Single User.....	33
Constraints.....	33
Track.....	35
Damped Track Constraint.....	35
Track to Constraint.....	35
Lock Track Constraint.....	36
Link / Transfer Data.....	36
Link Object to Scene.....	36
Object Data, Materials .. etc.....	37
Copy UV Maps.....	37
Transfer Mesh Data.....	37
Transfer Mesh Data Layout.....	39
Move to Collection.....	40
Shade Smooth, Shade Auto Smooth and Shade Flat.....	40
Shade Smooth.....	40
Shade Auto Smooth.....	41
Shade Flat.....	41
Animation.....	41
Insert Keyframe.....	41
Delete Key frame.....	42
Clear Key frames.....	42
Bake Action.....	42
Bake Mesh to Grease Pencil.....	43
Bake Mesh Animation to Grease Pencil.....	43

Bake Object Transform to Grease Pencil.....	44
Rigid Body.....	45
Add Active.....	45
Add Passive.....	46
Remove.....	46
Change shape.....	46
Calculate Mass.....	46
Quick Effects.....	46
Quick Fur.....	47
Quick Explode.....	47
Quick Smoke.....	47
Quick Fluid.....	47
Subdivide.....	48
Last Operator Subdivision Set.....	48
Convert to.....	48
Curve.....	48
Mesh.....	49
Grease Pencil.....	49
Point Cloud.....	49
Show/Hide.....	49
Show Hidden.....	49
Hide Selected.....	49
Hide Unselected.....	50
Clean Up.....	50
Clean Vertex Groups.....	50
Limit Total Vertex Groups.....	50
Remove Unused Material Slots.....	50

Detailed Table of content

Detailed table of content

Detailed Table of content.....	3
Object menu.....	9
Transform.....	10
To Sphere.....	10
Usage.....	10
Last Operator To Sphere.....	10
Factor.....	10
Proportional editing.....	10
Proportional Falloff.....	10
Proportional Size.....	10
Connected.....	10
Projected(2D).....	10
Shear.....	11
Last Operator Shear.....	11
Offset.....	11
Shear Axis.....	11
Axis.....	11
Axis Ortho.....	11

Orientation.....	11
Proportional editing.....	11
Proportional Falloff.....	11
Proportional Size.....	11
Connected.....	11
Projected(2D).....	12
Bend.....	12
Push/Pull.....	12
Last Operator Push/Pull.....	12
Factor.....	12
Proportional editing.....	12
Proportional Falloff.....	12
Proportional Size.....	12
Connected.....	12
Projected(2D).....	12
Move Texture Space.....	13
Last Operator Move.....	13
Move.....	13
Orientation.....	13
Proportional editing.....	13
Proportional Falloff.....	13
Proportional Size.....	13
Connected.....	13
Projected(2D).....	14
Scale Texture Space.....	14
Last Operator Resize.....	14
Move.....	14
Orientation.....	14
Proportional editing.....	14
Proportional Falloff.....	14
Proportional Size.....	14
Connected.....	14
Projected(2D).....	14
Align to Transform Orientation.....	14
Last Operator Transform.....	15
Values.....	15
Axis.....	15
Orientation.....	15
Proportional editing.....	15
Proportional Falloff.....	15
Proportional Size.....	15
Connected.....	15
Projected(2D).....	15
Randomize Transform.....	15
Last Operator Randomize Transform.....	16
Random Seed.....	16
Transform Delta.....	16
Randomize Location checkbox.....	16
Location edit boxes.....	16
Randomize Rotation checkbox.....	16
Rotation edit boxes.....	16
Randomize Scale checkbox.....	16
Scale Even.....	16

Scale edit boxes.....	16
Align Objects.....	16
Last Operator Align Objects.....	16
High Quality.....	16
Align Mode.....	16
Relative To.....	17
Align.....	17
Set Origin.....	17
Geometry to Origin.....	17
Origin to Geometry.....	17
Origin to 3D cursor.....	17
Origin to Center of Mass(Surface).....	17
Origin to Center of Mass(Volume).....	17
Last Operator Set Origin.....	17
Type.....	17
Center.....	17
Mirror.....	17
Interactive Mirror.....	18
Usage:.....	18
X Y Z Global.....	18
X Y Z Local.....	18
Last Operator Mirror.....	18
Orientation.....	18
Proportional editing.....	18
Proportional Falloff.....	18
Proportional Size.....	18
Connected.....	18
Projected(2D).....	18
Clear.....	18
Clear.....	18
Location.....	19
Last Operator Clear Location.....	19
Clear Delta.....	19
Rotation.....	19
Last Operator Clear Rotation.....	19
Clear Delta.....	19
Scale.....	19
Last Operator Clear Scale.....	19
Clear Delta.....	19
Origin.....	19
Apply.....	19
Apply.....	19
Location, Rotation, Scale, All Transforms and Rotation&Scale.....	20
Last Operator Apply Object Transform.....	20
Location.....	20
Rotation.....	20
Scale.....	20
Apply Properties.....	20
Location, Rotation, Scale and All Transforms to Deltas.....	20
Last Operator Transforms to Deltas.....	20
Mode.....	20
Reset Values.....	20
Animated Transform to Deltas.....	20

Visual Transform.....	21
Make Instances Real.....	21
Last Operator Make Instances Real.....	21
Parent.....	21
Keep Hierarchy.....	21
Parent Inverse.....	21
Snap.....	21
Selection to Cursor.....	21
Selection to Cursor(Keep Offset).....	21
Last operator Snap Selection to Cursor.....	21
Offset.....	21
Selection to Active.....	21
Selection to Grid.....	21
Cursor to Selected.....	22
Cursor to World Origin.....	22
Cursor to Active.....	22
Cursor to Grid.....	22
From Duplicate ... to Paste.....	22
Duplicate Objects.....	22
Last Operator Duplicate.....	22
Duplicate Objects.....	22
Linked.....	22
Move X , Y , Z.....	22
Orientation.....	22
Proportional editing.....	23
Proportional Falloff.....	23
Proportional Size.....	23
Connected.....	23
Projected(2D).....	23
Duplicate Linked.....	23
Last Operator Duplicate Linked.....	24
Duplicate Objects.....	24
Linked.....	24
Move X, Y, Z.....	24
Orientation.....	24
Proportional editing.....	25
Proportional Falloff.....	25
Proportional Size.....	25
Connected.....	25
Projected(2D).....	25
Join.....	25
Delete.....	25
Delete Global.....	25
Copy.....	25
Paste.....	25
Last Operator Paste Selection from Buffer.....	26
Select.....	26
Active Collection.....	26
Asset.....	26
Mark as asset.....	26
Clear Asset.....	26
Clear Asset(Set Fake User).....	26
Parent.....	26

Object.....	27
Object (Keep Transform).....	27
Armature Deform.....	27
With empty Groups.....	27
With automatic Weights.....	27
Bone.....	27
Bone Relative.....	27
Curve Deform.....	28
Follow Path.....	28
Path Constraint.....	29
Lattice Deform.....	29
Vertex.....	30
Vertex (Triangle).....	30
Last Operator Make Parent.....	30
Type.....	30
Object (without inverse).....	31
Clear Parent.....	31
Clear and Keep Transformation.....	31
Clear Parent Inverse.....	31
Last Operator Clear Parent.....	31
Relations.....	31
Make Library Override.....	31
Make Instance Face.....	32
Usage:.....	32
Make Local.....	33
Make Single User.....	33
Constraints.....	33
Add Constraints (With Targets).....	33
Last Operator Add Constraints (with Target).....	34
Type.....	34
Copy Constraints to Selected Objects.....	34
Clear Object Constraints.....	34
Track.....	35
Damped Track Constraint.....	35
Track to Constraint.....	35
Lock Track Constraint.....	35
Clear Track.....	35
Last Operator Clear track.....	35
Type.....	35
Clear Track - Keep Transformation.....	36
Last Operator Clear track.....	36
Type.....	36
Link / Transfer Data.....	36
Link Object to Scene.....	36
Object Data, Materials .. etc.....	36
Last Operator Link Data.....	37
Type.....	37
Copy UV Maps.....	37
Transfer Mesh Data.....	37
Last Operator Transfer Mesh Data.....	37
Freeze Operator.....	37
Data Type.....	37
Create Data.....	37

Edge Mapping.....	37
Topology.....	37
Nearest Vertice.....	38
Nearest Edge.....	38
Nearest Face Edge.....	38
Projected Edge Interpolation.....	38
Auto Transform.....	38
Only Neighbor Geometry.....	38
Max Distance.....	38
Ray Radius.....	38
Mix Mode.....	38
Below Threshold.....	38
Above Threshold.....	38
Replace.....	38
Mix Factor.....	38
Transfer Mesh Data Layout.....	39
Last Operator Transfer Mesh Data Layout.....	39
Data Type.....	39
Exact Match.....	39
Source Layers Selection.....	39
Mygroup.....	39
Active Layer.....	39
All Layers.....	39
Destination Layers Matching.....	39
By Name.....	39
By Order.....	39
Active Layer.....	39
Shade Smooth, Shade Auto Smooth and Shade Flat.....	40
Shade Smooth.....	40
Shade Auto Smooth.....	40
Shade Flat.....	40
Animation.....	40
Insert Keyframe.....	40
Insert Keyframe Menu.....	41
Delete Key frame.....	41
Clear Key frames.....	41
Bake Action.....	41
Last Operator Bake Action.....	41
Start Frame.....	41
End Frame.....	41
Frame Step.....	42
Only Selected Bones.....	42
Visual Keying.....	42
Clear Constraints.....	42
Clear Parents.....	42
Overwrite current Action.....	42
Bake Data.....	42
Bake Mesh to Grease Pencil.....	42
Bake Mesh Animation to Grease Pencil.....	42
Target Object.....	42
Start Frame.....	42
End Frame.....	42
Step.....	42

Thickness.....	43
Threshold Angle.....	43
Stroke Offset.....	43
Only Seam Edges.....	43
Export Faces.....	43
Only Selected Keyframes.....	43
Target Frame.....	43
Projection Type.....	43
OK.....	43
Last Operator Bake Mesh Animation to Grease Pencil.....	43
Bake Object Transform to Grease Pencil.....	44
Bake Transform to Grease Pencil panel.....	44
Start Frame.....	44
End Frame.....	44
Only selected Keyframes.....	44
Target Frame.....	44
Projection Type.....	44
Last Operator Bake Transform to Grease Pencil panel.....	44
Rigid Body.....	45
Add Active.....	45
Add Passive.....	45
Last Operator Add Rigid bodies.....	45
Remove.....	45
Change shape.....	45
Last Operator Change Collision shape.....	45
Calculate Mass.....	45
Last Operator Calculate Mass.....	46
Material Preset.....	46
Density.....	46
Quick Effects.....	46
Quick Fur.....	46
Quick Explode.....	46
Quick Smoke.....	46
Quick Fluid.....	47
Subdivide.....	47
Last Operator Subdivision Set.....	47
Level.....	47
Relative.....	47
Convert to.....	48
Curve.....	48
Mesh.....	48
Grease Pencil.....	48
Point Cloud.....	48
Last Operator Convert to.....	48
Target.....	48
Target Point Cloud, Mesh, Curve.....	48
Keep Original.....	48

Object menu

The object menu in Object mode provides you with tools to work at Object level.

It contains things like undo redo, copy and paste, delete and other general tools. But also some object specific tools, like the Convert to menu. Or Transform items, and many more.

There are lots of tools in this menu. So we will divide it into sub chapters.

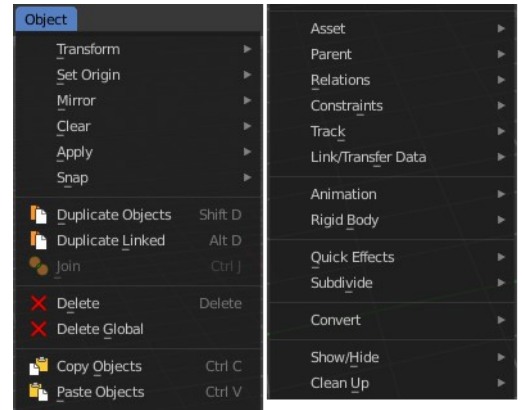

Transform

The transform sub menu contains functionality for some kind of transformations.

To Sphere

Shapes a selection of objects into the shape of a sphere. The calculation happens with the object origins.

In Object mode this tool requires to have more than one object selected.

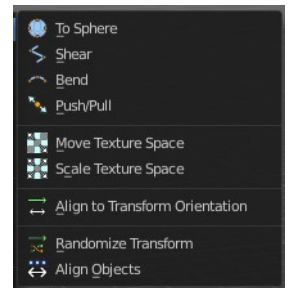

Usage

Select the objects, activate the tool, then drag the mouse in the 3D viewport. In the header you will read the current factor then. Which tells you how close you are towards the sphere shape.

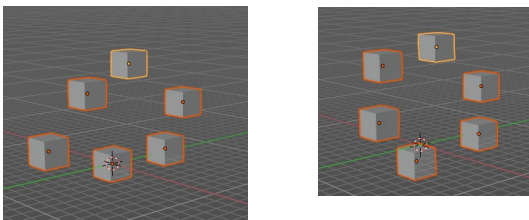
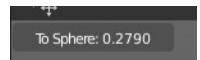

Last Operator To Sphere

Factor

The factor to transform the selection into a sphere form.

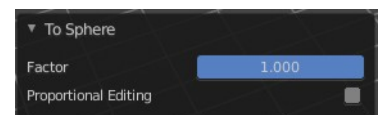

Proportional editing

Enables proportional editing. Activating proportional editing reveals further settings.

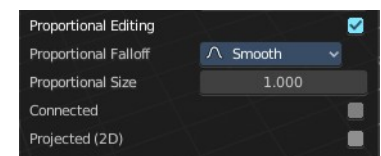

Proportional Falloff

Adjust the falloff methods.

Proportional Size

See and adjust the falloff radius.

Connected

The proportional falloff gets calculated for connected parts only.

Projected(2D)

The proportional falloff gets calculated in the screen space. Depth doesn't play a role. When it's in the radius, then it gets calculated.

Shear

Shear shears the selection.

In Object mode this tool requires to have more than one object selected.

Last Operator Shear

Offset

Adjust an offset.

Shear Axis

The shear tool works along a imaginary 2d plane. The shear axis controls if the items are sheared along the x or the y axes of this plane. This is the plane along which the transformation happens. You can shear along the x or the y axis of this plane.

To make things even more complicated, the orientation of this imaginary plane is defined by the Axis and Axis Ortho items below.

Axis

Defines one axis of the imaginary shear axis plane.

Axis Ortho

Defines the other axis of the imaginary shear axis plane.

Orientation

Choose the orientation for the shear action.

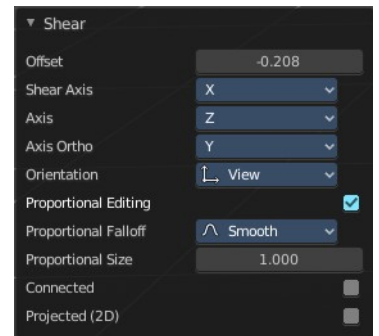

Proportional editing

Enables proportional editing. Activating proportional editing reveals further settings.

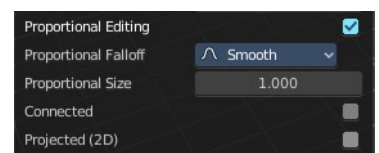
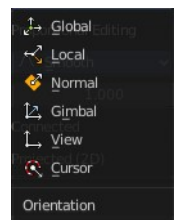

Proportional Falloff

Adjust the falloff methods.

Proportional Size

See and adjust the falloff radius.

Connected

The proportional falloff gets calculated for connected parts only.

Projected(2D)

The proportional falloff gets calculated in the screen space. Depth doesn't play a role. When it's in the radius, then it gets calculated.

Bend

Bends the selection.

In Object mode this tool requires to have more than one object selected.

Push/Pull

It pushes or pulls the object positions relative to the center of the selection.

In Object mode this tool requires to have more than one object selected.

Last Operator Push/Pull

Factor

Adjust the strength of influence of the tool.

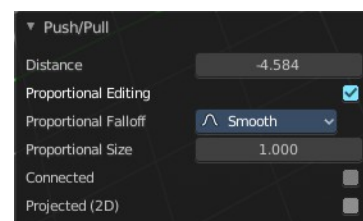

Proportional editing

Enables proportional editing. Activating proportional editing reveals further settings.

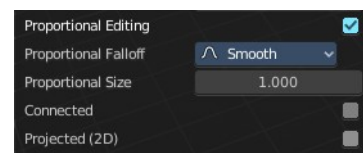

Proportional Falloff

Adjust the falloff methods.

Proportional Size

See and adjust the falloff radius.

Connected

The proportional falloff gets calculated for connected parts only.

Projected(2D)

The proportional falloff gets calculated in the screen space. Depth doesn't play a role. When it's in the radius, then it gets calculated.

Move Texture Space

This tool relies at the move tool. With the difference that it moves the texture space instead of the object. It has also a very special use case, and just works with a material with a Texture Coordinate / Generated node. And requires to have the shading at Material or Rendered to see a result in the viewport.

The yellow cage represents the texture space. The actual UV mapping does not change.

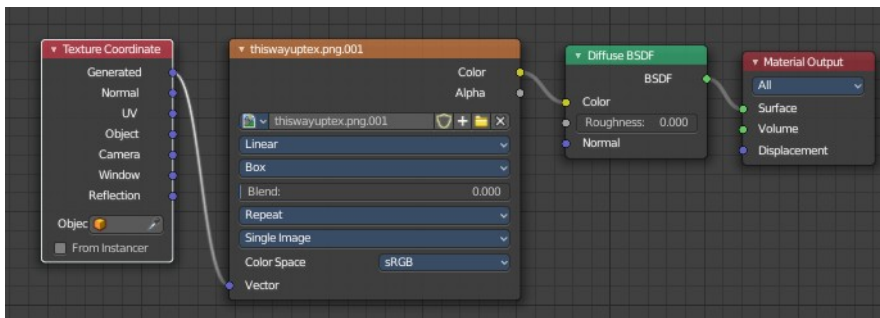
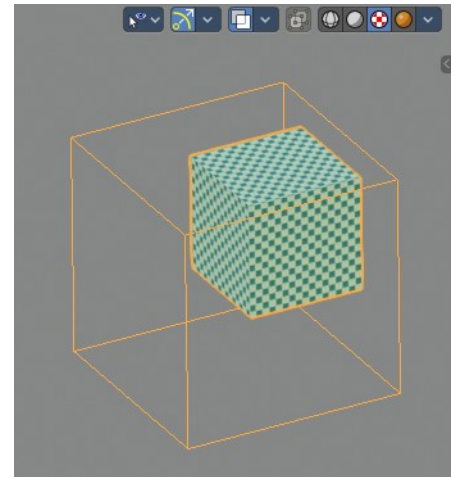

Last Operator Move

Move

Adjust in which directions you want to transform.

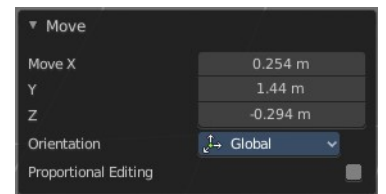

Orientation

Choose the orientation.

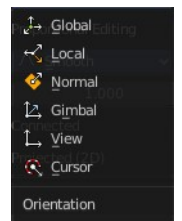

Proportional editing

Enables proportional editing. Activating proportional editing reveals further settings.

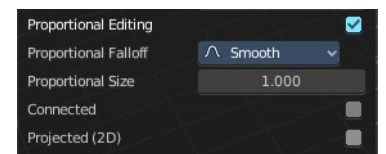

Proportional Falloff

Adjust the falloff methods.

Proportional Size

See and adjust the falloff radius.

Connected

The proportional falloff gets calculated for connected parts only.

Projected(2D)

The proportional falloff gets calculated in the screen space. Depth doesn't play a role. When it's in the radius, then it gets calculated.

Scale Texture Space

Scale Texture space is similar to the Move texture Space. With the only difference that it scales the UV space instead of moving it.

Last Operator Resize

Move

Adjust in which directions you want to transform.

Orientation

Choose the orientation.

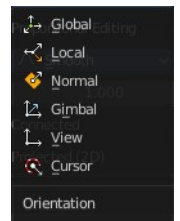
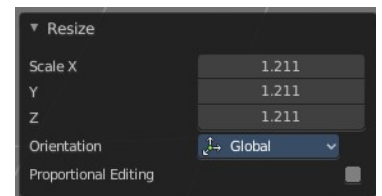

Proportional editing

Enables proportional editing. Activating proportional editing reveals further settings.

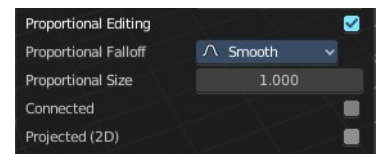

Proportional Falloff

Adjust the falloff methods.

Proportional Size

See and adjust the falloff radius.

Connected

The proportional falloff gets calculated for connected parts only.

Projected(2D)

The proportional falloff gets calculated in the screen space. Depth doesn't play a role. When it's in the radius, then it gets calculated.

Align to Transform Orientation

Align to Transform Orientation rotates the selected objects so that their local orientation matches the active transform orientation in the Transform orientation panel or the Orientation selection in the Transform Operator panels.

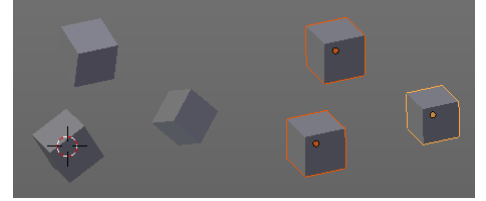

For example when you have a few cubes that are rotated differently, then perform align to transform orientation with Global coordinates, then the cubes rotations gets set back to 0/0/0

Last Operator Transform

Values

These values can't be edited. The tool aligns to zero, so the values turns to zero.

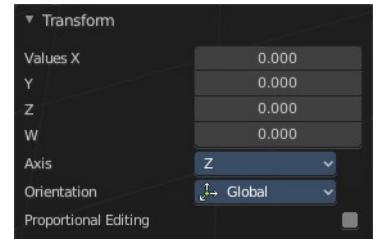

Axis

These values doesn't matter. Changing them does nothing.

Orientation

Choose the orientation in which the transform should happen.

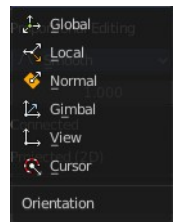

Proportional editing

Enables proportional editing. Activating proportional editing reveals further settings.

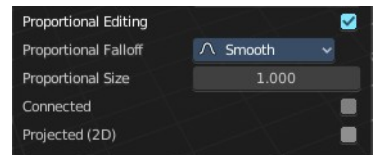

Proportional Falloff

Adjust the falloff methods.

Proportional Size

See and adjust the falloff radius.

Connected

The proportional falloff gets calculated for connected parts only.

Projected(2D)

The proportional falloff gets calculated in the screen space. Depth doesn't play a role. When it's in the radius, then it gets calculated.

Randomize Transform

This tool allows to randomize position rotation and scale of selected objects. Each object gets threaten individually by a random value.

It starts with zeroed values. You need to adjust the values in the last operator.

Last Operator Randomize Transform

Random Seed

Adjust the random seed value.

Transform Delta

Randomize Delta transform values instead of the regular transform values.

Randomize Location checkbox

With this checkbox ticked the location of the selected objects gets randomize

Location edit boxes

Adjust the strength of the transform for the single axis.

Randomize Rotation checkbox

With this checkbox ticked the rotation of the selected objects gets randomize

Rotation edit boxes

Adjust the strength of the transform for the single axis.

Randomize Scale checkbox

With this checkbox ticked the scale of the selected objects gets randomized.

Scale Even

Use the same scale values for all axis.

Scale edit boxes

Adjust the strength of the transform for the single axis.

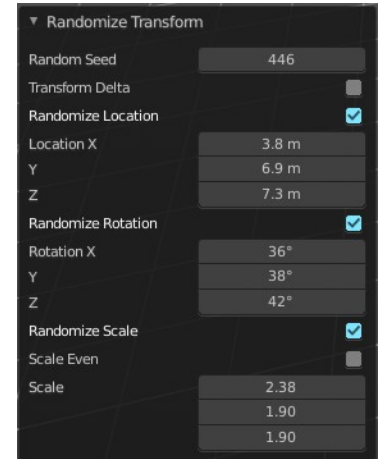

Align Objects

Align Objects allows you to align the selected objects in various ways. You need to adjust the settings in the Last operator panel. The align operation happens in world coordinates.

Last Operator Align Objects

High Quality

When ticked the calculation gets performed in a higher precision.



Align Mode

Align Mode is a drop-down box choose between different align modes.

Relative To

Relative to is a drop-down box. Here you adjust in what method the alignment happens.

Relative to the active object, to the center of selection, to the 3D cursor or to the scene origin.

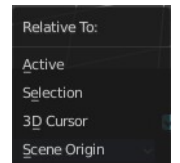
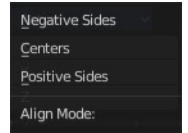

Align

Turn on or off the single axis for the align operation.

Set Origin

Set origin sets the origin of the selected objects to a chosen location.

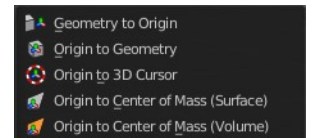

Geometry to Origin

Sets the geometry to origin.

Origin to Geometry

Sets the origin to geometry.

Origin to 3D cursor

Sets the origin to the 3D cursor.

Origin to Center of Mass(Surface)

Sets the origin to the center of mass, calculating it from the center of the surface area.

Origin to Center of Mass(Volume)

Sets the origin to the center of mass, calculating from the center of the Volume. It must be manifold geometry with consistent normals.

Last Operator Set Origin

The last operator is the same for all set origin methods.

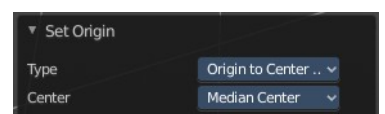

Type

Choose the method again.

Center

Use the median center or the bounds center for calculation.

Mirror

Mirrors the selection.

Interactive Mirror

Mirrors the selection.



Usage:

Activate the tool. In the header you will now see further instructions. Which is: type in the axis at which you want to mirror. Interactive mirroring starts in Global space. You can change the orientation in the last operator.

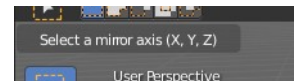

X Y Z Global

Mirrors along the global axis.

X Y Z Local

Mirrors along the object axis.

Last Operator Mirror

Orientation

Choose the orientation in which the transform should happen.

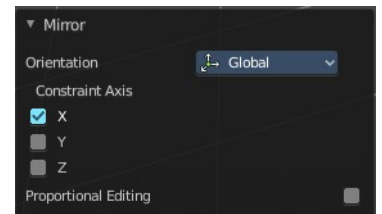
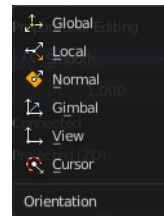

Proportional editing

Enables proportional editing. Activating proportional editing reveals further settings.

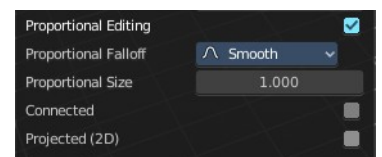

Proportional Falloff

Adjust the falloff methods.

Proportional Size

See and adjust the falloff radius.

Connected

The proportional falloff gets calculated for connected parts only.

Projected(2D)

The proportional falloff gets calculated in the screen space. Depth doesn't play a role. When it's in the radius, then it gets calculated.

Clear

Clear

Clear Transform is a menu where you can clear the transform for location, rotation, scale and Origin. Clear means in this conjunction that the values gets reset.

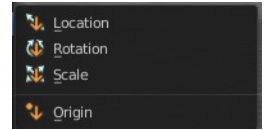

When you have for example a cube at X 5, and clear the location, then the cube gets positioned at position X 0.

Location

Resets the location of the selected object(s).

Last Operator Clear Location

Clear Delta

With Clear Delta ticked it clears the delta transform instead of the transform.



Rotation

Resets the rotation of the selected object(s).

Last Operator Clear Rotation

Clear Delta

With Clear Delta ticked it clears the delta transform instead of the transform.



Scale

Resets the scaling of the selected object(s).

Last Operator Clear Scale

Clear Delta

With Clear Delta ticked it clears the delta transform instead of the transform.



Origin

Clear Origin requires to have a parent child relationship selected. It sets the child object to the position of the parent object.

Apply

Apply

Apply is a menu where you can apply transforms in various combinations. For example, when you create a cube, then move it to let's say 3, then apply the location, then the origin gets set to 0. The position is "applied". Of special Interest is apply scale, since it resets the scale factor to 1.

Apply just works with single user objects. And it does **not apply to pose position, animation curves or constraints. These tools should be used before rigging and animation.**

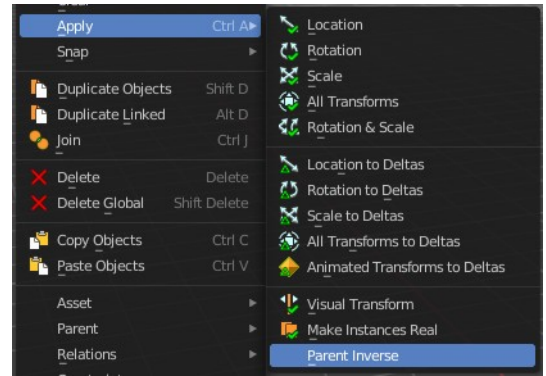

Location, Rotation, Scale, All Transforms and Rotation&Scale

This applies the location, rotation and scale of the object.

Last Operator Apply Object Transform.

Location

Applies the position, and resets origin to 0

Rotation

Applies the rotation.

Scale

Applies the Scale.

Apply Properties

Properties such as Curve Vertex Radius. Font Size and bone envelope gets applied.

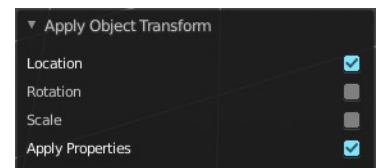

Location, Rotation, Scale and All Transforms to Deltas

Transforms are absolute to the world coordinates. Delta Transforms are relative to the current transformation.

The delta transform values can be found in the Object properties, in the Delta Transform Panel.

Example use case:

Key frame a object rotation from 0 to 90 degrees. Rotate the object by 45 degrees. When you play the animation it will still rotate from 0 to 90 degrees.

Now key frame a delta rotation from 0 to 90 degrees and rotate the object by 45 degrees. When you playback the animation it will rotate from 45 to 135 degrees now. (a 90 degree difference from the current state)

Last Operator Transforms to Deltas

Mode

Mode is a drop-down box choose the transform mode again.

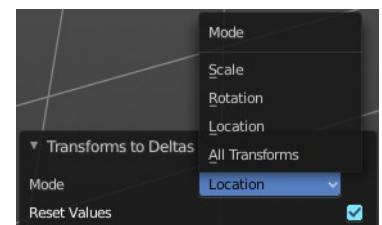

Reset Values

Clears the transform values after transferring to Deltas.

Animated Transform to Deltas

Converts the “normal” transformation animations to Delta transforms. This tool requires to have key frames at the object.

Visual Transform

Applies (set) the result of a constraint, and applies this back to the Object’s location, rotation and scale.

Make Instances Real

Make Instances real makes any duplicates attached to this Object real so that they can be edited.

Last Operator Make Instances Real

Parent

Parent newly created objects to the original duplicator.

Keep Hierarchy

Keep Parent Child relationship.

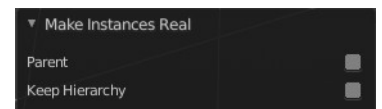

Parent Inverse

Applies the objects parent inverse to its data.

Snap

Selection to Cursor

Snaps the currently selected object(s) to the cursor location.

Selection to Cursor(Keep Offset)

Snaps the currently selected object(s) to the cursor location, but keeps the offset of the selected objects to each other. Means the center of the current selection goes to cursor position. Not every individual object.

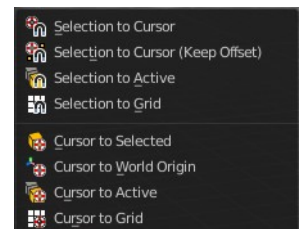

Last operator Snap Selection to Cursor

Offset

Keep the offset of the selected objects to each other.

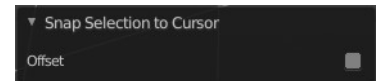

Selection to Active

Snaps the currently selected object(s) to the active object.

Selection to Grid

Snaps the currently selected object(s) to the nearest grid point.

Cursor to Selected

Moves the cursor to the center of the selected object(s).

Cursor to World Origin

Moves the cursor to the world origin.

Cursor to Active

Moves the cursor to the center of the active object.

Cursor to Grid

Moves the cursor to the nearest grid point.

From Duplicate ... to Paste

Duplicate Objects

Duplicates selected objects. The copy is completely independent. All containing data gets duplicated too. And you can edit the object instances completely independent. then.

You are automatically in grab mode, and so you can easily move the object out of position. Which is sometimes wanted, since you can position the duplicate then. But sometimes this is unwanted. A right click after releasing the mouse lets the object snap back into its creation position.

When you drag the duplicate around you will see the position values in the header.

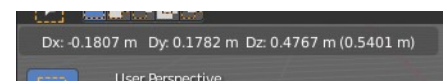
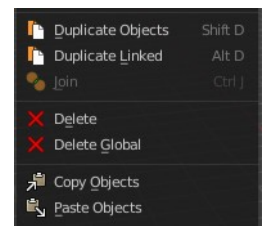

Last Operator Duplicate

Duplicate Objects

Linked

With this option ticked the duplication happens with linked data.

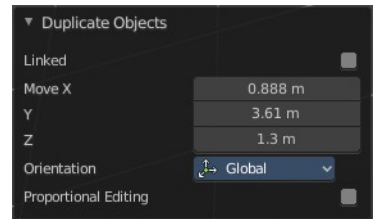

Move X , Y , Z

The Position of the duplicated object.

Orientation

Orientation is a drop-down box choose the type of orientation for the duplicate action.

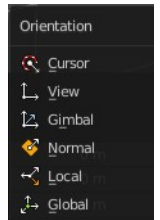

Proportional editing

Enables proportional editing. Activating proportional editing reveals further settings.

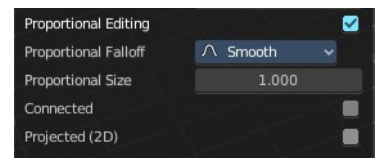

Proportional Falloff

Adjust the falloff methods.

Proportional Size

See and adjust the falloff radius.

Connected

The proportional falloff gets calculated for connected parts only.

Projected(2D)

The proportional falloff gets calculated in the screen space. Depth doesn't play a role. When it's in the radius, then it gets calculated.

Duplicate Linked

Duplicates selected objects. The instance has its own transforms. But the duplicate shares some data with the first instance. This means when you for example edit the mesh of one of the instances, then the other instance gets modified too. As you can see this in the screenshot. Here you can also see that the mesh name is the same. The object name is different though.

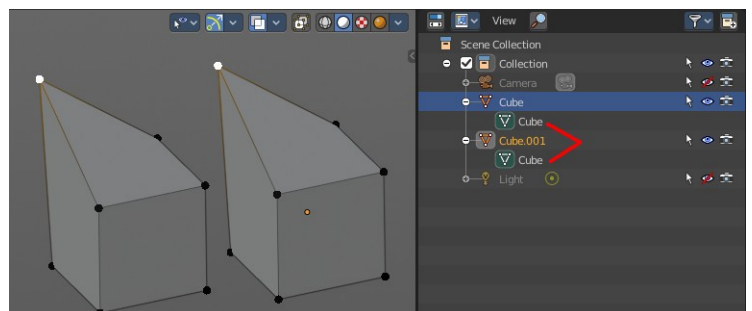

If you want to make changes to an object in the new linked duplicate independently of the original object, then you will have to manually make the object a “single-user”. This can be done for example in the Outliner, in the right click menu of the object. (Currently broken). Or in the Object menu. Choose what attached data you want to make single user.

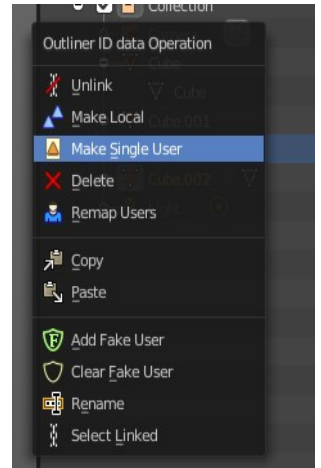
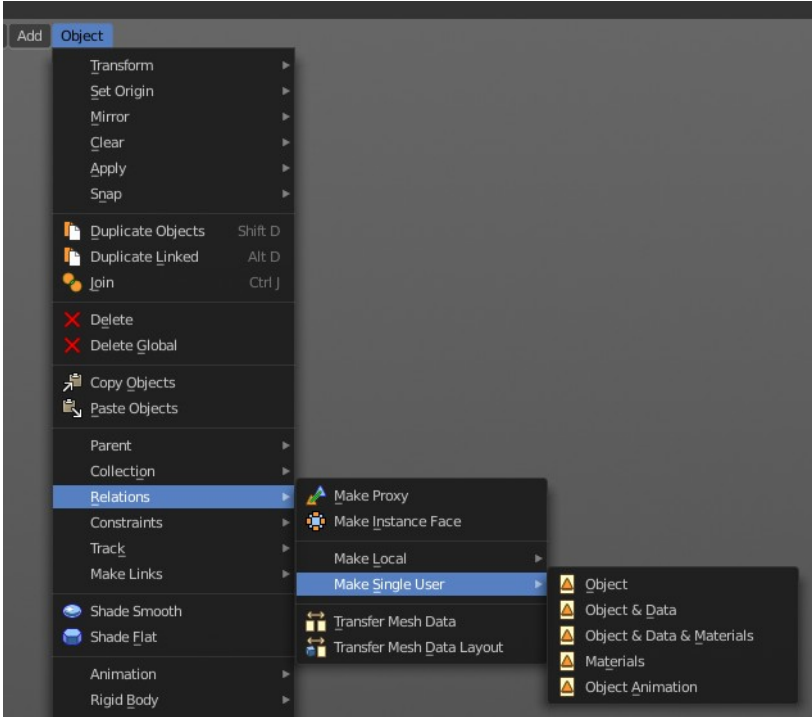

When you duplicate an object, then you are automatically in grab mode. And so you can easily move the object out of position. which is sometimes wanted, since you can position the duplicate then. But sometimes this is unwanted. A right click after releasing the mouse lets the object snap back into its creation position.

Duplicate linked instances the object data.

Explanation: Each Bforartists object type (mesh, lamp, curve, camera *etc.*) is composed from two parts: an *Object* and *Object Data* (sometimes abbreviated to *ObData*):

Object - Holds information about the position, rotation and size of a particular element.

Object Data - Holds everything else. For example. Meshes stores geometry, material lists, vertex groups, etc. . Cameras stores focal length, depth of field, sensor size, etc. .

Each object has a link to its associated object-data, and a single object-data, like a material, may be shared by many objects.

Last Operator Duplicate Linked

Duplicate Objects

Linked

With this option ticked the duplication happens with linked data.

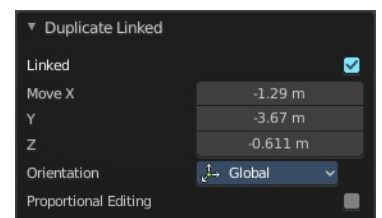

Move X, Y, Z

The Position of the duplicated object.

Orientation

Orientation is a drop-down box choose the type of orientation for the duplicate action.

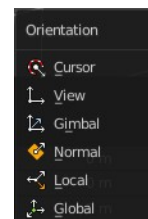

Proportional editing

Enables proportional editing. Activating proportional editing reveals further settings.

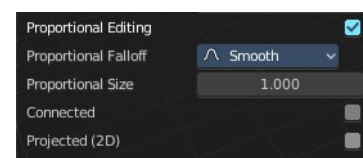

Proportional Falloff

Adjust the falloff methods.

Proportional Size

See and adjust the falloff radius.

Connected

The proportional falloff gets calculated for connected parts only.

Projected(2D)

The proportional falloff gets calculated in the screen space. Depth doesn't play a role. When it's in the radius, then it gets calculated.

Join

Joins two independent objects together and makes them one object.

This works with mesh objects and with curve objects. What does not work is to try to join mesh objects with curve objects. They are of different type.

Delete

Delete deletes the selected object(s).

Delete Global

It can be that you have more than one scene open. Delete deletes the selected object(s) in all scenes.

Copy

Copies the selected object(s).

Paste

Pastes copied object(s).

Last Operator Paste Selection from Buffer

Select

Select pasted object(s).

Active Collection

Put the pasted objects into the active collection.

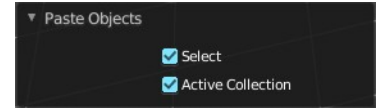

Asset

Asset related menu.

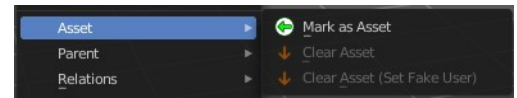

Mark as asset

Marks the selected object as an asset. It will be inserted in the asset library.

Clear Asset

Removes the selected object from the asset library.

Clear Asset(Set Fake User)

Removes the selected object from the asset library. But adds a fake user to it, so that it remains in the scene.

Parent

The parent menu provides you with all parenting methods at object level.

To use parenting you first have to select the source object, hold down shift, then select the target object so that both are selected. This also works in the outliner (here you can also simply hold

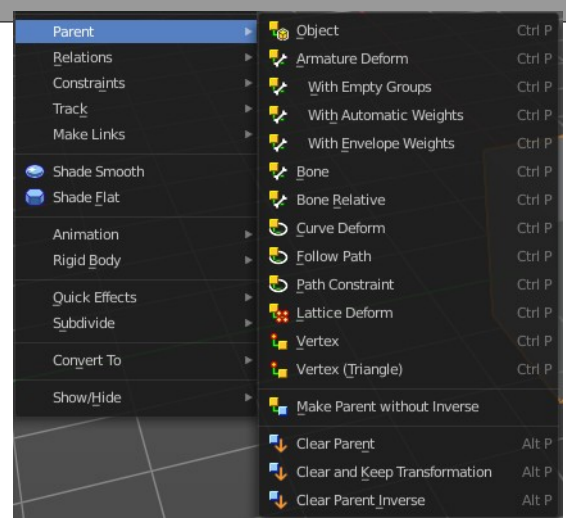

down shift and drag the source object at the target object to make it a child). The source object becomes the child object then.

The methods are object type dependent. The armature methods requires to have a mesh and an armature. The path methods a curve. The available methods for the current selection can also be found out by pressing the hotkey ctrl P. This calls the parenting menu with just the available methods.

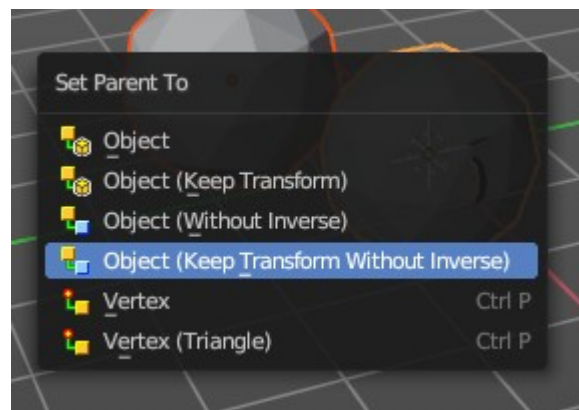

Object

Sets the parent to selected object.

Object (Keep Transform)

Sets the parent to selected object, but applies all transform before the operation.

Object (Without Inverse)

Set the object's parenting without setting the inverse parent correction. This preserves all transforms before the operation.

Object (Keep Transform Without Inverse)

Set the object's parenting without setting the inverse parent connections and applies all transform before the operation.

Armature parenting creates an armature modifier at the mesh.

Armature Deform

Sets the parent to selected Armature.

With empty Groups

Sets the parent to selected Armature, using empty groups.

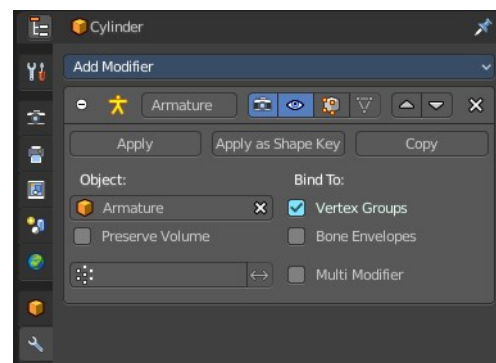

With Envelope Weights

Sets the parent to selected Armature, using envelope weights

With automatic Weights

Sets the parent to selected Armature, with automatic weights.

Bone

Sets the parent absolute to selected Bone.

Bone Relative

Sets the parent relative to selected Bone.

Curve Deform

Curve Deform allows you to deform a mesh by a curve shape. It adds a curve modifier at the mesh.

Usage:

Create a curve. Bend it in edit mode to your needs. Create a mesh. I have for demonstration purposes created a cylinder with several subdivisions.

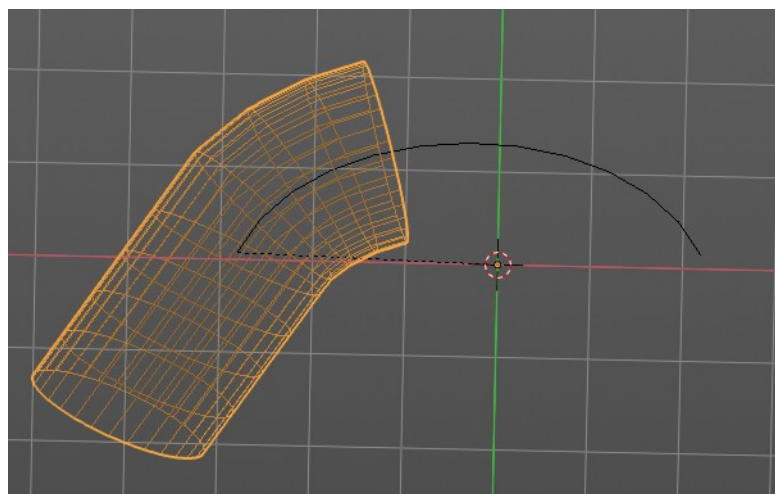
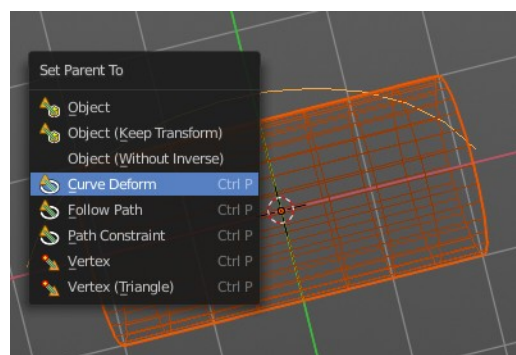
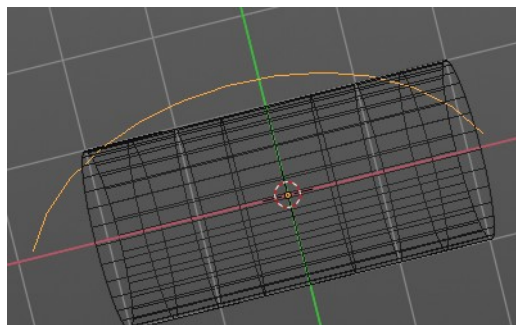
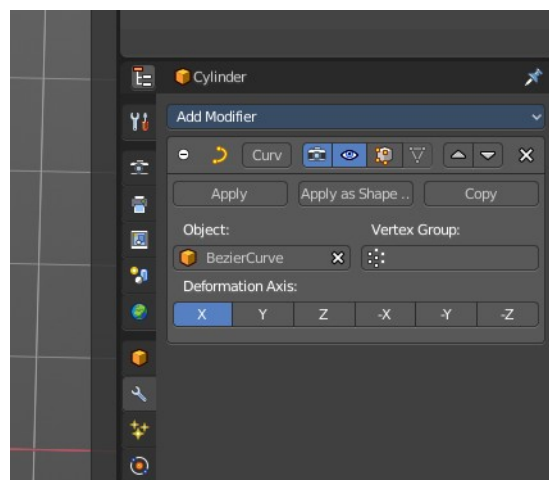

To demonstrate the only pitfall, by parenting the center of the object goes to the start point of the curve. So you better put the origin at the bottom of the cylinder before parenting.

Follow Path

Attaches an object to a curve. The curve then gets used to animate the object position. Every vertice of the curve is one key frame.

Create a curve, create an object, hold down shift and select the curve, make parent ...

Take care of the position and rotation of the object before parenting it to the curve. It influences how the object behaves.

There is a constraint with the same name and functionality. But parenting with follow path will not create such a constraint.

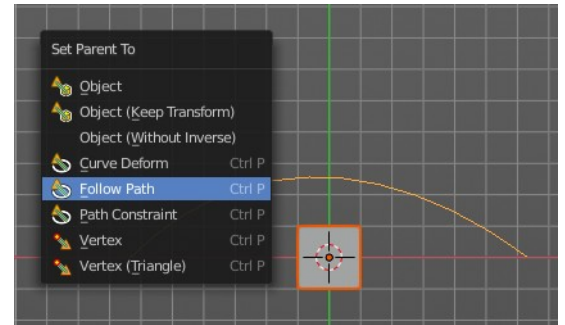

Path Constraint

Path constraint adds a AutoPath constraint at the mesh object, which is most probably a wrong labeled path constraint. It is not documented by the Blender developers.

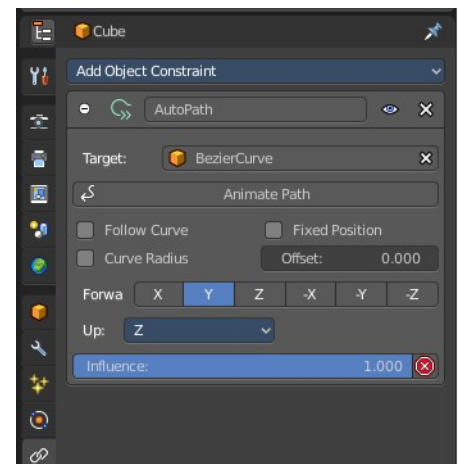
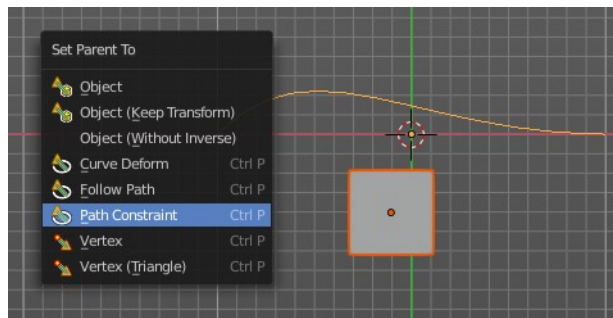

Create a curve, create an object, hold down shift and select the curve, make parent ...

Take care of the position and rotation of the object before parenting it to the curve. It influences how the object behaves.

Lattice Deform

Parents a lattice object to the object.

You need a lattice object and a mesh object. Lattice deformations just works with mesh objects.

Create a lattice, create an object, hold down shift and select the lattice, make parent ...

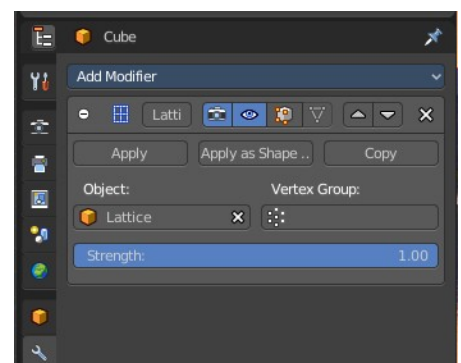

Parent the mesh object to the lattice object with method Lattice Deform. A Lattice Deform constraint will be added at the mesh object.

Take care of the position and size of the lattice object. It influences how the deformation works.

Enter Edit Mode with the lattice object. Deform it. The mesh object will follow the deformation.

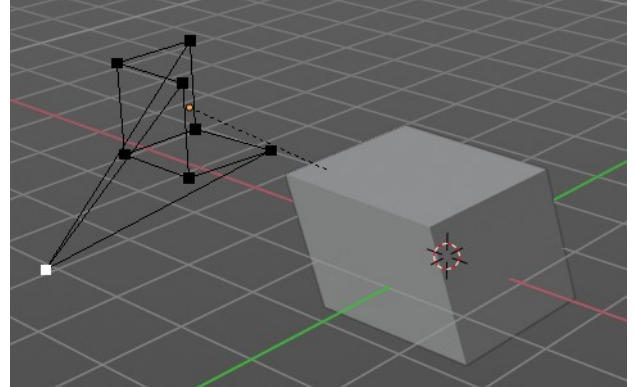
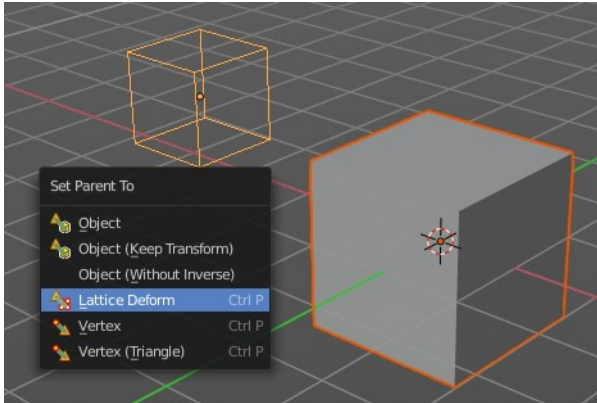

Vertex

Vertex parents the current object to a vertex of the target object. The vertex will be chosen automatically, it's the closest vertice of the parent object. When you want to assign the object to a specific vertex, then you have to do

The vertex parenting in Edit mode. You need to have an object type that has vertices. Mesh or curve.

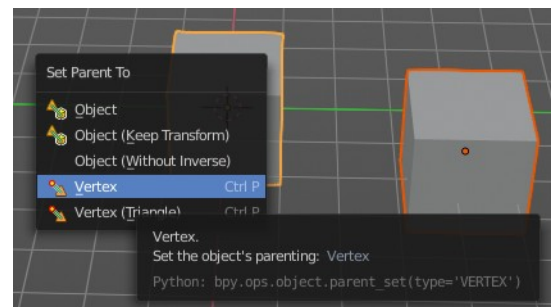

Create a mesh or curve object, create an object, hold down shift and select the mesh object, make parent ...

Vertex (Triangle)

Vertex (Triangle) parents the current object to a face of the target object. The face will be chosen automatically.

It's the closest face of the parent object. When you want to assign the object to a specific face, then you have to

Do the vertex parenting in Edit mode. You need to have an object type that has vertices. Mesh or curve.

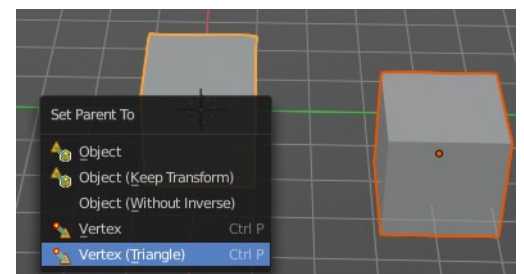

Create a mesh or curve object, create an object, hold down shift and select the mesh object, make parent ...

Last Operator Make Parent

Type

Choose the make parent method again. This last operator counts for most of the parent actions.

Keep Transform

Apply transform before parenting.

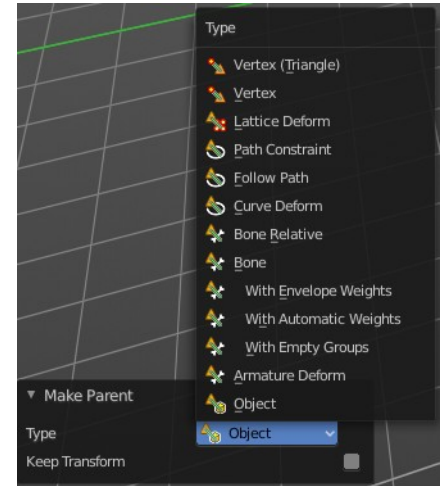

Object (Without Inverse)

With normal parenting the child object keeps its world transformation.

Without inverse parenting the child object uses the coordinate system of the parent object. As one of the effects you will see that the child objects will jump to the origin of the parent object when parenting.

Object (Keep Transform Without Inverse)

Set the object's parenting without setting the inverse parent connections and applies all transform before the operation. Without inverse parenting the child object uses the coordinate system of the parent object. By keeping the transform, the origin of the parent and child object stay in position.

Clear Parent

Clear Parent clears the parent relation completely, including involved modifiers.

Clear and Keep Transformation

Clear Parent clears the parent relation completely, including involved modifiers.

But keeps the current visual transformation.

Clear Parent Inverse

Clear Parent Inverse resets the transform corrections applied to the parenting relationship. It does not remove the parenting itself.

Last Operator Clear Parent

Change the type of clearing.

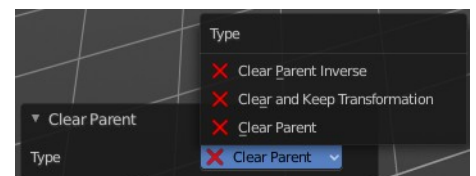
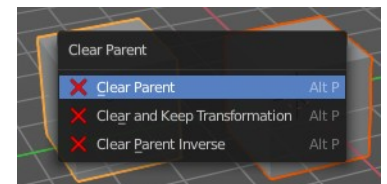

Relations

This sub menu contains relations related functionality.



Make Library Override

Add a local library override to this collection.

This tool works different from Add Override in the outliner. It iterates through the hierarchy of objects and collections based on the selection. And tries to override everything linked.

To work properly, it is important that all the collections needed by the character are children of the root object Both, linked and instantiated. Otherwise the automated overriding may fail.

Library Overrides is the new system designed to replace and supersede Proxies. Most types of linked datablocks can be overridden, and the properties of those overrides can then be edited. When the library data change, unmodified properties of the override one will be updated accordingly.

You need to link a collection from another file for example to set the Make Library Override tool active.

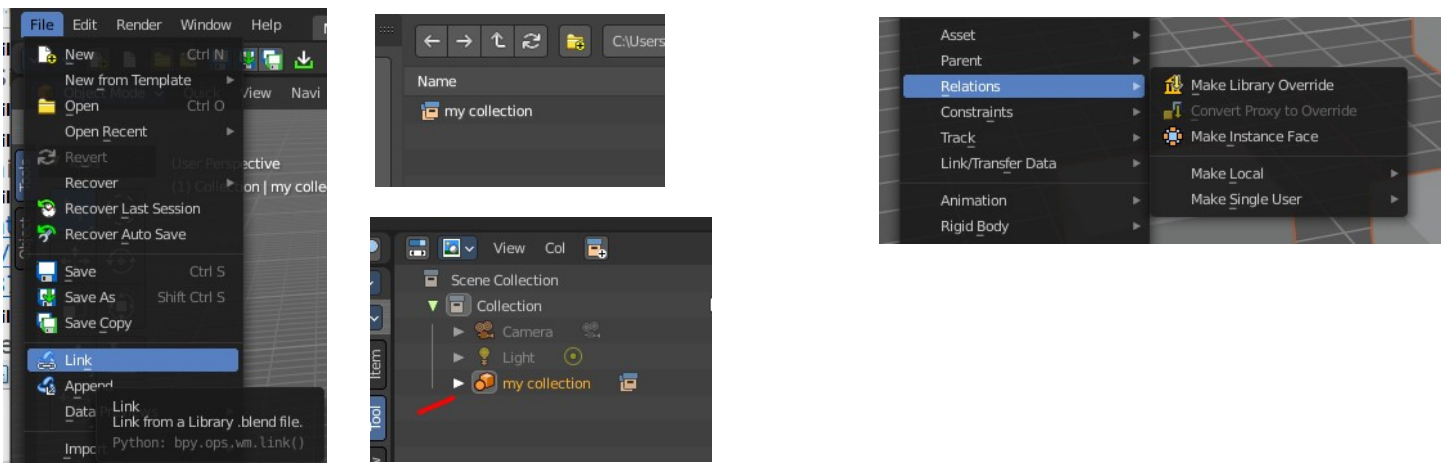

Make Instance Face

Make Instance Face, formerly Make Dupli Face, is a relict from the past, when there was no instancing or parenting feature available in Blender. When you turn an object into a Dupli Face object, then this object becomes an instancing container for this object. All objects in this container just exists once in ram when you duplicate it. No matter how often you duplicate it. This allows to plant whole forests without to run into a

memory problem. Since the tree object just loads once into ram. And gets just drawn at different screen positions then.

Usage:

Create an object. Make Instance Face. The name will be extended by a `_dupli` term.

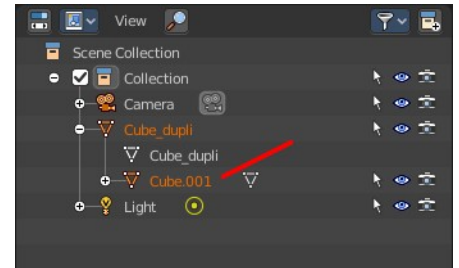

Now in the outliner go into the hierarchy of the dupli object. And duplicate the Cube.001 object inside of it. This is the parent object that you can duplicate. You will see that the duplicated copies will now be connected by a dotted line with the parent object.

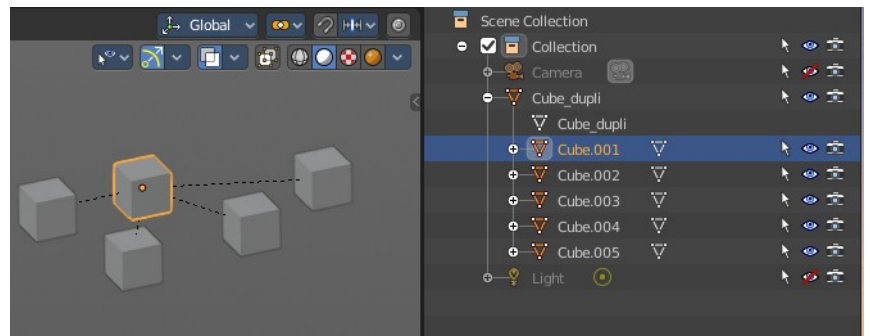

Make Local

You need to have a linked object for that. Make library linked data blocks local to this file. The link to the library object will be lost. And the object acts like you would have created it in the current scene.

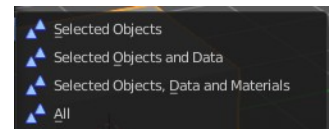

There are four different methods available. With which you can also make the dependencies of the library object local. Materials for example.

Make Single User

Make linked data local to each object. Additionally, it can also make single-user copies of its dependencies, like meshes, curves, materials, animations...

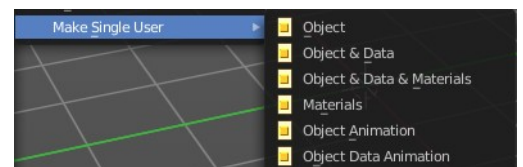

Constraints

The constraints menu contains some functionality that could also be done in the constraints tab in the Properties editor. Those buttons provides a quicker access though.

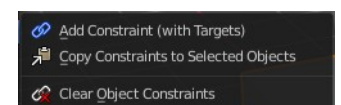

Constraints provides you with various limitation methods connected to a target object. For example, you can limit the X position of an object to the X position of the target object. And when you move the target object, then the object will change its X position too.

Add Constraints (With Targets)

Add Constraints (With Targets) calls a menu choose the constraints type. It's the same content than in the Constraints tab in the Properties editor.

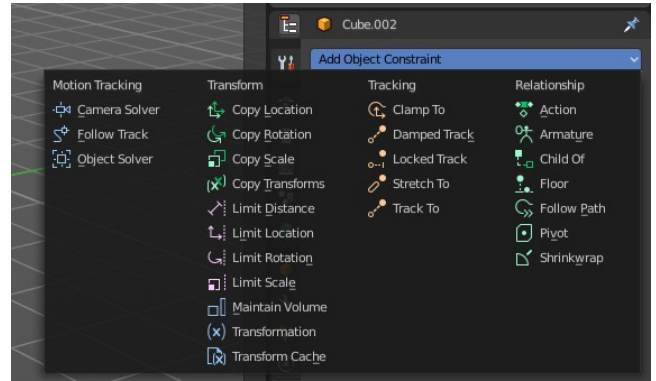

We will not explain every single constraint type here. Please have a look at the constraint types in the manual part for the Properties editor.

Usage:

Select the target object. Hold down Shift key. Now select the object where you want to add the constraints to. Both should be selected. Then choose the constraints type in the menu that you want to add.

As a result a constraints panel gets created in the Constraints tab in the Properties editor. Tweak the settings further if required. In our example we wanted to limit the X axis. So we added a Copy Location constraint, and unticked Y and Z axis. And when we move the cube around then the sphere will follow in X axis. But not in Y and Z.

In the 3D view a dotted line indicates the relationship.

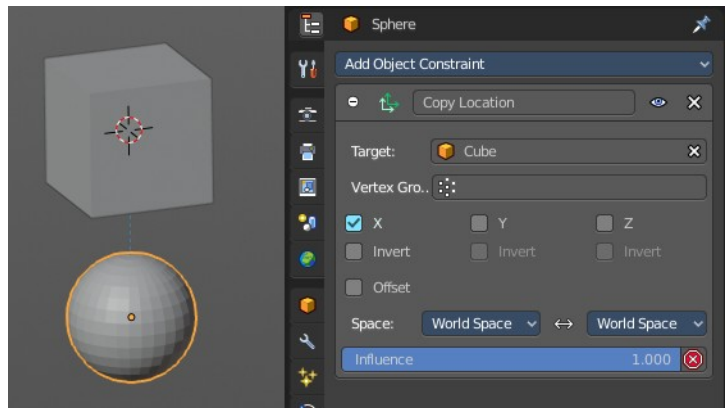

Last Operator Add Constraints (with Target)

Type

Type is a drop-down box choose the constraints type again.

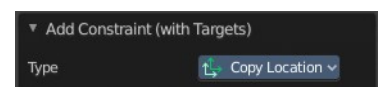

Copy Constraints to Selected Objects

Copy Constraints to Selected Objects copies a constraint from one object to another.

Usage:

Select the object where you want to copy the constraint to. Hold down Shift and select the object with the constraint. Both should be selected. Then click at Copy Constraints to Selected Objects. This copies the constraint to the object.

Clear Object Constraints

Removes all constraints from the object.

Track

Track constraints are constraints. And adding them could also be done in the constraints tab in the Properties editor. Those buttons provides a quicker access though.

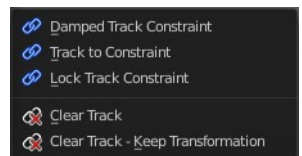

Damped Track Constraint

The Damped Track constraint constrains one local axis of the owner to always point towards Target. It is a Look At constraint.

Usage: select the source object, hold down shift, select the target object, add Damped Track Constraint.

The wrong constraint name called AutoTrack is a Blender bug.

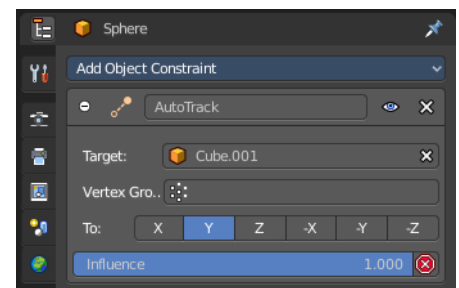

Track to Constraint

This constraint is similar to Damped Track constraints, but provides some more control.

Usage: select the source object, hold down shift, select the target object, add Damped Track Constraint. Constraint will be added at source object.

The wrong constraint name called AutoTrack is a Blender bug.

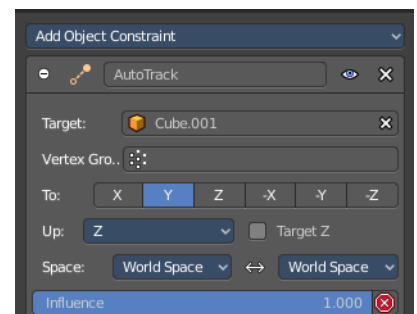

Lock Track Constraint

The Locked Track constraint is basically a Track To constraint. But with a locked axis. Means an axis that cannot rotate. So the constraint can just follow in one defined axis.

The wrong constraint name called AutoTrack is a Blender bug.

Usage: select the source object, hold down shift, select the target object, add Track Constraint. Constraint will be added at source object.

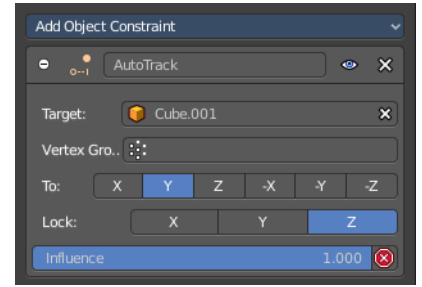

Clear Track

You need to have a Track constraint applied. It removes the track constraint.

Last Operator Clear track

Type

Type is a drop-down box choose between Clear Track and Clear Track Keep

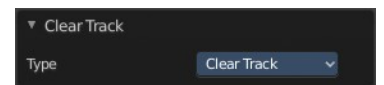

Clear Track - Keep Transformation

This menu item is just relevant when you have a Track constraint applied. Removes the track constraint. But keeps the current position.

Last Operator Clear track

Type

Type is a drop-down box choose between Clear Track and Clear Track Keep

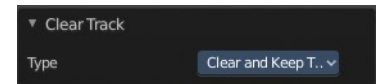

Link / Transfer Data

Links objects between scenes or data of the active object to all selected objects. In some case (i.e. Object Data, Modifier) the target objects must be of the same type than the active one or capable of receiving the data. If targets already have some data linked to them, it will be unlinked first.

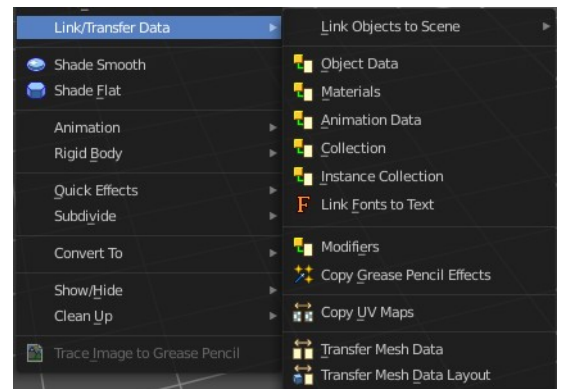

Link Object to Scene

In Bforartists you can have more than one scene in the blend file. See Scenes tab. The make links menu allows you to link or copy objects between those scenes.

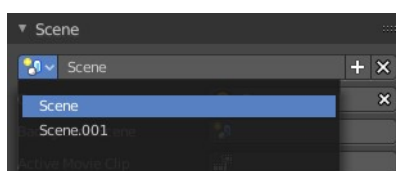
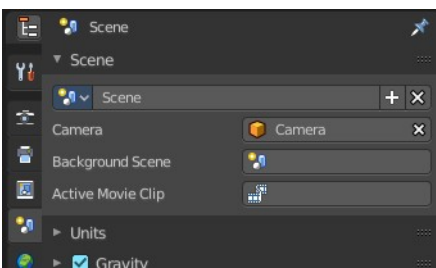

Object to Scene makes the selected object available in the chosen scene. This makes the object exist in two different scenes at once, including position and animation data.

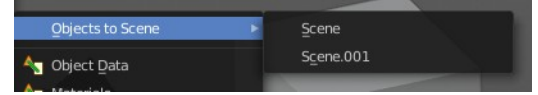

When you want the object not to be shared across two scenes anymore, then you have to make it single user again, which can be done in the relations menu.

Object Data, Materials .. etc

Link this specific data blocks between selected objects.

Select the source object, hold down shift, select the target objects. Perform the action.

Last Operator Link Data

Type

Choose the data type again that you want to transfer.

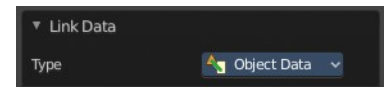

Copy UV Maps

Copies the UV map from one object to another. If the selected object doesn't have any UV maps, then it is created. The Objects must be of type mesh and must have a matching topology.

Select the source object, hold down shift, select the target object. Perform Transfer UV Map.

Transfer Mesh Data

Transfers mesh data from active to selected object.

Select the object that you want to copy the data to, hold down shift, select the source object with the modifications at it. Choose Transfer Mesh Data. A popup with the available methods will appear. Choose what you want to do.

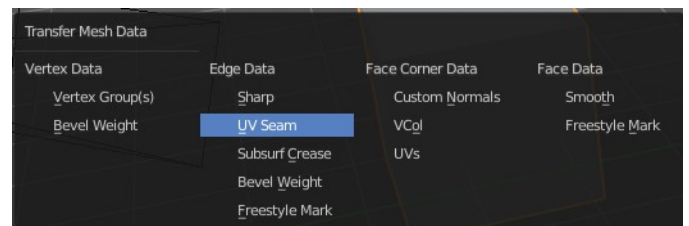

The caveat here is that the operator works in object mode. When you switch modes then the operator quits. And so you can't check if the UV seam transfer for example arrives as it should. This means that you sometimes end in trial and error with the last operator setting until you have your desired result.

Last Operator Transfer Mesh Data

Freeze Operator

Prevent changes to settings to re-run the operator. This is useful if you are editing several settings at once with heavy geometry.

Data Type

The popup from above. Choose again what you want to do.

Create Data

Add data layers on destination meshes if needed.

Edge Mapping

Edge mapping determines how edge data gets transferred.

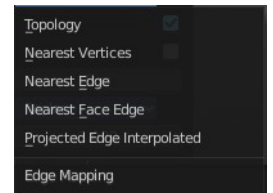
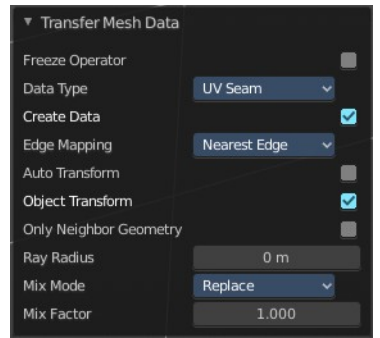

Topology

This method expects to have the same number of items at both objects. Identical objects that got deformed differently for example.

Nearest Vertice

Uses the nearest vertice of the source object for calculation.

Nearest Edge

Uses the nearest edge of the source object for calculation.

Nearest Face Edge

Uses the nearest edge of sources nearest face of the source object for calculation.

Projected Edge Interpolation

A sampling process that casts several rays from along the destination's edge for calculation.

Auto Transform

Automatically computes the transformation to get the best possible match between source and destination meshes.

Only Neighbor Geometry

Source elements must be closer than given distance from destination one. Turning this on reveals further settings.

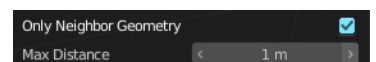

Max Distance

Maximum allowed distance between source and destination element (for non-topology mappings).

Ray Radius

The width of rays.

Mix Mode

How to affect destination elements with source values.



Below Threshold

Only replaces destination value if it is below given threshold Mix Factor. How that threshold is interpreted depends on data type, note that for Boolean values this option fakes a logical OR.

Above Threshold

Only replaces destination value if it is above given threshold Mix Factor. How that threshold is interpreted depends on data type, note that for Boolean values this option fakes a logical AND.

Replace

Replaces everything in destination (note that Mix Factor is still used).

Mix Factor

How much of the transferred data gets mixed into existing one (not supported by all data types).

Transfer Mesh Data Layout

Transfers the layout of data layer(s) from active to selected meshes.

Select the object that you want to copy the data to, hold down shift, select the source object with the modifications at it. Choose Transfer Mesh Data Layout. A popup with the available methods will appear. Choose what you want to do.



The menu has basically the same menu items like

Transfer Mesh Data. The difference is in what you can do in the last operator. It transfers the whole data layer.

Last Operator Transfer Mesh Data Layout

Data Type

Choose again what you want to do.

Exact Match

Also Delete some data layers from destination if necessary, so that it matches the source exactly.

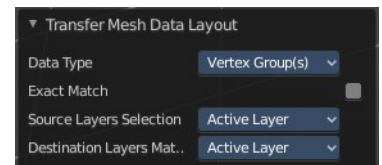

Source Layers Selection

Which layers to transfer, in case of multi-layer types.

Mygroup

Mygroup is in this case a vertex group i have created for demonstration purposes.

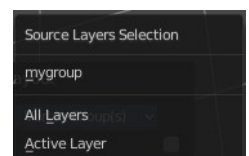

Active Layer

Only transfer the active data layer.

All Layers

Transfer all data layers.

Destination Layers Matching

How to match source and destination layers.



By Name

Match target data layers to affect by name.

By Order

Match target data layers to affect by order (indices).

Active Layer

Only transfer the active data layer.

Move to Collection

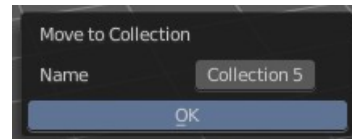
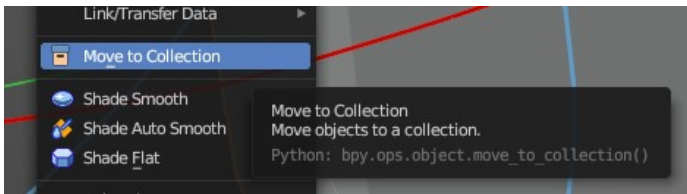

Moves the selected object to a collection. The object is removed from the collection it was in.

By clicking at this menu item a popup will appear choose the new collection. Allows also to create a new collection. Once done, the object will be moved to this new created collection.

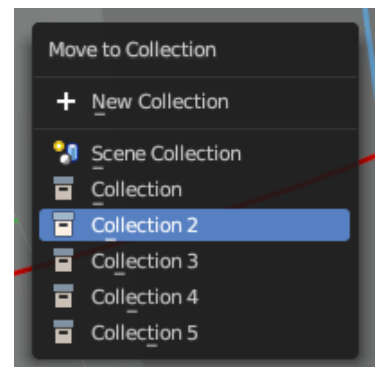

Shade Smooth, Shade Auto Smooth and Shade Flat

Shade Smooth

Sets the shading for the object to smooth. Smooth means that the sharp edges are no longer seen.

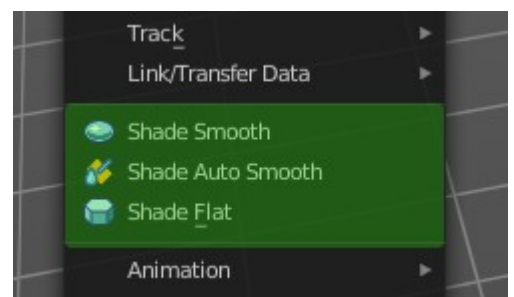
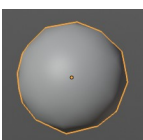

Shade Auto Smooth

Sets the shading for the object to smooth with Autosmooth activated. Autosmooth means that sharp edges above an angle threshold will have sharp faceted faces, meanwhile angles under the threshold will be smooth.

Shade Flat

Sets the shading for the object to flat. Flat means that every face of the object shows faceted, with a sharp edge.

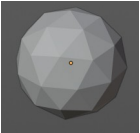

Animation

Insert Keyframe

Inserts a key frame.

When your object does have a active keying set, then a click at the button inserts the key frame directly. When a keying set is missing then you will see a Insert Key frame menu choose the keying method.

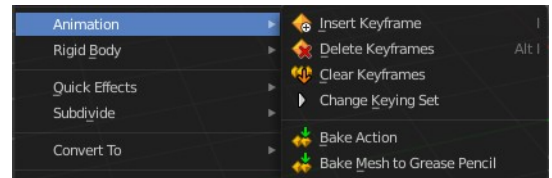

Insert Keyframe Menu

The keying set defines what kind of key frames gets recorded. When you start with an

animation, and your object does not have a keying set yet, then you will be prompted with a menu choose the proper keying set. The Insert Key frame menu.

Note that this just adds a keying set to the current key frame. And not to the whole object. That's why the keying set menu down right stays empty when you add a key frame this way. And the insert keyframe menu also misses the Whole Character keying set.

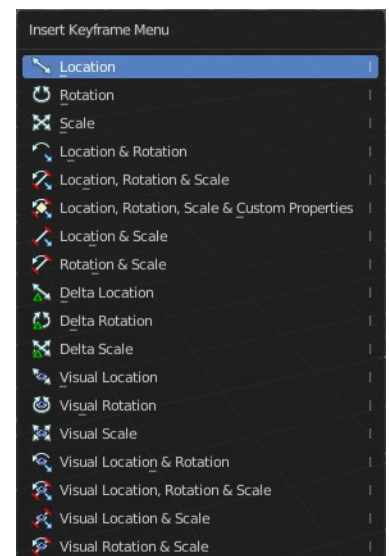



Delete Key frame

Removes the current active key frame for the selected object. You will get a confirmation dialogue.

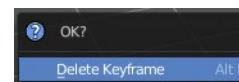

Clear Key frames

Clears all animation, and removes all key frames for the selected object.

Bake Action

Bake Action bakes the object animation to a new action. Bake action calls a panel adjust the settings for the new action.

The panel has the same settings than the last operator panel.

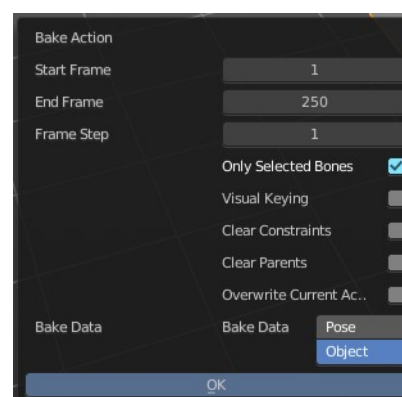

Last Operator Bake Action

Start Frame

Defines the start frame for baking.

End Frame

Defines the end frame for baking.

Frame Step

Defines the frame step for baking.

Only Selected Bones

Pose Baking only.

Visual Keying

Key frame from the final transform.

Clear Constraints

Remove all constraints from keyed objects / bones, and do visual keying.

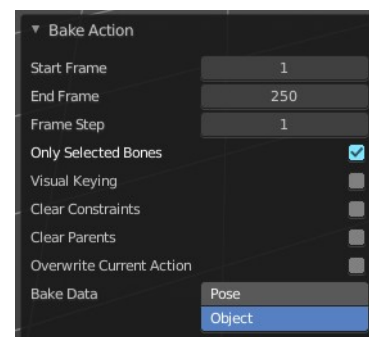

Clear Parents

Bake animation onto the object, then clear parents (objects only)

Overwrite current Action

Bake Action into current action instead of creating a new one.

Bake Data

Which data transformations to bake to. You have the choice between Pose and Object here.

Bake Mesh to Grease Pencil

Bakes mesh animation to grease pencil strokes.

Bake Mesh Animation to Grease Pencil

When you use the Bake Mesh to Grease Pencil tool then a menu pops up with further settings.

Target Object

Target grease pencil object. Leave empty to create a new stroke.

Start Frame

The start frame of the animation.

End Frame

The end frame of the animation.

Step

Step between generated frames.

Thickness

The thickness of the grease pencil stroke.

Threshold Angle

Threshold to determine the end of the strokes.

Stroke Offset

Stroke offset from fill.

Only Seam Edges

Convert only seam edges.

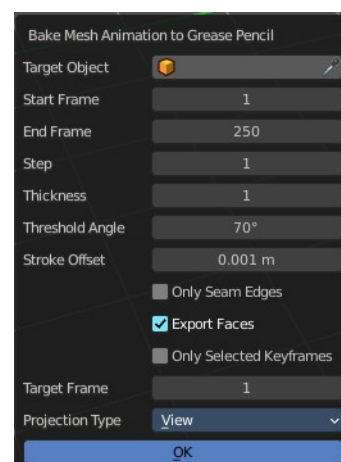

Export Faces

Export faces as filled strokes.

Only Selected Keyframes

Convert only selected keyframes.

Target Frame

The destination frame.

Projection Type

How to project the grease pencil stroke.

OK

Accept the settings.

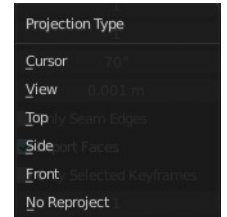

Last Operator Bake Mesh Animation to Grease Pencil

In the last operator you can again adjust the settings. It is the same settings than in the settings dialog. So we won't cover it again.

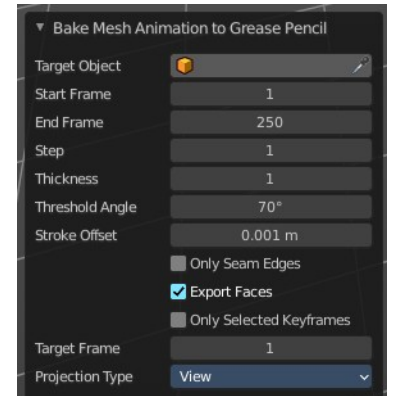

Bake Object Transform to Grease Pencil

Bakes grease pencil object transforms into single grease pencil keyframes. You need to have a keyframe animation recorded already. The result can then be found in the dopesheet editor in grease pencil mode.

When you perform this tool then an option panel will open up.

Bake Transform to Grease Pencil panel

Start Frame

The start frame to calculate.

End Frame

The end frame to calculate.

Step

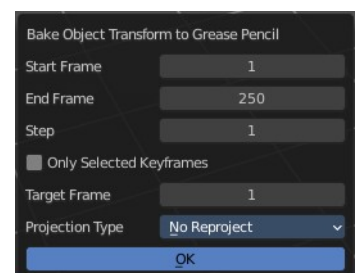

The steps between generated frames

Only selected Keyframes

Convert only selected keyframes.

Target Frame

The destination frame.

Projection Type

If the grease pencil object should be reprojected, and with what method.

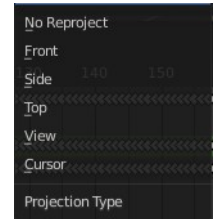

Last Operator Bake Transform to Grease Pencil panel

The last operator contains the same settings than the settings panel.

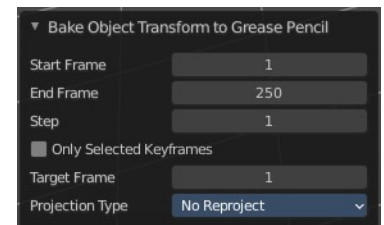

Rigid Body

Rigid Bodies belongs to physics. And can be added and modified in the physics tab in the Properties editor. This menu items here is just a quick way to add and modify the most basic things from within the 3D view.

The greyed out menu items becomes active when a rigid body is at the object.

Add Active

Add Active adds a rigid body to the selected object. The type of this rigid body is active. This is useful for any actively moving object. Characters, bullets, etc.

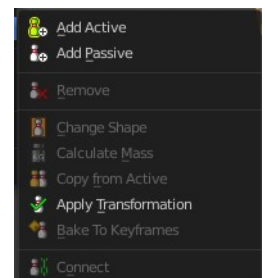

Add Passive

Add Active adds a rigid body to the selected object. The type of this rigid body is passive. This is useful for any static object, like ground for example.

Last Operator Add Rigid bodies

The rigid body type is a drop-down box choose if the type of the rigid body is active or passive.

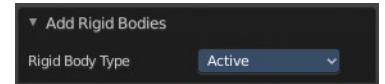

Remove

Remove simply removes the rigid body from the current object.

Change shape

Change Shape opens a pop-up menu change the shape of your rigid body.

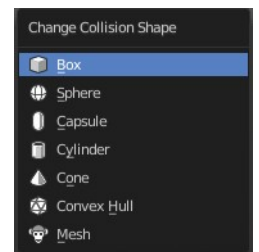

Last Operator Change Collision shape

Rigid Body Shape is a pop-up menu change the shape of your rigid body again.

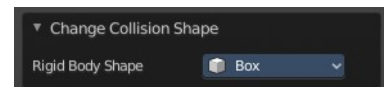

Calculate Mass

Calculate Mass does NOT calculate the mass. But gives you a long pop-up menu list choose between different predefined mass set-ups. The corresponding value will then be set in the physics settings in the Rigid Body settings.

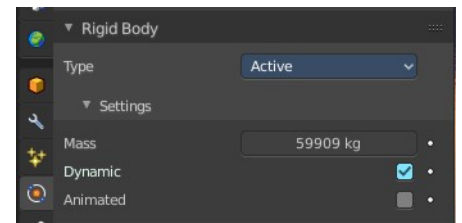
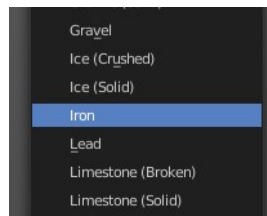

Last Operator Calculate Mass

Material Preset

Material Preset is a pop-up menu choose the type of preset again.

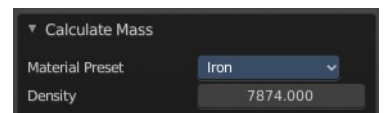

Density

Set a custom density for the material preset.

Quick Effects

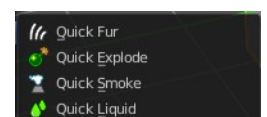

The quick effects menu contains some predefined basic Particle effects. They can be tweaked further in the Properties editor then.

You need to have a mesh object selected.

Quick Fur

Adds a particle system with Fur settings.

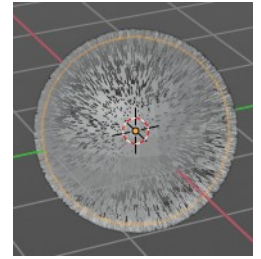

Quick Explode

Adds a particle system that lets the selected object explode into pieces.

Hit play to play the animation.

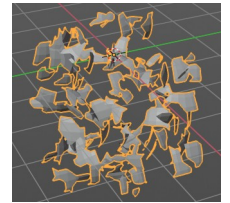

Quick Smoke

Adds a particle system with a simple smoke.

Hit play to play the animation.

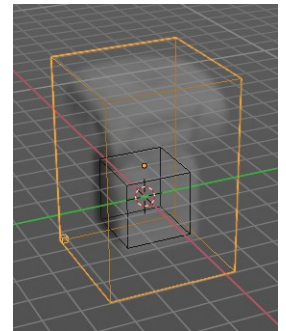

Quick Fluid

Adds a particle system with Fluid settings.

This feature does not completely work out of the box. You need to bake the animation first. This can be done in the Properties Editor, Particles Tab, Fluid Panel in the Bake sub panel.

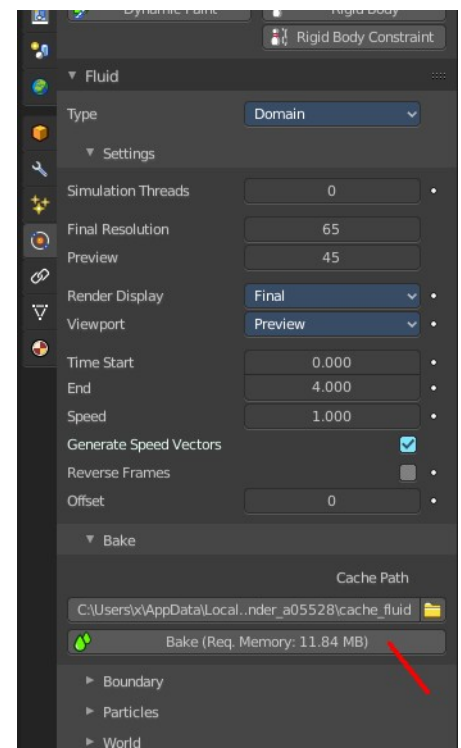

Subdivide

Subdivide is a menu where you can quickly set the subdivision level of the selection. What it does is to add a SDS modifier in the Properties Editor if required. And set the SDS level to the needed value. Ctrl 0 sets SDS to level 0. Ctrl 1 sets SDS level to 1, and so on.

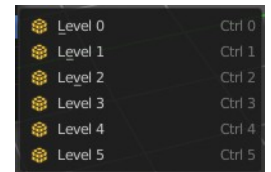

SDS happens at Object mode level. Even when you apply it in the Edit Mode! And it happens at the whole object.

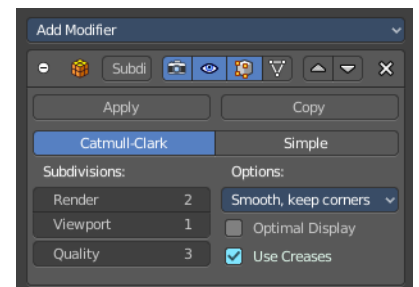

Last Operator Subdivision Set

Level

Adjust the SDS level.

Relative

Applies the Subsurf Level as an offset relative to the current level.



Convert to

Convert to is a menu to convert curves object types to mesh objects or grease pencil strokes, and mesh object types to curves.

The Gpencil tools just appears with a grease pencil object selected.

Curve

Converts a selected Mesh or Text Object to a Curve Object.

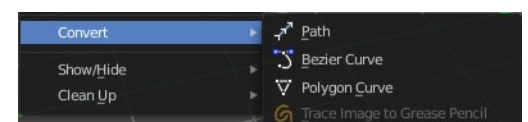
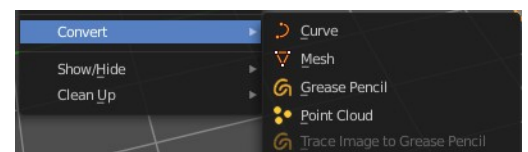

Mesh

Converts a selected object to a Mesh Object.

Grease Pencil

Converts a selected curve to a grease pencil stroke.

Point Cloud

Converts a selected object to a point cloud object.

Last Operator Convert to

Target

Target is a drop-down box that allows you to choose the convert method again.

Target Point Cloud, Mesh, Curve

Keep Original

With this option ticked the original object gets kept. And a new object gets created.

Merge UV's

Merge UV coordinates that share a vertex to account for imprecision in some modifiers.

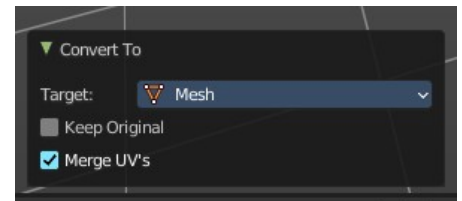

Show/Hide

Sub-menu with shows or hide selection, unselected or hidden operators.

Show Hidden

Makes all geometry in the scene visible again.

Hide Selected

Hides the selected geometry.

Last Operator Hide Selected

Unselected

Hides the not selected geometry.



Hide Unselected

Hides the not selected geometry. The selected geometry stays visible.

Clean Up

Sub-Menu with clean up operators to help do some house keeping when it comes to vertex groups, weights and material slots.

Clean Vertex Groups

Remove vertex assignments that are not required. This will delete any zero influence vertex groups.

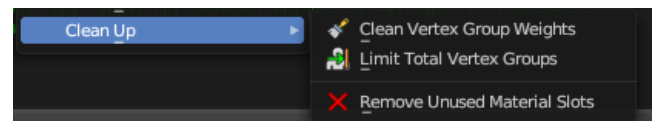

Limit Total Vertex Groups

Limit deform weights associated with a vertex to a specified number by removing lowest weights. This will set a total amount of vertex group influences per vertice.

Remove Unused Material Slots

Removed unused material slots on the selected object.



7.1.9 Editors - 3D Viewport - Header - Mesh - Edit mode - Mesh menu

Table of content

Detailed Table of content.....	2
Edit Mode - Mesh Menu.....	11
Legacy.....	11
Bisect.....	11
Transform.....	13
To Sphere.....	13
Shear.....	14
Bend.....	15
Push/Pull.....	15
Warp.....	16
Randomize Transform.....	16
Shrink/Fatten.....	17
Skin Resize.....	17
Move Texture Space.....	18
Scale Texture Space.....	19
Set Dimensions.....	21
Mirror.....	21
Interactive Mirror.....	21
X Global, Y Global etc.....	21
Mirror Vertex Group.....	22
Snap.....	23
Last Operator Snap.....	23
Single Operators.....	23
Duplicate.....	23
Extrude.....	24
Merge.....	31
Split.....	32
Separate.....	32
Convex Hull.....	33
Symmetrize.....	34
Snap to Symmetry.....	35
Smart Delete.....	35
Normals.....	36
Recalculate Outside.....	36
Recalculate Inside.....	36
Flip.....	36
Set from Faces.....	36
Rotate.....	36
Point Normals to Target.....	37
Merge.....	37
Split.....	37
Average.....	38
Copy Vectors.....	38
Paste Vectors.....	38
Smoothen Vectors.....	38

Reset Vectors.....	39
Select by Face Strength.....	39
Set Face Strength.....	39
Shading.....	39
Weights.....	39
Set Attribute.....	43
Sort Elements.....	43
Subdivide.....	44
Show / Hide.....	45
Show Hidden.....	45
Hide Selected.....	45
Hide Unselected.....	45
Cleanup.....	45
Delete Loose.....	46
Decimate Geometry.....	46
Degenerate Dissolve.....	47
Make Planar Faces.....	47
Split Non-Planar Faces.....	47
Split Concave Faces.....	47
Merge by Distance.....	48
Fill Holes.....	48
Delete.....	48
Dissolve.....	49
Dissolve Vertices.....	49
Dissolve Edges.....	50
Dissolve Faces.....	50
Dissolve Selection.....	50
Limited Dissolve.....	51
Edge Collapse.....	51
Mesh Select Mode.....	51

Detailed Table of content

Detailed Table of Content

Detailed Table of content.....	2
Edit Mode - Mesh Menu.....	11
Legacy.....	11
Bisect.....	11
Last Operator Bisect.....	12
Plane Point X , Y , Z.....	12
Plane Normal X , Y , Z.....	12
Fill.....	12
Clear Inner.....	12
Clear Outer.....	12
Axis threshold.....	12
Knife tool.....	12
Hotkey functionality in the footer text.....	12
Transform.....	13
To Sphere.....	13
Usage.....	13
Last Operator To Sphere Panel.....	13

Factor.....	13
Proportional editing.....	13
Proportional Falloff.....	14
Proportional Size.....	14
Connected.....	14
Projected(2D).....	14
Shear.....	14
Last Operator Shear.....	14
Offset.....	14
Shear Axis.....	14
Axis.....	14
Axis Ortho.....	14
Orientation.....	14
Proportional editing.....	14
Proportional Falloff.....	15
Proportional Size.....	15
Connected.....	15
Projected(2D).....	15
Bend.....	15
Push/Pull.....	15
Last Operator Push/Pull.....	15
Factor.....	15
Proportional editing.....	15
Proportional Falloff.....	15
Proportional Size.....	15
Connected.....	15
Projected(2D).....	16
Warp.....	16
Last operator Warp.....	16
Warp Angle.....	16
Offset Angle.....	16
Min.....	16
Max.....	16
Randomize Transform.....	16
Last Operator Randomize Transform.....	16
Amount.....	16
Uniform.....	16
Normal.....	16
Random Seed.....	16
Shrink/Fatten.....	17
Last Operator Shrink/Fatten.....	17
Offset.....	17
Offset Even.....	17
Proportional editing.....	17
Proportional Falloff.....	17
Proportional Size.....	17
Connected.....	17
Projected(2D).....	17
Skin Resize.....	17
Last Operator Skin Resize.....	18
Vector.....	18
Scale X, Y, Z.....	18
Orientation.....	18

Proportional editing.....	18
Proportional Falloff.....	18
Proportional Size.....	18
Connected.....	18
Projected(2D).....	18
Move Texture Space.....	18
Last Operator Translate.....	19
Move X, Y Z.....	19
Orientation.....	19
Proportional editing.....	19
Proportional Falloff.....	19
Proportional Size.....	19
Connected.....	19
Projected(2D).....	19
Scale Texture Space.....	19
Last Operator Resize Texture.....	20
Move X, Y Z.....	20
Orientation.....	20
Proportional editing.....	20
Proportional Falloff.....	20
Proportional Size.....	20
Connected.....	20
Projected(2D).....	20
Set Dimensions.....	21
Last Operator Set Dimensions.....	21
New Dimensions.....	21
Mirror.....	21
Interactive Mirror.....	21
X Global, Y Global etc.....	21
Last Operator Mirror.....	21
Orientation.....	21
Constraint Axis.....	22
Proportional editing.....	22
Proportional Falloff.....	22
Proportional Size.....	22
Connected.....	22
Projected(2D).....	22
Mirror Vertex Group.....	22
Last Operator Mirror Vertex Group.....	22
Mirror Weights.....	22
Flip Group Names.....	22
All Groups.....	22
Topology Mirror.....	23
Snap.....	23
Last Operator Snap.....	23
Offset.....	23
Single Operators.....	23
Duplicate.....	23
Last Operator Duplicate.....	23
Mode.....	23
Move X, Y, Z.....	23
Orientation.....	23
Constraint Axis.....	23

Proportional editing.....	24
Proportional Falloff.....	24
Proportional Size.....	24
Connected.....	24
Projected(2D).....	24
Extrude.....	24
Extrude Faces (Legacy).....	24
Last Operator Extrude Region and Move.....	24
Flip Normals.....	24
Dissolve Orthogonal Edges.....	25
Move X, Y Z.....	25
Orientation.....	25
Proportional editing.....	25
Proportional Falloff.....	25
Proportional Size.....	25
Connected.....	25
Projected(2D).....	25
Extrude Faces along Normals (Legacy).....	25
Last Operator Extrude Region and Shrink/Fatten.....	25
Flip Normals.....	25
Dissolve Orthogonal Edges.....	25
Offset.....	26
Offset Even.....	26
Proportional editing.....	26
Proportional Falloff.....	26
Proportional Size.....	26
Connected.....	26
Projected(2D).....	26
Extrude Individual Faces (Legacy).....	26
Last Operator Extrude Individual Faces and Move.....	26
Offset.....	26
Offset Even.....	26
Proportional editing.....	26
Proportional Falloff.....	26
Proportional Size.....	27
Connected.....	27
Projected(2D).....	27
Extrude Manifold (Legacy).....	27
Last Operator Extrude Manifold.....	27
Flip Normals.....	27
Dissolve Orthogonal Edges.....	27
Move X, Y Z.....	27
Orientation.....	27
Proportional editing.....	27
Proportional Falloff.....	27
Proportional Size.....	27
Connected.....	28
Projected(2D).....	28
Extrude Edges.....	28
Last Operator Extrude Only Edges and Move.....	28
Flip Normals.....	28
Move X Y Z.....	28
Orientation.....	28

Constraint Axis.....	28
Proportional editing.....	28
Proportional Falloff.....	28
Proportional Size.....	28
Connected.....	28
Projected(2D).....	28
Extrude Vertices.....	29
Last Operator Extrude Only Vertices and Move.....	29
Move X Y Z.....	29
Orientation.....	29
Constraint Axis.....	29
Proportional editing.....	29
Proportional Falloff.....	29
Proportional Size.....	29
Connected.....	29
Projected(2D).....	29
Dupli Extrude / Dupli Extrude Rotate.....	29
Dupli Extrude - with selected Faces.....	29
Dupli Extrude - with selected Vertices.....	30
Extrude Repeat.....	30
Last Operator Extrude Repeat.....	30
Steps.....	30
Spin.....	30
Last Operator Spin.....	31
Steps.....	31
Use Duplicates.....	31
Angle.....	31
Auto Merge.....	31
Flip Normals.....	31
Center X / Y / Z.....	31
Axis.....	31
Merge.....	31
At Center, At Cursor, Collapse, At First, At Last.....	31
Last Operator Merge.....	31
Type.....	31
UV's.....	31
By Distance.....	32
Last Operator Merge by Distance.....	32
Merge Distance.....	32
Split.....	32
Selection.....	32
Faces by Edges / Faces by Edges by Vertices.....	32
Last Operator Edge Split.....	32
Type.....	32
Separate.....	32
Selection.....	32
By Material.....	32
By Loose Parts.....	33
Knife Project.....	33
Last Operator Knife Project.....	33
Cut through.....	33
Convex Hull.....	33
Last Operator Convex Hull.....	34

Delete Unused.....	34
Use existing Faces.....	34
Make Holes.....	34
Join Triangles.....	34
Max Face Angle.....	34
Max Shape Angle.....	34
Compare UV's.....	34
Compare Vcols.....	34
Compare Seam.....	34
Compare Sharp.....	34
Compare Materials.....	34
Symmetrize.....	34
Last Operator Symmetrize.....	35
Direction.....	35
Threshold.....	35
Snap to Symmetry.....	35
Last Operator Snap to Symmetry.....	35
Direction.....	35
Threshold.....	35
Factor.....	35
Center.....	35
Smart Delete.....	35
Normals.....	36
Recalculate Outside.....	36
Last Operator Recalc Outside.....	36
Inside.....	36
Recalculate Inside.....	36
Flip.....	36
Set from Faces.....	36
Rotate.....	36
Last Operator Rotate Normals.....	36
Angle.....	36
Axis.....	37
Orientation.....	37
Constraint Axis.....	37
Point Normals to Target.....	37
Last Operator Point Normals to Target.....	37
Invert.....	37
Align.....	37
Target.....	37
Spherize.....	37
Merge.....	37
Split.....	37
Average.....	38
Custom Normal.....	38
Face Area.....	38
Corner Angle.....	38
Last Operator Average Normals.....	38
Weigh.....	38
Threshold.....	38
Copy Vectors.....	38
Paste Vectors.....	38
Last Operator Normals Vector Tools.....	38

Absolute Coordinates.....	38
Smoothen Vectors.....	38
Last Operator Smooth Normals Vectors.....	39
Factor.....	39
Reset Vectors.....	39
Select by Face Strength.....	39
Set Face Strength.....	39
Shading.....	39
Weights.....	39
Normalize All.....	40
Last Operator Normalize all.....	40
Subset.....	40
Lock Active.....	40
Normalize.....	40
Mirror.....	40
Last Operator Mirror Vertex Group.....	40
Mirror Weights.....	40
Flip Group Names.....	40
All Groups.....	41
Topology Mirror.....	41
Invert.....	41
Last Operator Invert Vertex Group.....	41
Subset.....	41
Add Weights.....	41
Remove Weights.....	41
Clean.....	41
Last Operator Clean Vertex Group.....	41
Subset.....	41
Limit.....	41
Keep Single.....	41
Quantize.....	41
Last Operator Quantize.....	41
Subset.....	41
Steps.....	41
Levels.....	42
Last Operator Vertex Group Levels.....	42
Subset.....	42
Offset.....	42
Gain.....	42
Smooth.....	42
Last Operator Smooth Vertex Weights.....	42
Subset.....	42
Factor.....	42
Iterations.....	42
Expand/Contract.....	42
Limit Total.....	42
Last Operator Limit Number of Weights per Vertex.....	42
Subset.....	42
Limit.....	42
Fix Deforms.....	42
Last Operator Fix Deforms.....	43
Distance.....	43
Strength.....	43

Change Sensitivity.....	43
Set Attribute.....	43
Sort Elements.....	43
View Z Axis.....	43
View Y Axis.....	43
Cursor Distance.....	43
Material.....	43
Selected.....	44
Randomize.....	44
Reverse.....	44
Last Operator Sort Mesh Elements.....	44
Type.....	44
Vertices, Edges or Faces.....	44
Reverse Checkbox.....	44
Seed Edit box (Randomize only).....	44
Subdivide.....	44
Last Operator Subdivision Set.....	45
Level.....	45
Relative.....	45
Show / Hide.....	45
Show Hidden.....	45
Hide Selected.....	45
Hide Unselected.....	45
Last Operator Reveal Hidden / Hide Selected.....	45
Select.....	45
Cleanup.....	45
Delete Loose.....	46
Last Operator Delete Loose.....	46
Vertices.....	46
Edges.....	46
Faces.....	46
Decimate Geometry.....	46
Last Operator Decimate Geometry.....	46
Ratio.....	46
Vertex Group.....	46
Weight.....	46
Invert.....	47
Symmetry.....	47
Degenerate Dissolve.....	47
Make Planar Faces.....	47
Last Operator Make Planar Faces.....	47
Factor.....	47
Iterations.....	47
Split Non-Planar Faces.....	47
Last Operator Split Non-Planar Faces.....	47
Max Angle.....	47
Split Concave Faces.....	47
Merge by Distance.....	48
Last Operator Merge by Distance.....	48
Merge Distance.....	48
Unselected.....	48
Fill Holes.....	48
Last Operator Fill Holes.....	48

Sides.....	48
Delete.....	48
Vertices.....	48
Edges.....	49
Faces.....	49
Only Edges and Faces.....	49
Only Faces.....	49
Edge Loops.....	49
Last Operator Delete Edge Loop.....	49
Face Split.....	49
Dissolve.....	49
Dissolve Vertices.....	49
Last Operator Dissolve Vertices.....	50
Face Split.....	50
Tear Boundary.....	50
Dissolve Edges.....	50
Last Operator Dissolve Edges.....	50
Dissolve Verts.....	50
Face Split.....	50
Dissolve Faces.....	50
Last Operator Dissolve Faces.....	50
Dissolve Verts.....	50
Dissolve Selection.....	50
Last Operator Dissolve Selection.....	50
Dissolve Verts.....	50
Face Split.....	51
Tear Boundary.....	51
Limited Dissolve.....	51
Last Operator Limited Dissolve.....	51
Max Angle.....	51
All Boundaries.....	51
Delimit.....	51
Edge Collapse.....	51
Mesh Select Mode.....	51

Edit Mode - Mesh Menu

The Mesh Menu in Edit Mode contains the tools to manipulate the mesh geometry in Edit mode. It just exists for Mesh Objects.

Lots of functionality that could also belong here can also be found in the Tool Shelf. The difference is that the tools in the tool shelf are easier to access. And so it contains the most used tools for the daily work. While the Mesh menu contains the not so often used tools. Or tools where you use the hotkey anyway. Delete for example.

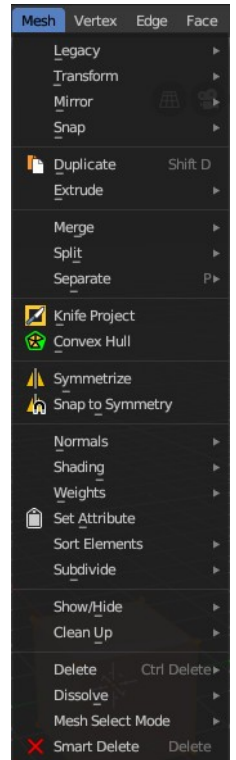

Legacy

The legacy sub menu contains tools that exists in the tool shelf already. It's the old way to do things. Different to the tools in the tool shelf, these tools are usually modal. And performs once. You have to call them again in case you want to repeat the tool.

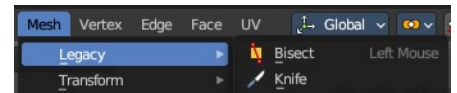

Bisect

Bisect cuts geometry along a plane. This description is a bit misleading though. You simply cut through the whole geometry by defining a line. And the cut goes through the geometry from the current view.

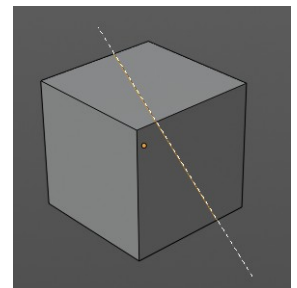

When you have set your cut and release the mouse then you reveal a widget with which you can move and rotate the cut. Clicking at the arrow and drag moves the cut. Clicking at the circle and drag rotates the cut.

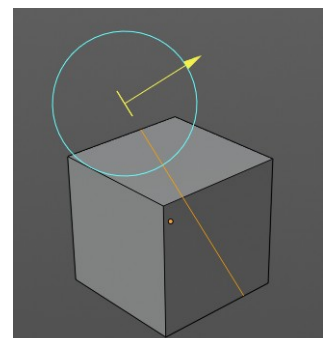

Last Operator Bisect

Plane Point X , Y , Z

Defines the start point of the Bisect cut.

Plane Normal X , Y , Z

The direction in which the bisect points.

Fill

Fills the cut.

Clear Inner

Removes the inner part of the face to cut.

Clear Outer

Removes the outer part of the face to cut.

Axis threshold

Axis threshold.

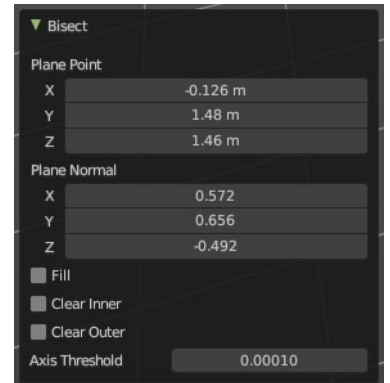

Knife tool

The Knife tool cuts the geometry, and adds edges. When it crosses existing geometry then it adds a vertice at the crossing point.

Usage: activate the tool, left click to define the starting point. This can also be a point in the middle of a face. But ideally you choose an existing vertice or an edge as the start and endpoints. The knife tool tries to snap to them when you get close with the mouse cursor.

When done press Enter or Spacebar to confirm. Right click abandons the operation.

When you create a vertice in the middle of a face, then the knife tool will try to connect this vertice by an existing vertice of this face when you confirm with spacebar.

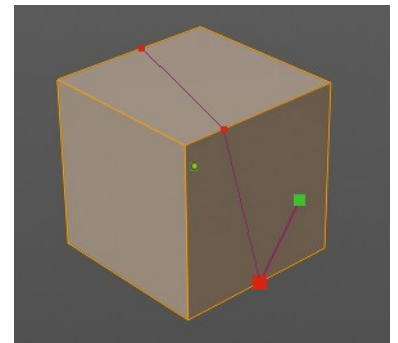

Hotkey functionality in the footer text

Have a look at the footer when you work with this tool. Here you will find further instructions and hotkeys.

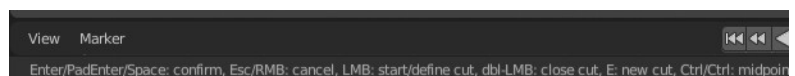

Enter, Pad Enter, Spacebar - confirm

Esc key, RMB - cancel the operation

LMB start the cut

Double LMB - close the cut

E - create new cut

Ctrl or Shift while dragging - Snap to the middle of an edge

Z - cut through the whole geometry, also the backfaces.

MMB - pan the view.

Alt MMB - rotate the view.

Transform

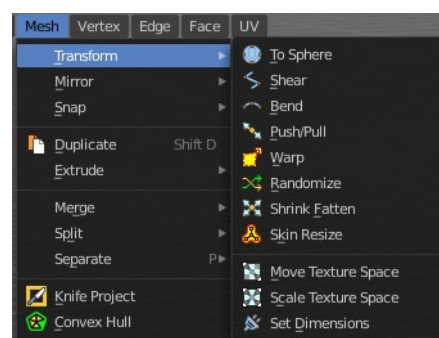

To Sphere

Shapes a selection of objects into the shape of a sphere. The calculation happens with the object origins.

In Object mode this tool requires to have more than one object selected.

Usage

Select the vertices, activate the tool, then drag the mouse in the 3D viewport. In the header you will read the current factor then. Which tells you how close you are towards the sphere shape.

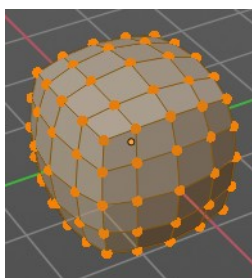
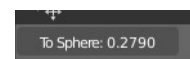

Last Operator To Sphere Panel

Factor

The factor to transform the selection into a shape form.

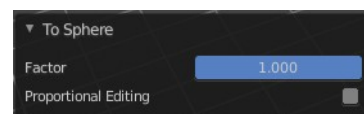

Proportional editing

Enables proportional editing. Activating proportional editing reveals further

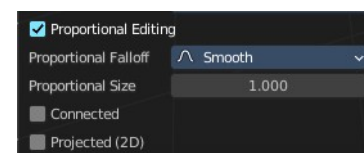

settings.

Proportional Falloff

Adjust the falloff methods.

Proportional Size

See and adjust the falloff radius.

Connected

The proportional falloff gets calculated for connected parts only.

Projected(2D)

The proportional falloff gets calculated in the screen space. Depth doesn't play a role. When it's in the radius, then it gets calculated.

Shear

Shear shears the selection.

Last Operator Shear

Offset

Adjust an offset.

Shear Axis

The shear tool works along a imaginary 2d plane. The shear axis controls if the items are sheared along the x or the y axes of this plane. This is the plane along which the transformation happens. You can shear along the x or the y axis of this plane.

To make things even more complicated, the orientation of this imaginary plane is defined by the Axis and Axis Ortho items below.

Axis

Defines one axis of the imaginary shear axis plane.

Axis Ortho

Defines the other axis of the imaginary shear axis plane.

Orientation

Choose the orientation for the shear action.

Proportional editing

Enables proportional editing. Activating proportional editing reveals further

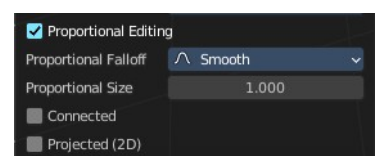
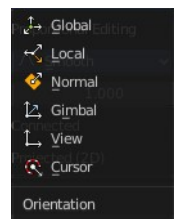
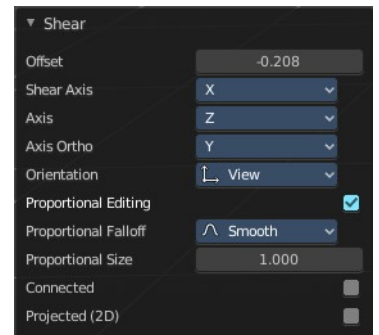

settings.

Proportional Falloff

Adjust the falloff methods.

Proportional Size

See and adjust the falloff radius.

Connected

The proportional falloff gets calculated for connected parts only.

Projected(2D)

The proportional falloff gets calculated in the screen space. Depth doesn't play a role. When it's in the radius, then it gets calculated.

Bend

Bends the selection.

Push/Pull

It pushes or pulls the object positions relative to the center of the selection.

In Object mode this tool requires to have more than one object selected.

Last Operator Push/Pull

Factor

Adjust the strength of influence of the tool.

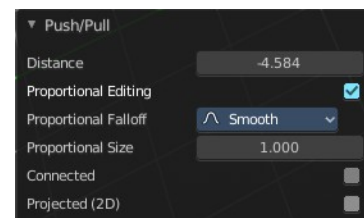

Proportional editing

Enables proportional editing. Activating proportional editing reveals further settings.

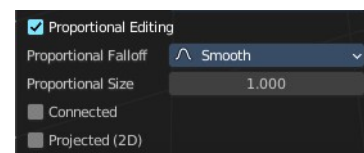

Proportional Falloff

Adjust the falloff methods.

Proportional Size

See and adjust the falloff radius.

Connected

The proportional falloff gets calculated for connected parts only.

Projected(2D)

The proportional falloff gets calculated in the screen space. Depth doesn't play a role. When it's in the radius, then it gets calculated.

Warp

Warp a mesh selection between two defined points.

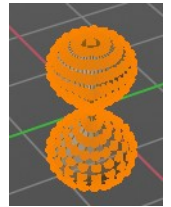

Last operator Warp

Warp Angle

The strength of the warp effect

Offset Angle

An offset angle to bend side wards.

Min

The start point.

Max

The end point.

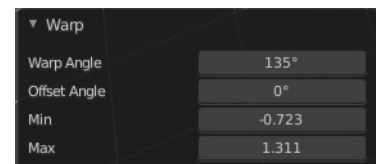

Randomize Transform

This tool allows randomizes the positions of the selected vertices.

Last Operator Randomize Transform

Amount

Adjust the amount.

Uniform

The uniform offset distance.

Normal

Align the offset direction to the normals.

Random Seed

The seed value for randomization.



Shrink/Fatten

Shrink/Fatten scales the selected geometry along its normals. Transform orientation and Pivot point gets ignored.

A positive value pushes the vertices outwards. A negative value pushes the vertices inwards.

Last Operator Shrink/Fatten

The Last Operator Shrink/Fatten panel gives you tools to adjust the Shrink/Fatten operation. Here you have numeric input for the strength and a few more options.

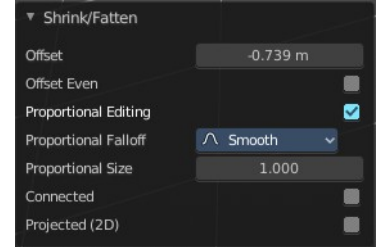

Offset

Offset is the strength of the offset for Shrink/Fatten.

Offset Even

Offset Even scales the selection to give more thickness in even areas.

Proportional editing

Enables proportional editing. Activating proportional editing reveals further settings.

Proportional Falloff

Adjust the falloff methods.

Proportional Size

See and adjust the falloff radius.

Connected

The proportional falloff gets calculated for connected parts only.

Projected(2D)

The proportional falloff gets calculated in the screen space. Depth doesn't play a role. When it's in the radius, then it gets calculated.

Skin Resize

This tool requires to have a skin modifier at the mesh. It scales the thickness of the skin.

While the operation you will see in the header the strength value for the skin.

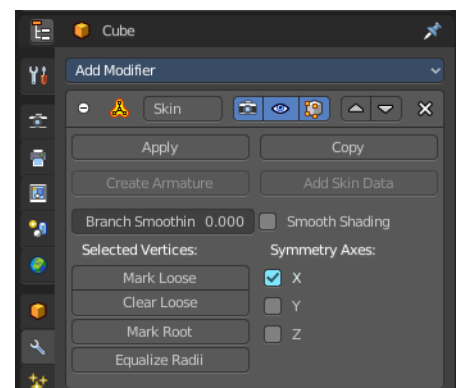

Scale X: -0.3484 Y: -0.3484 Z: -0.3484

Last Operator Skin Resize

Vector

Adjust the position values for the three values.

Scale X, Y, Z

Limit the position relative to the source object.

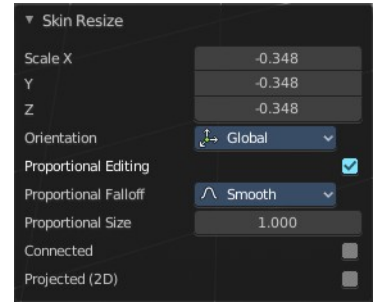

Orientation

Orientation is a drop-down box choose the type of orientation for the mirroring action.

Proportional editing

Enables proportional editing. Activating proportional editing reveals further settings.

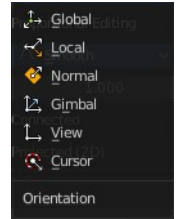

Proportional Falloff

Adjust the falloff methods.

Proportional Size

See and adjust the falloff radius.

Connected

The proportional falloff gets calculated for connected parts only.

Projected(2D)

The proportional falloff gets calculated in the screen space. Depth doesn't play a role. When it's in the radius, then it gets calculated.

Move Texture Space

This tool relies at the move tool. With the difference that it moves the texture space instead of the object. It has also a very special use case, and just works with a material with a Texture Coordinate / Generated node. And requires to have the shading at Material or Rendered to see a result in the viewport.

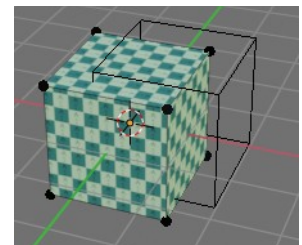

In the viewport you will see the UV cage in black color. In the header you will see the values for the current position of the UV cage.

Dx: -0.1501 m Dy: 0.05851 m Dz: 0.2117 m (0.2661 m)

Note that once done and applied, there is no way to reset the UV cage back to zero. When you repeat the operation, then the values will start at 0 again. Even when the UV cage is already offset.

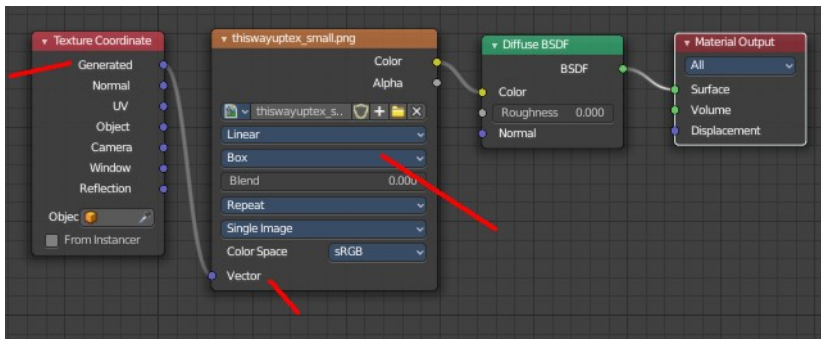

Last Operator Translate

Move X, Y Z

Limit the position relative to the source object.

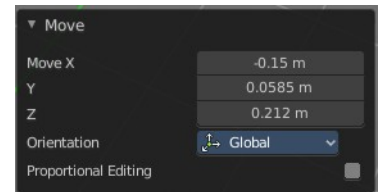

Orientation

Orientation is a drop-down box choose the type of orientation for the mirroring action.

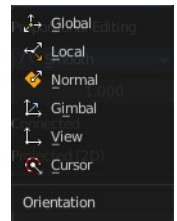

Proportional editing

Enables proportional editing. Activating proportional editing reveals further settings.

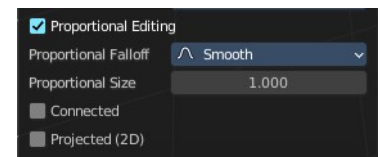

Proportional Falloff

Adjust the falloff methods.

Proportional Size

See and adjust the falloff radius.

Connected

The proportional falloff gets calculated for connected parts only.

Projected(2D)

The proportional falloff gets calculated in the screen space. Depth doesn't play a role. When it's in the radius, then it gets calculated.

Scale Texture Space

This tool relies at the scale tool. With the difference that it scales the texture space instead of the object. It has also a very special use case, and just works with a material with a Texture Coordinate / Generated node. And requires to have the shading at Material or Rendered to see a result in the viewport.

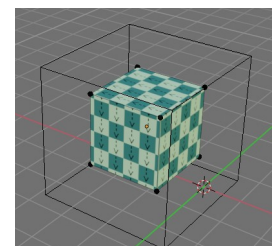

In the viewport you will see the UV cage in black color. In the header you will see the values for the current position of the UV cage.



Note that once done and applied, there is no way to reset the UV cage back to zero. When you repeat the operation, then the values will start at 0 again. Even when the UV cage is already offset.

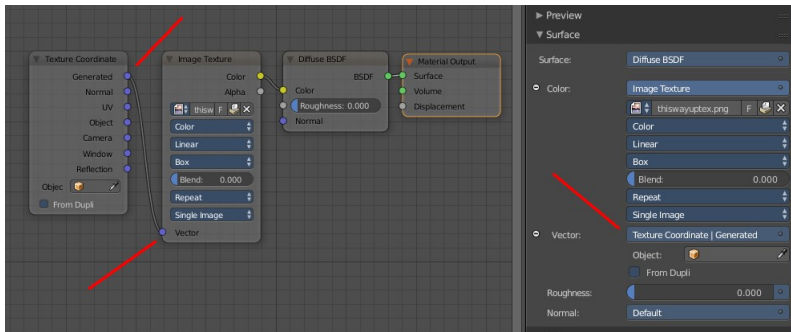

Last Operator Resize Texture

Move X, Y Z

Limit the position relative to the source object.

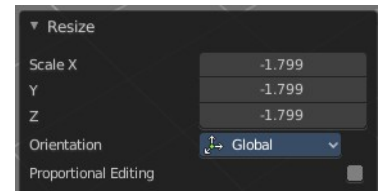

Orientation

Orientation is a drop-down box choose the type of orientation for the mirroring action.

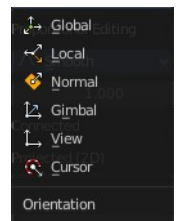

Proportional editing

Enables proportional editing. Activating proportional editing reveals further settings.

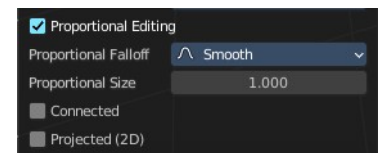

Proportional Falloff

Adjust the falloff methods.

Proportional Size

See and adjust the falloff radius.

Connected

The proportional falloff gets calculated for connected parts only.

Projected(2D)

The proportional falloff gets calculated in the screen space. Depth doesn't play a role. When it's in the radius, then it gets calculated.

Set Dimensions

Edit Mode Only!

Normally all scale operations in Bforartists are relative to the current selection and dimensions. And you always start with a relative value of 1.

Set dimensions allows to scale mesh selections in absolute world values. No matter how the initial values are. The new values gets set in the Last Operator.

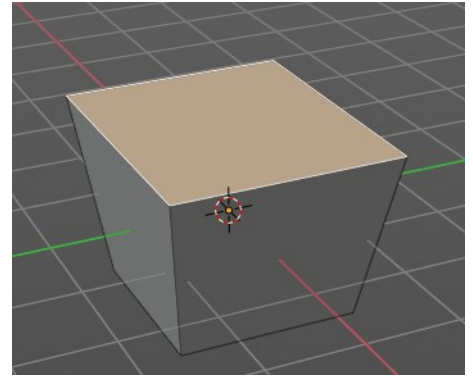

Set dimensions is an add-on. You can turn it off in the add-ons section of the user preferences when you want.

Last Operator Set Dimensions

New Dimensions

When you activate the tool then you will see the world coordinates of the selection. Change the values to other world coordinates.

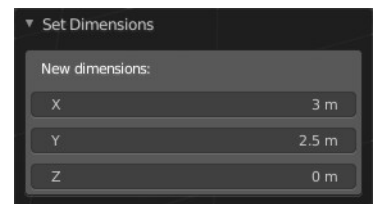

Mirror

Mirror mirrors the selected geometry along the defined axis.

Interactive Mirror

Mirror by hotkeys. You activate the tool, type in x for x global for example, or x x for x local. And the selection gets mirrored



X Global, Y Global etc.

Mirrors the selection around the chosen axis.

Last Operator Mirror

The Last Operator Mirror panel gives you tools to adjust the mirror action.

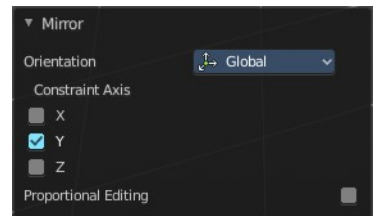

Orientation

Orientation is a drop-down box choose the type of orientation for the mirroring action.

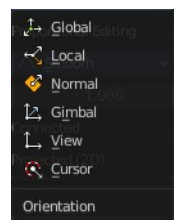

Constraint Axis

Constraint Axis gives you again the possibility to define the mirror axis. You can choose more than one axis here.

Proportional editing

Enables proportional editing. Activating proportional editing reveals further settings.

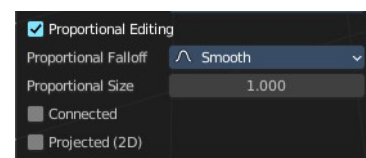

Proportional Falloff

Adjust the falloff methods.

Proportional Size

See and adjust the falloff radius.

Connected

The proportional falloff gets calculated for connected parts only.

Projected(2D)

The proportional falloff gets calculated in the screen space. Depth doesn't play a role. When it's in the radius, then it gets calculated.

Mirror Vertex Group

This tool requires to have a vertex group assigned. It mirrors the selected vertex group.

This tool works only with a perfectly symmetrical mesh along the local X axis. Vertices that have no corresponding vertex on the other side will not be affected.

Last Operator Mirror Vertex Group

Mirror Weights

Mirrors the Weight Painting informations from the symmetrical counterpart.

When both are selected it will become a group and weight information exchange. If only one is selected, then the information from the unselected vertice will go to the selected vertice.

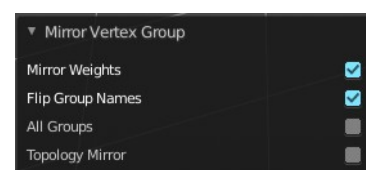

Flip Group Names

Flip selected group names. This works with vertex groups with symmetrical name conventions. Like .L , .R, right, left.

All Groups

Pass information to all groups instead of the active one.

Topology Mirror

Use topology based mirroring.

Snap

Choose several methods to snap one element to another. The menu items should be self explaining.



Last Operator Snap

Some snap operations shows a last operation panel, some not.

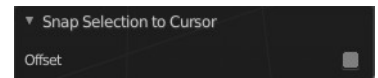

Offset

If the selection should snap as a whole, or if each individual element of the selection should snap.

Single Operators

Duplicate

Duplicates the current selection.

When you duplicate a selection, then it sticks to the mouse until you left click. And moves around. A right click repositions the duplicated geometry at its original location.

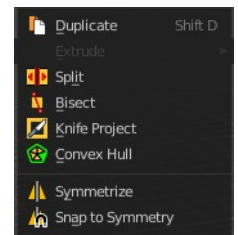

Last Operator Duplicate

Mode

Not to find out. No tool tip, no entry in the Blender manual. Good Job Blender Developers.

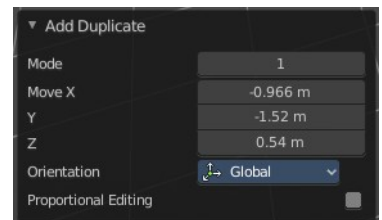

Move X, Y, Z

Adjust the position.

Orientation

Orientation is a drop-down box choose the type of orientation for the mirroring action.

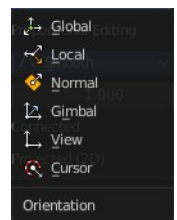

Constraint Axis

Constraint Axis gives you again the possibility to define the mirror axis. You can choose more than one axis here.

Proportional editing

Enables proportional editing. Activating proportional editing reveals further settings.

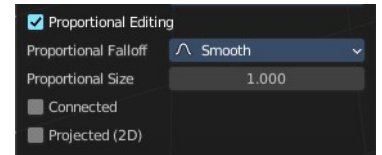

Proportional Falloff

Adjust the falloff methods.

Proportional Size

See and adjust the falloff radius.

Connected

The proportional falloff gets calculated for connected parts only.

Projected(2D)

The proportional falloff gets calculated in the screen space. Depth doesn't play a role. When it's in the radius, then it gets calculated.

Extrude

Extrude is a sub menu with several extrude methods. The content is dependent of the mesh select mode.

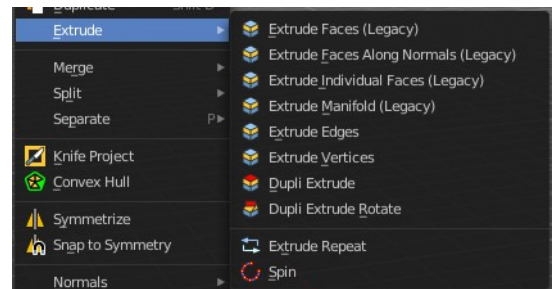

Note that the tool shelf also contains extrude functionality. And a few methods here are a double. These are marked with a (Legacy) in the tool name.

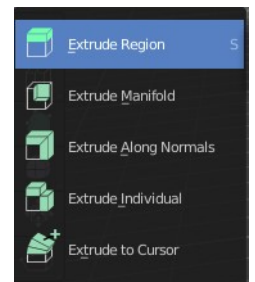

Extrude Faces (Legacy)

Extrude the selected faces along their normals. This functionality is part of the Extrude Region tool in the tool shelf.

Last Operator Extrude Region and Move

Flip Normals

Flips the normals of the extruded faces.

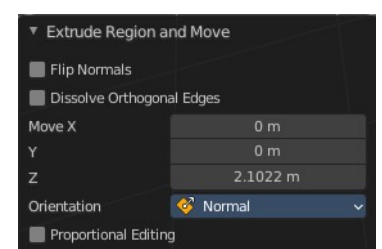

Dissolve Orthogonal Edges

Dissolves orthogonal edges at extrusion.

Move X, Y Z

The position. Attention, the actual world orientation and rotation does not matter here. It always starts with a value of zero, and moves relative to this zero then. For the actual location values have a look in the sidebar in the transform panel.

Orientation

The extrusion can have different orientations. The menu items should be self explaining.

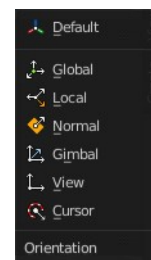

Proportional editing

Enables proportional editing. Activating proportional editing reveals further settings.

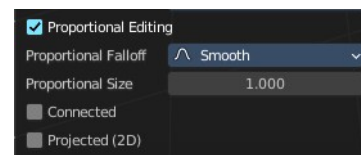

Proportional Falloff

Adjust the falloff methods.

Proportional Size

See and adjust the falloff radius.

Connected

The proportional falloff gets calculated for connected parts only.

Projected(2D)

The proportional falloff gets calculated in the screen space. Depth doesn't play a role. When it's in the radius, then it gets calculated.

Extrude Faces along Normals (Legacy)

In the toolshelf it's the Extrude Along Normals tool. Extrudes the selection along local normals. You won't see a widget here. Simply drag.

The method works the same in all Mesh select modes. Vertice, Edge and Face Mode.

Last Operator Extrude Region and Shrink/Fatten

Flip Normals

Flips the normals of the extruded faces.

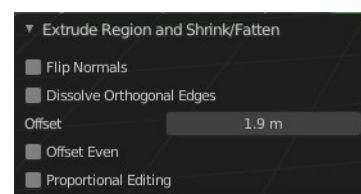

Dissolve Orthogonal Edges

Dissolves orthogonal edges at extrusion.

Offset

The current extrude amount.

Offset Even

Scales the offset to give more even thickness. Without this checked the farer away faces will have a bigger extrude amount.

Proportional editing

Enables proportional editing. Activating proportional editing reveals further settings.

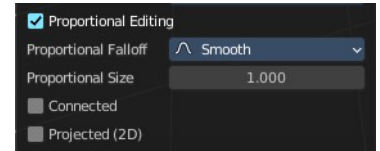

Proportional Falloff

Adjust the falloff methods.

Proportional Size

See and adjust the falloff radius.

Connected

The proportional falloff gets calculated for connected parts only.

Projected(2D)

The proportional falloff gets calculated in the screen space. Depth doesn't play a role. When it's in the radius, then it gets calculated.

Extrude Individual Faces (Legacy)

In the tool shelf the tool is called Extrude Individual. Extrudes the selection along local normals of each individual face. You won't see a widget here. Simply drag.

The method works the same in all Mesh select modes. Vertice, Edge and Face Mode.

Last Operator Extrude Individual Faces and Move

Offset

The current extrude amount.

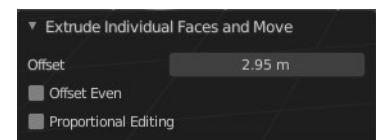

Offset Even

Scales the offset to give more even thickness. Without this checked the farer away faces will have a bigger extrude amount.

Proportional editing

Enables proportional editing. Activating proportional editing reveals further settings.

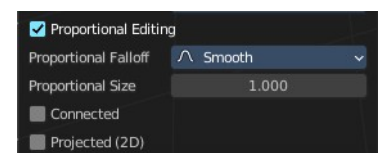

Proportional Falloff

Adjust the falloff methods.

Proportional Size

See and adjust the falloff radius.

Connected

The proportional falloff gets calculated for connected parts only.

Projected(2D)

The proportional falloff gets calculated in the screen space. Depth doesn't play a role. When it's in the radius, then it gets calculated.

Extrude Manifold (Legacy)

The same tool exists in the tool shelf. Extrude, dissolve Edges whose faces form a flat surface, and intersect new edges.

The method works the same in all Mesh select modes. Vertice, Edge and Face Mode.

Last Operator Extrude Manifold

Flip Normals

Flips the normals of the extruded faces.

Dissolve Orthogonal Edges

Dissolve edges that are at the same straight surface.

Move X, Y Z

The position. Attention, the actual world orientation and rotation does not matter here. It always starts with a value of zero, and moves relative to this zero then. For the actual location values have a look in the sidebar in the transform panel.

Orientation

The widget can have different orientations. The menu items should be self explaining.

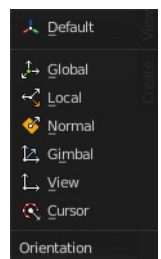
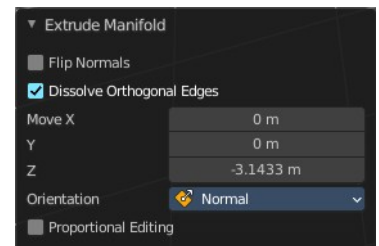

Proportional editing

Enables proportional editing. Activating proportional editing reveals further settings.

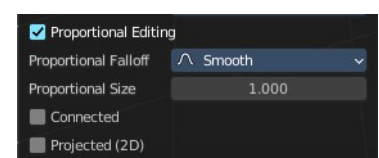

Proportional Falloff

Adjust the falloff methods.

Proportional Size

See and adjust the falloff radius.

Connected

The proportional falloff gets calculated for connected parts only.

Projected(2D)

The proportional falloff gets calculated in the screen space. Depth doesn't play a role. When it's in the radius, then it gets calculated.

Extrude Edges

Extrudes out the selected edges by moving the mouse.

Last Operator Extrude Only Edges and Move

Flip Normals

Flip the normals at the involved faces.

Move X Y Z

The coordinates for the extruded geometry.

Orientation

Choose the type of orientation, in which coordinate system the action should happen.

Constraint Axis

Proportional editing

Enables proportional editing. Activating proportional editing reveals further settings.

Proportional Falloff

Adjust the falloff methods.

Proportional Size

See and adjust the falloff radius.

Connected

The proportional falloff gets calculated for connected parts only.

Projected(2D)

The proportional falloff gets calculated in the screen space. Depth doesn't play a role. When it's in the radius, then it gets calculated.

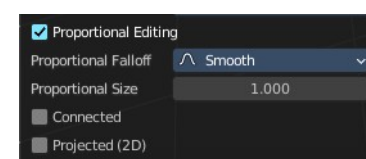
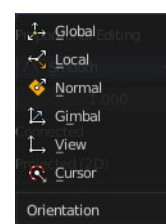
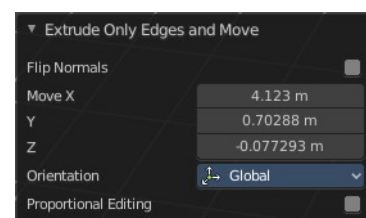

Extrude Vertices

Extrudes out the selected vertices by moving the mouse.

Last Operator Extrude Only Vertices and Move

Move X Y Z

The coordinates for the extruded geometry.

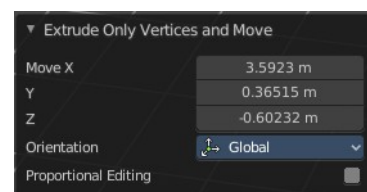

Orientation

Choose the type of orientation, in which coordinate system the action should happen.

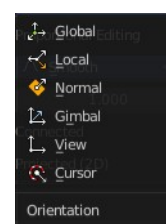

Constraint Axis

Proportional editing

Enables proportional editing. Activating proportional editing reveals further settings.

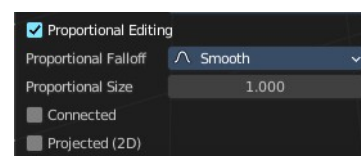

Proportional Falloff

Adjust the falloff methods.

Proportional Size

See and adjust the falloff radius.

Connected

The proportional falloff gets calculated for connected parts only.

Projected(2D)

The proportional falloff gets calculated in the screen space. Depth doesn't play a role. When it's in the radius, then it gets calculated.

Dupli Extrude / Dupli Extrude Rotate

Dupli Extrude is a two trick tool. With faces selected it creates a rotated copy of the geometry. With edges or vertices selected it extrudes to the mouse position. That's why it is a good idea to use this tool with a hotkey. But note that we have currently no hotkey assigned to this legacy functionality.

Dupli Extrude Rotate behaves the same than Dupli Extrude, but rotates the source geometry too.

Dupli Extrude - with selected Faces

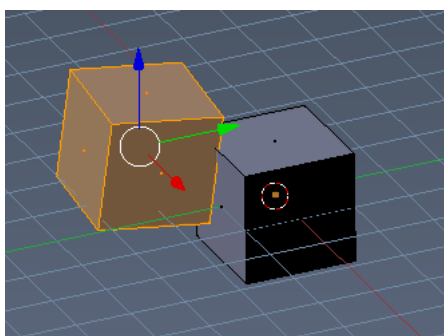

Dupli Extrude with selected faces creates a copy of the selection and rotates it slightly.

Dupli Extrude - with selected Vertices

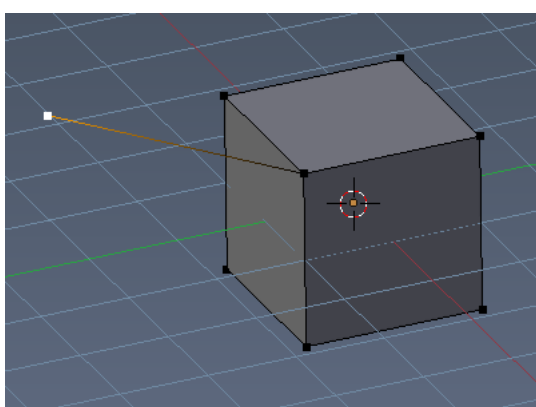

Dupli Extrude with selected vertices extrudes the vertice to the mouse position.

Extrude Repeat

All modes. Extrudes into the Z depth of the viewport, and repeats the extrusion by the adjusted amount. You have to adjust the extrusion afterwards.

Last Operator Extrude Repeat

Steps

How much repetitions.

Offset X / Y / Z

The offset in the x y and z direction.

Scale Offset

The scale factor of the extruded element.

Spin

All modes. Extrudes in a curve form.

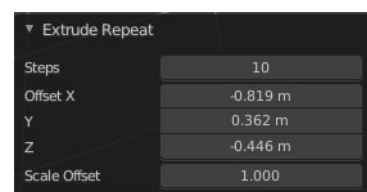

Last Operator Spin

Steps

How much segments.

Use Duplicates

Creates not connected geometry. In Vertex mode single vertices for example. Auto Merge and Flip Normals will not be available with duplicates.

Angle

The angle to extrude.

Auto Merge

Merge first and last element when the extrude is a full circle.

Flip Normals

Flip the normals of the extruded geometry.

Center X / Y / Z

The center point of the spin circle.

Axis

Axis in global View space. The values goes from -1 to 1.

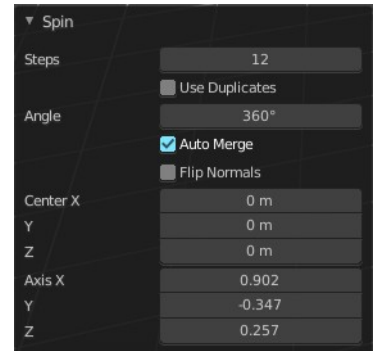

Merge

Merges the geometry.

At Center, At Cursor, Collapse, At First, At Last

Merges the geometry with the given methods.

The methods At First and At Last just shows when you have vertices selected, and there is at least one first vertice and one last vertice to merge at. So minimum two. But you can have more than one vertices selected.

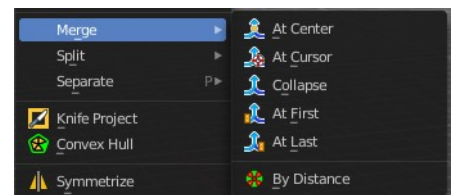
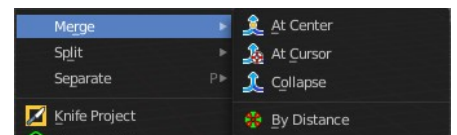

Last Operator Merge

Type

Choose the merge method again.

UV's

Move the UV's according to the merge.

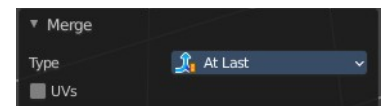

By Distance

Merge the vertices by their distance to each other. This tool is meant to remove double vertices at the same location.

Last Operator Merge by Distance

Merge Distance

Adjust the distance below which the vertices gets merged.

Merge selected vertices to unselected vertices.

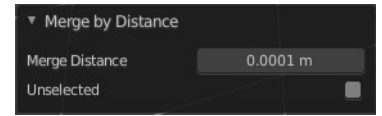

Split

Selection

Split splits the edges between the selected vertices. It creates two edges out of one. And splits the edge by that.

The mode doesn't matter. There will always the edges be splitted.

Faces by Edges / Faces by Edges by Vertices

Splits selected edges so that each neighbor face gets its own copy. You have two methods here.

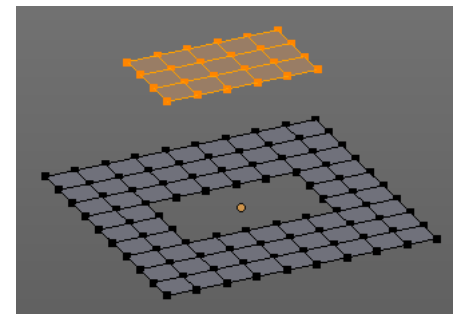
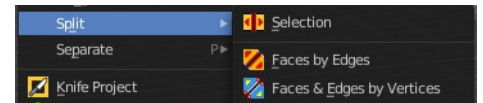

Last Operator Edge Split

Type

Choose the method again.

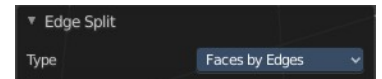

Separate

Separate separates the selected geometry, and creates a new object. The geometry becomes uneditable, since it is now a new object. You will have to leave the Edit mode, select the new object, and re-enter Edit mode when you want to edit it.

Selection

Selection separates the current selection.

By Material

By Material separates all geometry that has the same material than the current selection.

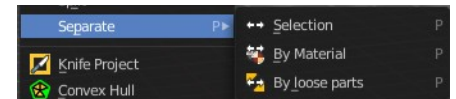

By Loose Parts

By Loose parts separates all geometry that is connected by edges to the current selection.

Knife Project

Knife Project uses an object as a knife to cut edges into a mesh.

Usage: Create a cube. Create a circle. Move the circle in front of the cube so that the geometry does not overlap the cube geometry. Enter Edit Mode with the cube. In the outliner hold down SHIFT, and select the circle. Note that you can select the circle in the 3d view with holding down CTRL.

Now that both objects are selected, go into front view, or whatever view you want. Just make sure that in the view the circle covers a part of the cube. Projection of the cut happens from the current view. Click the Knife Project tool.

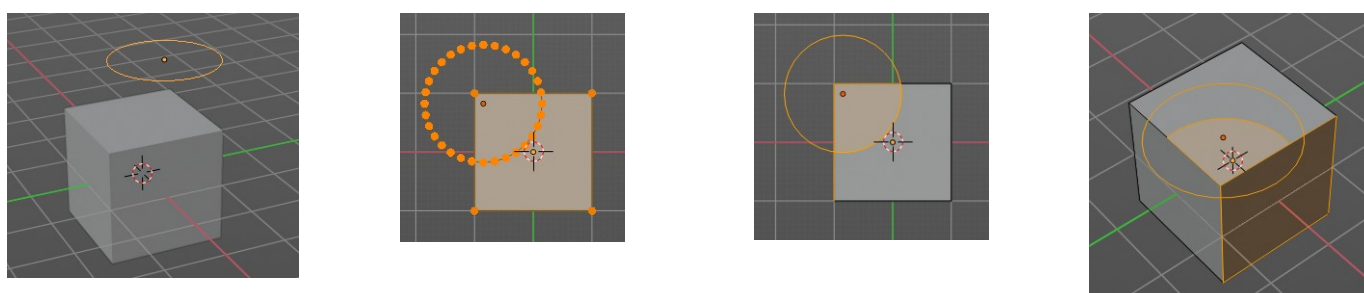

Last Operator Knife Project

Cut through

The cut goes through the whole object when the Cut through checkbox is ticked.

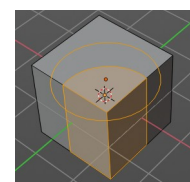
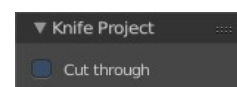

Convex Hull

Creates a convex hull around the outside of selected vertices. The old faces and inlaying vertices gets removed.

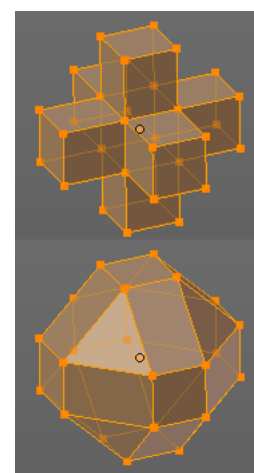

Last Operator Convex Hull

Delete Unused

Removes vertices that are not part of the convex geometry.

Use existing Faces

Use existing input faces that lies on the hull where possible. This option allows to have N-Gons in the convex hull.

Make Holes

Deletes edges and faces in the hull that were part of the input. This allows to delete faces between the existing mesh and the convex hull.

Join Triangles

Joins adjacent triangles into quads.

Max Face Angle

Max Face Angle belongs to the Join Triangles setting. Set the maximum face angle.

Max Shape Angle

Max Face Angle belongs to the Join Triangles setting. Set the maximum shape angle.

Compare UV's

Takes existing UV patches for the calculation into account.

Compare Vcols

Takes existing Vertex colors for the calculation into account.

Compare Seam

Takes existing seams for the calculation into account.

Compare Sharp

Takes existing sharp edges for the calculation into account.

Compare Materials

Takes existing materials for the calculation into account.

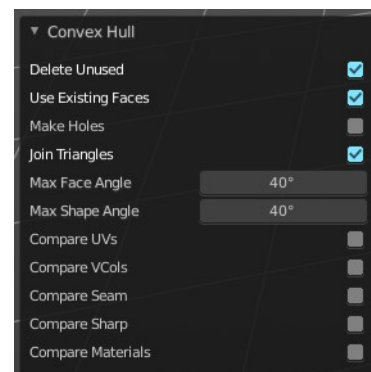

Symmetrize

The Symmetrize tool mirrors the selected geometry symmetrical along a world axis.

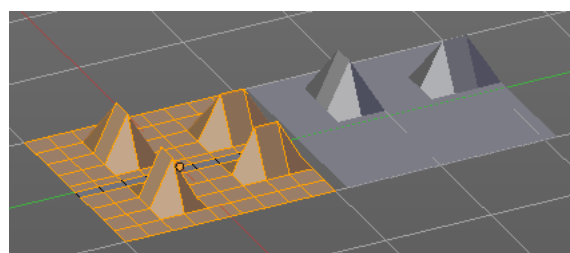

Last Operator Symmetrize

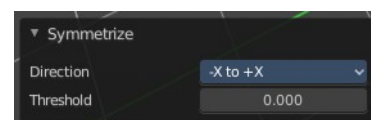

Direction

Direction is a drop down box define the mirroring direction.

Threshold

Adjust a distance after which the mirroring should happen, relative to the mirror axis. 0 means it mirrors the geometry directly at the axis.

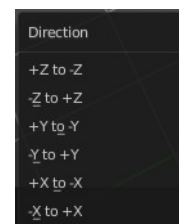

Snap to Symmetry

Tries to snap the selected vertices symmetrical along the chosen world orientation.

Last Operator Snap to Symmetry

Direction

The calculation direction.

Threshold

The threshold defines the radius in which matching vertices gets located. When you get a warning that snapping failed try increasing the threshold value.

Factor

The snapping factor. Blend mirrored locations from one side to the other. 0.5 is blending both sides equal.

Center

Snap vertices in the center axis to zero.

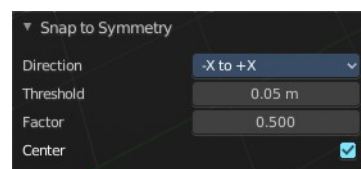

Smart Delete

Smart delete deletes what is selected in an intelligent way. When you for example delete an edge then the edge gets deleted. But it also deletes the vertices connected to this edge. It performs a Dissolve operation under the hood.

There is also a Delete and Dissolve menu in the Mesh menu, choose different methods for deleting if required.

Smart delete is an add-on. And can be deactivated if desired.

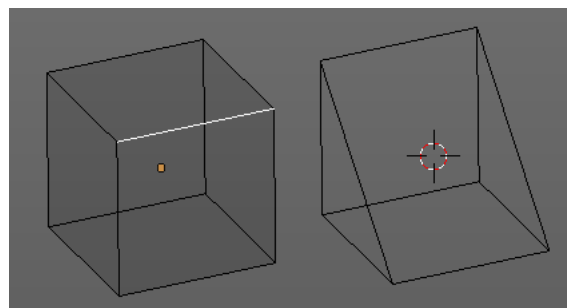

Normals

This menu contains functionality about dealing with normals. Normals influences the shading and the direction of a face. They can point inwards or outwards. And edges can be split. So that two adjacent faces have a sharp edge.

You can activate the display of normals in the Overlays panel in Edit mode.

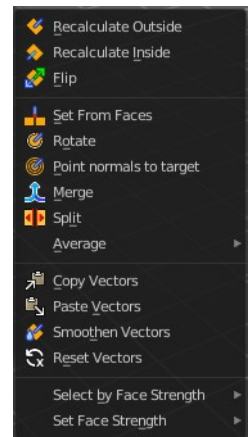
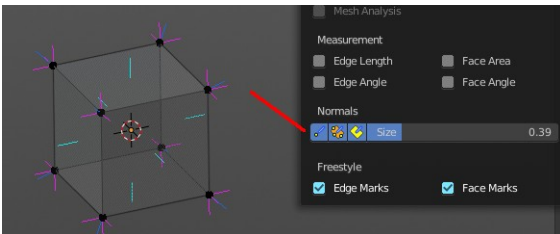

Recalculate Outside

Recalculates the normals of the selected geometry so that everything points outwards.

Last Operator Recalc Outside

Inside

Inside recalculates the normals of the selected geometry so that everything points inwards.

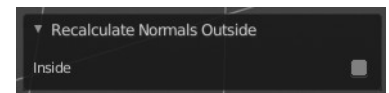

Recalculate Inside

Recalculates the normals of the selected geometry so that everything points inwards.

Flip

Flips the direction of the normals of the selected geometry.

Set from Faces

Sets the vertex normals from the selected faces. This tool requires to have Auto smooth activated!

Rotate

Rotate the normals of the selected vertices manually.

Last Operator Rotate Normals

Angle

The angle of the selected normal(s).

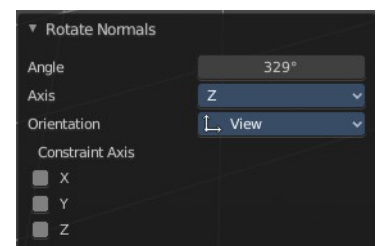

Axis

The axis to rotate around.

Orientation

Choose the type of orientation, in which coordinate system the action should happen.

Constraint Axis

Constraint specific axis.

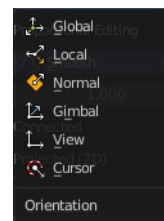

Point Normals to Target

All vertex normals will point to a specific target. This target can be chosen from hotkeys. They show in the header.

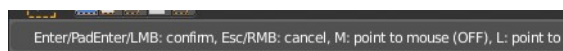

Pressing R for Reset will reset the normals to where they were before the operation.

Last Operator Point Normals to Target

Invert

The normal directions are reversed from what is specified.

Align

All normals will point in the same direction.

Target

The target position.

Spherize

Each normal will be interpolated between its original value and the direction to the target.

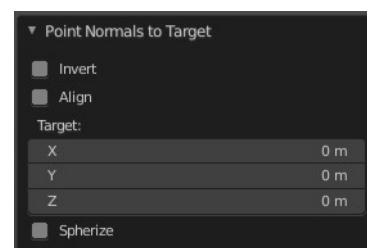

Merge

Merge all of the normals at selected vertices, making one average normal for all of the faces.

Split

Split the normals at all selected vertices so that there are separate normals for each face, pointing in the same direction as those faces.

Average

Average all of the normals in each fan of faces between sharp edges at a vertex.

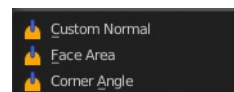

Custom Normal

Take the average of vertices normals.

Face Area

Set all vertices normals by face area.

Corner Angle

Set all vertices by corner angle.

Last Operator Average Normals

Type

Choose the average type again.

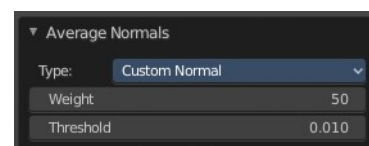

Weight

Just for custom normals method. Weight applied by face.

Threshold

Just for custom normals method. Threshold value for different weights to be considered as equal.

Copy Vectors

Copies the normals of a single selected vertice.

Paste Vectors

Pastes the normals from a formerly copied selected vertice to the currently selected vertice.

Last Operator Normals Vector Tools

Absolute Coordinates

When you paste normals then they get pasted relative to the current orientation of the selected vertice. With absolute coordinates the normals gets pasted in world coordinates.

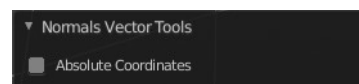

Smoothen Vectors

Smooth custom normals towards the adjacent vertex normals.

Last Operator Smooth Normals Vectors

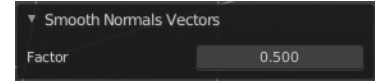

Factor

Adjust how strong the smoothen should be.

Reset Vectors

Resets the normal of the selected element(s).

Select by Face Strength

Face strength gets used by the Weighted Normals modifier. See Face Influence checkbox.

Select faces with either weak or medium or strong face strength.

Set Face Strength

Face strength gets used by the Weighted Normals modifier. See Face Influence checkbox.

Set selected faces to either a weak, a medium or a strong face strength.

Shading

Sets the shading of the selected elements to either smooth or flat.

Shading is under the hood a normals operation.

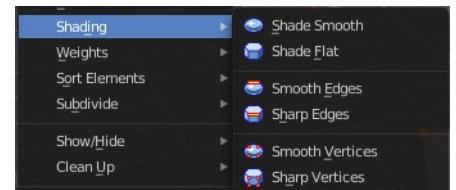

Weights

The Weights menu contains Weight tools. Those tools are meant to modify the weight mapping. At characters for example. The Weight Tools requires Vertex Groups to work with. Such Vertex groups gets created when you do weight painting at a character for example. Here is defined what bone is connected to what vertice.

In Edit Mode the weight mapping doesn't show. Here you work with the Vertex Groups.

In Weight paint mode the weight painting shows with colors. Here you usually paint the weighting.

This menu items also exists in Weight Paint mode.

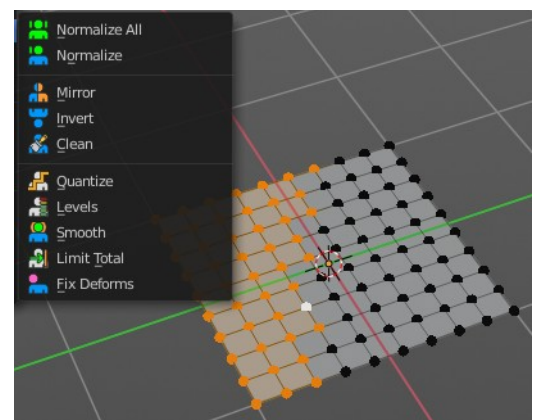

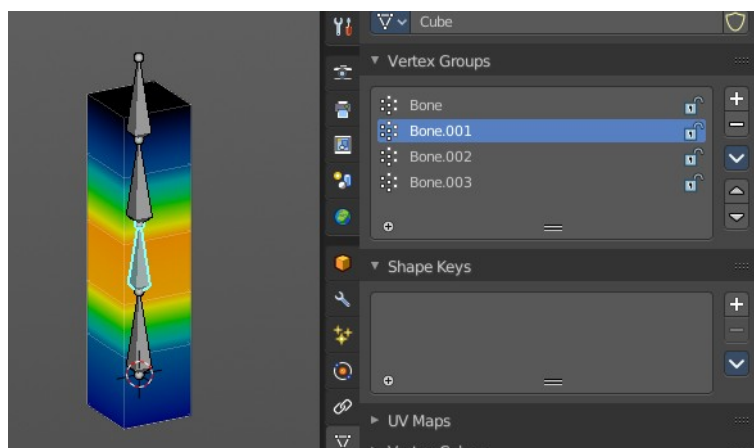

Normalize All

While weight painting it can happen that a vertice gets several weightings assigned. Normalize all normalizes the weight of all Vertex groups so that the values for the single vertices in the sum is 1.

Last Operator Normalize all

Subset

Subset is a drop-down menu choose the Subset method.

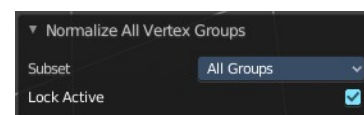

Lock Active

Keep the values of the active group while normalizing others.

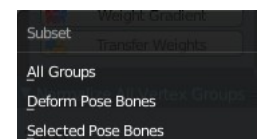

Normalize

Normalize normalizes the weight of the current selected Vertex group so that the values for the single vertices in the sum is 1. Means when there is influence from other groups, then those values are kept, but the one for the current group gets lowered so that the sum is 1.

The Last Operator Normalize panel has no adjustable settings.

Mirror

Mirror Vertex Group mirrors Vertex Groups and flips weights and/or names. It only edits selected Vertices. It flips when both sides are selected. Otherwise it copies from Unselected.

Last Operator Mirror Vertex Group

Mirror Weights

With Mirror Weights ticked it mirrors the weights.

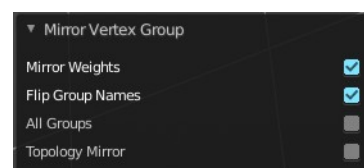

Flip Group Names

With Flip Group Names ticked it flips the Group names.

All Groups

Mirrors all Vertex Groups

Topology Mirror

Uses topology based mirroring. This requires matching mirrored topology.

Invert

Invert inverts the weight painting for the selected vertex group.

Last Operator Invert Vertex Group

Subset

Subset is a drop-down menu choose the Subset method.

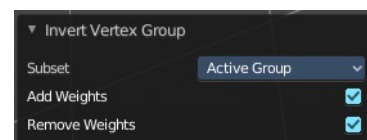

Add Weights

Add Vertices from Groups that have zero Weighting before inverting.

Remove Weights

Remove Vertices from Groups that have zero weight after inverting.

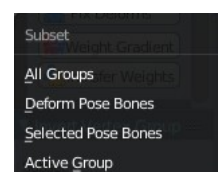

Clean

Removes Vertex group assignments that are not required from the active vertex group.

Last Operator Clean Vertex Group

Subset

Subset is a drop-down menu choose the Subset method.

Limit

Remove weights that are below or equal to the limit value.

Keep Single

Keep Vertices assigned to at least one vertex group when cleaning.

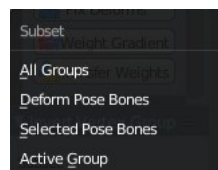
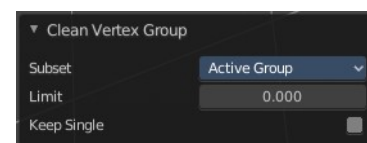

Quantize

Quantize quantizes the weight paint values. It starts with 4 steps. With a step of 1 you have a single vertex color, no matter how you have painted it before.

Last Operator Quantize

Subset

Subset is a drop-down menu choose the Subset method.

Steps

Here you adjust in how many steps the weight paint colors should be divided.

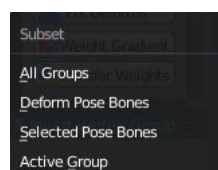
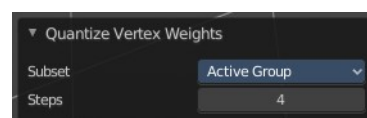

Levels

Adds some offset to the Weight paint, and multiplies it with some gain.

Last Operator Vertex Group Levels

Subset

Subset is a drop-down menu choose the Subset method.

Offset

Here you adjust the offset.

Gain

Here you adjust the gain.

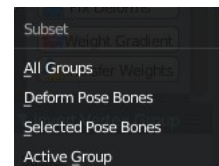
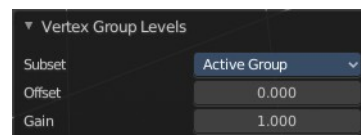

Smooth

Smooths the weight for selected vertices.

Last Operator Smooth Vertex Weights

Subset

Subset is a drop-down menu choose the Subset method.

Factor

Here you adjust the factor.

Iterations

Here you adjust how many iterations you use.

Expand/Contract

Expand or contract the weights.

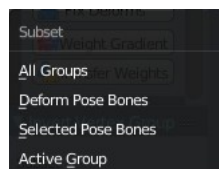
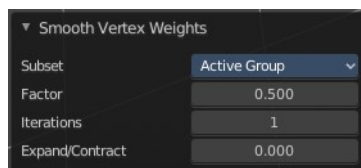

Limit Total

Limit number of Weights per vertex. The lowest weights gets removed.

This is of interest when you have for example five bones associated with a vertice. But your game engine just allows four ...

Last Operator Limit Number of Weights per Vertex

Subset

Subset is a drop-down menu choose the Subset method.

Limit

Here you adjust how many weights are allowed.

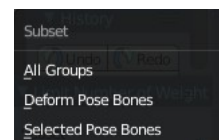
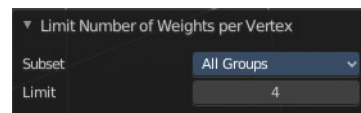

Fix Deforms

Modify the position of selected vertices by changing only their respective group weights.

This tool may operate slow at too many vertices.

Last Operator Fix Deforms

Distance

Adjust the distance.

Strength

Adjust the strength.

Change Sensitivity

Adjust the sensitivity.

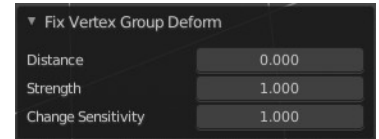

Set Attribute

Set values of the active attribute for the selected element.

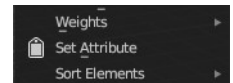

The operator calls a popup where you can for now adjust UV mapping values.

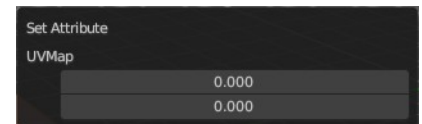

Sort Elements

Sort Elements is a menu with different sorting methods. It allows you to reorder the mesh indices of the selected mesh elements by various methods.

The indices can be turned on in the Overlays menu in the Developer section.

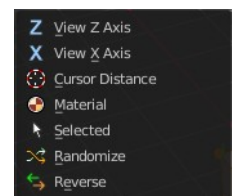
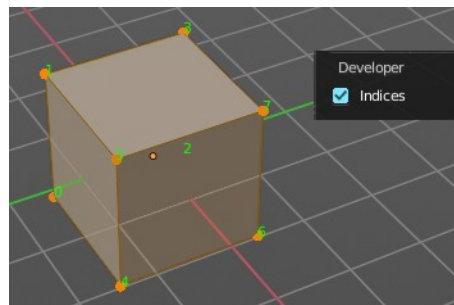

View Z Axis

Sorts along the active view's Z axis, from farthest to nearest. You can use Reverse if you want it the other way.

View Y Axis

Sorts along the active view's Y axis, from farthest to nearest. You can use Reverse if you want it the other way.

Cursor Distance

Sorts from nearest to farthest away from the 3D cursor position.

Material

Faces only! Sorts faces by their lowest material index up to highest material index. Order of faces inside each of those material groups remains unchanged.

Note that the Reverse option only reverses the order of the materials. And the order of the faces inside them.

Selected

Moves all selected elements to the beginning without affecting their relative orders. Attention, this option will also affect unselected element indices!

Randomize

Randomizes the indices of selected elements. This option does not affect the unselected elements.

Reverse

Reverses the order of the selected elements.

Last Operator Sort Mesh Elements

Sort Elements always brings up the same last operator. But with a small difference for Randomize and Reverse. Reverse has no checkbox. And Randomize has a Seed checkbox.

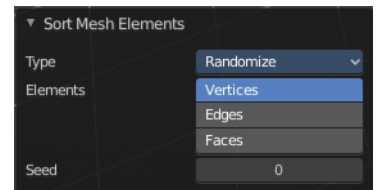

Type

This is a drop-down box choose the sort method again.

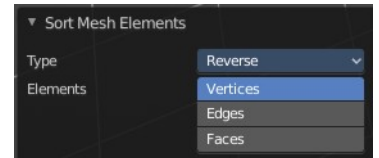

Vertices, Edges or Faces

Adjust if the sort will affect the vertices, edges or faces.

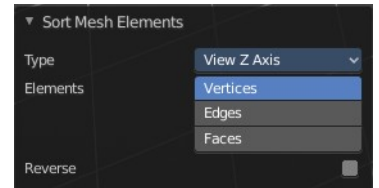

Reverse Checkbox

Reverses the sorting.

Seed Edit box (Randomize only)

The seed option allows you to get another randomization – the same seed over the same mesh/set of selected elements will always give the same result!

Subdivide

Subdivide is a menu where you can quickly add and change a subdivision surface modifier with a predefined resolution in a quick way. Especially when you use the hotkey for it. The subdivision surface modifier panel can then as usual be found in the Properties editor in the Modifier tab.

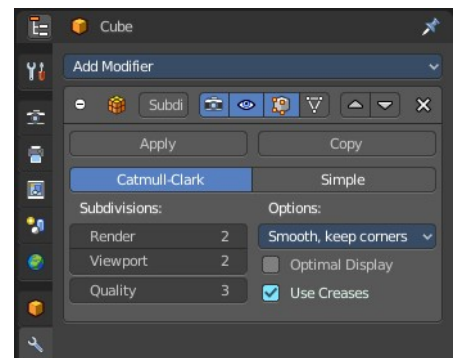
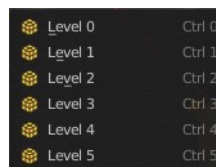

Last Operator Subdivision Set

Level

Set the level of subdivisions



Relative

Applies the sub surf level as an offset to the already existing sub surf level.

Show / Hide

The Show/Hide menu is available for all object types and in all modes. It is usually in the object related menu to find. In Object mode it's the Object menu, for a curve object in edit mode it is the Curve menu. It always contains three menu items. Show Hidden, Hide Selected and Hide Unselected.

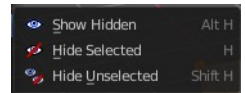

Show Hidden

Makes all hidden elements in the scene visible again.

Hide Selected

Hides the selected elements.

Hide Unselected

Hides the not selected elements. The selected elements stays visible.

Last Operator Reveal Hidden / Hide Selected

Select

Define if the selected or the unselected elements gets hidden or revealed.



Cleanup

In the Cleanup menu you will find tools to clean up the current geometry.

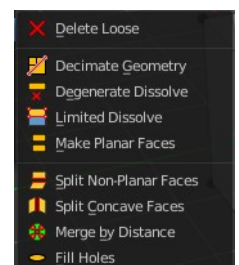

Delete Loose

Delete loose deletes not connected geometry. Vertices, Edges, and Faces. The tool starts with deleting Vertices and Edges. But you can tick Faces in the Last Operator too, and then it also removes not connected Faces.

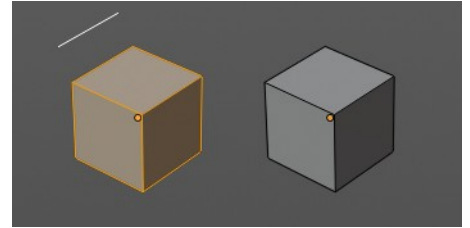

Last Operator Delete Loose

Vertices

Delete Vertices.

Edges

Delete Edges.

Faces

Delete Faces.

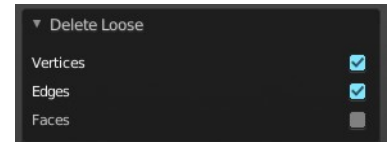

Decimate Geometry

Decimate Geometry decimates the currently selected geometry. It starts with a Ratio of 1. Which means no decimation. The lower the ratio the more decimation you will get. The Decimate Modifier works with Tris!

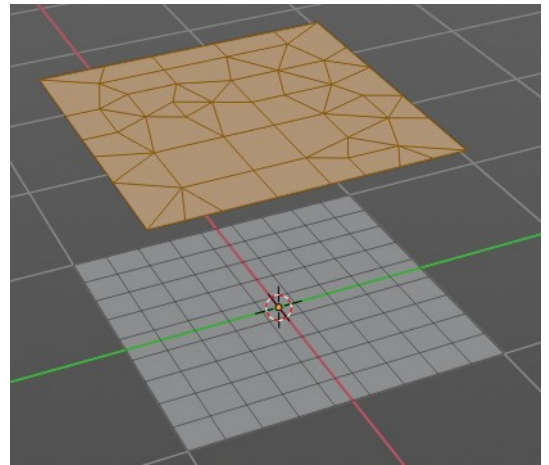

Last Operator Decimate Geometry

Ratio

Adjust the strength of decimation.

Vertex Group

Use active Vertex Group as an influence. You need to have a Vertex Group.

Weight

Adjust the Vertex Group Strength.

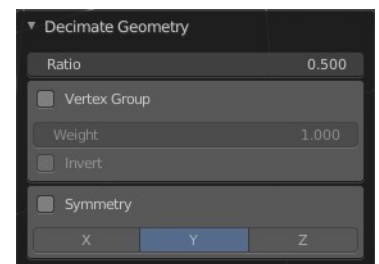

Invert

Invert Vertex Group Influence.

Symmetry

Make the decimation geometry symmetric along a chosen world axis.

Degenerate Dissolve

Removes zero size Faces and Edges.

Make Planar Faces

Make Planar Faces tries to make the selected faces planar. Quads or N-Gons for example can have vertices that are not planar.

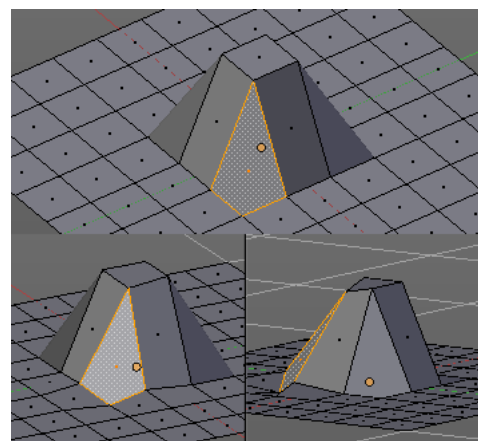

Last Operator Make Planar Faces

Factor

Here you adjust how strong the influence should be.

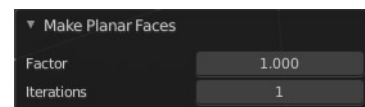

Iterations

Here you adjust how often it should repeat in the try to find a solution.

Split Non-Planar Faces

Split Non Planar Faces splits up non planar Quads and N-Gons to end in planar faces.

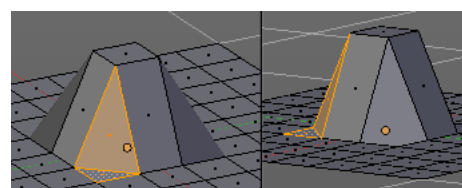

Last Operator Split Non-Planar Faces

Max Angle

Limit the action to a maximum angle.

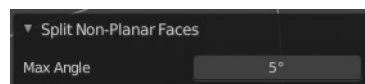

Split Concave Faces

Splits concave faces to make the geometry more stable. This tool is thought for N-Gons.

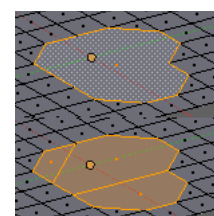

Merge by Distance

Merges vertices that are very close to each other. The merge happens at the center. When you need more control then you should use the Merge Vertices tool.

Last Operator *Merge by Distance*

Merge Distance

Adjust the distance in which the vertices gets merged.

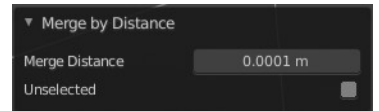

Unselected

Merge selected vertices also with other unselected vertices.

Fill Holes

Fill holes closes holes in the mesh geometry.

Fill holes can just calculate one face size at one time. So when you have several holes in the mesh, let's say one is a tri, and one is a quad, then you need to calculate twice.

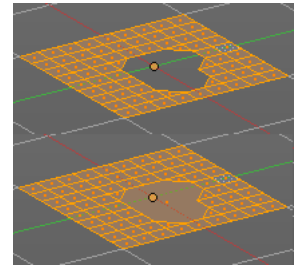

Last Operator Fill Holes

Sides

Define what face size will be filled.



Delete

The smart delete add-on. usually does the delete job already fine. It deletes the selected element(s).

There are sometimes some situations where you need more control over what you want to delete. The tools for this can be found in the Delete menu.



Vertices

Deletes the selected vertices, and all with it connected edges and faces.

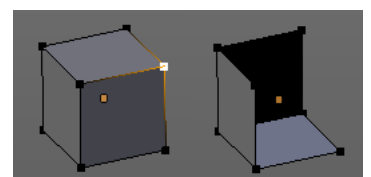

Edges

Deletes the selected edges and the connected faces.

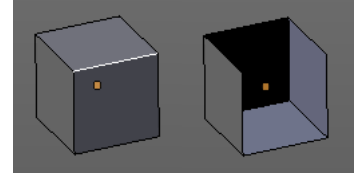

Faces

This one works similar to the smart delete. It deletes the selected faces.

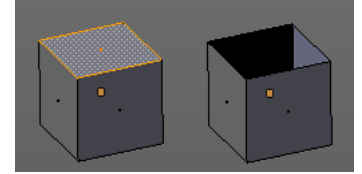

Only Edges and Faces

This mode is of interest when you have more than one selection mode activated. It deletes then just the selected edges and faces. And not single vertices.

Only Faces

This mode is of interest when you have more than one selection mode activated. Just selected faces gets deleted. Not single edges or vertices.

Edge Loops

This method works similar to the smart delete tool. It deletes the edge loop. But it selects the faces of the edge ring. And the Last operator offers you the option to split off face corners.

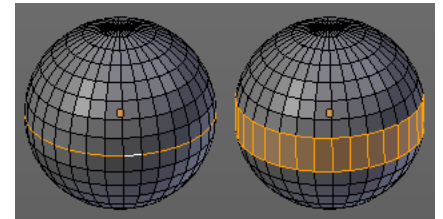

Last Operator Delete Edge Loop

Face Split

Split off face corners to maintain surrounding geometry.

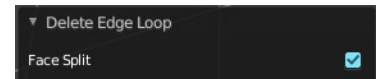

Dissolve

Dissolve operations removes for examples selected vertices, edges and faces. But they are not delete operations. They are union tools.

When you for example choose Delete vertices from the mesh menu, then the involved faces can get deleted too. When you choose Dissolve vertices, then the vertices gets removed, and the faces stays intact. The edges gets unioned.

Dissolve is a union operation.

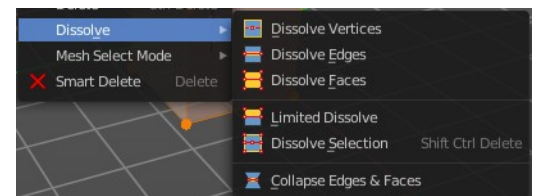

Dissolve Vertices

Dissolve Vertices dissolves the selected Vertices.

Note that pressing DEL in Vertice select mode calls Dissolve Vertices already. It's the same operator. But you

don't get the Last operator that way.

Last Operator Dissolve Vertices

Face Split

Split off Face corners to maintain surrounding geometry

Tear Boundary

Split off Face corners instead of merging faces.

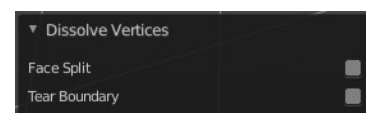

Dissolve Edges

Dissolve Edges dissolves the selected Edges.

Note that pressing DEL in Edge select mode calls Dissolve Edges already. It's the same operator. But you don't get the Last operator that way.

Last Operator Dissolve Edges

Dissolve Verts

When the dissolve operation leaves vertices behind, then this vertices will be dissolved too.

Face Split

Split off Face corners to maintain surrounding geometry.

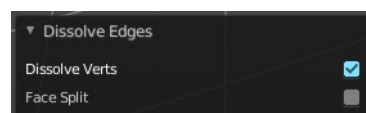

Dissolve Faces

Dissolve Faces removes the inlaying edges of the selected faces. This faces becomes one big N-Gon.

Last Operator Dissolve Faces

Dissolve Verts

When the dissolve operation leaves vertices behind, then this vertices will be dissolved too.

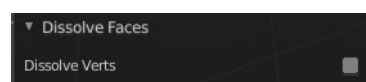

Dissolve Selection

Dissolves the selected geometry.

Last Operator Dissolve Selection

Dissolve Verts

When the dissolve operation leaves vertices behind, then this vertices will be

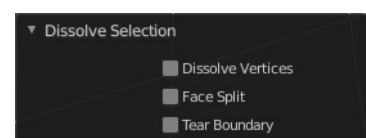

dissolved too.

Face Split

Split off Face corners to maintain surrounding geometry.

Tear Boundary

Split off face corners instead of merging faces.

Limited Dissolve

Limited Dissolve dissolves the selected Edges and Vertices, limited by the surrounding geometry.

Last Operator Limited Dissolve

Max Angle

The limiting angle.

All Boundaries

All Boundaries dissolves in-between face boundaries.

Delimit

You can also delimit by other methods than normals.

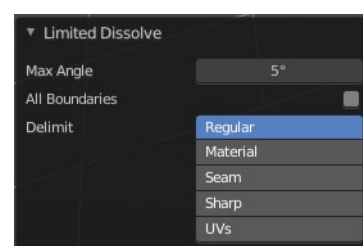

Edge Collapse

Edge Collapse collapses the selected edges to a vertice at the center of the selection.

Mesh Select Mode

Mesh Select mode is a sub menu Set the current mesh select mode. Its functionality is equal to the mesh select mode buttons in the header. Just that you can't select more than one mode directly here.

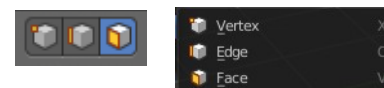

This menu just exists to show and to edit the hotkeys. Not to work with it.



7.2 Editors - 3D Viewport - Tool Shelf

Table of content

Tool Shelf.....	2
Active Tool.....	2
Tool Settings.....	2
Mode dependent content.....	2
Tool tips.....	2
Tool groups.....	3
Resizing the tool shelf.....	3
Switching Tools.....	3
Cycling through Tools in groups.....	4
Tool Shelf Tabs.....	4

Tool Shelf

Some editors have a tool shelf at the left. Here you can find and use various tools.



Active Tool

In the tool shelf there can just be one active tool in the tool shelf. An activated tool stays active as long as you don't change it. To deactivate the current tool you have to choose another tool. One of the select tools for example.

Tool Settings

When you activate a tool in the tool shelf then you will also reveal its tool settings. There are two locations where you can find the tool settings. In the header, and in the sidebar in the Tool tab. It's your choice with which panel you want to work.

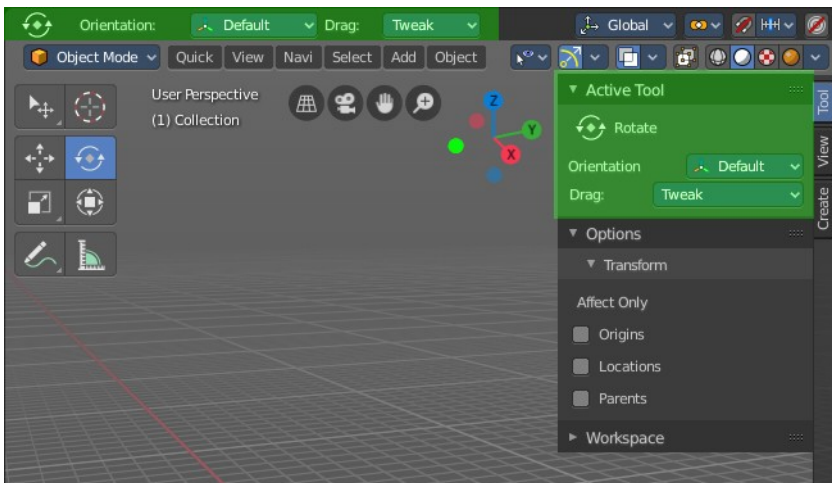

Mode dependent content

The content of the tool shelf is changing depend and of the mode that you are in, and dependent of the object type. A mesh object in edit mode has another set of tools than a metaball. But there are some tools that are available in all modes. 3D Cursor, Select tools and Transform tools.

Tool tips

The new tool system works here and there different from the old tool system. It is one gigantic hack on top of the old tool system. Already the tool tips are different. It misses the Python strings. And some tools misses a proper description. The tool tips are separated from the operators.

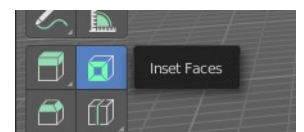
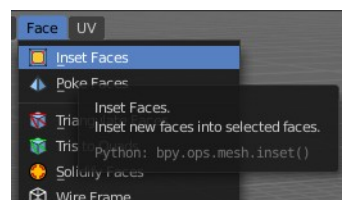

Tool groups

Some icons have a white small triangle down right. This indicates that this icon is part of a tool group. This group can be revealed by holding down the mouse until the popup reveals the hidden tools. You can then choose the needed tool in this group. And it will become the one that gets displayed.

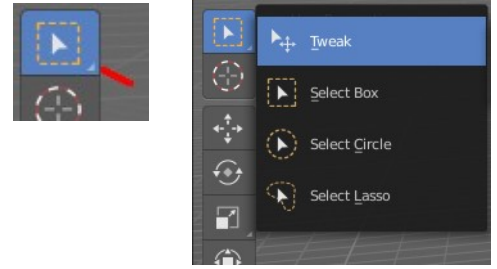

Resizing the tool shelf

The tool shelf can be resized by dragging the border of it in and out.

You have the choice between one, two and three icon rows. And text and icon buttons.

Currently the default starts with two rows.

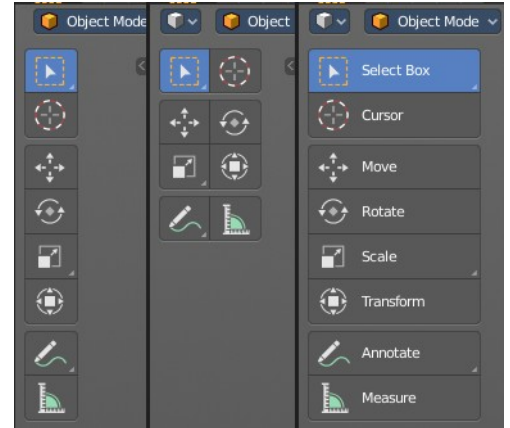

Switching Tools

The Blender key map provides a way to call the tools from the tool shelf under the mouse in a popup menu. And with hotkeys. Even when they don't have a hotkey assigned in the toolbar yet.

Keyboard tool switching is not enabled by default. You need to set the key-map preference Space bar Action to Tools. And when you press space bar, then you will see the tool shelf content under the mouse. But with an hotkey assigned. And then you can use this hotkey in combination with the space bar to activate the tool

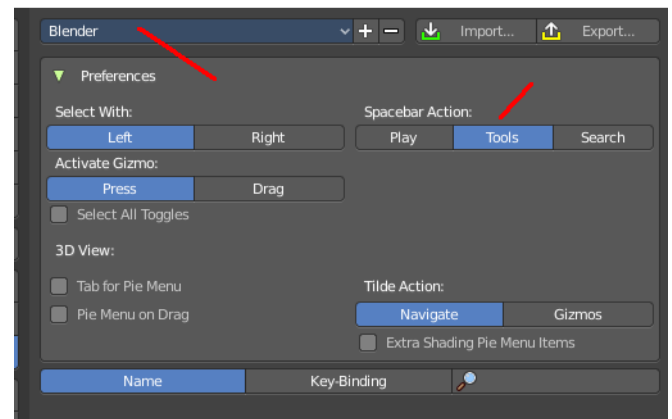

Spacebar-T for Transform, Spacebar-D for Annotate, Spacebar-M for measure, and so on.

The accelerator keys are displayed in the tool tips of the tools in the tool shelf. The hotkeys are hard coded. And are NOT the hotkeys for the tools in the tool shelf. But just the hotkeys in conjunction with the space bar menu!

Attention, this is not implemented in the Bforartists key map. This feature is just available in the Blender key map!

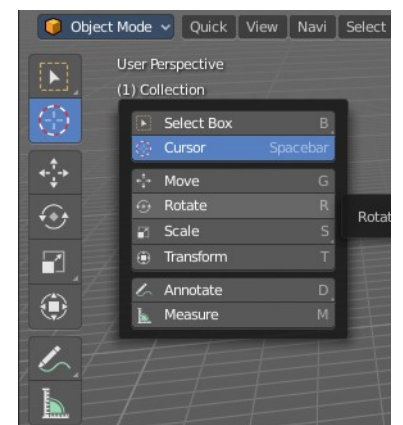

Cycling through Tools in groups

You can assign a hotkey to a group of tools, and then activate Cycle in the key map manager. This allows you to cycle through the tools in this group with the hotkey.

This is for example done with the Select tool group. The hotkey to cycle through the tools in the group shows in the tool tip.

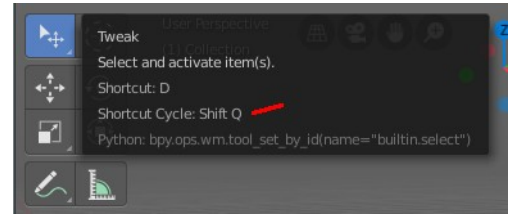

Tool Shelf Tabs

The tool shelf contains not only the new tool system tools. But contains also the old tools from the text menus in the header in tabs. They are a double menu entry by design. This tabs are faster to access. They resize like the tool shelf tabs, and allows icon rows of one, two and three width, and also the display as text buttons.

You can also pin panels. This allows for example to display the snap tools below the regular tool shelf tools. So that you don't need to dig in the text menus all the time. When they are pinned, then they are in reach with one click.

We won't explain the tools here, since they are already covered in the corresponding text menus.

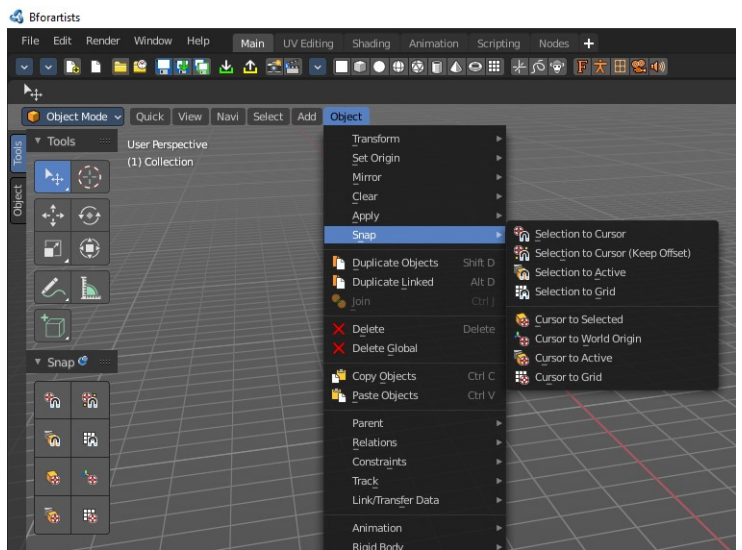

You can turn the tabs off in the View menu if you don't want to work with this tool set.

Note that you need to adjust the width of the tool shelf manually afterwards since it does not automatically update the width of the tool shelf area.

Note that you need to save the startup.blend to save the state of this checkbox. So be careful with modifications.

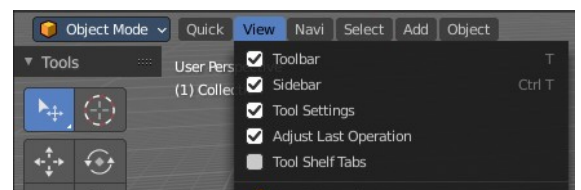
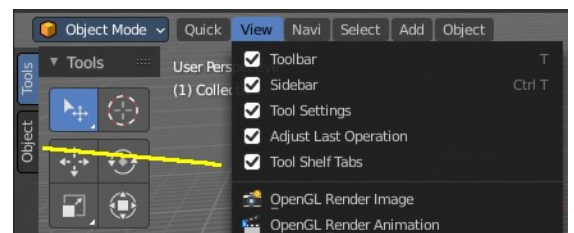



7.2.1 Editors - 3D Viewport - Tool Shelf - Object Mode

Table of content

Detailed table of content.....	1
Tool Shelf - Object Mode.....	8
Select Tools Group.....	8
Cursor.....	9
Move Rotate Scale Transform.....	10
Move.....	10
Rotate.....	12
Scale Tools Group.....	15
Transform.....	19
Modal Operators for the Transform tools.....	19
Annotate Tools group.....	23
Annotate tool.....	23
Annotate Line.....	25
Annotate Polygon.....	26
Annotate Eraser.....	27
Measure.....	28
Primitives Add tools group.....	28

Detailed table of content

Detailed table of content

Detailed table of content.....	1
Tool Shelf - Object Mode.....	8
Select Tools Group.....	8
Tweak.....	8
Select Box.....	8
Tool Settings.....	8
Mode.....	8
Set a new selection.....	8
Extend existing selection.....	8
Subtract existing selection.....	8
Inverts existing selection.....	8
Intersect existing selection.....	8
Select Circle.....	9
Tool Settings.....	9
Mode.....	9
Set a new selection.....	9
Extend existing selection.....	9
Subtract existing selection.....	9
Radius.....	9
Select Lasso.....	9
Tool Settings.....	9
Mode.....	9
Set a new selection.....	9
Extend existing selection.....	9

Subtract existing selection.....	9
Inverts existing selection.....	9
Intersect existing selection.....	9
Cursor.....	9
Tool Settings.....	10
Surface Project.....	10
Orientation.....	10
Move Rotate Scale Transform.....	10
Move.....	10
Snapping.....	10
Precision movement.....	10
Header Values.....	10
Numerical Input.....	11
Move without widget.....	11
Limit Axis.....	11
Tool Settings.....	11
Orientation.....	11
Last Operator Move.....	11
Move X, Y Z.....	11
Orientation.....	12
Proportional editing.....	12
Proportional Falloff.....	12
Proportional Size.....	12
Connected.....	12
Projected(2D).....	12
Rotate.....	12
Snapping.....	12
Precision rotation.....	13
Header Values.....	13
Numerical Input.....	13
Rotate without widget.....	13
Limit Axis.....	13
Tool Settings.....	13
Orientation.....	14
Last Operator Rotate.....	14
Angle.....	14
Axis.....	14
Orientation.....	14
Proportional editing.....	14
Proportional Falloff.....	14
Proportional Size.....	14
Connected.....	14
Projected(2D).....	14
Scale Tools Group.....	15
Scale.....	15
Snapping.....	15
Precision Scale.....	15
Header Values.....	15
Numerical Input.....	15
Scale without widget.....	15
Limit Axis.....	16
Tool Settings.....	16
Orientation.....	16

Last Operator Resize.....	16
Angle.....	16
Axis.....	16
Orientation.....	16
Proportional editing.....	17
Proportional Falloff.....	17
Proportional Size.....	17
Connected.....	17
Projected(2D).....	17
Scale Cage.....	17
Snapping.....	17
Header Values.....	17
Scale without widget.....	17
Limit Axis.....	18
Tool Settings.....	18
Orientation.....	18
Last Operator Resize.....	18
Angle.....	18
Axis.....	18
Orientation.....	18
Proportional editing.....	18
Proportional Falloff.....	19
Proportional Size.....	19
Connected.....	19
Projected(2D).....	19
Transform.....	19
Tool Settings.....	19
Drag Action.....	19
Orientation.....	19
Modal Operators for the Transform tools.....	19
General transform modal tools.....	20
Confirm.....	20
Cancel.....	20
X Axis.....	20
Y Axis.....	20
Z Axis.....	20
X Plane.....	20
Y Plane.....	20
Z Plane.....	20
Sert Snap Base.....	20
Snap Invert.....	20
Snap Toggle.....	21
Automatic Constraints.....	21
Automatic Constraints Plane.....	21
Precision Mode.....	21
Move tool in Object mode.....	21
Rotate.....	21
Resize.....	21
Move Tool in Edit mode.....	21
Vert/Edge Slide.....	21
Rotate.....	21
Resize.....	21
Rotate Tool in Object mode.....	22

Move.....	22
Trackball.....	22
Resize.....	22
Rotate Tool in Edit mode.....	22
Move.....	22
Trackball.....	22
Resize.....	22
Rotate Normals.....	22
Scale Tool in Object mode and Edit Mode.....	22
Move.....	22
Rotate.....	22
Annotate Tools group.....	23
Annotate tool.....	23
Tool Settings.....	23
Color.....	23
Note.....	23
Annotations list.....	24
Edit Box.....	24
Fake User.....	24
Add Annotation.....	24
Remove Annotation.....	24
Active Layer Index.....	24
Add Annotation Layer.....	24
Remove Annotation Layer.....	24
Opacity.....	24
Thickness.....	24
Frame Locked/Unlocked.....	24
Delete Active Frame.....	24
Placement.....	24
Stabilize Stroke.....	25
Radius.....	25
Factor.....	25
Drag.....	25
Annotate Line.....	25
Tool Settings.....	25
Placement.....	25
Style Start.....	25
End.....	25
Annotate Polygon.....	26
Tool Settings.....	26
Color.....	26
Note.....	26
Annotations list.....	26
Edit Box.....	26
Fake User.....	26
Add Annotation.....	26
Remove Annotation.....	27
Active Layer Index.....	27
Add Annotation Layer.....	27
Remove Annotation Layer.....	27
Opacity.....	27
Thickness.....	27
Frame Locked/Unlocked.....	27

Delete Active Frame.....	27
Placement.....	27
Annotate Eraser.....	27
Tool Settings.....	27
Radius.....	27
Measure.....	28
Restrict to global axis.....	28
Measuring angles.....	28
Snapping.....	28
Delete measure lines.....	28
Primitives Add tools group.....	28
Add Cube.....	29
Tool Settings.....	29
Depth.....	29
Position.....	29
Surface.....	29
3D Cursor Plane.....	29
3D Cursor View.....	29
Orientation.....	30
Snap To.....	30
Plane Axis.....	30
Auto Axis.....	30
Base.....	30
Origin.....	30
Aspect.....	30
Height.....	30
Origin.....	30
Aspect.....	30
Last Operator Add Cube Panel.....	30
Add Cone.....	31
Tool Settings.....	31
Depth.....	31
Position.....	31
Surface.....	31
3D Cursor Plane.....	31
3D Cursor View.....	31
Orientation.....	31
Snap To.....	31
Plane Axis.....	31
Auto Axis.....	31
Base.....	31
Origin.....	31
Aspect.....	31
Height.....	32
Origin.....	32
Aspect.....	32
Vertices.....	32
Base Fill Type.....	32
Last Operator Add Cone Panel.....	32
Add Cylinder.....	33
Tool Settings.....	33
Depth.....	33
Position.....	33

Surface.....	33
3D Cursor Plane.....	33
3D Cursor View.....	33
Orientation.....	33
Snap To.....	33
Plane Axis.....	33
Auto Axis.....	33
Base.....	33
Origin.....	33
Aspect.....	33
Height.....	34
Origin.....	34
Aspect.....	34
Vertices.....	34
Last Operator Add Circle Panel.....	34
Add UV Sphere.....	35
Tool Settings.....	35
Depth.....	35
Position.....	35
Surface.....	35
3D Cursor Plane.....	35
3D Cursor View.....	35
Orientation.....	35
Snap To.....	35
Plane Axis.....	35
Auto Axis.....	35
Base.....	35
Origin.....	35
Aspect.....	36
Height.....	36
Origin.....	36
Aspect.....	36
Segments.....	36
Rings.....	36
Last Operator Add UV Sphere Panel.....	36
Add Icosphere.....	36
Tool Settings.....	36
Depth.....	36
Position.....	36
Surface.....	37
3D Cursor Plane.....	37
3D Cursor View.....	37
Orientation.....	37
Snap To.....	37
Plane Axis.....	37
Auto Axis.....	37
Base.....	37
Origin.....	37
Aspect.....	37
Height.....	37
Origin.....	37
Aspect.....	37
Subdivisions.....	37

Last Operator Add Ico Sphere Panel.....37

Tool Shelf - Object Mode

In Object mode you will see mainly the general select and transform tools.

Those tools will also appear in other modes like Edit mode. We will not cover it again there.



Select Tools Group

Tools with a triangle down right are a group of tools. Click and hold to reveal the content. Then choose the tool that you need.

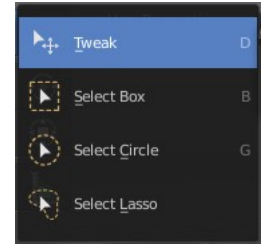

Tweak

Allows you to select or tweak single elements by clicking at it.

Note that Tweak is a transform tool, and therefore contains the same modal hotkeys with further functionality like the regular transform tools.

Select Box

Draws a box to select several elements at once. Click at the start point, then drag.

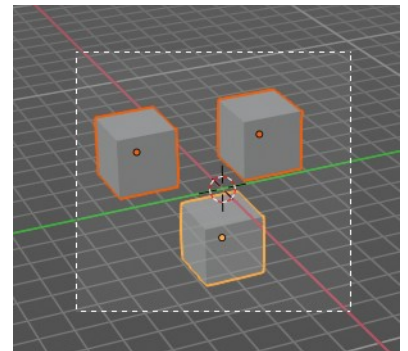

Tool Settings

Mode

The available selection modes. The mode titles are pretty self explaining. So i won't go into detail here.

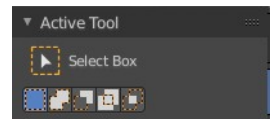

Set a new selection

Extend existing selection

Subtract existing selection

Inverts existing selection

Intersect existing selection

Select Circle

Draws a box to select several elements at once. Click at the start point, then drag.

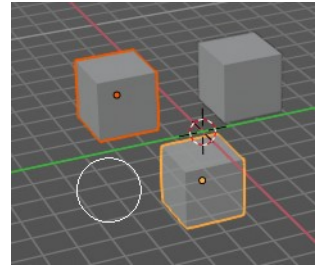

Tool Settings

Mode

The available selection modes. The mode titles are pretty self explaining. So i won't go into detail here.

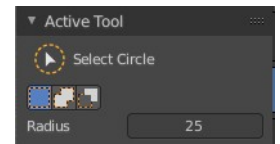

Set a new selection

Extend existing selection

Subtract existing selection

Radius

The brush radius.

Select Lasso

Draws a box to select several elements at once. Click at the start point, then drag.

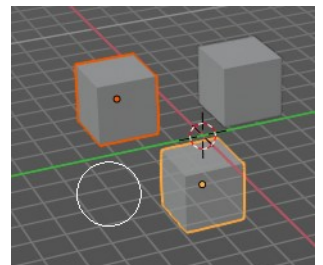

Tool Settings

Mode

The available selection modes. The mode titles are pretty self explaining. So i won't go into detail here.

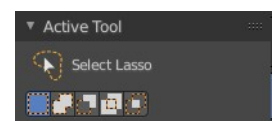

Set a new selection

Extend existing selection

Subtract existing selection

Inverts existing selection

Intersect existing selection

Cursor

The cursor tool allows you to move the 3d cursor around.



Tool Settings

Surface Project

Project the 3D cursor onto the surface.

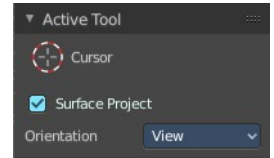

Orientation

The 3d cursor can have different orientations. The menu items should be self explaining.

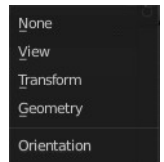

Move Rotate Scale Transform

The transformation tools.

Move

Activates the move tool. Activating the move tool also reveals a move widget at the object. This widget allows you to move the object around, by using the corresponding axis.



When you click at one of the square buttons at the icon, then you can move the object along the plane of the two adjacent axis. The rectangle buttons between the arrows allows you to move in direction of the blue and green arrows. This can also be done by clicking at the tip of the arrow and holding down shift. Then you can move the cube along the two other axis.

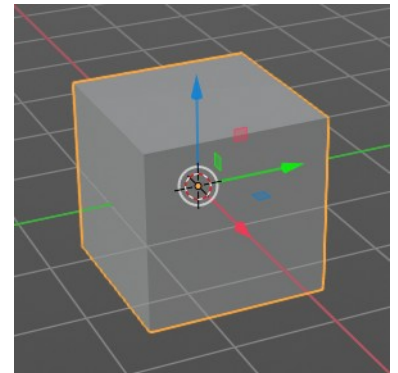

Snapping

Holding down Ctrl activates temporary global snapping.

Precision movement

When you hold down shift, then you will have a much slower but also much preciser movement.

Header Values

When you move your object then you will see some values in the header, which defines the current position of the object.

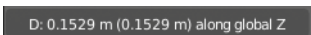

The value m stands for the default metric system. Meters. You can change the units in the Properties editor in the Scene properties in the Units panel. When you choose kilometers here then you will see a km instead m.

The value D stands for the distance of the current selected axis. This can also be two axis. Then you have two d values. The value in the brackets is then the direct distance to the starting point.

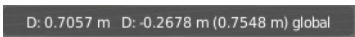

These values are always relative to the starting point. You always start with zero, regardless of the real world position.

Numerical Input

When you move the object, and hold down the mouse and type in a value, like 20, then the movement will be performed by the value that you have typed in. In this case by 20 units in direction of the selected axis.

Move without widget

You don't have to use the widget to move the object. You can also click aside of it, and drag the object around. The mouse turns into a move cursor. The standard behavior then is to move in screen space. When you want to move into a specific axis, then press X or Y or Z to limit the movement to this axis.

Limit Axis

When you want to rotate a specific axis, then press X or Y or Z to limit the rotation to this axis. You usually start in global orientation. But you can change this in the Orientation settings.

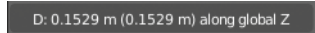

By holding down the mouse button and pressing the X, Y or Z key twice you can toggle this to local. But also to other orientations. This depends in what orientation you start. With normal you can toggle that way between Normal and global.

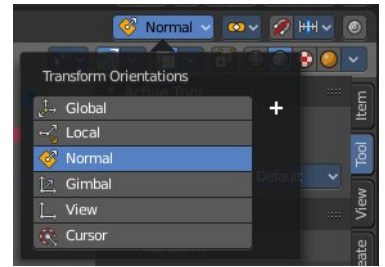

This can be combined with the numerical input. Type in X, type in X again to use the local space, type in 20 to move by 20 units in local orientation. Release the mouse to confirm.

Tool Settings

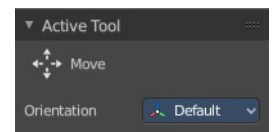

Orientation

The widget can have different orientations. The menu items should be self explaining.

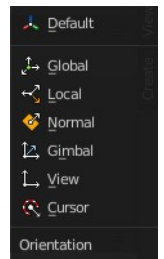

Last Operator Move

Move X, Y Z

The position. Attention, the actual world orientation and rotation does not matter here. It always starts with a value of zero, and moves relative to this zero then. For the actual location values have a look in the sidebar in the transform panel.

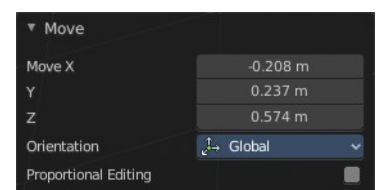

Orientation

The widget can have different orientations. The menu items should be self explaining.

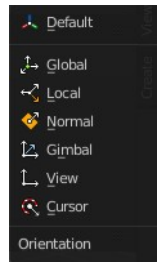

Proportional editing

Enables proportional editing. Activating proportional editing reveals further settings.

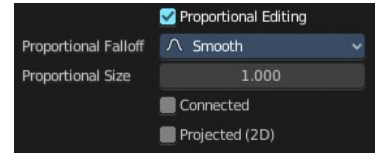

Proportional Falloff

Adjust the falloff methods.

Proportional Size

See and adjust the falloff radius.

Connected

The proportional falloff gets calculated for connected parts only.

Projected(2D)

The proportional falloff gets calculated in the screen space. Depth doesn't play a role. When it's in the radius, then it gets calculated.

Rotate

Activates the Rotate tool. Activating the move tool also reveals a rotate widget at the object. This widget allows you to rotate the object, by using the corresponding axis.

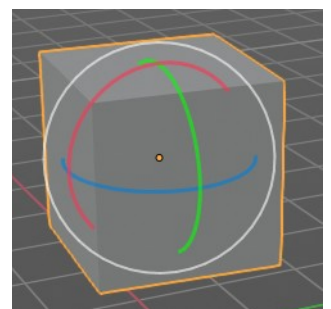

Snapping

Holding down Ctrl activates temporary global snapping. It snaps then by 5 degrees steps.

When you use the white circle to rotate, then the widget also shows a division circle around the widget. This divisions shows even finer when you do precision rotation.

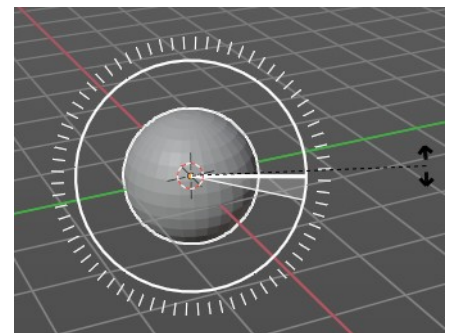

Precision rotation

When you hold down shift, then you will have a much slower but also much preciser rotation.

Header Values

When you rotate your object then you will see some values in the header, which defines the current rotation of the object. The rotation is shown in degrees.

Rot: -3.57 global

Numerical Input

When you rotate the object, and hold down the mouse and type in a value, like 20, then the rotation will be performed by the value that you have typed in. In this case by 20 degree around the selected axis.

Rotate without widget

You don't have to use the widget to rotate the object. You can also click asides and drag the object around. A black arrow will appear. The standard behavior then is to rotate in viewport orientation.

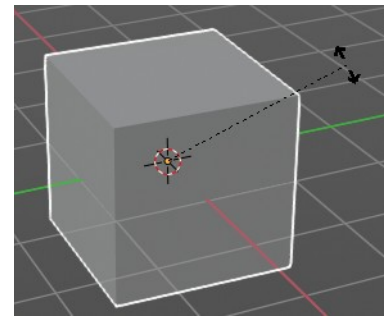

Limit Axis

When you want to rotate a specific axis, then press X or Y or Z to limit the rotation to this axis. You usually start in global orientation. But you can change this in the Orientation settings.

Rot: -0.08 along normal X

By holding down the mouse button and pressing the X, Y or Z key twice you can toggle this to local. But also to other orientations. This depends in what orientation you start. With normal you can toggle that way between Normal and Global.

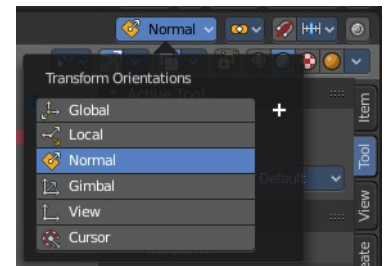

This can be combined with the numerical input. Type in X, type in X again to use the local space, type in 20 to rotate by 20 degree. Release the mouse to confirm.

Tool Settings

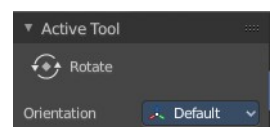

Orientation

The 3d cursor can have different orientations. The menu items should be self explaining.

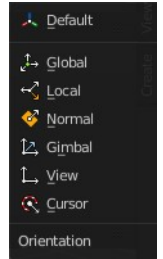

Last Operator Rotate

Angle

The rotation. Attention, the actual world orientation and rotation does not matter here. It always starts with a value of zero, and rotates relative to this zero then. For the actual rotation values have a look in the sidebar in the transform panel.

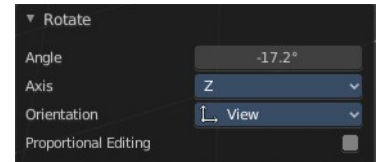

Axis

Which axis to rotate.

Orientation

The widget can have different orientations. The menu items should be self explaining.

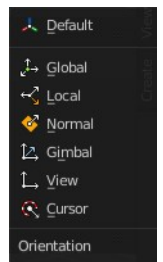

Proportional editing

Enables proportional editing. Activating proportional editing reveals further settings.

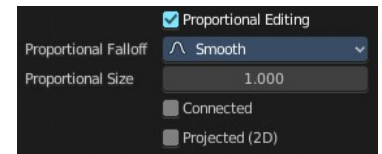

Proportional Falloff

Adjust the falloff methods.

Proportional Size

See and adjust the falloff radius.

Connected

The proportional falloff gets calculated for connected parts only.

Projected(2D)

The proportional falloff gets calculated in the screen space. Depth doesn't play a role. When it's in the radius, then it gets calculated.

Scale Tools Group

You can use two scale tools with different widget styles.

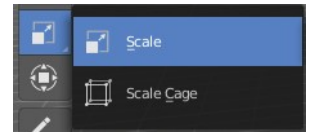

Scale

Activates the Scale tool. Activating the scale tool also reveals a traditional scale widget at the object. This widget allows you to scale the object, by using the corresponding axis. When you click at the outer white circle and drag, then you can scale the object uniformly.

The rectangle buttons between the arrows allows you to scale in direction of the adjacent arrows. This can also be done by clicking at the tip of the arrow and holding down shift. Then you can scale the cube along the two other axis.

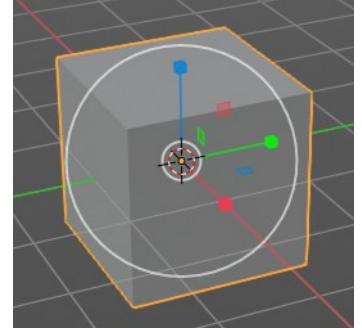

Snapping

Holding down Ctrl activates temporary global snapping.

Precision Scale

When you hold down shift, then you will have a much slower but also much preciser scale.

Header Values

When you scale your object then you will see some values in the header, which defines the current scale of the object.

Scale: 1.1996 global

These values are always relative to the starting point. You always start with 1, regardless of the real world scale.

Numerical Input

When you scale the object, and hold down the mouse and type in a value, like 20, then the scale will be performed by the value that you have typed in. In this case by factor 20 along the selected axis.

Scale without widget

You don't have to use the widget to scale the object. You can also click asides and drag the object around. A black arrow will appear. The standard behavior then is to scale uniformly. When you want to scale into a specific axis, then press X or Y or Z to limit the scale to this axis.

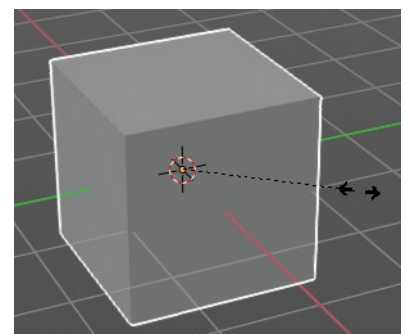

Limit Axis

When you want to rotate a specific axis, then press X or Y or Z to limit the scale to this axis. You usually start in global orientation. But you can change this in the Orientation settings.

Rot: -0.08 along normal X

By holding down the mouse button and pressing the X, Y or Z key twice you can toggle this to local. But also to other orientations. This depends in what orientation you start. With normal you can toggle that way between Normal and Global.

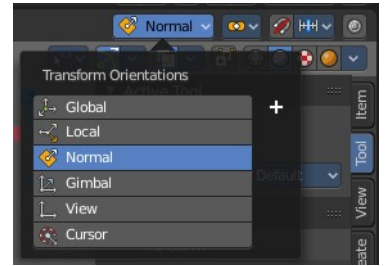

This can be combined with the numerical input. Hold down mouse, type in X, type in X again to use the local space, type in 20 to scale by 20 units. Release the mouse to confirm.

Tool Settings

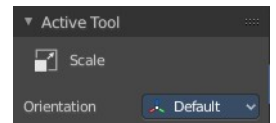

Orientation

The 3d cursor can have different orientations. The menu items should be self explaining.

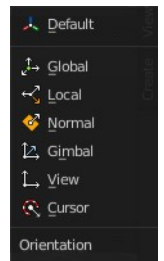

Last Operator Resize

Angle

The rotation. Attention, the actual world orientation and rotation does not matter here. It always starts with a value of zero, and rotates relative to this zero then. For the actual rotation values have a look in the sidebar in the transform panel.

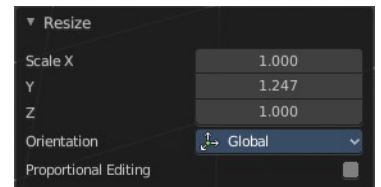

Axis

Which axis to rotate.

Orientation

The widget can have different orientations. The menu items should be self explaining.

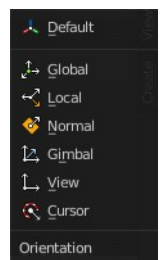

Proportional editing

Enables proportional editing. Activating proportional editing reveals further settings.

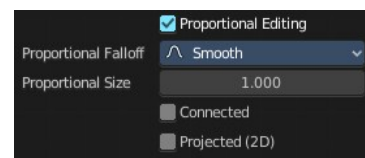

Proportional Falloff

Adjust the falloff methods.

Proportional Size

See and adjust the falloff radius.

Connected

The proportional falloff gets calculated for connected parts only.

Projected(2D)

The proportional falloff gets calculated in the screen space. Depth doesn't play a role. When it's in the radius, then it gets calculated.

Scale Cage

Activates the Scale tool. Activating the scale tool also reveals a scale widget in cage style at the object. This widget allows you to scale the object by clicking at the white handler points and drag them in the desired direction.

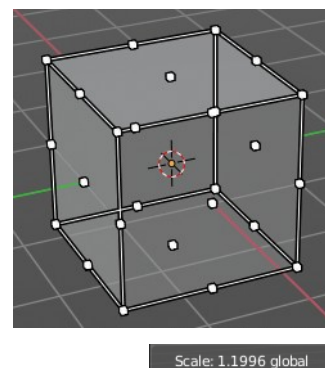

Snapping

Holding down Ctrl activates temporary global snapping.

Header Values

When you scale your object then you will see some values in the header, which defines the current scale of the object.

These values are always relative to the starting point. You always start with 1, regardless of the real world scale.

Scale without widget

You don't have to use the widget to scale the object. You can also click asides and drag the object around. A black arrow will appear. The standard behavior then is to scale uniformly. When you want to scale into a specific axis, then press X or Y or Z to limit the scale to this axis.

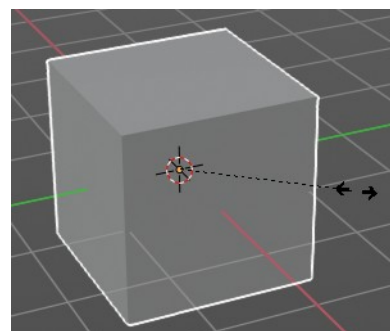

Limit Axis

When you want to rotate a specific axis, then press X or Y or Z to limit the rotation to this axis. You usually start in global orientation. But you can change this in the Orientation settings.

Scale: 1.1996 global

By holding down the mouse button and pressing the X, Y or Z key twice you can toggle this to local. But also to other orientations. This depends in what orientation you start. With normal you can toggle that way between Normal and Global.

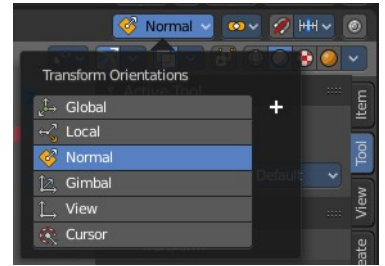

Tool Settings

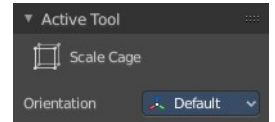

Orientation

The 3d cursor can have different orientations. The menu items should be self explaining.

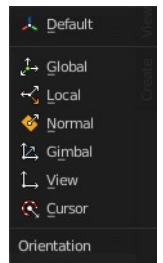

Last Operator Resize

Angle

The rotation. Attention, the actual world orientation and rotation does not matter here. It always starts with a value of zero, and rotates relative to this zero then. For the actual rotation values have a look in the sidebar in the transform panel.

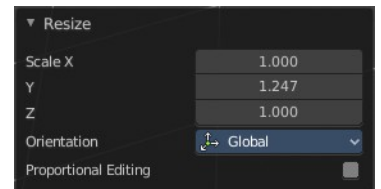

Axis

Which axis to rotate.

Orientation

The widget can have different orientations. The menu items should be self explaining.

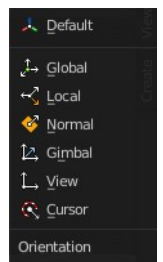

Proportional editing

Enables proportional editing. Activating proportional editing reveals further settings.

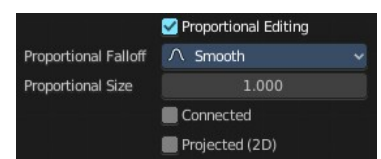

Proportional Falloff

Adjust the falloff methods.

Proportional Size

See and adjust the falloff radius.

Connected

The proportional falloff gets calculated for connected parts only.

Projected(2D)

The proportional falloff gets calculated in the screen space. Depth doesn't play a role. When it's in the radius, then it gets calculated.

Transform

Transform reveals a multi transform widget with all three transform methods available at once. Move, Rotate and Scale.

The rules are the same than for the single tools, and also the last operators. Dependent of which widget part you pull here. So i won't go into detail again here.

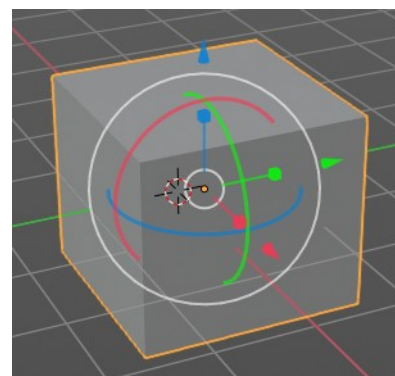

Tool Settings

Drag Action

Define what kind of transform should happen when you click not at the widget but besides, and drag the mouse.

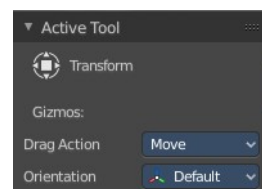

Orientation

The 3d cursor can have different orientations. The menu items should be self explaining.

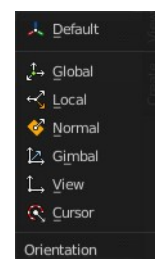

Modal Operators for the Transform tools

Every transform tool has a sub set of modal operators that extends the functionality. These modal operators are shown at the bottom in the info bar. Usually they are self explaining. But the transform tools contains a few tools that needs further explanation.

Note that these hotkeys are hardcoded, and cannot be changed in the keymap manager.

To use these tools you must start the transform operation by moving and holding the mouse. Then press one of the hotkeys to perform this operator.

General transform modal tools



Confirm

Left Mouse button confirms the tool.

Cancel

Right mouse button cancels the operation

X Axis

Constraint the transformation to the X axis.

Y Axis

Constraint the transformation to the Y axis.

Z Axis

Constraint the transformation to the Z axis.

X Plane

Constraint the transformation to the X plane. You can transform in Y Z direction.

Y Plane

Constraint the transformation to the Y plane. You can transform in X Z direction.

Z Plane

Constraint the transformation to the Z plane. You can transform in Y Z direction.

Set Snap Base

Usually the snap base is the center of the object. This tool allows you to move the snap base to another point. The corner of another mesh for example.

Hold down B and move the mouse to the location that you want to be the snap base. The new snap base will be displayed as an orange circle.

Pressing b again while in transformation will now snap the object to this new snap base.

Note that you cannot place this tool freely, it needs geometry to snap to.

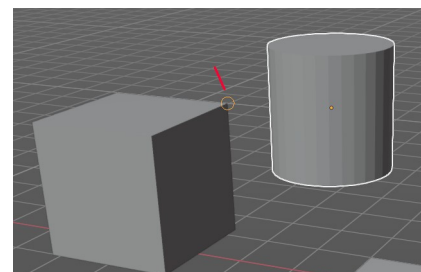

Snap Invert

Snap in incremental steps.

Snap Toggle

Ctrl + Tab toggles to snap in incremental steps.

Automatic Constraints

Displays all the three axis and allows you to snap to one of it to constraint the operation to this axis then.

Automatic Constraints Plane

Same as with Automatic Constraints, but this time you can snap to a plane to constraint the operation to this plane then.

Precision Mode

Activates the precision mode to allow much more accurate transform operations.

Move tool in Object mode

Rotate

Rotate around the chosen axis instead of moving the selection. When you didn't use one of the widget arrows then it rotates towards the mouse.

Resize

Resize along the chosen axis instead of moving the selection. When you didn't use one of the widget arrows then it scales towards the mouse.

Move Tool in Edit mode

Vert/Edge Slide

Edit Mode with the move tool. Slide the selected edges or vertices along their corner or face.

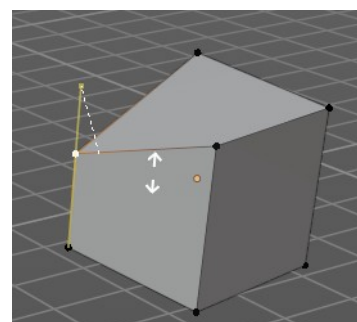

Rotate

Rotate the selection around the chosen axis instead of moving the selection. When you didn't use one of the widget arrows then it rotates towards the mouse.

Resize

Resize the selection along the chosen axis instead of moving the selection. When you didn't use one of the widget arrows then it scales towards the mouse.

Rotate Tool in Object mode

Move

Move around the chosen axis instead of rotating the selection. When you didn't use one of the widget arrows then it moves towards the mouse.

Trackball

Use trackball rotation.

Resize

Resize along the chosen axis instead of moving the selection. When you didn't use one of the widget arrows then it scales towards the mouse.

Rotate Tool in Edit mode

Move

Move the selection around the chosen axis instead of rotating the selection. When you didn't use one of the widget arrows then it moves towards the mouse.

Trackball

Use trackball rotation.

Resize

Resize the selection along the chosen axis instead of moving the selection. When you didn't use one of the widget arrows then it scales towards the mouse.

Rotate Normals

Rotates the normals instead of the selection. Note that it might be a good idea to turn on display normals in the overlays.

Scale Tool in Object mode and Edit Mode

Move

Move around the chosen axis instead of scaling the selection. When you didn't use one of the widget arrows then it moves towards the mouse.

Rotate

Rotate around the chosen axis instead of scaling the selection. When you didn't use one of the widget arrows then it rotates towards the mouse.

Annotate Tools group

The annotation tool is available in multiple editors. With this tool you can write notes at the screen. The annotate tools is the little brother of the grease pencil objects.

Further settings for annotate can be found in the sidebar. Here you can also remove an annotation when you don't longer need it. And here you can also adjust the size of the stroke.

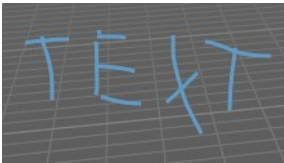
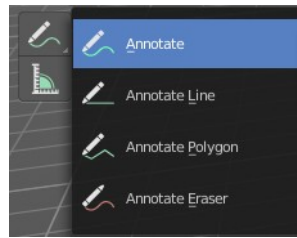

Annotate tool

Draw free-hand strokes in the main window.

Tool Settings

The tool settings for the Annotate tool.



Color

Clicking at the left color field reveals a color picker. Define the color for the annotation stroke.



Note

Clicking at the Note drop down box reveals a panel with further settings. It's the same content than in the annotations in the View tab.

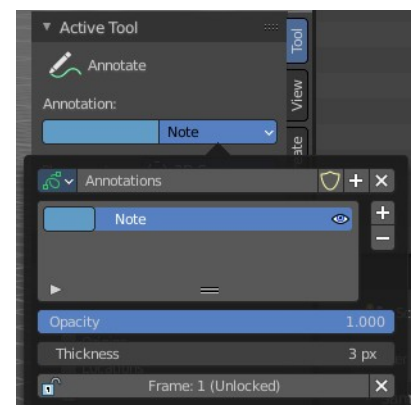

Annotations list

Add, remove and rename new annotations.

Edit Box

The name of the current annotation. You can rename the annotation to your needs here.

Fake User

Assign a fake user to this annotation. Fake users is an odd concept to keep data in the scene even if it has no user somewhere. The fake user is then a dummy user so that the object is not deleted when saving the scene.

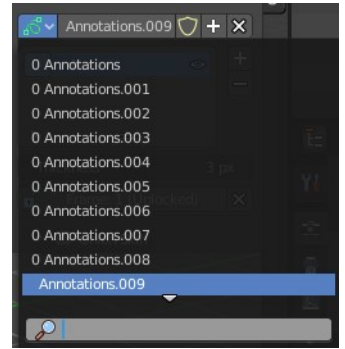

Add Annotation

Add a new annotation.

Remove Annotation

Delete the annotation.

Active Layer Index

The list of annotation layers.

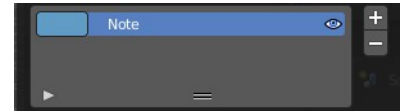

Add Annotation Layer

Add a new annotation layer.

Remove Annotation Layer

Remove the selected annotation layer.

Opacity

The opacity of the stroke.

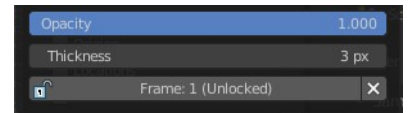

Thickness

The thickness of the annotation stroke.

Frame Locked/Unlocked

Lock frame displayed by current layer. This toggles whether the active layer is the only one that can be edited.

Delete Active Frame

Deletes the active frame from the active grease pencil layer.

Placement

Define how annotation strokes are aligned in the 3d space.

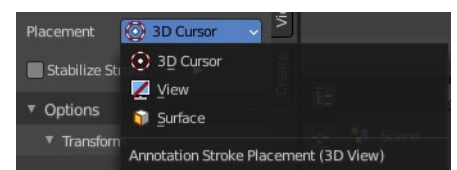

Stabilize Stroke

Helper to draw smooth and clean lines. Pressing shift inverts the effect.

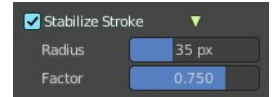

Radius

The radius for the stroke stabilization.

Factor

Stabilizer stroke factor. Higher values gives a smoother stroke.

Drag

Define what kind of transform should happen when you click not at the widget but besides, and drag the mouse.

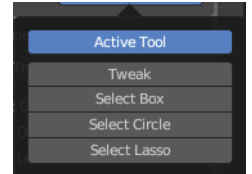

Annotate Line

Click and drag to create a line.

Tool Settings

The tool settings for the Annotate tool.

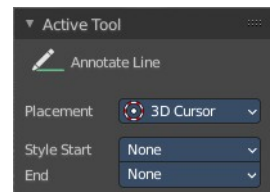

Placement

Define how annotation strokes are aligned in the 3d space.

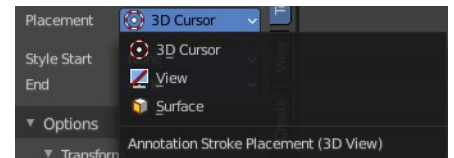

Style Start

The stroke start style. With an arrow for example you place an arrow at the start of the stroke.

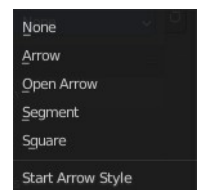

End

The stroke end style. With an arrow for example you place an arrow at the end of the stroke.

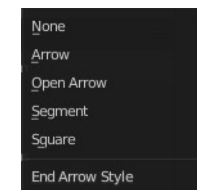

Annotate Polygon

Click multiple times to create multiple connected lines. The current polygon is finished when Esc or RMB is pressed.

Tool Settings

The tool settings for AnnotatePolygon.

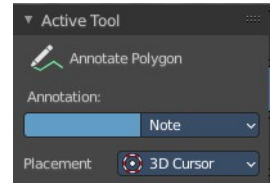

Color

Clicking at the left color field reveals a color picker. Define the color for the annotation stroke.



Note

Clicking at the Note drop down box reveals a panel with further settings. It's the same content than in the annotations in the View tab.

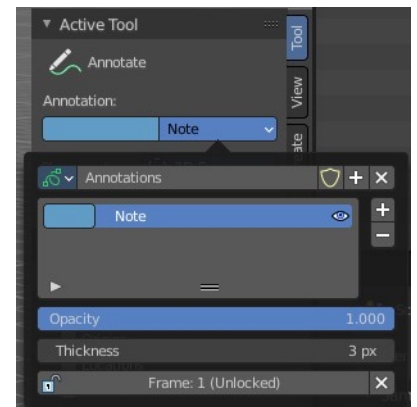

Annotations list

Add, remove and rename new annotations.

Edit Box

The name of the current annotation. You can rename the annotation to your needs here.

Fake User

Assign a fake user to this annotation. Fake users is an odd concept to keep data in the scene even if it has no user somewhere. The fake user is then a dummy user so that the object is not deleted when saving the scene.

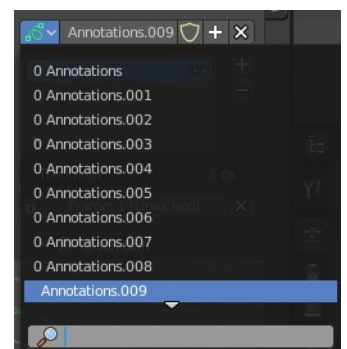

Add Annotation

Add a new annotation.

Remove Annotation

Delete the annotation.

Active Layer Index

The list of annotation layers.



Add Annotation Layer

Add a new annotation layer.

Remove Annotation Layer

Remove the selected annotation layer.

Opacity

The opacity of the stroke.

Thickness

The thickness of the annotation stroke.

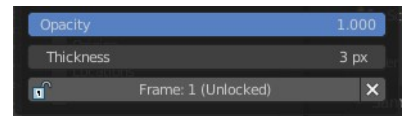

Frame Locked/Unlocked

Lock frame displayed by current layer. This toggles whether the active layer is the only one that can be edited.

Delete Active Frame

Deletes the active frame from the active grease pencil layer.

Placement

Define how annotation strokes are aligned in the 3d space.

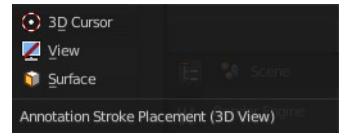

Annotate Eraser

Click and drag to remove annotate lines.

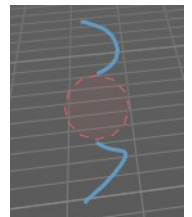

Tool Settings

Radius

The radius of the eraser pencil.

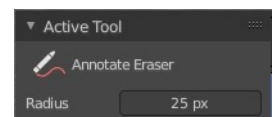

Measure

Measure allows you to draw measure lines into the view.

The measure tool has a few options, which are described in the tool tip.

New measure lines gets created by left clicking and dragging.

When you change the tool then the measure lines becomes visible. But they are not removed. When you activate the measure tool then they reappear.

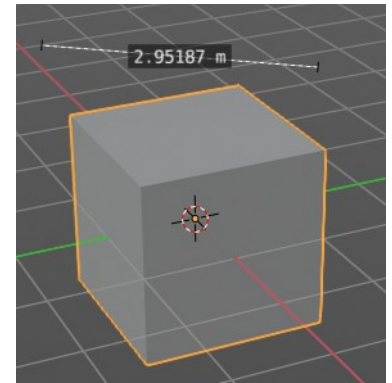
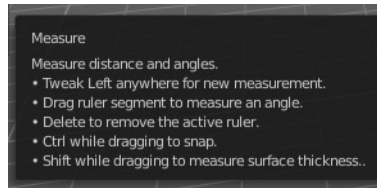

Restrict to global axis

You can constraint the measure tool to a single global axis by pressing the corresponding X Y or Z key once while holding down the mouse.

To escape this constraint, press the axis key twice again.

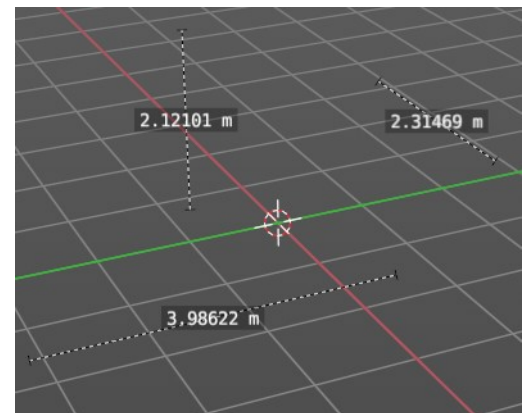

Measuring angles

When you want to measure an angle, first create a straight measure line. Then grab it in the middle to drag out a new point at the line. Then align everything proper.

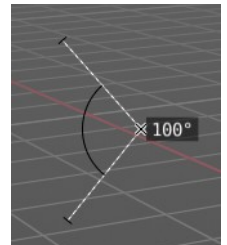

Snapping

Holding down Ctrl activates temporary global snapping.

Delete measure lines

Select them and press delete. When you have selected an angle point then first this angle point gets deleted. You need to have to select an endpoint to make the whole stroke active.

Primitives Add tools group

This tools appears in object and edit mode with the correct object types. The tools allows you to create primitives by dragging with the mouse. First you create a ground plane by dragging a rectangle. Then you release the mouse and drag the mouse upwards to create the third dimension of it. And a left click makes the object real then.

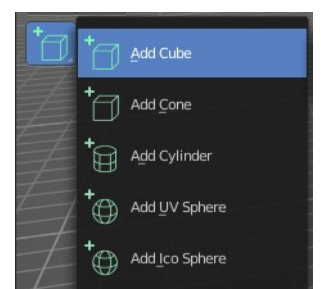

You can choose between five primitive types. Cube, Cone, Cylinder, UV Sphere and Icosphere.

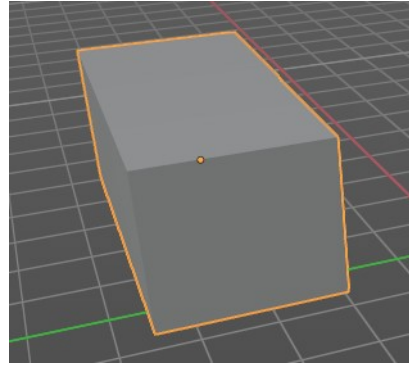
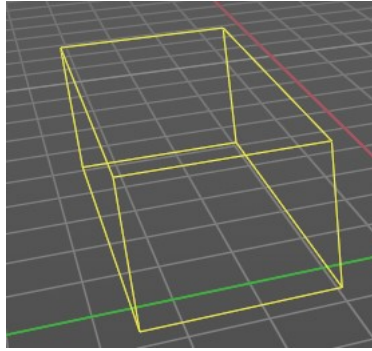
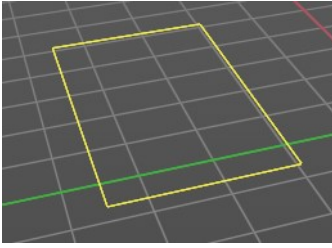

By default the ground plane starts to scale from one of the edges.

Holding down ALT key while dragging scales from the center instead of the default corner.

Holding down Shift key while dragging allows you to scale uniformly.

Holding down CTRL while dragging snaps to other objects.

Add Cube

Adds a cube primitive.

Tool Settings

Depth

Position

How to position the primitive.

Surface

Start placing on the surface. The 3d cursor acts as a fallback.

3D Cursor Plane

Start placement using a point that is projected at the selected axis at the 3d cursor position

3D Cursor View

Start placement using the mouse cursor projected onto the view plane.

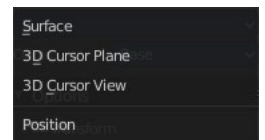
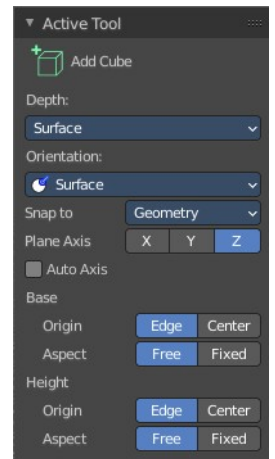

Orientation

In which orientation the new object to create.

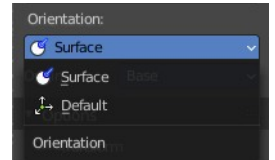

Snap To

The target for snapping. Geometry snaps to existing mesh geometry. Default snaps to the ground.

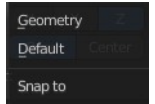

Plane Axis

What plane axis to use.



Auto Axis

Select the closest axis when placing objects. Surface overrides.

Base

Origin

From where to scale the primitive. From one of its corners or from the center.

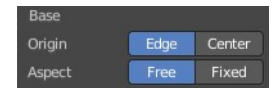

Aspect

Scale uniformly or in drag direction.

Height

Origin

From where to scale the primitive. From one of its corners or from the center.

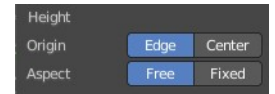

Aspect

Scale uniformly or in drag direction.

Last Operator Add Cube Panel

Size is in real the size of the Cube.

Generate UV's creates UV's for this primitive.

Align to view aligns the geometry to the chosen view. World, View or 3D cursor.

Location defines the location of the Cube.

Rotation defines the rotation of the Cube.

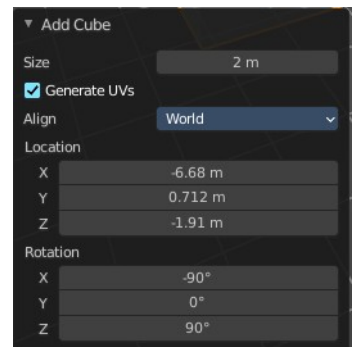

Add Cone

Adds a cone primitive.

Tool Settings

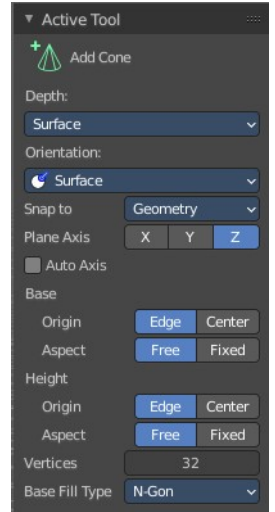

Depth

Position

How to position the primitive.

Surface

Start placing on the surface. The 3d cursor acts as a fallback.

3D Cursor Plane

Start placement using a point that is projected at the selected axis at the 3d cursor position

3D Cursor View

Start placement using the mouse cursor projected onto the view plane.

Orientation

In which orientation the new object to create.

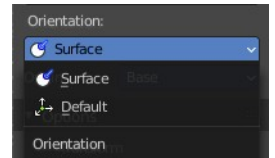
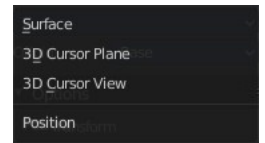

Snap To

The target for snapping. Geometry snaps to existing mesh geometry. Default snaps to the ground.

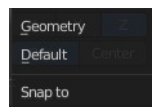

Plane Axis

What plane axis to use.



Auto Axis

Select the closest axis when placing objects. Surface overrides.

Base

Origin

From where to scale the primitive. From one of its corners or from the center.

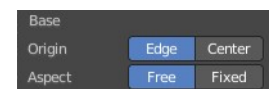

Aspect

Scale uniformly or in drag direction.

Height

Origin

From where to scale the primitive. From one of its corners or from the center.

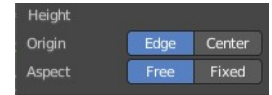

Aspect

Scale uniformly or in drag direction.

Vertices

The number of vertices for the cone ground plane.

Base Fill Type

Defines how the Base face is filled.

Nothing means you have no base face.

N-Gon means that the base face is an N-Gon face.

Triangle Fan means that the base face is triangulated.



Last Operator Add Cone Panel

Vertices defines of how much vertices the circle is made.

Radius 1 defines the base radius of the Cone.

Radius 2 defines the top radius of the Cone.

Depth defines the length of the Cone.

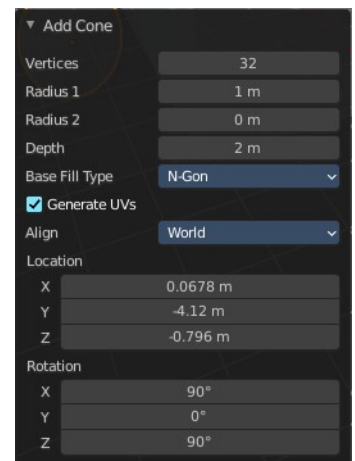

Base Fill Type defines how the Base face is filled.

- Nothing means you have no base face.
- N-Gon means that the base face is an N-Gon face.
- Triangle Fan means that the base face is triangulated.

Generate UV's creates UV's for this primitive.

Align to view aligns the geometry to the chosen view. World, View or 3D cursor.

Location defines the location of the Cone.

Rotation defines the rotation of the Cone.

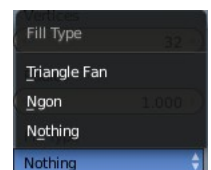

Add Cylinder

Adds a cylinder primitive.

Tool Settings

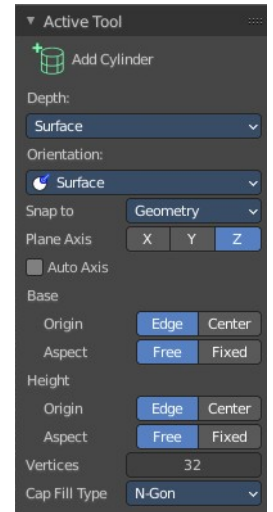

Depth

Position

How to position the primitive.

Surface

Start placing on the surface. The 3d cursor acts as a fallback.

3D Cursor Plane

Start placement using a point that is projected at the selected axis at the 3d cursor position

3D Cursor View

Start placement using the mouse cursor projected onto the view plane.

Orientation

In which orientation the new object to create.

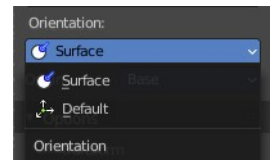
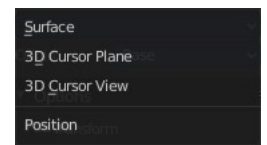

Snap To

The target for snapping. Geometry snaps to existing mesh geometry. Default snaps to the ground.

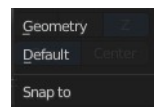

Plane Axis

What plane axis to use.



Auto Axis

Select the closest axis when placing objects. Surface overrides.

Base

Origin

From where to scale the primitive. From one of its corners or from the center.



Aspect

Scale uniformly or in drag direction.

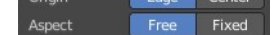

Height

Origin

From where to scale the primitive. From one of its corners or from the center.

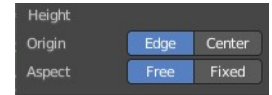

Aspect

Scale uniformly or in drag direction.

Vertices

The number of vertices.

Cap Fill Type defines how the cap face is filled.

- Nothing means you have no face at the top and the bottom of the Cylinder.
- N-Gon means that the cap face is an N-Gon face.
- Triangle Fan means that the cap face is triangulated.

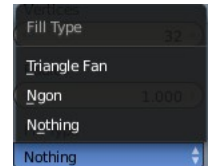

Last Operator Add Circle Panel

Vertices defines of how much vertices the circle is made.

Radius defines the radius of the Cylinder.

Depth defines the length of the Cylinder.

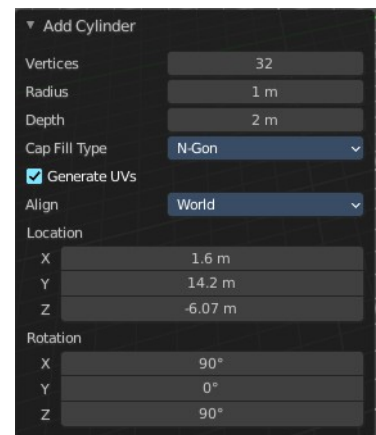

Cap Fill Type defines how the cap face is filled.

- Nothing means you have no face at the top and the bottom of the Cylinder.
- N-Gon means that the cap face is an N-Gon face.
- Triangle Fan means that the cap face is triangulated.

Generate UV's creates UV's for this primitive.

Align to view aligns the geometry to the chosen view. World, View or 3D cursor.

Location defines the location of the Cylinder.

Rotation defines the rotation of the Cylinder.

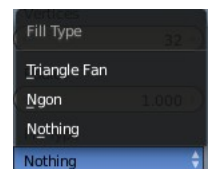

Add UV Sphere

Adds a UV sphere primitive.

Tool Settings

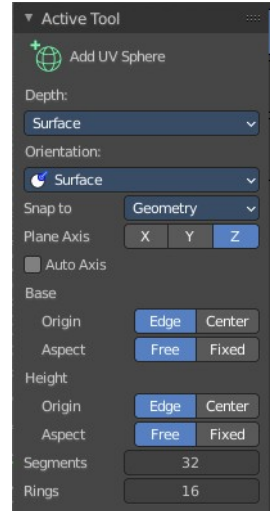

Depth

Position

How to position the primitive.

Surface

Start placing on the surface. The 3d cursor acts as a fallback.

3D Cursor Plane

Start placement using a point that is projected at the selected axis at the 3d cursor position

3D Cursor View

Start placement using the mouse cursor projected onto the view plane.

Orientation

In which orientation the new object to create.

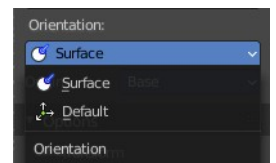
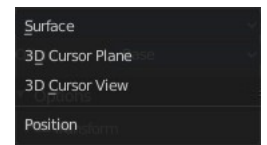

Snap To

The target for snapping. Geometry snaps to existing mesh geometry. Default snaps to the ground.

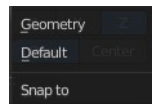

Plane Axis

What plane axis to use.



Auto Axis

Select the closest axis when placing objects. Surface overrides.

Base

Origin

From where to scale the primitive. From one of its corners or from the center.



Aspect

Scale uniformly or in drag direction.

Height

Origin

From where to scale the primitive. From one of its corners or from the center.

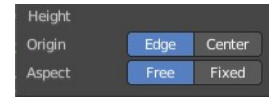

Aspect

Scale uniformly or in drag direction.

Segments

Defines of how much segments the sphere has vertically.

Rings

Defines how much rings the sphere has horizontally.

Last Operator Add UV Sphere Panel

Segments defines of how much segments the sphere has vertically.

Rings defines how much rings the sphere has horizontally.

Size defines the radius of the UV Sphere.

Generate UV's creates UV's for this primitive.

Align to view aligns the geometry to the chosen view. World, View or 3D cursor.

Location defines the location of the Sphere.

Rotation defines the rotation of the Sphere.

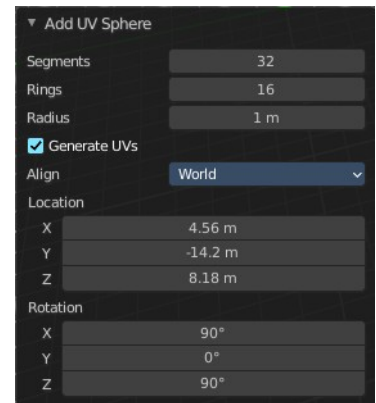

Add Icosphere

Adds an icosphere primitive.

Tool Settings

Depth

Position

How to position the primitive.

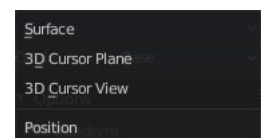
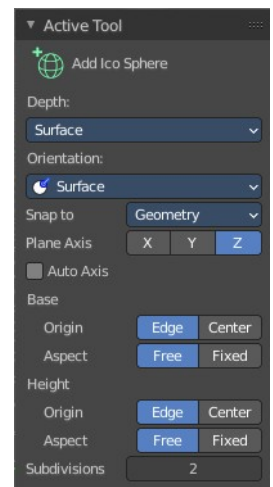

Surface

Start placing on the surface. The 3d cursor acts as a fallback.

3D Cursor Plane

Start placement using a point that is projected at the selected axis at the 3d cursor position

3D Cursor View

Start placement using the mouse cursor projected onto the view plane.

Orientation

In which orientation the new object to create.

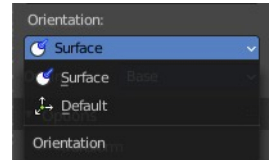

Snap To

The target for snapping. Geometry snaps to existing mesh geometry. Default snaps to the ground.

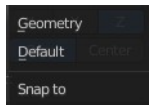

Plane Axis

What plane axis to use.



Auto Axis

Select the closest axis when placing objects. Surface overrides.

Base

Origin

From where to scale the primitive. From one of its corners or from the center.

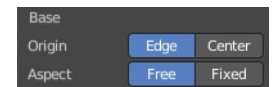

Aspect

Scale uniformly or in drag direction.

Height

Origin

From where to scale the primitive. From one of its corners or from the center.

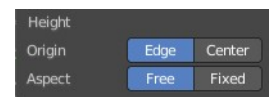

Aspect

Scale uniformly or in drag direction.

Subdivisions

The subdivision level of the Ico Sphere.

Last Operator Add Ico Sphere Panel

Subdivisions defines the subdivision level of the Ico Sphere.

Size defines the radius of the Ico Sphere.

Generate UV's creates UV's for this primitive.

Align to view aligns the geometry to the chosen view. World, View or 3D cursor.

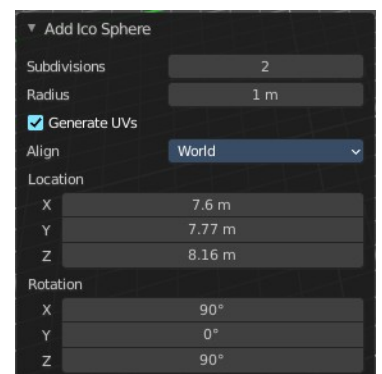

Location defines the location of the Sphere.

Rotation defines the rotation of the Sphere.

7.2.10 Editors - 3D Viewport - Tool Shelf - Metaball - Edit Mode

Table of content

Tool Shelf - Metaball - Edit Mode.....	1
Tweak, Select, 3D Cursor, Transform, Measure and Annotate tools.....	1
Shear.....	1
Tool Settings.....	1
Orientation.....	2
Drag.....	2
Active Tool.....	2
Tweak, Select Box, Circle and Lasso.....	2
Last Operator Shear.....	2
Offset.....	2
Axis.....	2
Axis Ortho.....	2
Orientation.....	2
Proportional editing.....	2
Proportional Falloff.....	2
Proportional Size.....	2
Connected.....	3
Projected(2D).....	3

Tool Shelf - Metaball - Edit Mode

Tweak, Select, 3D Cursor, Transform, Measure and Annotate tools

The Tweak, Select, 3D Cursor, Transform, Measure and Annotate tools at the end of the list are explained in the chapter 7.1.1 Editors - 3D View - Tool Shelf - Object Mode. We won't cover this tools again here.



Shear

The shear tool allows you to shear the selected geometry. When you activate the tool, then a widget appears that allows you to pull in the desired direction.

The shear happens between the meta elements. This means you need more than one. And you need to select the meta elements first!

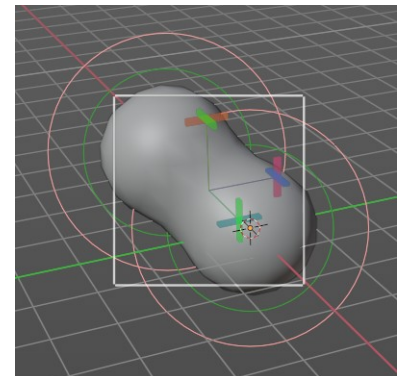

Tool Settings

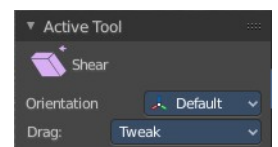

Orientation

Choose the orientation for the shear action.

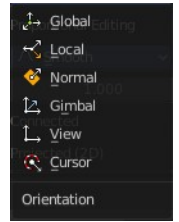

Drag

When you click at the widget of the active tool, then you perform the tool action. Adjust what should happen when you click outside of the widget, in the empty area.

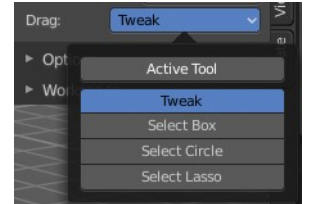

Active Tool

When you click off the widget then the click still does the same than clicking at the widget. It performs the active tool.

Tweak, Select Box, Circle and Lasso

When you choose this options then you will set the off click to the different select methods. Whereas tweak works more than a move tool then. Tweak is the default.

Last Operator Shear

Offset

Adjust an offset.

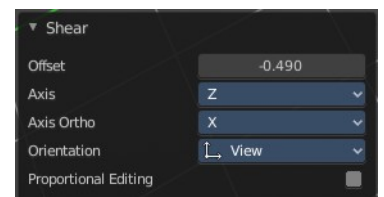

Axis

Defines one axis of the imaginary shear axis plane.

Axis Ortho

Defines the other axis of the imaginary shear axis plane.

Orientation

Choose the orientation for the shear action.

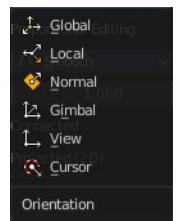

Proportional editing

Enables proportional editing. Activating proportional editing reveals further settings.

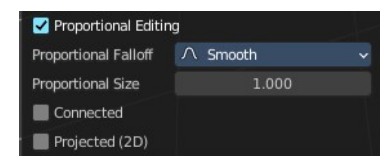

Proportional Falloff

Adjust the falloff methods.

Proportional Size

See and adjust the falloff radius.

Connected

The proportional falloff gets calculated for connected parts only.

Projected(2D)

The proportional falloff gets calculated in the screen space. Depth doesn't play a role. When it's in the radius, then it gets calculated.



7.2.11 Editors - 3D Viewport - Tool Shelf - Text - Edit Mode

Table of content

Tool Shelf - Text - Edit Mode.....	1
3D Cursor, Measure and Annotate tools.....	1

Tool Shelf - Text - Edit Mode

The tool shelf does not have any tools in the tool shelf yet for the Metaball object.

Note that the Tweak tool does nothing here. But it is a good default to avoid placing accidentally the 3D cursor around.



3D Cursor, Measure and Annotate tools

The 3D Cursor, Measure and annotate tools at the end of the list are explained in the chapter 7.1.1 Editors - 3D View - Tool Shelf - Object Mode. We won't cover this tools again here.

7.2.12 Editors - 3D Viewport - Tool Shelf - Grease Pencil - Edit Mode

Table of content

Tool Shelf - Grease Pencil - Edit Mode.....	3
Tweak, Select, Transform, 3D Cursor Measure and Annotate tools.....	3
Extrude.....	3
Snapping.....	3
Precision movement.....	3
Header Values.....	3
Move without Widget.....	3
Limit Axis.....	4
Tool Settings.....	4
Axis Type.....	4
Drag.....	4
Active Tool.....	4
Tweak, Select Box, Circle and Lasso.....	4
Last Operator Extrude Stroke Points.....	4
Move X, Y Z.....	4
Orientation.....	5
Proportional editing.....	5
Proportional Falloff.....	5
Proportional Size.....	5
Connected.....	5
Projected(2D).....	5
Radius.....	5
Snapping.....	5
Precision movement.....	5
Header Values.....	5
Last Operator Transform.....	5
Transform X, Y Z.....	5
Axis.....	6
Orientation.....	6
Proportional editing.....	6
Proportional Falloff.....	6
Proportional Size.....	6
Connected.....	6
Projected(2D).....	6
Bend.....	6
Snapping.....	6
Precision movement.....	6
Header Values.....	6
Shear / To Sphere Tools group.....	7
Shear.....	7
Snapping.....	7
Precision movement.....	7
Header Values.....	7
Hotkeys.....	7
Last Operator Shear.....	7

Offset.....	7
Axis.....	7
Axis Ortho.....	7
Orientation.....	7
Proportional editing.....	7
Proportional Falloff.....	7
Proportional Size.....	7
Connected.....	8
Projected(2D).....	8
To Sphere.....	8
Snapping.....	8
Precision movement.....	8
Header Values.....	8
Last Operator To Sphere.....	8
Offset.....	8
Proportional editing.....	8
Proportional Falloff.....	8
Proportional Size.....	8
Connected.....	8
Projected(2D).....	8
Transform Fill.....	9
Tool Settings.....	9
Last Operator Transform Stroke Fill.....	9
Mode.....	9

Tool Shelf - Grease Pencil - Edit Mode

Here you can find tools to edit the curve geometry of the grease pencil strokes.

Tweak, Select, Transform, 3D Cursor Measure and Annotate tools

The tweak, select, transform, 3d cursor, measure and annotate tools at the end of the list are explained in the chapter 7.1.1 Editors - 3D View - Tool Shelf - Object Mode. We won't cover this tools again here.



Extrude

Extrude out selected curve points.

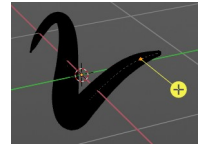

Snapping

Holding down Ctrl activates temporary global snapping.

Precision movement

When you hold down shift, then you will have a much slower but also much preciser movement.

Header Values

When you move the mouse then you will see some values in the header, which defines the current position of the object.

D: 0.04303 m (0.04303 m) global

The value m stands for the default metric system. Meters. You can change the units in the Properties editor in the Scene properties in the Units panel. When you choose kilometers here then you will see a km instead m.

The value D stands for the distance of the current selected axis. This can also be two axis. Then you have two d values. The value in the brackets is then the direct distance to the starting point.

These values are always relative to the starting point. You always start with zero, regardless of the real world position.

Move without Widget

You don't have to use the widget to move the object. You can also click aside of it, and drag the object around. The mouse turns into a move cursor. The standard behavior then is to move in screen space. When you want to move into a specific axis, then press X or Y or Z to limit the movement to this axis.

Limit Axis

When you want to move along a specific axis, then press X or Y or Z to limit the movement to this axis. You usually start in global orientation. But you can change this in the Orientation settings.

D: 0.1529 m (0.1529 m) along global Z

By holding down the mouse button and pressing the X, Y or Z key twice you can toggle this to local. But also to other orientations. This depends in what orientation you start. With normal you can toggle that way between Normal and Global.

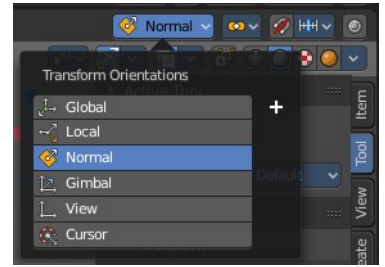

Tool Settings

Axis Type

You can choose between the regular axis type. That's the yellow widget with just one handler. It always points in the direction of the middled normals of the selection.

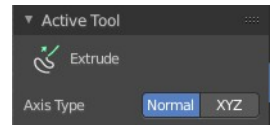

Or you can use the XYZ axis type. That's a handler with three axis. This widget can be aligned with the transform orientation methods.

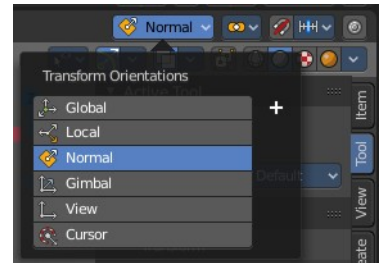
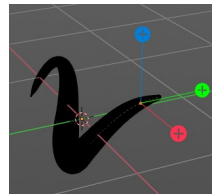

Drag

When you click at the widget of the active tool, then you perform the tool action. Adjust what should happen when you click outside of the widget, in the empty area.

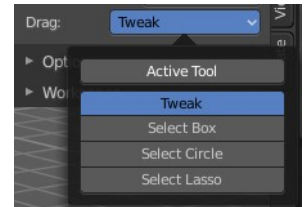

Active Tool

When you click off the widget then the click still does the same than clicking at the widget. It performs the active tool.

Tweak, Select Box, Circle and Lasso

When you choose this options then you will set the off click to the different select methods. Whereas tweak works more than a move tool then. Tweak is the default.

Last Operator Extrude Stroke Points

Move X, Y Z

The position. Attention, the actual world orientation and rotation does not matter here. It always starts with a value of zero, and moves relative to this zero then. For the actual location values have a look in the sidebar in the transform panel.

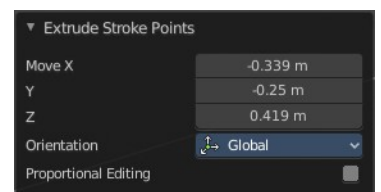

Orientation

The widget can have different orientations. The menu items should be self explaining.

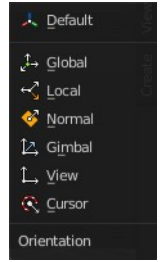

Proportional editing

Enables proportional editing. Activating proportional editing reveals further settings.

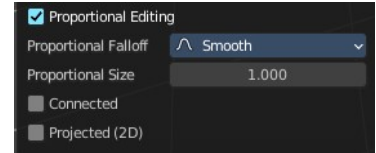

Proportional Falloff

Adjust the falloff methods.

Proportional Size

See and adjust the falloff radius.

Connected

The proportional falloff gets calculated for connected parts only.

Projected(2D)

The proportional falloff gets calculated in the screen space. Depth doesn't play a role. When it's in the radius, then it gets calculated.

Radius

Increases the thickness of the stroke for the selected curve points.

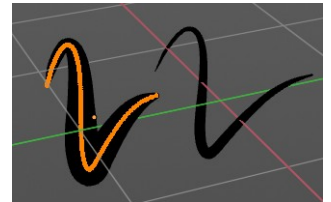

Snapping

Holding down Ctrl activates temporary global snapping.

Precision movement

When you hold down shift, then you will have a much slower but also much preciser movement.

Header Values

When you move the mouse then you will see some values in the header, which shows the current scale factor. This value is relative to the starting value, which always starts with 1.

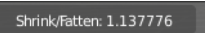

Last Operator Transform

Transform X, Y Z

The scale factor. Actually just the Value X does really matter. The other values have no effect.

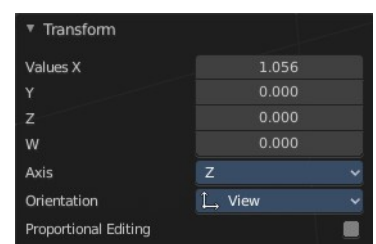

Axis

Define an axis to scale. But this setting has no effect.

Orientation

The widget can have different orientations. The menu items should be self explaining.

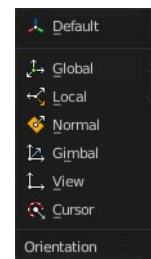

Proportional editing

Enables proportional editing. Activating proportional editing reveals further settings.

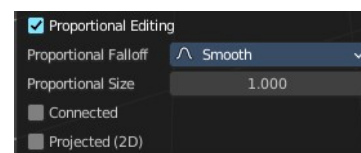

Proportional Falloff

Adjust the falloff methods.

Proportional Size

See and adjust the falloff radius.

Connected

The proportional falloff gets calculated for connected parts only.

Projected(2D)

The proportional falloff gets calculated in the screen space. Depth doesn't play a role. When it's in the radius, then it gets calculated.

Bend

Bends the selection.

Snapping

Holding down Ctrl activates temporary global snapping.

Precision movement

When you hold down shift, then you will have a much slower but also much preciser movement.

Header Values

When you move the mouse then you will see some values in the header, which shows the current scale factor. This value is relative to the starting value, which always starts with 1.



Shear / To Sphere Tools group

Shear

Snapping

Holding down Ctrl activates temporary global snapping.

Precision movement

When you hold down shift, then you will have a much slower but also much preciser movement.

Header Values

When you move the mouse then you will see some values in the header, which shows the current scale factor. This value is relative to the starting value, which always starts with 1.

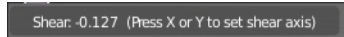

Hotkeys

As shown in the header, you can press X or Y to set the shear axis.

Last Operator Shear

Offset

The shear offset. This value always starts at zero.

Axis

Define the first axis for the shear transformation.

Axis Ortho

Define the second axis for the shear transformation

Orientation

The widget can have different orientations. The menu items should be self explaining.

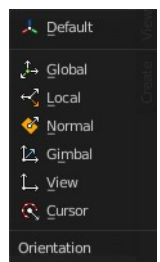
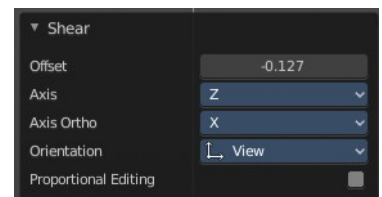

Proportional editing

Enables proportional editing. Activating proportional editing reveals further settings.

Proportional Falloff

Adjust the falloff methods.

Proportional Size

See and adjust the falloff radius.

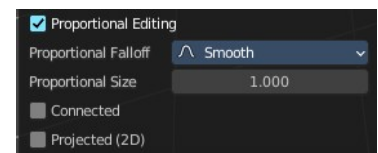

Connected

The proportional falloff gets calculated for connected parts only.

Projected(2D)

The proportional falloff gets calculated in the screen space. Depth doesn't play a role. When it's in the radius, then it gets calculated.

To Sphere

Transforms the selection into a sphere shape.

Snapping

Holding down Ctrl activates temporary global snapping.

Precision movement

When you hold down shift, then you will have a much slower but also much preciser movement.

Header Values

When you move the mouse then you will see some values in the header, which shows the current to sphere factor. This value is relative to the starting value, which always starts with 0.

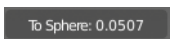

Last Operator To Sphere

Offset

The to sphere factor. This value is relative to the starting value, which always starts with 0.

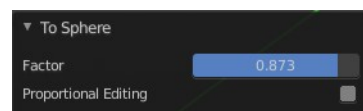

Proportional editing

Enables proportional editing. Activating proportional editing reveals further settings.

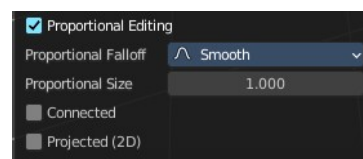

Proportional Falloff

Adjust the falloff methods.

Proportional Size

See and adjust the falloff radius.

Connected

The proportional falloff gets calculated for connected parts only.

Projected(2D)

The proportional falloff gets calculated in the screen space. Depth doesn't play a role. When it's in the radius, then it gets calculated.

Transform Fill

Change the Translation, Rotation and scale of strokes fill.

This tool is connected with the material settings. And works with Fill style Gradient and Texture.

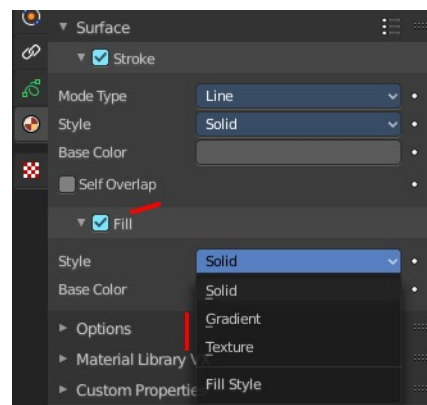

Tool Settings

Adjust the translation mode to Translate, Rotate or Scale.

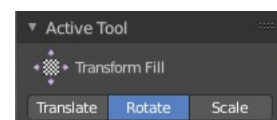

Last Operator Transform Stroke Fill

Mode

Adjust the translation mode to Translate, Rotate or Scale.

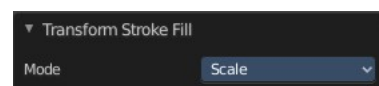

7.2.13 Editors - 3D Viewport - Tool Shelf - Grease Pencil - Sculpt Mode

Table of content

Tool Shelf - Grease Pencil - Sculpt Mode.....	1
Annotate tools.....	1
Stabilize Stroke.....	1
Radius.....	1
Factor.....	2
Select Tools.....	2
Footer.....	2
Smooth brush.....	2
Thickness.....	2
Strength.....	2
Randomize.....	2
Grab.....	2
Push.....	2
Twist.....	2
Pinch.....	3
Clone.....	3

Tool Shelf - Grease Pencil - Sculpt Mode

In Sculpt Mode you will mainly find brushes in the tool shelf.

The brushes settings are covered in the chapter 25.1.8 Editors - Properties Editor - Tools Tab - Grease Pencil Object.



Annotate tools

The annotate tools at the end of the list are explained in the chapter 7.1.1 Editors - 3D View - Tool Shelf - Object Mode. We won't cover this tools again here.

However, the active tool setting in Sculpt mode has an extra setting.

Stabilize Stroke

Helper to draw smooth and clean lines. Press Shift for an invert effect (even if this option is not active)

Radius and factor becomes visible when stabilize stroke is activated.

Radius

Stabilizer stroke radius. Minimum distance from last point before the stroke continues

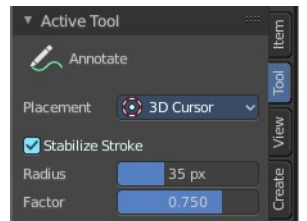

Factor

Stabilizer stroke factor. Higher values gives a smoother stroke.

Select Tools

When you activate one of the mask modes then the select tool group appears. It is explained in the chapter 7.1.1 Editors - 3D View - Tool Shelf - Object Mode. We won't cover this tools again here.

Footer

When you use a brush then you will see some further informations to the brush. Scroll Wheel changes for example the brush radius.

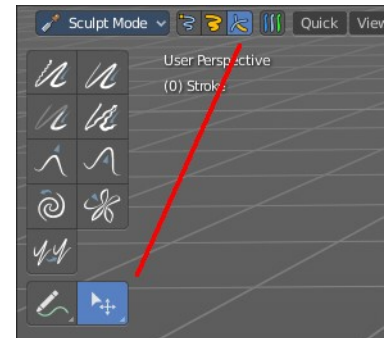

GPencil Sculpt: Smooth Stroke | LMB to paint | RMB/Escape to Exit | Ctrl to Invert Action | Wheel Up/Down for Size | Shift-Wheel Up/Down for Strength

Smooth brush

Smoothens the stroke under the brush.

Thickness

Changes the thickness of the stroke under the brush.

Strength

Adjust the transparency of the stroke under the brush. Note that the effect is pretty weak with even a strength of 1. You need several strokes until you get a visible effect.

Randomize

Randomizes the curve points.

Grab

Grab the stroke and pull it around.

Push

Push the stroke under the brush around.

Twist

Twist the stroke under the mouse. Clockwise or counter clockwise.

Pinch

Pinches or inflates the stroke under the mouse.

Clone

Clones strokes. You first need to copy a stroke before you can clone it.

Currently you need to be in one of the mask selection modes for that. Then select a stroke. With circle select for example. Copy it with ctrl c. And then you should be able to clone the current stroke around with a mouse click.

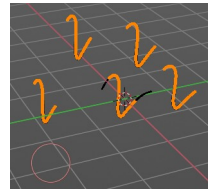

Note that it clones the whole stroke, and not just the selected stroke geometry. The clone brush is more of a copy and paste stroke tool.

7.2.14 Editors - 3D Viewport - Tool Shelf - Grease Pencil - Draw Mode

Table of content

Tool Shelf - Grease Pencil - Draw Mode.....	2
3D Cursor Tool.....	2
Footer.....	2
Hotkeys.....	2
Draw.....	2
Draw Color.....	2
Brushes.....	3
Guides.....	3
Guides Hotkeys.....	3
Circular.....	3
Radial.....	3
Parallel.....	3
Grid.....	3
Isometric.....	3
Angle.....	4
Use Snapping.....	4
Reference Point.....	4
Fill.....	4
Erase.....	4
Tint.....	4
Cutter.....	4
Tool settings.....	4
Flat Caps.....	4
Eye Dropper.....	4
Line.....	5
Poly line.....	5
Arc.....	5
Curve.....	5
Box.....	5
Circle.....	5
Interpolate.....	5
Tool settings.....	5
Layer.....	6
Flip Mode.....	6
Smooth.....	6
Iterations.....	6

Tool Shelf - Grease Pencil - Draw Mode

In Sculpt Mode you will mainly find draw tools in the tool shelf.

The brushes settings are covered in the chapter 7.3.12 Editors - 3D View - Sidebar - Tool Tab - Grease Pencil - Draw Mode

For the Annotate tools group see chapter 7.2.1 Editors - 3D View - Tool Shelf - Object Mode



3D Cursor Tool

The 3D cursor tool is explained in the chapter 7.2.1 Editors - 3D View - Tool Shelf - Object Mode. We won't cover this tool again here.

Footer

Some of the brushes and tools shows some further information in the footer.



Hotkeys

Some tools have some additional hotkey functionality. We will cover it one by one.

Draw

The Draw tool allows you to draw free-hand strokes. You paint with the left mouse.

Holding down Shift while drawing reveals a stabilizer widget which gives you more fine control over painting the stroke.

Holding down ALT while drawing will allow you to draw straight horizontal or vertical lines.

Holding down CTRL while drawing will turn the brush into an eraser brush.

Pressing B will allow you to box select stroke parts and delete them.



Draw Color

The Draw color is in real a material. To change the color you need to change the material. Or create one with the color that you need. The Grease Pencil Stroke object comes already with a few predefined colors. You can choose between them in the header tools area.

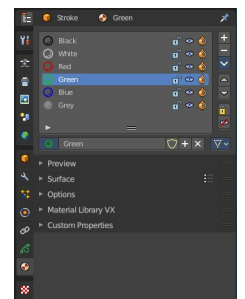
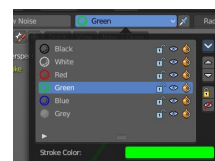

New materials can be created in the Properties editor in the Materials tab. You can also change the color of an existing material. But note that all previously drawn strokes will also change their color then. It is one material for one color.

Brushes

In the Brush browser you will find some more brush types for the Draw tool.

Guides

When you activate the Draw tool, then the Guides panel shows in the header. The Guides tools are directly connected with the Draw brush, it is a tools subset for it, and allows you to draw some guide shapes. Some perform around a center point called Reference Point.

You need to activate the Guides by clicking at the button at the left side of the drop down box.

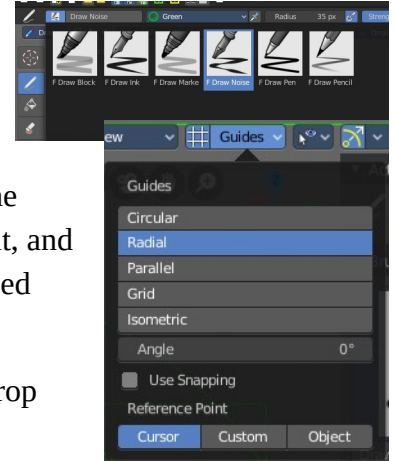

Guides Hotkeys

There are some special hotkeys just for the Guides tools. They don't have a regular menu entry. Better said, they are connected to the Guides panel.

- J/K** adjust guide angle by 15°, with holding alt key by 45°
- C** turn on Circular guide then toggle between Circular and Radial
- V** turn off guides
- L** turn on Parallel Line guide
- Alt L** Use angle of last freehand stroke for Parallel mode
- M** toggle between Circular & Radial mode or 90° in Parallel mode
- O** sets the reference point (only in Cursor or Custom mode)

Circular

Draws a circle around the reference point.

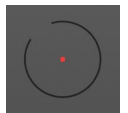

Radial

Draws a line from the starting point through the reference point.

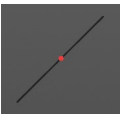

Parallel

Draws parallel horizontal lines. You can draw rotated lines with changing the angle slider.



Grid

Draws parallel horizontal and vertical lines.

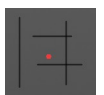

Isometric

Draws parallel horizontal and vertical lines. You can draw rotated lines with changing the angle slider. Vertical lines can still be drawn.



Angle

Radial, Angle, Isometric. The angle.

Use Snapping

Enable snapping to guides angle or spacing options.

Reference Point

Circular, Radial. What reference point to use.

Fill

This tool does not fill, but extend strokes of closed strokes areas by click drag, coming from the border. For example, when you create a Bezier circle. When you then click in the inner area, drag the mouse and release it, then the outer line of this Bezier circle gets extended into the inner direction by the in the brush panel adjusted amount.



When you use this tool outside of closed geometry, then it draws a frame around the current view.

Erase

Erase stroke curve points under the mouse.

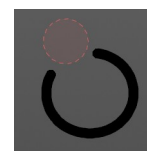

Tint

With the tint tool you can pant onto strokes points and mix the material base color with a selected vertex color.

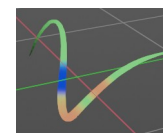

You first have to set up the colors in the color panel in the sidebar. The colors can be seen in viewport shading Material Preview and Rendered.

Cutter

Lasso select delete tool. Erases stroke curve points in the selection.



Tool settings

Flat Caps

Define if after cutting the stroke the cap of the cut side will be set as flat.

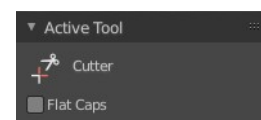

Eye Dropper

Pick a grease pencil material and make it the draw color.

Line

Draw straight lines by click drag. The yellow points are handlers that can be dragged around. Right mouse abandons the action. Pressing enter or middle mouse button confirms and makes the stroke real.

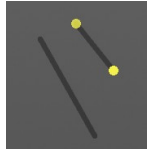

Hotkey E allows you to extrude the line.

Poly line

Draw straight lines by click drag. Clicking creates a new line in the polygon. Right mouse abandons the action. Pressing enter or middle mouse button confirms and makes the stroke real.

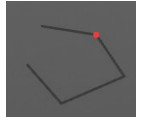

The polygon cannot be closed.

Arc

Draw simple arcs by click drag. The yellow points are handlers that can be dragged around. Right mouse abandons the action. Pressing enter or middle mouse button confirms and makes the stroke real.

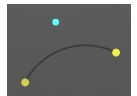

Curve

Draw complex Bezier style curves by click drag. First you create a straight line. The handlers allows you to deform the curve to your needs. Right mouse abandons the action. Pressing enter or middle mouse button confirms and makes the stroke real.



Box

Draw rectangular shapes by click drag. Hold Shift to create square shapes. The handlers allows you to adjust the rectangle to your needs. Right mouse abandons the action. Pressing enter or middle mouse button confirms and makes the stroke real.

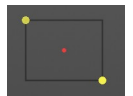

Circle

Draw oval shapes by click drag. Hold Shift to create square shapes. The handlers allows you to adjust the rectangle to your needs. Right mouse abandons the action. Pressing enter or middle mouse button confirms and makes the stroke real.

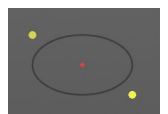

Interpolate

Interpolate grease pencil strokes between frames. You need to have two frames to interpolate between.

Tool settings

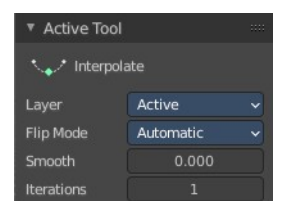

Layer

What layers to include in the interpolation.

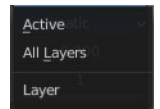

Flip Mode

How to invert destination stroke to match start and end with source stroke.



Smooth

Amount of smoothing to apply to interpolated strokes, to reduce jitter or noise.

Iterations

How often to smooth newly created strokes.

7.2.15 Editors - 3D Viewport - Tool Shelf - Grease Pencil - Vertex Paint Mode

Table of content

Tool Shelf - Grease Pencil - Vertex Paint Mode.....	1
Annotate tools.....	1
Select Tools.....	1
Footer.....	1
Draw.....	1
Blur.....	1
Average.....	2
Smear.....	2
Replace.....	2

Tool Shelf - Grease Pencil - Vertex Paint Mode

In Sculpt Mode you will mainly find brushes in the tool shelf.



Annotate tools

The annotate tools at the end of the list are explained in the chapter 7.1.1 Editors - 3D View - Tool Shelf - Object Mode. We won't cover this tools again here.

Select Tools

When you activate one of the mask modes then the select tool group appears. It is explained in the chapter 7.1.1 Editors - 3D View - Tool Shelf - Object Mode. We won't cover this tools again here.

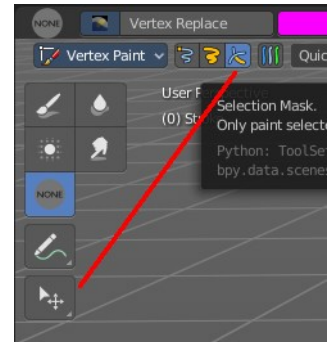

Footer

When you use a brush then you will see some further informations to the brush.

GPencil Vertex Paint: LMB to paint | RMB/Escape to Exit | Ctrl to Invert Action

Draw

Paint vertices.

Blur

Blur the color.

Average

Blends the color under the brush.

Smear

Smear the colors.

Replace

Replaces the vertex color under the mouse with the current color.

7.2.16 Editors - 3D Viewport - Tool Shelf - Grease Pencil - Weight Paint Mode

Table of content

Tool Shelf - Grease Pencil - Weight Paint Mode.....	1
Footer.....	1
Weight.....	1
Hotkeys.....	1

Tool Shelf - Grease Pencil - Weight Paint Mode

You can rig grease pencil strokes. And so you need a weight paint mode. In Weight Paint Mode you will just find one tool. The weight paint pencil.

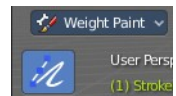

The brush settings are covered in the chapter 25.1.8 Editors - Properties Editor - Tools Tab - Grease Pencil Object.

Footer

When you paint then you will see some further information in the footer.

```
GPencil Sculpt: <?> Stroke | LMB to paint | RMB/Escap to Exit | Ctrl to Invert Action | Wheel Up/Down for Size | Shift-Wheel Up/Down for Strength
```

Weight

Allows you to weight paint the current stroke with the settings defined in the brush panel.

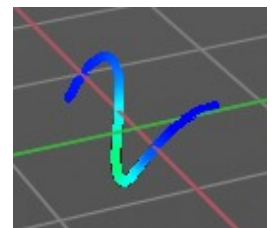

Hotkeys

F adjusts the brush radius.

Holding down lmb and scroll wheel adjusts the brush radius.

Shift F adjusts the brush strength.

Holding down lmb and ctrl and scroll wheel adjusts the brush strength.

Holding down Ctrl inverts the weight that gets drawn.

7.2.17 Editors - 3D Viewport - Tool Shelf - Armature - Edit Mode

Table of content

Tool Shelf - Armature - Edit Mode.....	3
Tweak, Select, 3D Cursor, Transform, Annotate and Measure.....	3
Roll.....	3
Snapping.....	3
Precision movement.....	3
Header Values.....	3
Tool Settings.....	3
Drag.....	3
Active Tool.....	3
Tweak, Select Box, Circle and Lasso.....	3
Last Operator Transform.....	4
Values X, Y Z.....	4
Axis.....	4
Orientation.....	4
Proportional editing.....	4
Proportional Falloff.....	4
Proportional Size.....	4
Connected.....	4
Projected(2D).....	4
Bone Size / Envelope Tools group.....	4
Bone Size.....	4
Snapping.....	5
Precision movement.....	5
Header Values.....	5
Tool Settings.....	5
Drag.....	5
Active Tool.....	5
Tweak, Select Box, Circle and Lasso.....	5
Last Operator Transform.....	5
Values X, Y Z.....	5
Axis.....	5
Orientation.....	6
Proportional editing.....	6
Proportional Falloff.....	6
Proportional Size.....	6
Connected.....	6
Projected(2D).....	6
Bone Envelope.....	6
Snapping.....	6
Precision movement.....	6
Header Values.....	6
Tool Settings.....	7
Drag.....	7
Active Tool.....	7
Tweak, Select Box, Circle and Lasso.....	7
Last Operator Transform.....	7

Values X, Y Z.....	7
Axis.....	7
Orientation.....	7
Proportional editing.....	7
Proportional Falloff.....	7
Proportional Size.....	7
Connected.....	7
Projected(2D).....	8
Extrude Tools group.....	8
Snapping.....	8
Precision movement.....	8
Header Values.....	8
Move without Widget.....	8
Limit Axis.....	8
Extrude.....	9
Tool Settings.....	9
Axis Type.....	9
Drag.....	9
Active Tool.....	9
Tweak, Select Box, Circle and Lasso.....	9
Last Operator Extrude.....	10
Forked.....	10
Move X , Y, Z.....	10
Orientation.....	10
Proportional editing.....	10
Extrude to cursor.....	10
Shear.....	10
Tool Settings.....	11
Orientation.....	11
Drag.....	11
Active Tool.....	11
Tweak, Select Box, Circle and Lasso.....	11
Last Operator Shear.....	11
Offset.....	11
Axis.....	11
Axis Ortho.....	11
Orientation.....	11
Proportional editing.....	11
Proportional Falloff.....	11
Proportional Size.....	11
Connected.....	12
Projected(2D).....	12

Tool Shelf - Armature - Edit Mode

Here you find some tools to edit and extend the armature.

Tweak, Select, 3D Cursor, Transform, Annotate and Measure

The tweak, select, 3D cursor and transform tools and the annotation and measure tool is already described in the chapter Object Mode. So we won't cover it here again.



Roll

Adjust the bone roll of the selected bone(s).

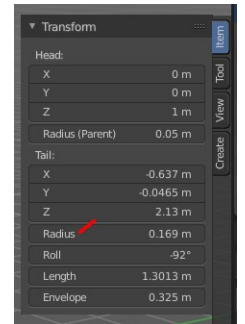
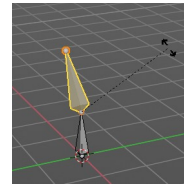

Snapping

Rotate and holding down Ctrl activates temporary global snapping. The rotation snaps every 5 degrees. With holding shift too it snaps every 1 degree.

Precision movement

When you hold down shift, then you will have a much slower but also much preciser rotation.

Header Values

When you move the mouse then you will see some values in the header, which shows the current rotation factor. This value is relative to the starting value, which always starts with 0.

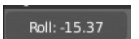

Tool Settings

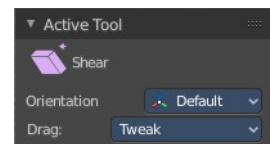

Drag

When you click at the widget of the active tool, then you perform the tool action. Adjust what should happen when you click outside of the widget, in the empty area.

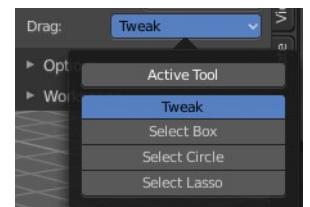

Active Tool

When you click off the widget then the click still does the same than clicking at the widget. It performs the active tool.

Tweak, Select Box, Circle and Lasso

When you choose this options then you will set the off click to the different select methods. Whereas tweak works more than a move tool then. Tweak is the default.

Last Operator Transform

Values X, Y Z

The rotation. Attention, the actual world orientation and rotation does not matter here. It always starts with a value of zero, and moves relative to this zero then. For the actual location values have a look in the sidebar in the transform panel.

The only relevant setting here is Value X. All other values and settings does not have any effect.

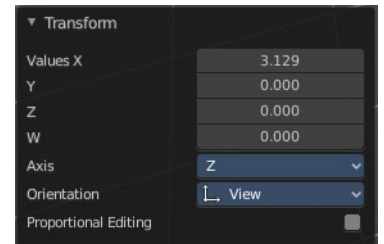

Axis

The axis to use. Axis has no effect, the bone axis X is always used.

Orientation

The widget can have different orientations. The menu items should be self explaining.

Orientation has no effect, the bone axis X is always used.

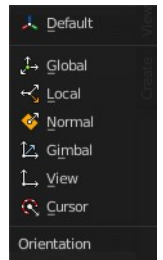

Proportional editing

Enables proportional editing. Activating proportional editing reveals further settings.

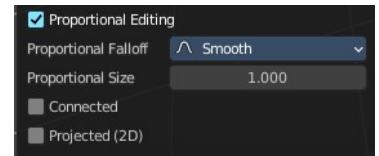

Proportional Falloff

Adjust the falloff methods.

Proportional Size

See and adjust the falloff radius.

Connected

The proportional falloff gets calculated for connected parts only.

Projected(2D)

The proportional falloff gets calculated in the screen space. Depth doesn't play a role. When it's in the radius, then it gets calculated.

Bone Size / Envelope Tools group

Bone Size

This tool just works with bone display type Bbone. With other bone display types nothing happens. Here you can scale the bbones.

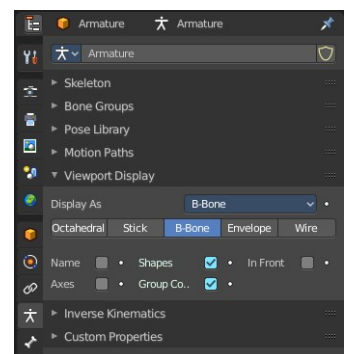
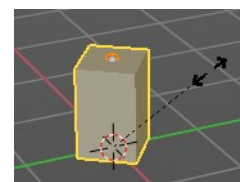
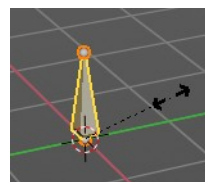

The bone display can be changed in the properties editor in the Object Data tab in the Viewport Display panel.

Snapping

Move and holding down Ctrl activates temporary global snapping. The rotation snaps every 5 degrees. With holding shift too it snaps every 1 degree.

Precision movement

When you hold down shift, then you will have a much slower but also much preciser rotation.

Header Values

When you move the mouse then you will see some values in the header, which shows the current rotation factor. This value is relative to the starting value, which always starts with 0.

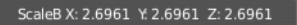

Scale B X: 2.6961 Y: 2.6961 Z: 2.6961

Tool Settings

Drag

When you click at the widget of the active tool, then you perform the tool action. Adjust what should happen when you click outside of the widget, in the empty area.

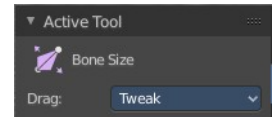

Active Tool

When you click off the widget then the click still does the same than clicking at the widget. It performs the active tool.

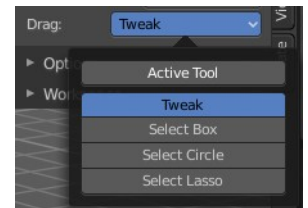

Tweak, Select Box, Circle and Lasso

When you choose this options then you will set the off click to the different select methods. Whereas tweak works more than a move tool then. Tweak is the default.

Last Operator Transform

Values X, Y Z

The rotation. Attention, the actual world orientation and rotation does not matter here. It always starts with a value of zero, and moves relative to this zero then. For the actual location values have a look in the sidebar in the transform panel.

The only relevant setting here is Value X. All other values and settings does not have any effect.

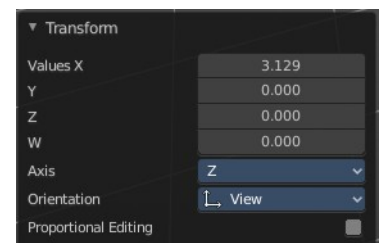

Axis

The axis to use. Axis has no effect, the bone axis X is always used.

Orientation

The widget can have different orientations. The menu items should be self explaining.

Orientation has no effect, the bone axis X is always used.

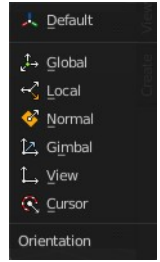

Proportional editing

Enables proportional editing. Activating proportional editing reveals further settings.

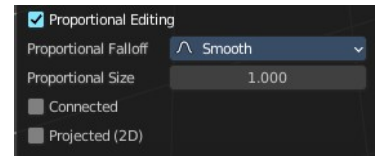

Proportional Falloff

Adjust the falloff methods.

Proportional Size

See and adjust the falloff radius.

Connected

The proportional falloff gets calculated for connected parts only.

Projected(2D)

The proportional falloff gets calculated in the screen space. Depth doesn't play a role. When it's in the radius, then it gets calculated.

Bone Envelope

This tool just works with bone display type Bbone. With other bone display types nothing happens. Here you can scale the envelope of the bones.

The bone display can be changed in the properties editor in the Object Data tab in the Viewport Display panel.

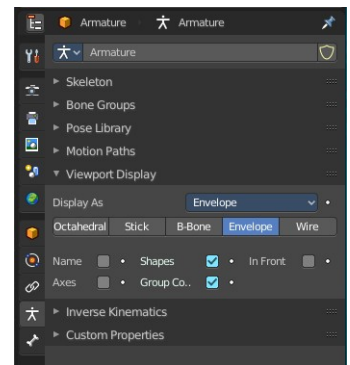
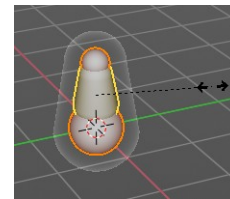
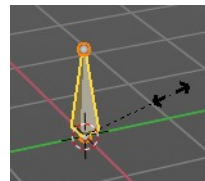

Snapping

Move and holding down Ctrl activates temporary global snapping. The rotation snaps every 5 degrees. With holding shift too it snaps every 1 degree.

Precision movement

When you hold down shift, then you will have a much slower but also much preciser rotation.

Header Values

When you move the mouse then you will see some values in the header, which shows the current rotation factor. This value is relative to the starting value, which always starts with 0.

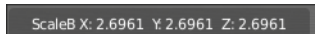

Tool Settings

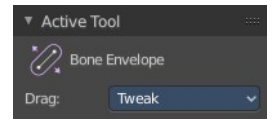

Drag

When you click at the widget of the active tool, then you perform the tool action. Adjust what should happen when you click outside of the widget, in the empty area.

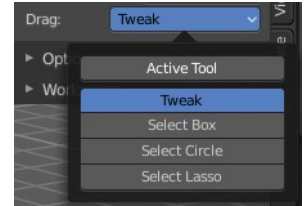

Active Tool

When you click off the widget then the click still does the same than clicking at the widget. It performs the active tool.

Tweak, Select Box, Circle and Lasso

When you choose this options then you will set the off click to the different select methods. Whereas tweak works more than a move tool then. Tweak is the default.

Last Operator Transform

Values X, Y Z

The rotation. Attention, the actual world orientation and rotation does not matter here. It always starts with a value of zero, and moves relative to this zero then. For the actual location values have a look in the sidebar in the transform panel.

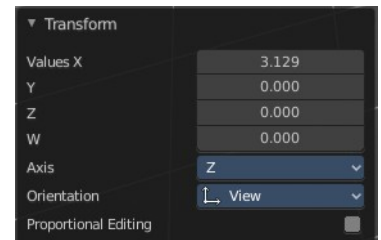

The only relevant setting here is Value X. All other values and settings does not have any effect.

Axis

The axis to use. Axis has no effect, the bone axis X is always used.

Orientation

The widget can have different orientations. The menu items should be self explaining.

Orientation has no effect, the bone axis X is always used.

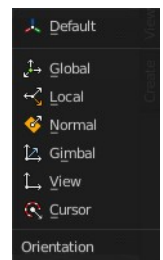

Proportional editing

Enables proportional editing. Activating proportional editing reveals further settings.

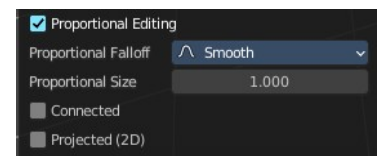

Proportional Falloff

Adjust the falloff methods.

Proportional Size

See and adjust the falloff radius.

Connected

The proportional falloff gets calculated for connected parts only.

Projected(2D)

The proportional falloff gets calculated in the screen space. Depth doesn't play a role. When it's in the radius, then it gets calculated.

Extrude Tools group

This group contains some extrude tools.

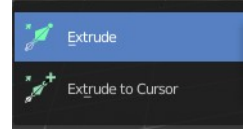

There are some general settings, since they all have some move settings We will cover them all here for all of the tools.

Snapping

Holding down Ctrl activates temporary global snapping.

Precision movement

When you hold down shift, then you will have a much slower but also much preciser movement.

Header Values

When you move your object then you will see some values in the header, which defines the current position of the object.

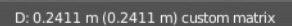

The value m stands for the default metric system. Meters. You can change the units in the Properties editor in the Scene properties in the Units panel. When you choose kilometers here then you will see a km instead m.

The value D stands for the distance of the current selected axis. This can also be two axis. Then you have two d values. The value in the brackets is then the direct distance to the starting point.

These values are always relative to the starting point. You always start with zero, regardless of the real world position.

Move without Widget

You don't have to use the widget to move the object. You can also click aside of it, and drag the object around. The mouse turns into a move cursor. The standard behavior then is to move in screen space. When you want to move into a specific axis, then press X or Y or Z to limit the movement to this axis.

Limit Axis

When you want to move along a specific axis, then press X or Y or Z to limit the movement to this axis. You usually start in global orientation. But you can change this in the Orientation settings.

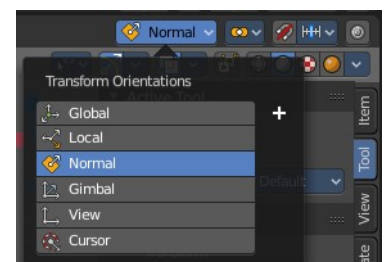
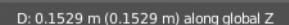

By holding down the mouse button and pressing the X, Y or Z key twice you can toggle this to local. But also to other orientations. This depends in what orientation you start. With normal you can toggle that way between Normal and Global.

Extrude

The Extrude tool extrudes out bones from selected joints.

When you activate the tool, then you will by default see a yellow widget at the selection. Drag it to extrude the selection.

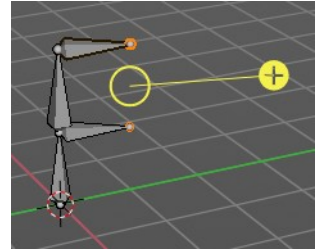

Tool Settings

Axis Type

You can choose between the regular axis type. That's the yellow widget with just one handler. It always points in the direction of the middled normals of the selection.

Or you can use the XYZ axis type. That's a handler with three axis. This widget can be aligned with the transform orientation methods.

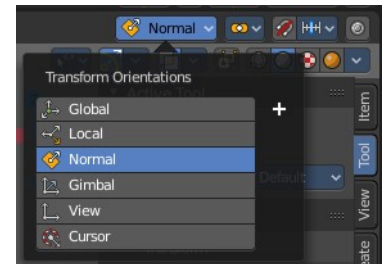
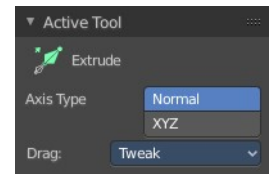
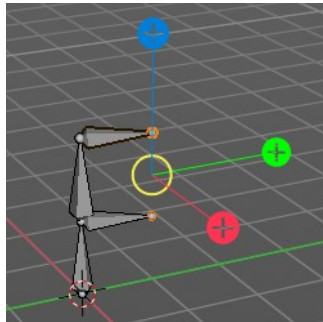

Drag

When you click at the widget of the active tool, then you perform the tool action. Adjust what should happen when you click outside of the widget, in the empty area.

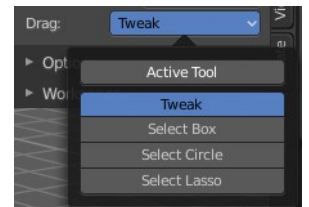

Active Tool

When you click off the widget then the click still does the same than clicking at the widget. It performs the active tool.

Tweak, Select Box, Circle and Lasso

When you choose this options then you will set the off click to the different select methods. Whereas tweak works more than a move tool then. Tweak is the default.

Last Operator Extrude

Forked

You need to tick X Axis Mirror. When you tick Forked, then the bone that you extrude to the one side will now be extruded to the other side too. The extrude gets mirrored along the x axis. This allows you to create a symmetrical armature.

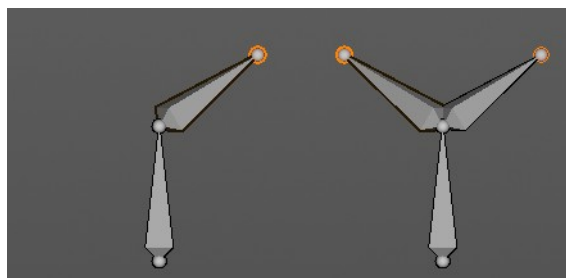
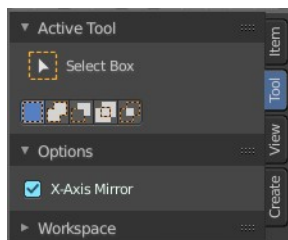
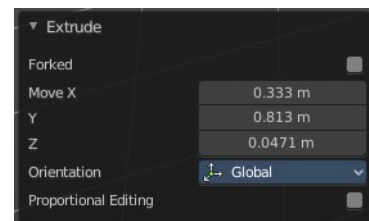

Move X , Y, Z

The transform values for the new created joint(s)

Orientation

Orientation is a drop-down box. Choose the type of orientation for the mirroring action.

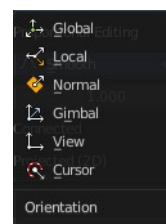

Proportional editing

Proportional editing is dysfunctional. You cannot activate it.

Extrude to cursor

Extrudes the selection towards the mouse cursor by clicking and dragging. The extruded geometry will rotate towards the mouse pointer.

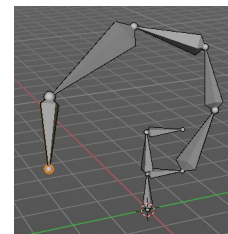

Shear

Shear shears the selection. When you activate the tool then you will reveal a widget. This widget allows you to shear the selection in all possible axis.

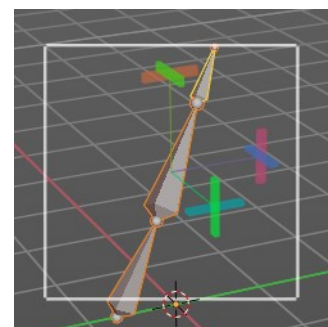

Tool Settings

Orientation

Choose the orientation for the shear action.

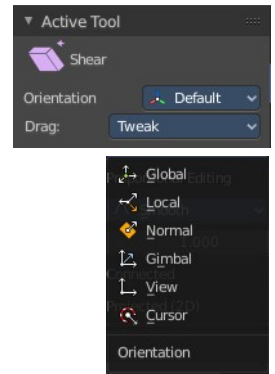

Drag

When you click at the widget of the active tool, then you perform the tool action. Adjust what should happen when you click outside of the widget, in the empty area.

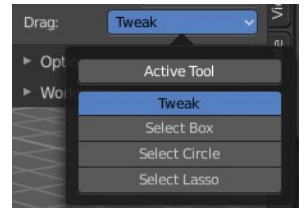

Active Tool

When you click off the widget then the click still does the same than clicking at the widget. It performs the active tool.

Tweak, Select Box, Circle and Lasso

When you choose this options then you will set the off click to the different select methods. Whereas tweak works more than a move tool then. Tweak is the default.

Last Operator Shear

Offset

Adjust an offset.

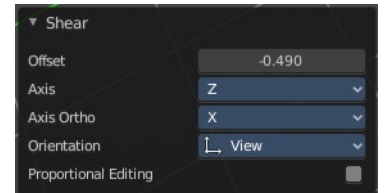

Axis

Defines one axis of the imaginary shear axis plane.

Axis Ortho

Defines the other axis of the imaginary shear axis plane.

Orientation

Choose the orientation for the shear action.

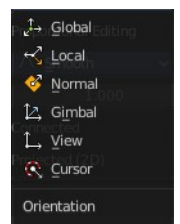

Proportional editing

Enables proportional editing. Activating proportional editing reveals further settings.

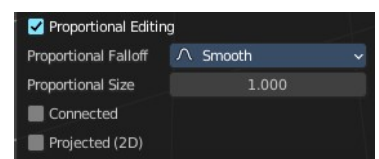

Proportional Falloff

Adjust the falloff methods.

Proportional Size

See and adjust the falloff radius.

Connected

The proportional falloff gets calculated for connected parts only.

Projected(2D)

The proportional falloff gets calculated in the screen space. Depth doesn't play a role. When it's in the radius, then it gets calculated.



7.2.18 Editors - 3D Viewport - Tool Shelf - Armature - Pose Mode

Table of content

Tool Shelf - Armature - Pose Mode.....	2
Tweak, Select, 3D Cursor, Transform, Annotate and Measure.....	2
Breakdowner Push Relax tools group.....	2
Breakdowner.....	2
Header values.....	2
Footer hotkey display.....	2
Last Operator Pose Breakdowner.....	3
Percentage.....	3
Previous Keyframe.....	3
Next Keyframe.....	3
Channels.....	3
Axis Lock.....	3
Push.....	3
Header Values.....	3
Last Operator Push Pose from Breakdown.....	3
Previous Keyframe.....	3
Next Keyframe.....	3
Percentage.....	3
Channels.....	3
Axis Lock.....	4
Relax.....	4
Header Values.....	4
Last Operator Relax Pose to Breakdown.....	4
Previous Keyframe.....	4
Next Keyframe.....	4
Percentage.....	4
Channels.....	4
Axis Lock.....	4

Tool Shelf - Armature - Pose Mode

The Pose mode provides some pose tools.

Tweak, Select, 3D Cursor, Transform, Annotate and Measure

The tweak, select, 3d cursor and transform tools and the annotation and measure tool is already described in the chapter Object Mode. So we won't cover it here again.



Breakdowner Push Relax tools group

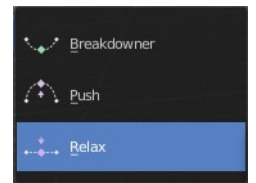

Breakdowner

Creates a suitable breakdowner pose on the current frame. Requires to have a keyframe before and after the current position.

Header values

When you activate one of the tools, then you will see a percentage slider in the header. This slider is not interactive. It just displays the percentage of the exaggeration.



Footer hotkey display

In the footer you will see some hotkeys for further options. These hotkeys are hard coded, and cannot be changed in the input manager.

Breakdown: W/E/R/B/C - Limit to Transform/Property Set | S - Enable overshoot | Shift - Hold for precision | Ctrl - Hold for 10% increments | [H] - Toggle bone visibility

The hotkeys W, E and R stands for the usual transform modes move, rotate or scale. Hotkey B stands for Bendy Bones. And C is for a custom property.

Overshoot allows you to go over the 0 -100 per cent range. The header values shows a bigger range then.



The rest of the hotkeys should be self explaining.

Last Operator Pose Breakdowner

Percentage

The percentage of exaggeration. Interestingly the value in the Last operator differs from the value in the header.

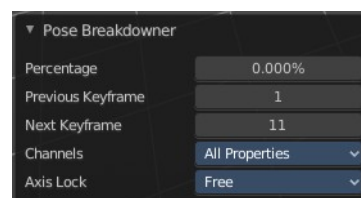

Previous Keyframe

The keyframe position before the current frame.

Next Keyframe

The keyframe position after the current frame.

Channels

Which channels to affect.

Axis Lock

Lock the action to specific axis.

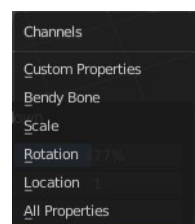

Push

Push exaggerates the current pose.

Header Values

When you move the mouse then you will see some values in the header, which shows the current factor. This value is relative to the starting value, which always starts with 0.



It also shows some more available transform hotkeys. The hotkeys W E and R allows you just to move, rotate or scale. Hotkey B stands for Bendy Bones. And C is for a custom property. This hotkeys are hard coded, and cannot be changed in the input manager.

Last Operator Push Pose from Breakdown.

Previous Keyframe

The keyframe position before the current frame.

Next Keyframe

The keyframe position after the current frame.

Percentage

The percentage of exaggeration. Interestingly the value in the Last operator differs from the value in the header.

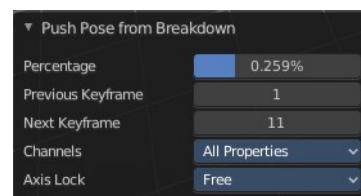

Channels

Which channels to affect.

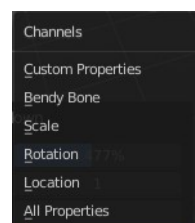

Axis Lock

Lock the action to specific axis.

Relax

Relax relaxes the current pose.

Header Values

Push Pose: 38 % | W/E/R/B/C - Limit to Transform/Property Set

When you move the mouse then you will see some values in the header, which shows the current factor. This value is relative to the starting value, which always starts with 0. It also shows some more available transform hotkeys.

It also shows some more available transform hotkeys. The hotkeys W E and R allows you just to move, rotate or scale. Hotkey B stands for Bendy Bones. And C is for a custom property. This hotkeys are hard coded, and cannot be changed in the input manager.

Last Operator Relax Pose to Breakdown

Previous Keyframe

The keyframe position before the current frame.

Next Keyframe

The keyframe position after the current frame.

Percentage

The percentage of exaggeration. Interestingly the value in the Last operator differs from the value in the header.

Channels

Here you can again choose if you just want to limit a specific channel.

Axis Lock

Allows you to lock a specific axis.

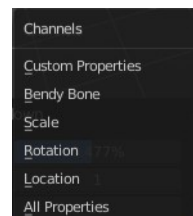
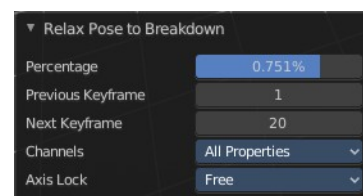



7.2.19 Editors - 3D Viewport - Tool Shelf - Lattice - Edit Mode

Table of content

Tool Shelf - Lattice - Edit Mode.....	1
Select, 3D Cursor, Transform, Measure and Annotate tools.....	1
Shear.....	1
Tool Settings.....	1
Orientation.....	2
Drag.....	2
Active Tool.....	2
Tweak, Select Box, Circle and Lasso.....	2
Last Operator Shear.....	2
Offset.....	2
Axis.....	2
Axis Ortho.....	2
Orientation.....	2
Proportional editing.....	2
Proportional Falloff.....	2
Proportional Size.....	2
Connected.....	2
Projected(2D).....	3

Tool Shelf - Lattice - Edit Mode

Select, 3D Cursor, Transform, Measure and Annotate tools

The Select, 3D Cursor, Transform, Measure and Annotate tools at the end of the list are explained in the chapter 7.1.1 Editors - 3D View - Tool Shelf - Object Mode. We won't cover this tools again here.



Shear

Shear shears the selection. When you activate the tool then you will reveal a widget. This widget allows you to shear the selection in all possible axis.

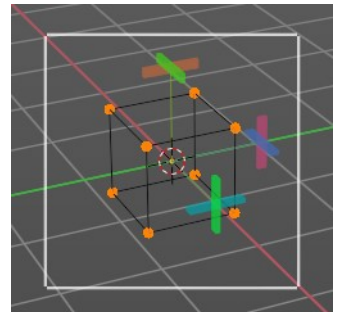

Tool Settings

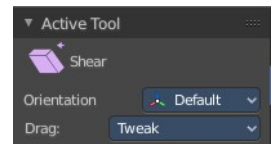

Orientation

Choose the orientation for the shear action.

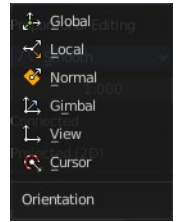

Drag

When you click at the widget of the active tool, then you perform the tool action. Adjust what should happen when you click outside of the widget, in the empty area.

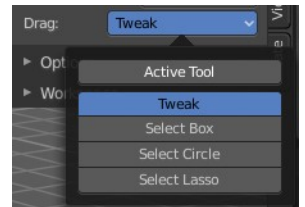

Active Tool

When you click off the widget then the click still does the same than clicking at the widget. It performs the active tool.

Tweak, Select Box, Circle and Lasso

When you choose this options then you will set the off click to the different select methods. Whereas tweak works more than a move tool then. Tweak is the default.

Last Operator Shear

Offset

Adjust an offset.

Axis

Defines one axis of the imaginary shear axis plane.

Axis Ortho

Defines the other axis of the imaginary shear axis plane.

Orientation

Choose the orientation for the shear action.

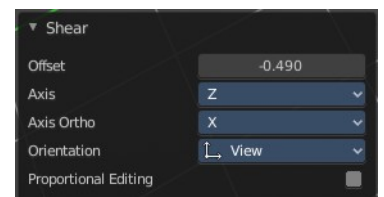

Proportional editing

Enables proportional editing. Activating proportional editing reveals further settings.

Proportional Falloff

Adjust the falloff methods.

Proportional Size

See and adjust the falloff radius.

Connected

The proportional falloff gets calculated for connected parts only.

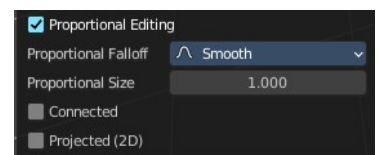
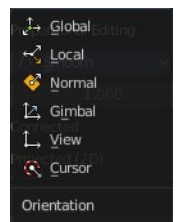

Projected(2D)

The proportional falloff gets calculated in the screen space. Depth doesn't play a role. When it's in the radius, then it gets calculated.



7.2.2 Editors - 3D Viewport - Tool Shelf - Mesh - Edit Mode

Table of content

Detailed table of content.....	1
Tool Shelf - Mesh - Edit Mode.....	10
Tweak, Select, 3D Cursor, Transform, Annotate and Measure.....	10
Primitives Add Tools Group.....	10
Extrude tools group.....	10
Inset Faces.....	18
Bevel.....	20
Loop Cut tools group.....	28
Knife Tool Group.....	30
Poly Build.....	33
Spin Tools Group.....	34
Smooth / Randomize Tools group.....	36
Edge and Vertex Slide Tools Group.....	38
Shrink/Fatten / Push/Pull Tools Group.....	40
Shear and To Sphere Tools Group.....	42
To Sphere.....	44
Rip Tools Group.....	45

Detailed table of content

Detailed table of content

Detailed table of content.....	1
Tool Shelf - Mesh - Edit Mode.....	10
Tweak, Select, 3D Cursor, Transform, Annotate and Measure.....	10
Primitives Add Tools Group.....	10
Extrude tools group.....	10
Snapping.....	10
Precision movement.....	10
Header Values.....	10
Move without Widget.....	11
Limit Axis.....	11
Extrude Region.....	11
Tool Settings.....	11
Axis Type.....	11
Drag.....	12
Active Tool.....	12
Tweak, Select Box, Circle and Lasso.....	12
Last Operator Extrude Region and Move.....	12
Flip Normals.....	12
Dissolve Orthogonal Edges.....	12
Move X, Y Z.....	12
Orientation.....	12
Proportional editing.....	12
Proportional Falloff.....	12

Proportional Size.....	12
Connected.....	12
Projected(2D).....	13
Extrude Manifold.....	13
Header Value.....	13
Tool Settings.....	13
Drag.....	13
Active Tool.....	13
Tweak, Select Box, Circle and Lasso.....	13
Last Operator Extrude Manifold.....	13
Flip Normals.....	13
Dissolve Orthogonal Edges.....	13
Move X, Y Z.....	14
Orientation.....	14
Proportional editing.....	14
Proportional Falloff.....	14
Proportional Size.....	14
Connected.....	14
Projected(2D).....	14
Extrude Along Normals.....	14
Header Value.....	14
Tool Settings.....	15
Offset Even.....	15
Drag.....	15
Active Tool.....	15
Tweak, Select Box, Circle and Lasso.....	15
Last Operator Extrude Region and Shrink/Fatten.....	15
Flip Normals.....	15
Dissolve Orthogonal Edges.....	15
Offset.....	15
Offset Even.....	15
Proportional editing.....	15
Proportional Falloff.....	15
Proportional Size.....	15
Connected.....	15
Projected(2D).....	16
Extrude Individual.....	16
Header Value.....	16
Tool Settings.....	16
Drag.....	16
Active Tool.....	16
Tweak, Select Box, Circle and Lasso.....	16
Last Operator Extrude Individual Faces and Move.....	16
Offset.....	16
Offset Even.....	16
Proportional editing.....	16
Proportional Falloff.....	17
Proportional Size.....	17
Connected.....	17
Projected(2D).....	17
Extrude to cursor.....	17
Tool Settings.....	17
Rotate Source.....	17

Last Operator Move.....	17
Move X Y Z.....	17
Orientation.....	17
Proportional editing.....	17
Proportional Falloff.....	17
Proportional Size.....	18
Connected.....	18
Projected(2D).....	18
Inset Faces.....	18
Tool Settings.....	18
Outset.....	18
Interpolate.....	18
Offset Even.....	18
Offset Relative.....	18
Drag.....	18
Active Tool.....	18
Tweak, Select Box, Circle and Lasso.....	18
Last Operator Inset Faces.....	19
Boundary.....	19
Offset Even.....	19
Offset Relative.....	19
Edge Rail.....	19
Thickness.....	19
Depth.....	19
Outset.....	19
Select Outer.....	19
Individual.....	19
Interpolate.....	19
Bevel.....	20
Tool Settings.....	20
Affect.....	20
Width type.....	20
Segments.....	20
Shape.....	20
Material Index.....	20
Harden Normals.....	20
Clamp Overlap.....	21
Loop Slide.....	21
Mark.....	21
Seam.....	21
Sharp.....	21
Miter outer.....	21
Sharp.....	21
Patch.....	21
Arc.....	21
Miter Inner.....	21
Sharp.....	21
Arc.....	21
Spread.....	22
Intersections.....	22
Face Strength Mode.....	22
None.....	22
New.....	22

Affected.....	22
All.....	22
Profile Type.....	22
Custom Profile.....	22
Preset.....	22
Zoom in.....	22
Zoom out.....	23
Tools.....	23
Reset View.....	23
Reset Curve.....	23
Reverse Path.....	23
Toggle Profile Clipping.....	23
Curve view.....	23
Handle Type Auto Handle.....	23
Handle Type Vector Handle.....	23
Handle Type Free Handle.....	23
Handle Type Aligned Free Handle.....	23
X Y Values.....	23
Delete.....	23
Sample Straight Edges.....	23
Sample Even Lengths.....	24
Drag.....	24
Active Tool.....	24
Tweak, Select Box, Circle and Lasso.....	24
Last Operator Bevel.....	24
Affect.....	24
Width type.....	24
Segments.....	24
Shape.....	24
Material Index.....	24
Harden Normals.....	24
Clamp Overlap.....	24
Loop Slide.....	25
Mark Seams.....	25
Mark Sharp.....	25
Outer Miter.....	25
Sharp.....	25
Patch.....	25
Arc.....	25
Inner Miter.....	25
Sharp.....	25
Arc.....	25
Spread.....	25
Intersections.....	26
Face Strength Mode.....	26
None.....	26
New.....	26
Affected.....	26
All.....	26
Profile Type.....	26
Profile Type Custom.....	26
Preset.....	26
Zoom in.....	26

Zoom out.....	26
Tools.....	26
Reset View.....	26
Reset Curve.....	27
Reverse Path.....	27
Toggle Profile Clipping.....	27
Curve view.....	27
Handle Type Auto Handle.....	27
Handle Type Vector Handle.....	27
Handle Type Free Handle.....	27
Handle Type Aligned Free Handle.....	27
X Y Values.....	27
Delete.....	27
Sample Straight Edges.....	27
Sample Even Lengths.....	27
Loop Cut tools group.....	28
Loop Cut.....	28
Tool Settings.....	28
Number of Cuts.....	28
Correct UV's.....	28
Last Operator Loop Cut and Slide.....	28
Number of Cuts.....	28
Smoothness.....	28
Falloff.....	28
Factor.....	28
Even.....	29
Flipped.....	29
Clamp.....	29
Correct UV's.....	29
Offset Edge Loop Cut.....	29
Last Operator Offset Edge Slide.....	29
Cap Endpoint.....	29
Edge Slide Factor.....	29
Even.....	29
Flipped.....	29
Clamp.....	29
Correct UV's.....	29
Knife Tool Group.....	30
Knife tool.....	30
Hotkey functionality in the footer text.....	30
Tool Settings.....	31
Occlude Geometry.....	31
Only Selected.....	31
X-Ray.....	31
Measurements.....	31
Angle Snapping.....	31
Angle Snapping Increment.....	31
Drag.....	31
Active Tool.....	31
Tweak, Select Box, Circle and Lasso.....	31
Bisect.....	31
Tool Settings.....	32
Fill.....	32

Clear Inner.....	32
Clear Outer.....	32
Axis threshold.....	32
Last Operator Bisect.....	32
Plane Point X , Y , Z.....	32
Plane Normal X , Y , Z.....	32
Fill.....	32
Clear Inner.....	32
Clear Outer.....	32
Axis threshold.....	32
Poly Build.....	33
Usage:.....	33
Tool Settings.....	33
Create Quads.....	33
Last Operator.....	33
Extrude At Cursor Move panel.....	33
Flip Normals.....	33
Move X, Y Z.....	33
Orientation.....	33
Face at Cursor Move panel.....	34
Move X, Y Z.....	34
Orientation.....	34
Proportional editing.....	34
Proportional Falloff.....	34
Proportional Size.....	34
Connected.....	34
Projected(2D).....	34
Spin Tools Group.....	34
Spin.....	34
Usage.....	35
Tool Settings.....	35
Steps.....	35
Axis.....	35
Last Operator Spin.....	35
Steps.....	35
Duplicate.....	35
Angle.....	35
Center X Y Z.....	35
Axis X Y Z.....	36
Spin Duplicate.....	36
Smooth / Randomize Tools group.....	36
Smooth.....	36
Usage.....	36
Tool Settings.....	36
Repeat.....	36
Drag.....	36
Active Tool.....	36
Tweak, Select Box, Circle and Lasso.....	36
Last Operator Smooth Vertices.....	36
Smoothing.....	36
Repeat.....	36
X Axis, Y Axis, Z Axis.....	37
Randomize.....	37

Usage.....	37
Tool Settings.....	37
Uniform.....	37
Normal.....	37
Random Seed.....	37
Drag.....	37
Active Tool.....	37
Tweak, Select Box, Circle and Lasso.....	37
Last Operator Smooth Vertices.....	37
Amount.....	37
Uniform.....	37
Normal.....	37
Random Seed.....	38
Edge and Vertex Slide Tools Group.....	38
Edge Slide.....	38
Header Values.....	38
Tool Settings.....	38
Correct UV's.....	38
Drag.....	38
Active Tool.....	38
Tweak, Select Box, Circle and Lasso.....	38
Last Operator Edge Slide.....	38
Factor.....	38
Even.....	39
Flipped.....	39
Clamp.....	39
Correct UV's.....	39
Vertex Slide.....	39
Header Values.....	39
Tool Settings.....	39
Correct UV's.....	39
Drag.....	39
Active Tool.....	39
Tweak, Select Box, Circle and Lasso.....	40
Last Operator Vertex Slide.....	40
Factor.....	40
Even.....	40
Flipped.....	40
Clamp.....	40
Correct UV's.....	40
Shrink/Fatten / Push/Pull Tools Group.....	40
Shrink / Fatten.....	40
Header Values.....	40
Tool Settings.....	40
Offset Even.....	40
Drag.....	40
Active Tool.....	40
Tweak, Select Box, Circle and Lasso.....	41
Last Operator Shrink/Fatten.....	41
Offset.....	41
Offset Even.....	41
Proportional editing.....	41
Proportional Falloff.....	41

Proportional Size.....	41
Connected.....	41
Projected(2D).....	41
Push/Pull.....	41
Header Values.....	41
Tool Settings.....	41
Offset Even.....	41
Drag.....	41
Active Tool.....	42
Tweak, Select Box, Circle and Lasso.....	42
Last Operator Push/Pull.....	42
Distance.....	42
Proportional editing.....	42
Proportional Falloff.....	42
Proportional Size.....	42
Connected.....	42
Projected(2D).....	42
Shear and To Sphere Tools Group.....	42
Shear.....	42
Tool Settings.....	43
Orientation.....	43
Drag.....	43
Active Tool.....	43
Tweak, Select Box, Circle and Lasso.....	43
Last Operator Shear.....	43
Offset.....	43
Axis.....	43
Axis Ortho.....	43
Orientation.....	43
Proportional editing.....	43
Proportional Falloff.....	43
Proportional Size.....	43
Connected.....	44
Projected(2D).....	44
To Sphere.....	44
Usage.....	44
Last Operator To Sphere Panel.....	44
Factor.....	44
Proportional editing.....	44
Proportional Falloff.....	44
Proportional Size.....	44
Connected.....	44
Projected(2D).....	44
Rip Tools Group.....	45
Rip Vertices.....	45
Tool Settings.....	45
Fill.....	45
Drag.....	45
Active Tool.....	45
Tweak, Select Box, Circle and Lasso.....	45
Last Operator Rip.....	45
Move X , Y , Z.....	45
Constraint Axis.....	45

Orientation.....	46
Proportional editing.....	46
Proportional Falloff.....	46
Proportional Size.....	46
Connected.....	46
Projected(2D).....	46
Rip Edge.....	46
Tool Settings.....	46
Drag.....	46
Active Tool.....	46
Tweak, Select Box, Circle and Lasso.....	46
Last Operator Extend Vertices.....	47
Move X , Y , Z.....	47
Constraint Axis.....	47
Orientation.....	47
Proportional editing.....	47
Proportional Falloff.....	47
Proportional Size.....	47
Connected.....	47
Projected(2D).....	47

Tool Shelf - Mesh - Edit Mode

In Edit mode with a mesh object you will find some polygon tools in the tool shelf.

Tweak, Select, 3D Cursor, Transform, Annotate and Measure

The weak, select and transform tools and the annotation and measure tool is already described in the chapter Object Mode. So we won't cover it here again. And start directly with the polygon tools.



Primitives Add Tools Group

This chapter is already explained in the Editors - 3D View - Tool Shelf - Object Mode chapter. Please have a look in this chapter.

The only difference is that the created primitive will be part of the mesh that you are in edit mode with. And not an independent object.

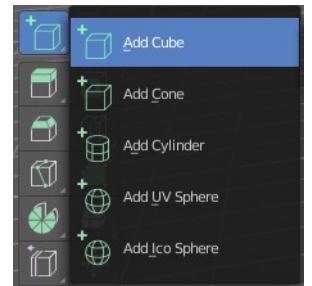

Extrude tools group

This group contains some extrude tools. A few more exotic ones can be found in the mesh menu.

There are some general settings, since they all have some move settings We will cover them all here for all of the tools.

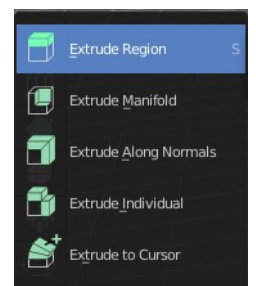

Snapping

Holding down Ctrl activates temporary global snapping.

Precision movement

When you hold down shift, then you will have a much slower but also much preciser movement.

Header Values

When you move your object then you will see some values in the header, which defines the current position of the object.

D: 0.2411 m (0.2411 m) custom matrix

The value m stands for the default metric system. Meters. You can change the units in the Properties editor in the Scene properties in the Units panel. When you choose kilometers here then you will see a km instead m.

The value D stands for the distance of the current selected axis. This can also be two axis. Then you have two d values. The value in the brackets is then the direct distance to the starting point.

These values are always relative to the starting point. You always start with zero, regardless of the real world position.

Move without Widget

You don't have to use the widget to move the object. You can also click aside of it, and drag the object around. The mouse turns into a move cursor. The standard behavior then is to move in screen space. When you want to move into a specific axis, then press X or Y or Z to limit the movement to this axis.

Limit Axis

When you want to move along a specific axis, then press X or Y or Z to limit the movement to this axis. You usually start in global orientation. But you can change this in the Orientation settings.

By holding down the mouse button and pressing the X, Y or Z key twice you can toggle this to local. But also to other orientations. This depends in what orientation you start. With normal you can toggle that way between Normal and Global.

D: 0.1529 m (0.1529 m) along global Z

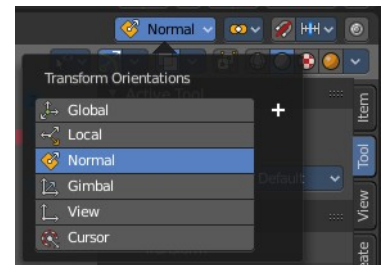

Extrude Region

The Extrude Region tool extrudes by default along the vertex normals of the current selection. When it's more than one vertex, edge or face, then the middle will be used.

The method works the same in all Mesh select modes. Vertice, Edge and Face Mode.

When you activate the tool, then you will by default see a yellow widget at the selection. Drag it to extrude the selection.

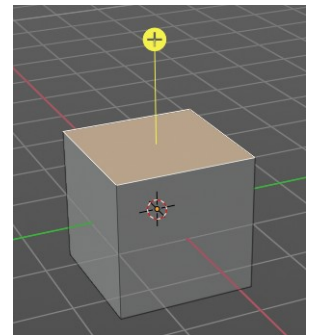

Tool Settings

Axis Type

You can choose between the regular axis type. That's the yellow widget with just one handler. It always points in the direction of the muddled normals of the selection.

Or you can use the XYZ axis type. That's a handler with three axis. This widget can be aligned with the transform orientation methods.

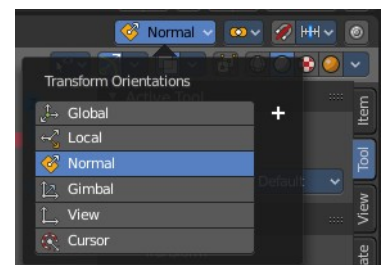
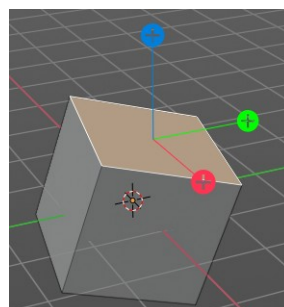
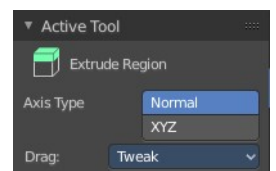

Drag

When you click at the widget of the active tool, then you perform the tool action. Adjust what should happen when you click outside of the widget, in the empty area.

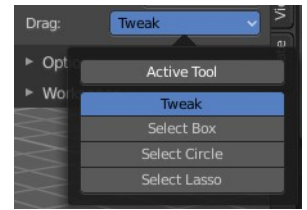

Active Tool

When you click off the widget then the click still does the same than clicking at the widget. It performs the active tool.

Tweak, Select Box, Circle and Lasso

When you choose this options then you will set the off click to the different select methods. Whereas tweak works more than a move tool then. Tweak is the default.

Last Operator Extrude Region and Move

Flip Normals

Flips the normals of the extruded faces.

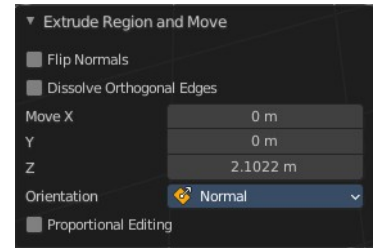

Dissolve Orthogonal Edges

Dissolves orthogonal edges at extrusion.

Move X, Y Z

The position. Attention, the actual world orientation and rotation does not matter here. It always starts with a value of zero, and moves relative to this zero then. For the actual location values have a look in the sidebar in the transform panel.

Orientation

The widget can have different orientations. The menu items should be self explaining.

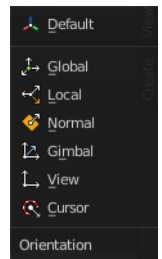

Proportional editing

Enables proportional editing. Activating proportional editing reveals further settings.

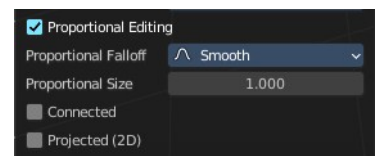

Proportional Falloff

Adjust the falloff methods.

Proportional Size

See and adjust the falloff radius.

Connected

The proportional falloff gets calculated for connected parts only.

Projected(2D)

The proportional falloff gets calculated in the screen space. Depth doesn't play a role. When it's in the radius, then it gets calculated.

Extrude Manifold

Extrude, dissolve Edges whose faces form a flat surface, and intersect new edges.

The method works the same in all Mesh select modes. Vertice, Edge and Face Mode.

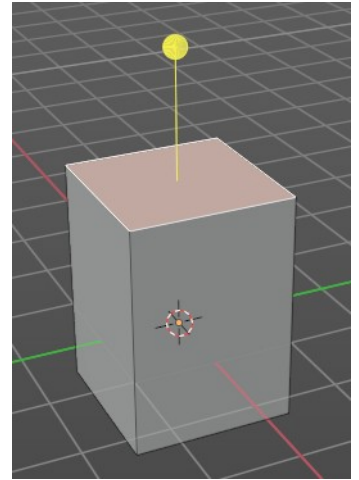

Header Value

The extrude amount.

D: 0 m (0.551 m) normal

Tool Settings

Drag

When you click at the widget of the active tool, then you perform the tool action. Adjust what should happen when you click outside of the widget, in the empty area.

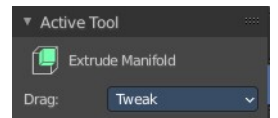

Active Tool

When you click off the widget then the click still does the same than clicking at the widget. It performs the active tool.

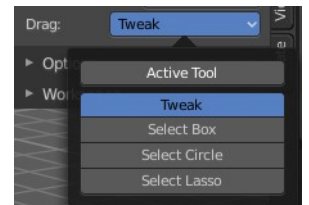

Tweak, Select Box, Circle and Lasso

When you choose this options then you will set the off click to the different select methods. Whereas tweak works more than a move tool then. Tweak is the default.

Last Operator Extrude Manifold

Flip Normals

Flips the normals of the extruded faces.

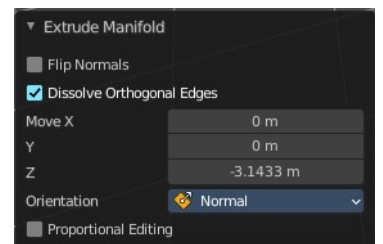

Dissolve Orthogonal Edges

Dissolve edges that are at the same straight surface.

Move X, Y Z

The position. Attention, the actual world orientation and rotation does not matter here. It always starts with a value of zero, and moves relative to this zero then. For the actual location values have a look in the sidebar in the transform panel.

Orientation

The widget can have different orientations. The menu items should be self explaining.

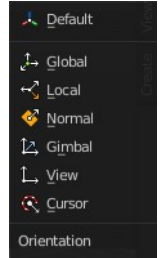

Proportional editing

Enables proportional editing. Activating proportional editing reveals further settings.

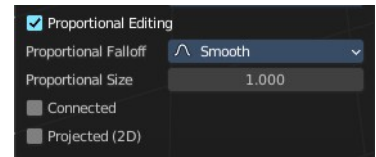

Proportional Falloff

Adjust the falloff methods.

Proportional Size

See and adjust the falloff radius.

Connected

The proportional falloff gets calculated for connected parts only.

Projected(2D)

The proportional falloff gets calculated in the screen space. Depth doesn't play a role. When it's in the radius, then it gets calculated.

Extrude Along Normals

Extrudes the selection along local normals. You won't see a widget here. Simply drag.

The method works the same in all Mesh select modes. Vertice, Edge and Face Mode.

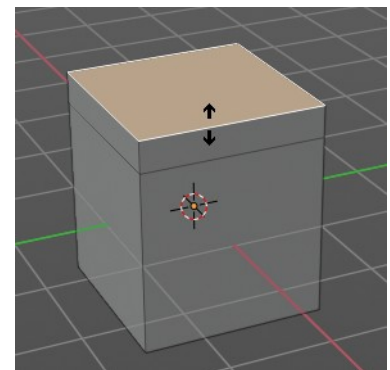

Header Value

This tool works like a shrink fatten extrude. And so you will see a corresponding set of values in the header.

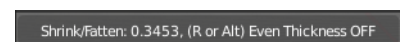

Tool Settings

Offset Even

Scales the offset to give more even thickness. Without this checked the farer away faces will have a bigger extrude amount.

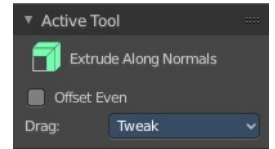

Drag

When you click at the widget of the active tool, then you perform the tool action. Adjust what should happen when you click outside of the widget, in the empty area.

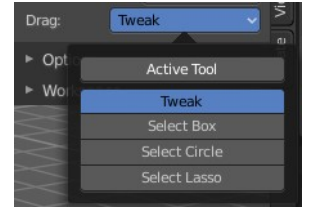

Active Tool

When you click off the widget then the click still does the same than clicking at the widget. It performs the active tool.

Tweak, Select Box, Circle and Lasso

When you choose this options then you will set the off click to the different select methods. Whereas tweak works more than a move tool then. Tweak is the default.

Last Operator Extrude Region and Shrink/Fatten

Flip Normals

Flips the normals of the extruded faces.

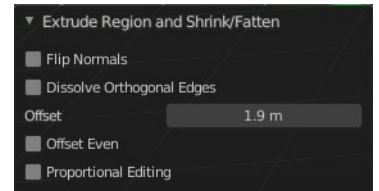

Dissolve Orthogonal Edges

Dissolves orthogonal edges at extrusion.

Offset

The current extrude amount.

Offset Even

Scales the offset to give more even thickness. Without this checked the farer away faces will have a bigger extrude amount.

Proportional editing

Enables proportional editing. Activating proportional editing reveals further settings.

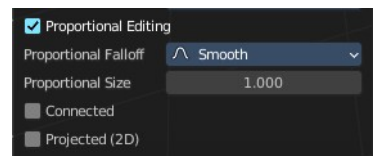

Proportional Falloff

Adjust the falloff methods.

Proportional Size

See and adjust the falloff radius.

Connected

The proportional falloff gets calculated for connected parts only.

Projected(2D)

The proportional falloff gets calculated in the screen space. Depth doesn't play a role. When it's in the radius, then it gets calculated.

Extrude Individual

Extrudes the selection along local normals of each individual face. You won't see a widget here. Simply drag.

The method works the same in all Mesh select modes. Vertice, Edge and Face Mode.

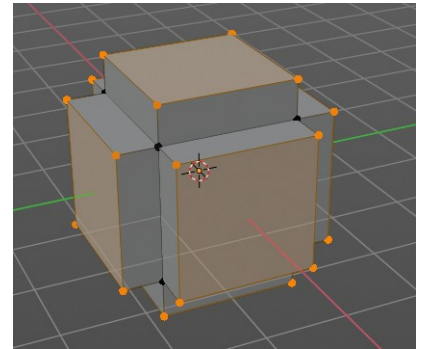

Header Value

This tool works like a shrink fatten extrude. And so you will see a corresponding set of values in the header.

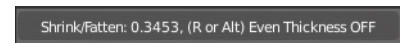

Tool Settings

Drag

When you click at the widget of the active tool, then you perform the tool action. Adjust what should happen when you click outside of the widget, in the empty area.

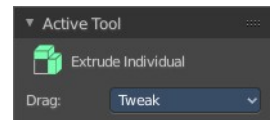

Active Tool

When you click off the widget then the click still does the same than clicking at the widget. It performs the active tool.

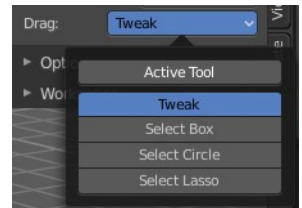

Tweak, Select Box, Circle and Lasso

When you choose this options then you will set the off click to the different select methods. Whereas tweak works more than a move tool then. Tweak is the default.

Last Operator Extrude Individual Faces and Move

Offset

The current extrude amount.

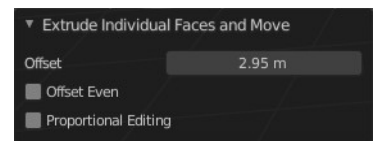

Offset Even

Scales the offset to give more even thickness. Without this checked the farer away faces will have a bigger extrude amount.

Proportional editing

Enables proportional editing. Activating proportional editing reveals further settings.

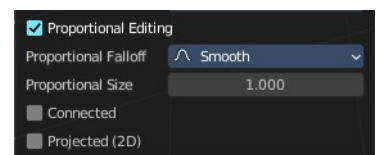

Proportional Falloff

Adjust the falloff methods.

Proportional Size

See and adjust the falloff radius.

Connected

The proportional falloff gets calculated for connected parts only.

Projected(2D)

The proportional falloff gets calculated in the screen space. Depth doesn't play a role. When it's in the radius, then it gets calculated.

Extrude to cursor

Extrudes the selection towards the mouse cursor by clicking and dragging. The extruded geometry will rotate towards the mouse pointer.

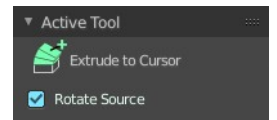
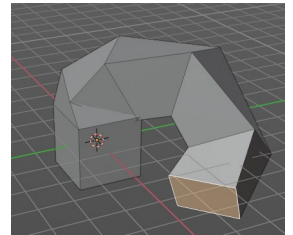

Tool Settings

Rotate Source

In theory this setting should rotate the source geometry too to achieve a better result. In practice this setting does nothing.

Last Operator Move

Move X Y Z

The current extrude amount.

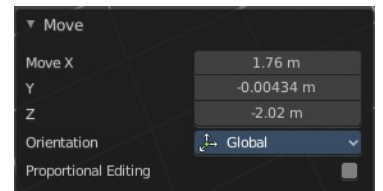

Orientation

The widget can have different orientations. The menu items should be self-explaining.

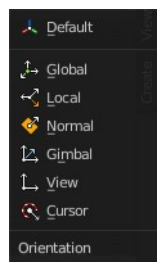

Proportional editing

Enables proportional editing. Activating proportional editing reveals further settings.

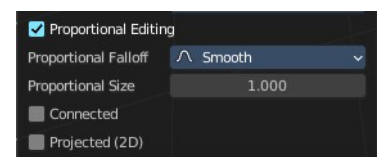

Proportional Falloff

Adjust the falloff methods.

Proportional Size

See and adjust the falloff radius.

Connected

The proportional falloff gets calculated for connected parts only.

Projected(2D)

The proportional falloff gets calculated in the screen space. Depth doesn't play a role. When it's in the radius, then it gets calculated.

Inset Faces

Inset insets edges into the selected faces. Think of it as an extrude inwards the face.

Activate the tool, drag the mouse. But carefully. The control is not the best. You better adjust the amount in the last operator.

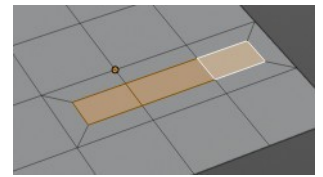

Tool Settings

Outset

With outset ticked the Inset will not extrude inwards but outwards.

Interpolate

Blend Face Data across the inset.

Offset Even

Scales the offset to give more even thickness.

Offset Relative

Scales the offset by surrounding geometry.

Drag

When you click at the widget of the active tool, then you perform the tool action. Adjust what should happen when you click outside of the widget, in the empty area.

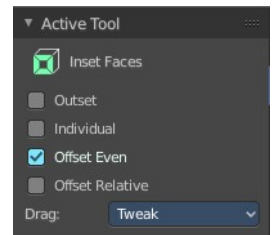

Active Tool

When you click off the widget then the click still does the same than clicking at the widget. It performs the active tool.

Tweak, Select Box, Circle and Lasso

When you choose this options then you will set the off click to the different select methods. Whereas tweak works more than a move tool then. Tweak is the default.

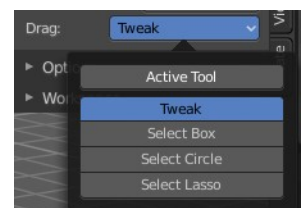

Last Operator Inset Faces

Boundary

With Boundary ticked you will get the connect edges in the corners. Without the edges ends straight.

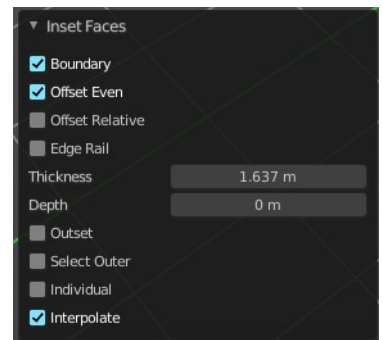
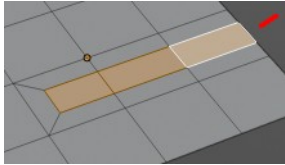

Offset Even

Scales the offset to give more even thickness.

Offset Relative

Scales the offset by surrounding geometry.

Edge Rail

Inset the region along existing edges.

Thickness

Thickness adjusts the thickness of the inset geometry.

Depth

With depth you can bevel the inset geometry. It is then not longer co planar to the initial face.

Outset

With outset ticked the Inset will not extrude inwards but outwards.

Select Outer

With Select Outer the outer ring will be selected after the Inset.

Individual

Inset every face individually.

Interpolate

Blend Face Data across the inset.

Bevel

The Bevel Tool adds a bevel to the selected geometry.

Usage: first select the geometry that you want to bevel. Then activate the tool. Don't wonder that the mouse movement does nothing until you move the mouse really really far away. That's by design. Best is to adjust the amount in the Last Operator Bevel panel.

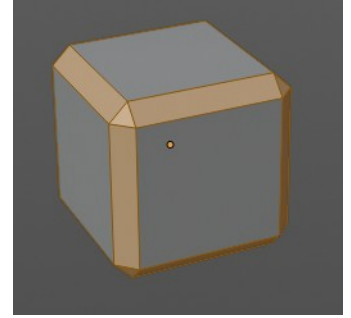

Tool Settings

Affect

What geometry to bevel. Vertices or Edges.

Note that with Vertices some options are not available.

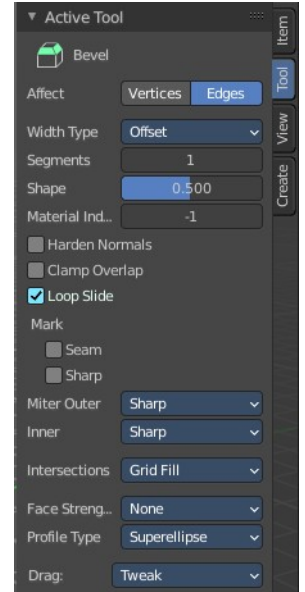
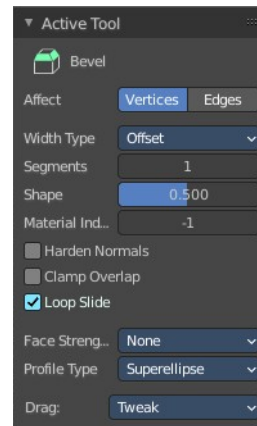

Width type

Which measure type to choose for the bevel action. Offset, Width, Depth or Percent.

Segments

How many segments gets created.

Shape

Controls the profile shape strength. A value close to 0 bends the roundness to inside. A value towards 1 bends the curve to outside. A value of 0.5 defines a radius around the center point of the bevel.

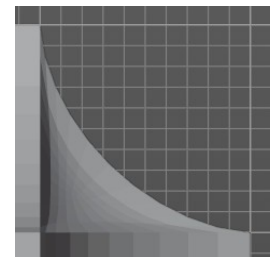
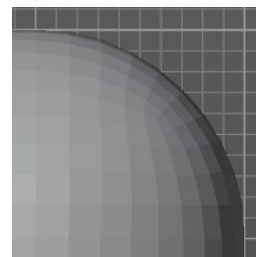

Material Index

The material for bevel faces. -1 means to use the material from the adjacent faces.

Harden Normals

Match normals of new faces to adjacent faces.

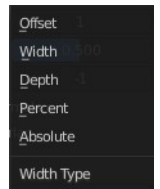

Clamp Overlap

Do not allow beveled edges / vertices to overlap each other.

Loop Slide

Prefer sliding along edges to even widths.

Mark

Seam

Mark seam along beveled edges.

Sharp

Mark beveled edges as sharp.

Miter outer

How the outer miter is set. Miter is how the bevel rounding at a corner is done.



Sharp

Creates a sharp miter.

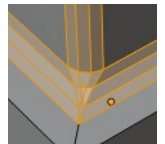

Patch

This replaces the outside vertex of a miter with 3 vertices. And uses a patch pattern there.

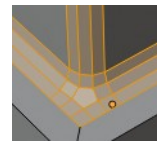

Arc

This replaces the vertex of a miter with 2 vertices, joined by an arc. A separate Spread parameter says how far to move the vertices away from their original position.

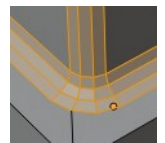

Miter Inner

How the inner miter is set. Miter is how the bevel rounding at a corner is done.

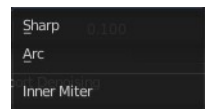

Sharp

Creates a sharp miter.

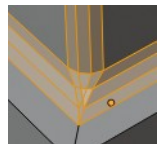

Arc

This replaces the vertex of a miter with 2 vertices, joined by an arc. A separate Spread parameter says how far to move the vertices away from their original position.

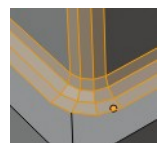

Spread

Belongs to inner miter method Arc. Adjust how strong the inner radius is bent.

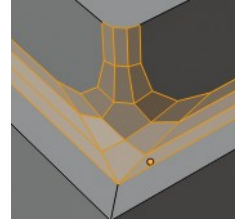

Intersections

The method to use to create meshes at intersections. Bevel can create self intersecting geometry.



Face Strength Mode

Set Face Strength on the faces involved in the bevel, according to the specified mode. This can be used in conjunction with a Weight Normals Modifier (with the Face Influence option checked).

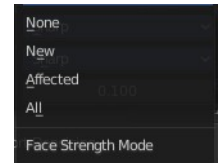

None

Do not set face strength.

New

Set the face strength of new faces along edges to Medium, and the face strength of new faces at vertices to Weak.

Affected

In addition to those set for the New case, also set the faces adjacent to new faces to have strength Strong.

All

In addition to those set for the Affected option, also set all the rest of the faces of the model to have strength Strong.

Profile Type

Which profile type to use. Super ellipse or Custom.

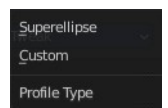

Custom Profile

Choose and adjust a custom bevel profile. This feature needs more than one segment to work.

Preset

Choose some profile presets.

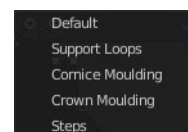

Zoom in

Zooms into the curve view.

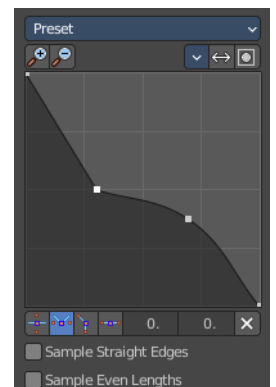

Zoom out

Zooms out of the curve view.

Tools

Reset View

Resets the zoom factor of the curve view.

Reset Curve

Resets the curve to the defaults. This means when you choose a curve preset to reset it to the values of the latest chosen preset.



Reverse Path

The path gets reversed. The first point becomes the last and vice versa.

Toggle Profile Clipping

Toggles the profile clipping.

Curve view

Adjust the profile curve.

Left click where no point is adds a new point. Left click at a point allows you to move it.

Holding down Shift while moving a node point activates precision movement.

Holding down ctrl while moving activates temporary snapping.

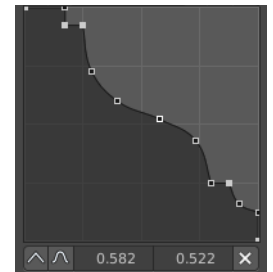

When a point is selected then the curve view reveals a sub menu at the bottom.

Handle Type *Auto Handle*

Sets the handle type of this curve point to smooth.

Handle Type *Vector Handle*

Sets the handle type of this curve point to sharp.

Handle Type *Free Handle*

Sets the handle type of this curve to Free handles. The curve point has now two handles with which you can adjust the curve before and after the point each.

Handle Type *Aligned Free Handle*

Sets the handle type of this curve to Free handles. The curve point has now a handle with which you can adjust the curve.

X Y Values

The position of the currently selected curve point

Delete

Delete the selected curve point.

Sample Straight Edges

Sample edges with vector handles.

Sample Even Lengths

Sample edges with even lengths.

Drag

When you click at the widget of the active tool, then you perform the tool action. Adjust what should happen when you click outside of the widget, in the empty area.

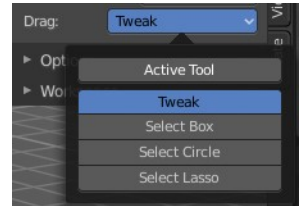

Active Tool

When you click off the widget then the click still does the same than clicking at the widget. It performs the active tool.

Tweak, Select Box, Circle and Lasso

When you choose this options then you will set the off click to the different select methods. Whereas tweak works more than a move tool then. Tweak is the default.

Last Operator Bevel

Affect

What geometry to bevel. Vertices or Edges.

Width type

Which measure type to choose for the bevel action. Offset, Width, Depth or Percent.

Segments

How many segments gets created.

Shape

Controls the profile shape strength. A value close to 0 bends the roundness to inside. A value towards 1 bends the curve to outside. A value of 0.5 defines a radius around the center point of the bevel.

Material Index

The material for bevel faces. -1 means to use the material from the adjacent faces.

Harden Normals

Match normals of new faces to adjacent faces.

Clamp Overlap

Do not allow beveled geometry to overlap each other.

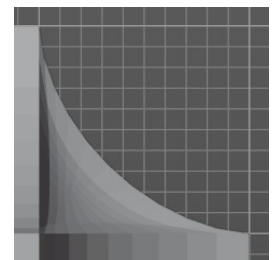
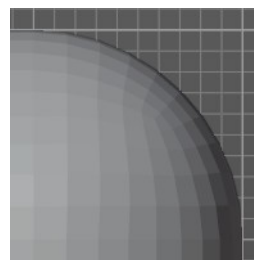
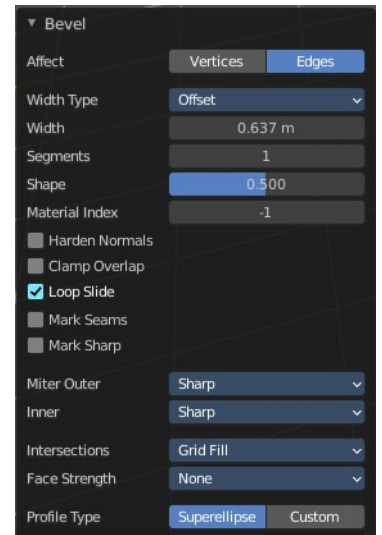

Loop Slide

Prefer slide along edge to even widths.

Mark Seams

Mark the edges of the new created geometry as seams.

Mark Sharp

Mark the edges of the new created geometry sharp.

Outer Miter

How the outer miter is set. Miter is how the bevel rounding at a corner is done.



Sharp

Creates a sharp miter.

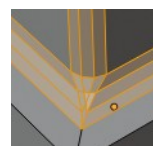

Patch

This replaces the outside vertex of a miter with 3 vertices. And uses a patch pattern there.

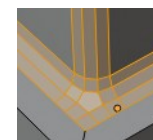

Arc

This replaces the vertex of a miter with 2 vertices, joined by an arc. A separate Spread parameter says how far to move the vertices away from their original position.

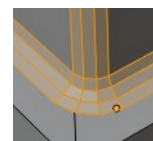

Inner Miter

How the inner miter is set. Miter is how the bevel rounding at a corner is done.

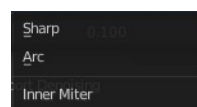

Sharp

Creates a sharp miter.

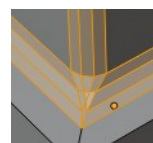

Arc

This replaces the vertex of a miter with 2 vertices, joined by an arc. A separate Spread parameter says how far to move the vertices away from their original position.

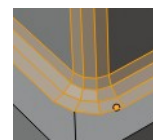

Spread

Belongs to inner miter method Arc. Adjust how strong the inner radius is bent.

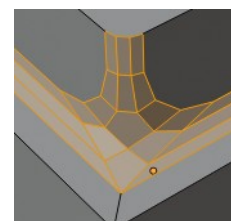

Intersections

The method to use to create meshes at intersections. Bevel can create self intersecting geometry.

Face Strength Mode

Set Face Strength on the faces involved in the bevel, according to the specified mode. This can be used in conjunction with a Weight Normals Modifier (with the Face Influence option checked).

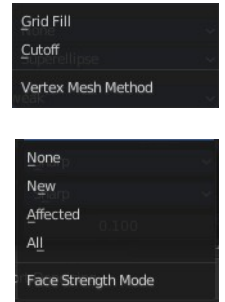

None

Do not set face strength.

New

Set the face strength of new faces along edges to Medium, and the face strength of new faces at vertices to Weak.

Affected

In addition to those set for the New case, also set the faces adjacent to new faces to have strength Strong.

All

In addition to those set for the Affected option, also set all the rest of the faces of the model to have strength Strong.

Profile Type

Which profile type to use. Super ellipse or Custom.



Profile Type Custom

Choose and adjust a custom bevel profile. This feature needs more than one segment to work.

Preset

Choose some profile presets.

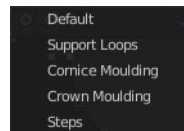

Zoom in

Zooms into the curve view.

Zoom out

Zooms out of the curve view.

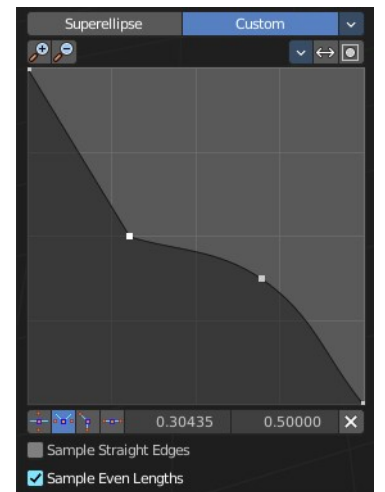

Tools

Reset View

Resets the zoom factor of the curve view.

Reset Curve

Resets the curve to the defaults. This means when you choose a curve preset to reset it to the values of the latest chosen preset.



Reverse Path

The path gets reversed. The first point becomes the last and vice versa.

Toggle Profile Clipping

Toggles the profile clipping.

Curve view

Adjust the profile curve.

Left click where no point is adds a new point. Left click at a point allows you to move it.

Holding down Shift while moving a node point activates precision movement.

Holding down ctrl while moving activates temporary snapping.

When a point is selected then the curve view reveals a sub menu at the bottom.

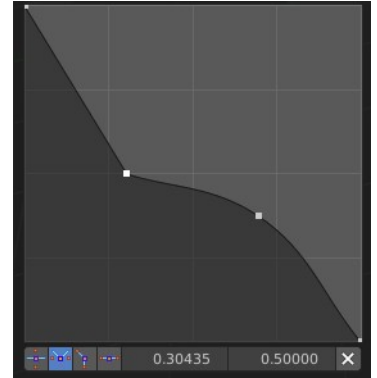

Handle Type *Auto Handle*

Sets the handle type of this curve point to smooth.

Handle Type *Vector Handle*

Sets the handle type of this curve point to sharp.

Handle Type *Free Handle*

Sets the handle type of this curve to Free handles. The curve point has now two handles with which you can adjust the curve before and after the point each.

Handle Type *Aligned Free Handle*

Sets the handle type of this curve to Free handles. The curve point has now a handle with which you can adjust the curve.

X Y Values

The position of the currently selected curve point

Delete

Delete the selected curve point.

Sample Straight Edges

Sample edges with vector handles.

Sample Even Lengths

Sample edges with even lengths.

Loop Cut tools group

Loop Cut

Loop Cut adds edge loops. When you hover with the mouse over the geometry then you will see a yellow line in the exact middle of the face(s). This is what will be the new cutted edge.

When you click once, then this edge gets created. When you click and hold, then you can move this edge to a new location.

Loop cut ignores selections. It will try to divide the face under the mouse, and continue the loop until it is closed, or until it cannot continue. At poles for example.

Tool Settings

Number of Cuts

You can with one cut add more than one edge. Adjust the amount.

Note that here you need to adjust this setting before adding the loop. Note also that the yellow preview line will not show all added loops. But just the yellow line.

The settings remains its values as long as you don't close Bforartists and restart it.

Correct UV's

Correct the UV's when transforming the new added loop.

Last Operator Loop Cut and Slide

Note that all settings here just changes the latest added loop. Not all added loops in the current session.

Number of Cuts

The number of cuts that gets added. It can be more than one loop at once.

Smoothness

This value defines how smooth the loop cut gets added. From flat to bent.

Falloff

Adjust the Falloff type for smoothness.

Factor

Change the center of the added loop.

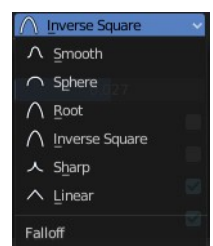
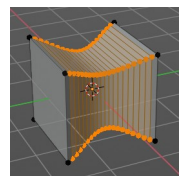
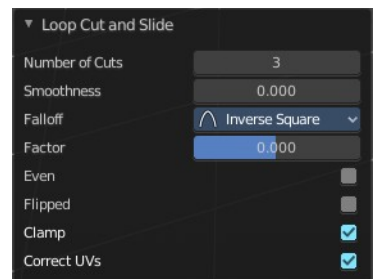
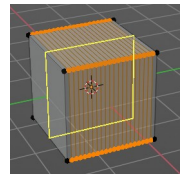
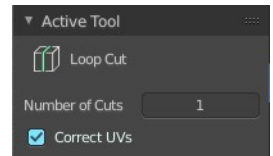
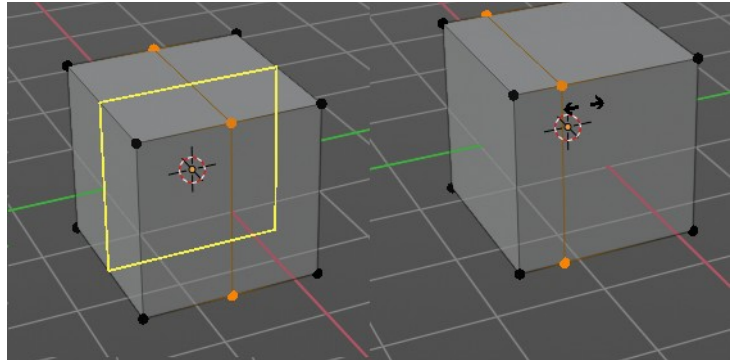
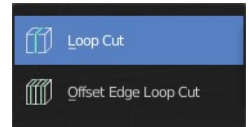

Even

Make the edge loop match the shape of the adjacent edge loop

Flipped

When Even mode is active, flips between the two adjacent edge loops.

Clamp

Clamp within the edge extend.

Correct UV's

Corrects the UV's when modifying the geometry.

Offset Edge Loop Cut

Slides the selected edge(s)

Usage: select the edges that you want to slide. Click to confirm.

You can adjust the sliding amount in the Last Operator Offset Edge Slide.

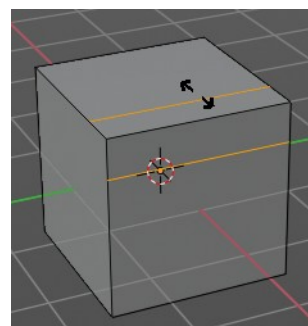

Last Operator Offset Edge Slide

Cap Endpoint

Cap Endpoint caps the loose edges.

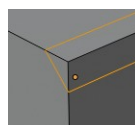

Edge Slide Factor

Adjust the slide amount.

Even

Make the edge loop match the shape of the adjacent edge loop

Flipped

When Even mode is active, flips between the two adjacent edge loops.

Clamp

Clamp within the edge extend.

Correct UV's

Corrects the UV's when modifying the geometry.

Knife Tool Group

Knife tool

The Knife tool cuts the geometry, and adds edges. When it crosses existing geometry then it adds a vertex at the crossing point.

Usage: activate the tool, left click to define the starting point. This can also be a point in the middle of a face. But ideally you choose an existing vertex or an edge as the start and endpoints. The knife tool tries to snap to them when you get close with the mouse cursor.

When done press Enter or Spacebar to confirm. Right click abandons the operation.

When you create a vertex in the middle of a face, then the knife tool will try to connect this vertex by an existing vertex of this face when you confirm with spacebar.

The Knife tool can now cut through multiple objects in edit mode. You need to enter edit mode with these objects. Hold down shift to select the other objects ...

Hotkey functionality in the footer text

Have a look at the footer when you work with this tool. Here you will find further instructions and hotkeys.



Enter, Pad Enter, Spacebar - confirm

Esc key, RMB - cancel the operation

LMB start the cut

Double LMB - close the cut

E - create new cut

Ctrl or Shift while dragging - Snap to the middle of an edge

Z - cut through the whole geometry, also the backfaces.

MMB - pan the view.

Alt MMB - rotate the view.

S - activate the measure tools. Holding down S will cycle through the three measure modes. Only Distance, Only Angles and both distance and angle measurement.

A - activate the angle constraint.

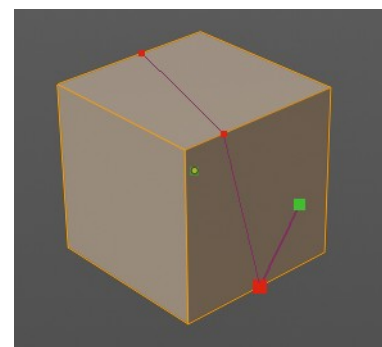

Tool Settings

Occlude Geometry

Just cut the visible geometry that points towards you. Not the backfaces.

Only Selected

Just cut through selected geometry. Not through not selected.

X-Ray

Show cuts through the geometry.

Measurements

The measurements modes. The names should be self explaining.

Angle Snapping

Activate snap to angles. When active then the knife cut snaps to an angle either aligned to the screen or relative to the object.

Angle Snapping Increment

The snapping angle in case the angle snapping tool is active.

Drag

When you click at the widget of the active tool, then you perform the tool action. Adjust what should happen when you click outside of the widget, in the empty area.

Active Tool

When you click off the widget then the click still does the same than clicking at the widget. It performs the active tool.

Tweak, Select Box, Circle and Lasso

When you choose this options then you will set the off click to the different select methods. Whereas tweak works more than a move tool then. Tweak is the default.

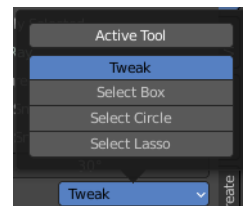
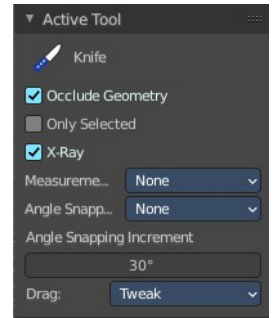

Bisect

Bisect cuts geometry along a plane. This description is a bit misleading though. You simply cut through the whole geometry by defining a line. And the cut goes through the geometry from the current view.

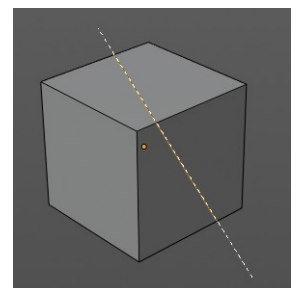

#

When you have set your cut and release the mouse then you reveal a widget with which you can move and rotate the cut. Clicking at the arrow and drag moves the cut. Clicking at the circle and drag rotates the cut.

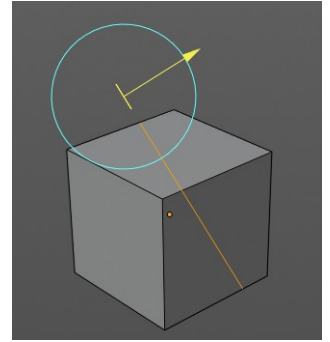

Tool Settings

Fill

Fills the cut.

Clear Inner

Removes the inner part of the face to cut.

Clear Outer

Removes the outer part of the face to cut.

Axis threshold

Axis threshold.

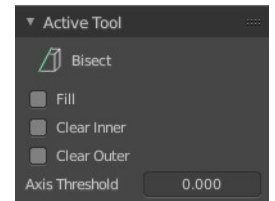

Last Operator Bisect

Plane Point X , Y , Z

Defines the start point of the Bisect cut.

Plane Normal X , Y , Z

The direction in which the bisect points.

Fill

Fills the cut.

Clear Inner

Removes the inner part of the face to cut.

Clear Outer

Removes the outer part of the face to cut.

Axis threshold

Axis threshold.

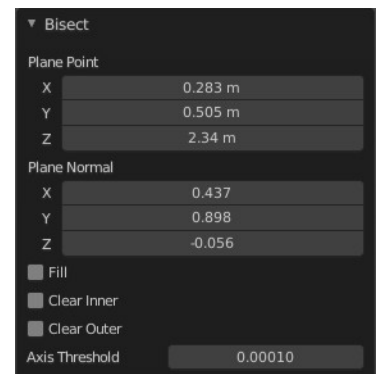

Poly Build

This tool extrudes out edges and faces from the border of existing open geometry.

The tool will not work at a cube, since here it cannot extrude out an existing polygon from a border. There is no border since the geometry is closed.

Usage:

Move the mouse over an edge until it turns blue. Then you can left click and drag to extrude it out.

Holding ctrl and clicking will extrude the last selected element to the mouse cursor. To extrude out an edge from a vertice don't click with left mouse. This would create a polygon. But with right mouse button.

Holding down shift allows you to mark vertices, edges or polygons that you want to remove. By clicking the selected geometry will be deleted.

You can just work at one edge at a time.

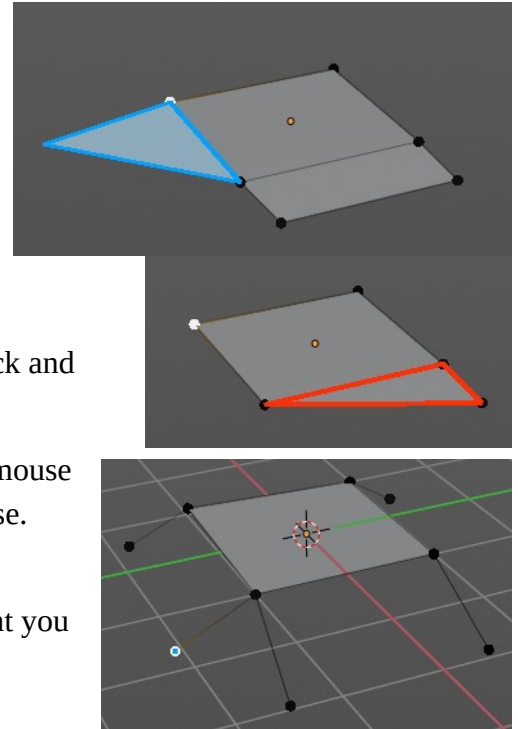

Tool Settings

Create Quads

Create quad or tri geometry.

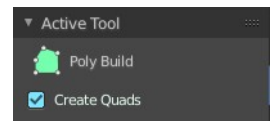

Last Operator

We have two last operators here, dependent of which method we use. Dragging out edges will reveal the Extrude At Cursor Move panel. Holding down CTRL will reveal the Face at Cursor Move panel.

Extrude At Cursor Move panel

Flip Normals

Flips the normals of the extruded faces.

Move X, Y Z

The position of the new created element. Attention, the actual world orientation and rotation does not matter here. It always starts with a value of zero, and moves relative to this zero then. For the actual location values have a look in the sidebar in the transform panel.

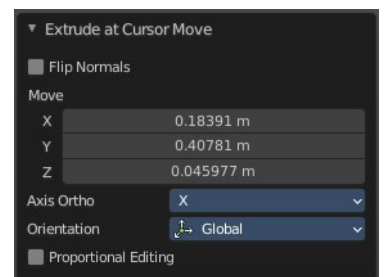

Orientation

The widget can have different orientations. The menu items should be self explaining.

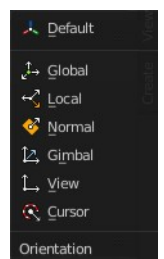

Face at Cursor Move panel

Move X, Y Z

The position of the new created element. Attention, the actual world orientation and rotation does not matter here. It always starts with a value of zero, and moves relative to this zero then. For the actual location values have a look in the sidebar in the transform panel.

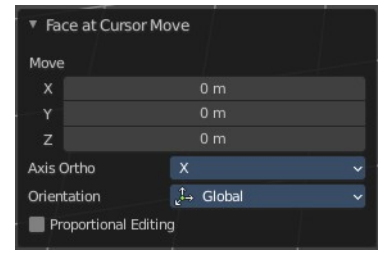

Orientation

The widget can have different orientations. The menu items should be self explaining.

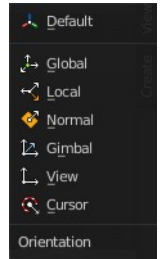

Proportional editing

Enables proportional editing. Activating proportional editing reveals further settings.

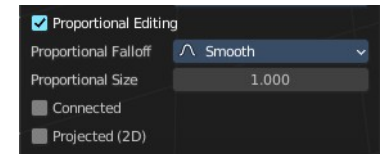

Proportional Falloff

Adjust the falloff methods.

Proportional Size

See and adjust the falloff radius.

Connected

The proportional falloff gets calculated for connected parts only.

Projected(2D)

The proportional falloff gets calculated in the screen space. Depth doesn't play a role. When it's in the radius, then it gets calculated.

Spin Tools Group

Spin

The Spin tool extrudes the selection and spins it by a defined amount and segments. This amount and number of segments can be adjusted.

When you activate the tool then you reveal some widgets with various handlers.

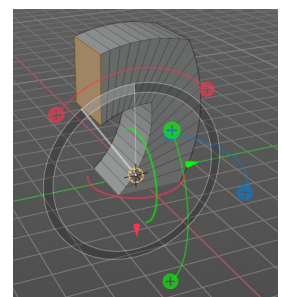
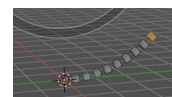
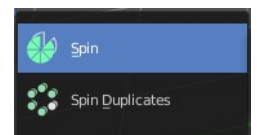

You can spin vertices, edges and faces. And even whole closed objects.

Usage

Select the geometry that you want to spin out. In our case we choose a face at a cube.

The first thing that you need to is to activate the correct Axis widget, which can be done in the Tool Settings. The ones with the big + buttons at the end defines in which direction the extrusion happens. And when you touch them then you start the spin extrusion. The rest of the widget functionality should be self explaining. You have handlers to pull and to rotate.

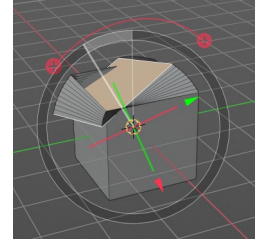

Hint, you activate all three axis widgets by holding down shift, and clicking at the axis buttons in the tool settings.

The second step is then to move the center of the spin to the desired location to get the rotation that you want. This can be done by the move handler. Or you click into the middle of the widget, at the white circle there, and drag it around.

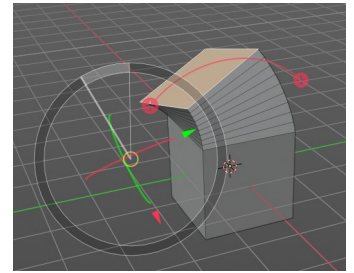

For an accurate rotation around a single axis you should work in one of the orthographic views.

Tool Settings

Steps

The number of divisions.

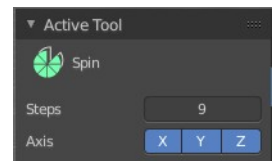

Axis

Activates the axis handler to perform the spin operation.

Hint, you activate all three axis widgets by holding down shift, and clicking at the axis buttons in the tool settings.

Last Operator Spin

Steps

Steps is the number of segments.

Duplicate

With duplicate checked the geometry gets duplicated instead of extruded.

Angle

Angle defines the angle of the spin.

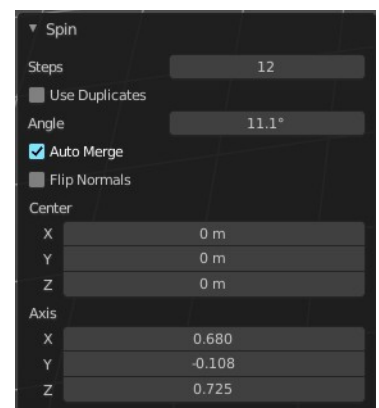
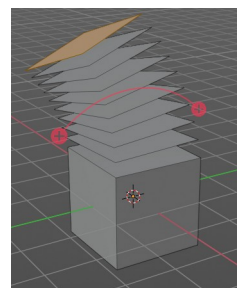

Center X Y Z

The Center edit boxes defines the center of the radius for the spin operation. In our example the X value is set to 2, and the Z value is set to 1.

Axis X Y Z

Axis defines the extrude direction. With X and Z values you can twist the result.

Spin Duplicate

Spin Duplicate is the exact same tool than Spin. It uses the same operator under the hood, and has no extra functionality. Not even the checkbox for duplicate is checked in the identical Adjust Last Operation Panel.

I think that this tool is meant to create duplicates by default. Simply use the Spin tool, and in the last operator panel tick Duplicate.

Smooth / Randomize Tools group

Smooth

Smoothens the selected vertices.

Usage

Activate the tool, move the mouse.

Tool Settings

Repeat

How often the smoothing should be applied.

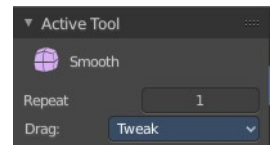

Drag

When you click at the widget of the active tool, then you perform the tool action. Adjust what should happen when you click outside of the widget, in the empty area.

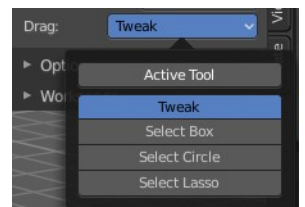

Active Tool

When you click off the widget then the click still does the same than clicking at the widget. It performs the active tool.

Tweak, Select Box, Circle and Lasso

When you choose this options then you will set the off click to the different select methods. Whereas tweak works more than a move tool then. Tweak is the default.

Last Operator Smooth Vertices

Smoothing

The smoothing factor.

Repeat

How often the smoothing should be applied.

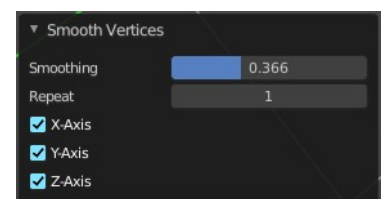

X Axis, Y Axis, Z Axis

Which axis to affect

Randomize

Randomizes the selected vertices.

Usage

Activate the tool, move the mouse.

Tool Settings

Uniform

Uniform offset. The higher the value the more uniform the offset becomes.

Normal

Align the random offset to the normals. This is a factor. 0 means no offset but completely random vertices positions. 1 means completely aligned with the normal axis, and just along this normal axis.

Random Seed

The seed for the randomization.

Drag

When you click at the widget of the active tool, then you perform the tool action. Adjust what should happen when you click outside of the widget, in the empty area.

Active Tool

When you click off the widget then the click still does the same than clicking at the widget. It performs the active tool.

Tweak, Select Box, Circle and Lasso

When you choose this options then you will set the off click to the different select methods. Whereas tweak works more than a move tool then. Tweak is the default.

Last Operator Smooth Vertices

Amount

The randomization amount.

Uniform

Uniform offset. The higher the value the more uniform the offset for all vertices becomes.

Normal

Align the random offset to the normals. This is a factor. 0 means no offset but completely random vertices positions. 1 means completely aligned with the normal axis, and just along this normal axis.

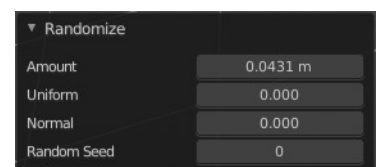
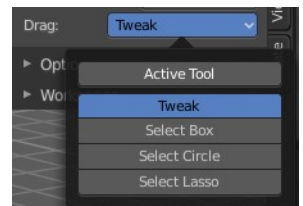
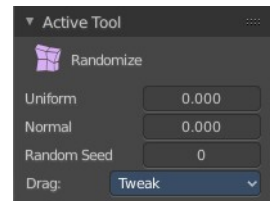

Random Seed

The seed for the randomization.

Edge and Vertex Slide Tools Group

Edge Slide

Edge Slide slides the selected edge along the face that it is part of. This is for the edge at a cube into two possible directions.

This tool requires to have at least one edge selected.

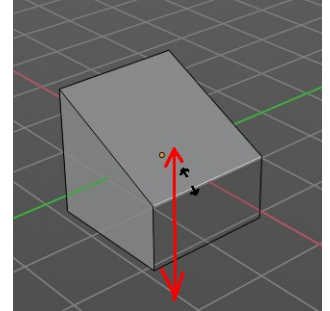
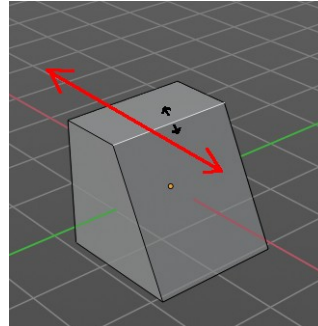

Header Values

The header values shows you the current transformation. But also hints towards a hotkey.

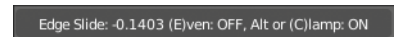

Holding down ALT will allow you to slide the edges behind the limits of the guide edge. Yellow infinite guide lines appears.

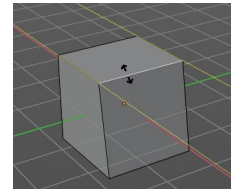

Tool Settings

Correct UV's

Correct UV's corrects the UV's while editing the geometry.

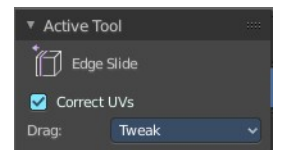

Drag

When you click at the widget of the active tool, then you perform the tool action. Adjust what should happen when you click outside of the widget, in the empty area.

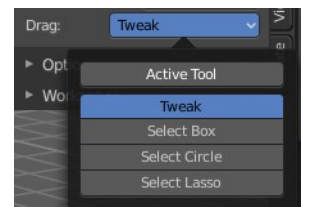

Active Tool

When you click off the widget then the click still does the same than clicking at the widget. It performs the active tool.

Tweak, Select Box, Circle and Lasso

When you choose this options then you will set the off click to the different select methods. Whereas tweak works more than a move tool then. Tweak is the default.

Last Operator Edge Slide

Factor

Factor is a sliding box Adjust the slide strength numerically. The width of the face is the 0-1 range.



Even

Make the Edge loop match the shape of the adjacent edge loop.

Flipped

When Even Mode is active, flips between the two adjacent edge loops.

Clamp

Clamp within the edge extend.

Correct UV's

Correct UV's corrects the UV's while editing the geometry.

Vertex Slide

Vertex Slide slides the selected vertice along the edge that it is part of. This is for the corner vertice at a cube into three possible directions.

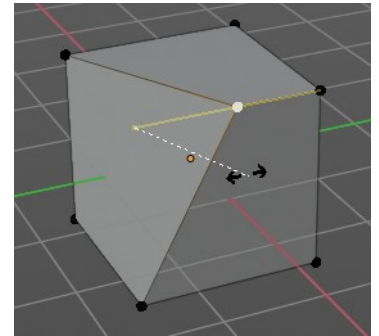

Header Values

The header values shows you the current transformation. But also hints towards a hotkey.

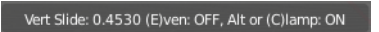

Holding down ALT will allow you to slide the edges behind the limits of the guide edge. Yellow infinite guide lines appears.

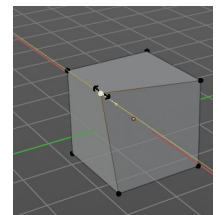

Tool Settings

Correct UV's

Correct UV's corrects the UV's while editing the geometry.

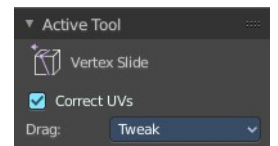

Drag

When you click at the widget of the active tool, then you perform the tool action. Adjust what should happen when you click outside of the widget, in the empty area.

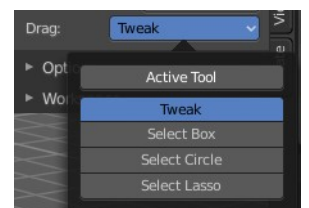

Active Tool

When you click off the widget then the click still does the same than clicking at the widget. It performs the active tool.

Tweak, Select Box, Circle and Lasso

When you choose this options then you will set the off click to the different select methods. Whereas tweak works more than a move tool then. Tweak is the default.

Last Operator Vertex Slide

Factor

Factor is a sliding box Adjust the slide strength numerically. The width of the face is the 0-1 range.

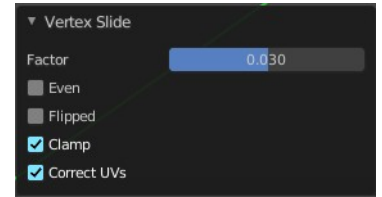

Even

Make the Edge loop match the shape of the adjacent edge loop.

Flipped

When Even Mode is active, flips between the two adjacent edge loops.

Clamp

Clamp within the edge extend.

Correct UV's

Correct UV's corrects the UV's while editing the geometry.

Shrink/Fatten / Push/Pull Tools Group

Shrink / Fatten

Shrink / Fatten shrinks or fattens the selection. The faces moves along the normals of the faces.

Header Values

The header values shows you the current transformation. But also hints towards a hotkey. Holding down ALT will turn off Even Thickness.

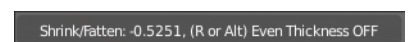

Tool Settings

Offset Even

Scales the offset to give more even thickness. Without this checked the farer away faces will have a bigger extrude amount.

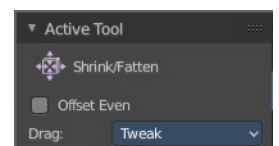

Drag

When you click at the widget of the active tool, then you perform the tool action. Adjust what should happen when you click outside of the widget, in the empty area.

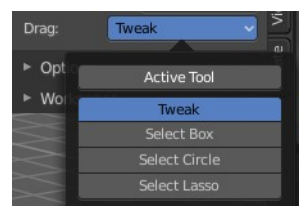

Active Tool

When you click off the widget then the click still does the same than clicking at the widget. It performs the active tool.

Tweak, Select Box, Circle and Lasso

When you choose this options then you will set the off click to the different select methods. Whereas tweak works more than a move tool then. Tweak is the default.

Last Operator Shrink/Fatten

Offset

The offset amount

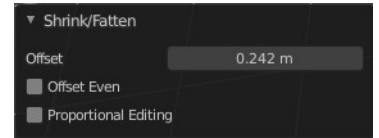

Offset Even

Scales the offset to give more even thickness. Without this checked the farer away faces will have a bigger extrude amount.

Proportional editing

Enables proportional editing. Activating proportional editing reveals further settings.

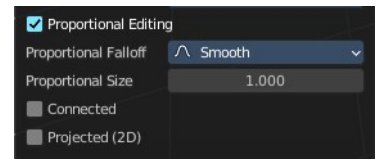

Proportional Falloff

Adjust the falloff methods.

Proportional Size

See and adjust the falloff radius.

Connected

The proportional falloff gets calculated for connected parts only.

Projected(2D)

The proportional falloff gets calculated in the screen space. Depth doesn't play a role. When it's in the radius, then it gets calculated.

Push/Pull

It pushes or pulls the selection relative to the center of the selection.

Header Values

The header values shows you the current transformation.

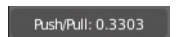

Tool Settings

Offset Even

Scales the offset to give more even thickness. Without this checked the farer away faces will have a bigger extrude amount.

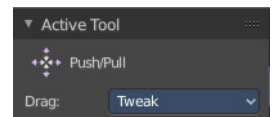

Drag

When you click at the widget of the active tool, then you perform the tool action.

Adjust what should happen when you click outside of the widget, in the empty area.

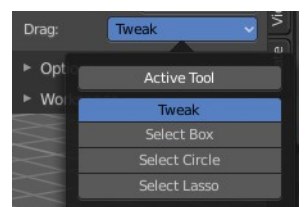

Active Tool

When you click off the widget then the click still does the same than clicking at the widget. It performs the active tool.

Tweak, Select Box, Circle and Lasso

When you choose this options then you will set the off click to the different select methods. Whereas tweak works more than a move tool then. Tweak is the default.

Last Operator Push/Pull

Distance

The push pull amount

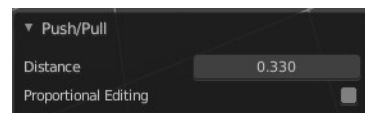

Proportional editing

Enables proportional editing. Activating proportional editing reveals further settings.

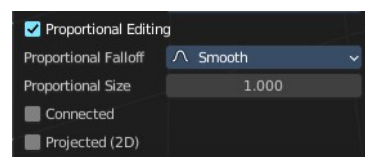

Proportional Falloff

Adjust the falloff methods.

Proportional Size

See and adjust the falloff radius.

Connected

The proportional falloff gets calculated for connected parts only.

Projected(2D)

The proportional falloff gets calculated in the screen space. Depth doesn't play a role. When it's in the radius, then it gets calculated.

Shear and To Sphere Tools Group

Shear

Shear shears the selection. When you activate the tool then you will reveal a widget. This widget allows you to shear the selection in all possible axis.

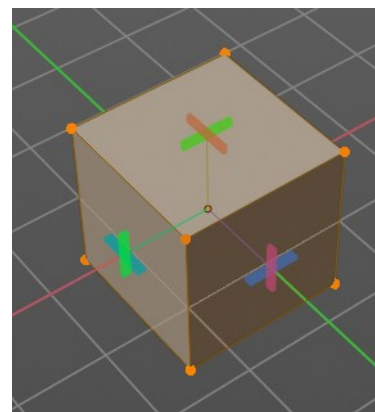

Tool Settings

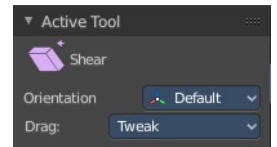

Orientation

Choose the orientation for the shear action.

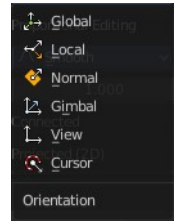

Drag

When you click at the widget of the active tool, then you perform the tool action. Adjust what should happen when you click outside of the widget, in the empty area.

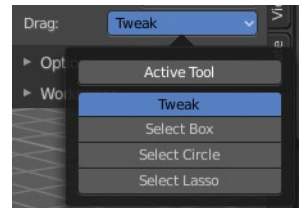

Active Tool

When you click off the widget then the click still does the same than clicking at the widget. It performs the active tool.

Tweak, Select Box, Circle and Lasso

When you choose this options then you will set the off click to the different select methods. Whereas tweak works more than a move tool then. Tweak is the default.

Last Operator Shear

Offset

Adjust an offset.

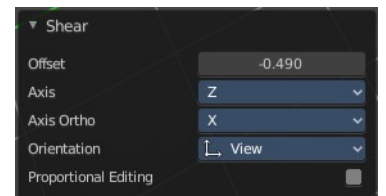

Axis

Defines one axis of the imaginary shear axis plane.

Axis Ortho

Defines the other axis of the imaginary shear axis plane.

Orientation

Choose the orientation for the shear action.

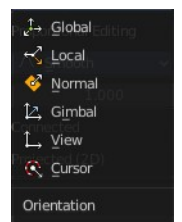

Proportional editing

Enables proportional editing. Activating proportional editing reveals further settings.

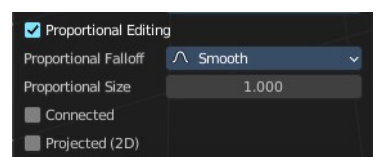

Proportional Falloff

Adjust the falloff methods.

Proportional Size

See and adjust the falloff radius.

Connected

The proportional falloff gets calculated for connected parts only.

Projected(2D)

The proportional falloff gets calculated in the screen space. Depth doesn't play a role. When it's in the radius, then it gets calculated.

To Sphere

Shapes a selection of objects into the shape of a sphere. The calculation happens with the object origins.

In Object mode this tool requires to have more than one object selected.

Usage

Select the vertices, activate the tool, then drag the mouse in the 3D viewport. In the header you will read the current factor then. Which tells you how close you are towards the sphere shape.

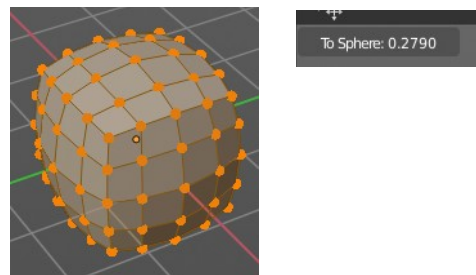

Last Operator To Sphere Panel

Factor

The factor to transform the selection into a shape form.

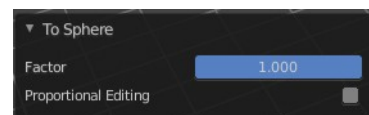

Proportional editing

Enables proportional editing. Activating proportional editing reveals further settings.

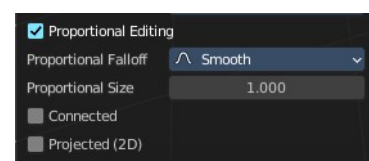

Proportional Falloff

Adjust the falloff methods.

Proportional Size

See and adjust the falloff radius.

Connected

The proportional falloff gets calculated for connected parts only.

Projected(2D)

The proportional falloff gets calculated in the screen space. Depth doesn't play a role. When it's in the radius, then it gets calculated.

Rip Tools Group

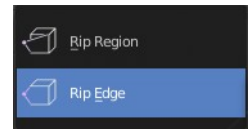

Rip Vertices

Rip splits the edges between the selected vertices. It creates two edges out of one.

This tool works similar to the Edge Split tool. It also selects the outer edges so that you immediately move them. Right click will snap them back to the initial space.

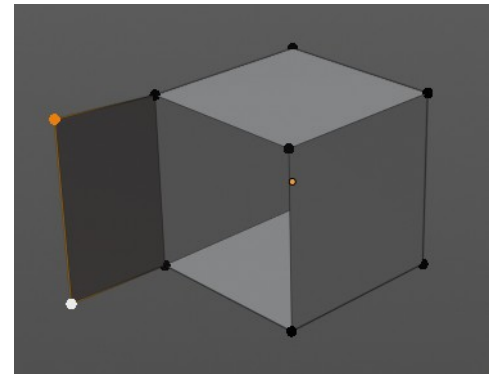

Tool Settings

Fill

Fills the gap between the new edges when you move the geometry.

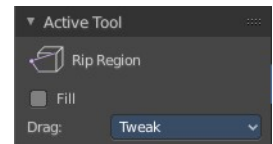
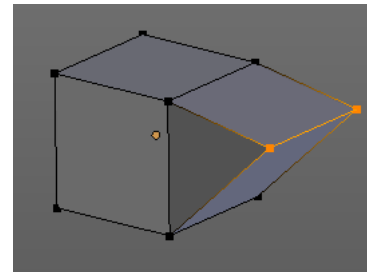

Drag

When you click at the widget of the active tool, then you perform the tool action. Adjust what should happen when you click outside of the widget, in the empty area.

Active Tool

When you click off the widget then the click still does the same than clicking at the widget. It performs the active tool.

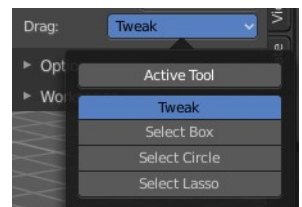

Tweak, Select Box, Circle and Lasso

When you choose this options then you will set the off click to the different select methods. Whereas tweak works more than a move tool then. Tweak is the default.

Last Operator Rip

Move X , Y , Z

Adjust the position.

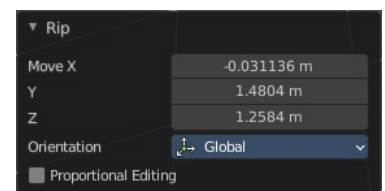

Constraint Axis

Limit the position relative to the source object.

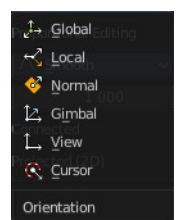

Orientation

Orientation is a drop-down box. Choose the type of orientation for the mirroring action.

Proportional editing

Enables proportional editing. Activating proportional editing reveals further settings.

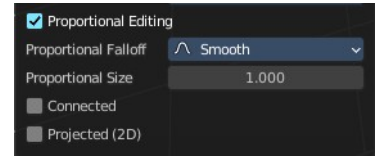

Proportional Falloff

Adjust the falloff methods.

Proportional Size

See and adjust the falloff radius.

Connected

The proportional falloff gets calculated for connected parts only.

Projected(2D)

The proportional falloff gets calculated in the screen space. Depth doesn't play a role. When it's in the radius, then it gets calculated.

Rip Edge

Rip Edge extrudes out the selected vertices. When you do this operation at an edge then you will create N-Gons that way.

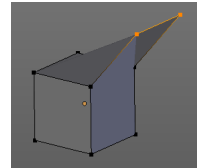

Tool Settings

Drag

When you click at the widget of the active tool, then you perform the tool action. Adjust what should happen when you click outside of the widget, in the empty area.

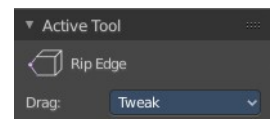

Active Tool

When you click off the widget then the click still does the same than clicking at the widget. It performs the active tool.

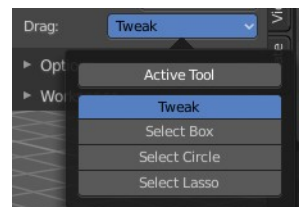

Tweak, Select Box, Circle and Lasso

When you choose this options then you will set the off click to the different select methods. Whereas tweak works more than a move tool then. Tweak is the default.

Last Operator Extend Vertices

Move X , Y , Z

Adjust the position.

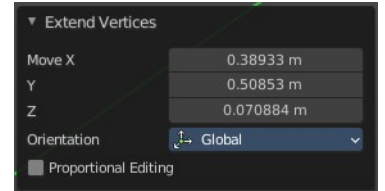

Constraint Axis

Limit the position relative to the source object.

Orientation

Orientation is a drop-down box. Choose the type of orientation for the mirroring action.

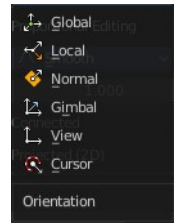

Proportional editing

Enables proportional editing. Activating proportional editing reveals further settings.

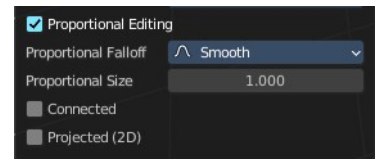

Proportional Falloff

Adjust the falloff methods.

Proportional Size

See and adjust the falloff radius.

Connected

The proportional falloff gets calculated for connected parts only.

Projected(2D)

The proportional falloff gets calculated in the screen space. Depth doesn't play a role. When it's in the radius, then it gets calculated.



7.2.20 Editors - 3D Viewport - Tool Shelf - Hair Curve - Sculpt Mode

Table of content

Tool Shelf - Hair Curve - Sculpt mode.....	1
Annotate tools.....	1
Brush cursor.....	2
Brush settings.....	2
Hotkeys.....	2
Symmetry.....	3
Tool Shelf - Hair Curve - Sculpt mode - Brushes.....	3
Selection Paint.....	3
Comb.....	3
Add.....	3
Delete.....	3
Snake Hook.....	3
Grow/Shrink.....	4
Pinch.....	4
Smooth.....	4
Puff.....	4
Density.....	4
Slide.....	4

Tool Shelf - Hair Curve - Sculpt mode

In Sculpt mode with a hair curve object selected, you will find mainly brushes in the tool shelf. This mode is used for styling hair curves with various tools, including adding, combing and more.

Hair Curve Sculpting is a process to deform hair strands by using brushes.

Annotate tools

The annotate tools at the end of the list are explained in the chapter 7.1.1 Editors - 3D View - Tool Shelf - Object Mode. We won't cover this tools again here.



Brush cursor

When you activate one of the brushes then the mouse cursor turns into a brush cursor. This cursor represents the size of the current brush.

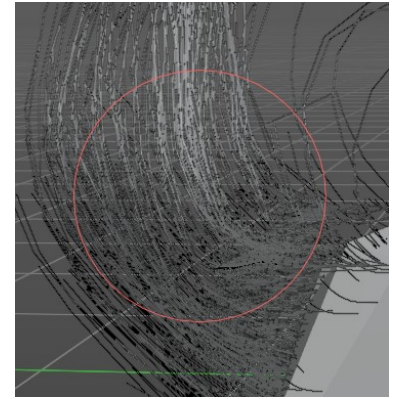

Brush settings

The different brushes settings can be found in the sidebar in the tools tab. Or in the properties editor in the Active Tool and Workspace settings tab. Or above the header area.

The different brushes settings in the Active Tool and Workspace settings are explained in the chapter **7.3.16 Editors - 3D Viewport - Sidebar - Tool Tab - Hair Curve - Sculpt Mode**.

We won't cover this chapters again, but just explain what the different brushes do in this mode.

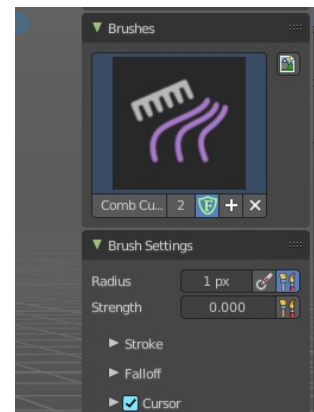
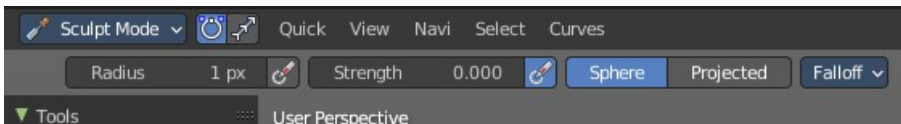

Hotkeys

Pressing **X** allows you to change the brush size onscreen. Drag the mouse to increase or decrease the size. Left click applies the new size, right click cancels the resizing.

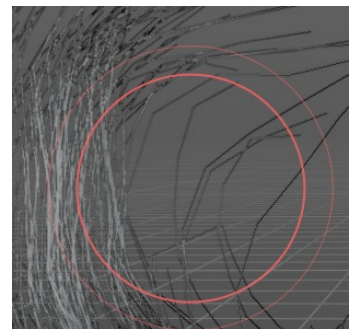

Pressing **C** allows you to change the strength of the brush. Drag the mouse to increase or decrease the size. Left click applies the new size, right click cancels the resizing.

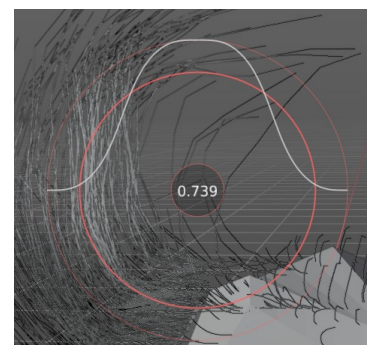

Symmetry

Note that the sculpting mode starts with Symmetry off. You can turn this on per the desired axis from in the tool header.

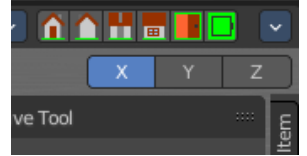

Tool Shelf - Hair Curve - Sculpt mode - Brushes

Selection Paint

This brush draws a selection mask to aid in isolating strands. Isolated control points are lighter grey, and locked control points are dark grey.

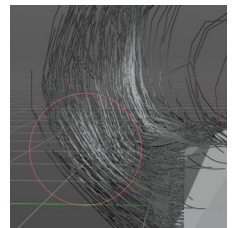

Comb

The comb brush acts like a true hair comb to pull strands at an angle. Click and hold it to pull strands with the comb.

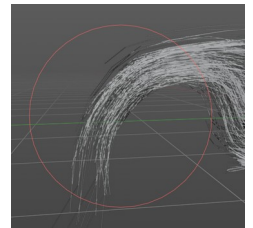

Add

This brush adds hair strands at a set density onto the mesh. Useful for painting new hair. When you add an “Empty Hair” curve object, there will be no hair till you add strands.

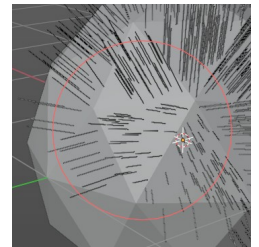

Delete

This brush completely removes any hair curves from the surface.

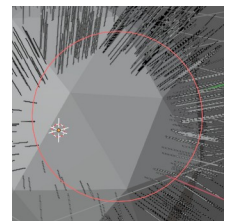

Snake Hook

This brush grows hair and extends it with the brush stroke, creating a flow of hair curves. This is useful for quickly styling general hair shapes.

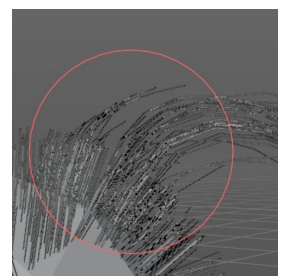

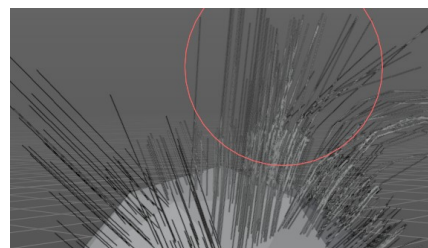

Grow/Shrink

This brush grows existing hair or inversely shrinks it. Useful for extending hair without reshaping it.

Pinch

This brush pulls hair curves together towards the center of the brush. Useful for hair clumping.

#

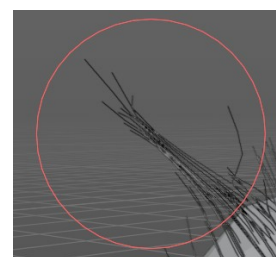

Smooth

This brush smooths out the hair curves and removes kinks and crinkles. Useful to straighten and relax hair strands.

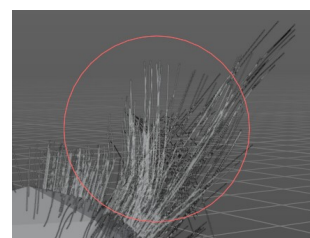

Puff

This brush pushes out the hair strand from the root by pushing a force on the tips. This is useful to add volume to hair.



Density

Adds more hair strands and increases the density.

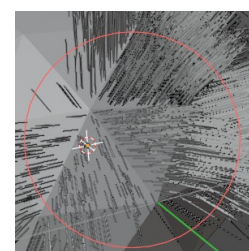

Slide

This is similar to the grab brush in Mesh Sculpt Mode, this pulls the root and control points of the hair curves over the surface to a new location.

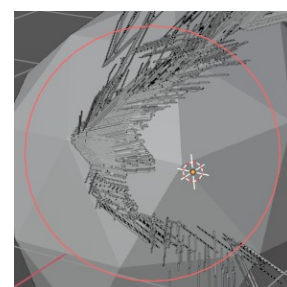



7.2.3 Editors - 3D Viewport - Tool Shelf - Mesh - Sculpt Mode

Table of content

Tool Shelf - Mesh - Sculpt Mode.....	4
Transform and Annotate tools.....	4
Brush cursor.....	4
Brushes settings.....	4
Hotkeys.....	5
Symmetry.....	5
Draw.....	5
Draw Sharp.....	5
Clay.....	5
Clay Strips.....	5
Clay Thumb.....	5
Layer.....	6
Inflate.....	6
Blob.....	6
Crease.....	6
Smooth.....	6
Flatten.....	6
Fill.....	6
Scrape.....	6
Multiplane Scrape.....	6
Pinch.....	6
Grab.....	7
Elastic Deform.....	7
Snake Hook.....	7
Thumb.....	7
Pose.....	7
Nudge.....	7
Rotate.....	7
Slide Relax.....	7
Boundary.....	7
Cloth.....	8
Simplify.....	8
Mask.....	8
Draw Face Sets.....	8
Multires Displacement Eraser.....	8
Multires Displacement Smear.....	9
Paint.....	9
Smear.....	9
Mask selection tools group.....	9
Box Mask, Lasso Mask and Line Mask.....	9
Active Tool setting.....	9
Front Faces only.....	9
Limit to Segment.....	9
Box Hide.....	9
Box / Lasso Faceset tools group.....	10
Box Face Sets.....	10
Tool Settings.....	10

Front faces only.....	10
Lasso Face Sets.....	10
Tool Settings.....	10
Front faces only.....	10
Box Trim / Lasso Trim tools group.....	10
Box Trim.....	10
Tool Settings.....	10
Trim Mode.....	11
Extrude Mode.....	11
Use Cursor Depth.....	11
Lasso Trim.....	11
Tool Settings.....	11
Trim Mode.....	11
Shape Orientation.....	11
Extrude Mode.....	11
Use Cursor Depth.....	11
Line Project.....	11
Tool Settings.....	11
Mesh Filter.....	12
Usage.....	12
Adjust Last Operator Filter Mesh.....	12
Strength.....	12
Repeat.....	12
Orientation.....	12
Deform Axis.....	12
Tool Settings.....	12
Filter Type.....	12
Smooth.....	12
Scale.....	12
Inflate.....	13
Sphere.....	13
Random.....	13
Relax.....	13
Relax Face Sets.....	13
Surface Smooth.....	13
Shape preservation.....	13
Per Vertex Displacement.....	13
Sharpen.....	13
Smooth Ratio.....	13
Intensity Details.....	13
Curvature Smooth Iterations.....	13
Strength.....	13
Deform Axis.....	13
Cloth Filter.....	13
Tool Settings.....	14
Filter Type.....	14
Strength.....	14
Force Axis.....	14
Orientation.....	14
Cloth Mass.....	14
Cloth Damping.....	14
Use Face Sets.....	14
Use Collisions.....	14

Color Filter.....	14
Tool Settings.....	15
Filter Type.....	15
Strength.....	15
Edit Face Sets.....	15
Tool Settings.....	15
Mode.....	15
Modify Hidden.....	15
Mask by Color.....	15
Tool Settings.....	15
Threshold.....	15
Contiguous.....	16
Invert.....	16
Preserve Previous Mask.....	16

Tool Shelf - Mesh - Sculpt Mode

In Sculpt mode with a mesh object you will find mainly brushes in the tool shelf.

Transform and Annotate tools

The transform and annotate tools at the end of the list are explained in the chapter 7.1.1 Editors - 3D View - Tool Shelf - Object Mode. We won't cover this tools again here.

Brush cursor

When you activate one of the brushes then the mouse cursor turns into a brush cursor. This cursor represents the size of the current brush. It aligns to the surface under the mouse. When you start to draw then the brush cursor will disappear except for one little yellow dot in the center.

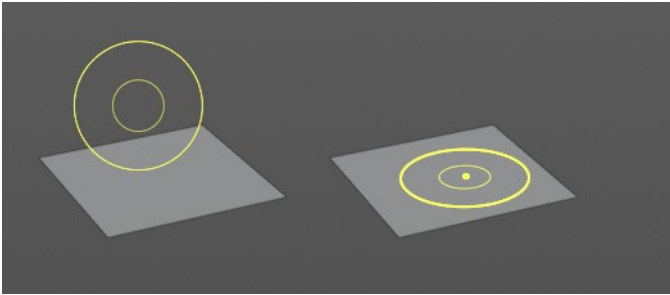

Brushes settings

The different brushes settings can be found in the sidebar in the tools tab. Or in the properties editor in the Active Tool and Workspace settings tab. Or above the header area.

The different brushes settings in the Active Tool and Workspace settings are explained in the chapter 25.1 Editors - Properties Editor - Tools Tab.

We won't cover this chapters again, but just explain what the different brushes does.

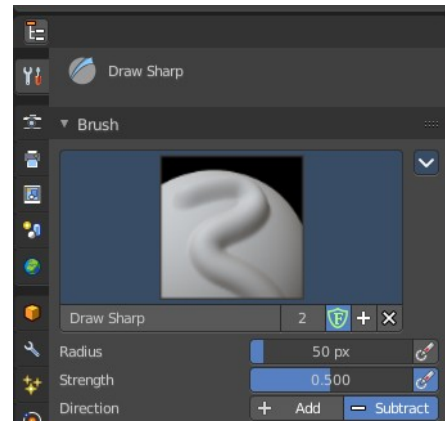
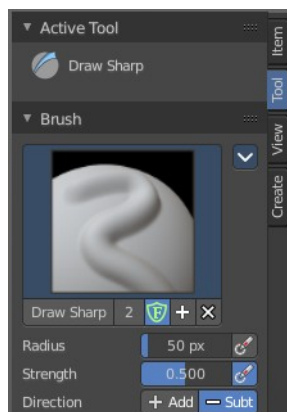
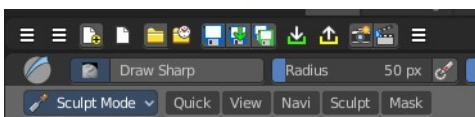

Hotkeys

Pressing **X** allows you to change the brush size onscreen. Drag the mouse to increase or decrease the size. Left click applies the new size, right click cancels the resizing.

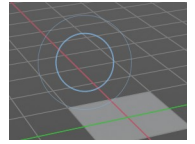

Pressing **C** allows you to change the strength of the brush. Drag the mouse to increase or decrease the size. Left click applies the new size, right click cancels the resizing.

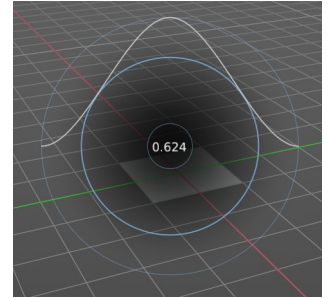

Symmetry

Note that the sculpting mode starts with Symmetry in X axis on. You can turn this off up right in the header.

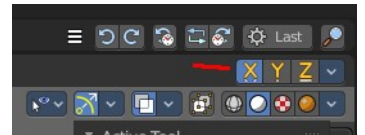

Draw

Draws a stroke.

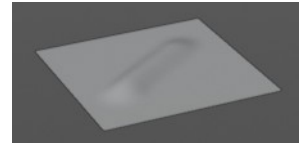

Draw Sharp

Draws a negative stroke. In the Brush panel you will see that the direction is set to subtract instead of add. But you can also set it to add. This brush is a bit sharper than the Draw brush.

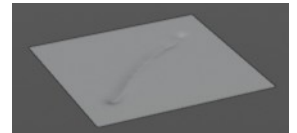

Clay

Draws a stroke. The pencil reacts different than with draw. It's more like sculpting, not so much like drawing, and deforms the surface also more in a sculpting style. The brush has a pretty weak effect in its default settings.

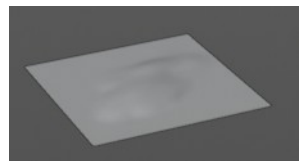

Clay Strips

Draws little strips on top of each other.

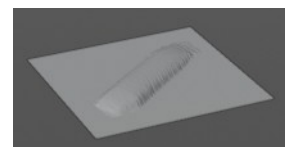

Clay Thumb

Draws like you would use the thumb.

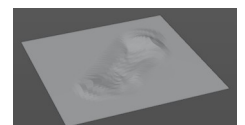

Layer

Adds a layer stroke with a predefined height. This height can be adjusted with the height slider in the Brushes panel.

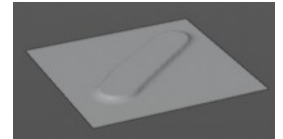

Inflate

Inflates or deflates existing strokes. See Inflate/Deflate setting in the Brush panel.

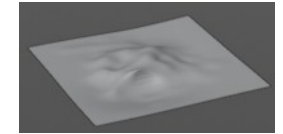

Blob

Reacts pretty similar to Draw. It draws a stroke.

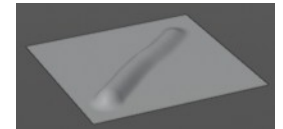

Crease

Draws a negative stroke.

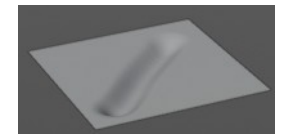

Smooth

Smoothens the surface.

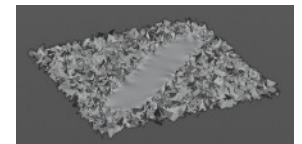

Flatten

Flattens the surface.

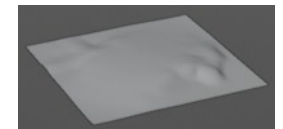

Fill

Tries to fill the valley between two hill strokes. Hard to see in the shot. And the default values have a very weak influence.

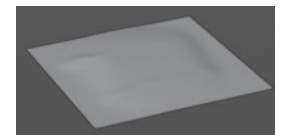

Scrape

As the name says. With this brush you can scrape.

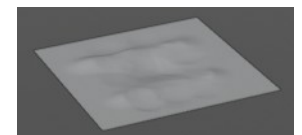

Multipane Scrape

As the name says. With this brush you can scrape. But this brush takes different surface angles into account.

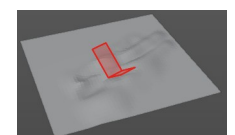

Pinch

Pinches existing strokes. Hard to see in the shot. What happens is that the stroke at the top becomes much sharper.

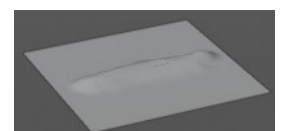

Grab

Allows you to grab a portion of the sculpt mesh and drag it around.

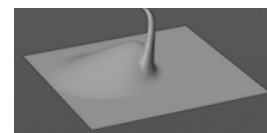

Elastic Deform

Allows you to grab a portion of the sculpt mesh and drag it around. This brush tries to preserve the volume of closed meshes. So it's best used at a closed geometry.

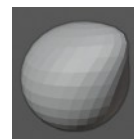

Snake Hook

Allows you to grab a portion of the sculpt mesh and drag it around. The tool reacts a bit different than the Grab tool.

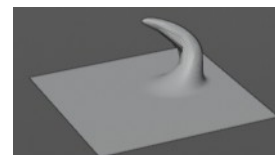

Thumb

Allows you to pull geometry around than you would press your thumb into the clay.

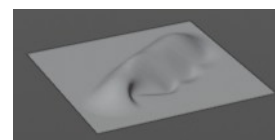

Pose

Allows you to pose the geometry under the brush by rotating it freely.

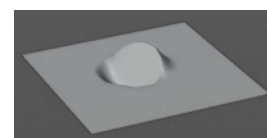

Nudge

Nudges the geometry. Drag it sideways.

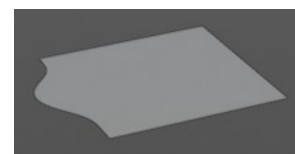

Rotate

Rotates the geometry under the brush, aligned with the brush alignment.

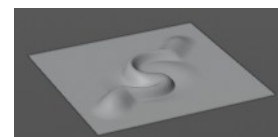

Slide Relax

Allows you to relax the surface in drag direction by dragging with the mouse over it.

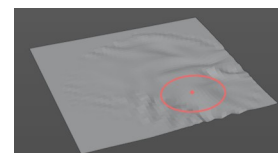

Boundary

Allows to deform the boundary geometry in various modes.

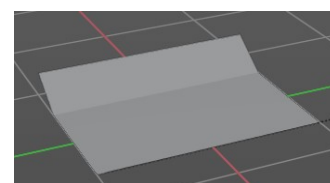

Cloth

The cloth brush allows you to crumple the surface like it would be a piece of cloth.

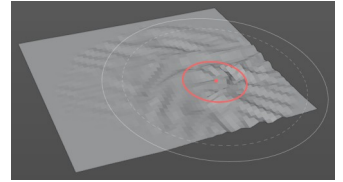

Simplify

Has no effect on quad geometry. This tool is of interest for Dyntopo sculpting. It simplifies the geometry, using the less dense areas as reference.

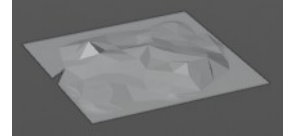

Mask

Allows you to mask out specific parts of the mesh by painting it black. Black means no sculpt stroke possible in this area.

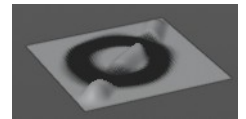

In the Brush panel you can negate the effect. And remove the mask by repainting over it with Direction set to Subtract.

The mask menu in the header provides you with further functionality like clear and invert the mask.

Draw Face Sets

Allows you to draw so called faces set areas. It is some kind of a permanent mask. Every drawn face set gets a random color assigned. This face sets can then be manipulated with the Mesh Filter tool. Or you can use them to hide the parts away that you don't want to sculpt at the moment.

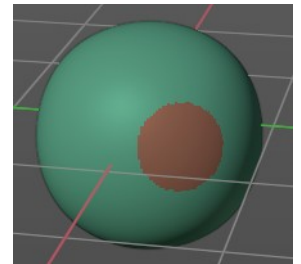

Holding Shift will relax or smooth the edges of the Face Sets.

Holding Ctrl will continue drawing the same Face Set as the one under the cursor.

Once you have painted Face Sets, the Face Set beneath your mouse pointer can be hidden by pressing the H hotkey.

Hotkey Shift H hides all Face Sets but the one under your mouse pointer. See also the Face Sets menu.

To reset all face sets choose Face Sets from Visible in the Face Sets menu, followed by Randomize Color. This should clear all colors.

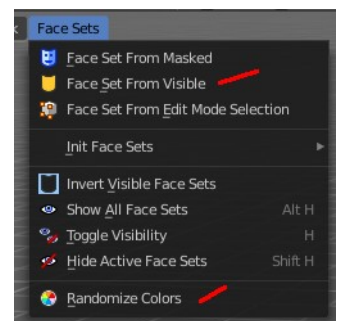

Multires Displacement Eraser

Deletes the displacement information of the Multires Modifier. And resets the mesh to the subdivision limit surface.

Use case is to delete parts of the sculpt or to fix reprojection artifacts after applying a Shrinkwrap Modifier.

Multires Displacement Smear

Moves Multires displacement over the surface. This works like smearing a displacement texture. The brush can be used continually without creating topology artifacts.

Paint

Paint over vertex colors. Note that this feature is not supported when you work in Dynatopo.

Smear

Smears painted vertex colors. Note that this feature is not supported when you work in Dynatopo.

Mask selection tools group

Box Mask, Lasso Mask and Line Mask

Allows you to mask out specific parts of the mesh by selecting mesh parts, and mask them with black. Black means no sculpt stroke possible in this area.

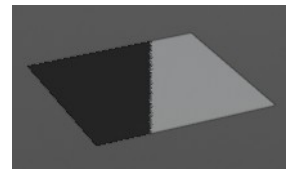
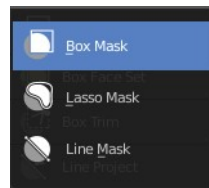

This tool is different from the mask brush not brushes, but select tools. Box mask and Lasso mask behaves like the general box and lasso select methods. To subtract hold down ctrl. Line mask selects along a line.

The mask menu in the header provides you with further functionality like clear and invert the mask.

Active Tool setting

Front Faces only

Affect only the faces that points to the front.

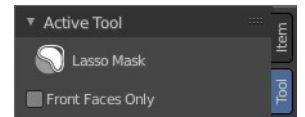
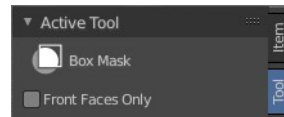

Limit to Segment

Line mask only. Affect only the current segment.

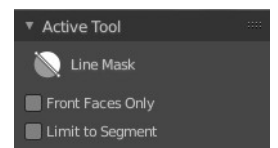

Box Hide

This tool allows you to box select parts of the mesh that gets hidden then. To reveal hidden mesh parts left click anywhere.

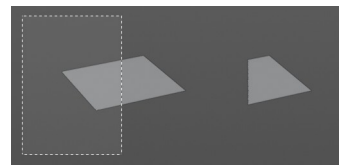

Box / Lasso Faceset tools group

Allows to select faces and apply a face set to it.

Box Face Sets

Box select an area of the mesh to apply a face set.

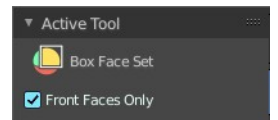
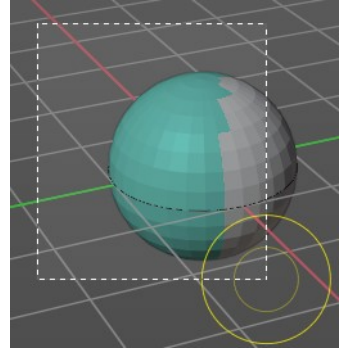

Tool Settings

Front faces only

Only affect the front faces.

Lasso Face Sets

Lasso select an area of the mesh to apply a face set.

Tool Settings

Front faces only

Only affect the front faces.

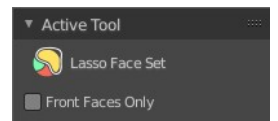

Box Trim / Lasso Trim tools group

Trim the geometry with a rectangle or lasso.

Box Trim

Tool Settings

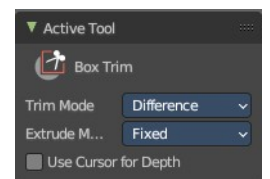
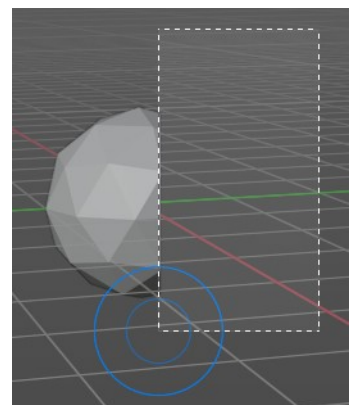

Trim Mode

What trim method to choose. Trim uses a boolean method. You have the choice between difference, union and join.



Extrude Mode

How to deal with extrude.

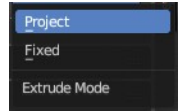

Use Cursor Depth

Use cursor location and radius for the dimensions and position of the trimming shape.

Lasso Trim

Tool Settings

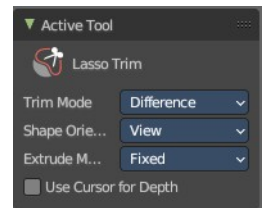

Trim Mode

What trim method to choose. Trim uses a boolean method. You have the choice between difference, union and join.

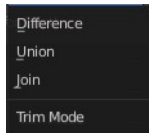

Shape Orientation

Use the view or the surface of the object to orientate the trimming shape.

Extrude Mode

How to deal with extrude.

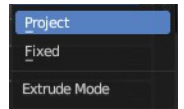

Use Cursor Depth

Use cursor location and radius for the dimensions and position of the trimming shape.

Line Project

Cuts away part of the mesh along a line.

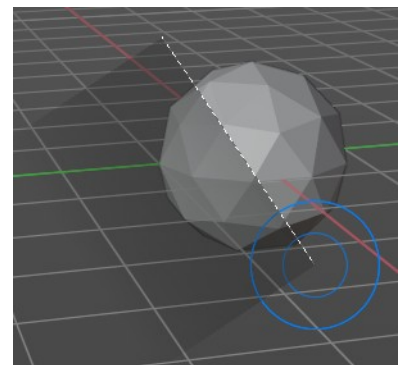

Tool Settings

Apply the action only to the current segment.

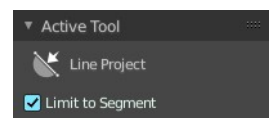

Mesh Filter

Apply a Mesh Filter Type. Mesh filters are something like deform modifiers.

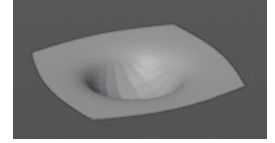

Usage

Choose the filter type that you want to apply in the Tool Settings panel. Then drag with the mouse to adjust the amount.

To work with Face Sets first tick Use Face Sets in the Active Tool panel. Then hover the mouse over the Face Set that you want to manipulate. Then drag with the mouse to adjust the amount.

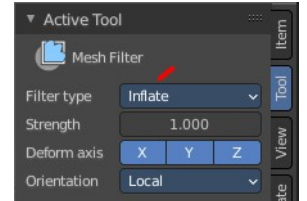

You have to adjust everything beforehand. This tool has no last operator.

Adjust Last Operator Filter Mesh

Strength

Filter Strength.

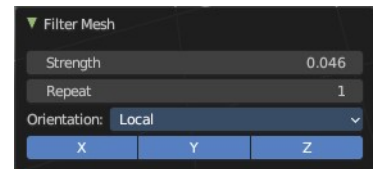

Repeat

How many times to repeat the filter

Orientation

Orientation of the axis to limit the filter displacement.

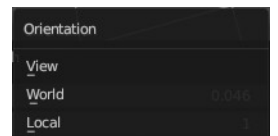

Deform Axis

Which axis to affect by the deformation.

Tool Settings

Filter Type

Smooth

Smoothens the surface.

Scale

Scales the surface.

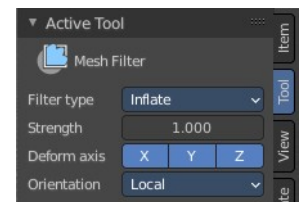

Inflate

Inflates the surface.

Sphere

Forms the surface to a sphere.

Random

Randomizes the vertices positions.

Relax

Relaxes the mesh.

Relax Face Sets

Smooth the edges of all face sets.

Surface Smooth

Smooth the surface of the mesh, preserving the volume.



Shape preservation

How much of the original mesh is preserved when smoothing.

Per Vertex Displacement

How much the position of each individual vertex influences the final result.

Sharpen

Sharpen the cavities of the mesh.



Smooth Ratio

How much smoothing is applied to polished surface.

Intensity Details

How much creases and valleys are intensified.

Curvature Smooth Iterations

How smooth the resulting shape is. This feature ignores high frequency details.

Strength

The strength of the effect.

Deform Axis

Limit the effect to single world axis.

Cloth Filter

Applies a cloth filter type.

Choose the filter type that you want to apply in the Tool Settings panel. Then drag with the mouse to adjust the amount.

You have to adjust everything beforehand. This tool has no last operator.

Tool Settings

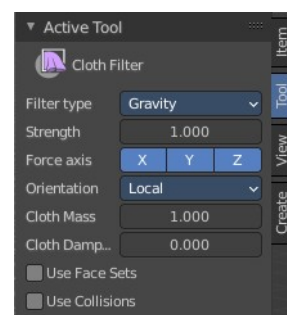

Filter Type

The cloth filter type.

Strength

The filter strength.

Force Axis

Apply the force in the selected axis.

Orientation

Orientation of the axis to limit the filter force. Local, World or View.

Cloth Mass

Mass of each simulation particle

Cloth Damping

How much the applied forces are propagated through the cloth.

Use Face Sets

Use an existing face set under the mouse for the cloth filter brush.

Use Collisions

Collide with other collider objects in the scene.

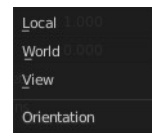
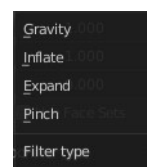

Color Filter

Applies a filter to modify the current sculpt vertex colors.

Tool Settings

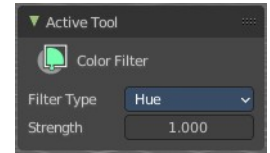

Filter Type

What kind of filter to apply to the vertex colors.

Strength

The strength of the filter.

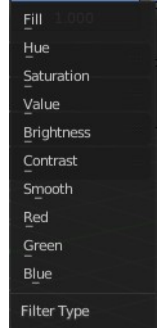

Edit Face Sets

Allows you to grow or shrink the face set under the mouse.

Tool Settings

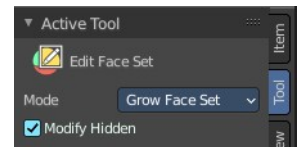

Mode

Grow or shrink.

Modify Hidden

Affect hidden face sets too.

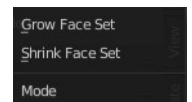

Mask by Color

Creates a mask from the sculpt vertex colors under the mouse.

Tool Settings

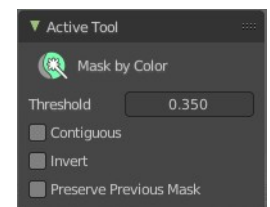

Threshold

How much changes in color affect the mask generation. Or in other words, the threshold after which the color gets count as an equal color to the current vertex color under the mouse to mask this color out.

Contiguous

Only mask out color parts that are connected.

Invert

Invert the generated mask.

Preserve Previous Mask

Add to or subtract from the current color mask.



7.2.4 Editors - 3D Viewport - Tool Shelf - Mesh - Vertex Paint Mode

Table of content

Tool Shelf - Mesh - Vertex Paint Mode.....	1
Annotate tools.....	1
Brush cursor.....	1
Brushes settings.....	2
Symmetry.....	2
Hotkeys.....	2
Draw.....	2
Add.....	3
Darken.....	3
Draw.....	3
Lighten.....	3
Mix.....	3
Multiply.....	3
Subtract.....	3
Blur.....	3
Average.....	3
Smear.....	3

Tool Shelf - Mesh - Vertex Paint Mode

In Vertex Paint mode with a mesh object you will find mainly brushes in the tool shelf. Vertex painting allows you to paint the vertices of a mesh object with a specific color. This can then be used in various ways. As direct painting without any UV mapping. Or for some special calculations. There is a shader node that reads the vertex color values.



Annotate tools

The annotate tools at the end of the list are explained in the chapter 7.1.1 Editors - 3D View - Tool Shelf - Object Mode. We won't cover these tools again here.

Brush cursor

When you activate one of the brushes then the mouse cursor turns into a brush cursor. This cursor represents the size of the current brush. It does not align with the surface under the mouse. But always faces towards you.

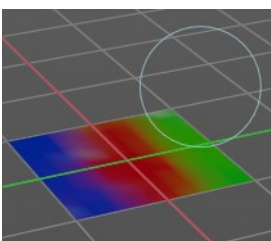

Brushes settings

The different brushes settings can be found in the sidebar in the tools tab. Or in the properties editor in the Active Tool and Workspace settings tab. Or above the header area.

The different brushes settings in the Active Tool and Workspace settings are explained in the chapter 25.1.4 Editors - Properties Editor - Tools Tab - Vertex Paint Mode

We won't cover this chapters again, but just explain what the different brushes does.

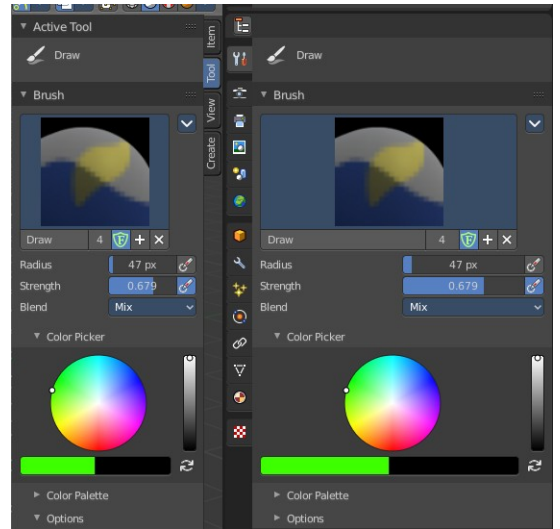
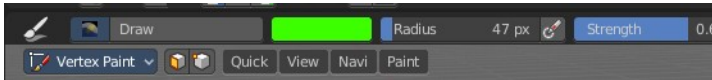

Symmetry

You can enable Symmetry painting up right in the header.

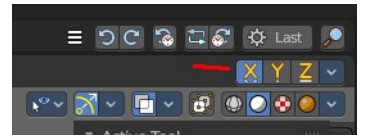

Hotkeys

Pressing F allows you to change the brush size on-screen. Drag the mouse to increase or decrease the size. Left click applies the new size, right click cancels the resizing.

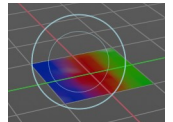

Pressing Shift F allows you to change the strength of the brush. Drag the mouse to increase or decrease the size. Left click applies the new size, right click cancels the resizing.

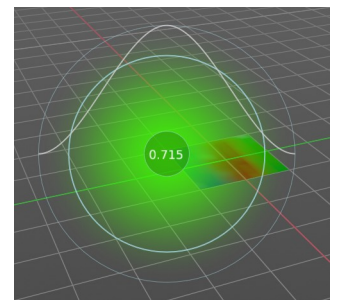

Draw

Draws a stroke. The Draw tool has several sub brushes in the Brush panel. The names of the brushes are pretty self explaining.

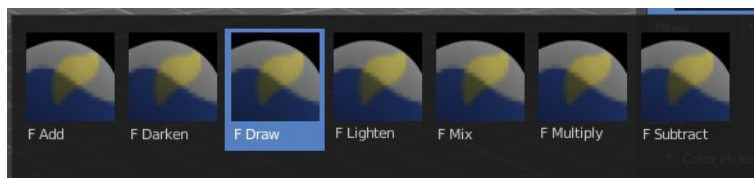

Add

The specified weight value is added to the vertex weights. The strength determines which fraction of the weight gets added per stroke. But the brush will not paint weight values above 1.0.

Darken

Darkens the current colour at the vertices down to the specified target value. Only weights above the target weight are affected. Weights below the target weight remain unchanged.

Draw

Draws a stroke.

Lighten

Lightens the current colour at the vertices up to the specified target value. Only weights below the target weight are affected. Weights above the target weight remain unchanged.

Mix

Mix the colour that you draw with the background colour.

Multiply

Multiplies the colour that you draw with the background colour.

Subtract

Removes the colour from the vertex with drawing.

Blur

Smooths out the colours of adjacent vertices. In this mode the Colour Value is ignored. The strength defines how much the colours are blurred.

Average

Smooths colour by painting the average resulting colour from all colours under the brush.

Smear

Smudges colours by grabbing the colours under the brush and “dragging” them.



7.2.5 Editors - 3D Viewport - Tool Shelf - Mesh - Weight Paint Mode

Table of content

Tool Shelf - Mesh - Weight Paint Mode.....	1
Transform and Annotate tools.....	2
Brush cursor.....	2
Brushes settings.....	2
Symmetry.....	3
Hotkeys.....	3
Draw.....	3
Add.....	3
Darken.....	4
Draw.....	4
Lighten.....	4
Mix.....	4
Multiply.....	4
Subtract.....	4
Blur.....	4
Average.....	4
Smear.....	4
Gradient.....	4
Tool Settings.....	5
Weight.....	5
Strength.....	5
Type.....	5
Falloff.....	5
Curve Presets.....	5
Selecting Points.....	5
Adding Points.....	6
Navigation elements.....	6
Zoom in and out.....	6
Tools.....	6
Reset View.....	6
Vector Handle.....	6
Auto Handle.....	6
Auto Clamped Handle.....	6
Reset Curve.....	6
Use Clipping.....	6
Delete Points.....	6
Curve Presets.....	6
Last Operator Weight Gradient.....	7
Type.....	7
Sample tools group.....	7
Sample Weight.....	7
Sample Vertex Group.....	7

Tool Shelf - Mesh - Weight Paint Mode

In Vertex Paint mode with a mesh object you will find mainly brushes in the tool shelf. Vertex painting allows you to paint the vertices of a mesh object with a specific color. This can then be used in various ways. As direct painting without any UV mapping. Or for some special calculations. There is a shader node that reads the vertex color values.



Transform and Annotate tools

The transform and annotate tools at the end of the list are explained in the chapter 7.1.1 Editors - 3D View - Tool Shelf - Object Mode. We won't cover this tools again here.

The transform tools group shows when you activate Paint Mask or Vertex selection sub modes.

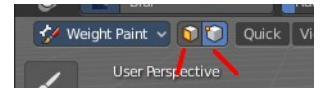

Brush cursor

When you activate one of the brushes then the mouse cursor turns into a brush cursor. This cursor represents the size of the current brush. It does not align with the surface under the mouse. But always faces towards you.

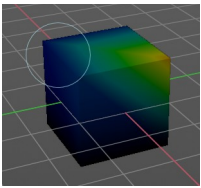

Brushes settings

The different brushes settings can be found in the sidebar in the tools tab. Or in the properties editor in the Active Tool and Workspace settings tab. Or above the header area.

The different brushes settings in the Active Tool and Workspace settings are explained in the chapter 25.1.4 Editors - Properties Editor - Tools Tab - Vertex Paint Mode

We won't cover this chapters again, but just explain what the different brushes does.

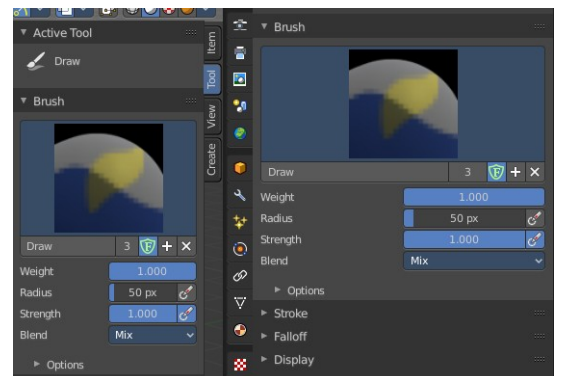
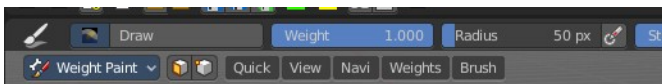

Symmetry

You can enable Symmetry painting up right in the header.

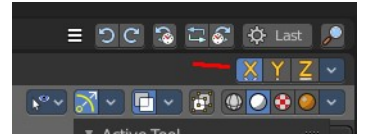

Hotkeys

Pressing F allows you to change the brush size onscreen. Drag the mouse to increase or decrease the size. Left click applies the new size, right click cancels the resizing.

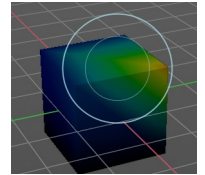

Pressing Shift F allows you to change the strength of the brush. Drag the mouse to increase or decrease the size. Left click applies the new size, right click cancels the resizing.

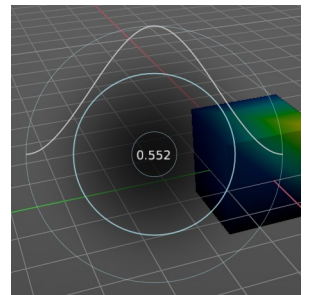

Pressing Ctrl F allows you to change the weight size onscreen. Drag the mouse to increase or decrease the size. Left click applies the new size, right click cancels the resizing.

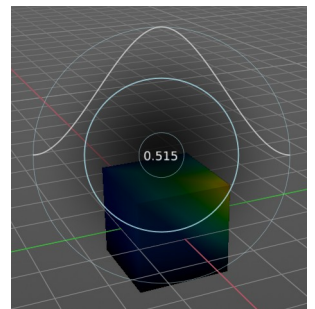

Draw

Draws a stroke. The Draw tool has several sub brushes in the Brush panel. The names of the brushes are pretty self explaining.

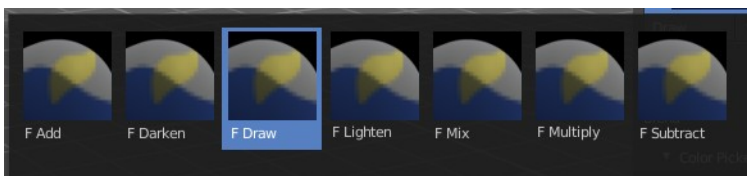

Add

The specified weight value is added to the vertex weights. The strength determines which fraction of the weight gets added per stroke. But the brush will not paint weight values above 1.0.

Darken

Darkens the current color at the vertices down to the specified target value. Only weights above the target weight are affected. Weights below the target weight remain unchanged.

Draw

Draws a stroke.

Lighten

Lightens the current color at the vertices up to the specified target value. Only weights below the target weight are affected. Weights above the target weight remain unchanged.

Mix

Mix the color that you draw with the background color.

Multiply

Multiplies the color that you draw with the background color.

Subtract

Removes the color from the vertex with drawing.

Blur

Smooths out the colors of adjacent vertices. In this mode the Color Value is ignored. The strength defines how much the colors are blurred.

Average

Smooths color by painting the average resulting color from all colors under the brush.

Smear

Smudges colors by grabbing the colors under the brush and “dragging” them.

Gradient

Allows you to draw a gradient between two defined points. The gradient gets drawn with the starting color at the start point, and the color for zero weight at the end point.

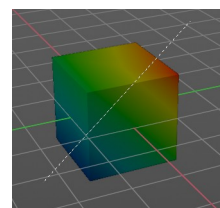

Tool Settings

Weight

The starting weight.

Strength

The strength with which it mixes with the existing weighting.

Type

Choose the gradient type. Linear or Radial.

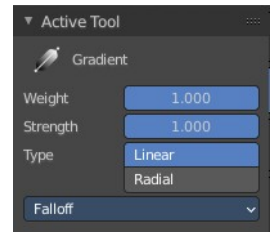

Falloff

Allows you to adjust the falloff by a curve.

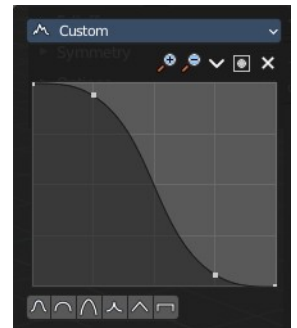

Curve Presets

Curve presets to choose from.

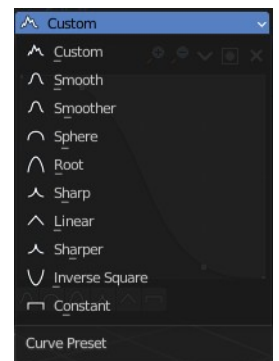

Selecting Points

You can select curve points. This reveals two edit boxes for the x and y coordinate of this point.

Selected points can be moved around. Left click at them, hold the mouse button down and move them to a new location.

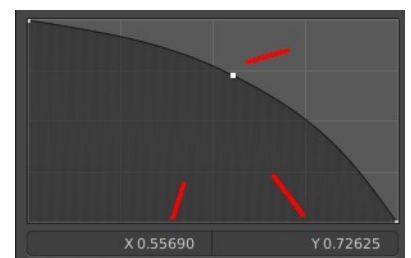

Adding Points

You can add new curve points by simply left clicking at the curve. Move the mouse to position them where you need it.

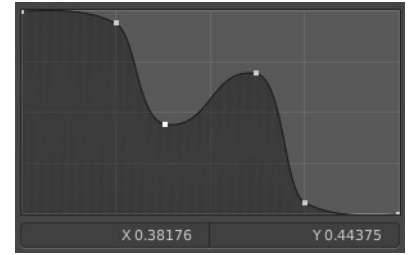

Navigation elements

The navigation elements at the top are described from left to right.

Zoom in and out

The two buttons with the magnifying glass at it zooms in and out in the curve window.



Tools

Tools is a menu where you can find some curve related tools.

Reset View

Resets the curve windows zoom.

Vector Handle

Set handle type to Vector.

Auto Handle

Set handle type to Auto.

Auto Clamped Handle

Set handle type to Auto Clamped.

Reset Curve

Resets the curve to the initial shape.

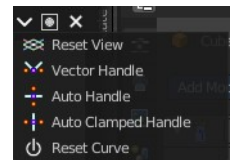

Use Clipping

Clipping options. Set up clipping for the stroke. The blue button at the top turns clipping on or off.

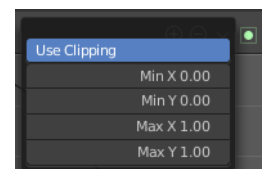

Delete Points

Deletes the selected curve point.

Curve Presets

Predefined curve presets.



Last Operator Weight Gradient

Type

Choose the gradient type. Linear or Radial.

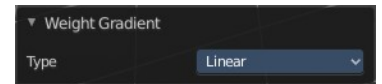

Sample tools group

Sample Weight

Sets the actual weight value to the color under the mouse.

The mouse turns into a picker. When clicking at the mesh with that picker, the header shows the weight value of the weighting of the corresponding vertice under the mouse

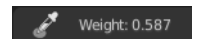
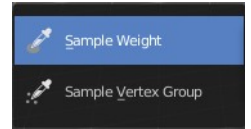

Sample Vertex Group

Opens a popup menu where you can select one of the vertex groups that are under the mouse.

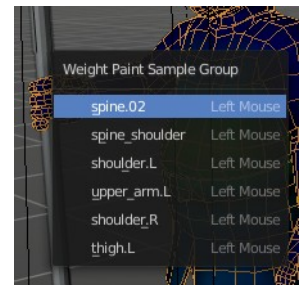

7.2.6 Editors - 3D Viewport - Tool Shelf - Mesh - Texture Paint Mode

Table of content

Tool Shelf - Mesh - Texture Paint Mode.....	1
Transform and Annotate tools.....	1
Brush cursor.....	1
Brushes settings.....	2
Symmetry.....	2
Hotkeys.....	2
Draw.....	2
Soften.....	3
Smear.....	3
Clone.....	3
Usage.....	3
Fill.....	3
Mask.....	3

Tool Shelf - Mesh - Texture Paint Mode

In Texture Paint mode with a mesh object you will find mainly brushes in the tool shelf. Texture painting allows you to paint directly onto the texture of the mesh.

Texture painting requires to have a proper UV mapping and a texture at the mesh. When there is no texture at the mesh then the mesh shows pink. And you will get a No Textures message in the tools settings in the Texture Slots panel. You can add a texture paint slot under the tiny little button at the right.

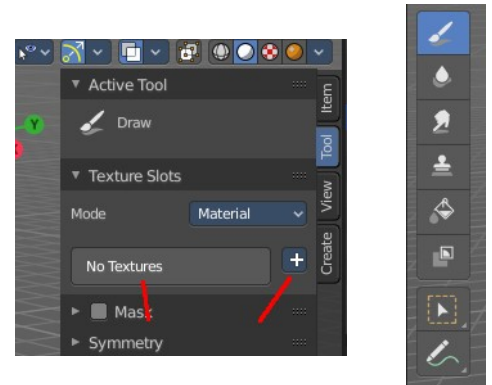
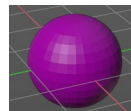

Transform and Annotate tools

The transform and annotate tools at the end of the list are explained in the chapter 7.1.1 Editors - 3D View - Tool Shelf - Object Mode. We won't cover this tools again here.



The transform tools group shows when you activate Paint Mask sub mode.

Brush cursor

When you activate one of the brushes then the mouse cursor turns into a brush cursor. This cursor represents the size of the current brush. It does not align with the surface under the mouse. But always faces towards you.

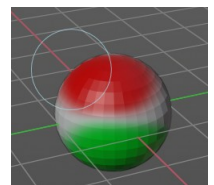

Brushes settings

The different brushes settings can be found in the sidebar in the tools tab. Or in the properties editor in the Active Tool and Workspace settings tab. Or above the header area.

The different brushes settings in the Active Tool and Workspace settings are explained in the chapter Tools Tab - Texture Paint Mode

We won't cover this chapters again, but just explain what the different brushes does.

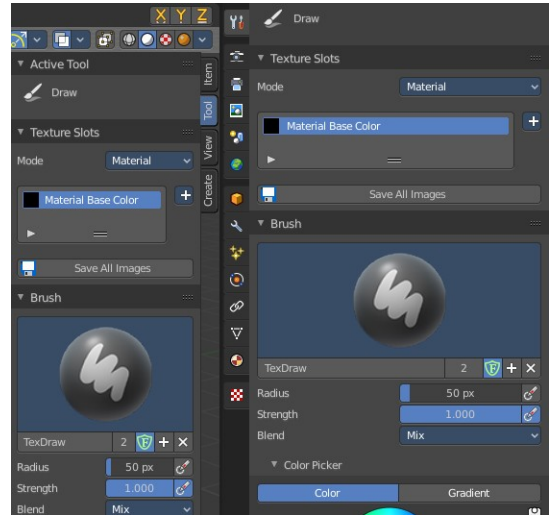

Symmetry

You can enable Symmetry painting up right in the header.



Hotkeys

Pressing F allows you to change the brush size onscreen. Drag the mouse to increase or decrease the size. Left click applies the new size, right click cancels the resizing.

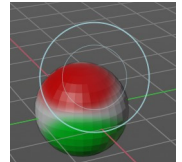

Pressing Shift F allows you to change the strength of the brush. Drag the mouse to increase or decrease the size. Left click applies the new size, right click cancels the resizing.

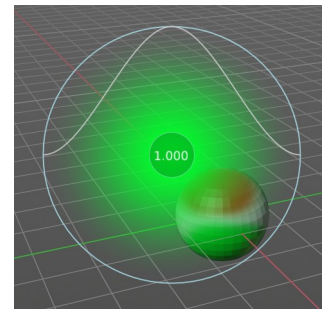

Draw

Draws a stroke. The color and quite a few other settings can be defined in the Tools settings.



Soften

Softens the texture region under the brush cursor.

Smear

Smears the color under the brush cursor

Clone

Clone a texture area and paint with it.

Usage

Hold down CTRL and click at the source area that you want to draw with. Then draw with left mouse strokes

Fill

Fills the whole selection with the chosen color.

Mask

Mask out mesh parts by painting these areas with the mask color, which is by default black. Masked texture parts won't be painted when you paint over it. Turn off the mask to see the effect.

This tool requires to have a stencil texture. This stencil texture can be created or loaded in the tools tab in the Mask panel.

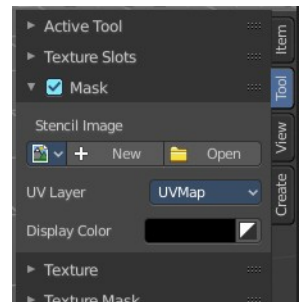
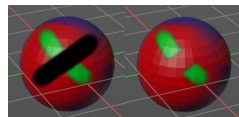



7.2.7 Editors - 3D Viewport - Tool Shelf - Mesh - Particle Edit Mode

Table of content

Tool Shelf - Mesh - Particle Edit Mode.....	2
Select and 3D Cursor tools.....	2
Hotkeys.....	2
Comb.....	2
Tool Settings.....	2
Radius.....	2
Strength.....	2
Deflect Emitter.....	2
Distance.....	3
Smooth.....	3
Tool Settings.....	3
Radius.....	3
Strength.....	3
Add.....	3
Tool Settings.....	3
Radius.....	3
Count.....	3
Interpolate.....	3
Steps.....	3
Keys.....	3
Length.....	3
Tool Settings.....	4
Radius.....	4
Strength.....	4
Length Mode.....	4
Puff.....	4
Tool Settings.....	4
Radius.....	4
Strength.....	4
Add / Sub.....	4
Puff Volume.....	4
Cut.....	4
Tool Settings.....	4
Radius.....	4
Strength.....	5
Weight.....	5
Tool Settings.....	5
Radius.....	5
Strength.....	5

Tool Shelf - Mesh - Particle Edit Mode

You can attach a particle system to a mesh object. And then you can switch to a Particle Edit Mode.

This mode allows you to edit the particles. In the tool shelf you will find several brushes. These brushes are of use for particles of type hair. They can be combed, cut etc. .



Select and 3D Cursor tools

Select tools group and 3D Cursor are explained in the chapter 7.1.1 Editors - 3D View - Tool Shelf - Object Mode. We won't cover this tools again here.

Hotkeys

Pressing F allows you to change the brush size onscreen. Drag the mouse to increase or decrease the size. Left click applies the new size, right click cancels the resizing.

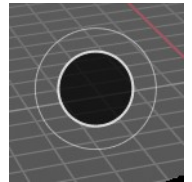

Pressing Shift F allows you to change the strength of the brush. Drag the mouse to increase or decrease the size. Left click applies the new size, right click cancels the resizing.

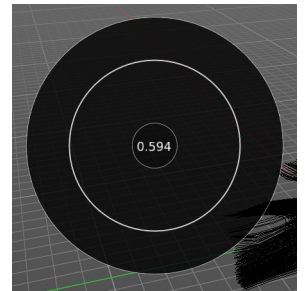

Comb

Allows you to comb the strands of the particle system.

Tool Settings

Radius

The brush radius. The button behind the edit box allows you to set the radius by mouse move. This is a hotkey tool, and should be performed in the viewport.

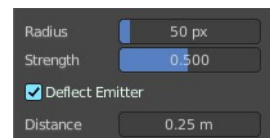

Strength

The brush strength. The button behind the edit box allows you to set the radius by mouse move. This is a hotkey tool, and should be performed in the viewport.

Deflect Emitter

Prevent paths to intersect the emitter mesh geometry.

Distance

The distance to keep particles away from the emitter mesh geometry.

Smooth

Allows you to smooth the strands of the particle system.

Tool Settings



Radius

The brush radius. The button behind the edit box allows you to set the radius by mouse move. This is a hotkey tool, and should be performed in the viewport.

Strength

The brush strength. The button behind the edit box allows you to set the radius by mouse move. This is a hotkey tool, and should be performed in the viewport.

Add

Allows you to add strands to the particle system.

Tool Settings

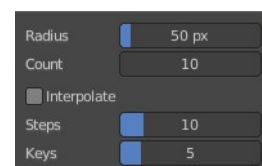

Radius

The brush radius. The button behind the edit box allows you to set the radius by mouse move. This is a hotkey tool, and should be performed in the viewport.

Count

The amount of strands.

Interpolate

Interpolate new particles from the existing ones.

Steps

Brush steps. Steps is connected with Interpolate.

Keys

How many keys to make new particles with.

Length

Manipulate the length of the strands.

Tool Settings

Radius

The brush radius. The button behind the edit box allows you to set the radius by mouse move. This is a hotkey tool, and should be performed in the viewport.

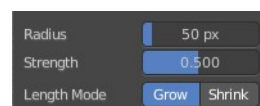

Strength

The brush strength. The button behind the edit box allows you to set the radius by mouse move. This is a hotkey tool, and should be performed in the viewport.

Length Mode

Grow or shrink the particles.

Puff

Manipulate the volume of the strands.

Tool Settings

Radius

The brush radius. The button behind the edit box allows you to set the radius by mouse move. This is a hotkey tool, and should be performed in the viewport.

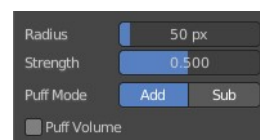

Strength

The brush strength. The button behind the edit box allows you to set the radius by mouse move. This is a hotkey tool, and should be performed in the viewport.

Add / Sub

Add or subtract to the current volume.

Puff Volume

Apply Puff to unselected end points.

Cut

Cut away particles.

Tool Settings

Radius

The brush radius. The button behind the edit box allows you to set the radius by mouse move. This is a hotkey tool, and should be performed in the viewport.



Strength

The brush strength. The button behind the edit box allows you to set the radius by mouse move. This is a hotkey tool, and should be performed in the viewport.

Weight

Manipulate the weight of the strands.

Tool Settings

Radius

The brush radius. The button behind the edit box allows you to set the radius by mouse move. This is a hotkey tool, and should be performed in the viewport.



Strength

The brush strength. The button behind the edit box allows you to set the radius by mouse move. This is a hotkey tool, and should be performed in the viewport.



7.2.8 Editors - 3D Viewport - Tool Shelf - Curve - Edit Mode

Table of content

Tool Shelf - Curve - Edit Mode.....	3
Tweak, Select, Transform, 3D Cursor Measure and Annotate tools.....	3
Curve Stroke Panel.....	3
Draw.....	3
Tool Settings.....	4
Type.....	4
Method.....	4
Refit.....	4
Split.....	4
Tolerance.....	4
Detect Corners.....	4
Corner Angle.....	4
Taper Start / End.....	4
Radius Min/Max.....	4
Use Pressure.....	4
Depth.....	4
Last Operator Draw Curve.....	4
Error.....	4
Fit Method.....	5
Corner Angle.....	5
Cyclic.....	5
Extrude Tools Group.....	5
Snapping.....	5
Precision movement.....	5
Header Values.....	5
Move without Widget.....	5
Limit Axis.....	5
Extrude.....	6
Header Value.....	6
Tool Settings.....	6
Axis Type.....	6
Drag.....	6
Active Tool.....	6
Tweak, Select Box, Circle and Lasso.....	6
Last operator Extrude Curve and Move.....	6
Mode.....	7
Move X , Y , Z.....	7
Orientation.....	7
Proportional editing.....	7
Proportional Falloff.....	7
Proportional Size.....	7
Connected.....	7
Projected(2D).....	7
Extrude Cursor.....	7
Last Operator Add Vertex.....	7
Location X Y Z.....	7
Radius.....	8

Header Value.....	8
Tool Settings.....	8
Drag.....	8
Active Tool.....	8
Tweak, Select Box, Circle and Lasso.....	8
Last Operator Transform.....	8
Values X Y Z W.....	8
Axis.....	8
Orientation.....	8
Proportional editing.....	8
Proportional Falloff.....	8
Proportional Size.....	9
Connected.....	9
Projected(2D).....	9
Tilt.....	9
Header Value.....	9
Tool Settings.....	9
Drag.....	9
Active Tool.....	9
Tweak, Select Box, Circle and Lasso.....	9
Last Operator Transform.....	9
Angle.....	9
Proportional editing.....	10
Proportional Falloff.....	10
Proportional Size.....	10
Connected.....	10
Projected(2D).....	10
Shear.....	10
Tool Settings.....	10
Orientation.....	10
Drag.....	10
Active Tool.....	10
Tweak, Select Box, Circle and Lasso.....	11
Last Operator Shear.....	11
Offset.....	11
Axis.....	11
Axis Ortho.....	11
Orientation.....	11
Proportional editing.....	11
Proportional Falloff.....	11
Proportional Size.....	11
Connected.....	11
Projected(2D).....	11
Randomize.....	11
Header Value.....	11
Tool Settings.....	12
Uniform.....	12
Normal.....	12
Random Seed.....	12
Drag.....	12
Active Tool.....	12
Tweak, Select Box, Circle and Lasso.....	12
Last Operator Transform.....	12

Amount.....12
 Uniform.....12
 Normal.....12
 Random Seed.....12

Tool Shelf - Curve - Edit Mode

With a curve object in edit mode you will find some tools to edit the curve geometry in the tool shelf.

Tweak, Select, Transform, 3D Cursor Measure and Annotate tools

The tweak, select, transform, 3d cursor, measure and annotate tools at the end of the list are explained in the chapter 7.1.1 Editors - 3D View - Tool Shelf - Object Mode. We won't cover this tools again here.



Curve Stroke Panel

The curve stroke panel is covered in the chapter 25.1.1 Editors - Properties Editor - Tools Tab - Edit Mode. We won't cover this tools again here.

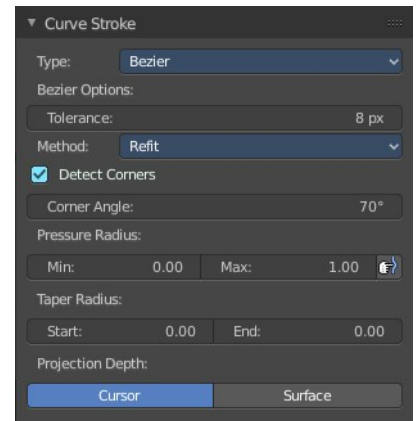

Draw

Allows you to draw a curve into the viewport.

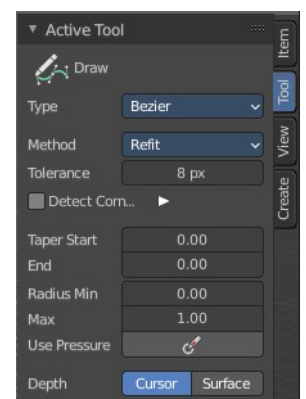
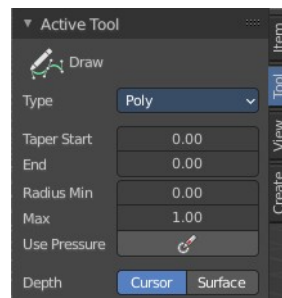
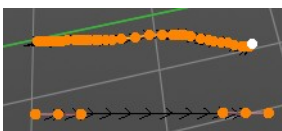

Tool Settings

Type

Set the draw method for the curve. Poly draws a simple polygon shape. Bezier creates a Bezier curve type with handlers.

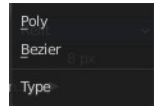

With type Bezier you will get more options.

Method

The curve fitting method for a Bezier curve.



Refit

Incrementally refit the curve.

Split

Split the curve until it fits.

Tolerance

Allow deviation for a smoother but less precise line.

Detect Corners

Detect corners and use non aligned angles.



Corner Angle

Corners above this angle are considered as corners.

Taper Start / End

Taper factor for the radius of each curve point.

Radius Min/Max

Minimum or maximum radius when the pressure is applied.

Use Pressure

Use tablet pressure to draw the curve.

Depth

The method of projecting depth. Cursor or surface.

Last Operator Draw Curve

Error

Adjust the error distance threshold in object units



Fit Method

The curve fitting method. Choose between Refit and Split.

Corner Angle

Corners above this angle are considered as corners.

Cyclic

With curve type Bezier the curve gets closed. Has no effect at curve type Poly.

Extrude Tools Group

This tools allows you to extrude out a new curve segment from the current selection

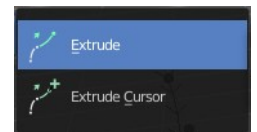

Snapping

Holding down Ctrl activates temporary global snapping.

Precision movement

When you hold down shift, then you will have a much slower but also much preciser movement.

Header Values

When you move your selection then you will see some values in the header, which defines the current position of the extrude point.

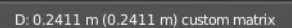
A screenshot of the software's header area showing the text 'D: 0.2411 m (0.2411 m) custom matrix'.

Move without Widget

You don't have to use the widget to move the object. You can also click aside of it, and drag the object around. The mouse turns into a move cursor. The standard behavior then is to move in screen space. When you want to move into a specific axis, then press X or Y or Z to limit the movement to this axis.

Limit Axis

When you want to move along a specific axis, then press X or Y or Z to limit the movement to this axis. You usually start in global orientation. But you can change this in the Orientation settings.

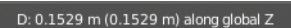
A screenshot of the software's header area showing the text 'D: 0.1529 m (0.1529 m) along global Z'.

By holding down the mouse button and pressing the X, Y or Z key twice you can toggle this to local. But also to other orientations. This depends in what orientation you start. With normal you can toggle that way between Normal and Global.

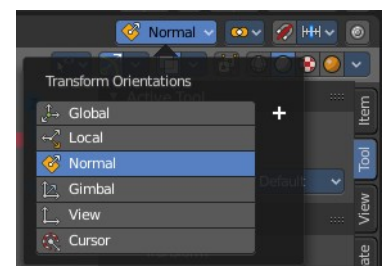

Extrude

The Extrude tool extrudes the current selection in the direction of the widget.

When you activate the tool, then you will by default see a yellow widget at the selection. Drag it to extrude the selection.

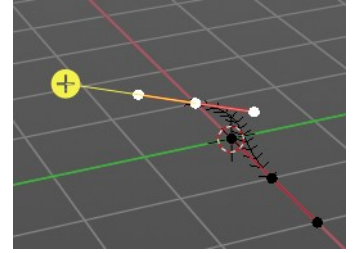

D: 0.4618 m (0.4618 m) custom matrix

Header Value

When you extrude curve points then you will see a value in the header. It tells you the current target position relative to the initial starting point(s) . This factor always starts with 0.

Tool Settings

Axis Type

You can choose between the regular axis type. That's the yellow widget with just one handler. It always points in the direction of the middle normals of the selection.

Or you can use the XYZ axis type. That's a handler with three axis. This widget can be aligned with the transform orientation methods.

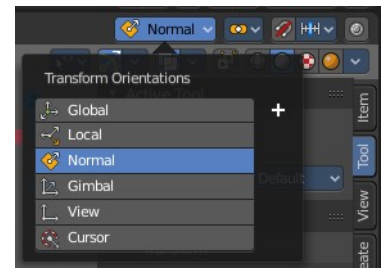
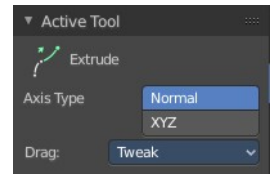
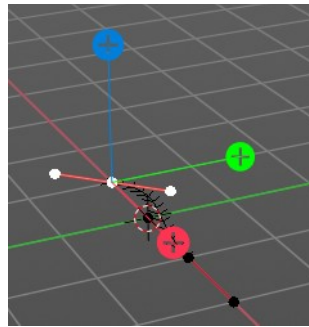

Drag

When you click at the widget of the active tool, then you perform the tool action. Adjust what should happen when you click outside of the widget, in the empty area.

Active Tool

When you click off the widget then the click still does the same than clicking at the widget. It performs the active tool.

Tweak, Select Box, Circle and Lasso

When you choose this options then you will set the off click to the different select methods. Whereas tweak works more than a move tool then. Tweak is the default.

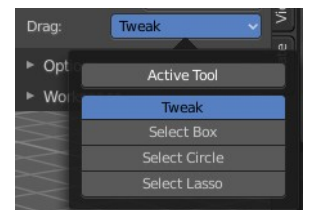

Last operator Extrude Curve and Move

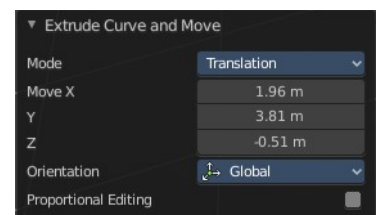

Mode

A drop-down box. Choose between different extrude modes.

Default is Translation. Most other methods has no effect.



Move X , Y , Z

The position of the extruded point(s).

Orientation

Adjust the orientation of the extrusion. It usually starts with Normal.

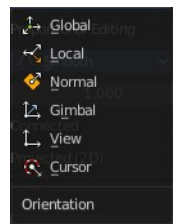

Proportional editing

Enables proportional editing. Activating proportional editing reveals further settings.

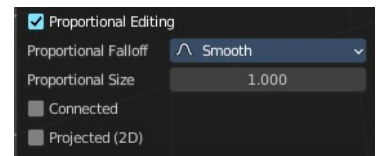

Proportional Falloff

Adjust the falloff methods.

Proportional Size

See and adjust the falloff radius.

Connected

The proportional falloff gets calculated for connected parts only.

Projected(2D)

The proportional falloff gets calculated in the screen space. Depth doesn't play a role. When it's in the radius, then it gets calculated.

Extrude Cursor

Extrudes the control points to where you click.

Last Operator Add Vertex

Location X Y Z

The location of the new created control point(s).

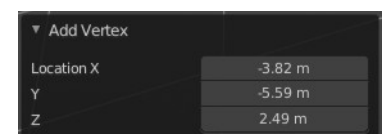

Radius

Bezier curves have a radius. This is displayed by the black lines that points away from the curve. The radius tool allows you to resize this radius.

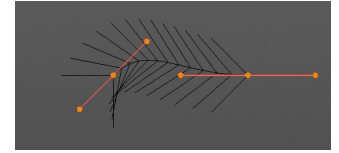

Header Value

When you resize the curve radius then you will see a value in the header. It tells you the current scale factor. This factor always starts with 1.

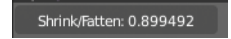

Tool Settings

Drag

When you click at the widget of the active tool, then you perform the tool action. Adjust what should happen when you click outside of the widget, in the empty area.

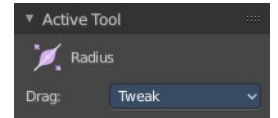

Active Tool

When you click off the widget then the click still does the same than clicking at the widget. It performs the active tool.

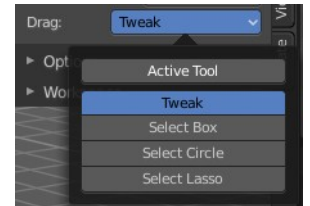

Tweak, Select Box, Circle and Lasso

When you choose this options then you will set the off click to the different select methods. Whereas tweak works more than a move tool then. Tweak is the default.

Last Operator Transform

Values X Y Z W

The axis to increase the radius. Just X has an effect with the curve radius.

Axis

The axis to use. This has no effect with a curve object.

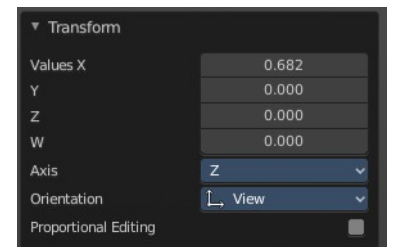

Orientation

Adjust the orientation of the extrusion. It usually starts with Normal.

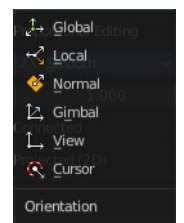

Proportional editing

Enables proportional editing. Activating proportional editing reveals further settings.

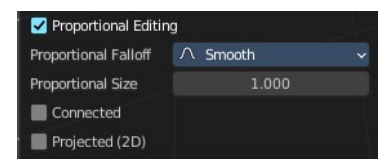

Proportional Falloff

Adjust the falloff methods.

Proportional Size

See and adjust the falloff radius.

Connected

The proportional falloff gets calculated for connected parts only.

Projected(2D)

The proportional falloff gets calculated in the screen space. Depth doesn't play a role. When it's in the radius, then it gets calculated.

Tilt

With this tool you can tilt the curve. It is the mean tilt value in the Transform panel of the Sidebar.

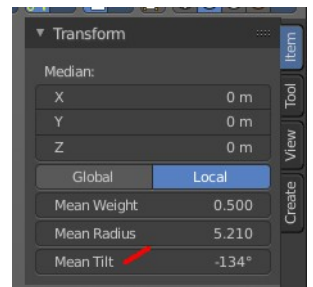

Header Value

When you rotate the curve with the tilt tool, then you will see a value in the header. It tells you the current rotation relative to the starting rotation. This value always starts with 0.

Tilt: 51.17°

Tool Settings

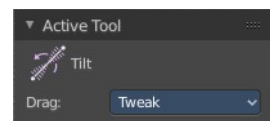

Drag

When you click at the widget of the active tool, then you perform the tool action. Adjust what should happen when you click outside of the widget, in the empty area.

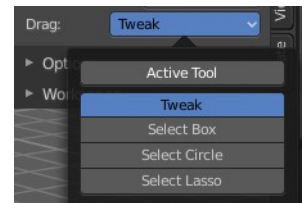

Active Tool

When you click off the widget then the click still does the same than clicking at the widget. It performs the active tool.

Tweak, Select Box, Circle and Lasso

When you choose this options then you will set the off click to the different select methods. Whereas tweak works more than a move tool then. Tweak is the default.

Last Operator Transform

Angle

This value tells you the current rotation relative to the starting rotation. This value always starts with 0.

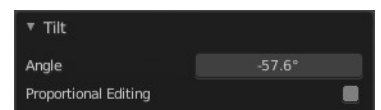

Proportional editing

Enables proportional editing. Activating proportional editing reveals further settings.

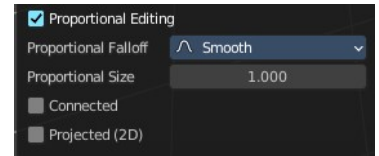

Proportional Falloff

Adjust the falloff methods.

Proportional Size

See and adjust the falloff radius.

Connected

The proportional falloff gets calculated for connected parts only.

Projected(2D)

The proportional falloff gets calculated in the screen space. Depth doesn't play a role. When it's in the radius, then it gets calculated.

Shear

The shear tool allows you to shear the selected geometry. When you activate the tool, then a widget appears that allows you to pull in the desired direction.

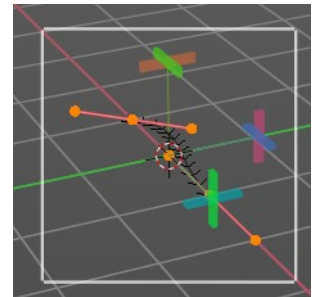

Tool Settings

Orientation

Choose the orientation for the shear action.

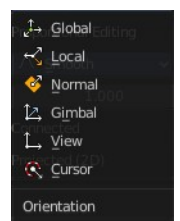
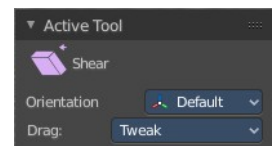

Drag

When you click at the widget of the active tool, then you perform the tool action. Adjust what should happen when you click outside of the widget, in the empty area.

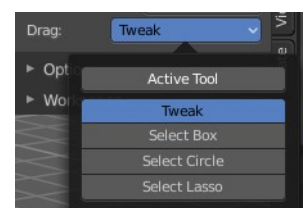

Active Tool

When you click off the widget then the click still does the same than clicking at the widget. It performs the active tool.

Tweak, Select Box, Circle and Lasso

When you choose this options then you will set the off click to the different select methods. Whereas tweak works more than a move tool then. Tweak is the default.

Last Operator Shear

Offset

Adjust an offset.

Axis

Defines one axis of the imaginary shear axis plane.

Axis Ortho

Defines the other axis of the imaginary shear axis plane.

Orientation

Choose the orientation for the shear action.

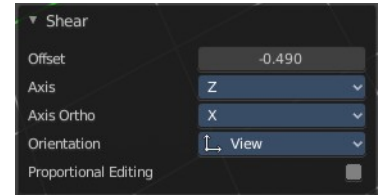

Proportional editing

Enables proportional editing. Activating proportional editing reveals further settings.

Proportional Falloff

Adjust the falloff methods.

Proportional Size

See and adjust the falloff radius.

Connected

The proportional falloff gets calculated for connected parts only.

Projected(2D)

The proportional falloff gets calculated in the screen space. Depth doesn't play a role. When it's in the radius, then it gets calculated.

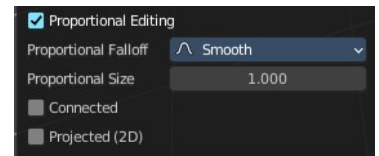
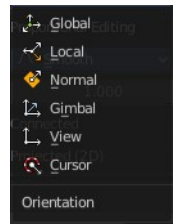

Randomize

Randomize the position of the selected polygon or control points.

Header Value

When you randomize the points, then you will see a value in the header. It tells you the current randomization amount. This value always starts with 0.

0.1167

Tool Settings

Uniform

With a value of 0 the randomization happens uniformly. The higher the value the more uniform the randomization affects the selected points.

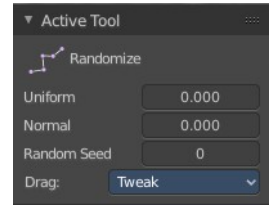

Normal

Align the offset direction to normals. This value has no effect.

Random Seed

A random seed value.

Drag

When you click at the widget of the active tool, then you perform the tool action. Adjust what should happen when you click outside of the widget, in the empty area.

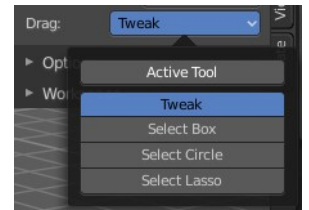

Active Tool

When you click off the widget then the click still does the same than clicking at the widget. It performs the active tool.

Tweak, Select Box, Circle and Lasso

When you choose this options then you will set the off click to the different select methods. Whereas tweak works more than a move tool then. Tweak is the default.

Last Operator Transform

Amount

The randomization amount.

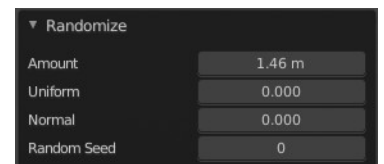

Uniform

With a value of 0 the randomization happens uniformly. The higher the value the more uniform the randomization affects the selected points.

Normal

Align the offset direction to normals. This value has no effect.

Random Seed

A random seed value.



7.2.9 Editors - 3D Viewport - Tool Shelf - Surface - Edit Mode

Table of content

Tool Shelf - Surface - Edit Mode.....	1
Tweak, Select, Transform, 3D Cursor Measure and Annotate tools.....	1
Shear.....	1
Tool Settings.....	1
Orientation.....	2
Drag.....	2
Active Tool.....	2
Tweak, Select Box, Circle and Lasso.....	2
Last Operator Shear.....	2
Offset.....	2
Axis.....	2
Axis Ortho.....	2
Orientation.....	2
Proportional editing.....	2
Proportional Falloff.....	2
Proportional Size.....	2
Connected.....	3
Projected(2D).....	3

Tool Shelf - Surface - Edit Mode

Tweak, Select, Transform, 3D Cursor Measure and Annotate tools



The tweak, select, transform, 3d cursor, measure and annotate tools at the end of the list are explained in the chapter 7.1.1 Editors - 3D View - Tool Shelf - Object Mode. We won't cover this tools again here.

Shear

The shear tool allows you to shear the selected geometry. When you activate the tool, then a widget appears that allows you to pull in the desired direction.

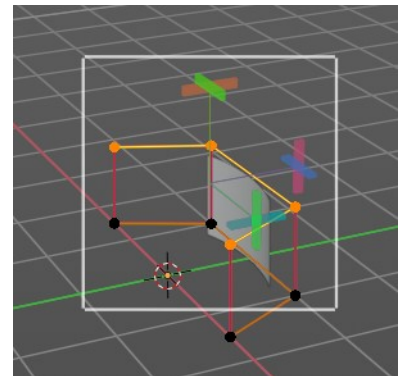

Tool Settings

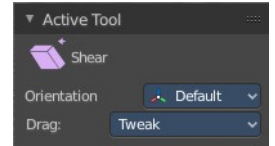

Orientation

Choose the orientation for the shear action.

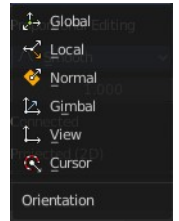

Drag

When you click at the widget of the active tool, then you perform the tool action. Adjust what should happen when you click outside of the widget, in the empty area.

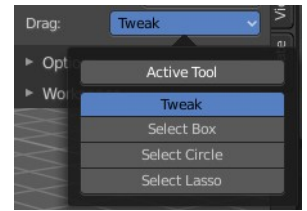

Active Tool

When you click off the widget then the click still does the same than clicking at the widget. It performs the active tool.

Tweak, Select Box, Circle and Lasso

When you choose this options then you will set the off click to the different select methods. Whereas tweak works more than a move tool then. Tweak is the default.

Last Operator Shear

Offset

Adjust an offset.

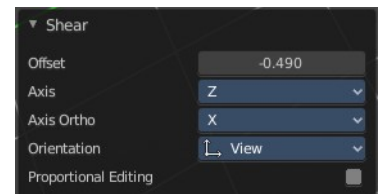

Axis

Defines one axis of the imaginary shear axis plane.

Axis Ortho

Defines the other axis of the imaginary shear axis plane.

Orientation

Choose the orientation for the shear action.

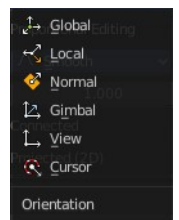

Proportional editing

Enables proportional editing. Activating proportional editing reveals further settings.

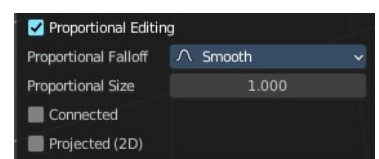

Proportional Falloff

Adjust the falloff methods.

Proportional Size

See and adjust the falloff radius.

Connected

The proportional falloff gets calculated for connected parts only.

Projected(2D)

The proportional falloff gets calculated in the screen space. Depth doesn't play a role. When it's in the radius, then it gets calculated.



7.3 Editors - 3D Viewport - Sidebar

Table of content

Introduction.....1

Introduction

The 3D View is made of several areas. At the right side you will find the sidebar.

In the sidebar you will find tool settings and view related settings. And it is also the home of addons. The Create tab is already created by an add-on. The Mini Lightlib add-on., which is covered in chapter 7.3.13

The content differs, dependent of the chosen object and the current mode.

The Tools tab is also a special chapter. It contains the settings for the tools from the tool shelf.

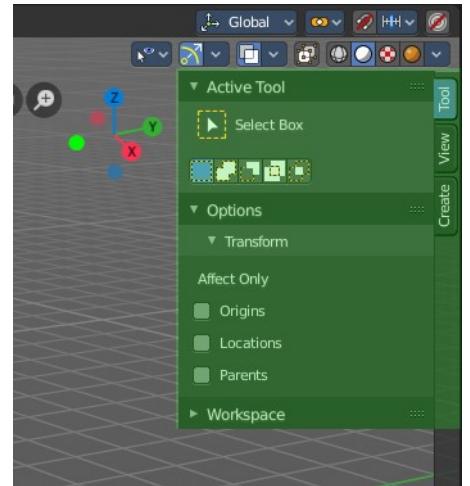



7.3.1 Editors - 3D Viewport - Sidebar - Item tab

Table of content

Item tab - Transform Panel.....	4
Animate Property.....	4
Keyframe and Driver coloring.....	4
Location.....	4
Rotation.....	4
Rotation Mode.....	4
Quaternion.....	4
Scale.....	5
Dimensions.....	5
Right Click menu.....	5
Insert Keyframe.....	5
Insert Single Keyframe.....	5
Add Driver.....	6
Driver Settings.....	6
Type.....	6
Built-in functions (Average, Sum, Min and Max).....	6
Custom (Scripted Expression).....	6
Driver Value.....	6
Expression.....	6
Expression edit box.....	6
Use Self.....	6
Driver Variables.....	7
Add Input variable.....	7
Driver Variable panel.....	7
Variable type.....	7
Object.....	7
Type.....	7
Space.....	7
Value.....	7
Update Dependencies.....	7
Show in Drivers Editor.....	7
Open Drivers Editor.....	8
Add All to Keying Set.....	8
Add single to Keying Set.....	8
Remove from Keying Set.....	8
Reset All to Default Value.....	8
Reset Single to Default Value.....	8
Unset.....	8
Copy All to Selected.....	8
Copy Single to Selected.....	8
Copy Data Path.....	9
Copy as new Driver.....	9
Assign Shortcut.....	9
Online Python Reference.....	9
Edit Source.....	9
Replace Keyframes.....	9
Replace single Keyframe.....	9

Delete Keyframes.....	9
Delete Single Keyframe.....	9
Clear Keyframes.....	9
Clear single Keyframe.....	9
Delete Drivers.....	9
Delete Single Driver.....	9
Copy Driver.....	10
Edit Driver.....	10
Item tab - Transform Panel in Edit Mode.....	10
Mesh Objects.....	10
Median.....	10
Global / Local.....	10
Vertices Data.....	10
Mean Bevel Weight.....	10
Edges Data.....	10
Mean Bevel Weight.....	10
Mean Crease.....	10
Curve Objects / Surface Objects.....	10
Median.....	10
Global / Local.....	11
Mean Weight.....	11
Mean Radius.....	11
Mean Tilt.....	11
Metaball Objects.....	11
Median.....	11
Global / Local.....	11
Radius.....	11
Stiffness.....	11
Type.....	11
Text Objects.....	11
Armature objects Edit Mode.....	12
Head.....	12
Radius.....	12
Tail.....	12
Radius.....	12
Roll.....	12
Length.....	12
Envelope.....	12
Lattice Objects.....	12
Vertex.....	12
Global / Local.....	12
Mean Weight.....	12
Item tab - Transform Panel in Pose Mode.....	13
Armature Objects in Pose Mode.....	13
Item tab - Vertex Weights Panel.....	13
Filter Vertex Groups.....	13
Group.....	13
Weight.....	13
Paste Weight to Selected.....	13
Delete Weight.....	13
Normalize.....	14
Copy.....	14

Item tab - Transform Panel

When you add an object to the scene then the Item tab with the Transform panel becomes visible. The content changes, dependent of the object type. And it changes with the mode.

In general you will most of the time see the same content though. Location, Rotation, Scale and Dimension.

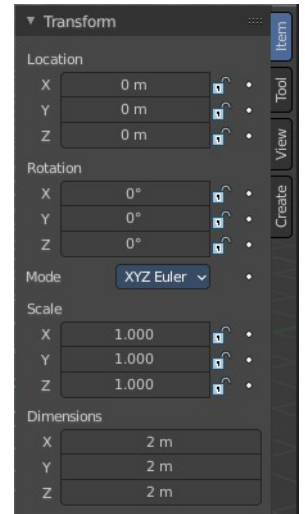

Animate Property

The properties with a dot button behind can be animated.

Note that you can, different from Blender, animate multiple objects at once this way.

Keyframe and Driver coloring

When a keyframe exists at the current position, then the corresponding edit box turns yellow. When a driver exists at the current position, then the corresponding edit box turns purple.

Note that you can have either a driver or a keyframe. Both is not possible.

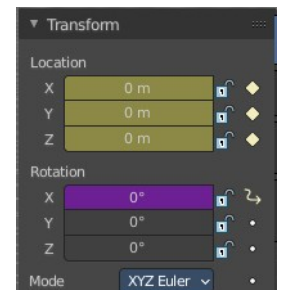

Location

The current location of the object in its X, Y and Z axis. The lock button behind the edit boxes allows you to lock the values.

Rotation

The current rotation of the object in its X, Y and Z axis in world coordinates. The lock button behind the edit boxes allows you to lock the values.

Rotation Mode

Adjust what method gets used for the rotation. Euler rotation can run into a so called Gimbal lock, which can be avoided with quaternion rotation mode. But for most cases the default XYZ Euler method should work.



Quaternion

With euler angles you will have three values available. But with a quaternion you will have four values available. And quaternions reveals a 4L button. This button shows or hides a lock behind the W value. Normally a quaternion has just three locks, one for each of the single axis. The W value is a mathematical construct from the three object axis. And you usually neither want to edit it nor to lock it therefore.

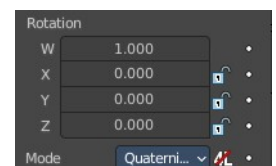
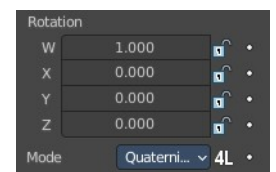

Locking the W axis will lock all axis.

Scale

The current scale of the object in its X, X and Z axis in world coordinates. The lock button behind the edit boxes allows you to lock the values.

Scale is not dimensions. Your object can have a scale of 1 in world coordinates. But a dimension of 4.5. Note that for some operations it is required to have a scale of 1 to get some operations to work. This can be achieved with applying scale in the Object menu.

Dimensions

The current dimension of the object in its X, X and Z axis in world coordinates. The lock button behind the edit boxes allows you to lock the values.

The Dimensions edit boxes are just available for primitives objects. Objects like Empties or a Camera doesn't have a dimension, but a scale factor.

Right Click menu

Location, Rotation and Scale edit boxes and the locks have a right click menu with further functionality.

When there is already a keyframe available then the right click menu looks a bit different. Same counts for adding a driver first.

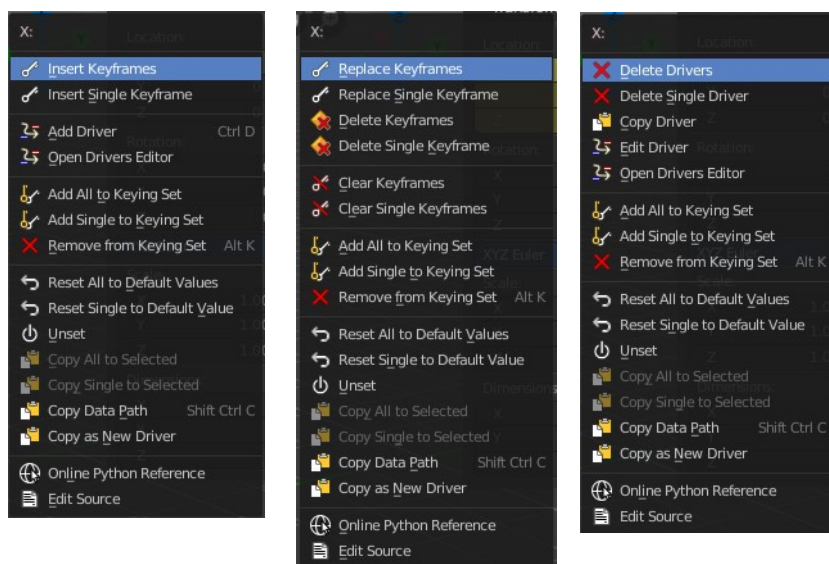

Insert Keyframe

Inserts a keyframe at the current position. The keyframe type depends of where you right click. Insert Keyframe adds a keyframe for all axis.

Insert Single Keyframe

Inserts a keyframe at the current position. The keyframe type depends of where you right click. Insert Single

Keyframe adds a keyframe for just the current axis.

Add Driver

In Bforartists lots of things can be animated. Also buttons. Add Driver does exactly what it tells. It adds a driver for animation needs to the element. Drivers allows to control animation by properties like expressions, scripts or movements of other objects. Drivers are explained in the chapter 18 Editors - Drivers.

When you click the button the Driven Property panel will appear where you can change the properties for this driver. You don't need to confirm the driver creation. It is just further settings.

Driver Settings

Type

The Driver type. There are two categories of drivers. Built-in and Custom

Built-in functions (Average, Sum, Min and Max)

The driven property will have the value of the average, sum, lowest or highest (respectively) of the values of the referenced Driver Variables. If there is only one driver variable, these functions will yield the same result.

Custom (Scripted Expression)

An arbitrary Python expression that can refer to the Driver Variables by name.

Driver Value

The current result of the driver setup.

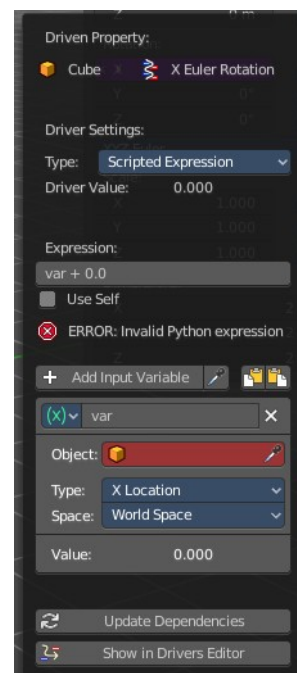

Expression

Expression edit box

Add a custom expression. An Expression to use for scripted expression.

The expression has access to a set of standard constants and math functions provided in the Driver Name space. For an example of adding a custom function to the name space.

When the expression is invalid then you get an error message. This error message appears also with the default values. Just ignore.

Use Self

The variable self can be used for drivers to reference their own data. This is useful for objects and bones to avoid having creating a Driver Variable pointing to itself.

Example: self.location.x applied to the Y rotation property of the same object will make the object tumble when

moving.

Note that dependencies for properties accessed via self may not be fully tracked.

Driver Variables

Driver Variables are references to properties, transformation channels, or the result of a comparison between transformations of two objects. It is displayed by a panel with all necessary settings, which gets filled in automatically when you create the driver.

Add Input variable

Add manually a new driver variable.

Picker should allow you to pick a target object. But this is dysfunctional here since the panel closes immediately when you move the mouse out of it. Please use the picker in the Driver Editor.

Copy and Paste buttons allows you to copy and paste Driver variable panels.

Driver Variable panel

Variable type

The content of the Driver variable panel changes, dependent of the variable type that you choose here. We came from the transform panel, so our default type here is transform channel. That's what we will explain here.

Object

Our object type.

Type

The type of the driver.

Space

The transform space in which the transform should happen.

Value

The resulting value of the driver.

Update Dependencies

Update all dependencies.

Show in Drivers Editor

Opens the Drivers editor in a floating window. The drivers editor is explained in the chapter 18 Editors - Drivers.

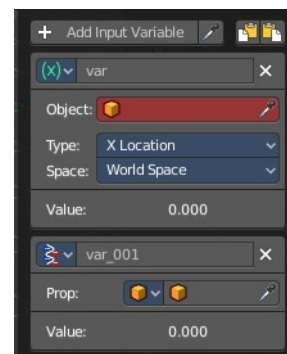

Open Drivers Editor

Opens the Drivers editor in a floating window. The drivers editor is explained in the chapter 18 Editors - Drivers.

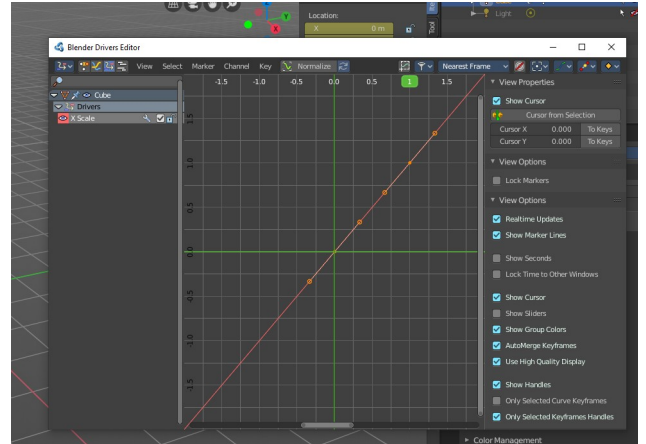

Add All to Keying Set

Add All to Keying Set adds the information of the element to the current keyframe.

Add single to Keying Set

Add to Keying Set adds the information of the element to the current keyframe.

Remove from Keying Set

Remove from Keying Set removes the information of the element from the current keyframe.

Reset All to Default Value

Resets the X Y and Z values to the default value.

Reset Single to Default Value

Resets the value for the single edit box under the mouse to the default value.

Unset

Unset is usually a RMB menu entry when you right click at an edit box. It is somehow similar to Reset to Default Value. But it clears the property instead of resetting it to the default value. Which can end in another value.

Copy All to Selected

Allows to copy the current rotation of all axis to another object.

Workflow. Select target object, hold down shift, select source object, and use Copy All to Selected.

Copy Single to Selected

Allows to copy the current rotation of the single selected axis to another object.

Workflow. Select target object, hold down shift, select source object, and use Copy All to Selected.

Copy Data Path

Copy Data Path copies the RNA data path for this property.

Copy as new Driver

Copies the current value as a new driver.

Assign Shortcut

This is just for the locks. Here you could assign a shortcut.

Online Python Reference

Developer feature. Open the Blender Python Reference.

Edit Source

Developer feature. When you have a text editor open in the current layout then you can call the UI script that contains this menu item.

Replace Keyframes

Replaces the keyframes in all axis at the current position.

Replace single Keyframe

Replaces the keyframe in the currently selected axis at the current position.

Delete Keyframes

Deletes the keyframes in all axis at the current position.

Delete Single Keyframe

Deletes the keyframe in the currently selected axis at the current position.

Clear Keyframes

Deletes all keyframes for all axis.

Clear single Keyframe

Deletes all keyframes for the currently selected axis.

Delete Drivers

Deletes the drivers for all axis.

Delete Single Driver

Deletes the drivers for just the current axis.

Copy Driver

Copies the driver.

Edit Driver

Opens the Driven Property panel where you can change the settings for this driver.

Item tab - Transform Panel in Edit Mode

Just primitive objects like mesh and curve does have an edit mode. Non primitive objects like a camera or an empty doesn't have an edit mode. With two exceptions. Text and Force Field type Curve Guide. Both are curve types.

Mesh Objects

Median

Median is the position of the selected mesh part.

Global / Local

Define if the orientation of the selection is local to the selected object, or global to the world coordinates.

Vertices Data

Mean Bevel Weight

Adjust the bevel weight for the selected vertices when you have a bevel modifier at the mesh.

Edges Data

Mean Bevel Weight

Adjust the bevel weight for the selected edges when you have a bevel modifier at the mesh.

Mean Crease

Adjust the weight of the selected vertices when you have a subdivision surface modifier at the mesh.

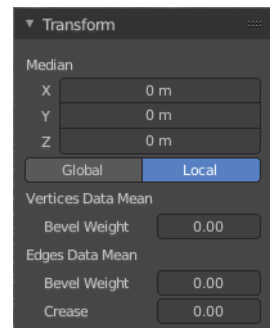

Curve Objects / Surface Objects

Median

Median is the position of the selected mesh part

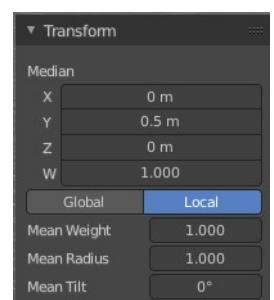

Global / Local

Define if the orientation of the selection is local to the selected object, or global to the world coordinates.

Mean Weight

Adjust the weight used by softbody. Needs softbody.

Mean Radius

Adjust the radius of the curve control points

Mean Tilt

Adjust the tilt of the curve control points.

Metaball Objects

Median

Median is the position of the selected mesh part

Global / Local

Define if the orientation of the selection is local to the selected object, or global to the world coordinates.

Radius

Adjust the radius of the selected meta element.

Stiffness

Adjust the stiffness of the selected meta element.

Type

Type is a drop down box. Adjust the meta element type.

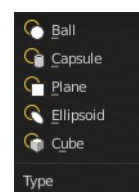
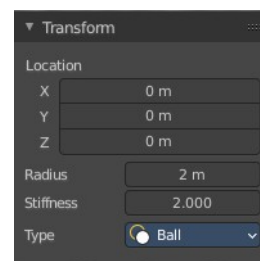

Text Objects

Text objects do have an edit mode, but they don't show content in the Transform panel.

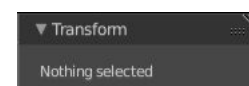

Armature objects Edit Mode

Bones do have a head and a tail. You cannot position the whole bone by numeric values, but the head and tail joints.

Head

Adjust the world position of the head joint.

Radius

This is just useful when you use Envelopes type bones. Adjust the Envelope radius of the head joint.

Tail

Adjust the world position of the tail joint.

Radius

This is just useful when you use Envelopes type bones. Adjust the Envelope radius of the tail joint.

Roll

Adjust the bone roll.

Length

Adjust the length of the bone.

Envelope

This is just useful when you use Envelopes type bones. Adjust the overall Envelope size.

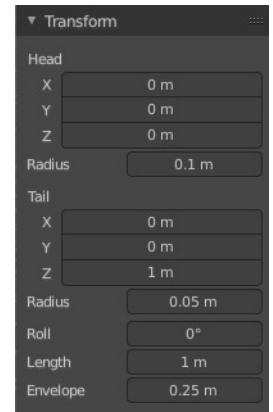

Lattice Objects

You need to have some vertices of the Lattice object selected to see the content.

Vertex

See and set the vertex positions of the lattice objects.

Global / Local

Define if the orientation of the selection is local to the selected object, or global to the world coordinates.

Mean Weight

Lattice object is a deform cage. Adjust the mean weight of the selected vertice(s).

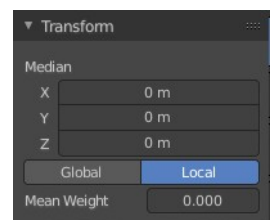

Item tab - Transform Panel in Pose Mode

Armature Objects in Pose Mode

The content in Pose mode is the same than in Object mode. We have Location, Rotation and Scale Edit Boxes. And the corresponding lock and animate buttons.

With one small difference. The rotation mode starts with Quaternions by default. And not with Euler Angles.

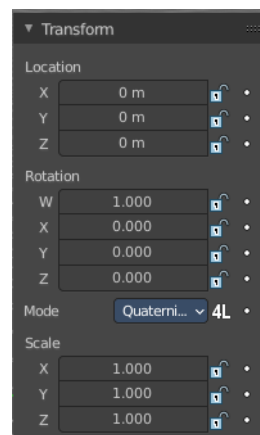

Item tab - Vertex Weights Panel

The Vertex Weights panel shows in Edit and Weight Paint mode, when you have vertices selected, and the selected vertice(s) has a weight assigned.

It allows you to modify the weight of this selected vertice(s).

In Weight paint mode you need to be in vertex selection mode and have a vertice selected. It will not show with face select mode. To select a vertice in weight paint mode hold down ctrl and click.

In Edit Mode you can select more than one vertices. In Weight Paint Mode just one vertice at a time.

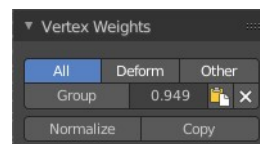

Filter Vertex Groups

The first row is a setting. You can filter by all, only vertex groups that are assigned to deform bones. Or vertex groups that are assigned to non deform bones.

Group

Set as active Vertex Group.

Weight

The weight of the selected vertice(s). The range goes from 0 to 1.

Paste Weight to Selected

Copy this group's weight to other selected vertices.

Delete Weight

Deletes the weight for this selected vertice(s).

Normalize

Normalizes the weight of the selected vertice(s).

Copy

Copy active vertex to other selected vertices.



7.3.10 Editors - 3D Viewport - Sidebar - Tool Tab - Particle Edit Mode

Table of content

Tools Tab in Particle Edit Mode.....	2
Particle Edit Mode - Options panel.....	2
Particle Edit Type.....	3
X Mirror.....	3
Preserve Strand Lengths.....	3
Preserve Root Positions.....	3
Auto-Velocity.....	3
Cut particles to Shape.....	3
Viewport Display.....	3
With Hair.....	3
Path Steps.....	3
Children.....	3
With Emitter.....	3
Path Steps.....	3
Particles.....	4
Fade Time.....	4
Frames.....	4

Tools Tab in Particle Edit Mode

The Particle Edit mode enables to edit particle settings. For example, Hair Particles can be manipulated with some brushes. They can be combed, cut etc.

The Tools tab contains the settings for the hair editing brushes.

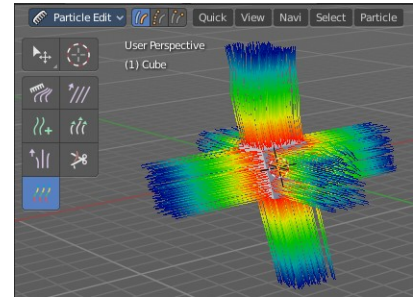

Different from the other paint modes, there is no brush panel. The brushes are here part of the tool settings of the single brushes. The brush settings will be covered in the 3D view in the chapter for Particle Edit Mode.

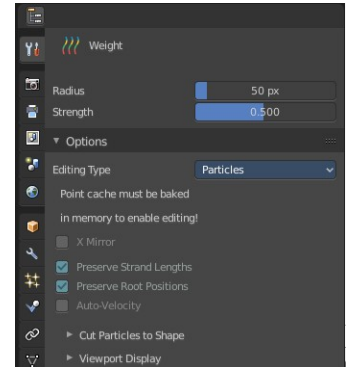

Particle Edit Mode - Options panel

This panel contains some further options for the particles.

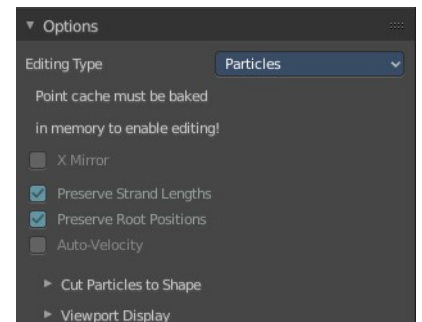

Note that you need to bake some particle types to be able to modify them. Emitter for example. You will get a warning then, and the Options panel content is greyed out.

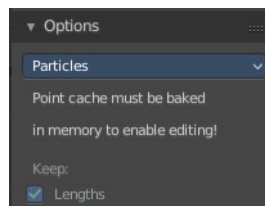

The particles can be baked in the Particles tab in the Cache panel.

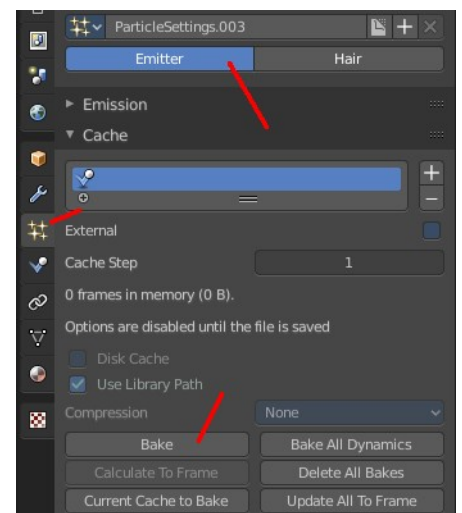

Particle Edit Type

The Particle Edit Type. This edit box just shows you what particle type you currently have. It does not allow you to change the particle type.

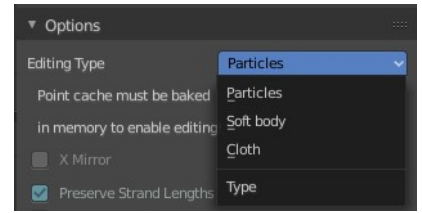

X Mirror

Mirrors the selected particles.

If you want a symmetrical haircut, first select all particles, then mirror the particles, then tick X Mirror.

Preserve Strand Lengths

Keep the path lengths constant.

Preserve Root Positions

Keep root keys unmodified.

Auto-Velocity

Calculate Point Velocity automatically.

Cut particles to Shape

Define an object to cut the hair particles into the shape of the object.

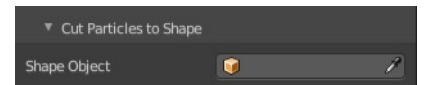

Viewport Display

With Hair

Path Steps

How many steps to display the path with. Meant is the resolution for the hair strains.

Children

Display all particles, including children. For performance reasons child particles are usually not displayed in the viewport.

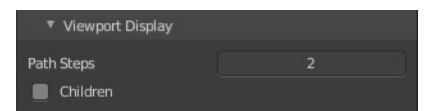

With Emitter

Path Steps

How many steps to display the emitter path with.

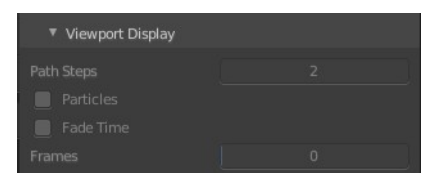

Particles

Display the actual particles.

Fade Time

Fade paths and keys further away from the current frame

Frames

How many frames to fade.

7.3.11 Editors - 3D Viewport - Sidebar - Tool Tab - Grease Pencil Object - Sculpt Mode

Table of content

Sculpt Mode.....	2
Sculpt Mode - Brushes Panel.....	2
Brush browser.....	2
Sculpt Mode - Brush Settings Panel - Smooth Brush.....	3
Radius.....	3
Strength.....	3
Sculpt Strokes sub panel.....	3
Affect Position.....	3
Affect Strength.....	3
Affect Thickness.....	3
Affect Pressure.....	3
Affect UV.....	3
Sculpt Mode - Brush Settings Panel - Thickness Brush.....	3
Radius.....	3
Strength.....	3
Add / Subtract.....	3
Sculpt Mode - Brush Settings Panel - Strength Brush.....	4
Radius.....	4
Strength.....	4
Add / Subtract.....	4
Sculpt Mode - Brush Settings Panel - Randomize Brush.....	4
Radius.....	4
Strength.....	4
Sculpt Strokes sub panel.....	4
Affect Position.....	4
Affect Strength.....	4
Affect Thickness.....	4
Affect UV.....	4
Sculpt Mode - Brush Settings Panel - Grab Brush.....	5
Radius.....	5
Strength.....	5
Sculpt Mode - Brush Settings Panel - Push Brush.....	5
Radius.....	5
Strength.....	5
Sculpt Mode - Brush Settings Panel - Twist Brush.....	5
Radius.....	5
Strength.....	5
Clockwise/Counter Clockwise.....	5
Pinch / Inflate.....	5
Sculpt Mode - Brush Settings Panel - Pinch Brush.....	6
Radius.....	6
Strength.....	6
Pinch / Inflate.....	6
Sculpt Mode - Brush Settings Panel - Clone Brush.....	6
Radius.....	6

Strength.....	6
Sculpt Mode - Brush Settings Panel - Cursor Sub panel.....	6
Show Brush.....	6
Cursor Color.....	6
Inverse Color.....	6
Grease Pencil - Weight Paint Mode.....	7
Weight Paint Mode - Brushes Panel.....	7
Brush browser.....	7
Weight Paint Mode - Brush Settings Panel.....	7
Radius.....	7
Strength.....	7
Weight.....	7
Use Falloff.....	7
Weight Paint Mode - Brush Settings Panel - Cursor Sub panel.....	7
Show Brush.....	7
Color.....	7
Sculpt Mode - Options panel.....	8
Auto Normalize.....	8

Sculpt Mode

In Sculpt mode you can sculpt the grease pencil strokes.

Sculpt Mode - Brushes Panel

Brush browser

Pick a pencil, and see what pencil is active.

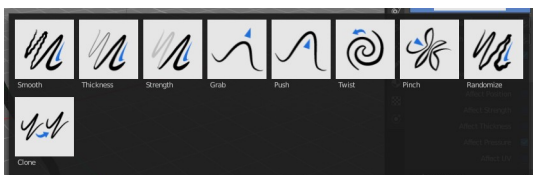

Sculpt Mode - Brush Settings Panel - Smooth Brush

Radius

The radius of the brush.

Strength

The strength of the brush.

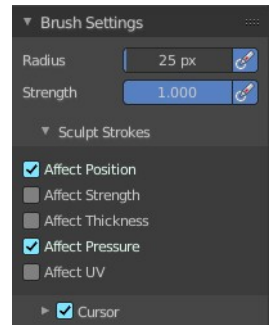

Sculpt Strokes sub panel

Affect Position

The brush affects the position of the point.

Affect Strength

The brush affects the color strength of the point.

Affect Thickness

The brush affects the thickness of the point.

Affect Pressure

The brush affects the pressure values as well when smoothing strokes.

Affect UV

The brush affects the UV rotation of the point.

Sculpt Mode - Brush Settings Panel - Thickness Brush

Radius

The radius of the brush.

Strength

The strength of the brush.

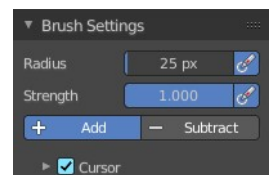

Add / Subtract

Thickness and Strength brush. If this brush should add or subtract to the



sculpt surface.

Sculpt Mode - Brush Settings Panel - Strength Brush

Radius

The radius of the brush.

Strength

The strength of the brush.

Add / Subtract

Thickness and Strength brush. If this brush should add or subtract to the sculpt surface.

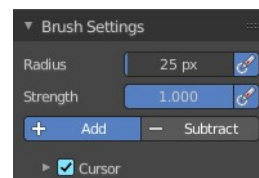

Sculpt Mode - Brush Settings Panel - Randomize Brush

Radius

The radius of the brush.

Strength

The strength of the brush.

Sculpt Strokes sub panel

Affect Position

The brush affects the position of the point.

Affect Strength

The brush affects the color strength of the point.

Affect Thickness

The brush affects the thickness of the point.

Affect UV

The brush affects the UV rotation of the point.

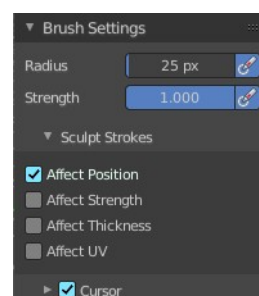

Sculpt Mode - Brush Settings Panel - Grab Brush

Radius

The radius of the brush.

Strength

The strength of the brush.

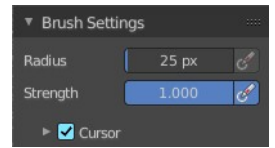

Sculpt Mode - Brush Settings Panel - Push Brush

Radius

The radius of the brush.

Strength

The strength of the brush.

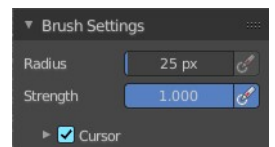

Sculpt Mode - Brush Settings Panel - Twist Brush

Radius

The radius of the brush.

Strength

The strength of the brush.

Clockwise/Counter Clockwise

If the twist goes clockwise or counter clockwise.

Pinch / Inflate

Pinch brush. If the brush should pinch or inflate.

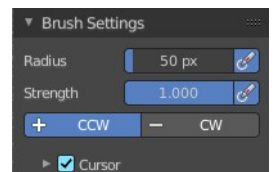

Sculpt Mode - Brush Settings Panel - Pinch Brush

Radius

The radius of the brush.

Strength

The strength of the brush.

Pinch / Inflate

Pinch brush. If the brush should pinch or inflate.

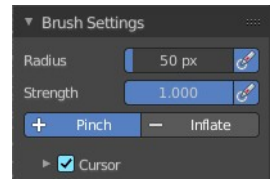

Sculpt Mode - Brush Settings Panel - Clone Brush

Radius

The radius of the brush.

Strength

The strength of the brush.

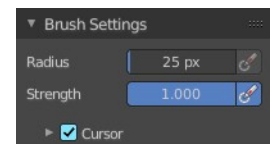

Sculpt Mode - Brush Settings Panel - Cursor Sub panel

This subpanel shows with all brushes in the Brush settings panel.

Show Brush

Show the brush icon when painting.

Cursor Color

The brush icon color with adding.

Inverse Color

The brush icon color with subtracting.

Inverse color does not show with all brushes. Just with Pinch for example.



Grease Pencil - Weight Paint Mode

In Weight Paint Mode you can weight paint your strokes.

Weight Paint Mode - Brushes Panel

Brush browser

Pick a pencil, and see what pencil is active. There is just one pencil available for weight painting.



Weight Paint Mode - Brush Settings Panel

Radius

The radius of the brush.

Strength

The strength of the brush.

Weight

The target weight. Everything below gets added towards this value. Everything above gets subtracted from this value. Usually you work with the maximum value of 1.

Use Falloff

Use Falloff for the brush.

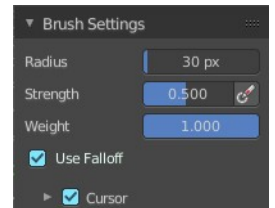

Weight Paint Mode - Brush Settings Panel - Cursor Sub panel

Show Brush

Show the brush icon when painting.

Color

The brush icon color.



Sculpt Mode - Options panel

Auto Normalize

Ensure that all bone deforming vertex groups adds up to 1.0 while weight painting.

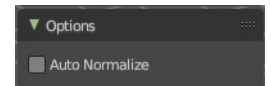



7.3.12 Editors - 3D Viewport - Sidebar - Tool Tab - Grease Pencil - Draw Mode

Table of content

Detailed table of content.....	1
Draw Mode.....	4
Brushes Panel.....	4
Brush settings Panel.....	5
Brush settings Panel - Advanced Sub panel.....	10
Brush settings Panel - Stroke Sub panel.....	12
Brush settings Panel - Curves Sub panel.....	14
Brush settings Panel - Cursor Sub panel.....	14
Color Panel.....	15
Color Panel - Palette sub panel.....	16

Detailed table of content

Detailed table of content

Detailed table of content.....	1
Draw Mode.....	4
Brushes Panel.....	4
Brush Browser.....	4
Brush Specials.....	4
Reset.....	4
Reset all Brushes.....	4
Custom Icon.....	5
Brush Name Edit Box.....	5
Brush settings Panel.....	5
Header - Add Brush Preset.....	5
Material Browser.....	5
Drop down box.....	6
Edit Box.....	6
With Draw Tools.....	6
Radius.....	6
Use Pressure.....	6
Radius Pressure Curve.....	6
Selecting Points.....	7
Adding Points.....	7
Navigation elements.....	7
Zoom in.....	7
Zoom out.....	7
Tools.....	7
Reset View.....	7
Vector Handle.....	7
Auto Handle.....	7
Auto Clamped Handle.....	7
Reset Curve.....	7

Clipping options.....	7
Delete Points.....	7
Strength.....	8
Use Pressure.....	8
Strength Pressure Curve.....	8
Selecting Points.....	8
Adding Points.....	8
Navigation elements.....	8
Zoom in.....	8
Zoom out.....	8
Tools.....	8
Reset View.....	8
Vector Handle.....	8
Auto Handle.....	8
Auto Clamped Handle.....	9
Reset Curve.....	9
Clipping options.....	9
Delete Points.....	9
Caps Type.....	9
With Fill Tool.....	9
Direction.....	9
Precision.....	9
Leak Size.....	9
Thickness.....	9
With Eraser Tools.....	9
Radius.....	9
Use Pressure.....	9
Occlude Eraser.....	9
Default Eraser.....	10
Mode.....	10
Dissolve.....	10
Point.....	10
Stroke.....	10
Display Cursor.....	10
Brush settings Panel - Advanced Sub panel.....	10
With Draw Tool.....	10
Mode.....	10
Active.....	10
Material.....	10
Vertex Color.....	10
Input Samples.....	10
Active Smooth.....	10
Angle.....	11
Factor.....	11
Border Opacity Factor.....	11
Aspect Ratio X / Y.....	11
With Fill Tool.....	11
Boundary.....	11
Layers.....	11
Stroke Extension.....	11
Show Extend Lines.....	11
Simplify.....	12
Show Fill.....	12

Threshold.....	12
Limit to Viewport.....	12
Brush settings Panel - Stroke Sub panel.....	12
Post Processing.....	12
Smooth.....	12
Iterations.....	12
Smooth Thickness.....	12
Iterations.....	12
Subdivision Steps.....	12
Randomness.....	12
Simplify.....	13
Trim Stroke Ends.....	13
Randomize.....	13
Pressure.....	13
Strength.....	13
UV.....	13
Jitter.....	13
Use Pressure.....	13
Stabilize Stroke.....	13
Radius.....	13
Factor.....	13
Brush settings Panel - Curves Sub panel.....	14
Navigation elements.....	14
Zoom in and out.....	14
Tools.....	14
Reset View.....	14
Vector Handle.....	14
Auto Handle.....	14
Auto Clamped Handle.....	14
Reset Curve.....	14
Use Clipping.....	14
Delete Points.....	14
Brush settings Panel - Cursor Sub panel.....	14
Show Fill Color while drawing.....	15
Color Panel.....	15
Material / Vertex Color.....	15
Color picker.....	15
Active color.....	15
Brush colors flip.....	15
Mode.....	15
Mix Factor.....	15
Color Panel - Palette sub panel.....	16
Palette browser.....	16
Edit Box.....	16
Number of users.....	16
Fake User.....	16
Add palette.....	16
Remove Palette.....	16
New Palette color.....	16
Delete Palette color.....	16
Move Palette Color up and down.....	17
Sort By.....	17
Palette Colors.....	17

Draw Mode

Just the grease Pencil object has a Draw mode.

The Grease Pencil Object allows you to draw in 2D in the workspace.

It starts as an object type. By switching into paint mode it becomes a paint feature. And editing turns it into a curve or a mesh object then.

In the Tools tab you will find all the options and settings for drawing and manipulating the grease pencil object, means your drawing.

The type **Blank** allows you to draw strokes.

The type **Stroke** allows you to draw filled forms.

The type **Monkey** is just an example object.

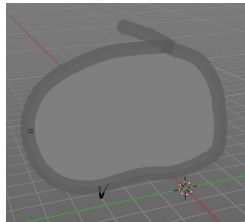
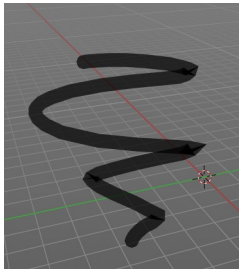
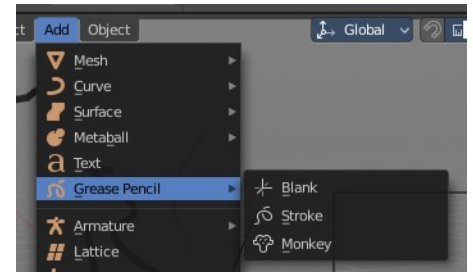

Brushes Panel

Brush Browser

Choose between the different draw, fill and erase brushes. It's the same than in the tool shelf.

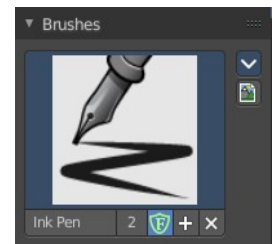
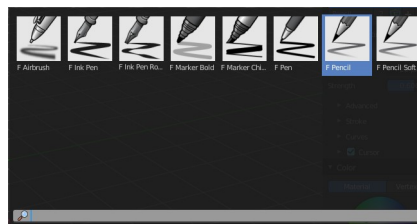

Brush Specials

Reset

Reverts the brush to the factory settings.

Reset all Brushes

Reverts all brushes to the factory settings.

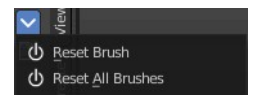

Custom Icon

The button at the right allows you to load a custom icon for your brush. It reveals a file browser below the image browser.

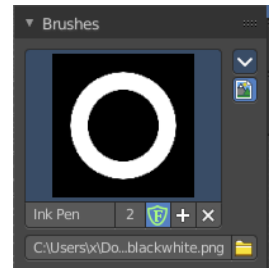

Brush Name Edit Box

The edit box below the Image shows you the name of the current active brush.

The number right of it, **in this case 2**, indicates how much number of users (internally) this brush uses. This means that this data block (the brush) shares currently settings with at least one other object. Most probably the parent brush where we have created it from. Click at the value to make this brush a single user. The button will vanish then.

Fake User set the brush to have a fake user. Zero user data-blocks are normally not saved. But sometimes you want to force the data to be kept even when the data block has no user.

The + button allows you to add a new pencil with the current settings. Note that the brushes are NOT saved when you close Bforartists. You can save them into the current blend file. Or you can save the startup file. But be careful here. This saves everything else of the current state of Bforartists too.

The X button deletes the brush as the active one. It does NOT delete it from the brushes list.

Brush settings Panel

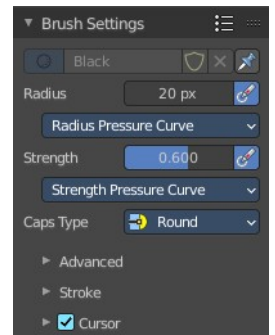

Header - Add Brush Preset

In the header is a brush preset menu where you can store and load custom brush presets. The dialog should be self explaining. In the edit box you type in the name of your new preset. And with clicking at the + button the new preset gets stored. Existing presets can be removed by clicking at the - button at the right side of the preset.

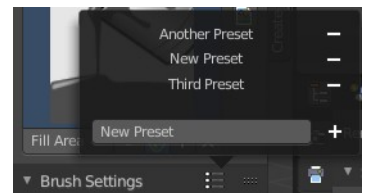

Material Browser

This browser is just active when the Keep material assigned to Brush Pin is activated.

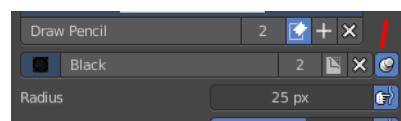

The colors for the grease pencil are materials each. For the grease pencil type Blank you will just have one color available. For this type you have to create new materials in the material tab first when you need more colors. But the other

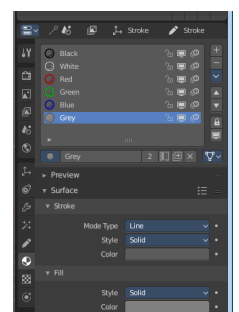

two types, strokes and monkey, comes with a few base materials already. Which can be found in the Materials tab.

The tool settings above the header shows this panel too. And here you can quickly change the color of a material. It is explained in the chapter Materials Tab.

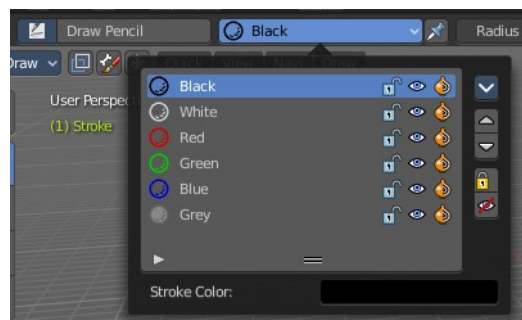

Drop down box

Choose another material to draw with.

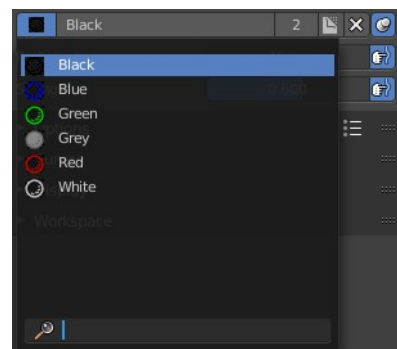

Edit Box

Read and modify the material name.

For set the material to have a fake user. Zero user data-blocks are normally not saved. But sometimes you want to force the data to be kept even when the data block has no user.

The X button deletes the material as the active one. It does NOT delete it from the materials list.

Keep material assigned to Brush Pin pins the brush to this material.

With Draw Tools

Radius

The Radius edit box allows you to adjust the radius of the brush.

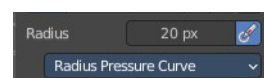

Use Pressure

The button behind the edit box enables tablet pressure sensitivity for radius.

Radius Pressure Curve

The pressure curve allows you to adjust the falloff curve for the tablet pressure. It shows when Use Pressure is activated. The curve panel shows when clicking at the button.

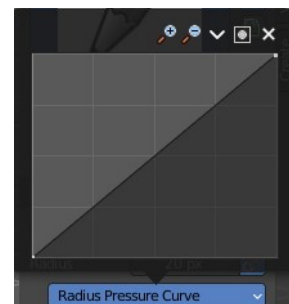

Selecting Points

You can select curve points. This reveals two edit boxes for the x and y coordinate of this point.

Selected points can be moved around. Left click at them, hold the mouse button down and move them to a new location.

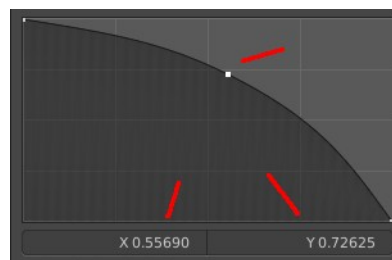

Adding Points

You can add new curve points by simply left clicking at the curve. Move the mouse to position them where you need it.

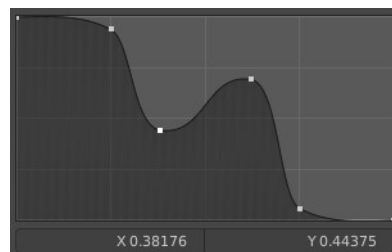

Navigation elements

Zoom in

Zooms in.

Zoom out

Zooms out.



Tools

Tools is a menu where you can find some curve related tools.

Reset View

Resets the curve windows zoom.

Vector Handle

Set handle type to Vector.

Auto Handle

Set handle type to Auto.

Auto Clamped Handle

Set handle type to Auto Clamped.

Reset Curve

Resets the curve to the initial shape.



Clipping options

Set up clipping for the stroke.

Delete Points

Deletes the selected curve point.

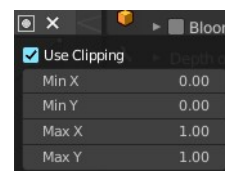

Strength

The Strength edit box allows you to adjust the strength of the brush.



Use Pressure

The button behind the edit box enables tablet pressure sensitivity for strength.

Strength Pressure Curve

The pressure curve allows you to adjust the falloff curve for the tablet pressure. It shows when Use Pressure is activated. The curve panel shows when clicking at the button.

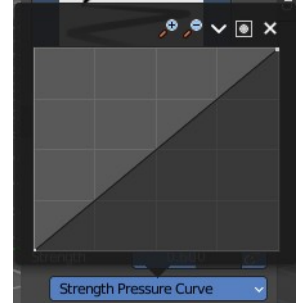

Selecting Points

You can select curve points. This reveals two edit boxes for the x and y coordinate of this point.

Selected points can be moved around. Left click at them, hold the mouse button down and move them to a new location.

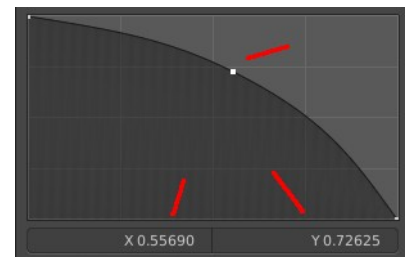

Adding Points

You can add new curve points by simply left clicking at the curve. Move the mouse to position them where you need it.

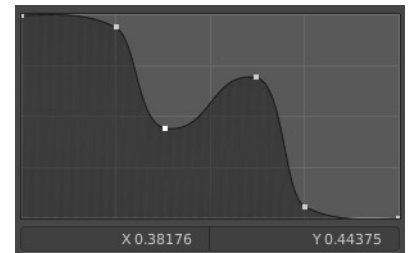

Navigation elements

Zoom in

Zooms in.

Zoom out

Zooms out.

Tools

Tools is a menu where you can find some curve related tools.

Reset View

Resets the curve windows zoom.

Vector Handle

Set handle type to Vector.

Auto Handle

Set handle type to Auto.

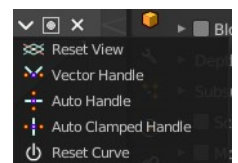

Auto Clamped Handle

Set handle type to Auto Clamped.

Reset Curve

Resets the curve to the initial shape.

Clipping options

Set up clipping for the stroke.

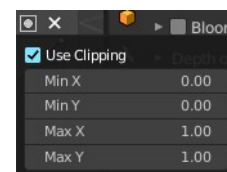

Delete Points

Deletes the selected curve point.

Caps Type

What caps type to use at the end of the grease pencil stroke. Flat or round

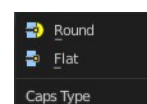

With Fill Tool

Note that the Fill tool does not fill an existing stroke like you would expect. It extends existing strokes with closed areas, or the border.

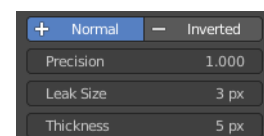

Direction

The fill direction. Fill internal or inverted.

Precision

Factor for fill boundary accuracy. Higher values are more accurate but slower.

Leak Size

Size in pixels to consider the leak closed.

Thickness

The thickness of the new created stroke drawn with the fill tool around existing strokes or the border.

With Eraser Tools

Radius

The radius of the eraser brush.

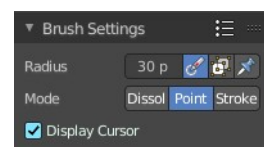

Use Pressure

The button behind the edit box enables tablet pressure sensitivity for strength.

Occlude Eraser

Erase only visible and not occluded strokes.

Default Eraser

Use this brush when you enable the eraser with fast switch key.

Note! Whatever this means. There is no fast switch key. This functionality is not documented in the Blender manual, and it is not to find out what is meant.

Mode

Dissolve

Erase strokes, fading their points strength and thickness.

Point

Erase stroke points.

Stroke

Erase entire strokes.

Display Cursor

Show the eraser cursor.

Brush settings Panel - Advanced Sub panel

With Draw Tool

Mode

What draw mode to use.

Active

Use the current active draw mode.

Material

Draw with material colors.

Vertex Color

Draw with Vertex colors.

Input Samples

Generate intermediate Points for very fast mouse movements. A value of 0 means this feature is disabled.

Active Smooth

The amount of smoothing the strokes while drawing.

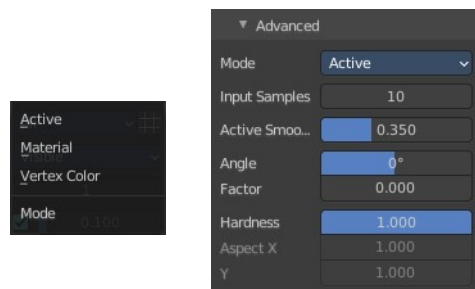

Angle

Direction of the stroke at which it gives the biggest thickness.

Factor

Reduce the brush thickness by this amount when the stroke is perpendicular to "Angle" direction.

Border Opacity Factor

Amount of transparency (alpha) to apply from the border of the point to the center. Works only when the brush is using stroke materials of Dot or Box style.

Aspect Ratio X / Y

The width and height of the alpha gradient.

It is unfortunately not to find out where this ominous Dot or Box Style material is to find or to create. So please ignore this settings for now. They are greyed out anyways. Maybe this will solve itself at a later development state.

With Fill Tool

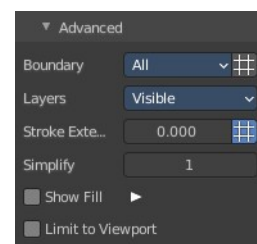

Boundary

The mode to draw the boundary lines.

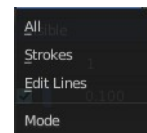

Layers

What layers to use as boundaries.

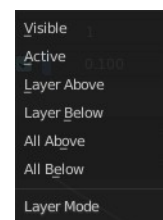

Stroke Extension

Stroke End Extension for closing gaps. Zero disables the stroke extension.

Show Extend Lines

Show help lines for filling to see boundaries.

Simplify

Number of simplify steps. Large values reduces Fill accuracy.

Show Fill

Show transparent lines to use as boundary for filling.



Threshold

The threshold to consider the color to be transparent for filling.

Limit to Viewport

Threshold to consider a color as transparent for filling.

Brush settings Panel - Stroke Sub panel

Here you will find some further stroke related settings. It has three sub sections. Post Processing, Randomize and Stabilize Stroke.

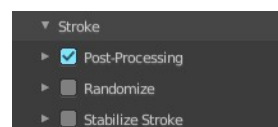

Post Processing

Here you find some post processing settings for new strokes.

Smooth

The smooth amount to reduce jittering.

Iterations

Number of iterations to smooth new created strokes.

Smooth Thickness

Amount of thickness smoothing to reduce jittering.

Iterations

Number of iterations to smooth new created strokes.

Subdivision Steps

Number of subdivisions of new created strokes

Randomness

Randomness factor for new created strokes after subdivision.

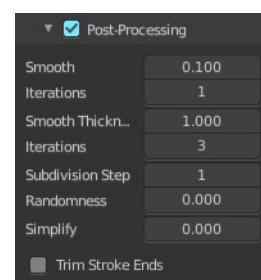

Simplify

Simplify new created strokes.

Trim Stroke Ends

Trim intersecting stroke ends.

Randomize

Add some randomization to the stroke.

Pressure

Randomize the pressure.

Strength

Randomize the strength.

UV

Randomize the auto generated UV rotation.

Jitter

Add Jitter

Use Pressure

The button behind the edit box enables tablet pressure sensitivity.

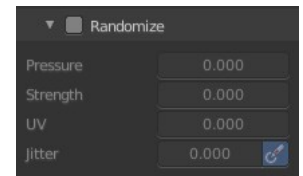

Stabilize Stroke

Draw lines with a delay to allow smooth strokes.

Radius

The minimum distance from last point before the stroke continues.

Factor

Smooth stroke factor. Higher values gives smoother stroke.

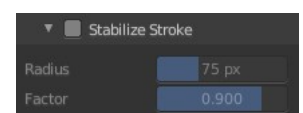

Brush settings Panel - Curves Sub panel

See and manipulate the curves for drawing Sensitivity, Strength and Jitter.

The navigation elements are the same for all three curve types.

Navigation elements

The navigation elements at the top are described from left to right.

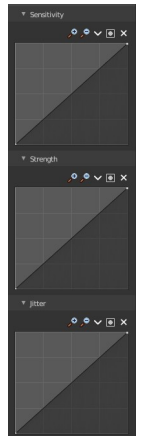
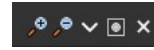

Zoom in and out

The two buttons with the magnifying glass at it zooms in and out in the curve window.

Tools

Tools is a menu where you can find some curve related tools.

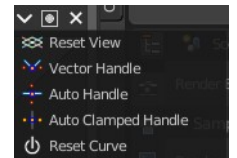

Reset View

Resets the curve windows zoom.

Vector Handle

Set handle type to Vector.

Auto Handle

Set handle type to Auto.

Auto Clamped Handle

Set handle type to Auto Clamped.

Reset Curve

Resets the curve to the initial shape.

Use Clipping

Clipping options. Set up clipping for the stroke.

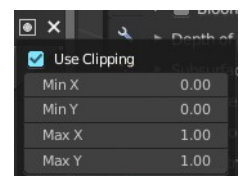

Delete Points

Deletes selected curve points.

Brush settings Panel - Cursor Sub panel

Show the brush cursor under the mouse.



Show Fill Color while drawing

Show the fill color of the grease pencil while drawing.

Color Panel

The default grease pencil color is based at materials. And then this panel is greyed out and dysfunctional. But you can also choose to work with vertex colors instead. And then all the color panel features becomes activated.

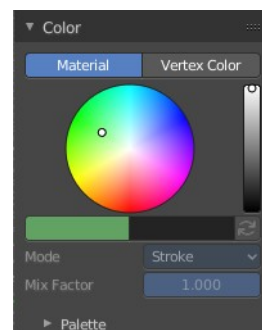

Material / Vertex Color

Choose if you want to work with material based colors or with vertex colors. Turn it to vertex colors to activate the features.

This can also be done in the tool settings in the header.



Color picker

Define the color for your brush.

Active color

The active color is the left one. When you click the button with the two arrows down right then you can swap the color with the secondary color. Then this secondary color becomes the primary color, and is active.

A click at one of the color fields will open a more detailed color dialog, to Set up the color by using rgb, hsv and hex colors and with value sliders.

Brush colors flip

Flips the primary color with the secondary color.

Mode

How the vertex color is applied.

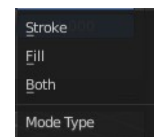

Mix Factor

Factor used to mix the vertex color to get final color.

Color Panel - Palette sub panel

Here you will find a predefined color palette, and here you can create a color palette for later reuse.

The color palette cannot be saved externally. It is part of the current blend file. You can however append color palettes from other blend files.

The currently active color is the one with the triangle at it.

The elements are explained from left to right and from top to bottom.

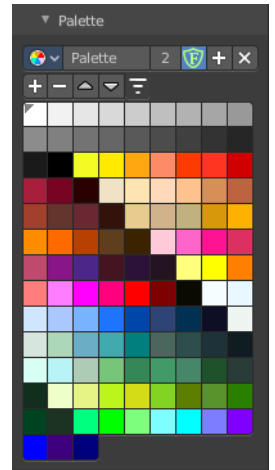

Palette browser

The button at the left opens a drop down list to choose between your palettes.

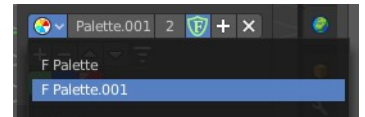

Edit Box

Read the name of the currently active palette. You can also rename the palette here. A click into the edit box makes the name editable.

Number of users

See how many users the palette currently has.

Fake User

Fake User sets the element to have a fake user. Zero user data-blocks are normally not saved. But sometimes you want to force the data to be kept even when the data block has no user.

Add palette

Add a new palette.

Remove Palette

Clicking at this button removes the palette. Note that you need to save, close Bforartists and reload the blend file to remove the palette completely.

New Palette color

Adjust a color in the color picker. Then click at the add button to add this color to the palette.

Delete Palette color

Select the color in the palette, then click at the minus button to remove it.

Move Palette Color up and down

With these two buttons you can move the active color up or down in the palette.

Sort By

Sort the palette by different methods.



Palette Colors

The actual list of the current palette colors. Click at one to make it the active one that gets used for painting.

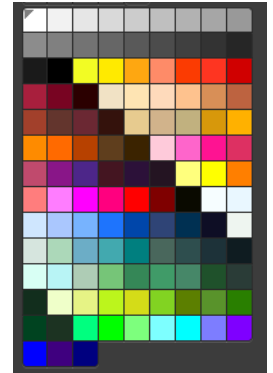



7.3.13 Editors - 3D Viewport - Sidebar - Tool Tab - Grease Pencil - Vertex Paint Mode

Table of content

Grease Pencil - Vertex Paint Mode.....	2
Brushes Panel.....	2
Brush Browser.....	2
Brush Specials.....	2
Reset.....	2
Reset all Brushes.....	2
Custom Icon.....	2
Brush Name Edit Box.....	2
Brush Settings Panel.....	3
Radius.....	3
Use Pressure.....	3
Strength.....	3
Use Pressure.....	3
Brush Settings Panel - Cursor Sub panel.....	3
Show Brush.....	3
Color.....	3
Color Panel.....	3
Material / Vertex Color.....	3
Color picker.....	3
Active color.....	4
Brush colors flip.....	4
Mode.....	4
Mix Factor.....	4
Color Panel - Palette sub panel.....	4
Palette browser.....	4
Edit Box.....	4
Number of users.....	4
Fake User.....	5
Add palette.....	5
Remove Palette.....	5
New Palette color.....	5
Delete Palette color.....	5
Move Palette Color up and down.....	5
Sort By.....	5
Palette Colors.....	5
Falloff Panel.....	5

Grease Pencil - Vertex Paint Mode

In draw mode you can paint whole strokes with vertex color. In Vertex Paint mode you can paint the single vertices of a stroke with vertex color.

Brushes Panel

Brush Browser

Choose between the different draw, fill and erase brushes. It's the same than in the tool shelf.

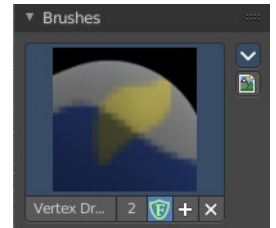

Brush Specials

Reset

Reverts the brush to the factory settings.

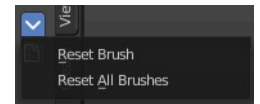

Reset all Brushes

Reverts all brushes to the factory settings.

Custom Icon

The button at the right allows you to load a custom icon for your brush. It reveals a file browser below the image browser.

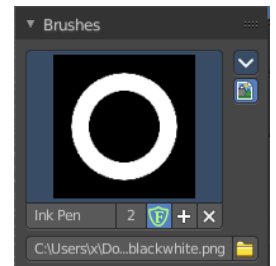

Brush Name Edit Box

The edit box below the Image shows you the name of the current active brush.

The number right of it, **in this case 2**, indicates how much number of users (internally) this brush uses. This means that this data block (the brush) shares currently settings with at least one other object. Most probably the parent brush where we have created it from. Click at the value to make this brush a single user. The button will vanish then.

Fake User set the brush to have a fake user. Zero user data-blocks are normally not saved. But sometimes you want to force the data to be kept even when the data block has no user.

The + button allows you to add a new pencil with the current settings. Note that the brushes are NOT saved when you close Bforartists. You can save them into the current blend file. Or you can save the startup file. But be careful here. This saves everything else of the current state of Bforartists too.

The X button deletes the brush as the active one. It does NOT delete it from the

Brush Settings Panel

Radius

The radius of the brush.

Use Pressure

Use tablet pressure.

Strength

The strength of the brush.

Use Pressure

Use tablet pressure.

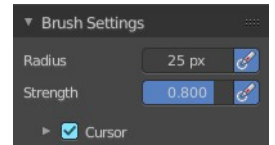

Brush Settings Panel - Cursor Sub panel

Show Brush

Show the brush icon when painting.

Color

The brush icon color.

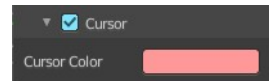

Color Panel

The default grease pencil color is based at materials. And then this panel is greyed out and dysfunctional. But you can also choose to work with vertex colors instead. And then all the color panel features becomes activated.

Material / Vertex Color

Choose if you want to work with material based colors or with vertex colors. Turn it to vertex colors to activate the features.

This can also be done in the tool settings in the header.

Color picker

Define the color for your brush.

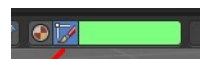

Active color

The active color is the left one. When you click the button with the two arrows down right then you can swap the color with the secondary color. Then this secondary color becomes the primary color, and is active.

A click at one of the color fields will open a more detailed color dialog, where you can set up the color by using rgb, hsv and hex colors and with value sliders.

Brush colors flip

Flips the primary color with the secondary color.

Mode

How the vertex color is applied.

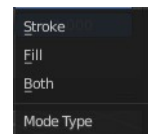

Mix Factor

Factor used to mix the vertex color to get final color.

Color Panel - Palette sub panel

Here you will find a predefined color palette, and here you can create a color palette for later reuse.

The color palette cannot be saved externally. It is part of the current blend file. You can however append color palettes from other blend files.

The currently active color is the one with the triangle at it.

The elements are explained from left to right and from top to bottom.



Palette browser

The button at the left opens a drop down list to choose between your palettes.

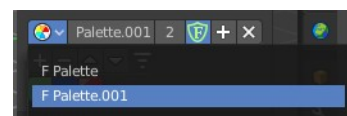

Edit Box

Read the name of the currently active palette. You can also rename the palette here. A click into the edit box makes the name editable.

Number of users

The number of users the palette currently has.

Fake User

Fake User sets the element to have a fake user. Zero user data-blocks are normally not saved. But sometimes you want to force the data to be kept even when the data block has no user.

Add palette

Add a new palette.

Remove Palette

Clicking at this button removes the palette. Note that you need to save, close Bforartists and reload the blend file to remove the palette completely.

New Palette color

Adjust a color in the color picker. Then click at the add button to add this color to the palette.

Delete Palette color

Select the color in the palette, then click at the minus button to remove it.

Move Palette Color up and down

With these two buttons you can move the active color up or down in the palette.

Sort By

Sort the palette by different methods.

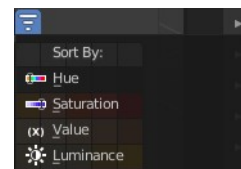

Palette Colors

The actual list of the current palette colors. Click at one to make it the active one that gets used for painting.

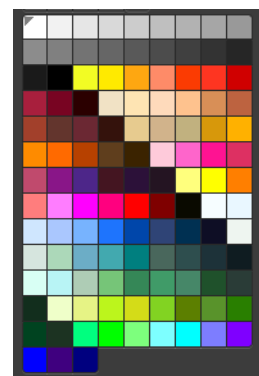

Falloff Panel

Adjust the brush falloff.

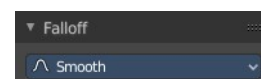

7.3.14 Editors - 3D Viewport - Sidebar - Tool Tab - Grease Pencil - Weight Paint Mode

Table of content

Grease Pencil - Weight Paint Mode.....	1
Weight Paint Mode - Brushes Panel.....	1
Brush browser.....	1
Weight Paint Mode - Brush Settings Panel.....	1
Radius.....	1
Strength.....	1
Weight.....	2
Use Falloff.....	2
Weight Paint Mode - Brush Settings Panel - Cursor Sub panel.....	2
Show Brush.....	2
Color.....	2

Grease Pencil - Weight Paint Mode

The Tools tab in Weight Paint Mode provides you the tools to do weight painting at a mesh. Skinned characters for example. Also grease pencil strokes can be skinned to a skeleton. In Weight Paint Mode you can weight paint your strokes.

Weight Paint Mode - Brushes Panel

Brush browser

Pick a pencil, and see what pencil is active. There is just one pencil available for weight painting.



Weight Paint Mode - Brush Settings Panel

Radius

The radius of the brush.

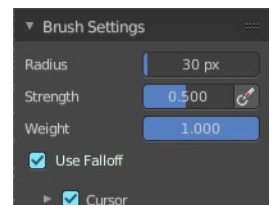

Strength

The strength of the brush.

Weight

The target weight. Everything below gets added towards this value. Everything above gets subtracted from this value. Usually you work with the maximum value of 1.

Use Falloff

Use Falloff for the brush.

Weight Paint Mode - Brush Settings Panel - Cursor Sub panel

Show Brush

Show the brush icon when painting.



Color

The brush icon color.

7.3.15 Editors - 3D Viewport - Sidebar - Tool Tab - Grease Pencil - Layer Panel

Table of content

Layer Panel.....	1
Layer list.....	2
Layer name.....	2
Mask Layer.....	2
Onion Skinning.....	2
Viewport/Render Visibility.....	2
Lock.....	2
Search Field.....	2
Add new layer.....	2
Remove layer.....	2
Layer Specials.....	2
Duplicate Layer.....	2
Show All.....	2
Hide Others.....	2
Lock All.....	2
Unlock All.....	3
Autolock inactive layer.....	3
Merge Down.....	3
Copy Layer to Object.....	3
Isolate Layer.....	3
Isolate Layer.....	3
Blend.....	3
Opacity.....	3
Mask Layer.....	3
Use Lights.....	3

Layer Panel

The content of the Tool tab in the sidebar and the tool settings above the 3D view is usually equal. The Layer panel is a special panel in this regards. It just exists in the tool settings above the 3Dview. And it exists in all grease pencil modes but the object mode.

Grease Pencil objects each have a list of 2D layers for grouping and arranging strokes in a List view. Any stroke can only belong to a single 2D layer. There is always only one active layer in the list (the selected one). When you draw, the new strokes are added to the active layer. By default the view order of the layers in the viewport is top to bottom.

Every layer correspond to a channel in the Dope Sheet editor (in Grease Pencil mode). Layers can also be used together with Modifiers to only affects part of your drawing.

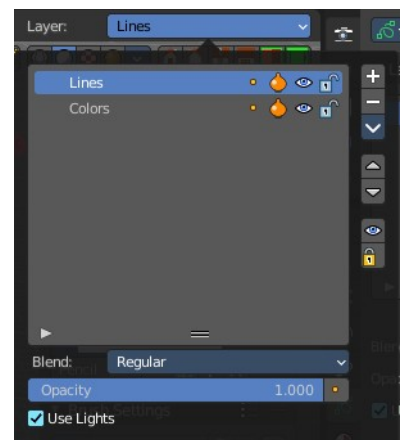

Layer list

Layer name

The name of the layer.

Mask Layer

Toggle the Masks visibility in the layer.

Onion Skinning

Toggle the use the layer for Onion Skinning.

Viewport/Render Visibility

Toggle layer visibility in the viewport and in render.

Lock

Toggle layer from being editable.

Search Field

You can expand a search field at the bottom of the list. Type in your term and hit enter to filter for your term.



Add new layer

Adds a new layer.

Remove layer

Removes the selected layer.

Layer Specials

Duplicate Layer

Makes an exact copy of the selected layer appending a number to differentiate its name.

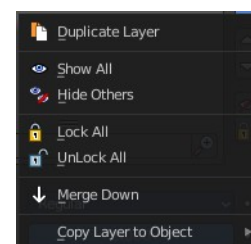

Show All

Turns on the visibility of every layer in the list.

Hide Others

Turns off the visibility of every layer in the list except the active one.

Lock All

Locks edition of all the layers in the list

Unlock All

Unlocks edition of all the layers in the list.

Autolock inactive layer

Locks automatically the edition of every layer in the list except the active one. This way you avoid to make unwanted changes in other layers without the need to lock them every time.

Merge Down

Merge the selected layer with the layer below, the new layer keeps the name of the lower layer.

Copy Layer to Object

Makes a copy of the layer and move it to the selected Grease Pencil object.

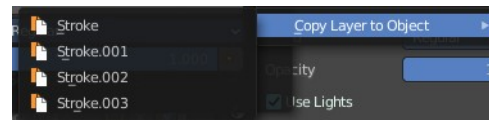

Isolate Layer

Hide and lock the layer.

Isolate Layer

Lock the layer.

Blend

The layer blending operation to perform. See Color Blend Modes.

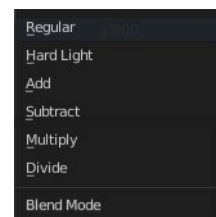

Opacity

Used to set the opacity of the layer.

Mask Layer

Toggle the Masks visibility in the layer.

Use Lights

When enabled, the layer is affected by lights.



7.3.16 Editors - 3D Viewport - Sidebar - Tool Tab - Hair Curve - Sculpt Mode

Table of content

Sculpt Mode.....	3
Sculpt Mode - Brushes Panel.....	3
Brushes browser.....	3
Select Mode.....	3
Control Point.....	3
Curves.....	4
Selection Paint.....	4
Radius.....	4
Strength.....	4
Direction.....	4
Use Sculpt Collision.....	4
Add.....	5
Radius.....	5
Strength.....	5
Use Sculpt Collision.....	5
Count.....	5
Interpolate.....	5
Length.....	5
Shape.....	5
Point Cloud.....	5
Curve Length.....	5
Points per Curve.....	5
Delete.....	6
Radius.....	6
Strength.....	6
Use Sculpt Collision.....	6
Density.....	6
Radius.....	6
Strength.....	6
Use Sculpt Collision.....	7
Comb.....	7
Radius.....	7
Strength.....	7
Use Sculpt Collision.....	7
Snake Hook.....	8
Radius.....	8
Strength.....	8
Use Sculpt Collision.....	8
Grow/Shrink.....	8
Radius.....	8
Strength.....	8
Direction.....	8
Use Sculpt Collision.....	9
Scale Uniform.....	9
Minimum Length.....	9

Pinch.....	9
Radius.....	9
Strength.....	9
Use Sculpt Collision.....	9
Puff.....	10
Radius.....	10
Strength.....	10
Use Sculpt Collision.....	10
Smooth.....	10
Radius.....	10
Strength.....	10
Use Sculpt Collision.....	11
Slide.....	11
Radius.....	11
Strength.....	11
Use Sculpt Collision.....	11
Stroke Sub panel.....	11
Stroke Method.....	11
Dots.....	11
Jitter.....	12
Jitter Unit.....	12
Input Samples.....	12
Stabilize Stroke.....	12
Radius.....	12
Factor.....	12
Space.....	12
Spacing.....	12
Dash Ratio.....	12
Dash Length.....	12
Jitter.....	12
Jitter Unit.....	12
Input Samples.....	13
Stabilize Stroke.....	13
Radius.....	13
Factor.....	13
Airbrush.....	13
Rate.....	13
Jitter.....	13
Jitter Unit.....	13
Input Samples.....	13
Stabilize Stroke.....	13
Radius.....	13
Factor.....	13
Line.....	14
Spacing.....	14
Dash Ratio.....	14
Dash Length.....	14
Jitter.....	14
Jitter Unit.....	14
Input Samples.....	14
Curve.....	14
Spacing.....	14
Paint Curve Data.....	14

Dash Ratio.....	14
Dash Length.....	14
Jitter.....	14
Jitter Unit.....	15
Input Samples.....	15
Falloff Sub panel.....	15
Curve Preset.....	15
Zoom In.....	15
Zoom Out.....	15
Clipping Options.....	15
Reset View.....	15
Reset Curve.....	15
Presets.....	16
Cursor Sub panel.....	16
Show Brush.....	16
Cursor Color.....	16
Falloff Opacity.....	16
Override Overlay.....	16
Use Cursor Overlay.....	16

Sculpt Mode

In Sculpt mode you can sculpt the hair curves.

Sculpt Mode - Brushes Panel

Brushes browser

You can create and manage brush settings from the brush browser and see what brush is active.

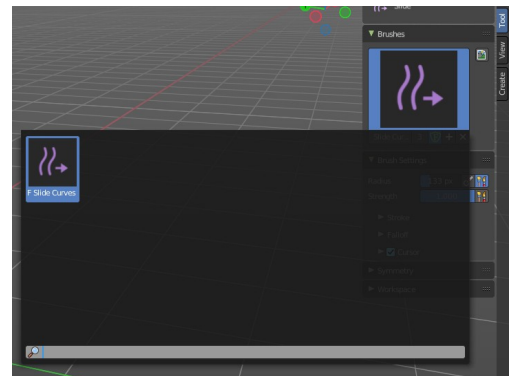

Select Mode

Change the mode used for selection masking in curves sculpt mode.

This toggles two methods of how the brushes interact with the hair curves. They can either be selected and manipulated by control points or the complete hair curve.



Control Point

Use the masked selection of the Selection Paint brush. Whatever is opaqued by dark grey is locked. Brush will only affect unlocked areas of the selection. You can modify the selection from the Select menu mentioned in

chapter 7.1.42 Editors - 3D Viewport - Header - Hair Curve - Sculpt mode - Curves menu

Curves

Uses the complete hair curve with the evaluation of the brush. You can modify the selection from the Select menu mentioned in chapter 7.1.42 Editors - 3D Viewport - Header - Hair Curve - Sculpt mode - Curves menu

Selection Paint

Radius

The radius of the brush.

Strength

The strength of the brush.

Direction

The direction of the brush selection, if it is additive or subtractive by adding or subtracting to the selected curves or control points.

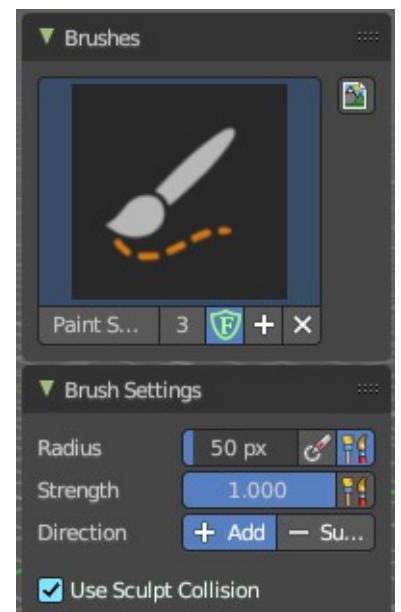

Use Sculpt Collision

Enable the collision of the hair curve particles with the surface.

This option can also be found in the tool settings in the upper right corner as a button only.

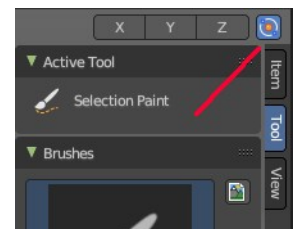

Add

Radius

The radius of the brush.

Strength

The strength of the brush.

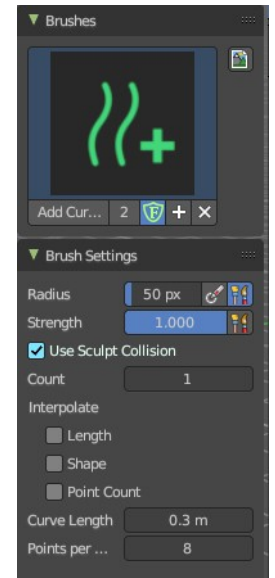

Use Sculpt Collision

Enable the collision of the hair curve particles with the surface.

This option can also be found in the tool settings in the upper right corner as a button only.

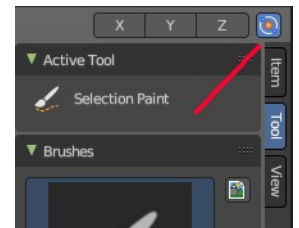

Count

Number of curves added by the add brush.

Interpolate

Length

Use length of the curve in close proximity.

Shape

Use shape of the curve in close proximity.

Point Cloud

Use the number of points from the curve in close proximity.

Curve Length

Length of the newly added curves when it is not interpolated from other curves.

Points per Curve

Number of control points in a newly added curve.

Delete

Radius

The radius of the brush.

Strength

The strength of the brush.

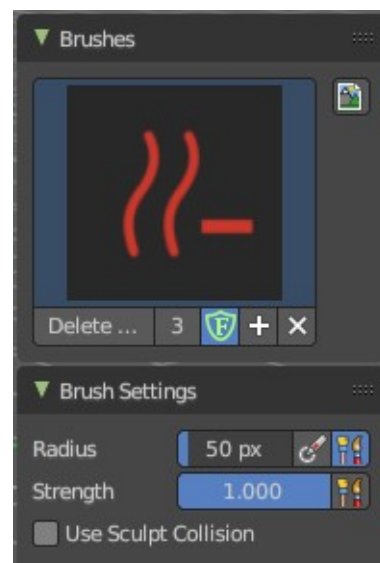

Use Sculpt Collision

Enable the collision of the hair curve particles with the surface.

This option can also be found in the tool settings in the upper right corner as a button only.

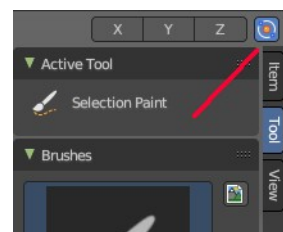

Density

Radius

The radius of the brush.

Strength

The strength of the brush.

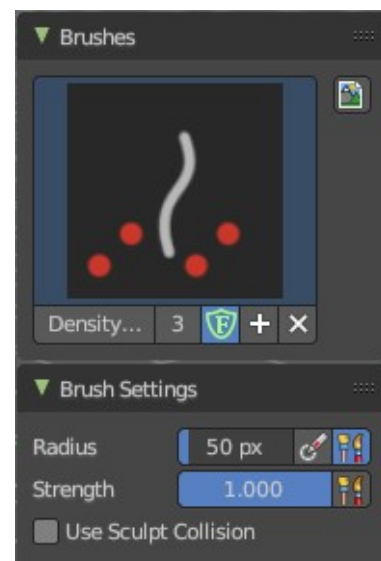

Use Sculpt Collision

Enable the collision of the hair curve particles with the surface.

This option can also be found in the tool settings in the upper right corner as a button only.

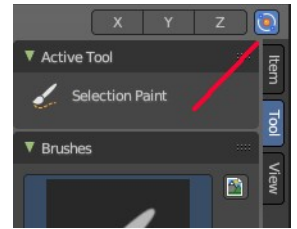

Comb

Radius

The radius of the brush.

Strength

The strength of the brush.

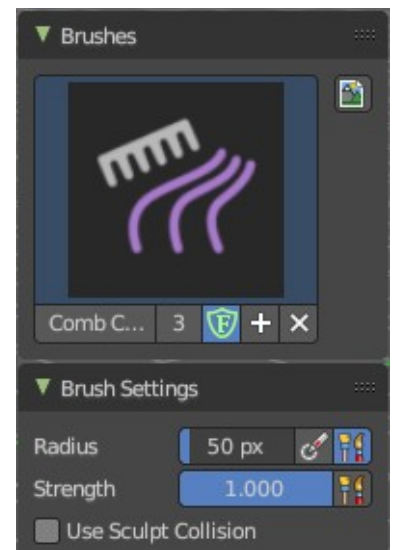

Use Sculpt Collision

Enable the collision of the hair curve particles with the surface.

This option can also be found in the tool settings in the upper right corner as a button only.

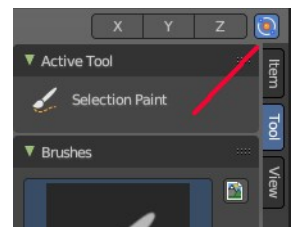

Snake Hook

Radius

The radius of the brush.

Strength

The strength of the brush.

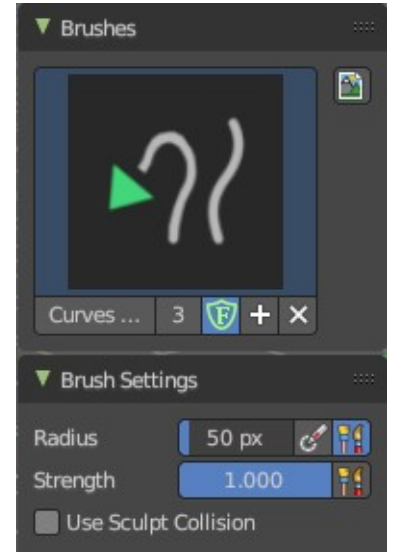

Use Sculpt Collision

Enable the collision of the hair curve particles with the surface.

This option can also be found in the tool settings in the upper right corner as a button only.

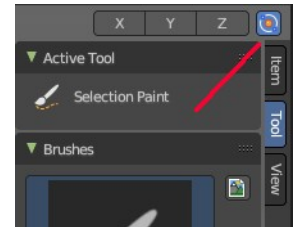

Grow/Shrink

Radius

The radius of the brush.

Strength

The strength of the brush.

Direction

Add or subtract the effect of the brush. Add grows hair curves, Subtract shorten the hair curves.

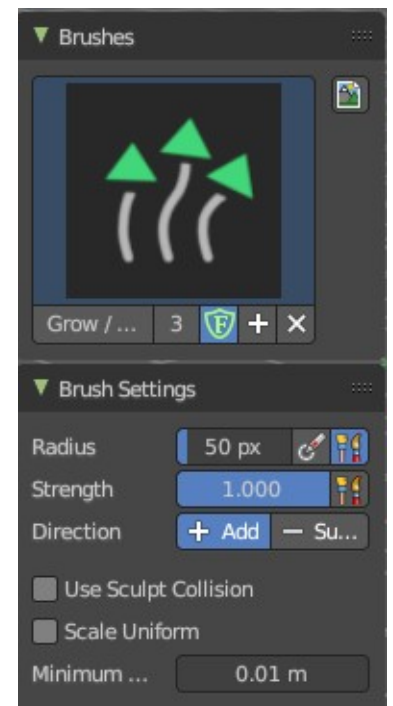

Use Sculpt Collision

Enable the collision of the hair curve particles with the surface.

This option can also be found in the tool settings in the upper right corner as a button only.

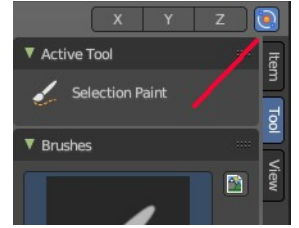

Scale Uniform

Grow or shrink curves by changing their size uniformly instead of using trimming or extrapolation. This is useful for preserving control point count.

Minimum Length

Avoids shrinking curves shorter than this length.

Pinch

Radius

The radius of the brush.

Strength

The strength of the brush.

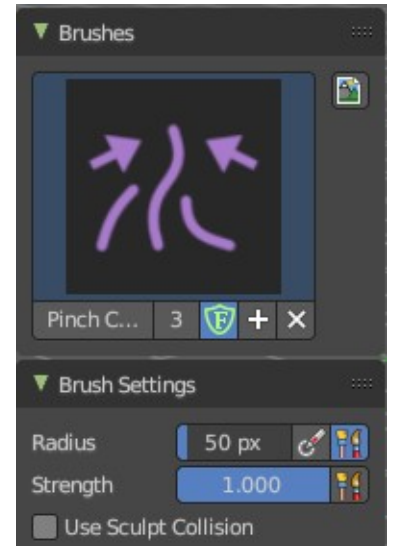

Use Sculpt Collision

Enable the collision of the hair curve particles with the surface.

This option can also be found in the tool settings in the upper right corner as a button only.

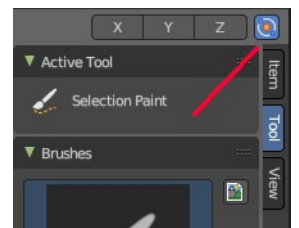

Puff

Radius

The radius of the brush.

Strength

The strength of the brush.

Use Sculpt Collision

Enable the collision of the hair curve particles with the surface.

This option can also be found in the tool settings in the upper right corner as a button only.

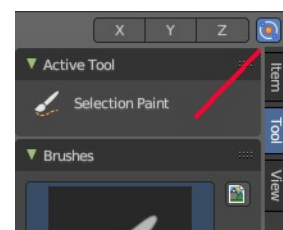
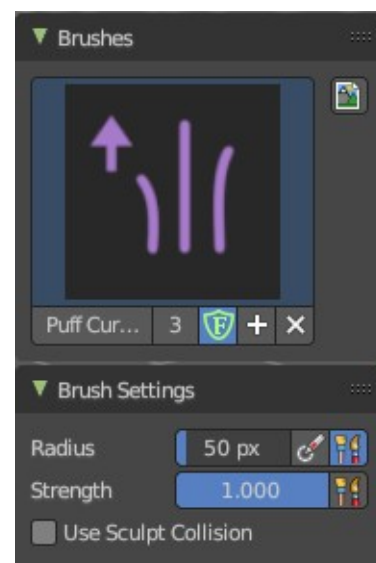

Smooth

Radius

The radius of the brush.

Strength

The strength of the brush.

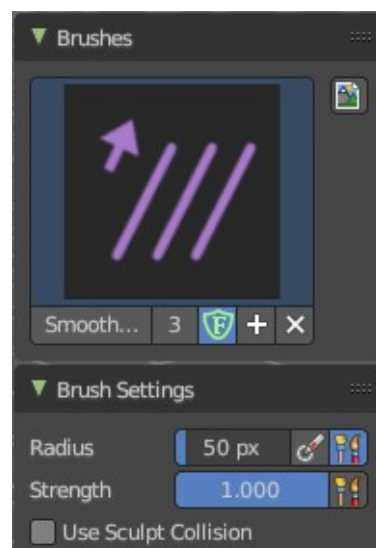

Use Sculpt Collision

Enable the collision of the hair curve particles with the surface.

This option can also be found in the tool settings in the upper right corner as a button only.

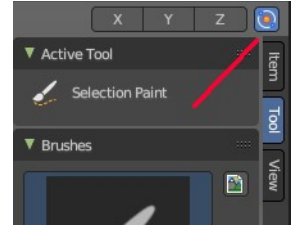

Slide

Radius

The radius of the brush.

Strength

The strength of the brush.

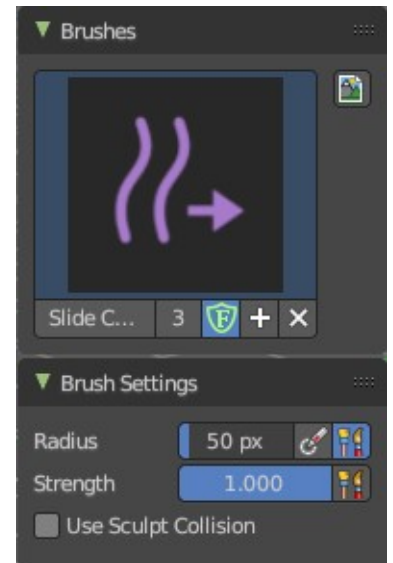

Use Sculpt Collision

Enable the collision of the hair curve particles with the surface.

This option can also be found in the tool settings in the upper right corner as a button only.

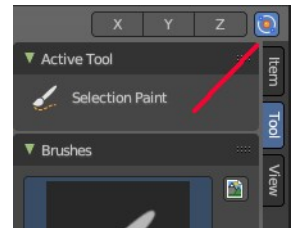

Stroke Sub panel

This subpanel shows with all brushes in the Brush settings panel.

Stroke Method

Show the brush icon when painting.

Dots

Apply paint on each mouse move step.

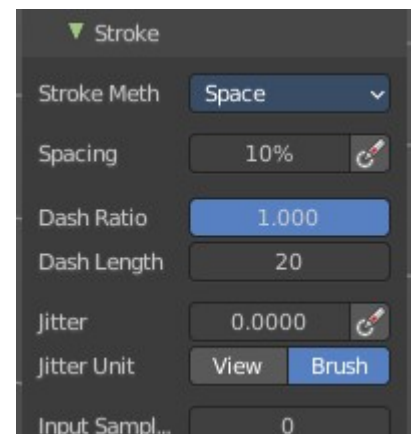
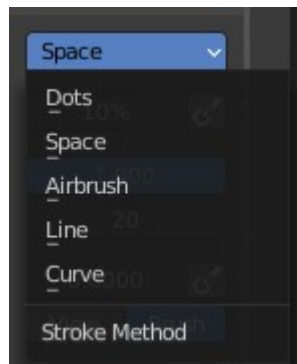

Jitter

The position of the brush while painting. Pressure sensitivity can be activated here.

Jitter Unit

Jitter in view in screen space or relative to brush size. Buttons are View and Brush Relatively..

Input Samples

Average multiple input samples together to smooth the brush stroke.

Stabilize Stroke

Brush lags behind the mouse and follows a smoother path when activated.

Radius

Smooth stroke radius: minimum distance from the last point before stroke continues.

Factor

Smooth stroke factor: higher values give a smoother stroke.

Space

Limit brush applications to the distance specified by spacing.

Spacing

Spacing between brush daubs as a percentage of a brush diameter. Pressure sensitivity activated here.

Dash Ratio

Ratio of samples in a cycle that the brush is enabled.

Dash Length

Length of a dash cycle measured in stroke samples.

Jitter

The position of the brush while painting. Pressure sensitivity can be activated here.

Jitter Unit

Jitter in view in screen space or relative to brush size. Buttons are View and Brush respectively.

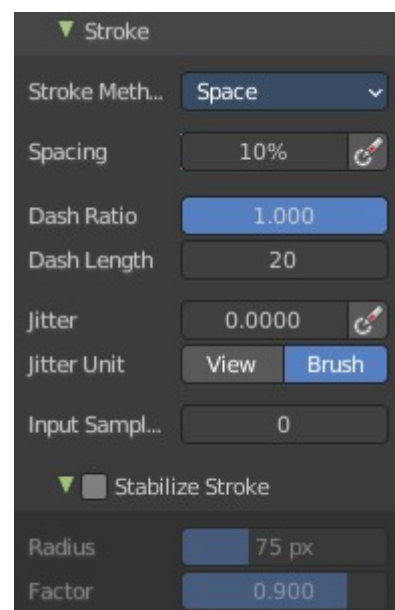
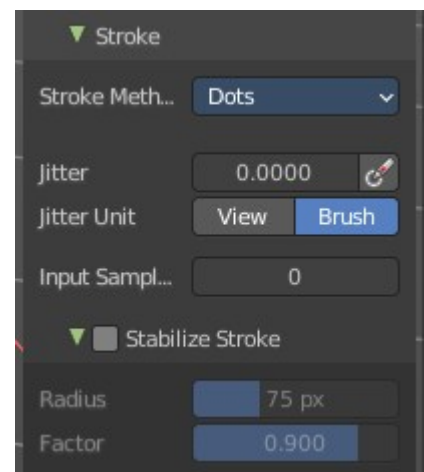

Input Samples

Average multiple input samples together to smooth the brush stroke.

Stabilize Stroke

Brush lags behind the mouse and follows a smoother path when activated.

Radius

Smooth stroke radius: minimum distance from the last point before stroke continues.

Factor

Smooth stroke factor: higher values give a smoother stroke.

Airbrush

Keep applying paint effect while hiding mouse (spray).

Rate

Intervals between paints for airbrush.

Jitter

The position of the brush while painting. Pressure sensitivity can be activated here.

Jitter Unit

Jitter in view in screen space or relative to brush size. Buttons are View and Brush respectively.

Input Samples

Average multiple input samples together to smooth the brush stroke.

Stabilize Stroke

Brush lags behind the mouse and follows a smoother path when activated.

Radius

Smooth stroke radius: minimum distance from the last point before stroke continues.

Factor

Smooth stroke factor: higher values give a smoother stroke.

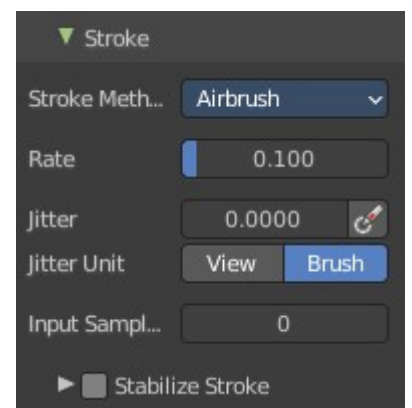

Line

Drag a line with dabs separated according to spacing.

Spacing

Spacing between brush daubs as a percentage of a brush diameter.

Dash Ratio

Ratio of samples in a cycle that the brush is enabled.

Dash Length

Length of a dash cycle measured in stroke samples.

Jitter

The position of the brush while painting. Pressure sensitivity can be activated here.

Jitter Unit

Jitter in view in screen space or relative to brush size. Buttons are View and Brush respectively.

Input Samples

Average multiple input samples together to smooth the brush stroke.

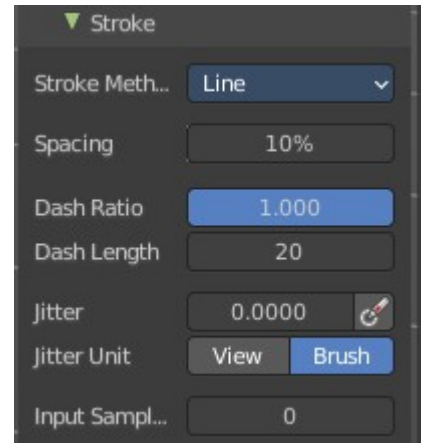

Curve

Define the stroke curve with a bezier curve. Dabs are separated according to spacing.

Spacing

Spacing between brush daubs as a percentage of a brush diameter.

Paint Curve Data

Make new or select existing paint curve data profiles.

Dash Ratio

Ratio of samples in a cycle that the brush is enabled.

Dash Length

Length of a dash cycle measured in stroke samples.

Jitter

The position of the brush while painting. Pressure sensitivity can be activated here.

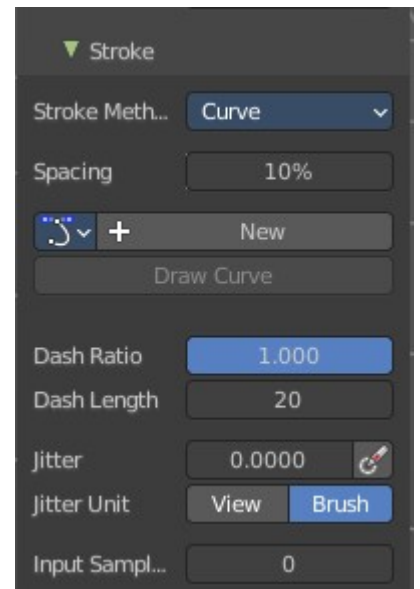

Jitter Unit

Jitter in view in screen space or relative to brush size. Buttons are View and Brush respectively.

Input Samples

Average multiple input samples together to smooth the brush stroke.

Falloff Sub panel

This subpanel shows with all brushes in the Brush settings panel. This customizes the fall off of the brush, where the left is the center and right is the outer circle of the brush. Higher values is stronger falloff.

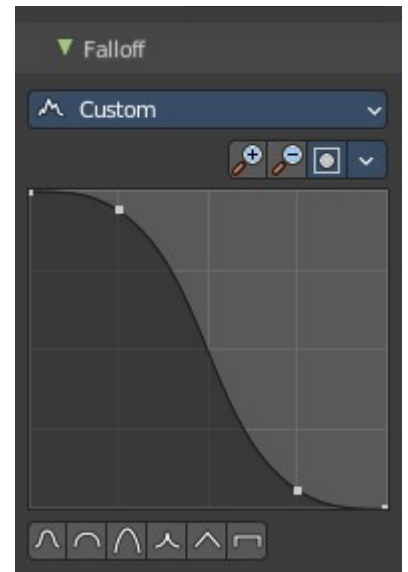
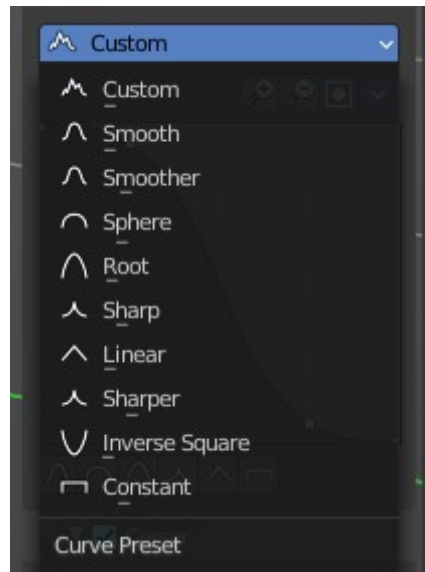

Curve Preset

Select a falloff curve preset.

Zoom In

Zoom the graph in.

Zoom Out

Zoom the graph out.

Clipping Options

Control the minimum X and Y values and maximum X and Y values.

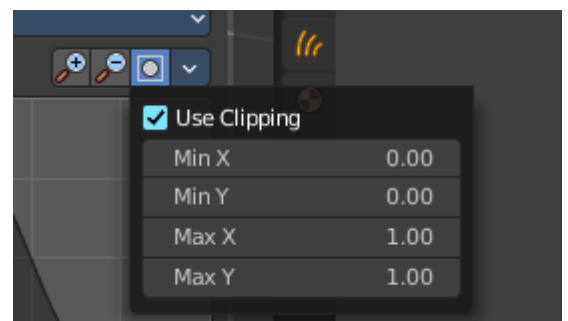

Reset View

Restore the default zoom value and center view.

Reset Curve

Reset to preset curve values.

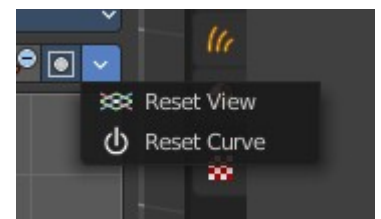

Presets

Quickly draw some default curve profiles.



Cursor Sub panel

This subpanel shows with all brushes in the Brush settings panel.

Show Brush

Show the brush icon when painting.

Cursor Color

The brush icon color with adding.

Falloff Opacity

The brush icon falloff opacity. This is an overlay drawn by a percentage.

Override Overlay

When activated it won't show the overlay when drawing.

Use Cursor Overlay

When activated, this will hide the overlay in the viewport completely.

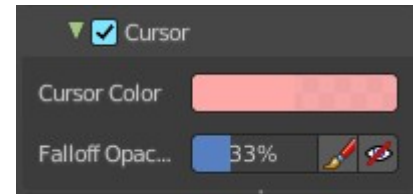



7.3.18 Editors - 3D Viewport - Sidebar - View Tab

Table of content

View tab.....	3
View tab - View Panel.....	3
Focal Length.....	3
Clip Near / Clip Far.....	3
Use Local Camera.....	3
Use Render Region.....	3
Camera Lock.....	3
Lock to Object.....	4
Lock to 3D Cursor.....	4
Lock Camera to view.....	4
Lock View Rotation.....	4
View tab - Edit Panel.....	4
Lock Object Modes.....	4
View Tab - 3D Cursor Panel.....	4
Location.....	5
Rotation.....	5
Right Click menu.....	5
Reset All to Default Value.....	5
Reset Single to Default Value.....	5
Unset.....	5
Copy All to Selected.....	5
Copy Single to Selected.....	5
Copy Data Path.....	5
Copy as new Driver.....	5
Online Python Reference.....	5
Edit Source.....	5
View tab - Collections Panel.....	6
Local Collections.....	6
List of Collections.....	6
View tab - Annotations Panel.....	6
Annotations prop.....	6
Drop down box.....	6
Edit Box.....	6
Fake User.....	6
List of Annotation Strokes.....	7
In Front.....	7
Eye icon.....	7
Add Annotation.....	7
Delete Annotation.....	7
Move up / Down.....	7
Opacity.....	7
Thickness.....	7
Frame Locked/Unlocked.....	7
Onion Skin.....	7
View tab - Stereoscopy Panel.....	8
Left / Right / 3D.....	8
Views / 3D.....	8

Cameras.....	8
Plane.....	8
Alpha.....	8
Volume.....	8
Alpha.....	8
Set Stere 3D.....	9
Display Mode.....	9
Display Mode Type Anaglyph.....	9
Anaglyph Type.....	9
Display Mode Type Interlace.....	9
Interlace Type.....	9
Swap Left/Right.....	10
Display Mode Type Time Sequential.....	10
Display Mode Type Side by Side.....	10
Cross Eyed.....	10
Display Mode Type Top Bottom.....	10
View tab - Quad View panel.....	11
Lock rotation.....	11
Sync Zoom Pan.....	11
Clip Contents.....	11
View tab - Important Hotkeys.....	11
Show Text.....	11
Color.....	11
Font Size.....	12

View tab

The View tab contains viewport related settings.

The content is in all modes and for all object types the same.

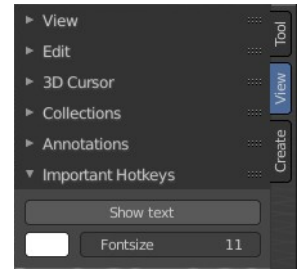

View tab - View Panel

The View panel contains some camera settings for the world camera and the render camera.

Focal Length

Set up the focal length for the world camera. You need to be in perspective view. In Orthographic view the lens values doesn't have an effect.

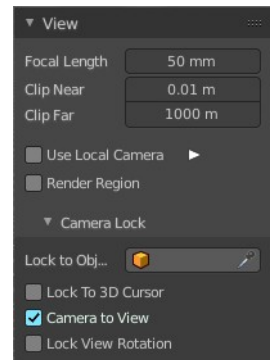

Clip Near / Clip Far

Set up the clipping values for the world camera. Geometry behind the end value and before the start value will not be drawn.

Use Local Camera

Normally when you render an image it gets rendered from the currently active camera.

Define a custom camera that is always used for rendering. Regardless which camera is the active one.

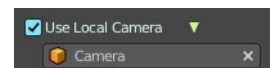

Use Render Region

When you have defined a render region rectangle, then you can toggle it on and off with this switch. See View menu in the 3d view header, the render region menu item.



Camera Lock

Camera Lock is a sub tab with camera related settings.

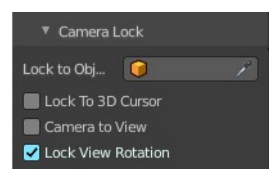

Lock to Object

Locks the view of the world camera to an object. Choose an object for it.

Lock to 3D Cursor

Locks the view of the world camera to the 3D cursor. You can either lock to an object or to the 3d cursor. When you choose an object then the checkbox for the 3d cursor vanishes.

Lock Camera to view

This menu item allows you to navigate in camera view like you would be in world view. When it is unticked then you can navigate the passepourtout, you can zoom and move it. And when you rotate the view, then you will leave the camera mode.

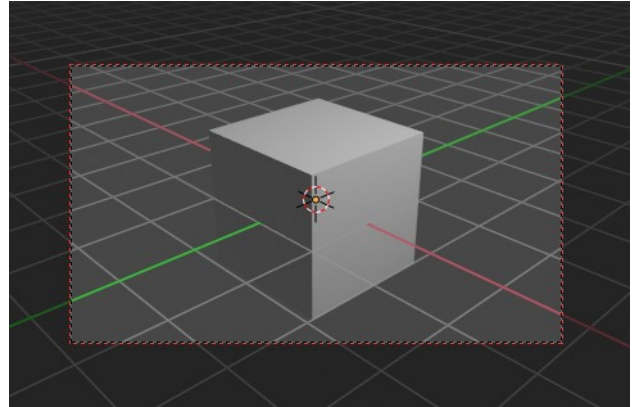

Note that this functionality also exists in the header when you are in camera view. This double menu entry exists by design.

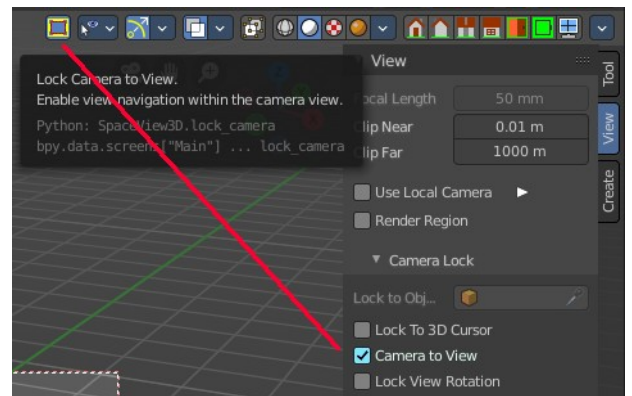

Lock View Rotation

Locks the camera rotation, you cannot rotate the camera anymore. A use case is the 2D Animation workspace, where you can easily accidentally rotate the orthographic view out of position.

View tab - Edit Panel

Lock Object Modes

Restrict selection to content that is in the same mode than the current element.

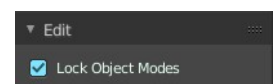

View Tab - 3D Cursor Panel

Location

The position of the 3D cursor in world coordinates.

Rotation

The rotation of the 3D cursor in world coordinates.

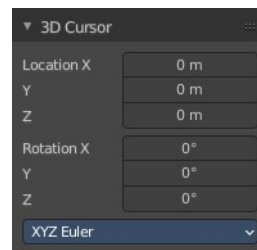

Right Click menu

When you right click at the edit boxes then a menu with further functionality appears.

Reset All to Default Value

Resets the X Y and Z values to the default value.

Reset Single to Default Value

Resets the value for the single edit box under the mouse to the default value.

Unset

Unset is usually a RMB menu entry when you right click at an edit box. It is somehow similar to Reset to Default Value. But it clears the property instead of resetting it to the default value. Which can end in another value.

Copy All to Selected

Allows to copy the current rotation of all axis to another object.

Workflow. Select target object, hold down shift, select source object, and use Copy All to Selected.

Copy Single to Selected

Allows to copy the current rotation of the single selected axis to another object.

Workflow. Select target object, hold down shift, select source object, and use Copy All to Selected.

Copy Data Path

Copy Data Path copies the RNA data path for this property.

Copy as new Driver

Copies the current value as a new driver.

Online Python Reference

Developer feature. Open the Blender Python Reference.

Edit Source

Developer feature. When you have a text editor open in the current layout then you can call the UI script that contains this menu item.

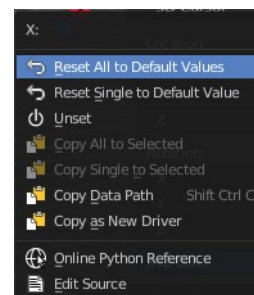

View tab - Collections Panel

Local Collections

Allows the list of visible collections to be controlled per viewport rather than globally.

List of Collections

The Collections panel shows a list of collections.

They can be hidden in the viewport by clicking on the eye icon.

If a collection contains objects, there is a circle to the left of the collection name. If a collection is empty, there is no circle to the left of the collection name.

By clicking directly on the collection names, it “isolates” the collection by hiding all other collections, and showing the direct parents and all the children of the selected collection.

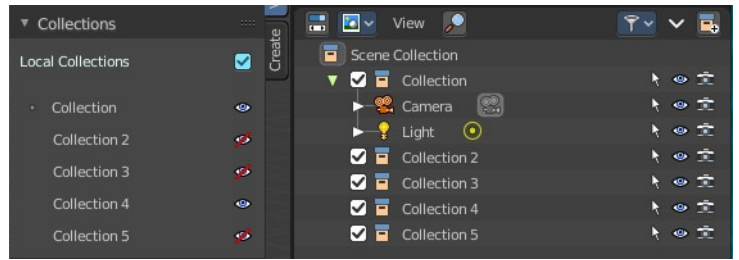

View tab - Annotations Panel

Manage the Annotation layers and materials.

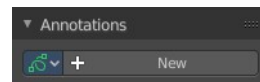

When you don't have drawn an annotation yet then the panel just contains a New button.

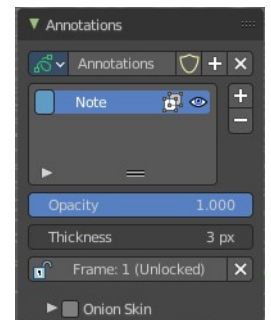

Annotations prop

Add, remove and rename new annotations.

Drop down box

A list of the available annotation layers.

Edit Box

The name of the current annotation. You can rename the annotation to your needs here.

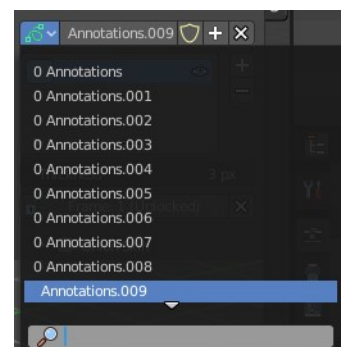

Fake User

Assign a fake user to this annotation. Fake users is an odd concept to keep data in the scene even if it has no user somewhere. The fake user is then a dummy user so that the object is not deleted when saving the scene.

List of Annotation Strokes

Here you see your Annotation layers for the current Annotation. Every layer can have an own color.

At the right side you find buttons to sort them and to add and remove new Annotation layers.

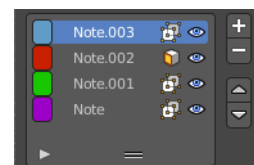

You can change the color by clicking at the color field. A color dialog will pop up. You can rename annotation layers by double clicking at it.

In Front

Toggle if the stroke is displayed in front of geometry or behind.

Eye icon

The eye icon allows you to make it invisible And it has a search field.

Add Annotation

Add a new annotation.

Delete Annotation

Delete the annotation.

Move up / Down

Move the selected annotation up or down in the list

Opacity

The opacity of the stroke.

Thickness

The thickness of the annotation stroke.

Frame Locked/Unlocked

Lock frame displayed by current layer. This toggles whether the active layer is the only one that can be edited.

Onion Skin

Enable Onion Skinning.

Onion Skinning allows to show ghosts of the keyframes before and after the current



frame. In this sub panel you can adjust the color of the onion skin frames.

With the numbers below the colors you can define how many frames before or after are displayed that way.

View tab - Stereoscopy Panel

This panel shows when you have Stereoscopy enabled in the Output Properties of the Properties editor. Some content depends of the Stereoscopy settings.

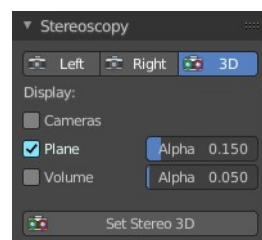
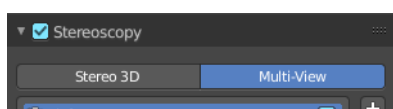

Left / Right / 3D

With Stereoscopy setting Stereo 3D.

Show the image in the 3d view from the left or right camera, or from both.



Views / 3D

With Stereoscopy setting Multi-View.

Show the image in the 3d view from the single cameras, or from both.



Cameras

With Stereoscopy setting Stereo 3D. Show the left and right cameras.

Plane

Show the convergence plane.

Alpha

The transparency of the convergence plane.

Volume

Show the stereoscopy volume.

Alpha

The transparency of the stereoscopy volume.

Set Stereo 3D

Calls a panel where you can adjust the stereoscopy display in the 3D view to preview the result.

This settings does not affect the output, just how the result gets displayed in the viewport!

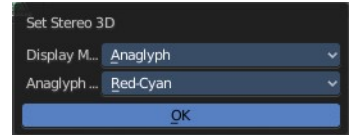

Display Mode

How to display the stereoscopic image when viewing through the camera. This is the preview mode. You need a special monitor for some of the methods. There are five methods available.

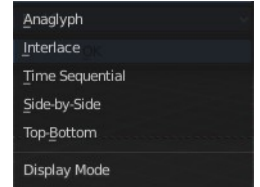

Display Mode Type Anaglyph

Render Views for left and right eyes as two differently filtered colors in a single image. You need anaglyph glasses to see the 3d effect.

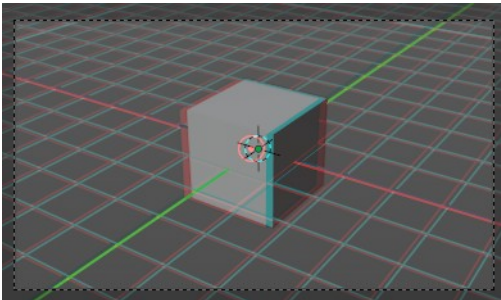
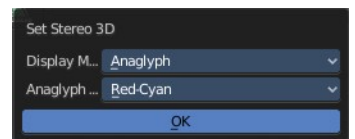

Anaglyph Type

The color model to display the graphics.

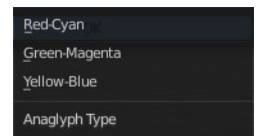

Display Mode Type Interlace

Render Views from left and right eyes interlaced into a single image. You need a 3D Ready monitor to see the stereo effect.

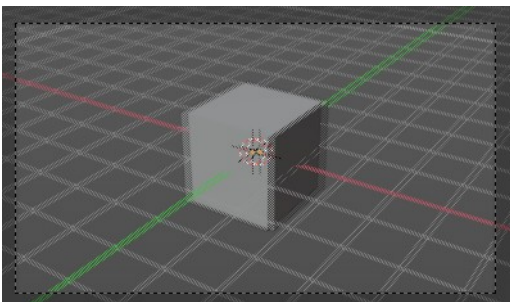
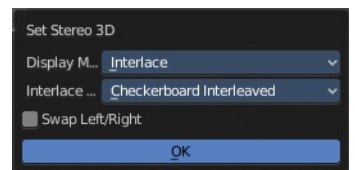

Interlace Type

The interlace type that you can choose.

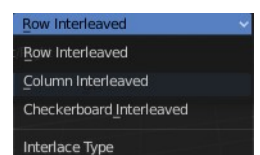

Swap Left/Right

Swaps left and right camera view.

Display Mode Type Time Sequential

Render alternate eyes. Also known as page flip. Needs a graphics card that supports quad buffer.

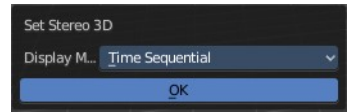

Display Mode Type Side by Side

Displays images of the two cameras side by side. You need to go into Window Full screen to see the effect.

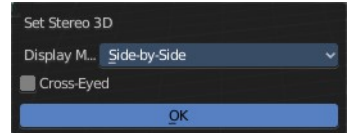

Don't use the full screen. feature in the View menu of the 3D view, but the Window toggle full screen. in the Window menu!

Attention! the menus becomes nearly unreadable then. The whole UI gets distorted by splitting the main window of Bforartists into two views. You might want to assign a shortcut here before trying.

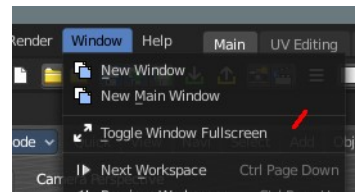

Cross Eyed

Swaps left and right camera view.

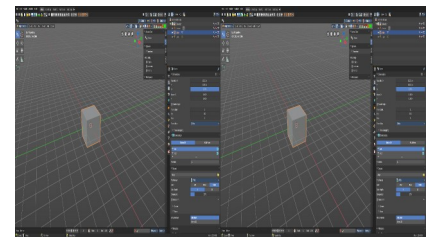

Display Mode Type Top Bottom

Displays images of the two cameras top and bottom. You need to go into Window Full screen to see the effect.

Don't use the full screen. feature in the View menu of the 3D view, but the Window toggle full screen. in the Window menu!

Attention! the menus becomes nearly unreadable then. The whole UI gets distorted by splitting the main window of Bforartists into two views. You might want to assign a shortcut here before trying.

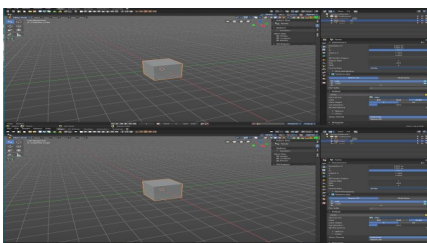
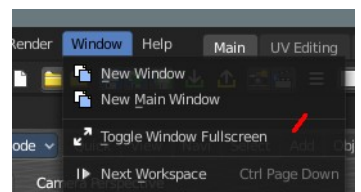
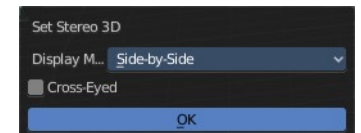

View tab - Quad View panel

This panel just shows when you are in quad view. Toggle Quad View can be found in the View menu.

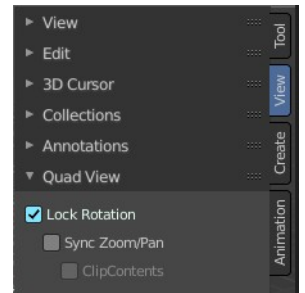

Lock rotation

Quad view has four windows. Three of them can be locked to the orthographic views.

Turning off Lock Rotation reveals the quick navigation buttons Switch to Camera View and Switch between Perspectivic and Orthographic display.



Sync Zoom Pan

In the three orthographic views you can either zoom and pan individually. Or you zoom and pan them in sync.

Clip Contents

Clip objects based on what is visible in the other orthographic side views. The perspectivic view is not affected.

View tab - Important Hotkeys

This panel is an addon called Important Hotkeys, and can be turned off in the Preferences.

It displays the most important hotkeys in the viewport.

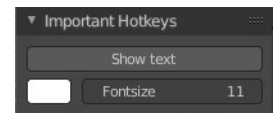

Show Text

Show or hide the text in the viewport.

Color

Define what color the text should have. Default is white.

Font Size

The size of the font.

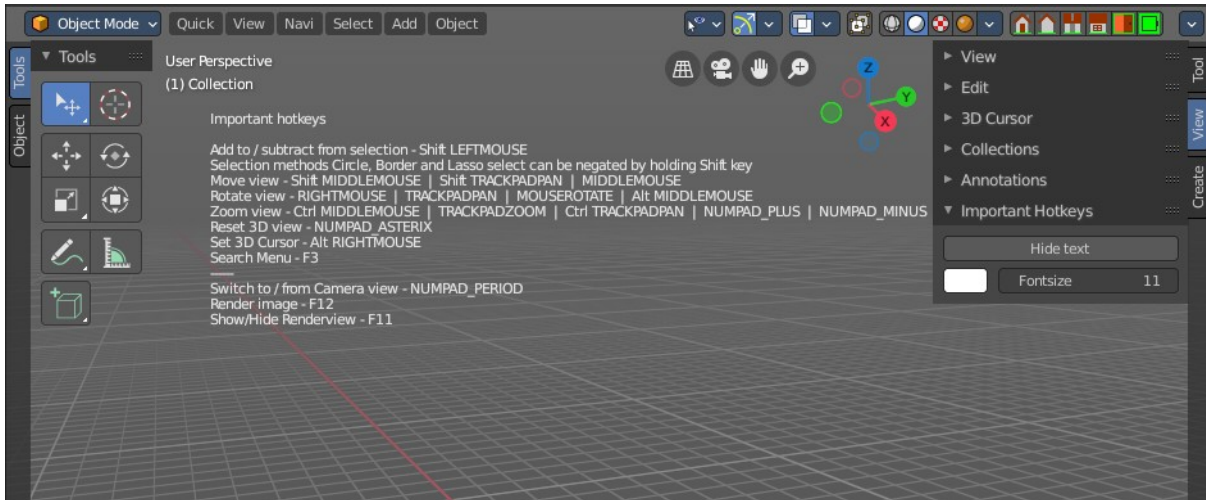



7.3.16 Editors - 3D Viewport - Sidebar - Animation Tab

Table of content

Animation tab - Pose Library Panel.....	2
Create Pose Asset.....	2
Copy Pose as Asset.....	2
Active Asset Library.....	2
List of Asset Poses.....	2
Search Field.....	2
Invert.....	2
Sort by Name.....	2

Animation tab - Pose Library Panel

The Animation tab contains currently the pose library settings.

Create Pose Asset

This button becomes active with a armature in pose mode. It allows you to insert the current pose into the Asset browser, to reuse it at a later point.

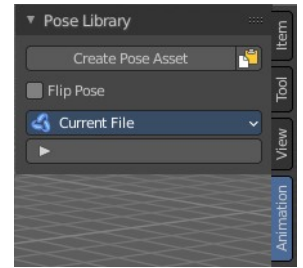

Copy Pose as Asset

Copy the current pose as an asset, which can then be pasted into an asset library.



Active Asset Library

Which asset library to use. A custom one, or the built in asset lib. Default is the built-in called Current File.

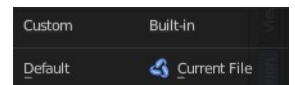

List of Asset Poses

The list of available asset poses.

Search Field

You can expand a search field at the bottom of the list. Type in your term and hit enter to filter for your term.



Invert

Exclude the search term instead of searching for it.

Sort by Name

Sort the List by name.

Pose Assets context menu

When you right click on a pose asset in the Pose Library, you get extra options to help apply the pose. To use them, make sure you have a compatible armature selected, are in Pose Mode and have the bones you'd like to pose selected.

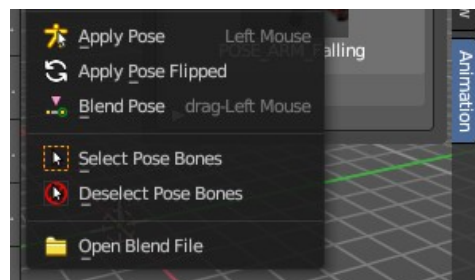

Apply Pose

Apply the given pose action to the active rig. When you select this, this will apply the pose to selected bones.

Apply Pose Flipped

Apply the given pose action to the active rig with a flipped axis. When you select this, this will apply the flipped pose to selected bones. Flipping happens usually from bones labeled .L and .R

Blend Pose

Blend the given pose action to the active rig. This is useful to interpolate from the original pose to the new pose. When using, you will see a slider in the asset browser header giving you a degree of blend.

Select Pose Bones

Select those bones used in this pose action. This will select all the necessary bones you need to apply the pose effectively. If you have no bones selected, the pose will not apply. Poses only apply to bones that are selected.

Deselect Pose Bones

Deselect those bones used in this pose action. This will ultimately clear the selection based on the pose action bones defined in the marked action clip.

Open Blend File

Opens the path for the blend file that contains the active asset. Useful to help edit poses.



7.3.2 Editors - 3D Viewport - Sidebar - Tool Tab

Table of content

Tool Tab.....	1
Tool Tab and Top Bar.....	1
Workspace Panel.....	1
Pin Scene.....	2
Mode.....	2
Filter Addons.....	2
Custom Properties.....	2
Top bar tools arrangement.....	2

Tool Tab

In the tool tab you will find the tool related settings for the tools in the tool shelf. In Weightpaint mode you have for example all brush related panels.

The tool specific entries are explained in the tool shelf chapter. The brushes panels are explained in the tool tab chapters.



Tool Tab and Top Bar

The content in the Tool Tab is besides one panel the same than in the Topbar. The panel called Workspace just exists in the sidebar.

The content of the Options panel changes, dependent of the object type and the mode. And will be described in other tool tab chapters.

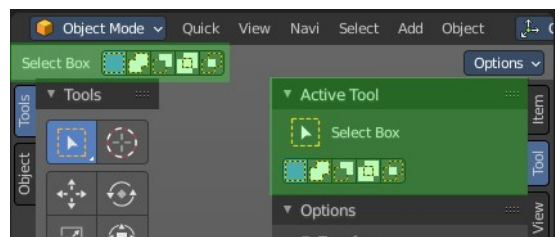

Workspace Panel

Workspaces can be configured to start in specific modes, and with a specific sets of active addons. This is the place where you configure this settings.

You have to save the startup file to make these changes permanent.

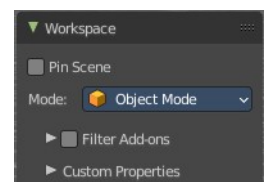

Pin Scene

Remember the last used scene for the workspace. And switch to it whenever the workspace is activated again.

Mode

The mode in which the 3D view should start when you switch to this workspace layout.

Filter Addons

Filter, means activate or deactivate specific addons. Here you can turn on or off specific addons.

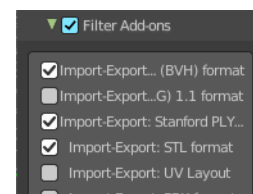

Custom Properties

Custom properties allows you to store your own metadata. This metadata can then be used for rigging and Python scripts.

The following data supports custom properties:

- All data-blocks types.
- Bones and Pose-Bones.
- Sequence strips.

Top bar tools arrangement

The tools in the top bar are arranged in a special way. Left you have the tools area. At the right you will find further options in case there are any. This is a general UI design paradigm. Left tools and menus, right settings.

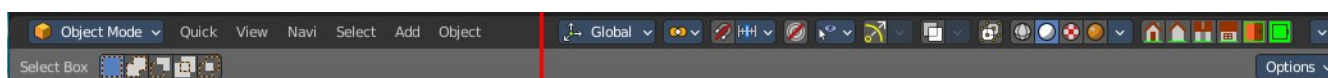



7.3.3 Editors - 3D View - Sidebar - Tool Tab - Object Mode

Table of content

Object Mode - Options Panel.....	1
Transform.....	1
Affect Only.....	1
Origins.....	1
Location.....	1
Parents.....	1

Object Mode - Options Panel

Transform

Affect Only

Restrict the elements that moves when you move rotate or scale the object.

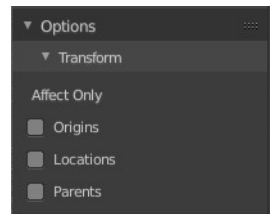

Origins

Move or rotate the origin instead of the object geometry. Scale has no effect. And it will not work on geometry like lamps.

Location

This is for having more than one object selected. Scales or rotates the selection instead of scaling or rotating the single objects. The single objects keeps their scale and their rotation.

Parents

Don't transform the child objects. Just the parent objects.



7.3.4 Editors - 3D Viewport - Sidebar - Tool Tab - Edit Mode

Table of content

- Tools Tab in Edit Mode.....1
- Mesh Object - Options Panel.....1
 - Transform sub panel.....1
 - Correct Face Attributes.....1
 - Keep Connected.....1
 - Mirror.....1
 - Topology Mirror.....2
 - Auto Merge.....2
 - Split Edges and Faces.....2
 - Threshold.....2
- UV subpanel.....2
 - Live Unwrap Edge Path.....2
- Armature - Armature Options panel.....2
 - X Axis Mirror.....2
 - Workflow.....2

Tools Tab in Edit Mode

Many object types can be edited in edit mode. Mesh objects, armature, text object and so on. In this chapter we will go through all the object types in edit mode. But just a few object types have really relevant settings in the tools tab in edit mode. Mesh Objects. All kind of curve objects. And the Armature.

For the rest of the editable object types the tools tab stays blank.

Mesh Object - Options Panel

This panel contains some mesh specific settings. It can also be found in the header.

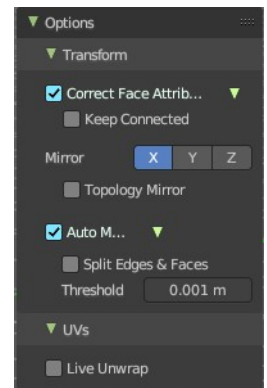

Transform sub panel

Correct Face Attributes

Correct data such as UV's and vertex colors when transforming.

Keep Connected

During the face attributes correction merge attributes connected to the same vertex.

Mirror

Mirror Editing.

The same mirror buttons can also be found in the tool settings bar as icon buttons. This allows quicker access and better visual control which mirror axis is currently active.



Topology Mirror

Use Topology based mirroring. This checkbox shows when you have selected a mirror axis.

Auto Merge

Automatically merge vertices that are close to each other.

The same checkbox can also be found in the tool settings bar as an icon button. This allows quicker access and better visual control which mirror axis is currently active.



Split Edges and Faces

When mirror editing then split edges and faces automatically.

Threshold

Limit for removing duplicates and 'Auto Merge'.

UV subpanel

Live Unwrap Edge Path

Changing an edges seam in the 3d view recalculates the UV unwrap.

Armature - Armature Options panel

X Axis Mirror

X Axis Mirror is made to sync the right side of a symmetrical armature with the left side of a symmetrical armature. Means you can create just one half of a skeleton. And then simply mirror it over to the other half. And any further changes that you do at the one side will also apply to the other side of the armature. This includes the whole FK IK setup. And can save you lots of work therefore.

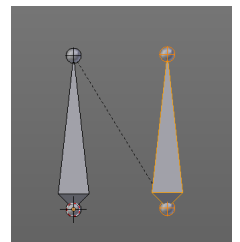

The same checkbox can also be found in the tool settings bar as an icon button. This allows quicker access and better visual control which mirror axis is currently active.



Workflow

To get X Axis mirror to work requires a bit preparation work.

Create an armature, with some bones at the one side. Like this. The 3D cursor needs to be

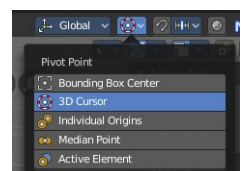

at 0/0/0. The left bone is in the middle. Think of it as the backbone. The right bone has an offset, and shall represent our right side of the armature.

Change the Pivot Point in the Header to 3D Cursor. Important step. We want to mirror around the 3D Cursor.

Now select the right side of the armature. Border select is one fast way. But NOT the bone in the middle, which is our backbone. We don't want to mirror this one too.

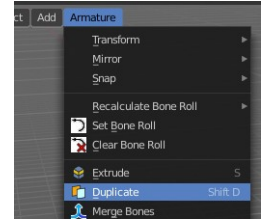

Duplicate what we have selected. And click immediately to leave the duplicate mode. Or you will pull the duplicated part around. Which is not what we want.

Next we will scale our new created armature part by -1 to mirror it over to the other side. Activate Scale, don't move the mouse, but type immediately in X for the axis and -1 for the scale factor.

This will create our mirrored armature part.

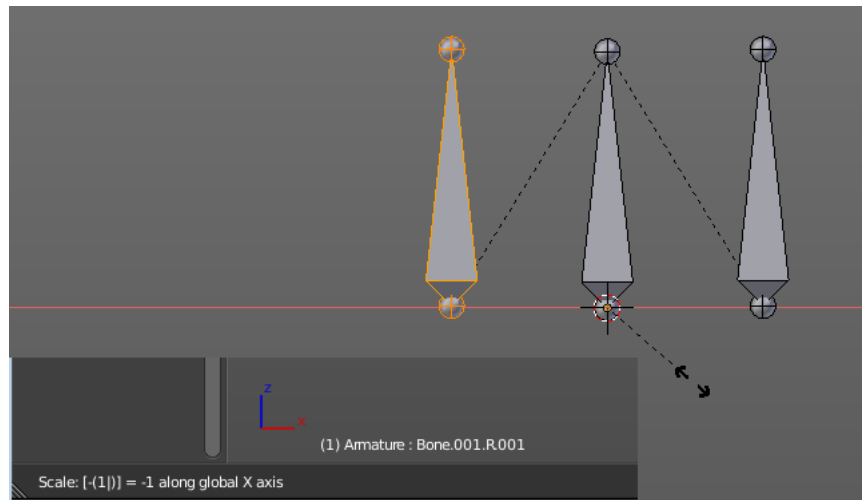

Next important step is to Flip Names. This renames the mirrored bones. Bone.001.R becomes without this step Bone.001.R.001. With rename we get Bone.001.L

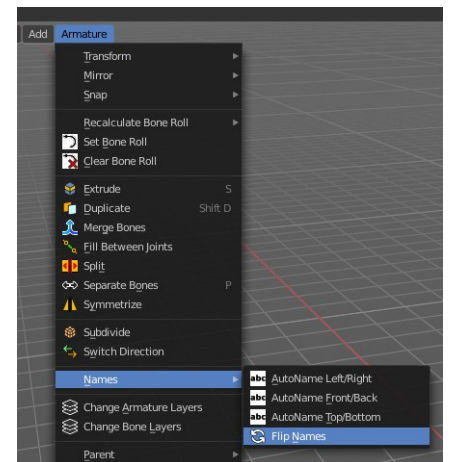

And now we are finally arrived at X Axis Mirror. Tick it.

Now you should be able to modify the one side of the armature, and the other side will be modified too. This includes as told above also FK IK set-ups that you do in Pose mode.



7.3.5 Editors - 3D Viewport - Sidebar - Tool Tab - Pose Mode

Table of content

Tools Tab in Pose Mode.....	1
Pose Mode - Armature.....	1
Pose Options Panel.....	1
Auto IK.....	1
X Axis Mirror.....	1
Relative Mirror.....	1
Affect Only Locations.....	1

Tools Tab in Pose Mode

There are two object types that has a pose mode. The armature, and the grease pencil object. We will cover the armature here. The grease pencil object has its own chapter as a whole.

The number of available tools in the tools panel is rather small. There is just one panel.

Pose Mode - Armature

Pose Options Panel

Auto IK

Add temporary IK constraints while grabbing bones in Pose mode.

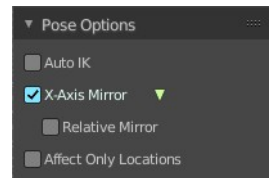

X Axis Mirror

X Axis Mirror in pose mode synchronizes the right side of a symmetrical armature with the left side of a symmetrical armature.

The same checkbox can also be found in the tool settings bar as an icon button. This allows quicker access and better visual control which mirror axis is currently active.



Relative Mirror

This is a setting for X Axis Mirror, and just shows when X Axis Mirror is ticked. Here you can define if the mirroring happens relative to the armature or to the world.

Affect Only Locations

This is for having more than one armature part selected. Scales or rotates the selection instead of scaling or rotating the single armature parts. The single bones keeps their scale and their rotation.

7.3.6 Editors - 3D Viewport - Sidebar - Tool Tab - Mesh - Sculpt Mode

Table of content

Detailed table of content.....	4
Tools Tab in Sculpt Mode.....	13
Brushes Panel.....	13
Custom Icon.....	13
Brush Settings Panel.....	14
Brush Settings Panel - Common Settings.....	14
Radius.....	14
Radius Unit.....	15
Strength.....	15
Front Faces Only.....	15
Normal Radius.....	15
Hardness.....	15
Autosmooth.....	15
Brush Settings Panel - Draw brush.....	16
Direction Add / Subtract.....	16
Brush Settings Panel - Draw Sharp brush.....	16
Direction Add / Subtract.....	16
Brush Settings Panel - Clay brush.....	16
Direction Add / Subtract.....	17
Plane Offset.....	17
Plane Trim.....	17
Brush Settings Panel - Clay Strip brush.....	17
Direction Add / Subtract.....	17
Plane Offset.....	17
Plane Trim.....	17
Tip roundness.....	18
Brush Settings Panel - Clay Thumb brush.....	18
Plane Offset.....	18
Plane Trim.....	18
Brush Settings Panel - Layer brush.....	19
Direction Add / Subtract.....	19
Height.....	19
Persistent.....	19
Brush Settings Panel - Inflate brush.....	19
Direction Inflate / Deflate.....	19
Brush Settings Panel - Blob brush.....	20
Direction Add / Subtract.....	20
Magnify.....	20
Brush Settings Panel - Crease brush.....	20
Direction Add / Subtract.....	20
Pinch.....	20
Brush Settings Panel - Smooth brush.....	21
Direction Smooth / Enhance.....	21
Brush Settings Panel - Flatten brush.....	21
Direction Contrast / Flatten.....	21

Plane Offset.....	21
Plane Trim.....	21
Brush Settings Panel - Fill brush.....	22
Direction Fill / Deepen.....	22
Plane Offset.....	22
Plane Trim.....	22
Area Radius.....	22
Invert to Scrape.....	22
Brush Settings Panel - Scrape brush.....	23
Direction Fill / Deepen.....	23
Plane Offset.....	23
Plane Trim.....	23
Area Radius.....	23
Invert to Fill.....	23
Brush Settings Panel - Multi-plane Scrape brush.....	24
Plane Angle.....	24
Dynamic Mode.....	24
Show Cursor Preview.....	24
Brush Settings Panel - Pinch brush.....	24
Direction Magnify / Pinch.....	24
Autosmooth.....	24
Brush Settings Panel - Grab brush.....	25
Normal Weight.....	25
Grab active Vertex.....	25
Grab Silhouette.....	25
Brush Settings Panel - Elastic Deform brush.....	25
Normal Weight.....	25
Deformation.....	25
Volume Preservation.....	26
Brush Settings Panel - Snake Hook brush.....	26
Normal Weight.....	26
Magnify.....	26
Rake.....	26
Deformation.....	26
Brush Settings Panel - Thumb brush.....	26
Brush Settings Panel - Pose brush.....	27
Deformation Target.....	27
Deformation.....	27
Rotation Origins.....	27
Pose Origin Offset.....	27
Smooth Iterations.....	27
Pose IK Segments.....	27
Keep Anchor Point.....	28
Connected only.....	28
Max Element Distance.....	28
Brush Settings Panel - Nudge brush.....	28
Brush Settings Panel - Rotate brush.....	28
Brush Settings Panel - Slide Relax brush.....	28
Deformation.....	28
Brush Settings Panel - Boundary brush.....	29
Deformation Target.....	29
Deformation.....	29
Boundary Falloff.....	29

Boundary Origin Offset.....	29
Brush Settings Panel - Cloth brush.....	30
Persistent.....	30
Simulation Area.....	30
Deformation.....	30
Force Falloff.....	31
Cloth Mass.....	31
Cloth Damping.....	31
Soft Body Influence.....	31
Enable Collision.....	31
Brush Settings Panel - Simplify brush.....	31
Brush Settings Panel - Mask brush.....	31
Direction Add / Subtract.....	32
Mask Tool.....	32
Brush Settings Panel - Draw Face Sets brush.....	32
Brush Settings Panel - Multires Displacement Eraser brush.....	32
Brush Settings Panel - Multires Displacement Smear brush.....	32
Deformation.....	32
Brush Settings Panel - Paint.....	33
Primary / Secondary color.....	33
Blend Mode.....	33
Flow.....	33
Wet Mix.....	33
Wet Persistence.....	34
Wet Paint Radius.....	34
Density.....	34
Tip Roundness.....	34
Tip Scale X.....	34
Brush Settings Panel - Smear.....	34
Deformation.....	35
Brush Settings Panel - Color Picker Sub panel.....	35
Mode.....	35
Brush Settings Panel - Color Palette Sub panel.....	38
Palette browser.....	38
Edit Box.....	38
Number of users.....	38
Fake User.....	38
Add palette.....	38
Remove Palette.....	38
Add color.....	38
Remove color.....	39
Sort By.....	39
Brush Settings Panel - Advanced Sub panel.....	39
Topology.....	39
Face Sets.....	39
Mesh Boundary.....	39
Face Sets Boundary.....	39
Cavity.....	40
Cavity (Inverted).....	40
View Normal.....	42
Area Normal.....	42
Sculpt Plane.....	42
Use Original.....	42

Accumulate.....	43
Brush Settings Panel - Texture Subpanel.....	43
Brush Settings Panel - Stroke Sub panel.....	49
Stroke Panel with Stroke method Space.....	49
Stroke Panel with Stroke method Curve.....	51
Stroke Panel with Stroke method Line.....	53
Stroke Panel with Stroke method Airbrush.....	54
Stroke Panel with Stroke method Anchored.....	55
Stroke Panel with Stroke method Drag dot.....	56
Stroke Panel with Stroke method dot.....	57
Brush Settings Panel - Falloff Sub panel.....	58
Presets.....	58
Brush Settings Panel - Cursor Sub panel.....	59
Cursor checkbox in header.....	59
Cursor Color.....	60
Inverse Color.....	60
Falloff Opacity.....	60
Texture Opacity.....	60
Dyntopo Panel.....	60
Dyntopo Panel.....	60
Remesh Panel.....	62
Voxel Size.....	62
Adaptivity.....	62
Fix Poles.....	62
Smooth Normals.....	62
Preserve.....	63
Remesh.....	63
Symmetry Panel.....	63
Mirror.....	63
Lock.....	63
Tiling.....	64
Feather.....	64
Radial.....	64
Tile Offset.....	64
Direction.....	64
Symmetrize.....	64
Merge Distance.....	64
Sculpt Mode - Options Panel.....	65
Display.....	65
Display.....	65
Gravity sub panel.....	66

Detailed table of content

Detailed table of content

Detailed table of content.....	4
Tools Tab in Sculpt Mode.....	13
Brushes Panel.....	13
Browse Brush.....	13
Custom Icon.....	13

Brush Settings Panel.....	14
Brush Settings Panel - Common Settings.....	14
Radius.....	14
Size Pressure.....	14
Use Unified Radius.....	14
Radius Unit.....	15
Strength.....	15
Size Pressure.....	15
Use Unified Radius.....	15
Front Faces Only.....	15
Normal Radius.....	15
Hardness.....	15
Invert Pressure for Hardness.....	15
Use pressure for hardness.....	15
Autosmooth.....	15
Use pressure for hardness.....	15
Brush Settings Panel - Draw brush.....	16
Direction Add / Subtract.....	16
Brush Settings Panel - Draw Sharp brush.....	16
Direction Add / Subtract.....	16
Brush Settings Panel - Clay brush.....	16
Direction Add / Subtract.....	17
Plane Offset.....	17
Plane Trim.....	17
Brush Settings Panel - Clay Strip brush.....	17
Direction Add / Subtract.....	17
Plane Offset.....	17
Plane Trim.....	17
Distance.....	18
Tip roundness.....	18
Brush Settings Panel - Clay Thumb brush.....	18
Plane Offset.....	18
Plane Trim.....	18
Distance.....	18
Brush Settings Panel - Layer brush.....	19
Direction Add / Subtract.....	19
Height.....	19
Persistent.....	19
Set Persistent Base.....	19
Brush Settings Panel - Inflate brush.....	19
Direction Inflate / Deflate.....	19
Brush Settings Panel - Blob brush.....	20
Direction Add / Subtract.....	20
Magnify.....	20
Brush Settings Panel - Crease brush.....	20
Direction Add / Subtract.....	20
Pinch.....	20
Brush Settings Panel - Smooth brush.....	21
Direction Smooth / Enhance.....	21
Brush Settings Panel - Flatten brush.....	21
Direction Contrast / Flatten.....	21
Plane Offset.....	21
Plane Trim.....	21

Brush Settings Panel - Fill brush.....	22
Direction Fill / Deepen.....	22
Plane Offset.....	22
Plane Trim.....	22
Area Radius.....	22
Size Pressure.....	22
Invert to Scrape.....	22
Brush Settings Panel - Scrape brush.....	23
Direction Fill / Deepen.....	23
Plane Offset.....	23
Plane Trim.....	23
Area Radius.....	23
Size Pressure.....	23
Invert to Fill.....	23
Brush Settings Panel - Multi-plane Scrape brush.....	24
Plane Angle.....	24
Dynamic Mode.....	24
Show Cursor Preview.....	24
Brush Settings Panel - Pinch brush.....	24
Direction Magnify / Pinch.....	24
Autosmooth.....	24
Brush Settings Panel - Grab brush.....	25
Normal Weight.....	25
Grab active Vertex.....	25
Grab Silhouette.....	25
Brush Settings Panel - Elastic Deform brush.....	25
Normal Weight.....	25
Deformation.....	25
Volume Preservation.....	26
Brush Settings Panel - Snake Hook brush.....	26
Normal Weight.....	26
Magnify.....	26
Rake.....	26
Deformation.....	26
Brush Settings Panel - Thumb brush.....	26
Brush Settings Panel - Pose brush.....	27
Deformation Target.....	27
Deformation.....	27
Lock Rotation when scaling.....	27
Rotation Origins.....	27
Pose Origin Offset.....	27
Smooth Iterations.....	27
Pose IK Segments.....	27
Keep Anchor Point.....	28
Connected only.....	28
Max Element Distance.....	28
Brush Settings Panel - Nudge brush.....	28
Brush Settings Panel - Rotate brush.....	28
Brush Settings Panel - Slide Relax brush.....	28
Deformation.....	28
Brush Settings Panel - Boundary brush.....	29
Deformation Target.....	29
Deformation.....	29

Boundary Falloff.....	29
Boundary Origin Offset.....	29
Brush Settings Panel - Cloth brush.....	30
Persistent.....	30
Set Persistent Base.....	30
Simulation Area.....	30
Simulation Limit.....	30
Simulation Falloff.....	30
Pin Simulation Boundary.....	30
Deformation.....	30
Force Falloff.....	31
Cloth Mass.....	31
Cloth Damping.....	31
Soft Body Influence.....	31
Enable Collision.....	31
Brush Settings Panel - Simplify brush.....	31
Brush Settings Panel - Mask brush.....	31
Direction Add / Subtract.....	32
Mask Tool.....	32
Brush Settings Panel - Draw Face Sets brush.....	32
Brush Settings Panel - Multires Displacement Eraser brush.....	32
Brush Settings Panel - Multires Displacement Smear brush.....	32
Deformation.....	32
Brush Settings Panel - Paint.....	33
Primary / Secondary color.....	33
Swap colors.....	33
Use Unified Color.....	33
Blend Mode.....	33
Flow.....	33
Invert Pressure.....	33
Use Pressure.....	33
Wet Mix.....	33
Invert Pressure.....	33
Use Pressure.....	34
Wet Persistence.....	34
Invert Pressure.....	34
Use Pressure.....	34
Wet Paint Radius.....	34
Density.....	34
Invert Pressure.....	34
Use Pressure.....	34
Tip Roundness.....	34
Tip Scale X.....	34
Brush Settings Panel - Smear.....	34
Deformation.....	35
Brush Settings Panel - Color Picker Sub panel.....	35
Mode.....	35
Color / Gradient.....	35
Color picker mode.....	35
Colorpicker.....	35
Primary / Secondary color.....	35
Swap colors.....	35
Use Unified Color.....	35

Gradient mode.....	35
Color Ramp.....	35
Controls.....	36
+.....	36
-.....	36
Tools menu.....	36
Flip Color Ramp.....	36
Distribute Stops from Left.....	36
Distribute Stops Evenly.....	36
Eyedropper (pipette icon) E.....	36
Reset Color Ramp.....	36
Color Mode.....	36
RGB.....	36
HSV/HSL.....	36
Interpolation.....	36
Ease.....	36
Cardinal.....	36
Linear.....	36
B-Spline.....	36
Constant.....	36
Color Ramp.....	37
Active Color Stop elements.....	37
Choose active color stop.....	37
Pos.....	37
Color.....	37
Background Color.....	37
Gradient Mapping.....	37
Pressure.....	37
Repeat.....	37
Gradient Spacing.....	37
Clamp.....	37
Gradient Spacing.....	37
Brush Settings Panel - Color Palette Sub panel.....	38
Palette browser.....	38
Edit Box.....	38
Number of users.....	38
Fake User.....	38
Add palette.....	38
Remove Palette.....	38
Add color.....	38
Remove color.....	39
Sort By.....	39
Brush Settings Panel - Advanced Sub panel.....	39
Topology.....	39
Face Sets.....	39
Mesh Boundary.....	39
Face Sets Boundary.....	39
Steps.....	39
Cavity.....	40
Cavity (Inverted).....	40
Create Mask.....	40
Factor.....	40
Blur.....	40

Custom Curve.....	40
Selecting Points.....	40
Adding Points.....	40
Navigation elements.....	40
Zoom in and out.....	41
Clipping Options.....	41
Use Clipping.....	41
Min and Max X Y.....	41
Tools.....	41
Reset View.....	41
Extend horizontal.....	41
Extend extrapolated.....	41
Reset Curve.....	41
Handle Types.....	41
X Y Position.....	41
Delete Points.....	41
View Normal.....	42
Occlusion.....	42
Limit.....	42
Falloff.....	42
Area Normal.....	42
Limit.....	42
Falloff.....	42
Sculpt Plane.....	42
Use Original.....	42
Normal.....	42
Plane.....	42
Accumulate.....	43
Brush Settings Panel - Texture Subpanel.....	43
Browse Texture to be linked.....	43
Adding a texture.....	43
Texture Edit box.....	44
Brush Mapping.....	44
Brush Mapping with mapping method View Plane and Area Plane.....	45
Angle edit box.....	45
Rake.....	45
Random.....	45
Random edit box.....	45
Offset.....	45
Size.....	46
Sample Bias.....	46
Vector Displacement.....	46
Brush Mapping with mapping method Tiled.....	46
Angle edit box.....	46
Offset.....	46
Size.....	46
Sample Bias.....	46
Brush Mapping with mapping method 3D.....	47
Offset.....	47
Size.....	47
Sample Bias.....	47
Brush Mapping with mapping method Random.....	47
Angle edit box.....	48

Rake.....	48
Random.....	48
Random edit box.....	48
Offset.....	48
Size.....	48
Sample Bias.....	48
Brush Mapping with mapping method Stencil.....	48
Image Aspect.....	49
Angle edit box.....	49
Offset.....	49
Stencil Texture Controls.....	49
Brush Settings Panel - Stroke Sub panel.....	49
Stroke Panel with Stroke method Space.....	49
Spacing Edit Box.....	50
Spacing Pressure.....	50
Spacing Distance.....	50
Adjust Strength for Spacing.....	50
Dash Ratio.....	50
Dash Length.....	50
Jitter Edit Box.....	50
Jitter Pressure.....	50
Jitter Unit.....	50
Input Samples Edit Box.....	50
Stabilize Stroke.....	50
Smooth Stroke Radius Edit Box.....	51
Smooth Stroke Factor Edit Box.....	51
Stroke Panel with Stroke method Curve.....	51
Spacing Edit Box.....	52
Spacing Distance.....	52
Adjust Strength for Spacing.....	52
Paint Curve edit box.....	52
Draw Curve Button.....	52
Jitter Edit Box.....	52
Jitter Pressure.....	52
Jitter Unit.....	52
Input Samples Edit Box.....	53
Stroke Panel with Stroke method Line.....	53
Spacing Edit Box.....	53
Spacing Distance.....	53
Adjust Strength for Spacing.....	53
Jitter Edit Box.....	53
Jitter Pressure.....	54
Jitter Unit.....	54
Input Samples Edit Box.....	54
Stroke Panel with Stroke method Airbrush.....	54
Rate Edit Box.....	54
Spacing Distance.....	54
Jitter Edit Box.....	54
Jitter Pressure.....	54
Jitter Unit.....	55
Input Samples Edit Box.....	55
Stabilize Stroke.....	55
Smooth Stroke Radius Edit Box.....	55

Smooth Stroke Factor Edit Box.....	55
Stroke Panel with Stroke method Anchored.....	55
Edge to Edge.....	55
Spacing Distance.....	56
Input Samples Edit Box.....	56
Stroke Panel with Stroke method Drag dot.....	56
Spacing Distance.....	56
Input Samples Edit Box.....	56
Stroke Panel with Stroke method dot.....	57
Spacing Distance.....	57
Jitter Edit Box.....	57
Jitter Unit.....	57
Input Samples Edit Box.....	57
Stabilize Stroke.....	57
Smooth Stroke Radius Edit Box.....	57
Smooth Stroke Factor Edit Box.....	57
Brush Settings Panel - Falloff Sub panel.....	58
Presets.....	58
Selecting Points.....	58
Adding Points.....	58
Navigation elements.....	58
Zoom in and out.....	58
Tools.....	59
Reset View.....	59
Vector Handle.....	59
Auto Handle.....	59
Auto Clamped Handle.....	59
Reset Curve.....	59
Use Clipping.....	59
Delete Points.....	59
Curve Presets.....	59
Falloff Shape.....	59
Brush Settings Panel - Cursor Sub panel.....	59
Cursor checkbox in header.....	59
Cursor Color.....	60
Inverse Color.....	60
Falloff Opacity.....	60
Override Overlay.....	60
Use Cursor Overlay.....	60
Texture Opacity.....	60
Override Overlay.....	60
Use Cursor Overlay.....	60
Dyntopo Panel.....	60
Dyntopo Panel.....	60
Resolution.....	61
Sample detail size picker.....	61
Refine method.....	61
Subdivide Collapse.....	61
Collapse Edges.....	61
Subdivide Edges.....	61
Detailing.....	61
Relative Detail.....	61
Brush Detail.....	61

Constant Detail.....	62
Manual Detail.....	62
Smooth shading.....	62
Remesh Panel.....	62
Voxel Size.....	62
Sample Detail Size.....	62
Adaptivity.....	62
Fix Poles.....	62
Smooth Normals.....	62
Preserve.....	63
Volume.....	63
Paint Mask.....	63
Face Sets.....	63
Remesh.....	63
Symmetry Panel.....	63
Mirror.....	63
Lock.....	63
Tiling.....	64
Feather.....	64
Radial.....	64
Tile Offset.....	64
Direction.....	64
Symmetrize.....	64
Merge Distance.....	64
Sculpt Mode - Options Panel.....	65
Display.....	65
Fast Navigate.....	65
Delay Viewport Updates.....	65
Use Deform only.....	65
Display.....	65
Topology.....	65
Face Sets.....	65
Mesh Boundary.....	65
Face Sets Boundary.....	65
Cavity.....	65
Cavity (Inverted).....	65
Area Normal.....	65
View Normal.....	65
Propagation Steps.....	66
Gravity sub panel.....	66
Factor.....	66
Orientation.....	66

Tools Tab in Sculpt Mode

Sculpting is a process to deform the geometry by using a brush. Mesh objects, Grease Pencil objects and Hair Curve objects can be sculpted. In this chapter we handle the mesh tools. Grease Pencil and Curve Objects have their own chapter.

In Sculpt Mode you will mainly find settings for the different brushes, General settings, and brush specific settings. This settings can be found in different panels. The different brushes have different options and settings, dependent of which brush is selected. This brush specific options and settings are explained in the tool shelf chapter. Here we just cover the general panels with options and settings that exists for (nearly) all brushes.

The Sculpt Mode just exists for Mesh, Grease Pencil and Hair Curve objects.

Brushes Panel

The Brush Panel contains an image browser to display the different Sculpt Brushes. Usually you have just one icon when you choose a brush from the tool shelf. But you can create your own brushes, based at the current chosen brush type. They save with the blend file when fake user is ticked.

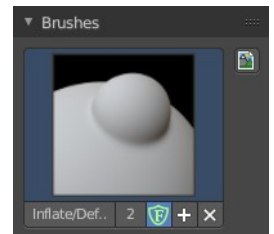

Browse Brush

The big image at the top is a drop down box where you can see the currently active brush. The file browser just shows the current active brush. Which gets chosen in the 3d view in the tool shelf. You can duplicate this brush, and modify it to your needs.

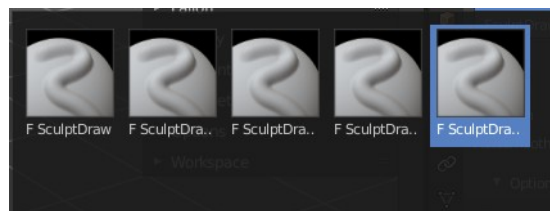
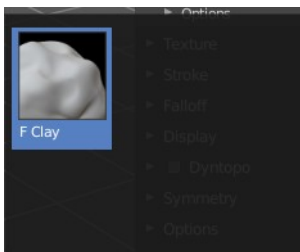

When you have added a few more brushes then the drop down box may be more than full. You will see some little white arrows then. Either in the top left or in the bottom right corner. They indicate that some brushes are hidden before or after the current display.

To scroll to this hidden content use the mouse wheel, or the arrow up and down buttons at the keyboard.

Custom Icon

The button at the right allows you to load a custom icon for your brush. It reveals a file browser below the image browser.

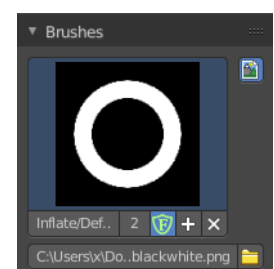

The edit box below the Image shows you the name of the current active brush.



The number right of it, **in this case 2**, indicates how much number of users (internally) this brush uses. This means that this data block (the brush) shares currently settings with at least one other object. Most probably the parent brush where we have created it from. Click at the value to make this brush a single user. The button will vanish then.

F set the brush to have a fake user. Zero user data-blocks are normally not saved. But sometimes you want to force the data to be kept even when the data block has no user.

The + button allows you to add a new pencil with the current settings. Note that the brushes are NOT saved when you close Bforartists. You can save them into the current blend file. Or you can save the startup file. But be careful here. This saves everything else of the current state of Bforartists too.

The X button deletes the brush as the active one. It does NOT delete it from the brushes list.

Brush Settings Panel

The Brush Settings Panel contains the Brush settings. The content differs, dependent of which brush you have chosen.

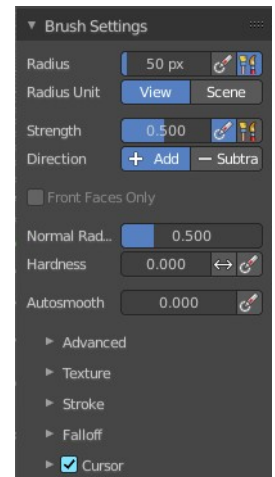

Brush Settings Panel - Common Settings

These settings can be found in all brushes.

Radius

The Radius edit box allows you to adjust the radius of the brush.

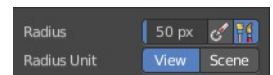

Size Pressure

The first button behind the edit box enables tablet pressure sensitivity for radius.

Use Unified Radius

The second button behind the edit box enables global radius size. Any modification at the radius will also modify the radius value for other paint tools.

Radius Unit

Display the radius value in view units or in scene units. View units are by default in pixels, scene units in meters.

Strength

The Strength edit box allows you to adjust the strength of the brush.



Size Pressure

The first button behind the edit box enables tablet pressure sensitivity for radius.

Use Unified Radius

The second button behind the edit box enables global radius size. Any modification at the radius will also modify the radius value for other paint tools.

Front Faces Only

Front Faces only means that the stroke just affects the vertices that are pointing forwards to the camera.



You need to have the falloff method set to Projected to activate the Front Faces Only checkbox.

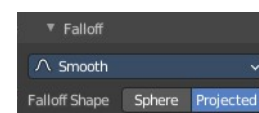

Normal Radius

The ratio between the brush radius and the radius that is going to be used to sample the normal.



Hardness

How close the brush falloff starts from the edge of the brush.



Invert Pressure for Hardness

Invert the modulation of pressure in hardness.

Use pressure for hardness

Tablet feature. Use pressure to modulate hardness.

Autosmooth

The autosmooth edit box allows you to adjust the amount of smoothing that gets automatically applied to each stroke.



Use pressure for hardness

Tablet feature. Use pressure to modulate hardness.

Brush Settings Panel - Draw brush

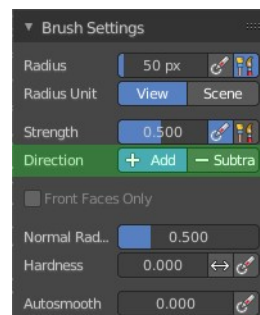

Direction Add / Subtract

Add means the stroke adds to the geometry. Subtract means the stroke subtracts from the geometry.



Brush Settings Panel - Draw Sharp brush

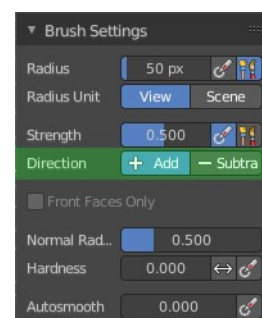

Direction Add / Subtract

Add means the stroke adds to the geometry. Subtract means the stroke subtracts from the geometry.



Brush Settings Panel - Clay brush



Direction Add / Subtract

Add means the stroke adds to the geometry. Subtract means the stroke subtracts from the geometry.

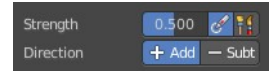

Plane Offset

Adjust the plane on which the brush acts towards or away from the objects surface.

Sculpting with the Clay brush happens in a plane defined by the view you are in and the first vertices hit by the brush.



Plane Trim

Various brushes like Clay, Clay Thumb, Fill and Scrape brush. Enable Plane Trim.

Sculpting with these brushes happens in a plane defined by the view you are in and the first vertices hit by the brush.

The trim distance defines a limit above which vertices are not affected by the brush.



Brush Settings Panel - Clay Strip brush

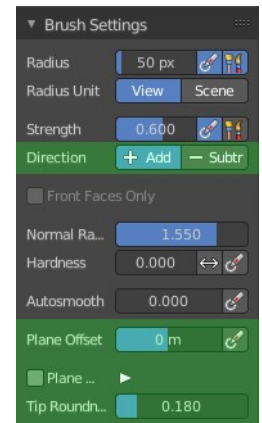

Direction Add / Subtract

Add means the stroke adds to the geometry. Subtract means the stroke subtracts from the geometry.



Plane Offset

Adjust the plane on which the brush acts towards or away from the objects surface.

Sculpting with the Clay brush happens in a plane defined by the view you are in and the first vertices hit by the brush.



Plane Trim

Various brushes like Clay, Clay Thumb, Fill and Scrape brush. Enable Plane Trim. Sculpting with these brushes



happens in a plane defined by the view you are in and the first vertices hit by the brush. The trim distance defines a limit above which vertices are not affected by the brush.

Distance

Adjust the plane trim distance.

Tip roundness

Roundness of the brush tip.



Brush Settings Panel - Clay Thumb brush

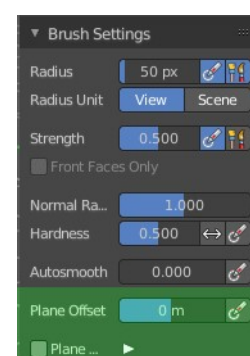

Plane Offset

Adjust the plane on which the brush acts towards or away from the objects surface.

Sculpting with the Clay brush happens in a plane defined by the view you are in and the first vertices hit by the brush.



Plane Trim

Various brushes like Clay, Clay Thumb, Fill and Scrape brush. Enable Plane Trim. Sculpting with these brushes happens in a plane defined by the view you are in and the first vertices hit by the brush. The trim distance defines a limit above which vertices are not affected by the brush.

Distance

Adjust the plane trim distance.



Brush Settings Panel - Layer brush

Direction Add / Subtract

Add means the stroke adds to the geometry. Subtract means the stroke subtracts from the geometry.

Height

Layer brush setting. The height that can be affected by the layer brush.

Persistent

Layer brush setting. Sculpt on a persistent layer of the mesh.

Set Persistent Base

This button resets the base so that you can add another layer.

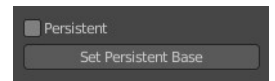
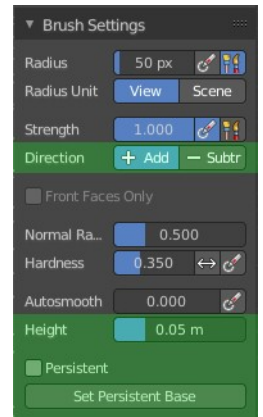

Brush Settings Panel - Inflate brush

Direction Inflate / Deflate

Add or subtract effect of the brush.

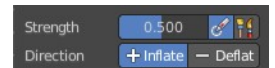
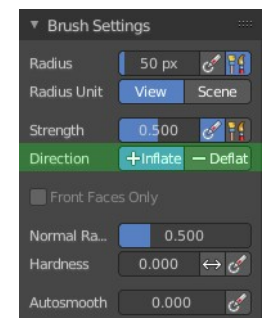

Brush Settings Panel - Blob brush



Direction Add / Subtract

Add means the stroke adds to the geometry. Subtract means the stroke subtracts from the geometry.



Magnify

The Crease Brush Pinch Factor.



Brush Settings Panel - Crease brush

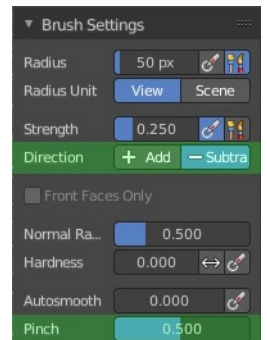

Direction Add / Subtract

Add means the stroke adds to the geometry. Subtract means the stroke subtracts from the geometry.



Pinch

The Crease Brush Pinch Factor.



Brush Settings Panel - Smooth brush

Direction Smooth / Enhance

Smooth or enhance the surface detail.

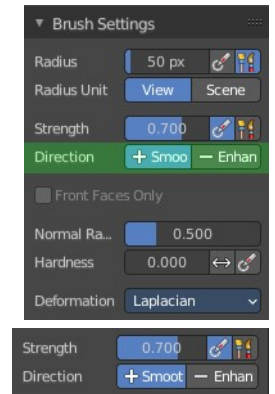

Brush Settings Panel - Flatten brush

Direction Contrast / Flatten

Give more contrast or smooth the surface.

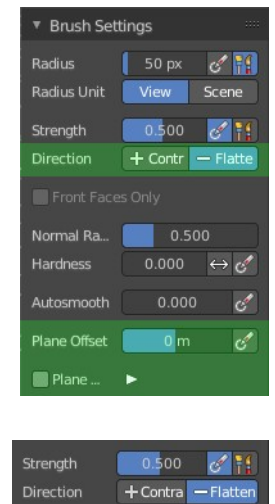

Plane Offset

Adjust the plane on which the brush acts towards or away from the objects surface.

Sculpting with the Clay brush happens in a plane defined by the view you are in and the first vertices hit by the brush.



Plane Trim

Enable Plane Trim. Sculpting with these brushes happens in a plane defined by the view you are in and the first vertices hit by the brush. The trim distance defines a limit above which vertices are not affected by the brush.



Brush Settings Panel - Fill brush

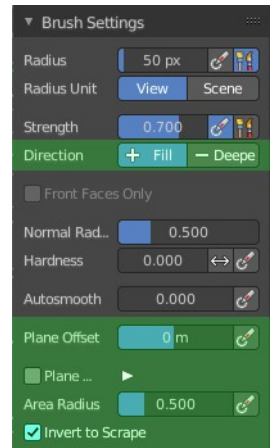

Direction Fill / Deepen

Add or subtract effect of the brush



Plane Offset

Adjust the plane on which the brush acts towards or away from the objects surface.

Sculpting with the Clay brush happens in a plane defined by the view you are in and the first vertices hit by the brush.



Plane Trim

Enable Plane Trim. Sculpting with these brushes happens in a plane defined by the view you are in and the first vertices hit by the brush. The trim distance defines a limit above which vertices are not affected by the brush.

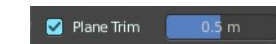

Area Radius

The ratio between the brush radius and the radius that is going to be used to sample the area center.



Size Pressure

Enables tablet pressure sensitivity for radius.

Invert to Scrape

Invert the stroke to a scrape stroke. Does not invert the displacement direction.



Brush Settings Panel - Scrape brush

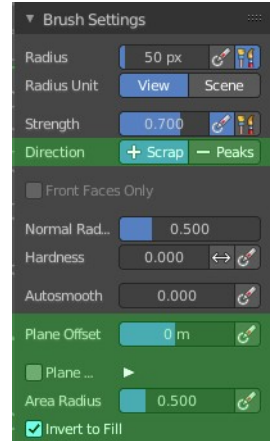

Direction Fill / Deepen

Add or subtract effect of the brush.



Plane Offset

Adjust the plane on which the brush acts towards or away from the objects surface.

Sculpting with the Clay brush happens in a plane defined by the view you are in and the first vertices hit by the brush.



Plane Trim

Enable Plane Trim. Sculpting with these brushes happens in a plane defined by the view you are in and the first vertices hit by the brush. The trim distance defines a limit above which vertices are not affected by the brush.



Area Radius

The ratio between the brush radius and the radius that is going to be used to sample the area center.



Size Pressure

Enables tablet pressure sensitivity for radius.



Invert to Fill

Use scrape or fill tool when inverting this brush instead of inverting its displacement direction.



Brush Settings Panel - Multi-plane Scrape brush

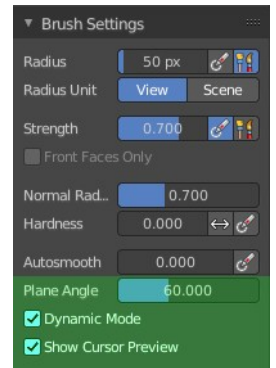

Plane Angle

Multiplane Scrape brush. The angles between the planes of the crease.



Dynamic Mode

Multiplane Scrape brush. Fit the angles during the stroke to fit the angles under the cursor.

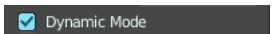

Show Cursor Preview

Multiplane Scrape brush. Preview the plane scrapes in the cursor during the stroke.



Brush Settings Panel - Pinch brush

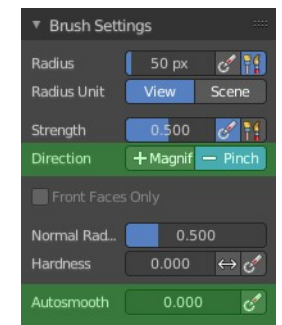

Direction Magnify / Pinch

Add or subtract effect of the brush.

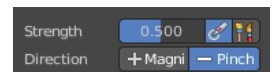

Autosmooth

The autosmooth edit box allows you to adjust the amount of smoothing that gets automatically applied to each stroke. The button behind the edit box enables tablet pressure sensitivity for autosmooth.



Brush Settings Panel - Grab brush

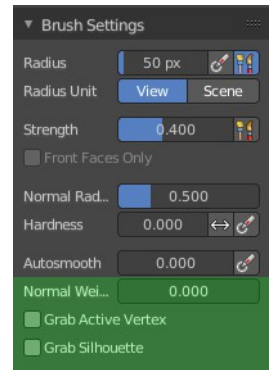

Normal Weight

How much grab will pull vertexes out of surface during grab.

Grab active Vertex

Apply the maximum grab strength to the active vertex instead of the cursor position.

Grab Silhouette

Grab trying to automask the silhouette of the object.



Brush Settings Panel - Elastic Deform brush

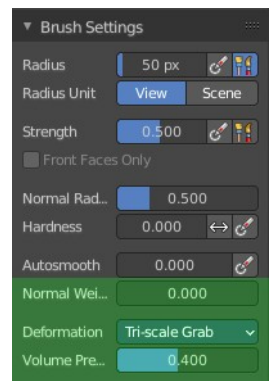

Normal Weight

How much grab will pull vertexes out of surface during grab.

Deformation

The deformation type to use.

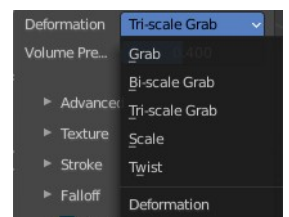

Volume Preservation

Poisson ratio for elastic deform. The higher the value is the more the volume is kept. But leads to more bulging.

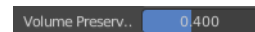

Brush Settings Panel - Snake Hook brush

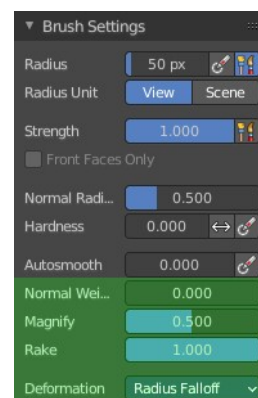

Normal Weight

How much grab will pull vertexes out of surface during grab.



Magnify

The Crease Brush Pinch Factor.



Rake

How much grab will follow cursor rotation.



Deformation

The deformation type.



Brush Settings Panel - Thumb brush

Just standard settings.

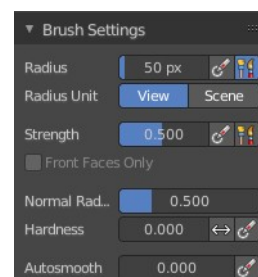

Brush Settings Panel - Pose brush

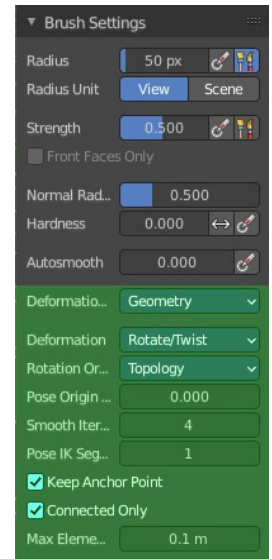

Deformation Target

Pose Brush setting. How the deformation of the brush will affect the object.

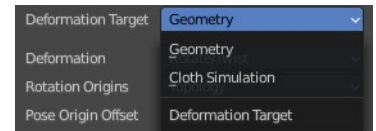

Deformation

Pose Brush setting. Deformation type that is used in the brush.



Lock Rotation when scaling

With Scale/Translate mode. Do not rotate the segment when using the scale deform mode.

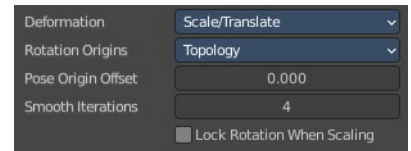

Rotation Origins

Pose Brush setting. Define the rotation origins.

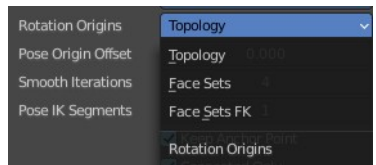

Pose Origin Offset

Pose Brush setting. Offset of the pose origin in relation to the brush radius.

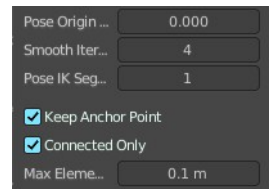

Smooth Iterations

Pose Brush setting. Smooth iterations applied after calculating the pose factor of each vertex.

Pose IK Segments

Pose Brush setting. Number of segments of the IK chain that will deform the mesh.

Keep Anchor Point

Pose Brush setting. Keep the position of the last segment in the IK chain fixed.

Connected only

Affect only topology connected elements.

Max Element Distance

Maximum distance to search for disconnected loose parts in the mesh.

Brush Settings Panel - Nudge brush

Just standard settings.

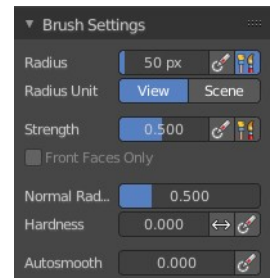

Brush Settings Panel - Rotate brush

Just standard settings.

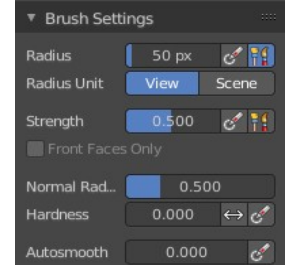

Brush Settings Panel - Slide Relax brush

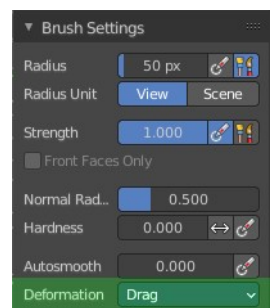

Deformation

The deformation type to use.

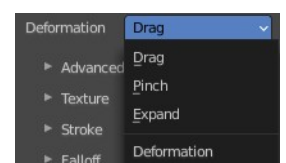

Brush Settings Panel - Boundary brush

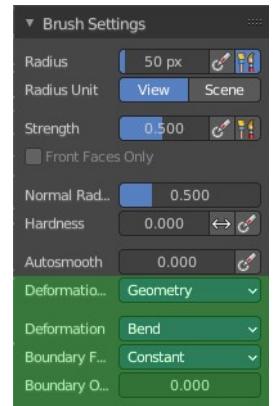

Deformation Target

The deformation type to use.

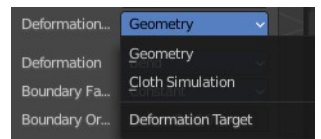

Deformation

The deformation type to use.

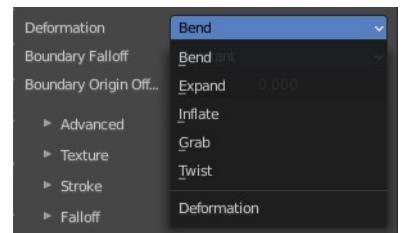

Boundary Falloff

Boundary brush option. The falloff type.

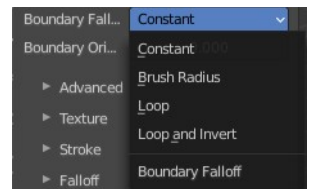

Boundary Origin Offset

Boundary brush option. Offset of the boundary origin in relation to the brush radius.



Brush Settings Panel - Cloth brush

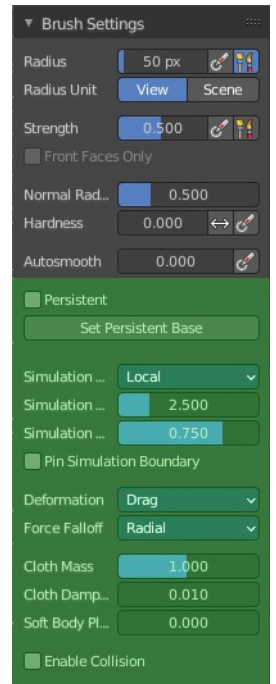

Persistent

Layer brush setting. Sculpt on a persistent layer of the mesh.

Set Persistent Base

This button resets the base so that you can add another layer.

Simulation Area

Cloth brush. Simulates either only a specific area around the brush or the entire mesh.

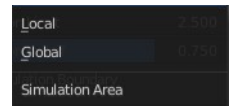

Simulation Limit

Cloth brush with local area. Factor added relative to the size of the radius. To limit the cloth simulation effect.



Simulation Falloff

Cloth brush with local area. The area to apply deformation falloff to the effects of the simulation.

Pin Simulation Boundary

Lock the position of the vertices in the simulation falloff area.

Deformation

Cloth brush. The type of cloth deformation that you want to perform.

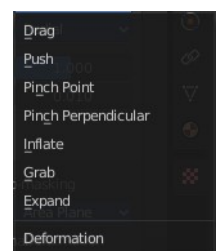

Force Falloff

Cloth brush. The shape that is used in the brush to apply force to the cloth.



Cloth Mass

Cloth brush. The mass of each simulation particle.

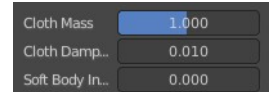

Cloth Damping

Cloth brush. How much the applied forces are propagated through the cloth.

Soft Body Influence

Cloth brush. How much the simulation preserves the original shape, acting as a soft body.

Enable Collision

Cloth brush. Collide with objects during the simulation.

Brush Settings Panel - Simplify brush

Just standard settings.

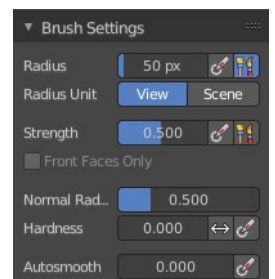

Brush Settings Panel - Mask brush

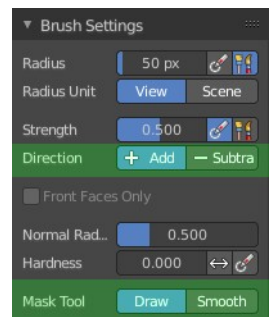

Direction Add / Subtract

Add means the stroke adds to the geometry. Subtract means the stroke subtracts from the geometry.

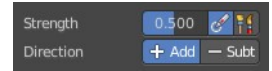

Mask Tool

Draw or smooth the current mask.

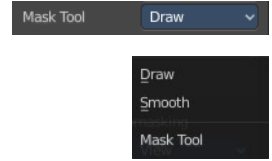

Brush Settings Panel - Draw Face Sets brush

Just standard settings.

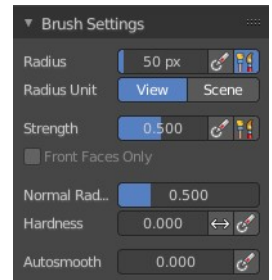

Brush Settings Panel - Multires Displacement Eraser brush

Just standard settings.

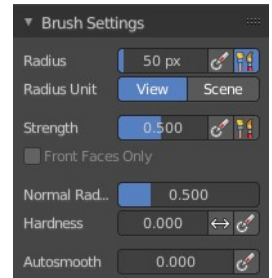

Brush Settings Panel - Multires Displacement Smear brush

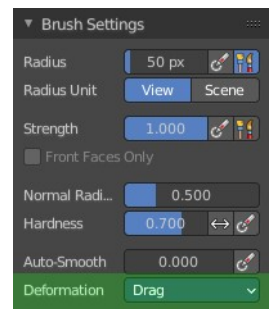

Deformation

The deformation method for the smear.

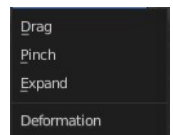

Brush Settings Panel - Paint

Paint allows you to vertex paint at the sculpt mesh.



Primary / Secondary color

Set the primary and secondary color for painting.

Swap colors

Swap the primary with the secondary color.

Use Unified Color

Use the same color over all editors and modes.

Blend Mode

The blending mode for the color.

Flow

Amount of paint applied per stroke sample.

Invert Pressure

Invert pressure.

Use Pressure

Use Pressure. This requires a tablet.

Wet Mix

Mix the existing color into the paint color.

Invert Pressure

Invert pressure.



Use Pressure

Use Pressure. This requires a tablet.

Wet Persistence

Amount of wet paint that stays at the stroke after applying paint to the surface.

Invert Pressure

Invert pressure.

Use Pressure

Use Pressure. This requires a tablet.

Wet Paint Radius

Ratio between the brush radius and the radius that gets used for wet paint.

Density

Amount of random elements that are going to be affected by the brush.

Invert Pressure

Invert pressure.

Use Pressure

Use Pressure. This requires a tablet.

Tip Roundness

Roundness of the brush tip.

Tip Scale X

Scale of the brush tip in X axis.

Brush Settings Panel - Smear

Smear vertex colors.

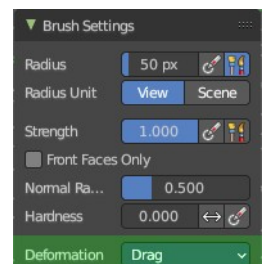

Deformation

How to deform the smearing.



Brush Settings Panel - Color Picker Sub panel

This sub panel is for the vertex painting paint tool. Define the primary and secondary color for the paint by a color picker and gradient dialog.

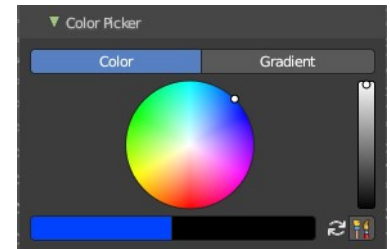

Mode

Color / Gradient

Choose the color mode.

Color picker mode

Colorpicker

The color wheel of the color picker.

Primary / Secondary color

Set the primary and secondary color for painting.

Swap colors

Swap the primary with the secondary color.

Use Unified Color

Use the same color over all editors and modes.

Gradient mode

Allows you to paint gradients.

Color Ramp

Color Ramps enables the user to specify a range of colors based on color stops. The color between the color stops gets interpolated.

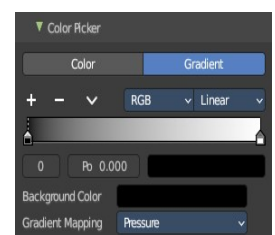

Controls

+

Add a stop to your color ramp. The stop will be added after the selected one, in the middle to the next one.

-

Deletes the selected color stop from the list.

Tools menu

Flip Color Ramp

Flips the gradient, inverting the values of the color ramp.

Distribute Stops from Left

Rearrange the stops so that every step has the same space to the right.

Distribute Stops Evenly

Space between all neighboring stops becomes equal.

Eyedropper (pipette icon) E

An Eyedropper to sample a color or gradient from the interface to be used in the color ramp.

Reset Color Ramp

Resets the color ramp to its default state.

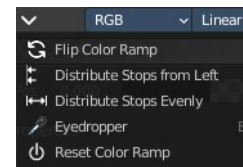

Color Mode

RGB

Blends color by mixing each color channel and combining.

HSV/HSL

Blends colors by first converting to HSV or HSL, mixing, then combining again. This has the advantage of maintaining saturation between different hues, where RGB would de-saturate, this allows for a richer gradient.

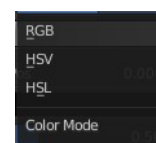

Interpolation

Ease

Uses an Ease Interpolation for the color stops.

Cardinal

Uses a Cardinal Interpolation for the color stops.

Linear

Uses a Linear Interpolation for the color stops.

B-Spline

Uses a B-Spline Interpolation for the color stops.

Constant

Uses a Constant Interpolation for the color stops.

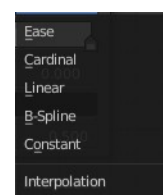

Color Ramp

The color band. A click at one of the color stops makes it the active one. You can move the color stops by clicking at them and dragging them around.



Active Color Stop elements

Adjust the active color stop.



Choose active color stop

Choose the color stop by index.

Pos

The position of the active color stop. The range goes from 0.000 to 1.000



Color

The color of the active color stop. Click at it to change the color.

Background Color

The background color.

Gradient Mapping

How to paint the gradient.



Pressure

Paint the gradient by tablet pressure. Obviously you need a tablet for this.

Repeat

Paint the gradient by repeating the colors.

Gradient Spacing

The spacing between the colors in screen pixels. You need to have a gradient spacing higher than 0.

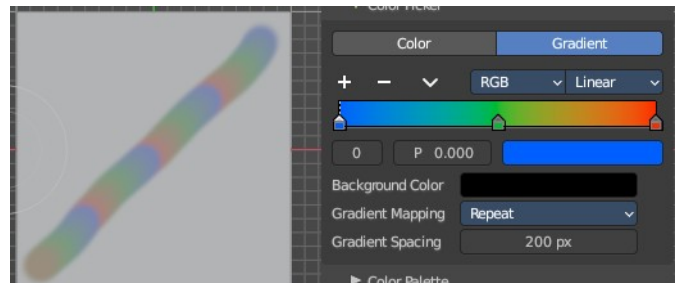

Clamp

Paint the gradient from first color to last color, and then sticks with the last color. You need to have a gradient spacing higher than 0.

Gradient Spacing

The spacing between the colors in screen pixels.

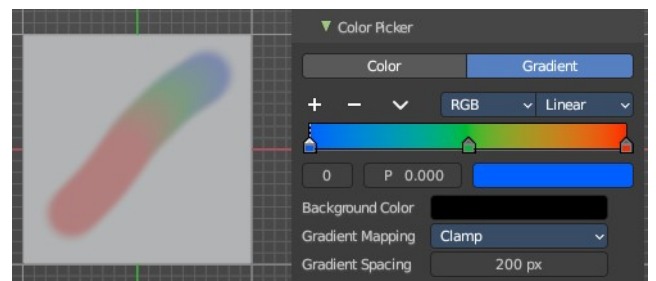

Brush Settings Panel - Color Palette Sub panel

This sub panel just shows with the paint tool. Define a color palette to use for vertex painting.

Create a color palette for later reuse.

First create a new palette by clicking at New. Then adjust the color in the color picker. And then click at the add button to add this color to the palette.

To set the color picker to a palette color simply click at this palette color.

To remove a color from the palette, choose it, then click at the remove button. The active palette color that gets removed is the one with the triangle at it.

The color palette cannot be saved externally. It is part of the current blend file. You can however append color palettes from other blend files.

The currently active color is the one with the triangle at it.

The elements are explained from left to right.

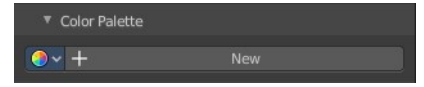

Palette browser

The button at the left opens a dropdown list. Choose between your palettes.

Edit Box

The name of the currently active palette. You can also rename the palette here. A click into the edit box makes the name editable.

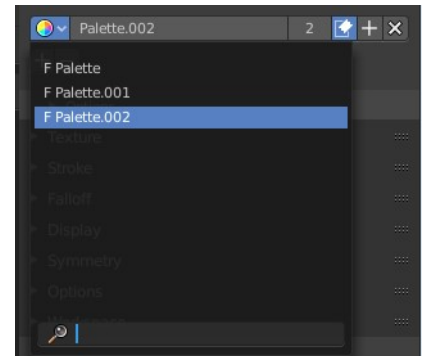

Number of users

See how many users the palette currently has.

Fake User

Fake User sets the element to have a fake user. Zero user data-blocks are normally not saved. But sometimes you want to force the data to be kept even when the data block has no user.

Add palette

Add a new palette.

Remove Palette

Clicking at this button removes the palette. Note that you need to save, close Bforartists and reload the blend file to remove the palette completely.

Add color

Adjust a color in the color picker. Then click at the add button to add this color to the palette.

Remove color

Select the color in the palette, then click at the minus button to remove it.

Sort By

Sort the palette by the chosen method.



Brush Settings Panel - Advanced Sub panel

In this sub panel you can find the not so often used settings. They differ from brush to brush. Have a look at the tool tips.

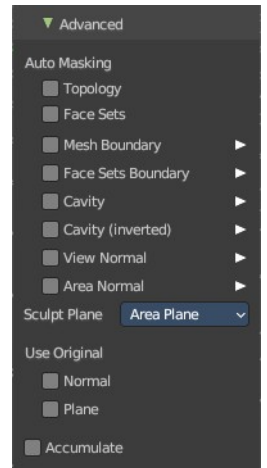

Topology

Affect only vertices that are connected to the current active vertex under the brush.

Face Sets

Affect only vertices that share face sets with the active vertex.

Mesh Boundary

Do not affect non manifold boundary edges.

The setting that appears on activation and is valid for both, Mesh Boundary and Face Sets Boundary.

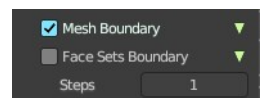

Face Sets Boundary

Do not affect vertices that belong to a face set boundary.

The setting that appears on activation and is valid for both, Mesh Boundary and Face Sets Boundary.

Steps

Distance where boundary edge automasking is going to protect vertices from the fully masked edge.

Cavity

Do not affect vertices on peaks. This feature is based on the surface curvature.

The setting that appears on activation and is valid for both, Cavity, and Cavity (Inverted).

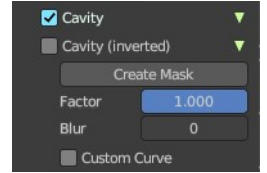

Cavity (Inverted)

Do not affect vertices in valleys. This feature is based on the surface curvature.

The setting that appears on activation and is valid for both, Cavity, and Cavity (Inverted).

Create Mask

Creates a mask based on the curvature of the surface.

Factor

The contrast of the cavity mask.

Blur

The number of times the cavity mask is blurred

Custom Curve

Use a custom falloff curve for the cavity mask.

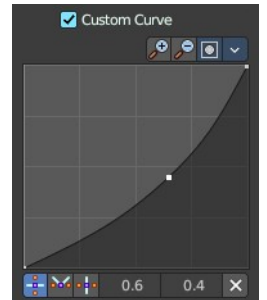

Selecting Points

You can select curve points. This reveals two edit boxes for the x and y coordinate of this point.

Selected points can be moved around. Left click at them, hold the mouse button down and move them to a new location.

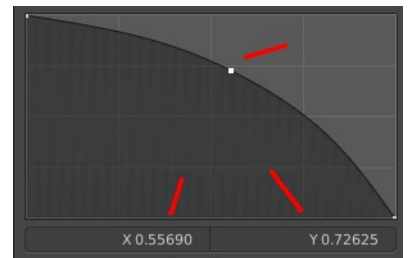

Adding Points

You can add new curve points by simply left clicking at the curve. Move the mouse to position them where you need it.

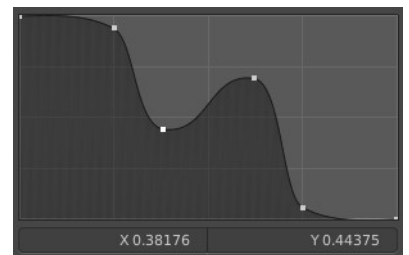

Navigation elements

The navigation elements at the top are described from left to right.



Zoom in and out

The two buttons with the magnifying glass at it zooms in and out in the curve window.

Clipping Options

Set up clipping for the stroke.

Use Clipping

Turns clipping on or off.

Min and Max X Y

The values for the clipping area.

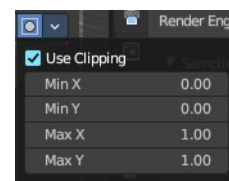

Tools

Tools is a menu where you can find some curve related tools.

Reset View

Resets the curve windows zoom.

Extend horizontal

Extends the curve before the first curve point and after the last curve point horizontally.

Extend extrapolated

Extends the curve before the first curve point and after the last curve point extrapolated.

Reset Curve

Resets the curve to the initial shape.

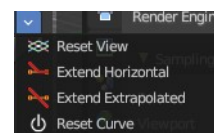

Handle Types

Sets the handle type for the current selected curve point.

X Y Position

The position of the current active curve point.

Delete Points

Deletes the current active curve point.

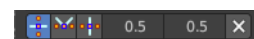

View Normal

Affect only vertices with a normal that faces the viewer.

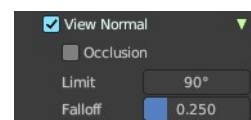

Occlusion

Only affect vertices that are not occluded by other faces. With Occlusion on the Limit and Falloff options are not available.

Limit

View normal limit. The range of angles that will be affected.

Falloff

Extend the angular range with a falloff gradient.

Area Normal

Affect only vertices with a similar normal to where the stroke starts.

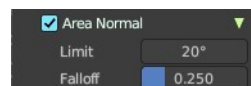

Limit

Area normal limit. The range of angles that will be affected.

Falloff

Extend the angular range with a falloff gradient.

Sculpt Plane

The sculpt plane defines how the sculpting is aligned. It is a dropdown box. Choose different methods. By default the Area Plane gets used.

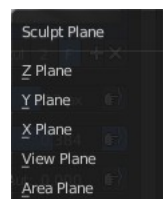

Use Original

Normal

When ticked keep using normal of the surface where the stroke was initiated.

Plane

When ticked keep using plane origin of the surface where the stroke was initiated.

Accumulate

Accumulate stroke daubts on top of each other.

Brush Settings Panel - Texture Subpanel

The Texture panel allows you to sculpt with textures. This allows you for example to grab a foto from some fish scales, and simply sculpt them into the surface of your object by using this image as a pencil. Or as a blueprint where you calk through (Stencil method).

Note that the following shots are made with Symmetry off and without Brush falloff. Since they disturbed.

Symmetry can be turned off a few panels deeper in the Symmetry panel.

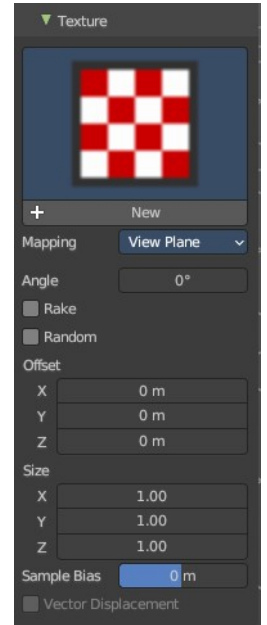

Browse Texture to be linked

The image at the top of the panel is a image browser. Choose a texture that you can choose for sculpting then. You can also have more than one image loaded at once.

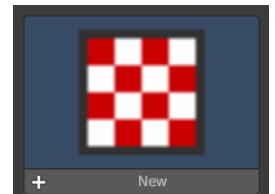

Adding a texture

The way to add the texture here is a bit more complicated. And not done with clicking at the New button.

First click at the New button below the image. This will create a new texture slot. This slot is still empty, it displays black.

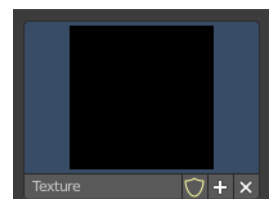

We need to load the texture in this slot. This must be done in the Properties editor in the Textures tab.

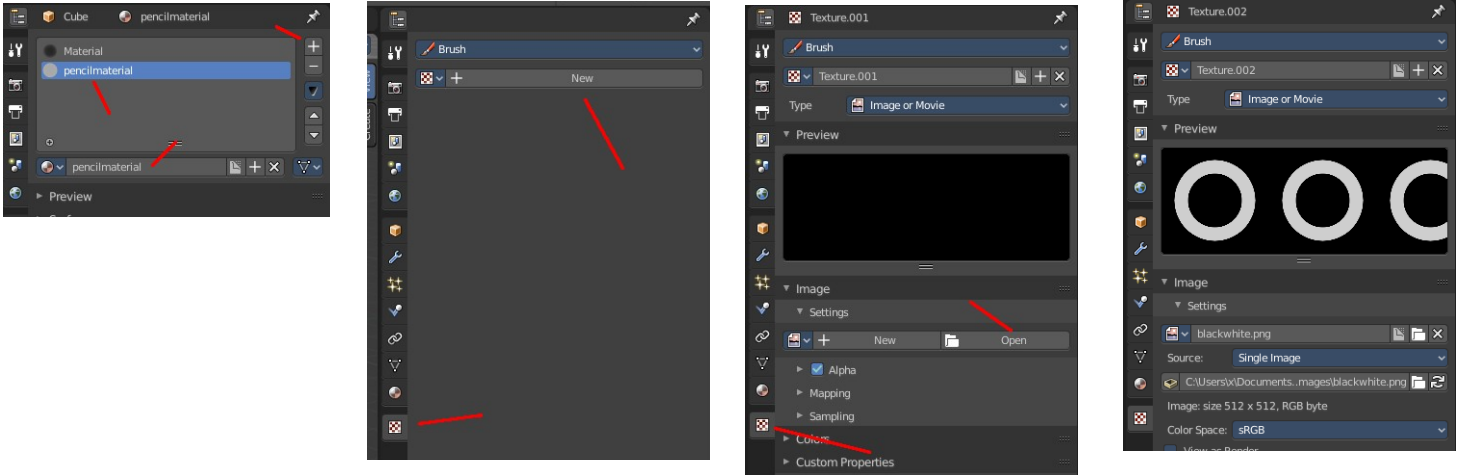

And when you switch back to the Tools tab, then the texture finally shows in the Texture panel in the Tool Shelf. And we can use it.

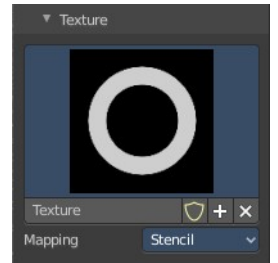

Texture Edit box

The Texture edit box is the edit box below the Image browser. When there's no image loaded then it displays the New button. When there's a image (or more) loaded, then you will see the name of the current texture.

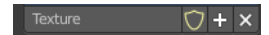

The Fake User button turns this texture into a data block with a fake user. Means it will exists even when there is no data connected to it anymore.

The + Button adds another texture slot. Note that you will have to load a texture too, as explained above.

The X button deletes the texture slot.

Brush Mapping

Our texture can be mapped in different methods. The Brush mapping is a drop down box. Choose this different brush mapping methods.

The settings vary. So we will go through them by the different brush mapping methods.

Brush Mapping with mapping method View Plane and Area Plane

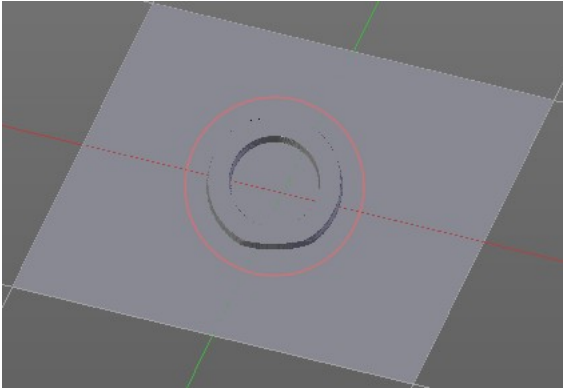

The brush mapping method View Plane maps the brush onto the surface of the object, calculating the mapping from the current view. The result may be distorted when the view does not align with the surface of the object.

The brush mapping method Area Plane maps the brush onto the surface of the object, calculating the mapping from the current view. The result is not distorted.

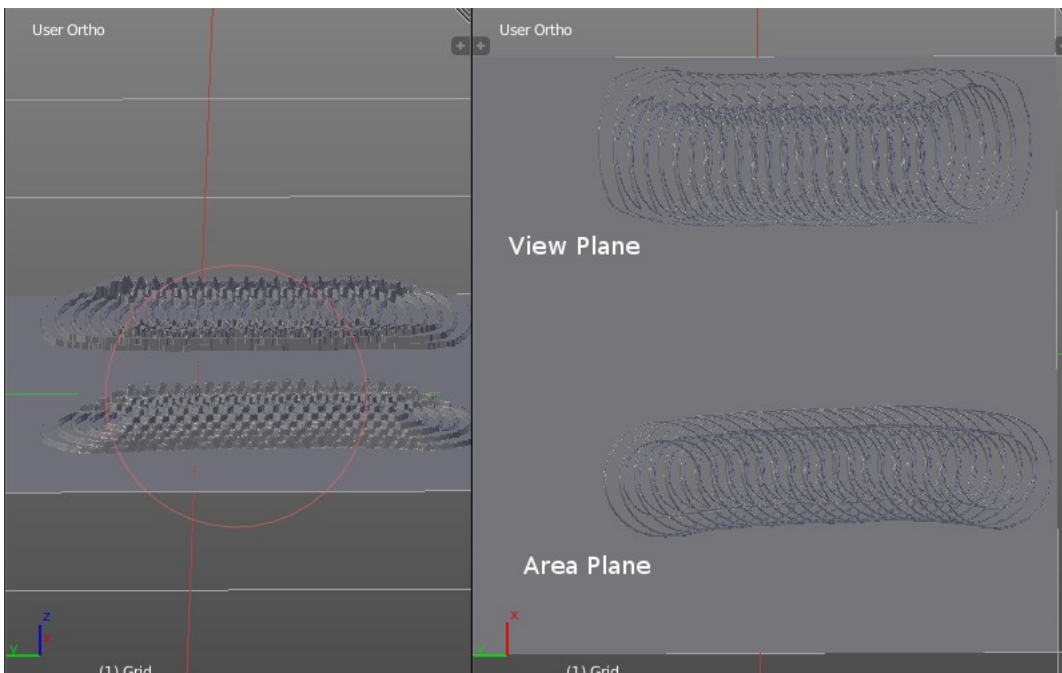
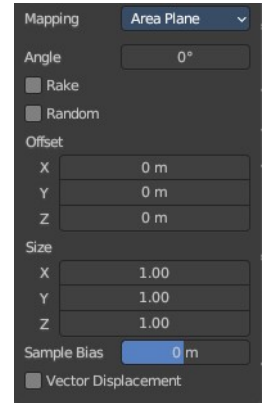

Angle edit box

Adjust the angle of the brush.

Rake

The angle follows the direction of the brush stroke.

Random

The brush angle gets set random.

Random edit box

Becomes visible when you tick Random. Adjust the maximum value of the random angle.

Offset

Fine tune the offset of the texture in the brush.

Size

Fine tune the size of the texture in the brush.

Sample Bias

Add to or subtract from the amount that gets added by the brush texture.

Vector Displacement

Just Area Plane. Handles each pixel color as an individual vector for displacement.

Brush Mapping with mapping method Tiled

The brush mapping method View Plane maps the brush onto the surface of the object, and tiles the pencil onto the surface. The mapping happens from the View plane. Means you get distortions when you sculpt from an angle.

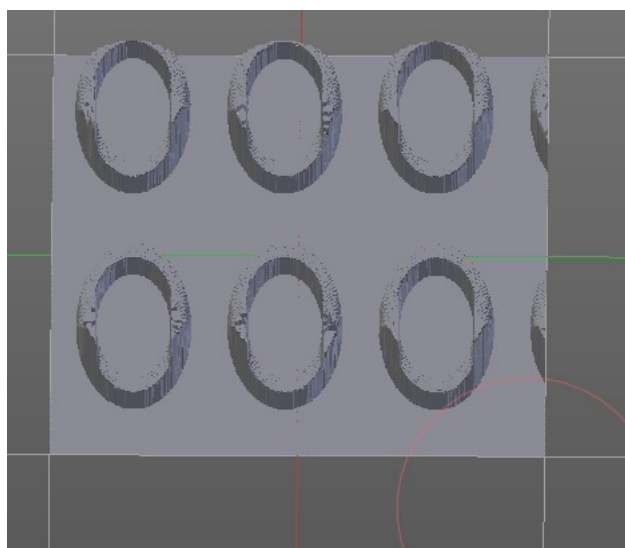
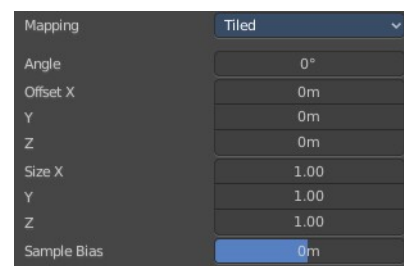

Angle edit box

Adjust the angle of the brush.

Offset

Fine tune the offset of the texture in the brush.

Size

Fine tune the size of the texture in the brush.

Sample Bias

Add to or subtract from the amount that gets added by the brush texture.

Brush Mapping with mapping method 3D

The brush mapping method View Plane and Area Plane sculpts where the pencil is. The method 3D sculpts at the initial position of the pencil, as long as you don't release the mouse. The mapping happens from the View plane. Means you get distortions when you sculpt from an angle.

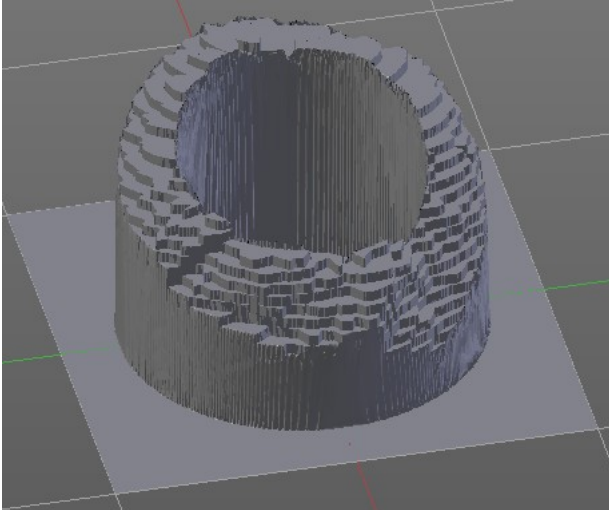
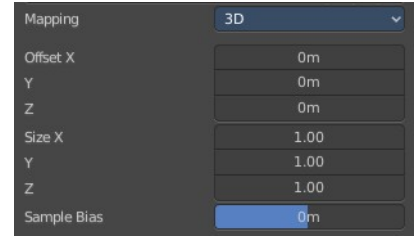

Offset

Fine tune the offset of the texture in the brush.

Size

Fine tune the size of the texture in the brush.

Sample Bias

Add to or subtract from the amount that gets added by the brush texture.

Brush Mapping with mapping method Random

The brush mapping method Random randomizes the texture position of the pencil. And so it sculpts random fragments of the pencil.

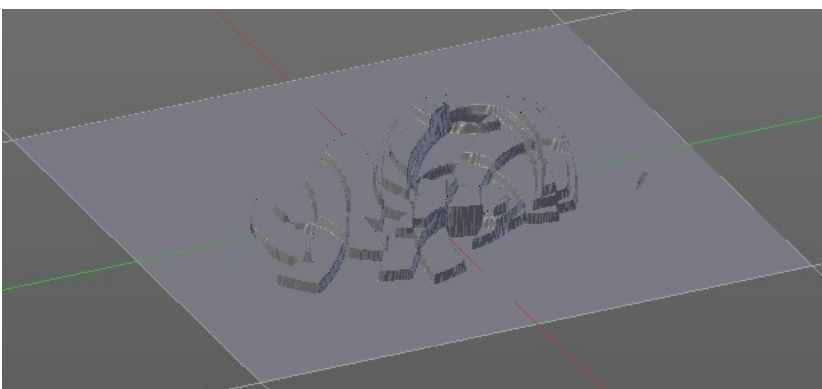

Angle edit box

Adjust the angle of the brush.

Rake

The angle follows the direction of the brush stroke.

Random

The brush angle gets set random.

Random edit box

Becomes visible when you tick Random. Adjust the maximum value of the random angle.

Offset

Fine tune the offset of the texture in the brush.

Size

Fine tune the size of the texture in the brush.

Sample Bias

Add to or subtract from the amount that gets added by the brush texture.

Brush Mapping with mapping method Stencil

The former methods uses the textures for the brush. The method Stencil works different. You have your texture displayed in the workspace above the object, and you paint this texture onto your object with your pencil strokes.

Note that the texture in the 3d space is just visible when you are with the mouse over the viewport.

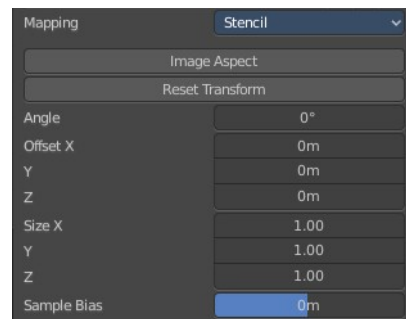
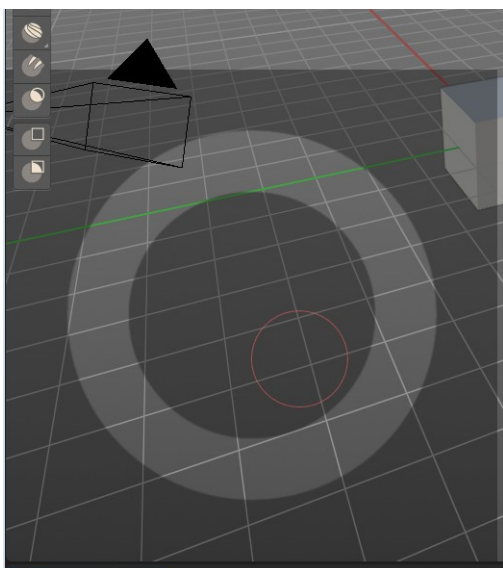

Image Aspect

Adjust the stencil size to fit to the image aspect ratio.

Angle edit box

Adjust the angle of the brush. The button at the end allows you to set the radius by dragging the mouse. This should be done in the viewport and with the hotkey. This button is just a visible reminder.



Offset

Fine tune the offset of the texture in the brush.

Stencil Texture Controls

You can find the controls to modify the position, rotation and scale of the stencil texture in the Brush menu in the 3D view. This happens by Hotkeys.

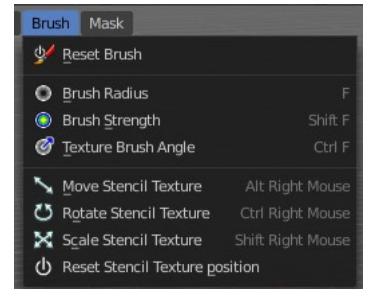

Brush Settings Panel - Stroke Sub panel

The Stroke panel contains settings to influence the behavior of the brush stroke. There are various stroke methods available. We will go through them one by one.

Stroke Panel with Stroke method Space

This is the default Stroke method. The sculpt stroke gets added continuously with given settings.

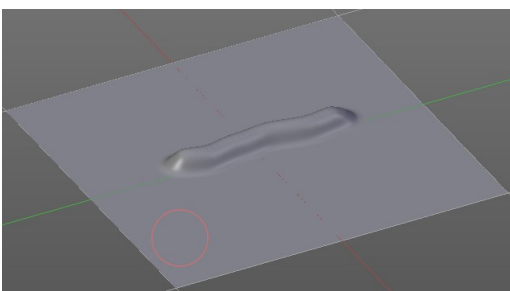
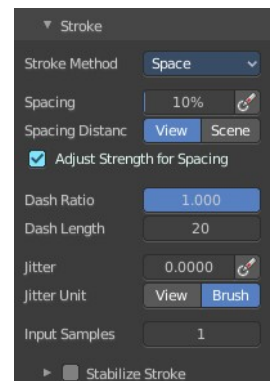

Spacing Edit Box

The sculpt drawing happens by mapping the pencil onto the mouse position. And when you move the mouse then the next mapping happens. Adjust the spacing after what mouse movement the next mapping should happen. The lower the value, the lower the distance between the single dots.

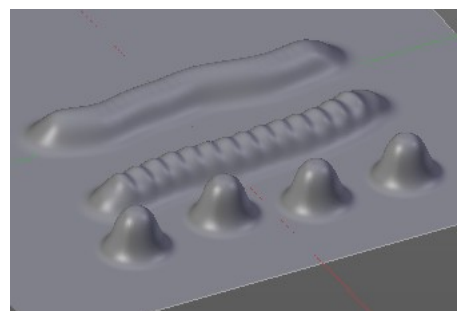

Spacing Pressure

The icon behind the edit box enables tablet pressure sensitivity for tablets.

Spacing Distance

If the spacing happens in View or in Scene distance.

Adjust Strength for Spacing

Automatically adjust the strength to give consistent results for different spacing.

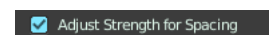

Dash Ratio

Ratio of samples in a cycle that the brush is enabled.

Dash Length

Length of a dash cycle measured in stroke samples.

Jitter Edit Box

Add Jitter to the brush while painting.



Jitter Pressure

The icon behind the edit box enables tablet pressure sensitivity for tablets.

Jitter Unit

If the jitter happens in screen space in pixels, or relative to the brush size.

Input Samples Edit Box

Average multiple input samples together to smooth the brush stroke.

Stabilize Stroke

When activated then the brush lags behind the mouse position, and produces a much smoother stroke by that. It is a sub panel with two settings.



Smooth Stroke Radius Edit Box

Adjust the radius of the smoothing.

Smooth Stroke Factor Edit Box

Adjust the factor of the smoothing.

Stroke Panel with Stroke method Curve

The Stroke method curve doesn't simply influence the way how the stroke is painted.

It is a special method. First you draw a curve object by holding down ctrl and clicking with left mouse button. Then you tweak the curve. You can click at the curve point, and drag out handlers to make the curve points smooth.

Then you hit the Draw Curve button. And the curve gets sculpted.

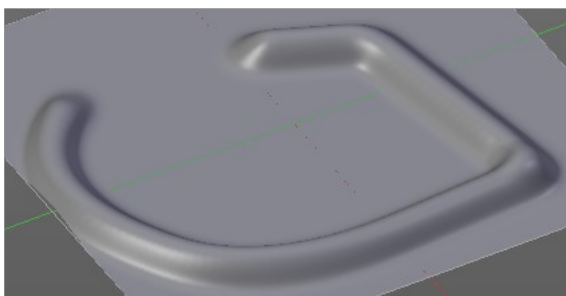
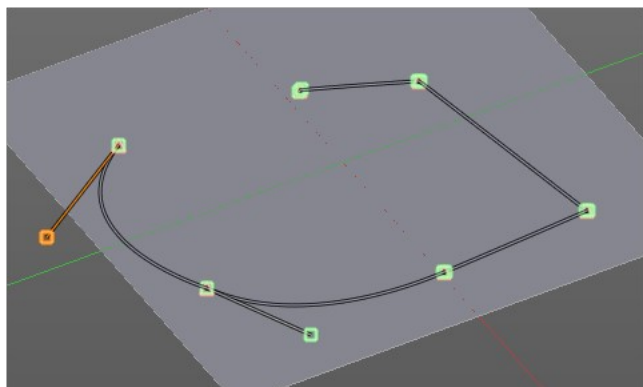
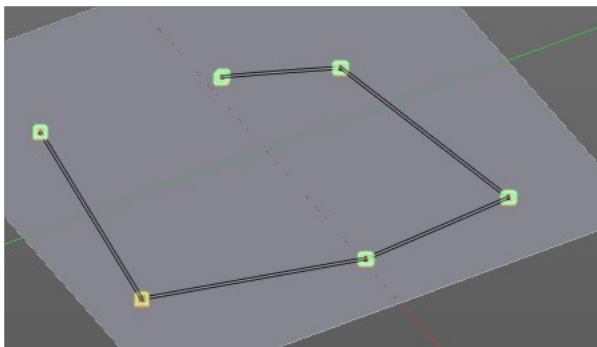
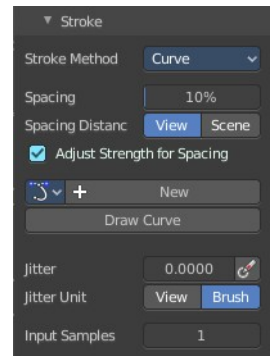

Spacing Edit Box

The sculpt drawing happens by mapping the pencil onto the mouse position. And when you move the mouse then the next mapping happens. Adjust the spacing after what mouse movement the next mapping should happen. The lower the value, the lower the distance between the single dots.

The icon behind the edit box enables tablet pressure sensitivity for tablets.

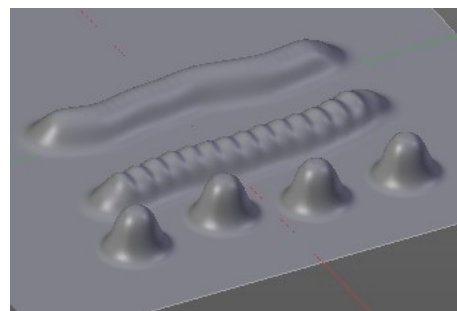
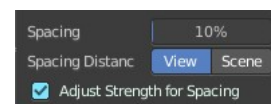

Spacing Distance

If the spacing happens in View or in Scene distance.

Adjust Strength for Spacing

Automatically adjust the strength to give consistent results for different spacing.

Paint Curve edit box

Here you set the active curve.

The first element is a drop down box where you will find your curves objects. You can have more than one.

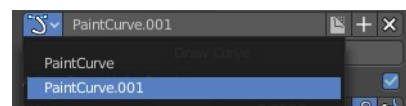

The second element is the edit box that displays the active curve.

Fake User set the brush to have a fake user. Zero user data-blocks are normally not saved. But sometimes you want to force the data to be kept even when the data block has no user.

The + button allows you to add a new pencil with the current settings. Note that the brushes are NOT saved when you close Bforartists. You can save them into the current blend file. Or you can save the startup file. But be careful here. This saves everything else of the current state of Bforartists too.

The X button deletes the brush as the active one. It does NOT delete it from the brushes list.

Draw Curve Button

A click at it to turns the curve into a sculpt stroke.

Jitter Edit Box

Add Jitter to the brush while painting.



Jitter Pressure

The icon behind the edit box enables tablet pressure sensitivity for tablets.

Jitter Unit

If the jitter happens in screen space in pixels, or relative to the brush size.

Input Samples Edit Box

Average multiple input samples together to smooth the brush stroke.



Stroke Panel with Stroke method Line

With Stroke method line you draw a line between a starting point and an endpoint. And when you release the mouse then the line gets sculpted.

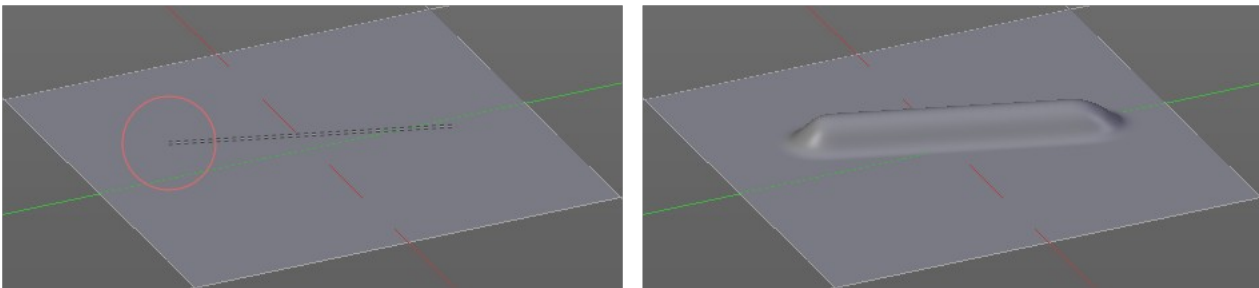
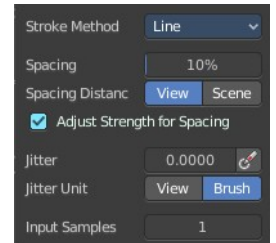

Spacing Edit Box

The sculpt drawing happens by mapping the pencil onto the mouse position. And when you move the mouse then the next mapping happens. Adjust the spacing after what mouse movement the next mapping should happen. The lower the value, the lower the distance between the single dots.

The icon behind the edit box enables tablet pressure sensitivity for tablets.

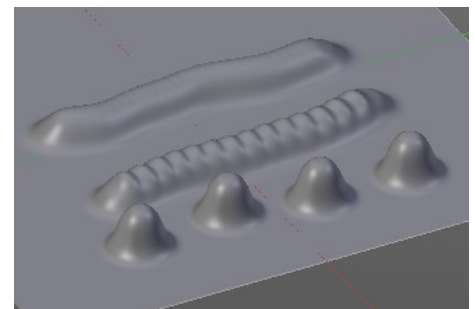
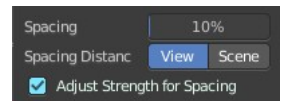

Spacing Distance

If the spacing happens in View or in Scene distance.

Adjust Strength for Spacing

Automatically adjust the strength to give consistent results for different spacing.

Jitter Edit Box

Add Jitter to the brush while painting.

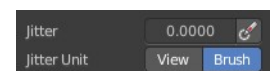

Jitter Pressure

The icon behind the edit box enables tablet pressure sensitivity for tablets.

Jitter Unit

If the jitter happens in screen space in pixels, or relative to the brush size.

Input Samples Edit Box

Average multiple input samples together to smooth the brush stroke.



Stroke Panel with Stroke method Airbrush

The sculpt stroke acts like an airbrush pencil. The dots gets placed randomly.

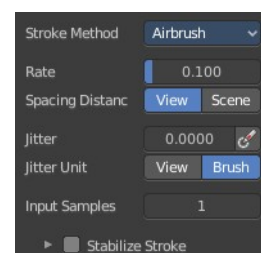
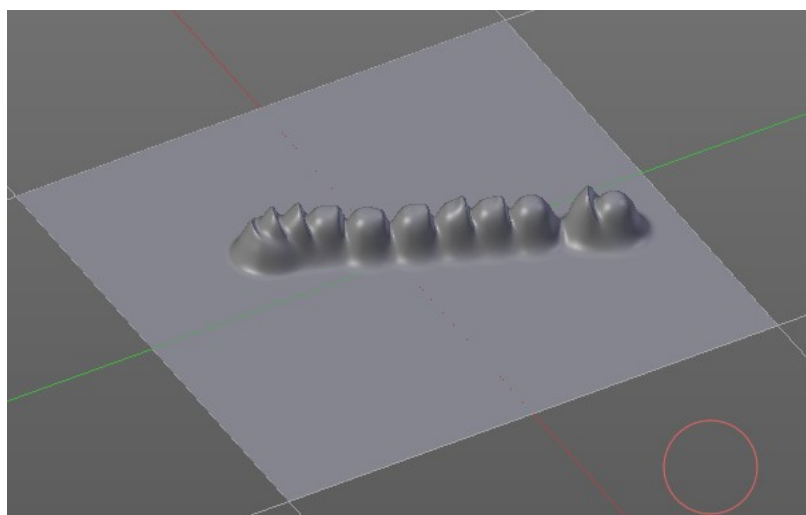

Rate Edit Box

Define the rate of the drawing.



Spacing Distance

If the spacing happens in View or in Scene distance.

Jitter Edit Box

Add Jitter to the brush while painting.



Jitter Pressure

The icon behind the edit box enables tablet pressure sensitivity for tablets.

Jitter Unit

If the jitter happens in screen space in pixels, or relative to the brush size.

Input Samples Edit Box

Average multiple input samples together to smooth the brush stroke.



Stabilize Stroke

When activated then the brush lags behind the mouse position, and produces a much smoother stroke by that. Smooth stroke has two settings.

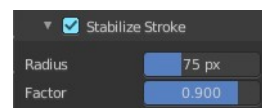

Smooth Stroke Radius Edit Box

Adjust the radius of the smoothing.

Smooth Stroke Factor Edit Box

Is just active when Smooth Stroke is activated. Adjust the factor of the smoothing.

Stroke Panel with Stroke method Anchored

Click and drag to place a dot and to scale it.

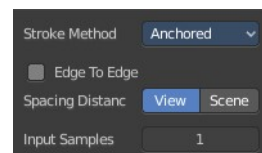
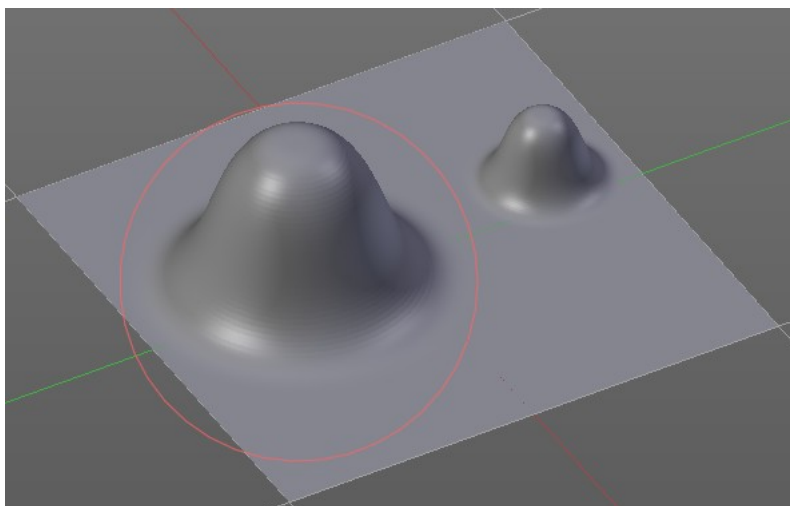

Edge to Edge

Without Edge to Edge the scaling happens from the center of the brush. With edge to edge the scaling happens from the edge of the brush.

Spacing Distance

If the spacing happens in View or in Scene distance.

Input Samples Edit Box

Average multiple input samples together to smooth the brush stroke.



Stroke Panel with Stroke method Drag dot

Click and drag to place a dot.

Spacing Distance

If the spacing happens in View or in Scene distance.

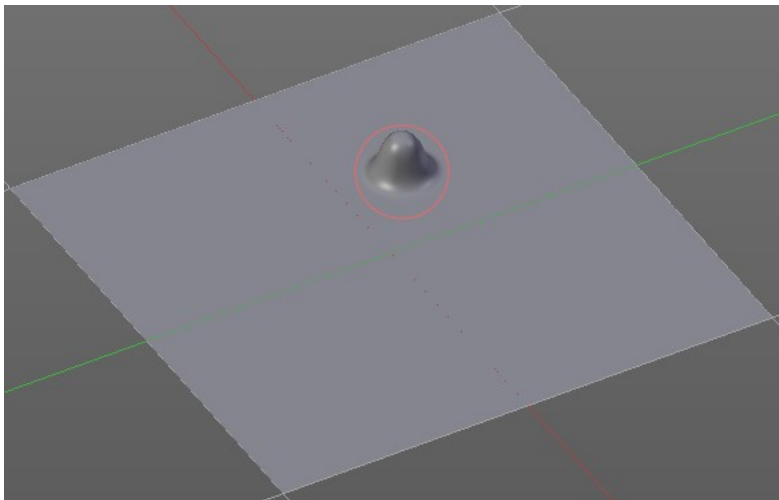
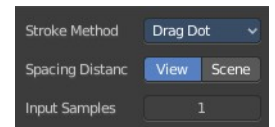

Input Samples Edit Box

Average multiple input samples together to smooth the brush stroke.



Stroke Panel with Stroke method dot

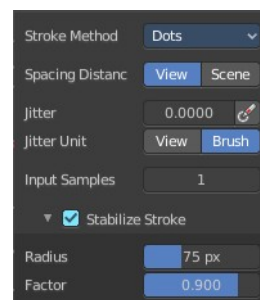
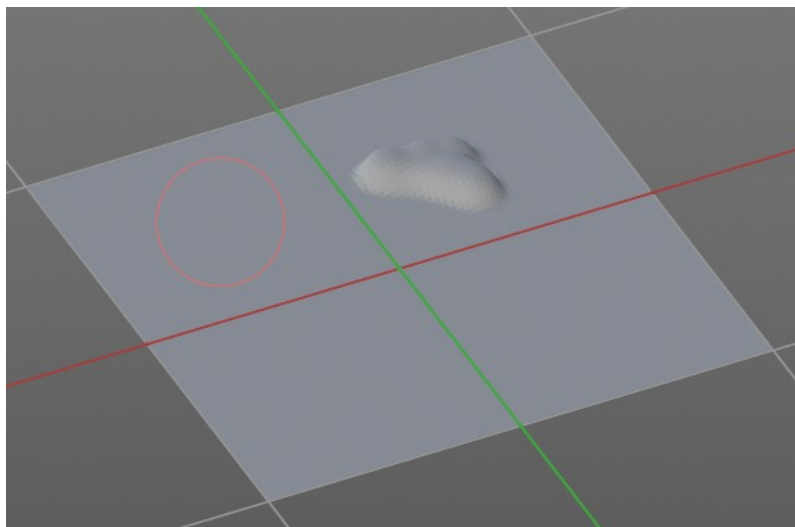

Spacing Distance

If the spacing happens in View or in Scene distance.

Jitter Edit Box

Add Jitter to the brush while painting.

The icon behind the edit box enables tablet pressure sensitivity for tablets.



Jitter Unit

Jitter in screen space or relative to the brush size.

Input Samples Edit Box

Average multiple input samples together to smooth the brush stroke.



Stabilize Stroke

When activated then the brush lags behind the mouse position, and produces a much smoother stroke by that. Smooth stroke has two settings.

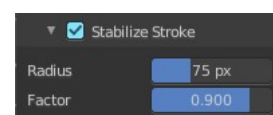

Smooth Stroke Radius Edit Box

Adjust the radius of the smoothing.

Smooth Stroke Factor Edit Box

Adjust the factor of the smoothing.

Brush Settings Panel - Falloff Sub panel

The Falloff panel allows you to define different falloffs methods for the border of the brush.

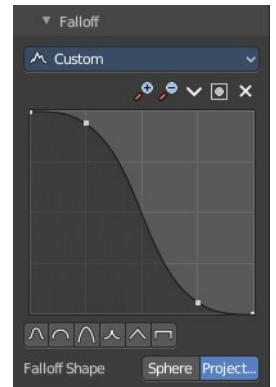
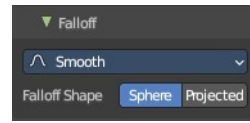

Presets

The different available falloff presets. The method custom allows you to define your own falloff. And reveals a curve panel.



Selecting Points

You can select curve points. This reveals two edit boxes for the x and y coordinate of this point.

Selected points can be moved around. Left click at them, hold the mouse button down and move them to a new location.

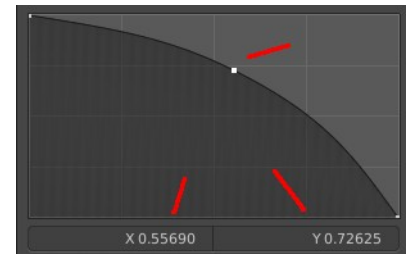

Adding Points

You can add new curve points by simply left clicking at the curve. Move the mouse to position them where you need it.

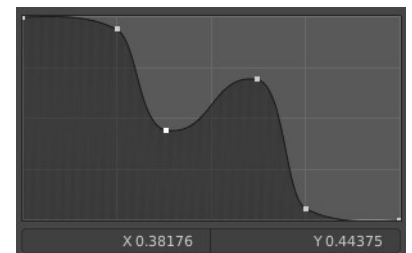

Navigation elements

The navigation elements at the top are described from left to right.



Zoom in and out

The two buttons with the magnifying glass at it zooms in and out in the curve window.

Tools

Tools is a menu where you can find some curve related tools.

Reset View

Resets the curve windows zoom.

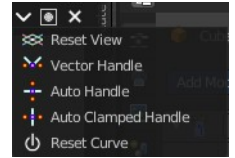

Vector Handle

Set handle type to Vector.

Auto Handle

Set handle type to Auto.

Auto Clamped Handle

Set handle type to Auto Clamped.

Reset Curve

Resets the curve to the initial shape.

Use Clipping

Clipping options. Set up clipping for the stroke. The blue button at the top turns clipping on or off.

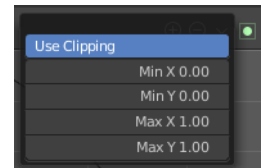

Delete Points

Deletes the selected curve point.

Curve Presets

Predefined curve presets as a starting point.



Falloff Shape

Use projected or spherical falloff.



Brush Settings Panel - Cursor Sub panel

Change the appearance of the brush cursor.

Cursor checkbox in header

Show or hide the brush cursor.

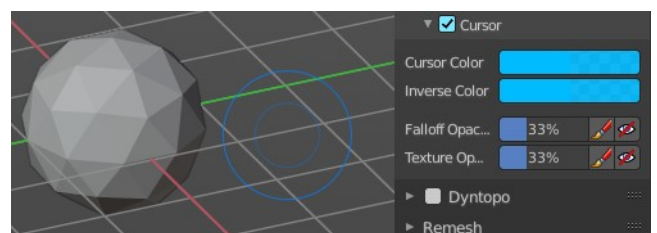

Cursor Color

The cursor color with add operations.

Inverse Color

The cursor color with subtract operations.

Falloff Opacity

You can turn on the cursor overlay with the eye button at the end. The falloff opacity slider allows you to adjust the opacity of this cursor overlay.

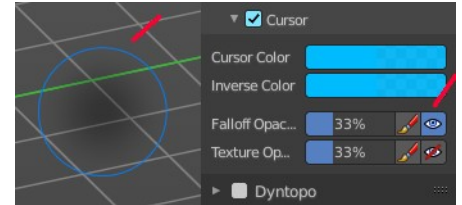

Override Overlay

Hide the Cursor Overlay when painting.

Use Cursor Overlay

Turn on Cursor Overlay.

Texture Opacity

This is for the case when you paint with a texture brush. You can turn on the Texture overlay with the eye button at the end. The falloff opacity slider allows you to adjust the opacity of this cursor overlay.

Override Overlay

Hide the Texture Overlay when painting.

Use Cursor Overlay

Turn on Texture Overlay.

Dyntopo Panel

Dyntopo Panel

Dyntopo stands for Dynamic Topology Sculpting.

Without Dyntopo you just deform the existing geometry. With Dyntopo geometry gets subdivided when needed. This makes it possible to sculpt complex shapes out of a block.

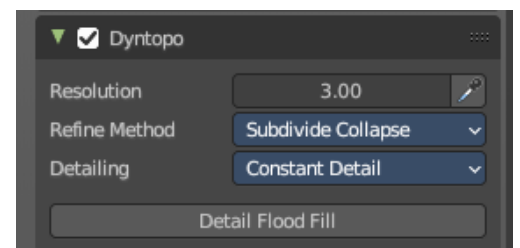

Left without Dyntopo, right with Dyntopo.

Note that some brushes does not work with Dyntopo. They are Grab brush, Rotate brush, Thumb brush, Layer brush, Smooth brush (including alt-key smoothing with a different brush) and Mask brush.

The topology will also not be updated if the stroke mode is Anchored or Drag Dot.

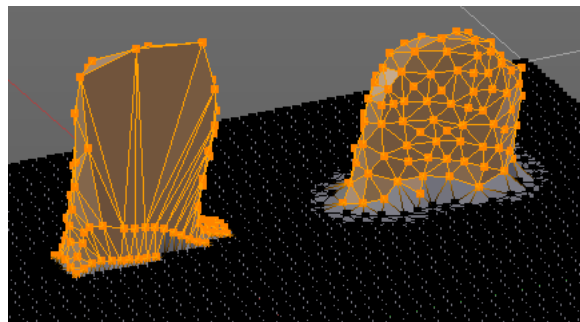

Resolution

The Resolution defines how fine the subdivision will be.



The edit box below does the same. But with a slider, and without visible feedback in form of a widget.

Sample detail size picker

This pipette allows you to pick the current resolution from a mesh.

Refine method

Define the Detail refine method.

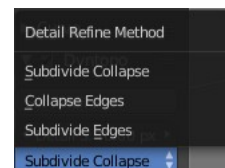

Subdivide Collapse

Both methods in one. Subdivide long edges to add mesh detail where needed. And collapse short edges to remove mesh detail where possible.

Collapse Edges

Collapse short edges to remove mesh detail where possible.

Subdivide Edges

Subdivide long edges to add mesh detail where needed.

Detailing

Define the Detail Type method.

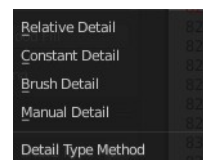

Relative Detail

Mesh Detail is relative to brush size and detail size

Brush Detail

Mesh Detail is relative to brush radius.

Constant Detail

Mesh detail is constant in object space according to detail size.

Manual Detail

Mesh detail does not change on each stroke. But just on flood fill

Remesh Panel

You may create a sculpt mesh that has ways too many polygons. Or too many polygons at one area, and not enough polygons at another area. Remeshing recreates the mesh geometry, with a more uniform topology.

Remesh does not work with Dyntopo enabled. You need to turn it of for remeshing.

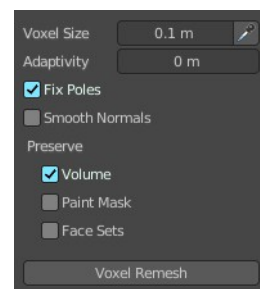

The Remesher in Sculpt mode uses the Voxel remesher only. When you want to remesh with the Quadriflow method, then use the settings in the Properties editor.

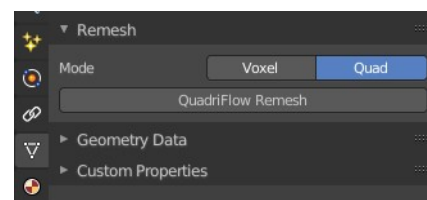

Voxel Size

Adjust the density of the new created geometry

Sample Detail Size

With this picker you can pick the density from an area of your mesh.

Adaptivity

Reduces the final face count by simplifying geometry where detail is not needed. This method uses tris. A value greater than 0 disables the Fix Poles feature.

Fix Poles

Produce less poles and a better topology flow.

Smooth Normals

Smooths the normals of the result.

Preserve

Volume

Tries to preserves the volume of the original mesh.

Paint Mask

Keep existing paint masks at the new mesh.

Face Sets

Keep the current face sets at the new created mesh.

Remesh

Starts the remesher.

Symmetry Panel

The Symmetry Lock panel contains tools around symmetry and lock features. Here you can turn on or off mirroring along axis, etc.



Mirror

Mirror sculpt along activated axis. By default the mirroring is activated around X axis.

The same buttons plus the whole Symmetry Lock Panel as a drop down menu can also be found in the tool settings bar as icon buttons. This allows quicker access and better visual control which mirror axis is currently active.

Lock

Disallow vertices movement in locked axis direction.

Tiling

Produces a mesh that is tilable in the activated directions.

Feather

Reduce the strength of the brush where it overlaps symmetrical daubs.



Radial

Adjust the repeating across some axis. For example, when you change Z to 32, then you can draw 32 segments simultaneously around the Z axis instead of just one, distributed around the Z axis.

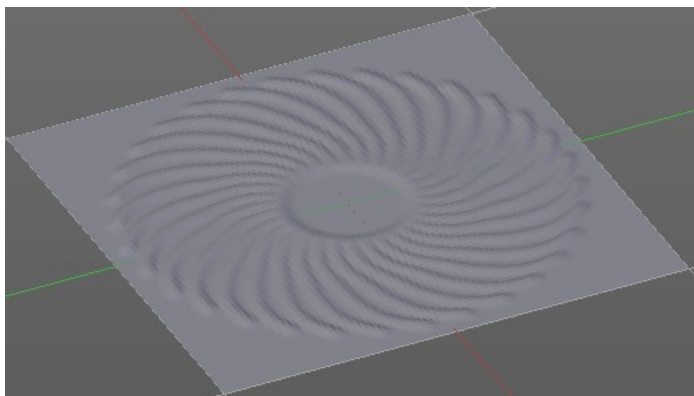

Tile Offset

Adjust the offset of the tiling.

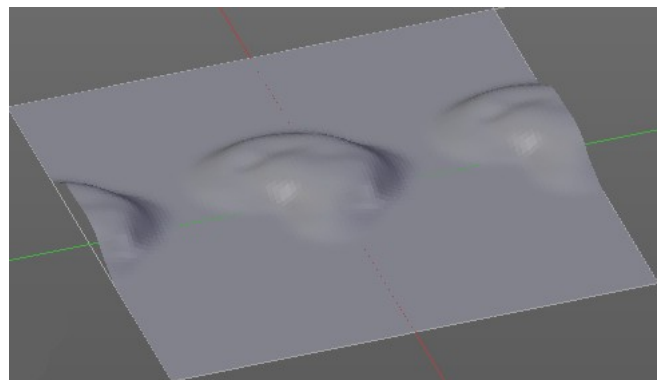

Direction

The direction in which the mirroring happens.

Symmetrize

Symmetrize the topology modifications.

Merge Distance

The distance to merge vertices with symmetrizing.

Sculpt Mode - Options Panel

Display

Fast Navigate

For Multires, show Low Res mesh when navigating.

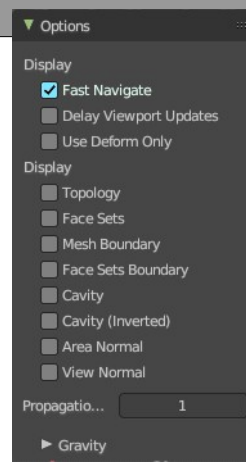

Delay Viewport Updates

Update the geometry when it enters the view. This enables a faster viewport navigation.

Use Deform only

Use only deformation modifiers (The other constructive modifiers except multi-resolution gets temporary disabled)

Display

Topology

Affect only vertices connected to the active vertex under the brush.

Face Sets

Affect only vertices that share face sets with the active vertex.

Mesh Boundary

Do not affect non manifold boundary edges.

Face Sets Boundary

Do not affect vertices that belongs to a face set boundary.

Cavity

Do not affect vertices at the peaks. Based on the surface curvature.

Cavity (Inverted)

Do not affect vertices in the valleys. Based on the surface curvature.

Area Normal

Affect only vertices with a similar normal to where the stroke starts.

View Normal

Affect only vertices with a normal that faces to the view.

Propagation Steps

Distance where boundary edge automasking is going to protect vertices from the fully masked edge.

Gravity sub panel

A panel with the gravity settings. Add gravity after each stroke.

Factor

The factor slider defines the amount.



Orientation

Here you define an object that gets used to determine the gravity from. The Z axis of this object gets used.



7.3.7 Editors - 3D Viewport - Sidebar - Tool Tab - Vertex Paint Mode

Table of content

Detailed table of content.....	1
Tools tab in Vertex Paint Mode.....	5
Brushes Panel.....	5
Browse Brush.....	5
Custom Icon.....	5
Brush Settings Panel.....	6
Brush Settings Panel - Color Picker Subpanel.....	7
Brush colors flip.....	7
Use unified Color.....	7
Brush Settings Panel - Color Palette Subpanel.....	8
Palette browser.....	8
Edit Box.....	8
Number of users.....	8
Fake User.....	8
Add palette.....	8
Remove Palette.....	8
Add color.....	8
Remove color.....	9
Sort By.....	9
Brush Settings Panel - Advanced Subpanel.....	9
Vertex Paint Mode - Texture Panel.....	9
Browse Texture to be linked.....	9
Texture Edit box.....	10
Brush Mapping.....	11
Brush Settings Panel - Stroke Sub panel.....	14
Stroke Panel with Stroke method Space.....	14
Stroke Panel with Stroke method Curve.....	16
Stroke Panel with Stroke method Line.....	17
Stroke Panel with Stroke method Airbrush.....	18
Stroke Panel with Stroke method Dots.....	19
Brush Settings Panel - Falloff Sub panel.....	20
Selecting Points.....	20
Adding Points.....	21
Navigation elements.....	21
Brush Settings Panel - Cursor Sub panel.....	22
Cursor Checkbox.....	22
Cursor Color.....	22
Falloff Opacity.....	22
Texture Opacity.....	23
Symmetry Panel.....	23
Mirror.....	23
Radial.....	23

Detailed table of content

Detailed table of content

Detailed table of content.....	1
Tools tab in Vertex Paint Mode.....	5
Brushes Panel.....	5
Browse Brush.....	5
Custom Icon.....	5
Brush Settings Panel.....	6
Blend.....	6
Radius.....	6
Size Pressure.....	7
Use Unified Radius.....	7
Strength.....	7
Size Pressure.....	7
Use Unified Radius.....	7
Brush Settings Panel - Color Picker Subpanel.....	7
Brush colors flip.....	7
Use unified Color.....	7
Brush Settings Panel - Color Palette Subpanel.....	8
Palette browser.....	8
Edit Box.....	8
Number of users.....	8
Fake User.....	8
Add palette.....	8
Remove Palette.....	8
Add color.....	8
Remove color.....	9
Sort By.....	9
Brush Settings Panel - Advanced Subpanel.....	9
Affect Alpha.....	9
Accumulate.....	9
Front Faces Only.....	9
Vertex Paint Mode - Texture Panel.....	9
Browse Texture to be linked.....	9
Texture Edit box.....	10
Brush Mapping.....	11
Brush Mapping with mapping method Tiled.....	11
Angle.....	11
Offset.....	11
Size.....	11
Brush Mapping with mapping method View Plane.....	11
Angle.....	12
Rake.....	12
Random.....	12
Offset.....	12
Size.....	12
Brush Mapping with mapping method 3D.....	12
Offset.....	12
Size.....	12
Brush Mapping with mapping method Random.....	12
Angle.....	13

Rake.....	13
Random.....	13
Offset.....	13
Size.....	13
Brush Mapping with mapping method Stencil.....	13
Image Aspect.....	14
Reset Transform.....	14
Angle edit box.....	14
Offset.....	14
Size.....	14
Brush Settings Panel - Stroke Sub panel.....	14
Stroke Panel with Stroke method Space.....	14
Spacing Edit Box.....	15
Dash Ratio.....	15
Dash Length.....	15
Jitter Edit Box.....	15
Spacing Pressure.....	15
Jitter Unit.....	15
Input Samples Edit Box.....	15
Stabilize Stroke.....	15
Smooth Stroke Radius Edit Box.....	16
Smooth Stroke Factor Edit Box.....	16
Stroke Panel with Stroke method Curve.....	16
Spacing Edit Box.....	16
Paint Curve edit box.....	17
Draw Curve Button.....	17
Jitter Edit Box.....	17
Jitter Pressure.....	17
Jitter Unit.....	17
Input Samples Edit Box.....	17
Stroke Panel with Stroke method Line.....	17
Spacing Edit Box.....	18
Jitter Edit Box.....	18
Jitter Pressure.....	18
Jitter Unit.....	18
Input Samples Edit Box.....	18
Stroke Panel with Stroke method Airbrush.....	18
Rate Edit Box.....	19
Jitter Edit Box.....	19
Jitter Pressure.....	19
Jitter Unit.....	19
Input Samples Edit Box.....	19
Stabilize Stroke.....	19
Smooth Stroke Radius Edit Box.....	19
Smooth Stroke Factor Edit Box.....	19
Stroke Panel with Stroke method Dots.....	19
Jitter Edit Box.....	19
Jitter Pressure.....	20
Jitter Unit.....	20
Input Samples Edit Box.....	20
Smooth Stroke.....	20
Smooth Stroke Radius Edit Box.....	20
Smooth Stroke Factor Edit Box.....	20

Brush Settings Panel - Falloff Sub panel.....	20
Selecting Points.....	20
Adding Points.....	21
Navigation elements.....	21
Zoom in and out.....	21
Tools.....	21
Reset View.....	21
Vector Handle.....	21
Auto Handle.....	21
Auto Clamped Handle.....	21
Reset Curve.....	21
Use Clipping.....	21
Delete Points.....	22
Curve window.....	22
Curve Presets.....	22
Falloff Shape.....	22
Front Face Falloff.....	22
Angle.....	22
Brush Settings Panel - Cursor Sub panel.....	22
Cursor Checkbox.....	22
Cursor Color.....	22
Falloff Opacity.....	22
Override Overlay.....	23
Use Cursor Overlay.....	23
Texture Opacity.....	23
Override Overlay.....	23
Use Cursor Overlay.....	23
Symmetry Panel.....	23
Mirror.....	23
Radial.....	23

Tools tab in Vertex Paint Mode

The Vertex paint allows you to color the vertices of a mesh.

In Vertex Paint Mode you will mainly find settings for the different brushes. General settings. And brush specific settings. This settings can be found in different panels. The brush specific options and settings are explained in the tool shelf chapter. Here we just cover the general panels.

The Vertex paint Mode just exists for Mesh objects.

Brushes Panel

The Brush Panel contains the different Brushes and some Brush settings. Choose and adjust your current active brush.

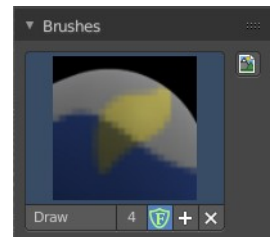

Browse Brush

The big image at the top is a dropdown box. Choose a brush. Click at it, and you will see the different brushes. A click at one of the images will choose this brush then.



When you have added a few more brushes then the dropdown box may be more than full. You will see some little white arrows then. Either in the top left or in the bottom right corner. They indicate that some brushes are hidden before or after the current display.

To scroll to this hidden content use the mouse wheel, or the arrow up and down buttons at the keyboard.

Custom Icon

The button at the right allows you to load a custom icon for your brush. It reveals a file browser below the image browser.

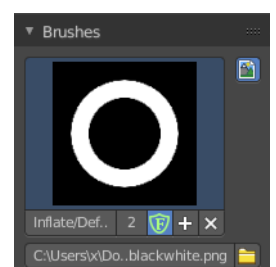

The edit box below the Image shows you the name of the current active brush.

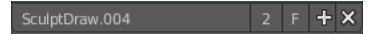

The number right of it, **in this case 2**, indicates how much number of users (internally) this brush uses. This means that this data block (the brush) shares currently settings with at least one other object. Most probably the parent brush where we have created it from. Click at the value to make this brush a single user. The button will vanish then.

F set the brush to have a fake user. Zero user data-blocks are normally not saved. But sometimes you want to force the data to be kept even when the data block has no user.

The + button allows you to add a new pencil with the current settings. Note that the brushes are NOT saved when you close Bforartists. You can save them into the current blend file. Or you can save the startup file. But be careful here. This saves everything else of the current state of Bforartists too.

The X button deletes the brush as the active one. It does NOT delete it from the brushes list.

Brush Settings Panel

The Brush Settings Panel contains the Brush settings. The content differs, dependant of which brush you have chosen.

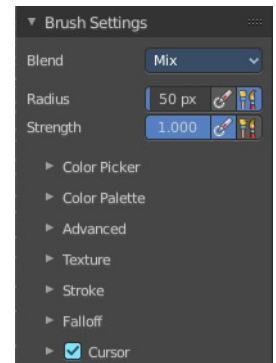

Blend

Define how the stroke will blend. You can choose between various blend modes.

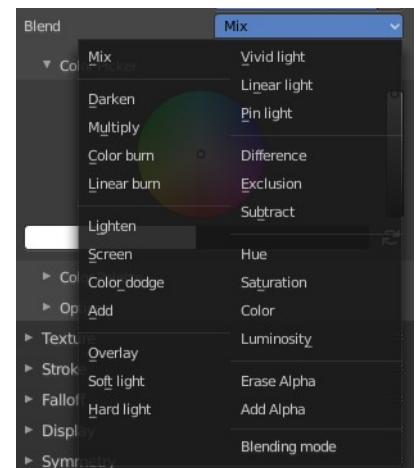

Radius

The Radius edit box allows you to adjust the radius of the brush. The button behind the edit box enables tablet pressure sensitivity for radius.

Size Pressure

The first button behind the edit box enables tablet pressure sensitivity for radius.

Use Unified Radius

The second button behind the edit box enables global radius size. Any modification at the radius will also modify the radius value for other paint tools.

Strength

The Strength edit box allows you to adjust the strength of the brush. The button behind the edit box enables tablet pressure sensitivity for strength.

Size Pressure

The first button behind the edit box enables tablet pressure sensitivity for radius.

Use Unified Radius

The second button behind the edit box enables global radius size. Any modification at the radius will also modify the radius value for other paint tools.

Brush Settings Panel - Color Picker Subpanel

Define the color for your brush.

The active color is the left one. When you click the button with the two arrows down right then you can swap the color with the secondary color. Then this secondary color becomes the primary color, and is active.



A click at one of the the color fields will open a more detailed color dialog, wSet up the color by using rgb, hsv and hex colors and with value sliders.



Brush colors flip

Flips the primary color with the secondary color.

Use unified Color

Choose if you want to use global colors or local color just for vertex painting.

Brush Settings Panel - Color Palette Subpanel

Create a color palette for later reuse.

First create a new palette by clicking at New. Then adjust the color in the color picker. And then click at the add button to add this color to the palette.

To set the color picker to a palette color simply click at this palette color.

To remove a color from the palette, choose it, then click at the remove button. The active palette color that gets removed is the one with the triangle at it.

The color palette cannot be saved externally. It is part of the current blend file. You can however append color palettes from other blend files.

The currently active color is the one with the triangle at it.

The elements are explained from left to right.

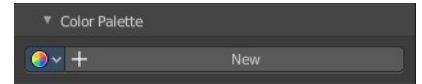

Palette browser

The button at the left opens a dropdown list. Choose between your palettes.

Edit Box

The name of the currently active palette. You can also rename the palette here. A click into the edit box makes the name editable.

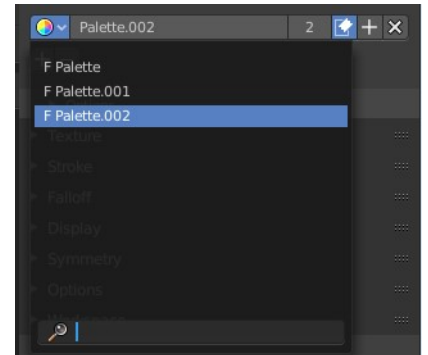

Number of users

See how many users the palette currently has.

Fake User

Fake User sets the element to have a fake user. Zero user data-blocks are normally not saved. But sometimes you want to force the data to be kept even when the data block has no user.

Add palette

Add a new palette.

Remove Palette

Clicking at this button removes the palette. Note that you need to save, close Bforartists and reload the blend file to remove the palette completely.

Add color

Adjust a color in the color picker. Then click at the add button to add this color to the palette.

Remove color

Select the color in the palette, then click at the minus button to remove it.

Sort By

Sort the palette by the chosen method.



Brush Settings Panel - Advanced Subpanel

Brush specific settings.

Affect Alpha

When disabled then the alpha is locked while painting.

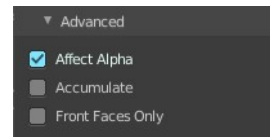

Accumulate

Accumulate stroke daubts on top of each other.

Front Faces Only

Paint just at faces that points forwards. Backwards pointing faces are not painted.

Vertex Paint Mode - Texture Panel

The Texture panel allows you to paint with textures. This allows you for example to grab a foto from some fish scales, and simply paint them onto the vertices by using this image as a pencil. Or as a blueprint where you calk through (Stencil method).

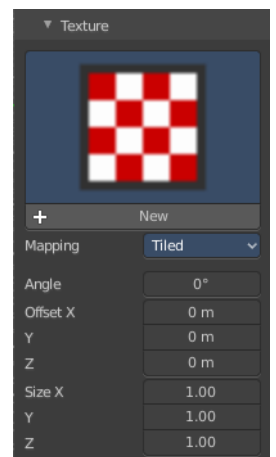

Browse Texture to be linked

The image at the top of the panel is a image browser. Choose a texture that you can choose for vertex painting then. You can also have more than one image loaded at once.

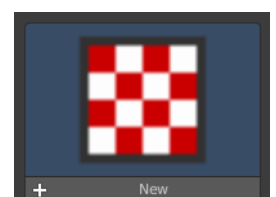

In this shot there is already a texture added. The way to add the texture here is a bit more complicated. And not done with clicking at the New button.

First click at the New button below the image. This will create a new texture slot. This slot is still empty, it displays black.

We need to load the texture in this slot. This must be done in the Properties editor in the Textures tab. And then the texture finally shows in the Texture panel in the Tool Shelf.

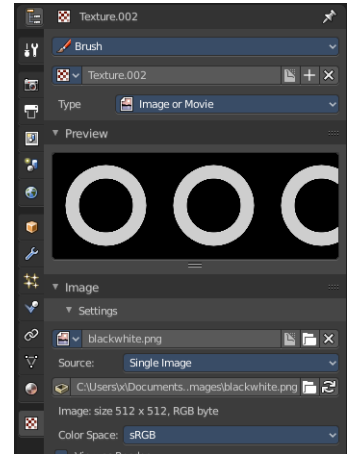
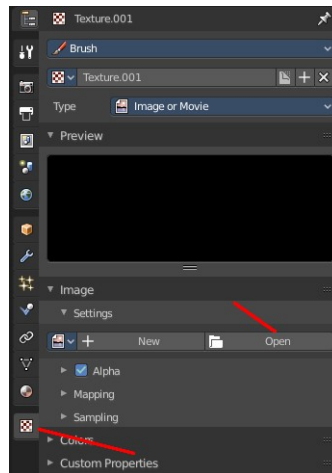
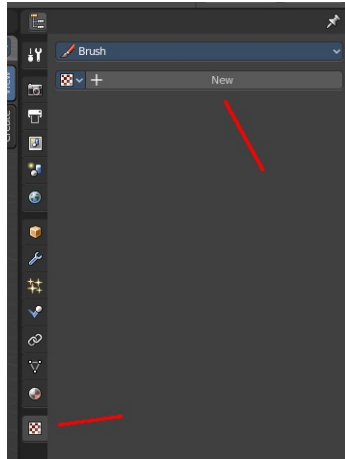
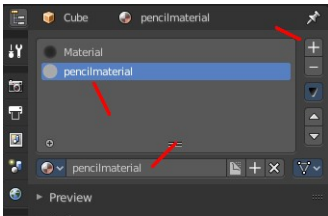
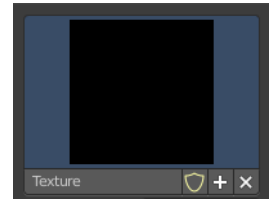

And when we switch back to the tools tab, then the texture is loaded. And we can work with this texture.

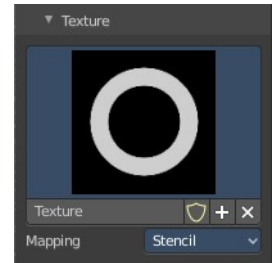

Texture Edit box

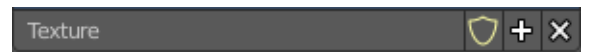

The Texture edit box is the edit box below the Image browser. When there's no image loaded then it displays the New button. When there's a image (or more) loaded, then you will see the name of the current texture.

The F button turns this texture into a data block with a fake user. Means it will exist even when there is no data connected to it anymore.

When you activate Fake User, then you may get a value in front of it, which displays how much users this data block (our texture slot) currently has.

The + Button adds another texture slot. Note that you will have to load a texture too, as explained above.

The X button deletes the texture slot.

Brush Mapping

Our texture can be mapped in different methods. The Brush mapping is a drop down box. Choose this different brush mapping methods.

The settings vary. So we will go through them by the different brush mapping methods.

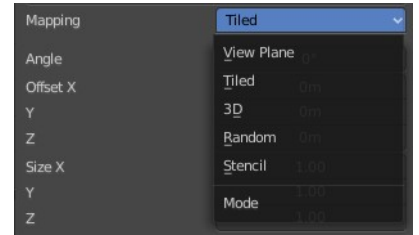

Brush Mapping with mapping method Tiled

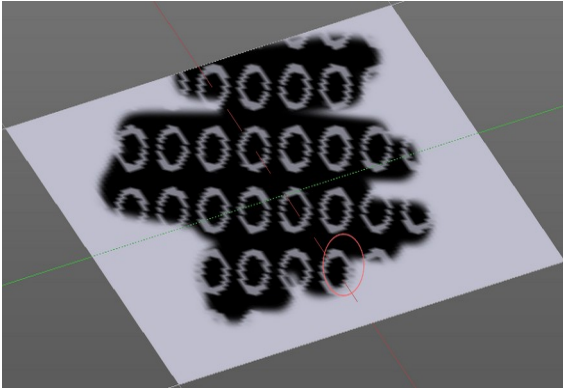

The brush mapping method Tiled tiles the brush stroke at the surface. The mapping happens from the current view. The result may be distorted when the view does not align with the surface of the object.

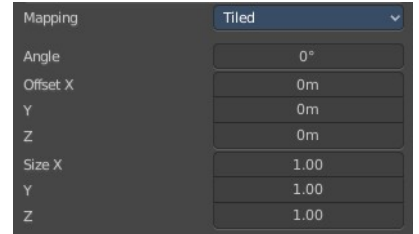

Angle

The angle of the brush.

Offset

The offset of the texture in the brush.

Size

The size of the texture in the brush.

Brush Mapping with mapping method View Plane

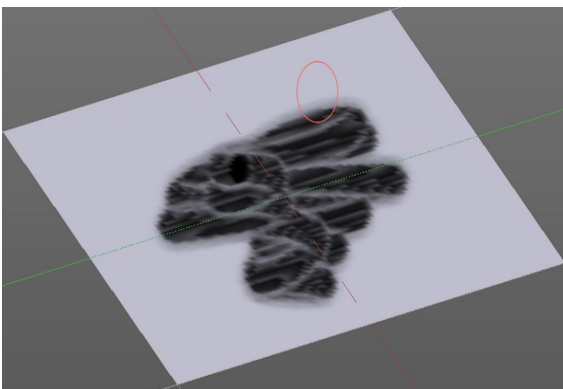

The brush mapping method View Plane simply paints onto the surface. The mapping happens from the current view. The result may be distorted when the view does not align with the surface of the object.

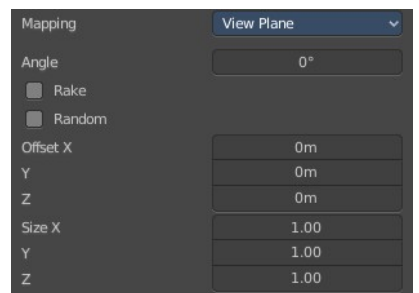

Angle

The angle of the brush.

Rake

The angle follows the direction of the brush stroke.

Random

The brush angle gets set random.

Offset

The offset of the texture in the brush.

Size

The size of the texture in the brush.

Brush Mapping with mapping method 3D

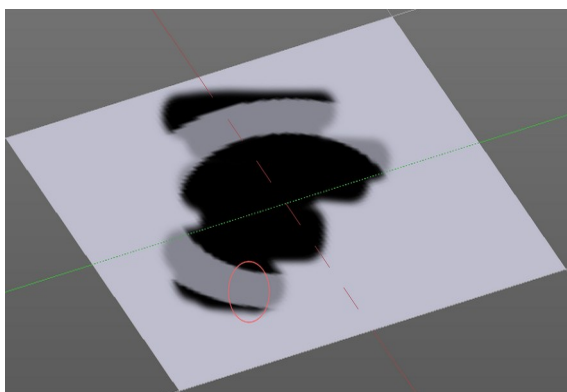

The brush mapping method 3D paints the texture at the surface, by tiling it 1/1 at the object surface.

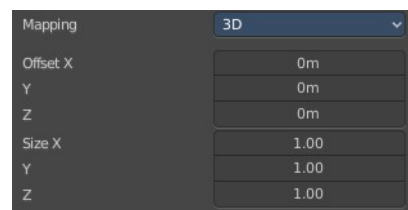

Offset

The offset of the texture in the brush.

Size

The size of the texture in the brush.

Brush Mapping with mapping method Random

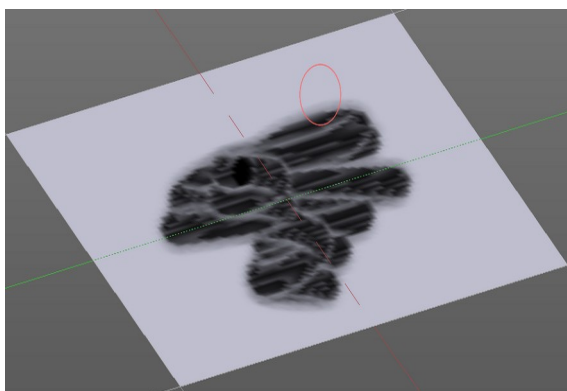

The brush mapping method Random paints onto the surface, and randomizes the texture position in the brush while that. The mapping happens from the current

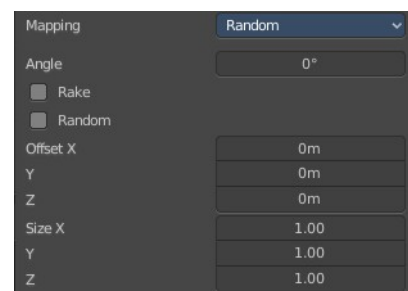

view. The result may be distorted when the view does not align with the surface of the object.

Angle

The angle of the brush.

Rake

The angle follows the direction of the brush stroke.

Random

The brush angle gets set random.

Offset

The offset of the texture in the brush.

Size

The size of the texture in the brush.

Brush Mapping with mapping method Stencil

The former methods uses the textures for the brush. The method Stencil works different. You have your texture displayed in the workspace above the object, and you paint this texture onto your object with your pencil strokes.

Note that the texture in the 3d space is just visible when you are with the mouse over the viewport. It gets by default displayed down left. You have to position it where you need it. See Brush menu, Stencil Texture controls.

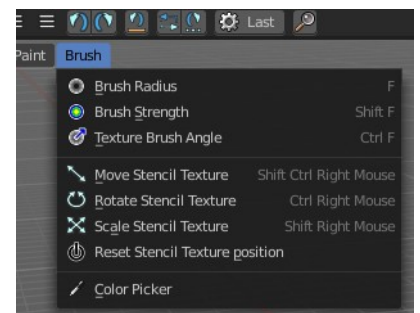
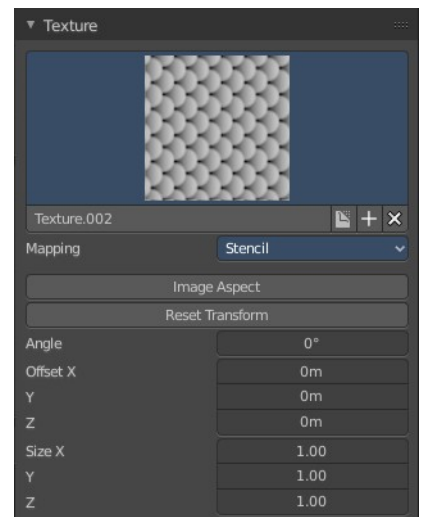
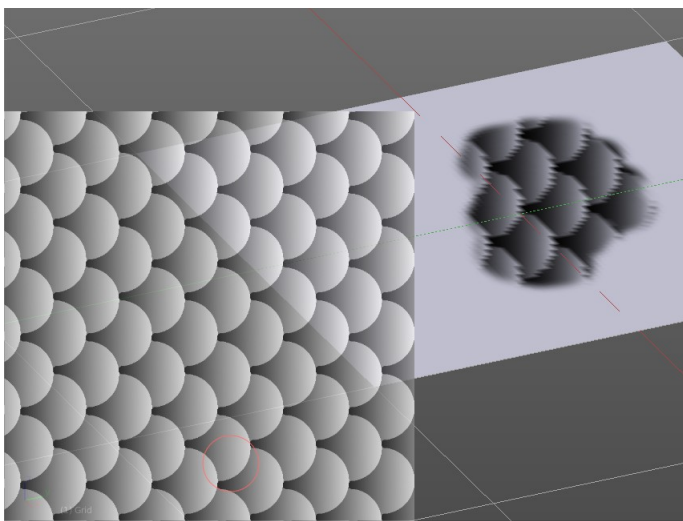

Image Aspect

Adjust the stencil size to fit to the image aspect ratio.

Reset Transform

Resets all transforms.

Angle edit box

Adjust the angle of the brush. The button at the end allows you to set the radius by dragging the mouse. This should be done in the viewport and with the hotkey. This button is just a visible reminder.

Offset

Fine tune the offset of the texture in the brush.

Size

Fine tune the size of the texture in the brush.

Brush Settings Panel - Stroke Sub panel

The Stroke panel contains settings to influence the behavior of the brush stroke. There are various stroke methods available. We will go through them one by one.

Stroke Panel with Stroke method Space

This is the default Stroke method. The sculpt stroke gets added continuously with given settings.

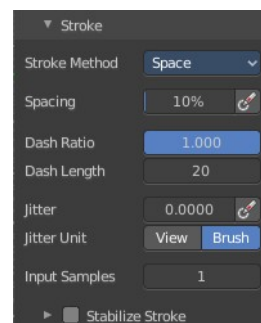
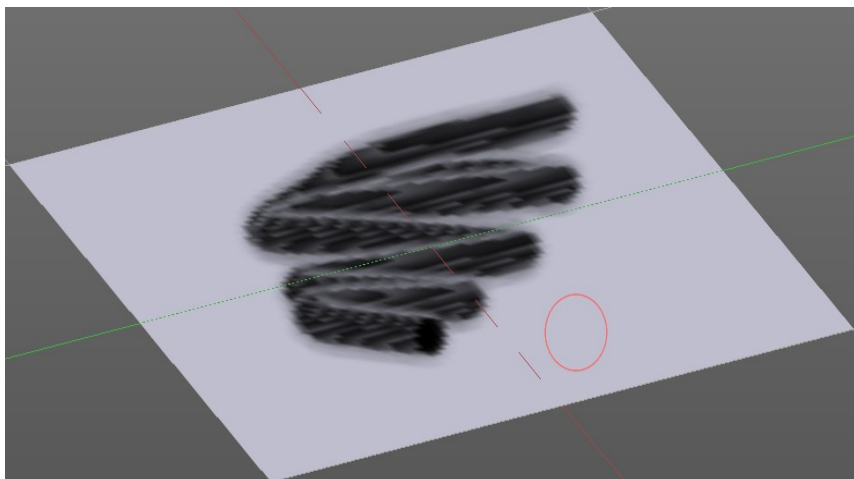

Spacing Edit Box

The sculpt drawing happens by mapping the pencil onto the mouse position. And when you move the mouse then the next mapping happens. Adjust the spacing after what mouse movement the next mapping should happen. The lower the value, the lower the distance between the single dots.

The icon behind the edit box enables tablet pressure sensitivity for tablets.

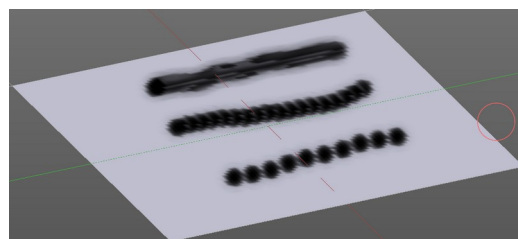

Dash Ratio

Ratio of samples in a cycle that the brush is covering.

Dash Length

Length of a dash cycle measured in stroke samples.

Jitter Edit Box

Add Jitter to the brush while painting.

Spacing Pressure

The icon behind the edit box enables tablet pressure sensitivity for tablets.

Jitter Unit

Jitter in screen space, or relative to the brush size.

Input Samples Edit Box

Average multiple input samples together to smooth the brush stroke.

Stabilize Stroke

The brush lags behind the mouse position, and produces a much smoother stroke by that. The Smooth Stroke related settings are hidden as long as Smooth Stroke is not activated.

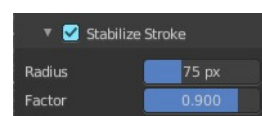

Smooth Stroke Radius Edit Box

Is just active when Smooth Stroke is activated. Adjust the radius of the smoothing.

Smooth Stroke Factor Edit Box

Is just active when Smooth Stroke is activated. Adjust the factor of the smoothing.

Stroke Panel with Stroke method Curve

The Stroke method curve doesn't simply influence the way how the stroke is painted. It is a special method. First you draw a curve object by holding down ctrl and clicking with left mouse button. Then you tweak the curve. You can click at the curve point, and drag out handlers to make the curve points smooth.

Then you hit the Draw Curve button. And the curve gets drawn onto the surface.

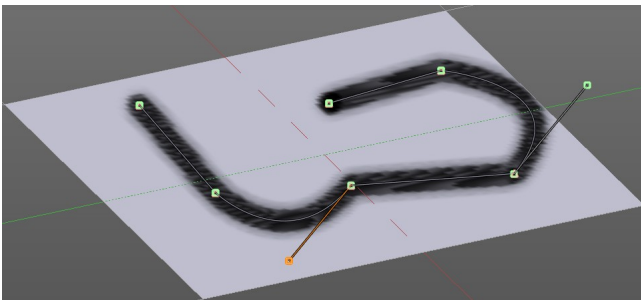
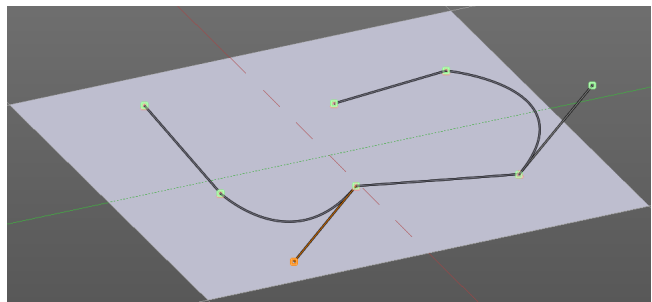
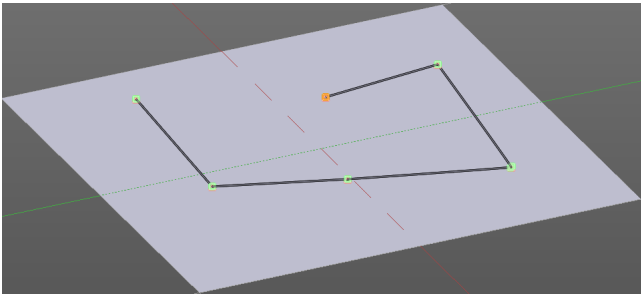
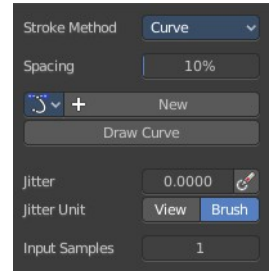

Spacing Edit Box

The drawing happens by mapping the pencil onto the mouse position. And when you move the mouse then the next mapping happens. Adjust the spacing after what mouse movement the next mapping should happen. The lower the value, the lower the distance between the single dots.

The icon behind the edit box enables tablet pressure sensitivity for

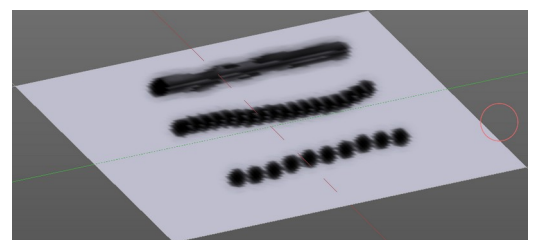

tablets.

Paint Curve edit box

Here you set the active curve.

The first element is a drop down box where you will find your curves objects. You can have more than one.

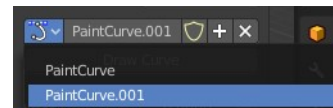

The second element is the edit box that displays the active curve.

The shield icon set the brush to have a fake user. Zero user data-blocks are normally not saved. But sometimes you want to force the data to be kept even when the data block has no user.

The + button allows you to add a new pencil with the current settings. Note that the brushes are NOT saved when you close Bforartists. You can save them into the current blend file. Or you can save the startup file. But be careful here. This saves everything else of the current state of Bforartists too.

The X button deletes the brush as the active one. It does NOT delete it from the brushes list.

Draw Curve Button

A click at it to turns the curve into a sculpt stroke.

Jitter Edit Box

Add Jitter to the brush while painting.

Jitter Pressure

The icon behind the edit box enables tablet pressure sensitivity for tablets.

Jitter Unit

Jitter in screen space, or relative to the brush size.

Input Samples Edit Box

Average multiple input samples together to smooth the brush stroke.

Stroke Panel with Stroke method Line

With Stroke method line you draw a line between a starting point and an endpoint. And when you release the mouse then the line gets sculpted.

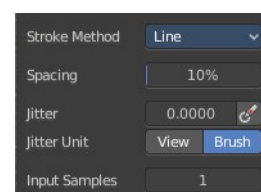

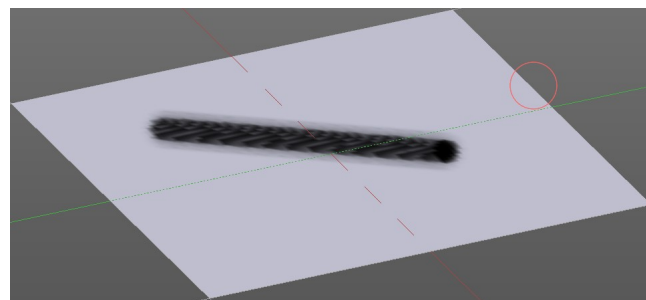
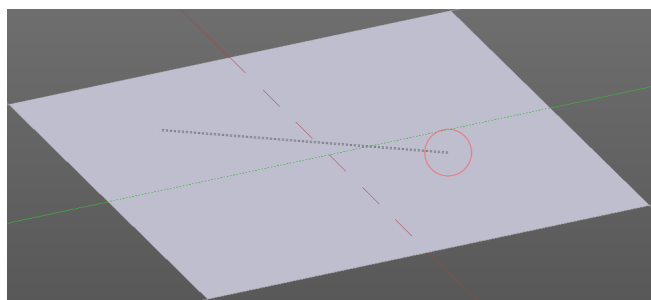

Spacing Edit Box

The sculpt drawing happens by mapping the pencil onto the mouse position. And when you move the mouse then the next mapping happens. Adjust the spacing after what mouse movement the next mapping should happen. The lower the value, the lower the distance between the single dots.

The icon behind the edit box enables tablet pressure sensitivity for tablets.

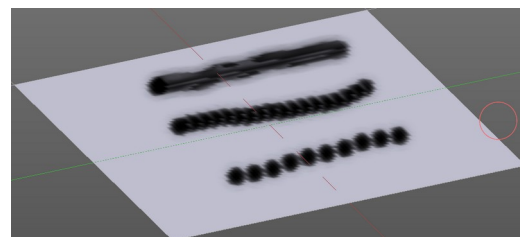

Jitter Edit Box

Add Jitter to the brush while painting.

Jitter Pressure

The icon behind the edit box enables tablet pressure sensitivity for tablets.

Jitter Unit

Jitter in screen space, or relative to the brush size.

Input Samples Edit Box

Average multiple input samples together to smooth the brush stroke.

Stroke Panel with Stroke method Airbrush

The stroke acts like an airbrush pencil. The dots gets placed randomly.

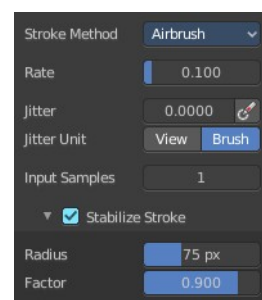
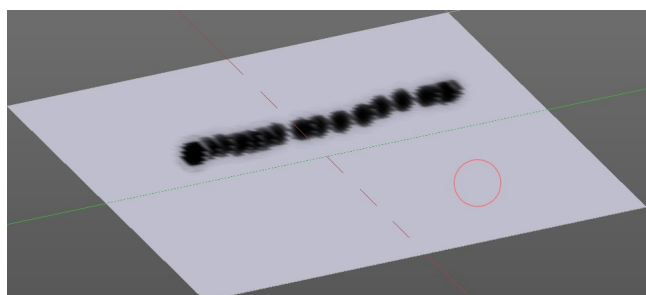

Rate Edit Box

Define the rate of the drawing.

Jitter Edit Box

Add Jitter to the brush while painting.

Jitter Pressure

The icon behind the edit box enables tablet pressure sensitivity for tablets.

Jitter Unit

Jitter in screen space, or relative to the brush size.

Input Samples Edit Box

Average multiple input samples together to smooth the brush stroke.

Stabilize Stroke

The brush lags behind the mouse position, and produces a much smoother stroke by that.

Smooth Stroke Radius Edit Box

Is just active when Smooth Stroke is activated. Adjust the radius of the smoothing.

Smooth Stroke Factor Edit Box

Is just active when Smooth Stroke is activated. Adjust the factor of the smoothing.

Stroke Panel with Stroke method Dots

The stroke method Dots draws dots of the pencil onto the surface. The mapping happens from the current view. Means you will get distortions when your view is not aligned with the surface of the object.

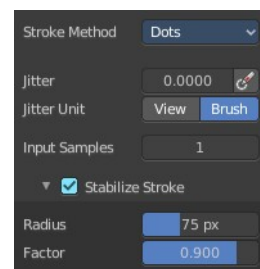
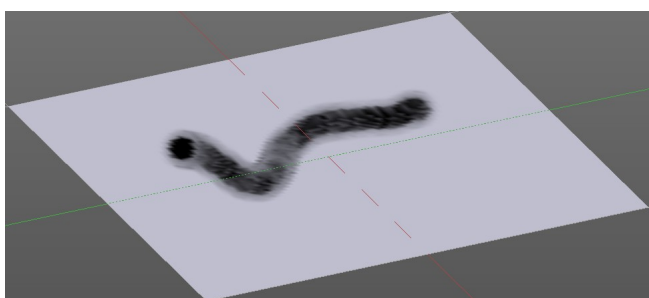

Jitter Edit Box

Add Jitter to the brush while painting.

Jitter Pressure

The icon behind the edit box enables tablet pressure sensitivity for tablets.

Jitter Unit

Jitter in screen space, or relative to the brush size.

Input Samples Edit Box

Average multiple input samples together to smooth the brush stroke.

Smooth Stroke

The brush lags behind the mouse position, and produces a much smoother stroke by that.

Smooth Stroke Radius Edit Box

Is just active when Smooth Stroke is activated. Adjust the radius of the smoothing.

Smooth Stroke Factor Edit Box

Is just active when Smooth Stroke is activated. Adjust the factor of the smoothing.

Brush Settings Panel - Falloff Sub panel

The curve panel allows you to define different falloffs methods for the border of the brush.

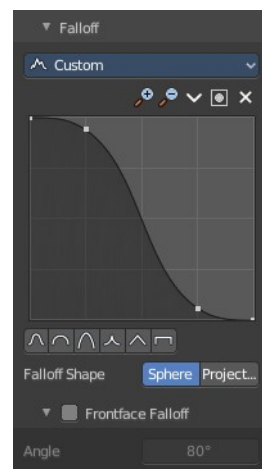

Selecting Points

You can select curve points. This reveals two edit boxes for the x and y

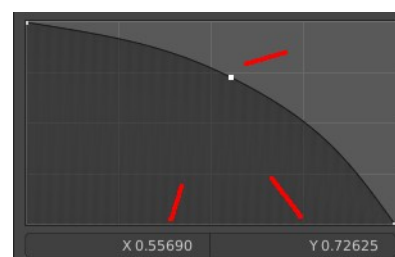

coordinate of this point.

Selected points can be moved around. Left click at them, hold the mouse button down and move them to a new location.

Adding Points

You can add new curve points by simply left clicking at the curve. Move the mouse to position them where you need it.

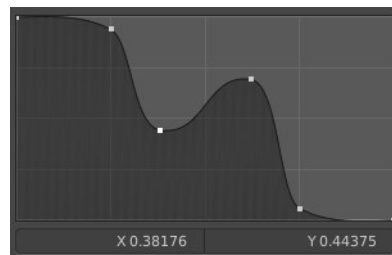

Navigation elements

The navigation elements at the top are described from left to right.



Zoom in and out

The two buttons with the magnifying glass at it zooms in and out in the curve window.

Tools

Tools is a menu where you can find some curve related tools.

Reset View

Resets the curve windows zoom.

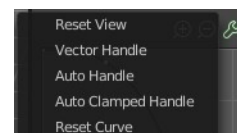

Vector Handle

Set handle type to Vector.

Auto Handle

Set handle type to Auto.

Auto Clamped Handle

Set handle type to Auto Clamped.

Reset Curve

Resets the curve to the initial shape.

Use Clipping

Clipping options. Set up clipping for the stroke.

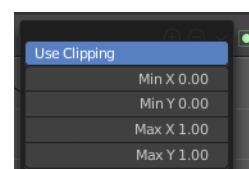

Delete Points

Deletes selected curve points.

Curve window

Tweak and adjust the falloff curve by clicking at a curve point and dragging it around.

Double click adds a new point.

Holding down ctrl activates temporary snapping.

Holding down shift enables slower movement, which allows more accurate setting.

Curve Presets

Predefined curve presets.



Falloff Shape

Use projected or spherical falloff.

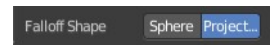

Front Face Falloff

Blend Brush influence, dependent by how much they face the front.

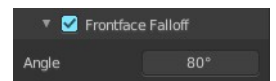

Angle

Adjust the angle.

Brush Settings Panel - Cursor Sub panel

Adjust the color and appearance of the brush cursor to custom values.

Cursor Checkbox

Activate the custom settings.

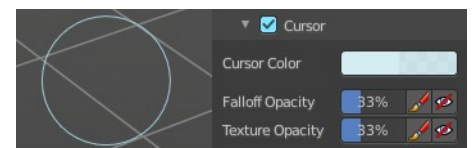

Cursor Color

Choose another color for the brush cursor. Double clicking at the color field will open a color picker.



Falloff Opacity

You can turn on the cursor overlay with the eye button at the end. The

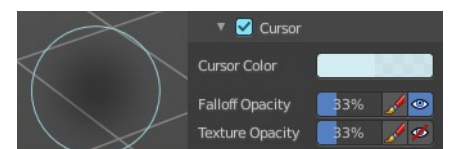

falloff opacity slider allows you to adjust the opacity of this cursor overlay.

Override Overlay

Hide the Cursor Overlay when painting.

Use Cursor Overlay

Turn on Cursor Overlay.

Texture Opacity

This is for the case when you paint with a texture brush. You can turn on the Texture overlay with the eye button at the end. The falloff opacity slider allows you to adjust the opacity of this cursor overlay.

Override Overlay

Hide the Texture Overlay when painting.

Use Cursor Overlay

Turn on Texture Overlay.

Symmetry Panel

Mirror

Mirror along given axis.

The same buttons plus the whole Symmetry Lock Panel as a drop down menu can also be found in the tool settings bar as icon buttons. This allows quicker access and better

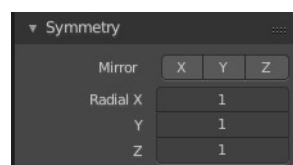

Radial

Tiling. The number of times to repeat the strokes across the surface.

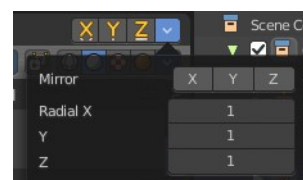



7.3.8 Editors - 3D Viewport - Sidebar - Tool Tab - Texture Paint Mode

Table of content

Detailed table of content.....	2
Tools Tab in Texture Paint Mode.....	7
Requirements.....	7
Save Texture.....	7
Texture Paint Mode - Texture Slots Panel.....	8
Mode.....	8
Add Texture Paint Slot.....	8
Paint Slot with mode Material.....	9
Paint Slot with Mode Single Image.....	9
Save all Images.....	10
Brushes Panel.....	10
Browse Brush.....	10
Custom Icon.....	10
Brush settings Panel.....	11
Brush Panel.....	11
Brush Settings Panel - Color Picker Sub panel.....	12
Brush colors flip.....	12
Use unified Color.....	12
Brush Settings Panel - Color Palette Sub panel.....	13
Palette browser.....	13
Edit Box.....	13
Number of users.....	13
Fake User.....	13
Add palette.....	13
Remove Palette.....	13
Sort By.....	13
Brush Settings Panel - Advanced Subpanel.....	14
Sharpen / Soften (Soften Brush).....	14
Blur Mode (Soften Brush).....	14
Mask Value (Mask brush).....	14
Brush Settings Panel - Texture Subpanel.....	14
Browse Texture to be linked.....	15
Brush Mapping.....	16
Brush Settings Panel - Texture Mask Subanel.....	19
Browse Texture to be linked.....	19
Brush Mapping with mapping method Tiled.....	21
Brush Mapping with mapping method View Plane.....	21
Brush Settings Panel - Stroke Sub panel.....	23
Stroke Panel with Stroke method Space.....	24
Stroke Panel with Stroke method Curve.....	25
Stroke Panel with Stroke method Line.....	26
Stroke Panel with Stroke method Anchored.....	27
Brush Settings Panel - Falloff Sub panel.....	30
Selecting Points.....	30
Adding Points.....	31

Navigation elements.....	31
Brush Settings Panel - Cursor Sub panel.....	32
Cursor Checkbox.....	32
Cursor Color.....	32
Falloff Opacity.....	32
Texture Opacity.....	33
Mask Texture Opacity.....	33
Brush Settings Panel - Clone from Paint Slot Sub panel.....	33
Masking Panel.....	34
Stencil Mask.....	34
Cavity Mask.....	35
Symmetry Panel.....	36
Symmetry Panel.....	36
Options Panel.....	36
Bleed.....	36
Dither.....	36
Occlude.....	36
Backface Culling.....	36
External.....	36

Detailed table of content

Detailed table of content

Detailed table of content.....	2
Tools Tab in Texture Paint Mode.....	7
Requirements.....	7
Save Texture.....	7
Texture Paint Mode - Texture Slots Panel.....	8
Mode.....	8
Add Texture Paint Slot.....	8
Paint Slot with mode Material.....	9
Material Paint Slot.....	9
Add Texture Paint Slot.....	9
Paint Slot with Mode Single Image.....	9
Image List.....	9
New/Open.....	9
Edit Box.....	9
Fake User.....	9
New Image.....	9
Open Image.....	9
Unlink Data Block.....	9
UV Map.....	9
Interpolation.....	10
Save all Images.....	10
Brushes Panel.....	10
Browse Brush.....	10
Custom Icon.....	10
Brush settings Panel.....	11
Brush Panel.....	11
Blend.....	11

Radius.....	11
Size Pressure.....	11
Use Unified Radius.....	12
Strength.....	12
Size Pressure.....	12
Use Unified Radius.....	12
Brush Settings Panel - Color Picker Sub panel.....	12
Brush colors flip.....	12
Use unified Color.....	12
Brush Settings Panel - Color Palette Sub panel.....	13
Palette browser.....	13
Edit Box.....	13
Number of users.....	13
Fake User.....	13
Add palette.....	13
Remove Palette.....	13
Sort By.....	13
Brush Settings Panel - Advanced Subpanel.....	14
Accumulate.....	14
Affect Alpha.....	14
Sharpen / Soften (Soften Brush).....	14
Sharp Threshold.....	14
Blur Mode (Soften Brush).....	14
Mask Value (Mask brush).....	14
Brush Settings Panel - Texture Subpanel.....	14
Browse Texture to be linked.....	15
Texture Edit box.....	16
Brush Mapping.....	16
Brush Mapping with mapping method Tiled.....	16
Angle.....	16
Offset.....	16
Size.....	16
Brush Mapping with mapping method View Plane.....	17
Angle.....	17
Rake.....	17
Random.....	17
Offset.....	17
Size.....	17
Brush Mapping with mapping method 3D.....	17
Offset.....	17
Size.....	17
Brush Mapping with mapping method Random.....	18
Angle.....	18
Rake.....	18
Random.....	18
Brush Mapping with mapping method Stencil.....	18
Image Aspect.....	18
Reset Transform.....	19
Angle edit box.....	19
Offset.....	19
Size.....	19
Brush Settings Panel - Texture Mask Subanel.....	19
Browse Texture to be linked.....	20

Brush Mapping with mapping method Tiled.....	21
Mask Pressure Mode.....	21
Angle.....	21
Offset.....	21
Size.....	21
Brush Mapping with mapping method View Plane.....	21
Mask Pressure Modem.....	21
Angle.....	21
Rake.....	21
Random.....	22
Offset.....	22
Size.....	22
Brush Mapping with mapping method Random.....	22
Mask Pressure Mode.....	22
Angle.....	22
Rake.....	22
Random.....	22
Offset.....	22
Size.....	22
Brush Mapping with mapping method Stencil.....	22
Mask Pressure Mode.....	23
Angle edit box.....	23
Offset.....	23
Size.....	23
Brush Settings Panel - Stroke Sub panel.....	23
Stroke Panel with Stroke method Space.....	24
Spacing Edit Box.....	24
Spacing Pressure.....	24
Adjust Strength for Spacing.....	24
Dash Ratio.....	24
Dash Length.....	24
Jitter Edit Box.....	24
Spacing Pressure.....	24
Jitter Unit.....	24
Input Samples Edit Box.....	25
Stabilize Stroke.....	25
Smooth Stroke Radius Edit Box.....	25
Smooth Stroke Factor Edit Box.....	25
Stroke Panel with Stroke method Curve.....	25
Spacing Edit Box.....	25
Adjust Strength for Spacing.....	26
Paint Curve edit box.....	26
Draw Curve Button.....	26
Jitter Edit Box.....	26
Jitter Pressure.....	26
Jitter Unit.....	26
Input Samples Edit Box.....	26
Stroke Panel with Stroke method Line.....	27
Spacing Edit Box.....	27
Adjust Strength for Spacing.....	27
Jitter Edit Box.....	27
Jitter Pressure.....	27
Jitter Unit.....	27

Input Samples Edit Box.....	27
Stroke Panel with Stroke method Anchored.....	28
Edge to edge.....	28
Jitter Edit Box.....	28
Jitter Pressure.....	28
Jitter Unit.....	28
Input Sample Edit Box.....	28
Stroke Panel with Stroke method Airbrush.....	28
Rate Edit Box.....	28
Jitter Edit Box.....	28
Jitter Pressure.....	28
Jitter Unit.....	29
Input Samples Edit Box.....	29
Stabilize Stroke.....	29
Smooth Stroke Radius Edit Box.....	29
Smooth Stroke Factor Edit Box.....	29
Stroke Panel with Stroke method Drag Dot.....	29
Jitter Edit Box.....	29
Jitter Pressure.....	29
Jitter Unit.....	29
Input Samples Edit Box.....	29
Stroke Panel with Stroke method Dots.....	29
Jitter Edit Box.....	29
Jitter Pressure.....	30
Jitter Unit.....	30
Input Samples Edit Box.....	30
Stabilize Stroke.....	30
Smooth Stroke Radius Edit Box.....	30
Smooth Stroke Factor Edit Box.....	30
Brush Settings Panel - Falloff Sub panel.....	30
Selecting Points.....	30
Adding Points.....	31
Navigation elements.....	31
Zoom in and out.....	31
Tools.....	31
Reset View.....	31
Vector Handle.....	31
Auto Handle.....	31
Auto Clamped Handle.....	31
Reset Curve.....	31
Use Clipping.....	31
Delete Points.....	31
Curve window.....	32
Curve Presets.....	32
Falloff Shape.....	32
Normal Falloff.....	32
Angle.....	32
Brush Settings Panel - Cursor Sub panel.....	32
Cursor Checkbox.....	32
Cursor Color.....	32
Falloff Opacity.....	32
Override Overlay.....	33
Use Cursor Overlay.....	33

Texture Opacity.....	33
Override Overlay.....	33
Use Cursor Overlay.....	33
Mask Texture Opacity.....	33
Override Overlay.....	33
Use Cursor Overlay.....	33
Brush Settings Panel - Clone from Paint Slot Sub panel.....	33
Masking Panel.....	34
Stencil Mask.....	34
Activate Stencil map.....	34
Stencil Image.....	34
Texture browser.....	34
Edit Box.....	34
UV Layer.....	34
Display Color.....	34
Cavity Mask.....	35
Activate Cavity mask.....	35
Navigation elements.....	35
Zoom in and out.....	35
Zoom in and out.....	35
Tools.....	35
Reset View.....	35
Vector Handle.....	35
Auto Handle.....	35
Auto Clamped Handle.....	35
Reset Curve.....	35
Use Clipping.....	35
Delete Points.....	35
Symmetry Panel.....	36
Symmetry Panel.....	36
Options Panel.....	36
Bleed.....	36
Dither.....	36
Occlude.....	36
Backface Culling.....	36
External.....	36
Screen Grab Size.....	37
Quick Edit.....	37
Apply.....	37
Apply Camera Image.....	37
Workflow for external editing.....	37
Preparations.....	37
Usage.....	37

Tools Tab in Texture Paint Mode

The Texture Paint Mode provides you the tools to paint directly at the texture of your mesh in the viewport. To fix visible seams for example.

The Texture Paint mode is just available for mesh objects.

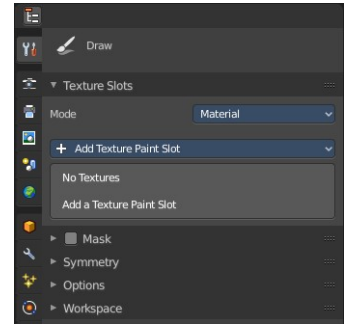

Requirements

Texture Painting requires to have a working UV mapping and a texture applied. When there is no UV mapping and no assigned texture, then you will get a warning about No Texture. You have to create a texture slot first.

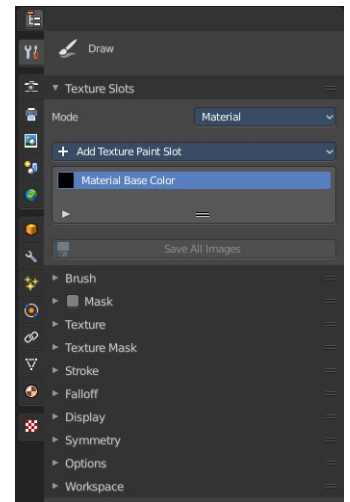
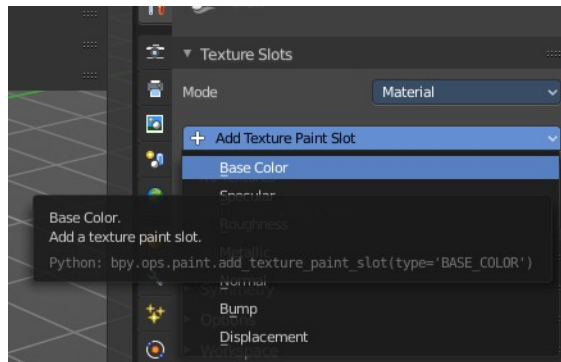

Open the Texture Paint Slot drop down menu, and choose Base Color. This will call a menu. Create a new blank texture.

Save Texture

The result of texture painting can be found and be saved in the UV Image Editor. You can also paint in the UV editor.

The modified texture does NOT save with the scene. You have to save out the image when you want to save the changes at the texture. There is no warning. So **DON'T FORGET TO SAVE THE TEXTURE.**

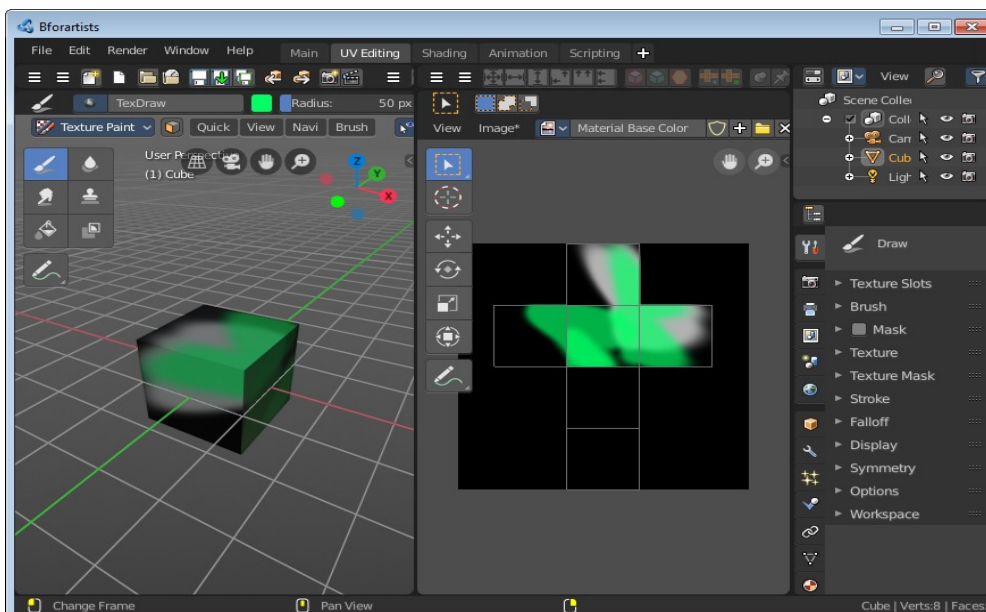

Texture Paint Mode - Texture Slots Panel

The texture slots panel allows you to manage the textures that you use for texture painting. When the mesh doesn't have a texture yet to paint at, then you get a hint about a missing texture. No Textures. The Add Texture Paint Slot button allows you to add one. Base Color allows you to create a diffuse map.

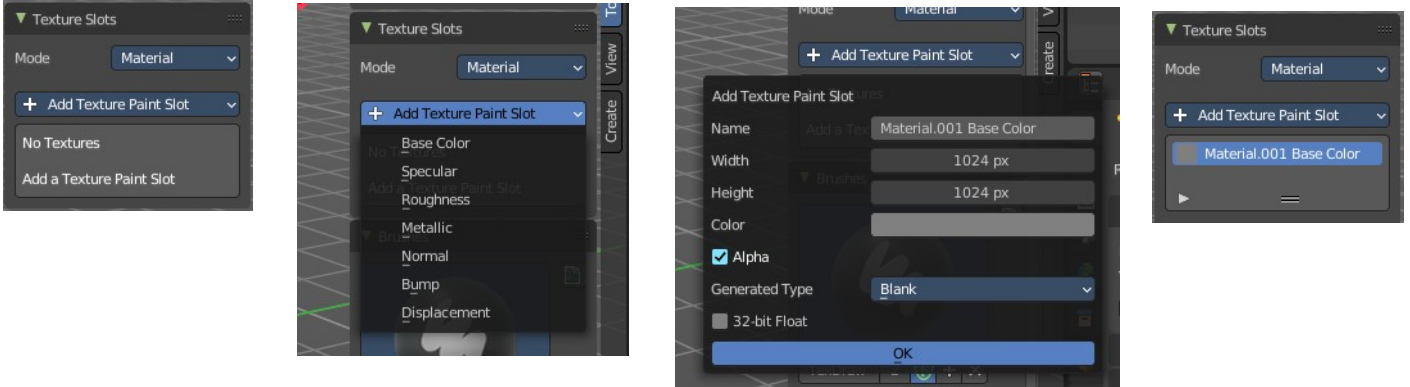

Mode

Choose in which mode you want to paint. Single Image just works with a single image, without any material.

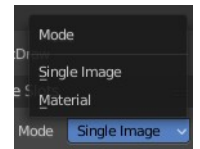

Material works with a material and a texture. The texture is here part of the material.

Add Texture Paint Slot

Here you can choose what type of texture you want to add for texture painting.

The texture gets added to the shader, and connected to the correct node. A base color is meant for diffuse, and so it connects with the base color slot.

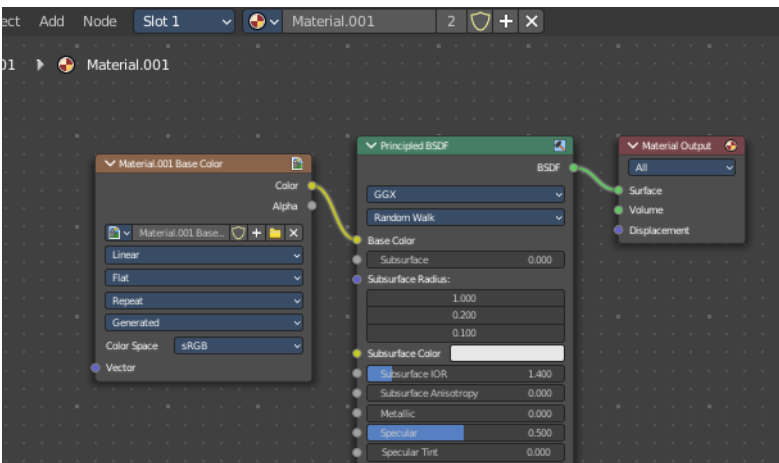
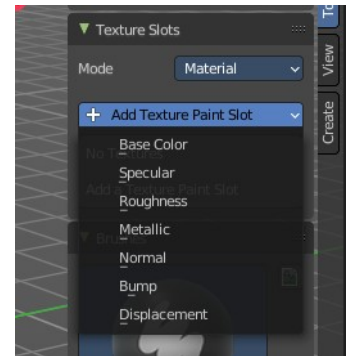

Paint Slot with mode Material

Material Paint Slot

A list of the available paint slot materials.

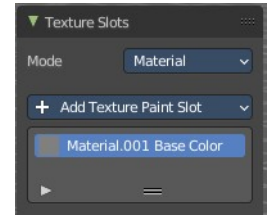

Add Texture Paint Slot

The + button at the right. Add more materials to the Material Paint Slot.

Paint Slot with Mode Single Image

Image List

A list of the available images, which allows you choose one in case one exists.

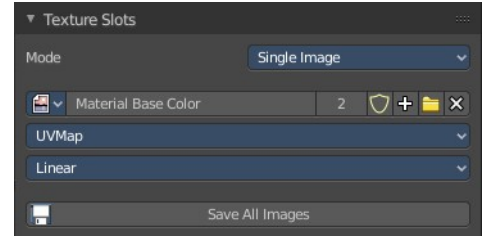

New/Open

When no image is loaded then you can create a new image here, or load a new image.



Edit Box

See the name of the image, and edit the name.

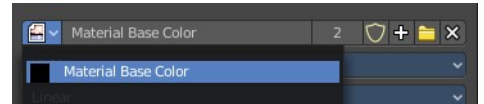

Fake User

When enabled then this image will be stored internally. But not the painted changes at it!!

New Image

Create a new image.

Open Image

Open an image

Unlink Data Block

Delete the Image when saving the scene, closing and reopening Bforartists. Note that the number of Users must be zero. Or the image comes back.

UV Map

Choose a UV map to work with. Usually there is just one. But there can be more than one UV map. You can add and manage more in the Object data tab in the UV Map panel.

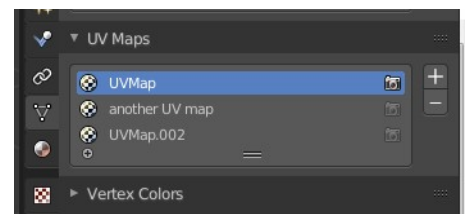
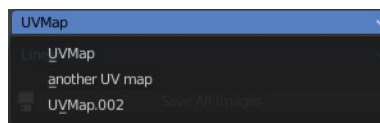

Interpolation

Set the interpolation type. Linear or Closest.

Save all Images

Saves all images. Internal images needs to be saved manually first. They don't have a path yet to which they could be saved. You will get an invalid path warning.



Brushes Panel

The Brush Panel contains the different Brushes and some Brush settings. Choose and adjust your current active brush.

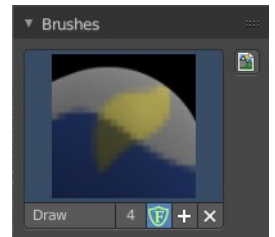

Browse Brush

The big image at the top is a drop down box where you can see the current active brush. You can add duplicates of this active brush, and customize it to your needs. But the active brush gets chosen in the Tool Shelf at the left of the 3D View.

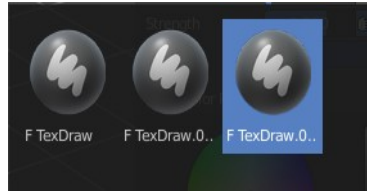
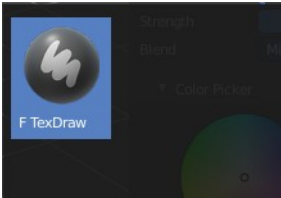

When you have added a few more brushes then the drop down box may be more than full. You will see some little white arrows then. Either in the top left or in the bottom right corner. They indicate that some

brushes are hidden before or after the current display.

To scroll to this hidden content use the mouse wheel, or the arrow up and down buttons at the keyboard.

Custom Icon

The button at the right allows you to load a custom icon for your brush. It reveals a file browser below the image browser.

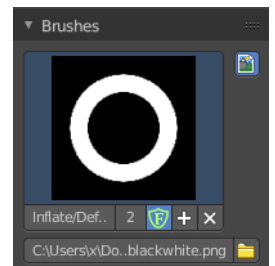

The edit box below the Image shows you the name of the current active brush.



The number right of it, **in this case 2**, indicates how much number of users (internally) this brush uses. This means that this data block (the brush) shares currently settings with at least one other object. Most probably the

parent brush where we have created it from. Click at the value to make this brush a single user. The button will vanish then.

The shield icon set the brush to have a fake user. Zero user data-blocks are normally not saved. But sometimes you want to force the data to be kept even when the data block has no user.

The + button allows you to add a new pencil with the current settings. Note that the brushes are NOT saved when you close Bforartists. You can save them into the current blend file. Or you can save the startup file. But be careful here. This saves everything else of the current state of Bforartists too.

The X button deletes the brush as the active one. It does NOT delete it from the brushes list.

Brush settings Panel

Brush Panel

The Brush Panel contains the different paint brushes, a color dialog, and some brush settings.

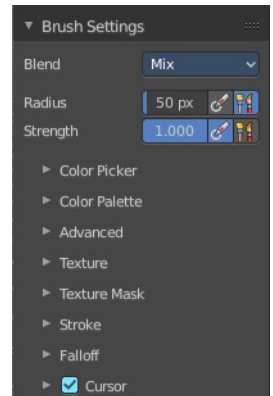

Blend

Define how the stroke will blend. You can choose between various blend modes.

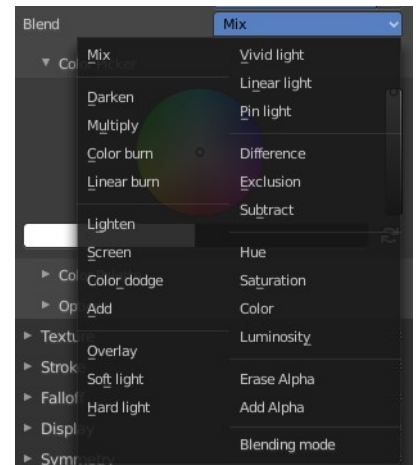

Radius

The Radius edit box allows you to adjust the radius of the brush. The button behind the edit box enables tablet pressure sensitivity for radius.

Size Pressure

The first button behind the edit box enables tablet pressure sensitivity for radius.

Use Unified Radius

The second button behind the edit box enables global radius size. Any modification at the radius will also modify the radius value for other paint tools.

Strength

The Strength edit box allows you to adjust the strength of the brush. The button behind the edit box enables tablet pressure sensitivity for strength.

Size Pressure

The first button behind the edit box enables tablet pressure sensitivity for radius.

Use Unified Radius

The second button behind the edit box enables global radius size. Any modification at the radius will also modify the radius value for other paint tools.

Brush Settings Panel - Color Picker Sub panel

Define the color for your brush.

The active color is the left one. When you click the button with the two arrows down right then you can swap the color with the secondary color. Then this secondary color becomes the primary color, and is active.



A click at one of the color fields will open a more detailed color dialog, where you can set up the color by using rgb, hsv and hex colors and with value sliders.

Brush colors flip

Flips the primary color with the secondary color.

Use unified Color

Choose if you want to use global colors or local color just for vertex painting.



Brush Settings Panel - Color Palette Sub panel

Create a color palette for later reuse.

First create a new palette by clicking at New. Then adjust the color in the color picker. And then click at the add button to add this color to the palette.

To set the color picker to a palette color simply click at this palette color.

To remove a color from the palette, choose it, then click at the remove button. The active palette color that gets removed is the one with the triangle at it.

The color palette cannot be saved externally. It is part of the current blend file. You can however append color palettes from other blend files.

The elements are explained from left to right.

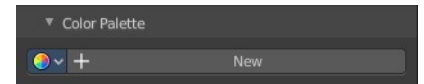

Palette browser

The button at the left opens a dropdown list where you can choose between your palettes.

Edit Box

The name of the currently active palette. You can also rename the palette here. A click into the edit box makes the name editable.

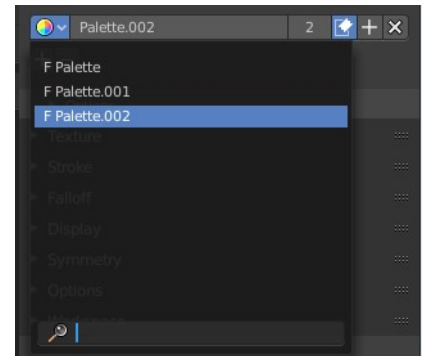

Number of users

See how many users the palette currently has.

Fake User

Fake User sets the element to have a fake user. Zero user data-blocks are normally not saved. But sometimes you want to force the data to be kept even when the data block has no user.

Add palette

Add a new palette.

Remove Palette

Clicking at this button removes the palette. Note that you need to save, close Bforartists and reload the blend file to remove the palette completely.

Sort By

Sort the palette by the chosen method.

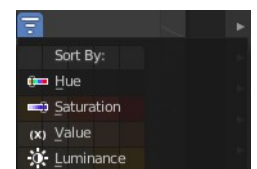

Brush Settings Panel - Advanced Subpanel

Brush specific settings.

Accumulate

Accumulate stroke daubts on top of each other.

Affect Alpha

When disabled then the alpha is locked while painting.

Sharpen / Soften (Soften Brush)

Sharp Threshold

The threshold below which no sharpening is performed.

Blur Mode (Soften Brush)

Choose the blur method. Gaussian or Box.

Mask Value (Mask brush)

The vertex weight when brush is applied.

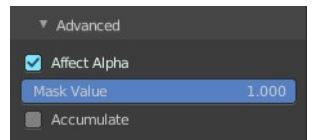
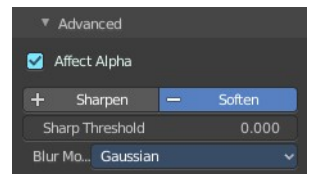
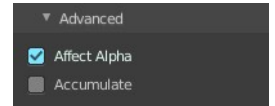

Brush Settings Panel - Texture Subpanel

The Texture panel allows you to paint with textures. This allows you for example to grab a foto from some fish scales, and simply paint them onto the vertices by using this image as a pencil. Or as a blueprint where you calk through (Stencil method).

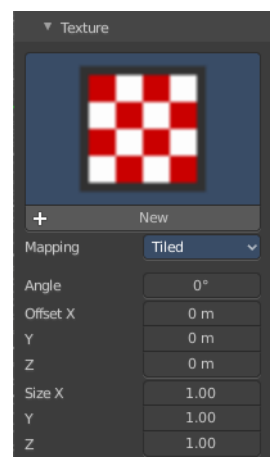

Browse Texture to be linked

The image at the top of the panel is a image browser. Choose a texture that you can choose for vertex painting then. You can also have more than one image loaded at once.

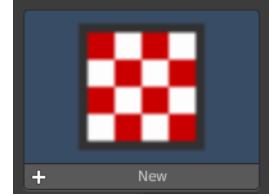

In this shot there is already a texture added. The way to add the texture here is a bit more complicated. And not done with clicking at the New button.

First click at the New button below the image. This will create a new texture slot. This slot is still empty, it displays black.

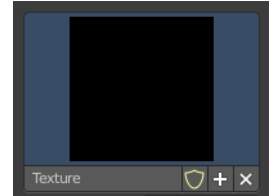

We need to load the texture in this slot. This must be done in the Properties editor in the Textures tab. And then the texture finally shows in the Texture panel in the Tool Shelf.

The problem is, we have an object with a material and a texture already selected. And when we change this texture , then we don't get the pencil texture loaded. But we change the texture at our mesh.

What we need to do is to create a material first. And in this material we load our pencil texture then. And then this texture becomes available in the image browser of the Texture panel.

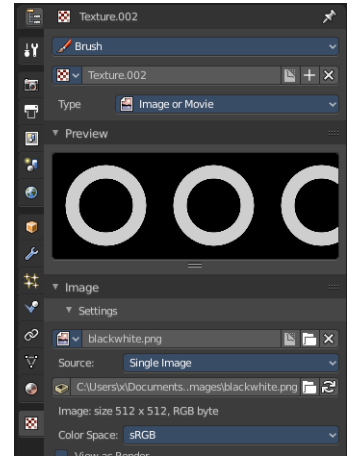
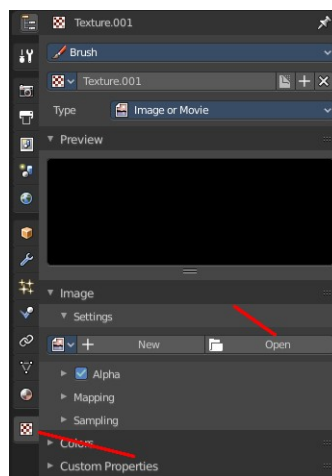
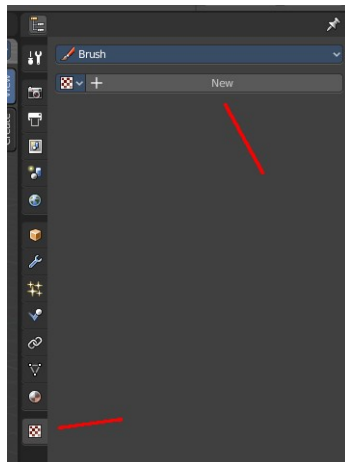
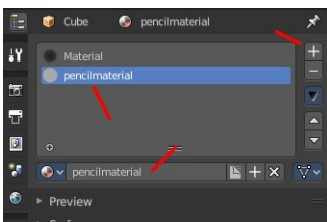

And when we switch back to the tools tab, then the texture is loaded. And we can work with this texture.

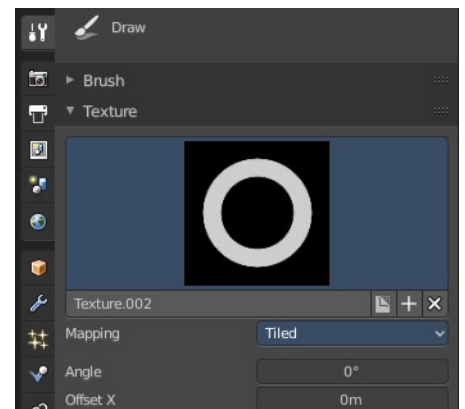

Texture Edit box



The Texture edit box is the edit box below the Image browser.

When there's no image loaded then it displays the New button. When there's a image (or more) loaded, then you will see the name of the current texture.

The F button turns this texture into a data block with a fake user. Means it will exists even when there is no data connected to it anymore.

When you activate Fake User, then you may get a value in front of it, which displays how much users this data block (our texture slot) currently has.

The + Button adds another texture slot. Note that you will have to load a texture too, as explained above.

The X button deletes the texture slot.

Brush Mapping

Our texture can be mapped in different methods. The Brush mapping is a dropdown box where you can choose this different brush mapping methods.

The settings vary. So we will go through them by the different brush mapping methods.

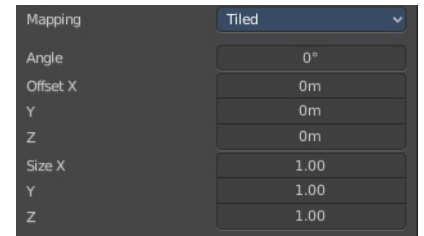

Brush Mapping with mapping method Tiled

The brush mapping method Tiled tiles the brush stroke at the surface. The mapping happens from the current view. The result may be distorted when the view does not align with the surface of the object.

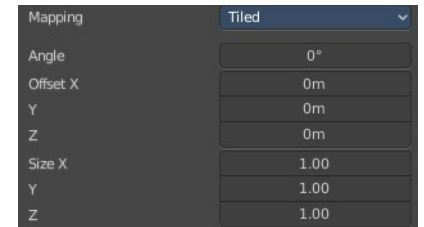

Angle

The angle of the brush.

Offset

The offset of the texture in the brush.

Size

The size of the texture in the brush.

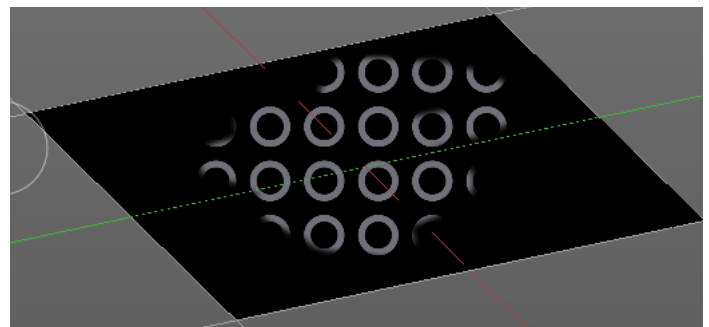

Brush Mapping with mapping method View Plane

The brush mapping method View Plane simply paints onto the surface. The mapping happens from the current view. The result may be distorted when the view does not align with the surface of the object.

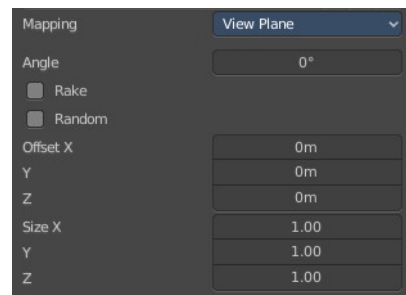

Angle

The angle of the brush.

Rake

The angle follows the direction of the brush stroke.

Random

The brush angle gets set random.

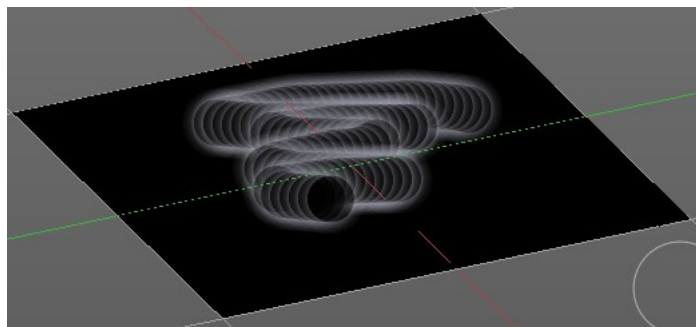

Offset

The offset of the texture in the brush.

Size

The size of the texture in the brush.

Brush Mapping with mapping method 3D

The brush mapping method 3D paints the texture at the surface, by tiling it 1/1 at the object surface.

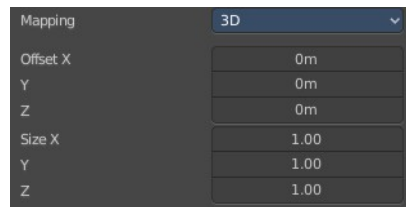

Offset

The offset of the texture in the brush.

Size

The size of the texture in the brush.

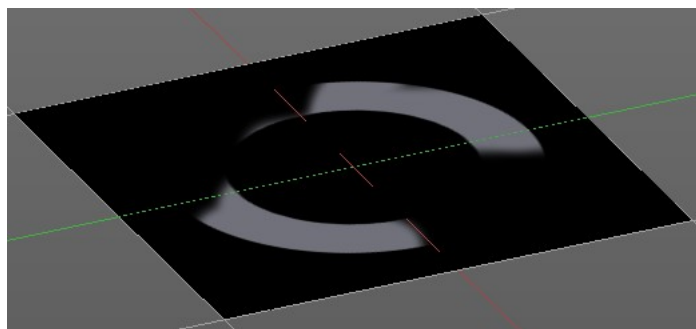

Brush Mapping with mapping method Random

The brush mapping method Random paints onto the surface, and randomizes the texture position in the brush while that. The mapping happens from the current view. The result may be distorted when the view does not align with the surface of the object.

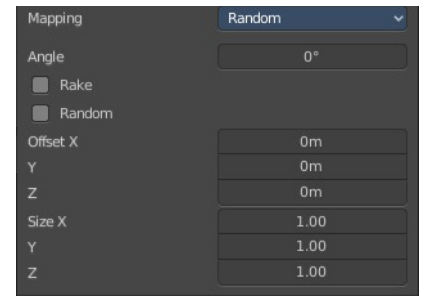

Angle

The angle of the brush.

Rake

The angle follows the direction of the brush stroke.

Random

The brush angle gets set random.

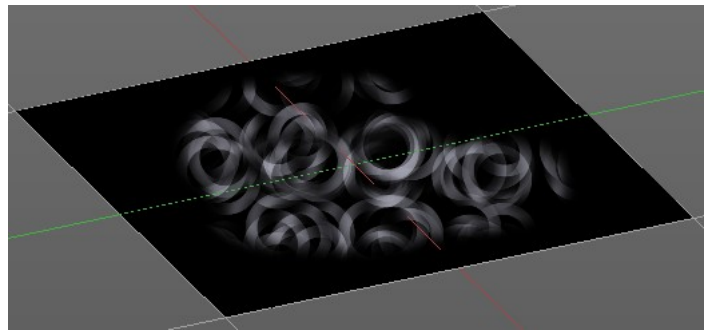

Brush Mapping with mapping method Stencil

The former methods uses the textures for the brush. The method Stencil works different. You have your texture displayed in the workspace above the object, and you paint this texture onto your object with your pencil strokes.

Note that the texture in the 3d space is just visible when you are with the mouse over the viewport.

It gets by default displayed down left. You have to position it where you need it. See Brush menu, Stencil Texture controls.

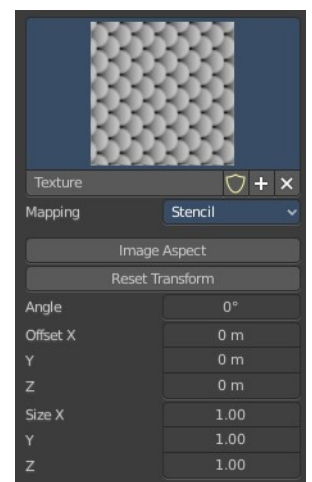
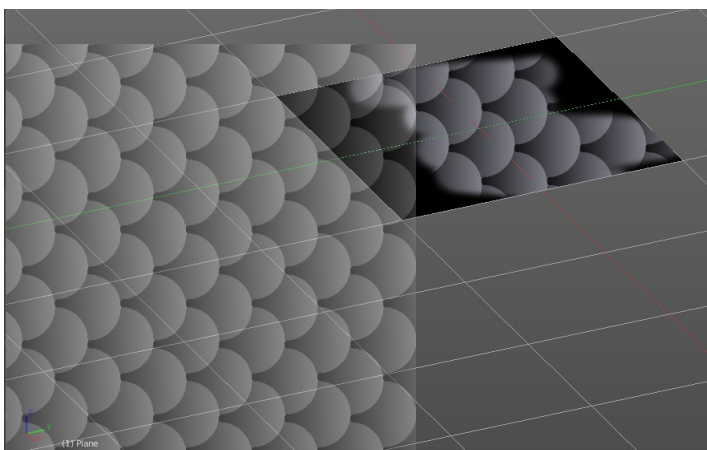
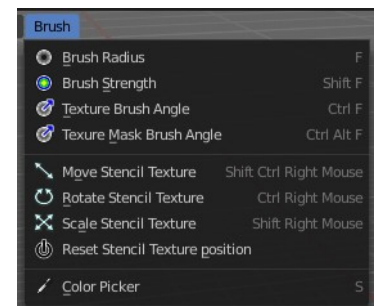

Image Aspect

Adjust the stencil size to fit to the image aspect ratio.

Reset Transform

Resets the stencil image to be down right in the 3D view.

Angle edit box

Adjust the angle of the brush. The button at the end allows you to set the radius by dragging the mouse. This should be done in the viewport and with the hotkey. This button is just a visible reminder.

Offset

Fine tune the offset of the texture in the brush.

Size

Fine tune the size of the texture in the brush.

Brush Settings Panel - Texture Mask Subanel

The texture mask subpanel allows you to use a texture as a mask to define the strength of painting. In the shot example we use a tiled fishscale Texture as a pencil, and a stencil map as our texture mask. And it paints just where the mask texture is bright. You can of course use gradients here to define the paint strength.

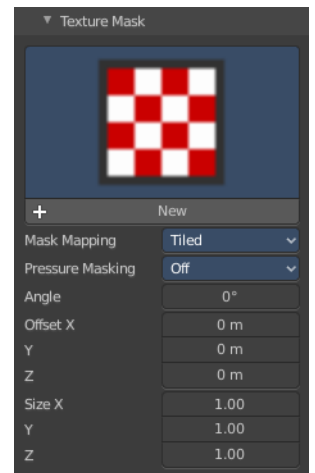
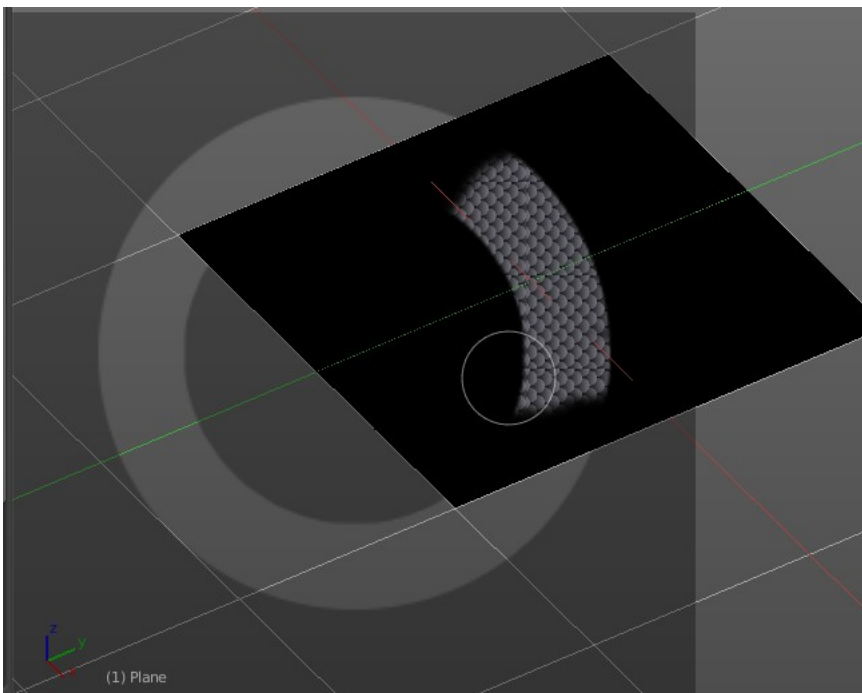

Browse Texture to be linked

The image at the top of the panel is a image browser. Choose a texture that you

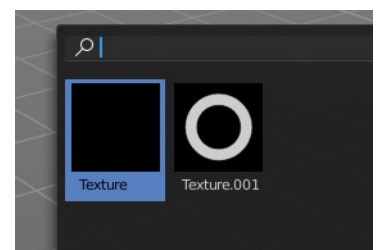

can choose for painting then. You can also have more than one image loaded at once.

In this shot there is already two textures added. The way to add the texture here is a bit more complicated. And not done with clicking at the New button.

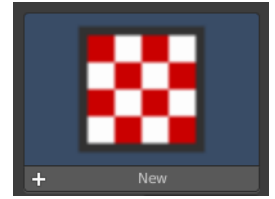

First click at the New button below the image. This will create a new texture slot. This slot is still empty, it displays black.

We need to load a texture in this slot. This must be done in the Properties editor in the Textures tab.

The problem is, we have an object with a material and a texture already selected. And when we change this texture, then we don't get the pencil texture loaded. But we change the texture at our mesh.

What we need to do is to create a material first. And in this material we load our pencil texture then. And then we can choose this texture in the image browser of the texture.

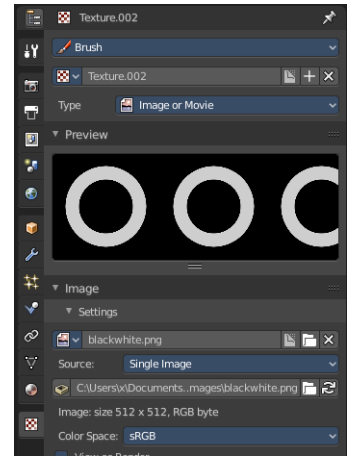
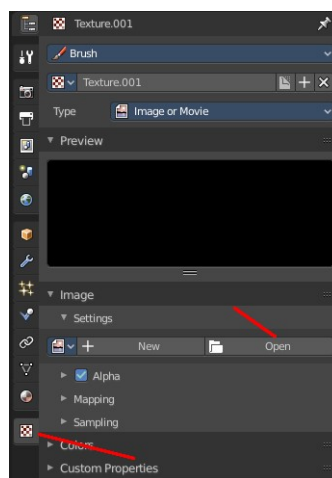
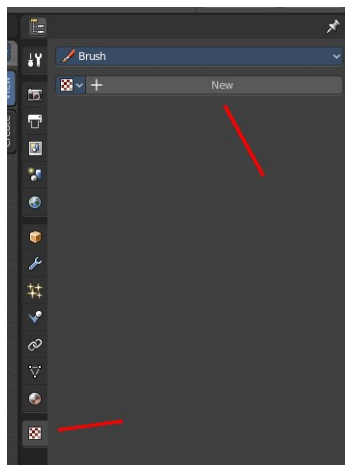
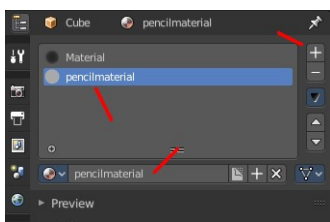

And when we switch back to the tools tab, then the texture is loaded. And we can work with this texture.

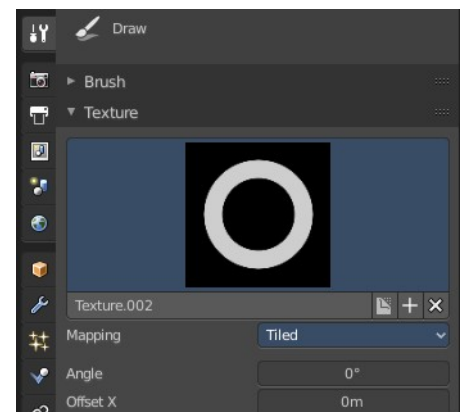

Brush Mapping with mapping method Tiled

The brush mapping method Tiled tiles the brush stroke at the surface. The mapping happens from the current view. The result may be distorted when the view does not align with the surface of the object.

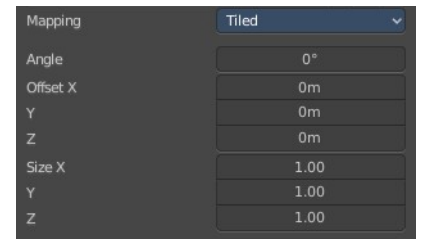

Mask Pressure Mode

A dropdown box to choose the mask pressure mode for tablets.

Angle

The angle of the brush.

Offset

The offset of the texture in the brush.

Size

The size of the texture in the brush.

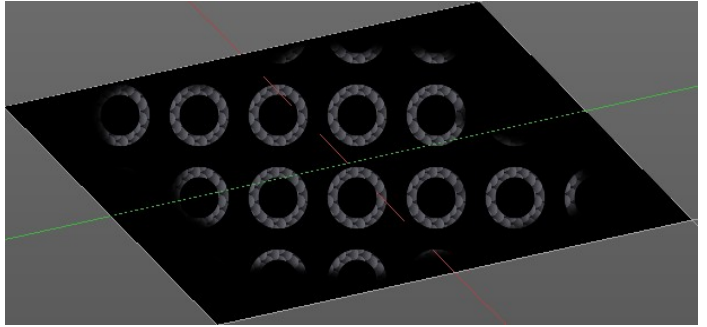

Brush Mapping with mapping method View Plane

The brush mapping method View Plane simply paints onto the surface. The mapping happens from the current view. The result may be distorted when the view does not align with the surface of the object.



Mask Pressure Modem

A dropdown box to choose the mask pressure mode for tablets.

Angle

The angle of the brush.

Rake

The angle follows the direction of the brush stroke.

Random

The brush angle gets set random.

Offset

The offset of the texture in the brush.

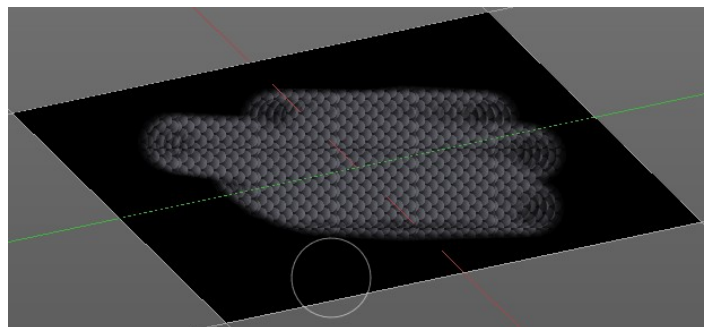

Size

The size of the texture in the brush.

Brush Mapping with mapping method Random

The brush mapping method Random paints onto the surface, and randomizes the texture position in the brush while that. The mapping happens from the current view. The result may be distorted when the view does not align with the surface of the object.



Mask Pressure Mode

A dropdown box to choose the mask pressure mode for tablets.

Angle

The angle of the brush.

Rake

The angle follows the direction of the brush stroke.

Random

The brush angle gets set random.

Offset

The offset of the texture in the brush.

Size

The size of the texture in the brush.

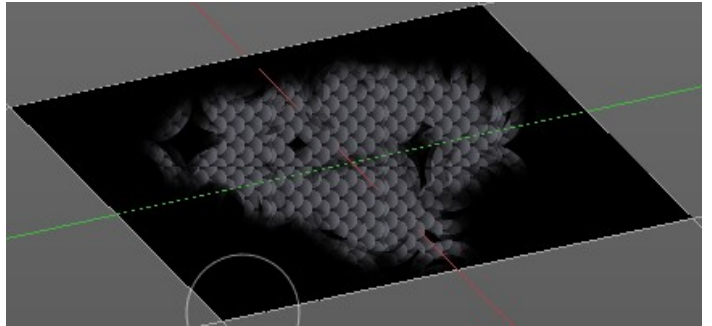

Brush Mapping with mapping method Stencil

The former methods uses the textures for the brush. The method Stencil works different. You have your texture displayed in the workspace above the object, and you paint this texture onto your object with your pencil strokes.

Note that the texture in the 3d space is just visible when you are with the mouse over the viewport. Note that the texture in the 3d space is just visible when you are with the mouse over the viewport. It gets by default displayed down left. You have to position it where you need it. See Brush menu, Stencil Texture controls.

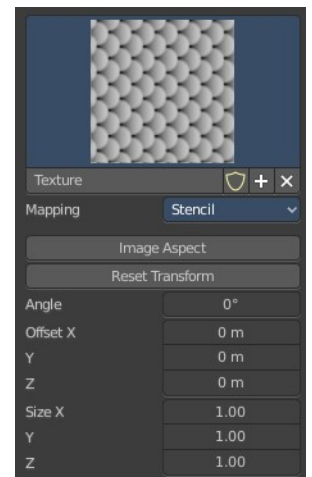

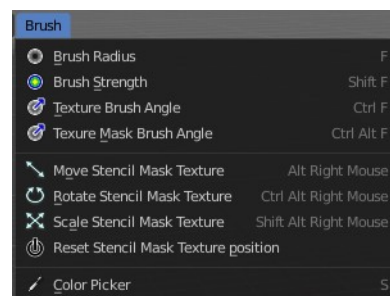
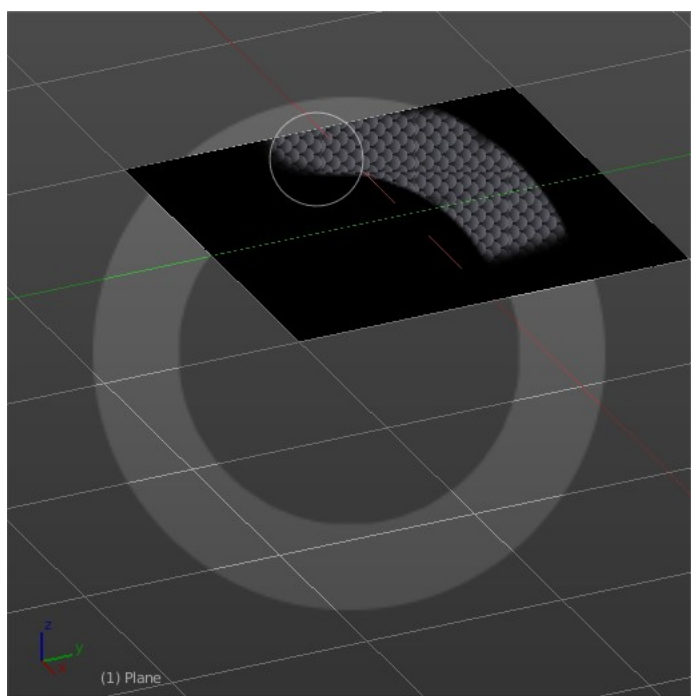

Mask Pressure Mode

A drop down box to choose the mask pressure mode for tablets.

Angle edit box

Adjust the angle of the brush. The button at the end allows you to set the radius by dragging the mouse. This should be done in the viewport and with the hotkey. This button is just a visible reminder.

Offset

Fine tune the offset of the texture in the brush.

Size

Fine tune the size of the texture in the brush.

Brush Settings Panel - Stroke Sub panel

The Stroke panel contains settings to influence the behavior of the brush stroke. There are various stroke methods available. We will go through them one by one.

Stroke Panel with Stroke method Space

This is the default Stroke method. The sculpt stroke gets added continuously with given settings.

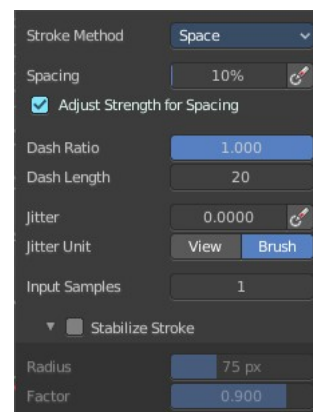
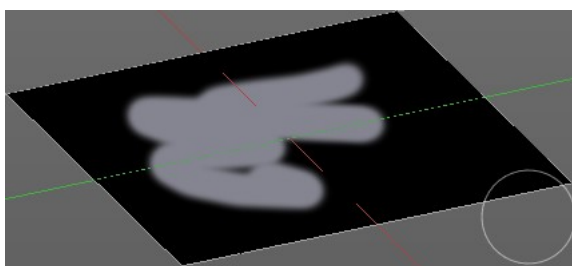

Spacing Edit Box

The sculpt drawing happens by mapping the pencil onto the mouse position. And when you move the mouse then the next mapping happens. Adjust the spacing after what mouse movement the next mapping should happen. The lower the value, the lower the distance between the single dots.

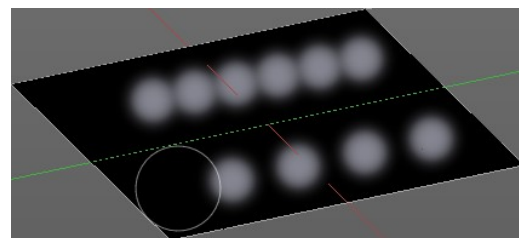

Spacing Pressure

The icon behind the edit box enables tablet pressure sensitivity for tablets.

Adjust Strength for Spacing

Automatically adjust strength to give consistent results for different spacing.

Dash Ratio

Ratio of samples in a cycle that the brush is covering.

Dash Length

Length of a dash cycle measured in stroke samples.

Jitter Edit Box

Add Jitter to the brush while painting.

Spacing Pressure

The icon behind the edit box enables tablet pressure sensitivity for tablets.

Jitter Unit

Jitter in screen space, or relative to the brush size.

Input Samples Edit Box

Average multiple input samples together to smooth the brush stroke.

Stabilize Stroke

The brush lags behind the mouse position, and produces a much smoother stroke by that.

Smooth Stroke Radius Edit Box

Is just active when Smooth Stroke is activated. Adjust the radius of the smoothing.

Smooth Stroke Factor Edit Box

Is just active when Smooth Stroke is activated. Adjust the factor of the smoothing.

Stroke Panel with Stroke method Curve

The Stroke method curve doesn't simply influence the way how the stroke is painted. It is a special method. First you draw a curve object by holding down ctrl and clicking with left mouse button. Then you tweak the curve. You can click at the curve point, and drag out handlers to make the curve points smooth.

Then you hit the Draw Curve button. And the curve gets drawn onto the surface.

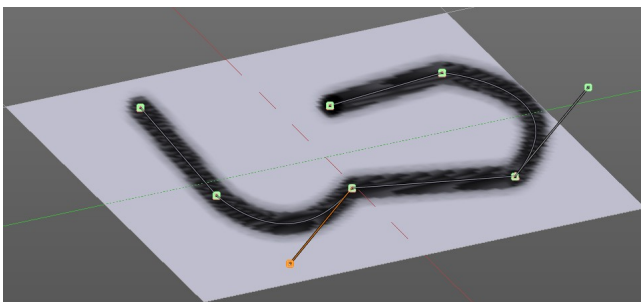
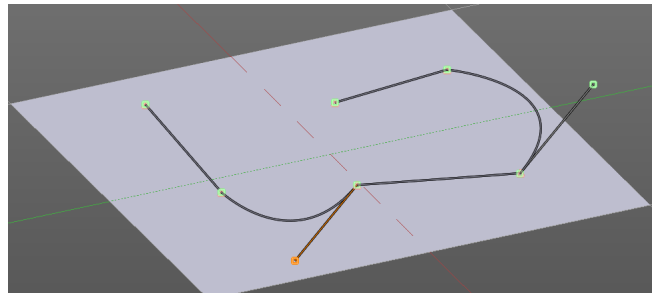
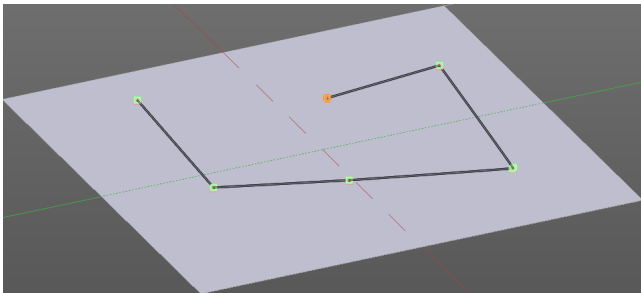
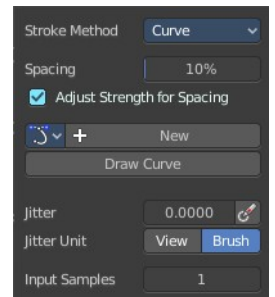

Spacing Edit Box

The drawing happens by mapping the pencil onto the mouse position. And when you move the mouse then the next mapping happens. Adjust the spacing after what mouse movement the next mapping should happen. The lower the value, the lower the distance between the single dots.

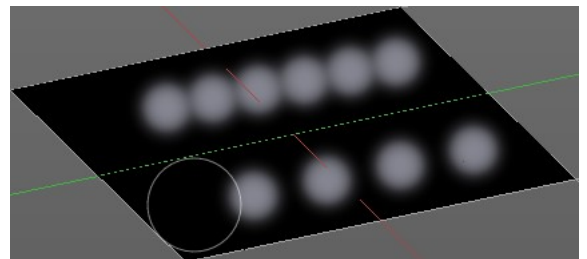

The icon behind the edit box enables tablet pressure sensitivity

for tablets.

Adjust Strength for Spacing

Automatically adjust strength to give consistent results for different spacing.

Paint Curve edit box

Here you set the active curve.

The first element is a drop down box where you will find your curves objects. You can have more than one.

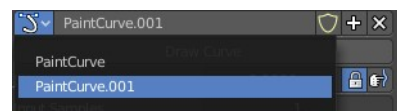

The second element is the edit box that displays the active curve.

The number right of it, **in this case 2**, indicates how much number of users (internally) this brush uses. This means that this data block (the brush) shares currently settings with at least one other object. Most probably the parent brush where we have created it from. Click at the value to make this brush a single user. The button will vanish then.

Set the brush to have a fake user. Zero user data-blocks are normally not saved. But sometimes you want to force the data to be kept even when the data block has no user.

The + button allows you to add a new pencil with the current settings. Note that the brushes are NOT saved when you close Bforartists. You can save them into the current blend file. Or you can save the startup file. But be careful here. This saves everything else of the current state of Bforartists too.

The X button deletes the brush as the active one. It does NOT delete it from the brushes list.

Draw Curve Button

A click at it turns the curve into a sculpt stroke.

Jitter Edit Box

Add Jitter to the brush while painting.

Jitter Pressure

The icon behind the edit box enables tablet pressure sensitivity for tablets.

Jitter Unit

Jitter in screen space, or relative to the brush size.

Input Samples Edit Box

Average multiple input samples together to smooth the brush stroke.

Stroke Panel with Stroke method Line

With Stroke method line you draw a line between a starting point and an endpoint. And when you release the mouse then the line gets sculpted.

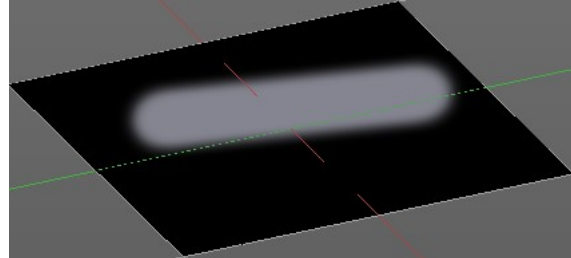
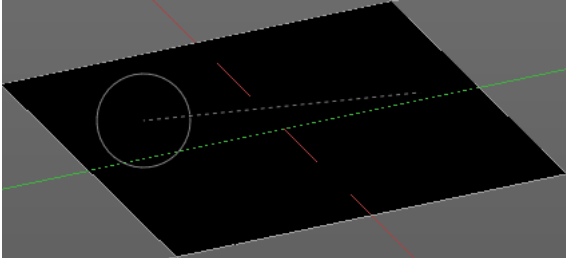
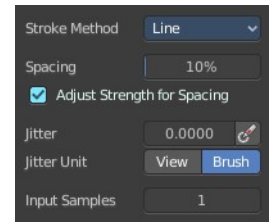

Spacing Edit Box

The drawing happens by mapping the pencil onto the mouse position. And when you move the mouse then the next mapping happens. Adjust the spacing after what mouse movement the next mapping should happen. The lower the value, the lower the distance between the single dots.

The icon behind the edit box enables tablet pressure sensitivity for tablets.

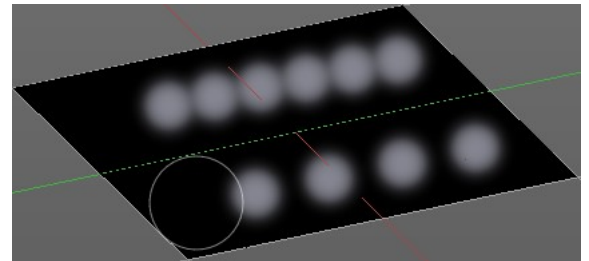

Adjust Strength for Spacing

Automatically adjust strength to give consistent results for different spacing.

Jitter Edit Box

Add Jitter to the brush while painting.

Jitter Pressure

The icon behind the edit box enables tablet pressure sensitivity for tablets.

Jitter Unit

Jitter in screen space, or relative to the brush size.

Input Samples Edit Box

Average multiple input samples together to smooth the brush stroke.

Stroke Panel with Stroke method Anchored

Click and drag to place a dot and to scale it.

Edge to edge

Drag Anchor Brush from edge to edge.

Jitter Edit Box

Add Jitter to the brush while painting.

Jitter Pressure

The icon behind the edit box enables tablet pressure sensitivity for tablets.

Jitter Unit

Jitter in screen space, or relative to the brush size.

Input Sample Edit Box

Average multiple input samples together to smooth the brush stroke.

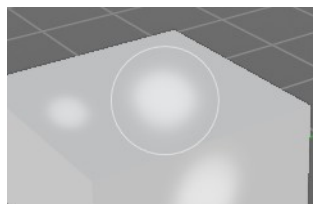
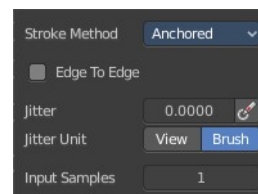

Stroke Panel with Stroke method Airbrush

The stroke acts like an airbrush pencil. The dots gets placed randomly.

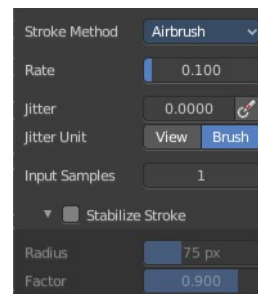
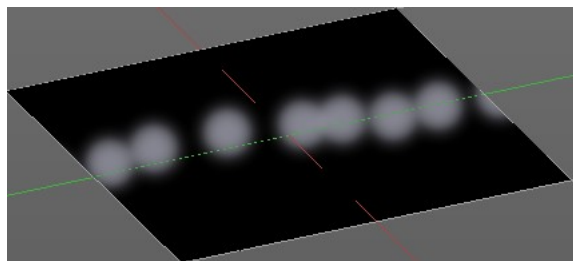

Rate Edit Box

Define the rate of the drawing.

Jitter Edit Box

Add Jitter to the brush while painting.

Jitter Pressure

The icon behind the edit box enables tablet pressure sensitivity for tablets.

Jitter Unit

Jitter in screen space, or relative to the brush size.

Input Samples Edit Box

Average multiple input samples together to smooth the brush stroke.

Stabilize Stroke

The brush lags behind the mouse position, and produces a much smoother stroke by that.

Smooth Stroke Radius Edit Box

Is just active when Smooth Stroke is activated. Adjust the radius of the smoothing.

Smooth Stroke Factor Edit Box

Is just active when Smooth Stroke is activated. Adjust the factor of the smoothing.

Stroke Panel with Stroke method Drag Dot

Paint a dot and drag it around. The actual painting happens then at releasing the mouse

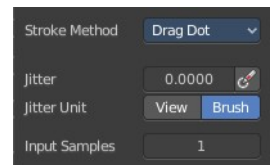

Jitter Edit Box

Add Jitter to the brush while painting.

Jitter Pressure

The icon behind the edit box enables tablet pressure sensitivity for tablets.



Jitter Unit

Jitter in screen space, or relative to the brush size.

Input Samples Edit Box

Average multiple input samples together to smooth the brush stroke.

Stroke Panel with Stroke method Dots

The stroke method Dots draws dots of the pencil onto the surface. The mapping happens from the current view. Means you will get distortions when your view is not aligned with the surface of the object.

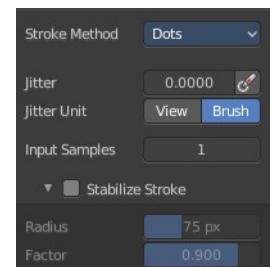

Jitter Edit Box

Add Jitter to the brush while painting.

Jitter Pressure

The icon behind the edit box enables tablet pressure sensitivity for tablets.

Jitter Unit

Jitter in screen space, or relative to the brush size.

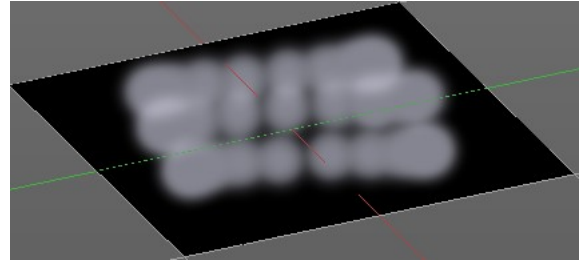

Input Samples Edit Box

Average multiple input samples together to smooth the brush stroke.

Stabilize Stroke

The brush lags behind the mouse position, and produces a much smoother stroke by that.

Smooth Stroke Radius Edit Box

Is just active when Smooth Stroke is activated. Adjust the radius of the smoothing.

Smooth Stroke Factor Edit Box

Is just active when Smooth Stroke is activated. Adjust the factor of the smoothing.

Brush Settings Panel - Falloff Sub panel

The curve panel allows you to define different falloffs methods for the border of the brush.

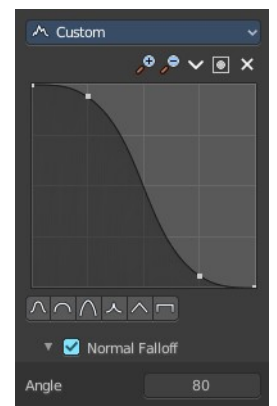

Selecting Points

You can select curve points. This reveals two edit boxes for the x and y coordinate of this point.

Selected points can be moved around. Left click at them, hold the mouse button down and move them to a new location.

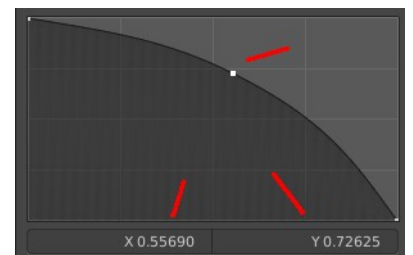

Adding Points

You can add new curve points by simply left clicking at the curve. Move the mouse to position them where you need it.

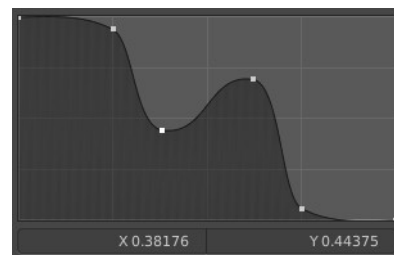

Navigation elements

The navigation elements at the top are described from left to right.

Zoom in and out

The two buttons with the magnifying glass at it zooms in and out in the curve window.



Tools

Tools is a menu where you can find some curve related tools.

Reset View

Resets the curve windows zoom.



Vector Handle

Set handle type to Vector.

Auto Handle

Set handle type to Auto.

Auto Clamped Handle

Set handle type to Auto Clamped.

Reset Curve

Resets the curve to the initial shape.

Use Clipping

Clipping options. Set up clipping for the stroke.

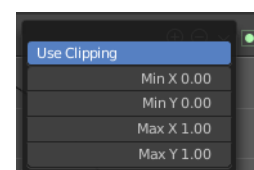

Delete Points

Deletes selected curve points.

Curve window

Tweak and adjust the falloff curve by clicking at a curve point and dragging it around.

Double click adds a new point.

Holding down ctrl activates temporary snapping.

Holding down shift enables slower movement, which allows more accurate setting.

Curve Presets

Predefined curve presets.



Falloff Shape

Use projected or spherical falloff.

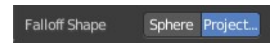

Normal Falloff

Blend Brush influence, dependent by how much they face the front.

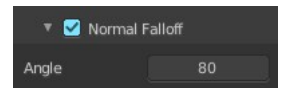

Angle

Adjust the angle.

Brush Settings Panel - Cursor Sub panel

Adjust the color and appearance of the brush cursor to custom values.

Cursor Checkbox

Activate the custom settings.

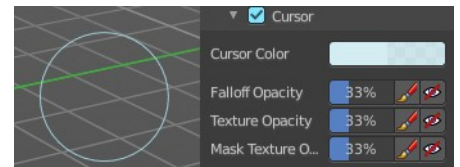

Cursor Color

Choose another color for the brush cursor. Double clicking at the color field will open a color picker.



Falloff Opacity

You can turn on the cursor overlay with the eye button at the end. The falloff opacity slider allows you to adjust the opacity of this cursor overlay.

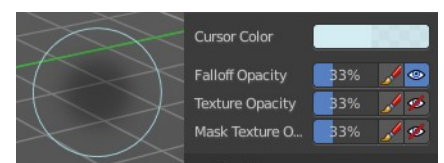

Override Overlay

Hide the Cursor Overlay when painting.

Use Cursor Overlay

Turn on Cursor Overlay.

Texture Opacity

This is for the case when you paint with a texture brush. You can turn on the Texture overlay with the eye button at the end. The falloff opacity slider allows you to adjust the opacity of this cursor overlay.

Override Overlay

Hide the Texture Overlay when painting.

Use Cursor Overlay

Turn on Texture Overlay.

Mask Texture Opacity

This is for the case when you mask paint with a texture brush. You can turn on the Texture overlay with the eye button at the end. The falloff opacity slider allows you to adjust the opacity of this cursor overlay.

Override Overlay

Hide the Texture Overlay when painting.

Use Cursor Overlay

Turn on Texture Overlay.

Brush Settings Panel - Clone from Paint Slot Sub panel

This panel is just for the clone tool in the tool shelf.

Activate to clone from the current texture. For the clone tool description see tool shelf. Here you just can activate, then see or choose the material to clone from. It is a list.

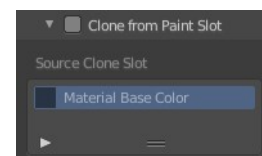

Masking Panel

Stencil Mask

Stencil mask allows mask painting with a stencil map. It is a sub menu tab. In expanded state it shows the falloff curve, which can be edited.

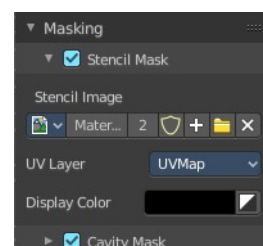

Activate Stencil map

Activates the stencil map

Stencil Image

Choose or load your stencil texture.

Texture browser

Here you will find a list of currently loaded textures.

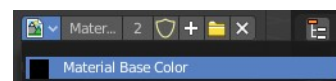

Edit Box

The currently active stencil texture.

The number right of it, **in this case 2**, indicates how much number of users (internally) this brush uses. This means that this data block (the brush) shares currently settings with at least one other object. Most probably the parent brush where we have created it from. Click at the value to make this brush a single user. The button will vanish then.

The shield icon button set the brush to have a fake user. Zero user data-blocks are normally not saved. But sometimes you want to force the data to be kept even when the data block has no user.

The + button allows you to add a new pencil with the current settings. Note that the brushes are NOT saved when you close Bforartists. You can save them into the current blend file. Or you can save the startup file. But be careful here. This saves everything else of the current state of Bforartists too.

The X button deletes the brush as the active one. It does NOT delete it from the brushes list.

UV Layer

At which UV map the stencil texture is active.

Display Color

The stencil color in the viewport.

Cavity Mask

Cavity mask allows mask painting according to mesh geometry cavity. It is a sub menu tab. In expanded state it shows the falloff curve, which can be edited.

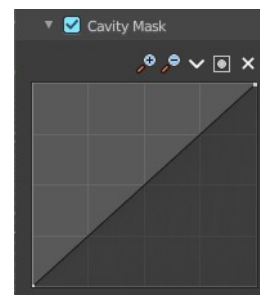

Activate Cavity mask

Activates the Cavity mask.

Navigation elements

The navigation elements at the top are described from left to right.

Zoom in and out

The two buttons with the magnifying glass at it zooms in and out in the curve window.

Zoom in and out

The two buttons with the magnifying glass at it zooms in and out in the curve window.

Tools

Tools is a menu where you can find some curve related tools.

Reset View

Resets the curve windows zoom.



Vector Handle

Set handle type to Vector.

Auto Handle

Set handle type to Auto.

Auto Clamped Handle

Set handle type to Auto Clamped.

Reset Curve

Resets the curve to the initial shape.

Use Clipping

Clipping options. Set up clipping for the stroke.

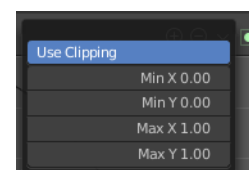

Delete Points

Deletes selected curve points.

Symmetry Panel

Symmetry Panel

Turn on/off symmetry painting along X, Y and Z axis. The mirroring happens along the world axis.

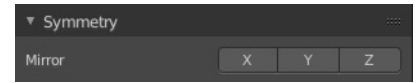

The same buttons can also be found in the tool settings bar as icon buttons. This allows quicker access and better visual control which mirror axis is currently active.

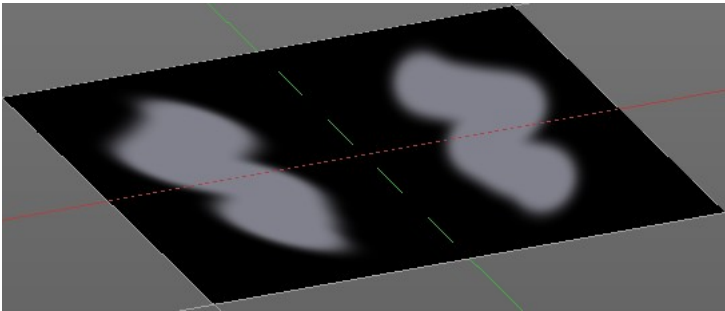

Options Panel

Bleed

An edit box to adjust the amount of bleeding into the areas outside of the faces UV.

Dither

An Edit box to adjust the amount of dither when painting on byte images

Occlude

Only paint the faces directly under the mouse.

Backface Culling

Ignore faces that are painting away from the viewport.

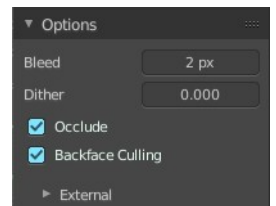

External

The external sub panel allows you to do projection painting by using an external 2d image editor. The projection happens from the current view. So this can lead to distortions.

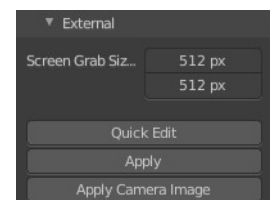

Screen Grab Size

Set the resolution of the shot.

Quick Edit

Opens a shot of the current view in your 2D Image Editor.

Apply

Applies the changes that you made and saved in your 2D Image Editor.

Apply Camera Image

Project an edited render from the active camera back onto the object.

This feature requires to have a background image loaded. Then this background image can be projected onto the object from the camera view.

Workflow for external editing

Preparations

You first have to link your software that you want to use here. When there is no image editor linked then you will get a warning.

Open the User Preferences, go to the File tab. Here choose the Image Editor section, and browse for your image editor. I have chosen Gimp here at Windows 7.

Don't forget to save the User Settings!

For further options have a look in the Project Paint panel.

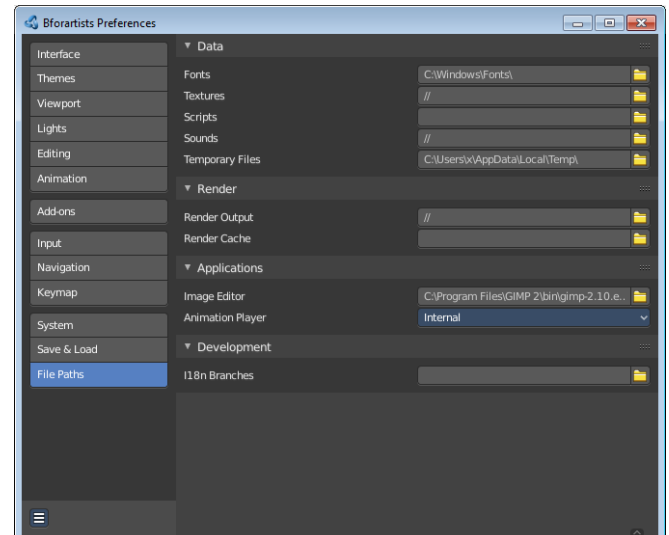

Usage

Click at the Quick Edit Button. And your image editor will open up with a shot from the current view. Modify your image.

When done simply overwrite the image. Sorry for the german shot ...

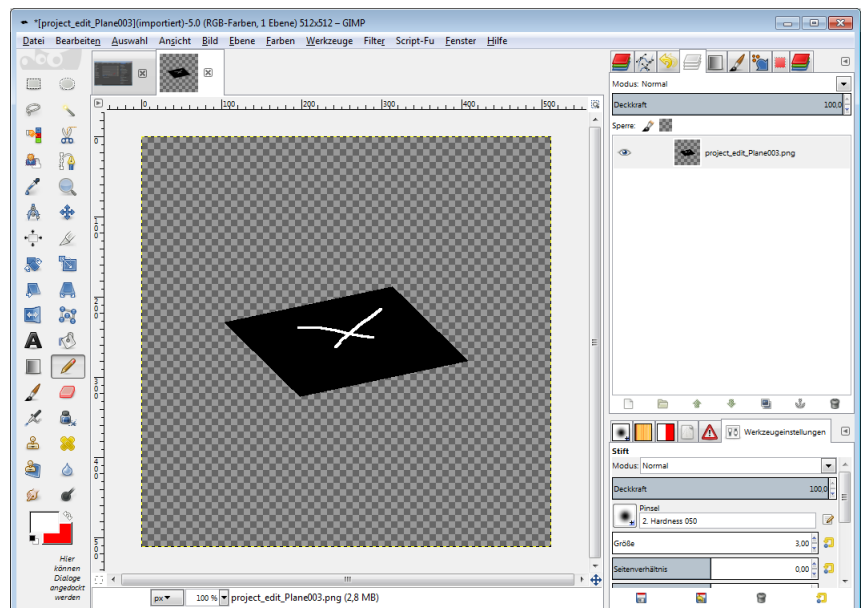

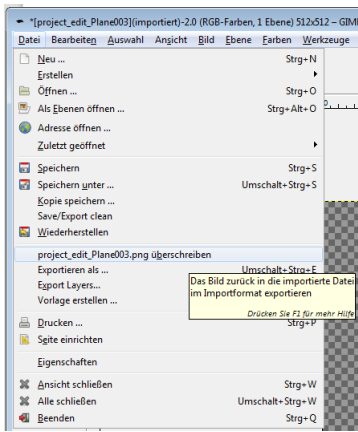

Back in Bforartists click at the Apply button. And the result gets mapped onto your object.

Attention, don't change the camera view while doing this. Mapping happens from the current camera view!

7.3.9 Editors - 3D Viewport - Sidebar - Tool Tab - Mesh - Weight Paint Mode

Table of content

Detailed table of content.....	1
Tools tab in Weight Paint Mode.....	4
Weight painting at characters.....	4
Weight painting a plain mesh.....	6
Weight painting in combination with particles.....	7
Brushes Panel.....	7
Browse Brush.....	7
Custom Icon.....	8
Brush Settings Panel.....	8
Brush Settings Panel - Advanced Sub panel.....	10
Brush Settings Panel - Stroke Sub panel.....	10
Stroke Panel with Stroke method Space.....	10
Stroke Panel with Stroke method Curve.....	11
Stroke Panel with Stroke method Line.....	13
Stroke Panel with Stroke method Airbrush.....	14
Stroke Panel with Stroke method Dots.....	15
Brush Settings Panel - Falloff Sub panel.....	16
Selecting Points.....	16
Adding Points.....	16
Navigation elements.....	16
Brush Settings Panel - Cursor Sub panel.....	18
Cursor Checkbox.....	18
Cursor Color.....	18
Falloff Opacity.....	18
Texture Opacity.....	18
Symmetry Panel.....	19
Mirror Vertex Groups.....	19
Mirror.....	19
Radial.....	19
Options Panel.....	19
Auto Normalize.....	19
Multi Paint.....	19
Restrict.....	19
X Mirror.....	19
Topology Mirror.....	19

Detailed table of content

Detailed table of content

Detailed table of content.....	1
Tools tab in Weight Paint Mode.....	4
Weight painting at characters.....	4
Skinning.....	4
Enter and leave Weight painting.....	6

Switch bones.....	6
Weight painting a plain mesh.....	6
Weight painting in combination with particles.....	7
Brushes Panel.....	7
Browse Brush.....	7
Custom Icon.....	8
Brush Settings Panel.....	8
Blend.....	9
Weight.....	9
Size Pressure.....	9
Radius.....	9
Size Pressure.....	9
Use Unified Radius.....	9
Strength.....	9
Size Pressure.....	9
Use Unified Radius.....	9
Brush Settings Panel - Advanced Sub panel.....	10
Accumulate.....	10
Front Faces Only.....	10
Brush Settings Panel - Stroke Sub panel.....	10
Stroke Panel with Stroke method Space.....	10
Spacing Edit Box.....	10
Spacing Pressure.....	10
Dash Ratio.....	10
Dash Length.....	11
Jitter Edit Box.....	11
Jitter Pressure.....	11
Jitter Unit.....	11
Input Samples Edit Box.....	11
Stabilize Stroke.....	11
Smooth Stroke Radius Edit Box.....	11
Smooth Stroke Factor Edit Box.....	11
Stroke Panel with Stroke method Curve.....	11
Spacing Edit Box.....	12
Paint Curve edit box.....	12
Draw Curve Button.....	13
Jitter Edit Box.....	13
Jitter Pressure.....	13
Jitter Unit.....	13
Input Samples Edit Box.....	13
Stroke Panel with Stroke method Line.....	13
Spacing Edit Box.....	13
Jitter Edit Box.....	14
Jitter Pressure.....	14
Jitter Unit.....	14
Input Samples Edit Box.....	14
Stroke Panel with Stroke method Airbrush.....	14
Rate Edit Box.....	14
Jitter Edit Box.....	14
Jitter Pressure.....	14
Jitter Unit.....	14
Input Samples Edit Box.....	15
Smooth Stroke.....	15

Smooth Stroke Radius Edit Box.....	15
Smooth Stroke Factor Edit Box.....	15
Stroke Panel with Stroke method Dots.....	15
Jitter Edit Box.....	15
Jitter Pressure.....	15
Jitter Unit.....	15
Input Samples Edit Box.....	15
Stabilize Stroke.....	16
Smooth Stroke Radius Edit Box.....	16
Smooth Stroke Factor Edit Box.....	16
Brush Settings Panel - Falloff Sub panel.....	16
Selecting Points.....	16
Adding Points.....	16
Navigation elements.....	16
Zoom in and out.....	17
Tools.....	17
Reset View.....	17
Vector Handle.....	17
Auto Handle.....	17
Auto Clamped Handle.....	17
Reset Curve.....	17
Use Clipping.....	17
Delete Points.....	17
Curve Presets.....	17
Falloff Shape.....	17
Front face Falloff.....	17
Angle.....	18
Brush Settings Panel - Cursor Sub panel.....	18
Cursor Checkbox.....	18
Cursor Color.....	18
Falloff Opacity.....	18
Override Overlay.....	18
Use Cursor Overlay.....	18
Texture Opacity.....	18
Override Overlay.....	18
Use Cursor Overlay.....	18
Symmetry Panel.....	19
Mirror Vertex Groups.....	19
Topology Mirror.....	19
Mirror.....	19
Radial.....	19
Options Panel.....	19
Auto Normalize.....	19
Multi Paint.....	19
Restrict.....	19
X Mirror.....	19
Topology Mirror.....	19

Tools tab in Weight Paint Mode

The Tools tab in Weight Paint Mode provides you the tools to do weight painting at a mesh. Skinned characters for example.

The vertices becomes a "weighting" assigned in this process. Means a per centage influence of the bone to a vertice. And under the hood you create vertex groups with the vertices that are assigned to the bones.

The amount of influence is defined by the weight paint color. Pure red has an influence value of 1. Pure blue has an influence value of 0. And the gradients between red and blue defines the in between steps in the 0-1 range. This is needed since there can be more than one bone influence and deform a vertice. Usually at the transition areas between two bones. The green areas in this shot.

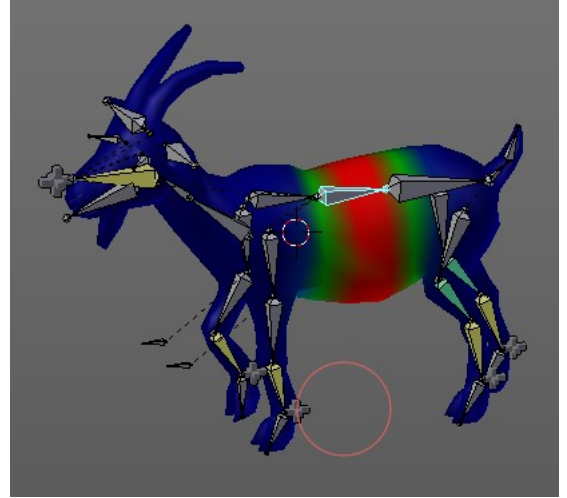

The Weight Paint mode is just available for mesh objects.

Weight painting at characters

The main purpose for Weight painting is to weight the skin for characters. So that they deform proper when you pose your armature.

Skinning

To do weight painting at a character you first have to assign the mesh to the armature. This process is called skinning. The mesh becomes the "skin" for the skeleton.

Let's do a quick run through skinning. You can skin in Object Mode. But also from Pose Mode. Lock Object Modes needs to be unticked to get it to work from Pose Mode, which it is by default. In case you have it on, untick it now.

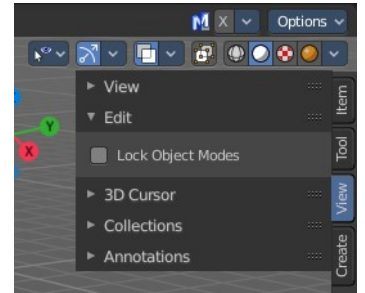

Create an object, create an armature

First we activate Display "in Front" for the armature. So that we can still see the armature inside of the mesh.

Position the mesh at its final location.

Now select the Mesh, hold down Shift key, and select the Armature. Both should be selected now.

Dive into the Object menu in the header of the 3D view, and search for Parent, with automatic weights. You can also press the hotkey Ctrl P. This calls the parenting menu under the mouse position.

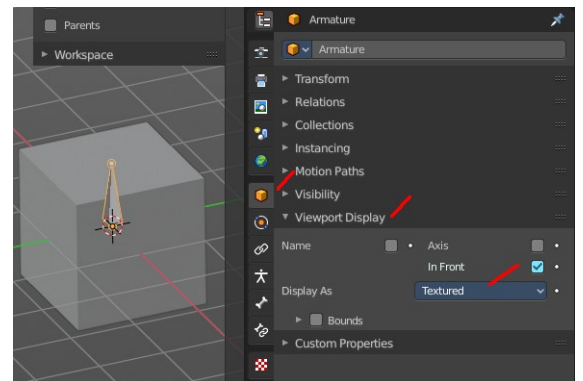

Here we choose "With Automatic Weights". Automatic weighting means that the bones grabs the nearest vertices within a given radius, and assigns them to this bone.

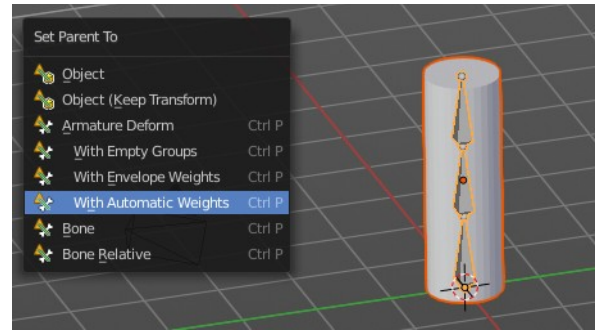
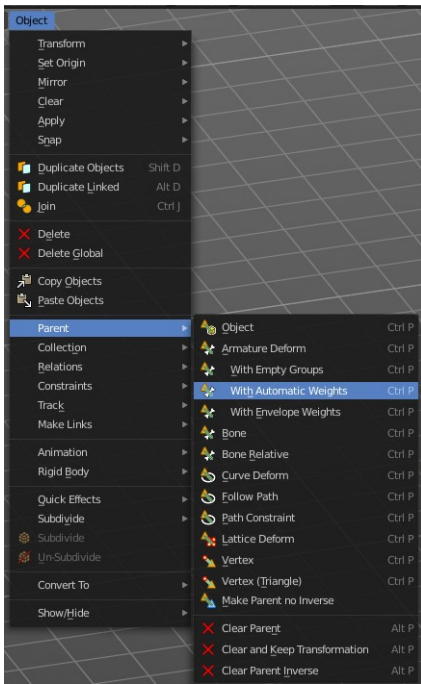

When everything went well then the mesh, in our case the Cylinder, is now part of the hierarchy of the armature.

And when you select the armature, and switch to Pose mode now, then you can already deform the mesh by posing the armature.

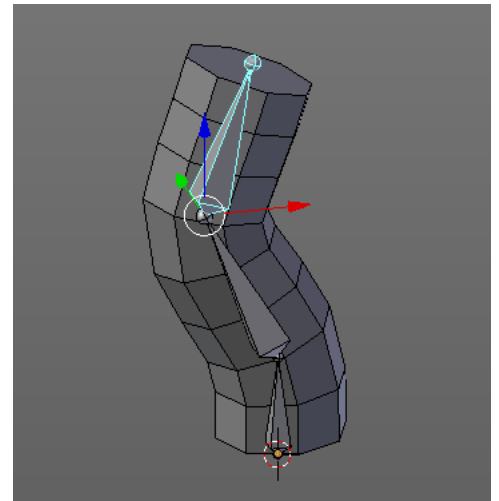

Note that currently the outliner does not indicate the hierarchy anymore. In former versions the cylinder became part of the armature when you parented it together. In the current version the cylinder remains where it is.

You can however select the whole hierarchy in the right click menu. And put it into an own collection for example.

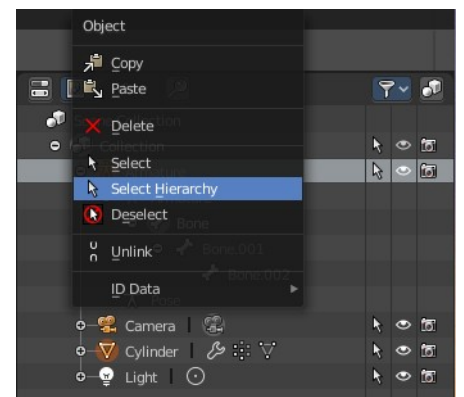
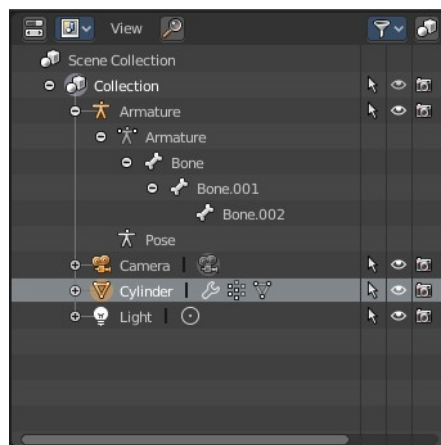

Enter and leave Weight painting

Weight painting should happen in Pose mode so that you can pose your mesh to see the resulting deforming.

With the armature in Pose mode, select the mesh by clicking at it. Then enter Weight Paint mode. You can now do weight painting at the mesh.

To leave Weight painting, simply switch back to Object mode. Or select the armature in the outliner.

Switch bones

The weighting that gets displayed when you enter Weight Paint mode is from the last active bone. So that's one method to define the bone that you want to weight paint. But you can also switch bones while in weight painting.

Hold down **Ctrl**, and **left click** at the bone that you want to set active. Then the weighting for this bone gets displayed.

Note that this just works when you come from Pose Mode. When you come from object mode, then you can't select another bone that way.

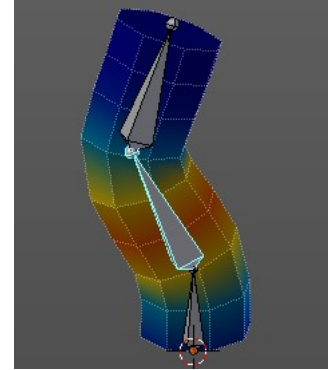

Weight painting a plain mesh

You can also do weight painting without an armature. Just at the pure mesh. In this case you just create the vertex groups for the mesh. And those vertex groups can be accessed in edit mode then for further usage. As shown in the shots below.

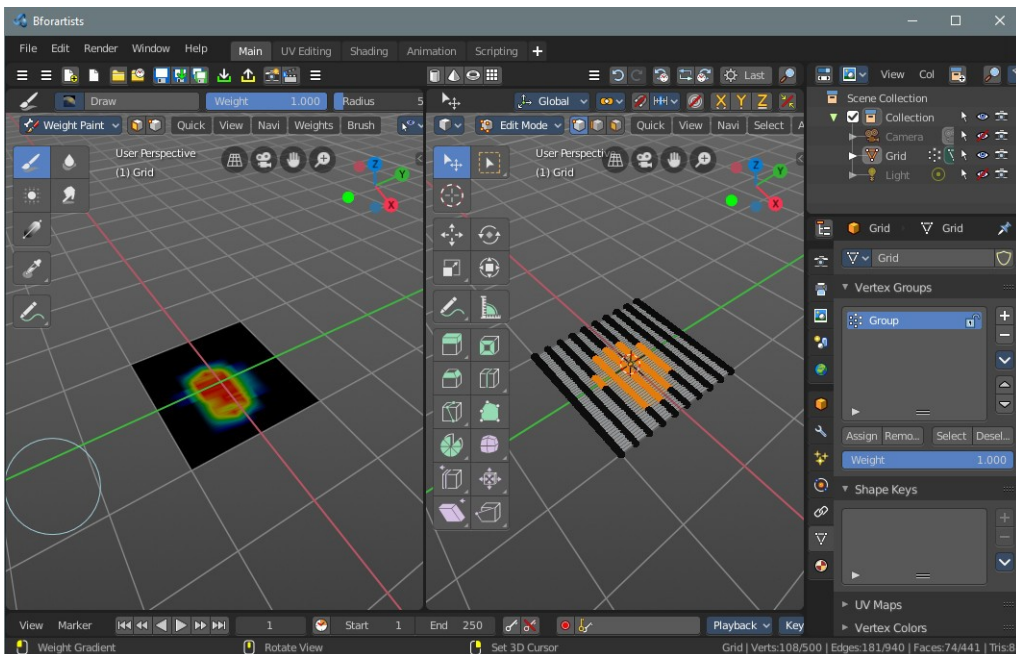

Weight painting in combination with particles

You can also combine weight painting with particles. To influence the density of hair for example. The weightmap can be assigned in the Vertex Groups panel in the Particles tab.

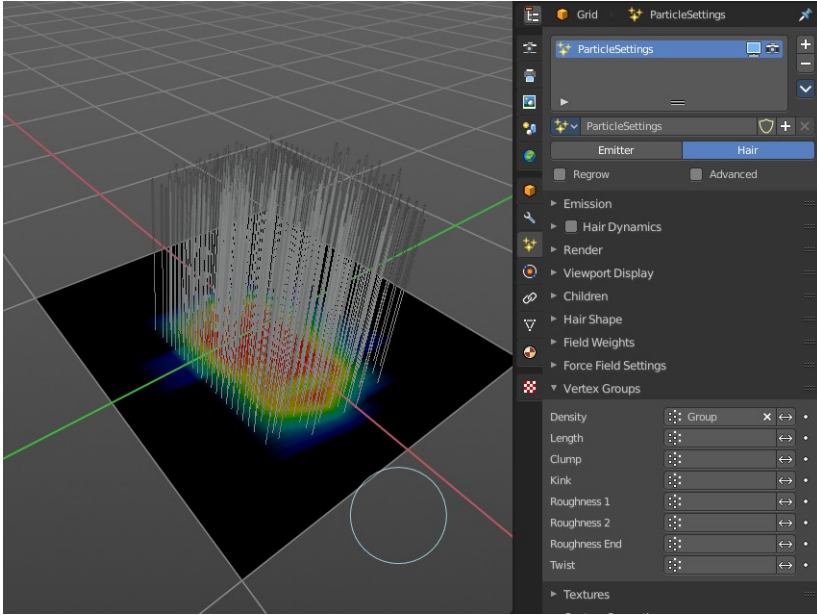

Brushes Panel

The Brush Panel contains the different Brushes and some Brush settings. Choose and adjust your current active brush.

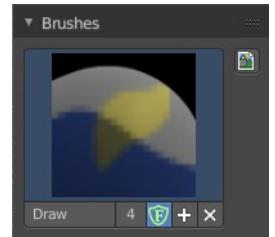

Browse Brush

The big image at the top is a drop down box to choose a brush. Click at it, and you will see the different brushes. A click at one of the images will choose this brush then.

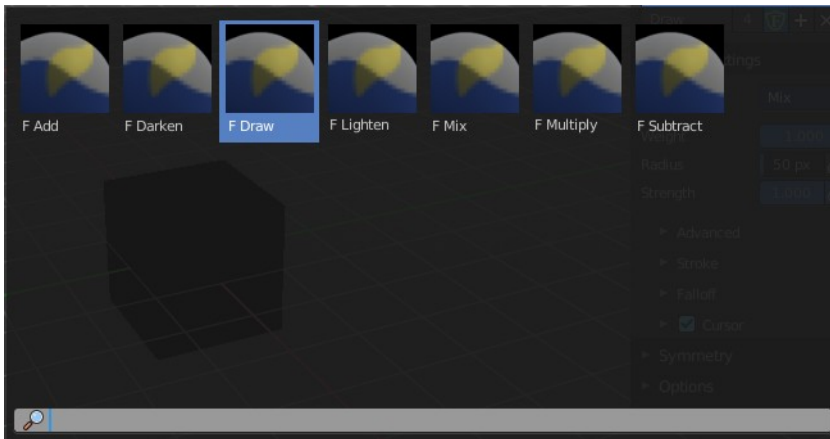

When you have added a few more brushes then the drop down box may be more than full. You will see some little white arrows then. Either in the top left or in the bottom right corner. They indicate that some brushes are

hidden before or after the current display.

To scroll to this hidden content use the mouse wheel, or the arrow up and down buttons at the keyboard.

Custom Icon

The button at the right allows you to load a custom icon for your brush. It reveals a file browser below the image browser.

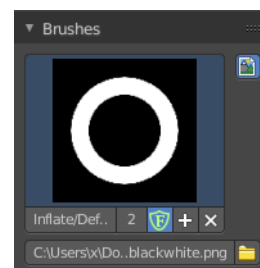

The edit box below the Image shows you the name of the current active brush.



The number right of it, **in this case 2**, indicates how much number of users (internally) this brush uses. This means that this data block (the brush) shares currently settings with at least one other object. Most probably the parent brush where we have created it from. Click at the value to make this brush a single user. The button will vanish then.

F set the brush to have a fake user. Zero user data-blocks are normally not saved. But sometimes you want to force the data to be kept even when the data block has no user.

The + button allows you to add a new pencil with the current settings. Note that the brushes are NOT saved when you close Bforartists. You can save them into the current blend file. Or you can save the startup file. But be careful here. This saves everything else of the current state of Bforartists too.

The X button deletes the brush as the active one. It does NOT delete it from the brushes list.

Brush Settings Panel

The Brush Settings Panel contains the Brush settings. The content differs, dependent of which brush you have chosen.

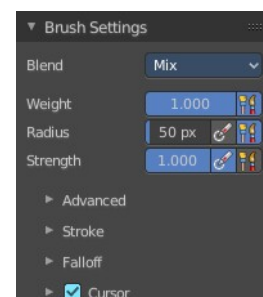

Blend

Define how the stroke will blend. You can choose between various blend modes.

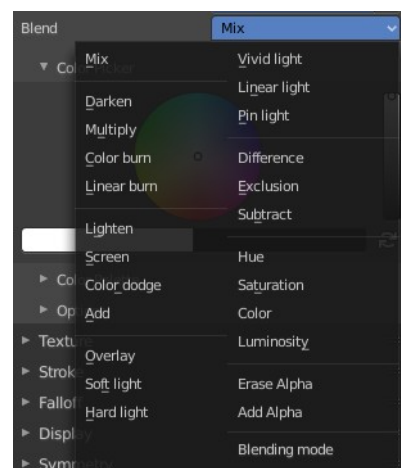

Weight

Adjust the strength of the weight painting.

Size Pressure

The first button behind the edit box enables tablet pressure sensitivity for radius.

Radius

The Radius edit box allows you to adjust the radius of the brush. The button behind the edit box enables tablet pressure sensitivity for radius.

Size Pressure

The first button behind the edit box enables tablet pressure sensitivity for radius.

Use Unified Radius

The second button behind the edit box enables global radius size. Any modification at the radius will also modify the radius value for other paint tools.

Strength

The Strength edit box allows you to adjust the strength of the brush. The button behind the edit box enables tablet pressure sensitivity for strength.

Size Pressure

The first button behind the edit box enables tablet pressure sensitivity for radius.

Use Unified Radius

The second button behind the edit box enables global radius size. Any modification at the radius will also modify the radius value for other paint tools.

Brush Settings Panel - Advanced Sub panel

Accumulate

Accumulate stroke daubs on top of each other.

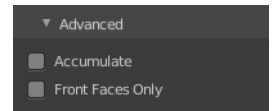

Front Faces Only

The Brush only paints at faces that faces to the view.

Brush Settings Panel - Stroke Sub panel

The Stroke panel contains settings to influence the behavior of the brush stroke. There are various stroke methods available. We will go through them one by one.

Stroke Panel with Stroke method Space

This is the default Stroke method. The sculpt stroke gets added continuously with given settings.

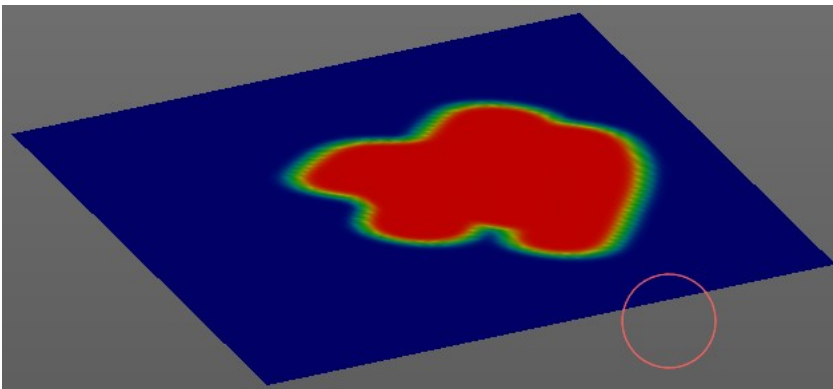
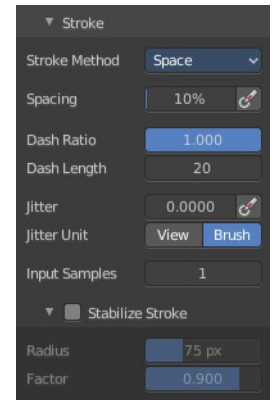

Spacing Edit Box

The drawing happens by mapping the pencil onto the mouse position. And when you move the mouse then the next mapping happens. Adjust the spacing after what mouse movement the next mapping should happen. The lower the value, the lower the distance between the single dots.

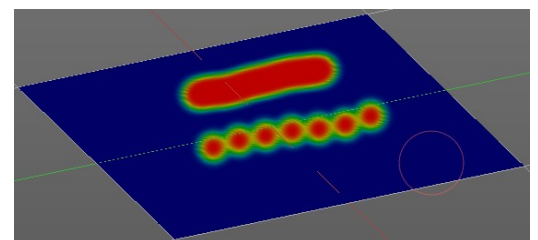

Spacing Pressure

The icon behind the edit box enables tablet pressure sensitivity for tablets.

Dash Ratio

Ratio of samples in a cycle that the brush is enabled.

Dash Length

Length of a dash cycle measured in stroke samples.

Jitter Edit Box

Add Jitter to the brush while painting.



Jitter Pressure

The icon behind the edit box enables tablet pressure sensitivity for tablets.

Jitter Unit

If the jitter happens in screen space in pixels, or relative to the brush size.

Input Samples Edit Box

Average multiple input samples together to smooth the brush stroke.



Stabilize Stroke

The brush lags behind the mouse position, and produces a much smoother stroke by that.

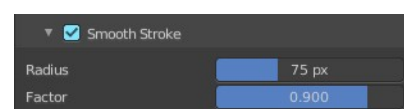

Smooth Stroke Radius Edit Box

Is just active when Smooth Stroke is activated. Adjust the radius of the smoothing.

Smooth Stroke Factor Edit Box

Is just active when Smooth Stroke is activated. Adjust the factor of the smoothing.

Stroke Panel with Stroke method Curve

The Stroke method curve doesn't simply influence the way how the stroke is painted. It is a special method. First you draw a curve object by holding down ctrl and clicking with left mouse button. Then you tweak the curve. You can click at the curve point, and drag out handlers to make the curve points smooth.

Then you hit the Draw Curve button. And the curve gets drawn onto the surface.

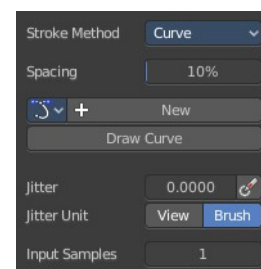

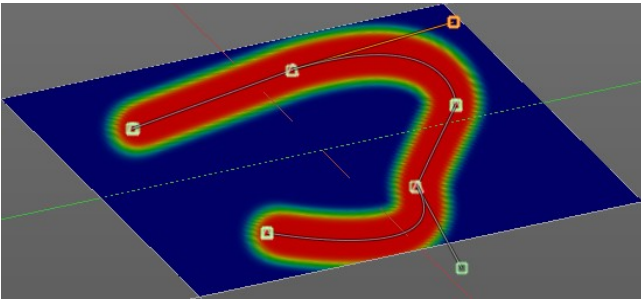
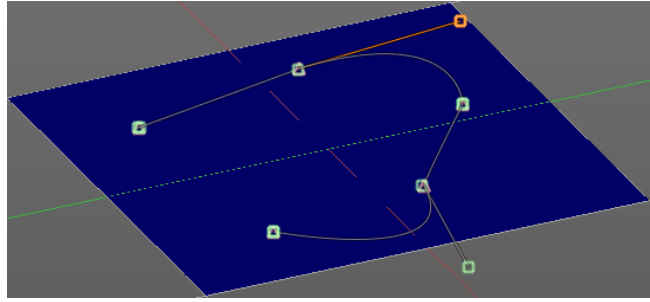
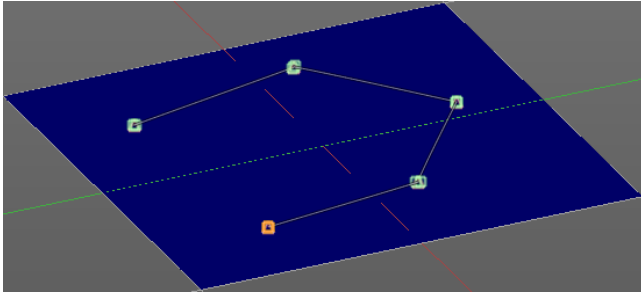

Spacing Edit Box

The drawing happens by mapping the pencil onto the mouse position. And when you move the mouse then the next mapping happens. Adjust the spacing after what mouse movement the next mapping should happen. The lower the value, the lower the distance between the single dots.

The icon behind the edit box enables tablet pressure sensitivity for tablets.

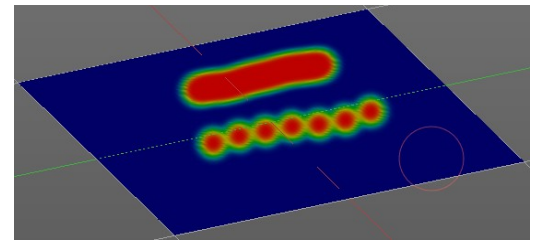

Paint Curve edit box

Here you set the active curve.

The first element is a drop down box where you will find your curves objects. You can have more than one.

The second element is the edit box that displays the active curve.

The number right of it, **in this case 2**, indicates how much number of users (internally) this brush uses. This means that this data block (the brush) shares currently settings with at least one other object. Most probably the parent brush where we have created it from. Click at the value to make this brush a single user. The button will vanish then.

F set the brush to have a fake user. Zero user data-blocks are normally not saved. But sometimes you want to force the data to be kept even when the data block has no user.

The + button allows you to add a new pencil with the current settings. Note that the brushes are NOT saved when you close Bforartists. You can save them into the current blend file. Or you can save the startup file. But be careful here. This saves everything else of the current state of Bforartists too.

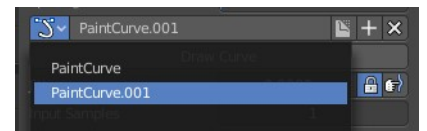

The X button deletes the brush as the active one. It does NOT delete it from the brushes list.

Draw Curve Button

A click at it to turns the curve into a sculpt stroke.

Jitter Edit Box

Add Jitter to the brush while painting.



Jitter Pressure

The icon behind the edit box enables tablet pressure sensitivity for tablets.

Jitter Unit

If the jitter happens in screen space in pixels, or relative to the brush size.

Input Samples Edit Box

Average multiple input samples together to smooth the brush stroke.

Stroke Panel with Stroke method Line

With Stroke method line you draw a line between a starting point and an endpoint. And when you release the mouse then the line gets sculpted.

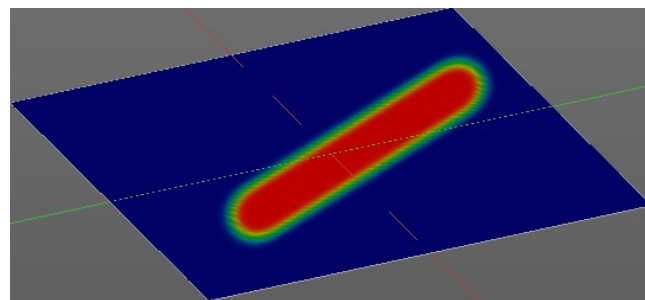
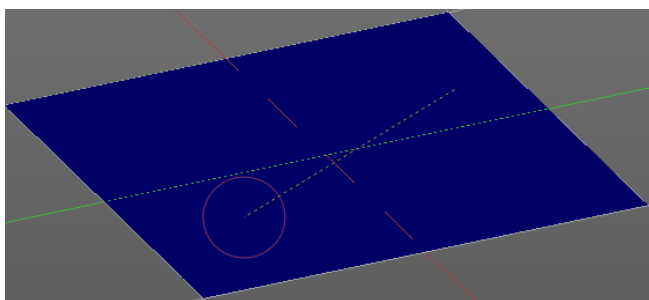
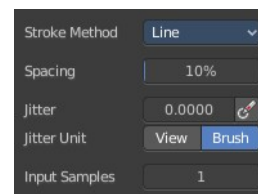

Spacing Edit Box

The sculpt drawing happens by mapping the pencil onto the mouse position. And when you move the mouse then the next mapping happens. Adjust the spacing after what mouse movement the next mapping should happen. The lower the value, the lower the distance between the single dots.

The icon behind the edit box enables tablet pressure sensitivity for tablets.

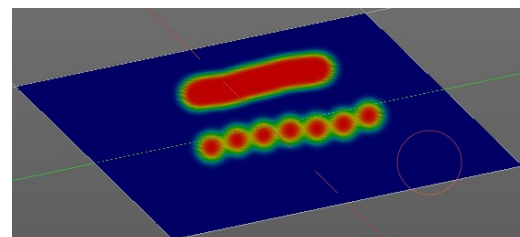

Jitter Edit Box

Add Jitter to the brush while painting.



Jitter Pressure

The icon behind the edit box enables tablet pressure sensitivity for tablets.

Jitter Unit

If the jitter happens in screen space in pixels, or relative to the brush size.

Input Samples Edit Box

Average multiple input samples together to smooth the brush stroke.

Stroke Panel with Stroke method Airbrush

The stroke acts like an airbrush pencil. The dots gets sprayed randomly.

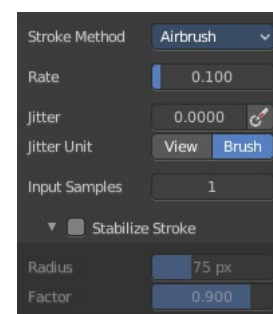
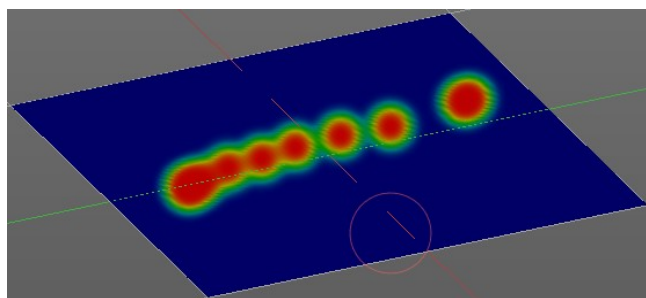

Rate Edit Box

Define the rate of the drawing.

Jitter Edit Box

Add Jitter to the brush while painting.



Jitter Pressure

The icon behind the edit box enables tablet pressure sensitivity for tablets.

Jitter Unit

If the jitter happens in screen space in pixels, or relative to the brush size.

Input Samples Edit Box

Average multiple input samples together to smooth the brush stroke.

Smooth Stroke

The brush lags behind the mouse position, and produces a much smoother stroke by that.

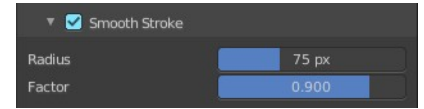

Smooth Stroke Radius Edit Box

Is just active when Smooth Stroke is activated. Adjust the radius of the smoothing.

Smooth Stroke Factor Edit Box

Is just active when Smooth Stroke is activated. Adjust the factor of the smoothing.

Stroke Panel with Stroke method Dots

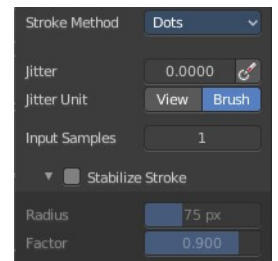
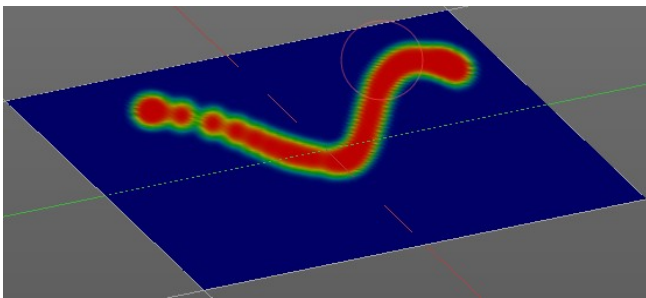

The stroke method Dots draws dots of the pencil onto the surface. The mapping happens from the current view. Means you will get distortions when your view is not aligned with the surface of the object.

Jitter Edit Box

Add Jitter to the brush while painting.

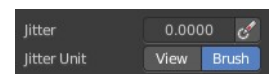

Jitter Pressure

The icon behind the edit box enables tablet pressure sensitivity for tablets.

Jitter Unit

If the jitter happens in screen space in pixels, or relative to the brush size.

Input Samples Edit Box

Average multiple input samples together to smooth the brush stroke.

Stabilize Stroke

The brush lags behind the mouse position, and produces a much smoother stroke by that.

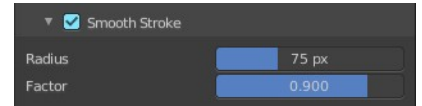

Smooth Stroke Radius Edit Box

Is just active when Smooth Stroke is activated. Adjust the radius of the smoothing.

Smooth Stroke Factor Edit Box

Is just active when Smooth Stroke is activated. Adjust the factor of the smoothing.

Brush Settings Panel - Falloff Sub panel

The Falloff panel allows you to define different falloffs methods for the border of the brush.

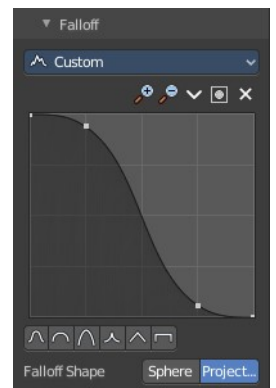

Selecting Points

You can select curve points. This reveals two edit boxes for the x and y coordinate of this point.

Selected points can be moved around. Left click at them, hold the mouse button down and move them to a new location.

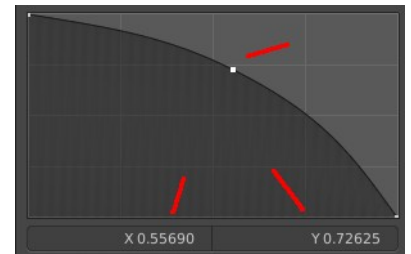

Adding Points

You can add new curve points by simply left clicking at the curve. Move the mouse to position them where you need it.

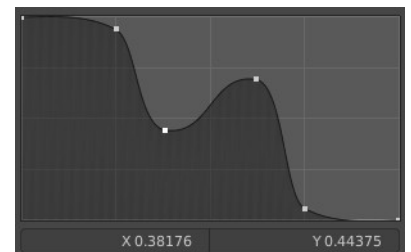

Navigation elements

The navigation elements at the top are described from left to right.



Zoom in and out

The two buttons with the magnifying glass at it zooms in and out in the curve window.

Tools

Tools is a menu where you can find some curve related tools.

Reset View

Resets the curve windows zoom.

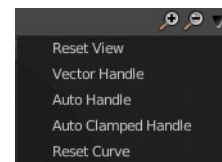

Vector Handle

Set handle type to Vector.

Auto Handle

Set handle type to Auto.

Auto Clamped Handle

Set handle type to Auto Clamped.

Reset Curve

Resets the curve to the initial shape.

Use Clipping

Clipping options. Set up clipping for the stroke. The blue button at the top turns clipping on or off.

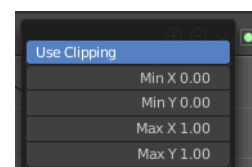

Delete Points

Deletes the selected curve point.

Curve Presets

Predefined curve presets.



Falloff Shape

Use projected or spherical falloff.



Front face Falloff

Blend brush influence by how much they face the front.

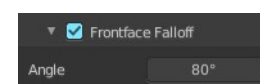

Angle

Paint most on faces pointing towards the view according to this angle.

Brush Settings Panel - Cursor Sub panel

Adjust the color and appearance of the brush cursor to custom values.

Cursor Checkbox

Activate the custom settings.

Cursor Color

Choose another color for the brush cursor. Double clicking at the color field will open a color picker.

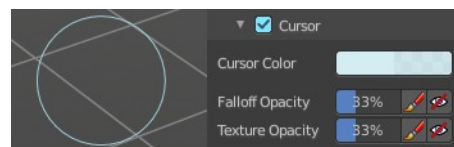

Falloff Opacity

You can turn on the cursor overlay with the eye button at the end. The falloff opacity slider allows you to adjust the opacity of this cursor overlay.

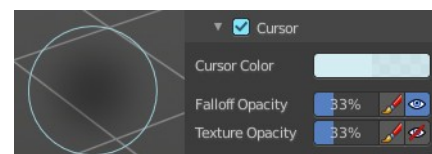

Override Overlay

Hide the Cursor Overlay when painting.

Use Cursor Overlay

Turn on Cursor Overlay.

Texture Opacity

This is for the case when you paint with a texture brush. You can turn on the Texture overlay with the eye button at the end. The falloff opacity slider allows you to adjust the opacity of this cursor overlay.

Override Overlay

Hide the Texture Overlay when painting.

Use Cursor Overlay

Turn on Texture Overlay.

Symmetry Panel

The same buttons plus the whole Symmetry Lock Panel as a drop down menu can also be found in the tool settings bar as icon buttons. This allows quicker access and better.

Mirror Vertex Groups

Mirror the left/right vertex groups when painting.

Topology Mirror

Not available with Mirror Vertex Groups deactivated. Use topology based mirroring. Both sides of the mesh needs matching geometry.

Mirror

Mirror along given axis. With Mirror Vertex groups on you just can turn on or off the X axis.

Radial

Tiling. The number of times to repeat the strokes across the surface. Not available with Mirror Vertex Groups activated.

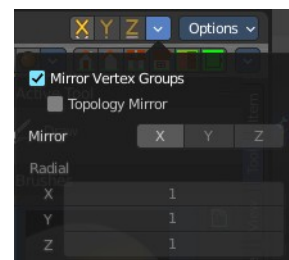
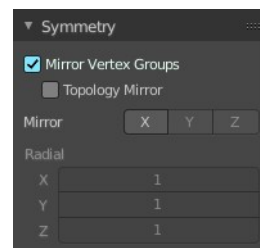

Options Panel

Auto Normalize

Ensure that all bone deforming vertex groups adds up to 1.0 while weight painting.

Multi Paint

Paint across the weights of all selected bones, maintaining their relative influence.

Restrict

Restrict painting to vertices in the group.

X Mirror

X Axis Mirror Editing.

Topology Mirror

Needs X Mirror ticked. Use topology based mirroring. For when both sides of the mesh have matching, unique topology.

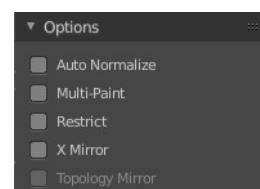



8 Editors - Image Editor

Table of content

- Image Editor.....2
- Navigating in the Image Editor viewport.....3
 - Hotkeys.....3
 - Navigation Elements.....3
 - 2D Cursor.....3
- Viewport context menus.....3
 - Double right click in Paint mode.....3
 - Blend Mode.....4
 - Radius.....4
 - Strength.....4
 - Double right click in Mask mode.....4
 - Without a mask.....4
 - New Mask.....4
 - Last Operator New Mask.....4
 - Name.....4
 - Add Circle.....4
 - Last Operator Add Circle.....4
 - Size.....4
 - Location X Y.....4
 - Add Square.....4
 - Last Operator Add Square.....4
 - Size.....4
 - Location X Y.....5
 - With existing mask.....5
 - Set Handle Type.....5
 - Last Operator Set Handle Type.....5
 - Type.....5
 - Switch Direction.....5
 - Toggle Cyclic.....5
 - Add Circle.....5
 - Last Operator Add Circle.....6
 - Size.....6
 - Location X Y.....6
 - Add Square.....6
 - Last Operator Add Square.....6
 - Size.....6
 - Location X Y.....6
 - Copy Splines.....6
 - Paste Splines.....6
 - Re-Key Shape Points.....6
 - Clear Feather Weight.....6
 - Reset Feather Animation.....6
 - Make Parent.....6
 - Clear Parent.....6
 - Delete.....7
- Quick Favorites menu.....7
- Slider snapping.....7

Hotkey only functionality.....7
Radial Control.....7
Set Handle Type - V.....8

Image Editor

In the Image Editor you can show and edit 2D Assets like textures or images. Images created or edited in the Image editor can also be used in the UV Editor and in the different Node Editors.

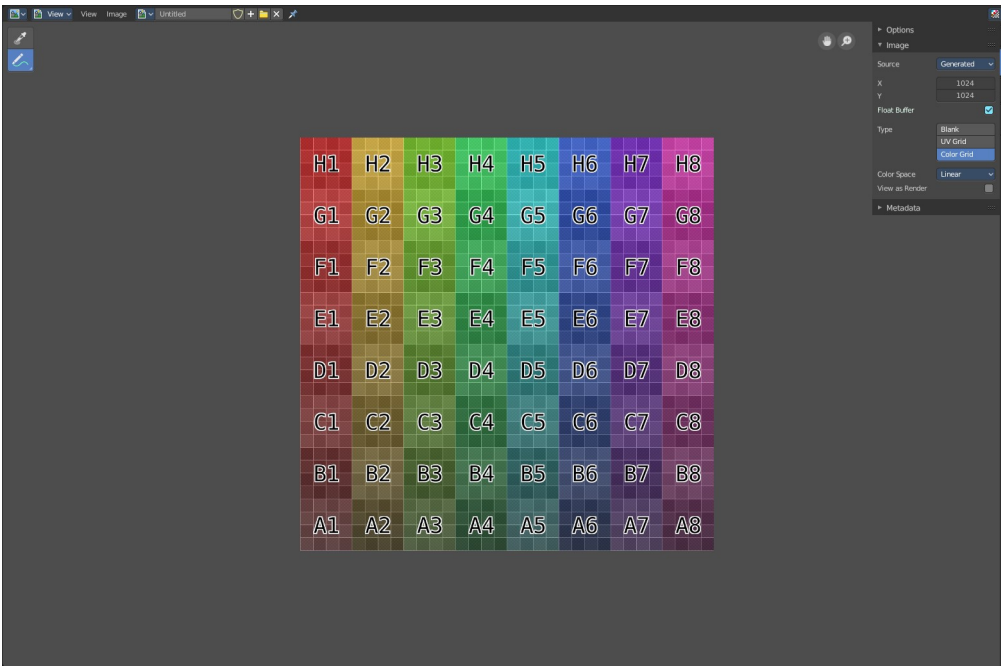

It is also the editor type in which the final renderings are displayed.

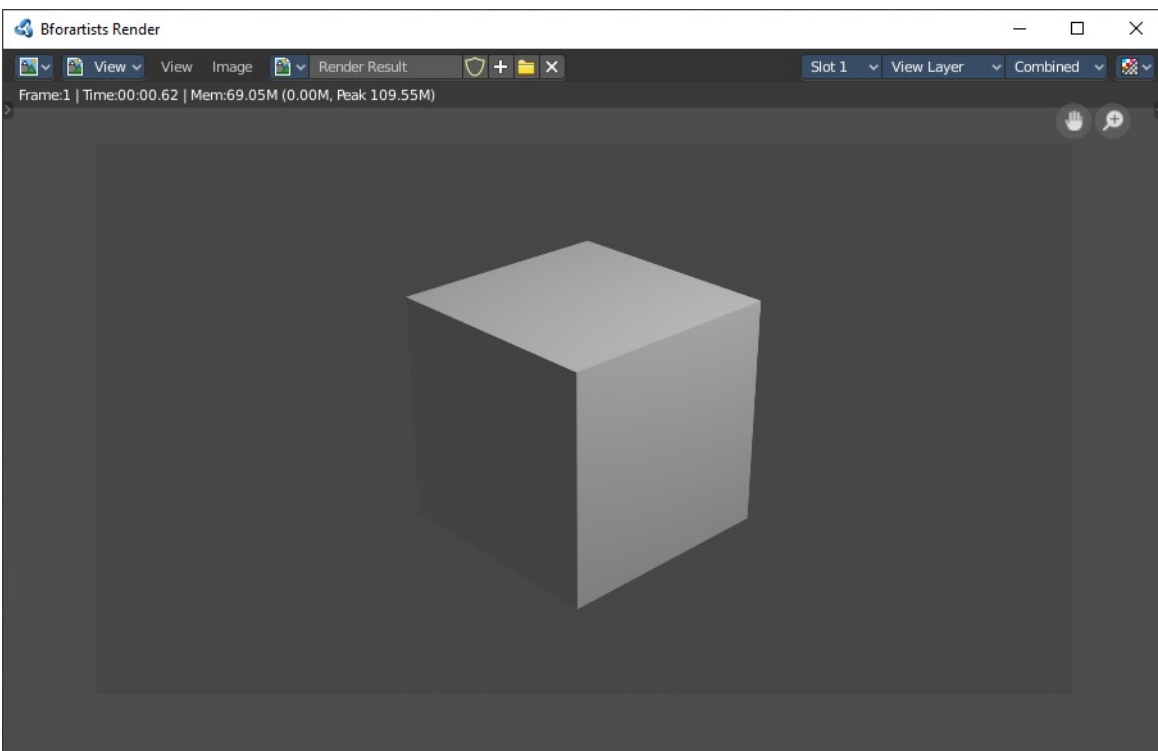

The Image editor is divided into several areas has several tool areas. Tool Settings Area, Viewport, Header, Tool Shelf and Sidebar.

The Tool Settings area contains the same functionality than the Tools tab in the Sidebar. So we won't cover it.

Navigating in the Image Editor viewport

The Viewport is the place where you view and edit your image content.

Hotkeys

Pan the view - MMB

Zoom - Mouse Wheel, LMB+CTRL, Numpad + / -

View All - Home

View Fit - Numpad Period

Navigation Elements

There are also two navigation elements for panning and zoom in the upper right corner. Click at them, hold the mouse button down, and move.

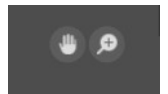

2D Cursor

In Mask mode you will see a 2D cursor. It is the center point for tool operations. And can be set with Alt + Right Mouse click.

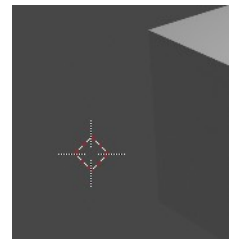

Viewport context menus

When you double right click into the viewport, then you will open a menu. Its content is to 100% double content to already existing menus. And it is despite the name not contextual.

There are two different menus. One in Paint mode. And one in Mask mode. The View mode has no right click menu.

Double right click in Paint mode

A double right click in paint mode opens a color picker with some further settings.

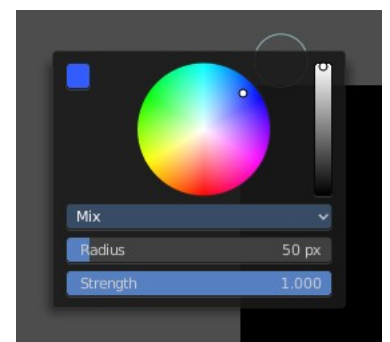

Blend Mode

Choose the blend mode for drawing.

Radius

The Brush radius.

Strength

The Brush strength.

Double right click in Mask mode

Without a mask

New Mask

Creates a new mask.

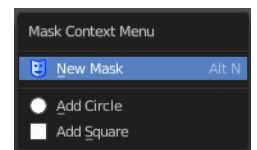

Last Operator New Mask

Name

Type in the name of the new mask.



Add Circle

Adds a circle shaped spline curve.

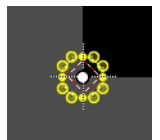

Last Operator Add Circle

Size

The size of the circle spline curve.

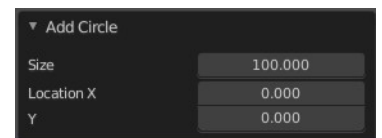

Location X Y

The location of the circle spline curve. Calculation happens from the center of the spline. 0 / 0 is down left.

Add Square

Adds a square shaped spline curve.

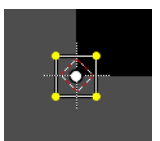

Last Operator Add Square

Size

The size of the square spline curve.



Location X Y

The location of the square spline curve. Calculation happens from the center of the spline. 0 / 0 is down left.

With existing mask

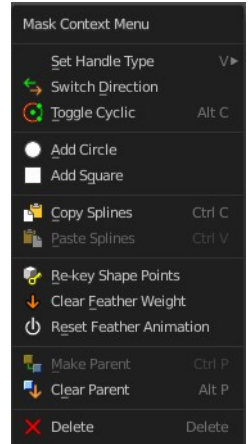

Set Handle Type

Opens a sub menu where you can choose different handle types.

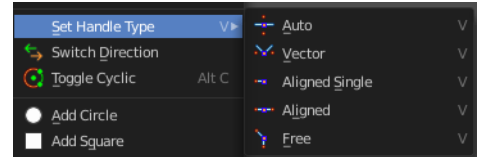

Last Operator Set Handle Type

Type

Choose the handle type again.

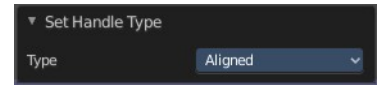

Switch Direction

A curve has a start point and an end point. Here you can switch them. The end point becomes the starting point and vice versa. As a consequence the handle can switch their location too. With handle type aligned single they can appear outside or inside of the circle.

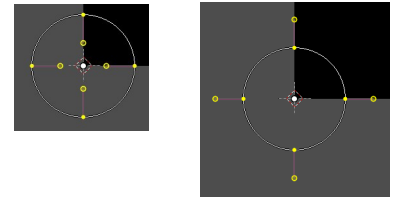

Toggle Cyclic

Closes or opens the spline.

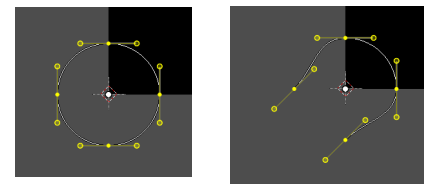

Add Circle

Adds a circle shaped spline curve.

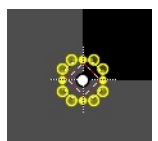

Last Operator Add Circle

Size

The size of the circle spline curve.

Location X Y

The location of the circle spline curve. Calculation happens from the center of the spline. 0 / 0 is down left.



Add Square

Adds a square shaped spline curve.

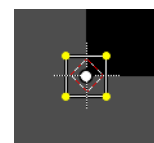

Last Operator Add Square

Size

The size of the square spline curve.

Location X Y

The location of the square spline curve. Calculation happens from the center of the spline. 0 / 0 is down left.



Copy Splines

Copy's the selected spline(s) or spline points.

Paste Splines

Pastes the copied spline(s) or spline points.

Re-Key Shape Points

Recalculate animation data for the currently selected curve points for frames that are selected in the dope sheet.

Clear Feather Weight

Resets the scale to its original dimensions.

Reset Feather Animation

Resets the feather weight on all selected curve points at the current frame.

Make Parent

Parents the selected spline points. Mask splines can be parented to motion tracker markers.

Clear Parent

Clears the parent relationship.

Delete

Deletes the selected spline(s) or spline points.

Quick Favorites menu

When you right click at a menu or a button, then a right click menu will open. Tools have usually a Add to Quick Favorites menu entry.

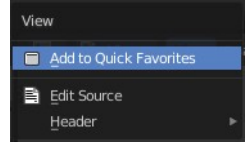

The Quick Menu is empty by default. With Add to Quick favorites you can add this menu to the Quick menu.

In the 3D view we have a menu called Quick in the header, which shows this content then. In the Image Editor you can just call it with its hotkey. Q. It has no regular menu entry here.

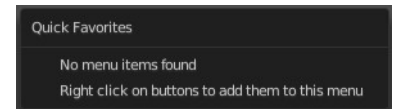

Slider snapping

Snapping also works at sliders. Hover with the mouse over the slider, start to slide, and holding down **Ctrl** will snap the sliders in incremental steps.



When it's a default value between 0 and 1 then it usually snaps in 0.1 steps. When it's a default value over 1 then it usually snaps in steps of 10.

Hotkey only functionality

Important! These hotkeys works with the default Bforartists key map And they do not list the N dof hotkeys. N dof is a 3d connexion mouse device that is also used for tablets.

Most of the tools can be found in the graphical UI. But there are still some tools that are hotkey only. Some have a UI brother with equal functionality. For example, Pick shortest path is the hotkey sister of Select shortest path. Some are hotkey only since they cannot be integrated in the graphical UI. Like calling the File menu under the mouse. Or mouse position dependent functionality like selecting an edge loop.

The navigation hotkeys and the context menus are excluded here since they are already covered.

Radial Control

In Paint modes you can set the strength or radius of the brush not only by the sliders. But also by hotkeys.

Sets the brush radius - F

Sets the brush strength - Shift F

Sets the brush direction - Ctrl F

Sets the brush direction - Ctrl Alt F

Set Handle Type - V

Mask mode with a mask primitive selected. Hotkey V Calls the set handle type menu.

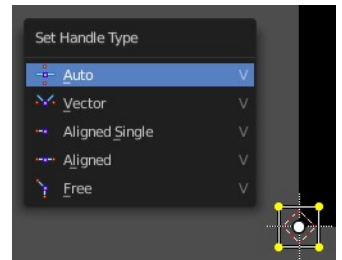



8.1 Editors - Image Editor - Header

Table of content

Image Editor - Header.....	1
Switch to UV / Image editor.....	1
Header right click menus.....	1
Editortype Menu.....	2
Sub Modes.....	2
View Mode.....	2
Paint Mode.....	2
Mask Mode.....	2

Image Editor - Header

The Header contains various menus, navigation elements, settings and tools for the viewport. This content differs, dependent of the sub mode.

The header is divided into two areas. Left mode and menus. Right settings.



Switch to UV / Image editor

Sometimes you want to switch from the UV Editor to the Image Editor. Or vice versa. To continue at the unwrap or to paint a texture.

This two editors are connected by a menu that allows exactly that. A button in each header that switches to the other editor.

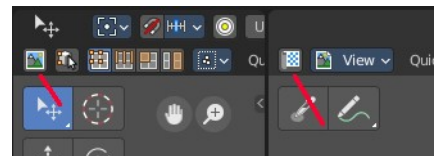

Header right click menus

The general right click menu functionality is explained in chapter 6 Editors introduction.

Editortype Menu

Bforartists is made of several editor types. Headers can display a menu where you can switch to other editor types.

This menu is hidden by default. It is meant to edit the layouts, and should not be necessary for regular work. You can reveal it in the header right click menu.

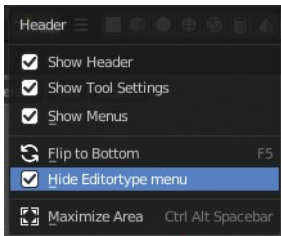
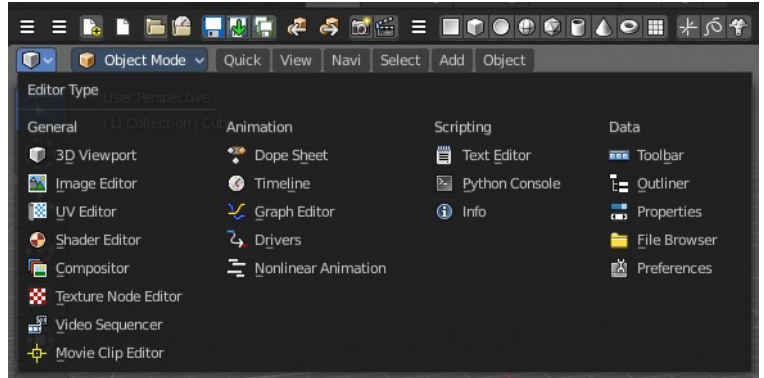

Sub Modes

The Image Editor has three sub modes. View, Paint and Mask.

View Mode

It is as the name says a pure view mode. You can view your content.

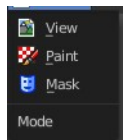

Paint Mode

Paint mode allows to paint at your image material. The Paint mode is not available when you have a render result selected. You cannot paint at a render result. The render result is a special kind of image in this regards.

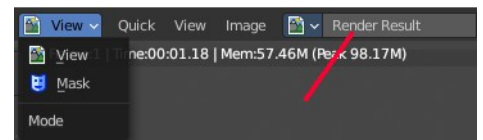

Mask Mode

This mode comes with masking functionality. You can mask out parts of the image.



8.1.1 Editors - Image Editor - Header - Header Tools and Options

Table of content

Image Editor - Header Tools.....	2
Image Prop.....	2
List of images in the scene.....	2
Image Edit Box.....	2
Fake User.....	3
Search form.....	3
New Image.....	3
Name.....	3
Width.....	3
Height.....	3
Color.....	3
Alpha.....	3
Generated Type.....	3
32 Bit Float.....	3
Duplicate.....	4
Unlink Datablock.....	4
Fake User.....	4
Open Image.....	4
Unpack.....	4
User.....	4
Use Image Pin.....	4
Display Channels.....	4
Color and Alpha.....	4
Color.....	4
Alpha.....	5
Red.....	5
Green.....	5
Blue.....	5
Mask Prop.....	5
List of Masks.....	5
Mask Edit Box.....	5
Fake User.....	5
Search form.....	5
Create Mask.....	6
Unlink Datablock.....	6
Show Overlays.....	6
Overlays settings.....	6
Image.....	6
Show Metadata.....	6
Mask Display.....	6
Smooth.....	6
Overlay.....	6
Edge Display Type.....	7
Slot.....	7
Layers.....	7
Pass.....	7
Combined.....	8

Depth.....	8
Show Stereo.....	8
View.....	8
Options Panel.....	8
In View and Mask mode.....	8
Update Automatically.....	8
Show Metadata.....	8
In Paint Mode.....	8
Update Automatically.....	8
Show Metadata.....	8
Display Texture Paint UV's.....	8
Show same material.....	9

Image Editor - Header Tools

The header contains several tools, depends on what you do and what toolset is selected. The render result has some additional functionality.

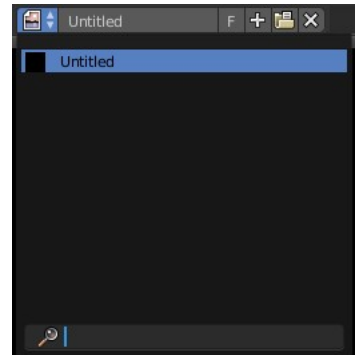

Image Prop

This property contains the list of loaded images. When no image is loaded then it displays the New and Open Buttons.



When an image exists then it displays the name of the currently selected image.



From left to right ...



List of images in the scene

This is a list of the images in the scene. This list allows you to switch to other images.

Image Edit Box

Read the name of the currently selected image. And you can rename the image here too.

Fake User

With this button you assign a fake user to this selected image.

Data, like images, that is not longer linked to anything else gets removed when you save and reload a scene. Bforartists has the concept of fake users to go around this behavior. An image with a fake user is in fact linked to something. And so it is not lost when you save and reload the scene.

Search form

Search for specific images.

New Image

Create a new image.

Creates a new image. You will get a dialog where you can define settings for the new image.

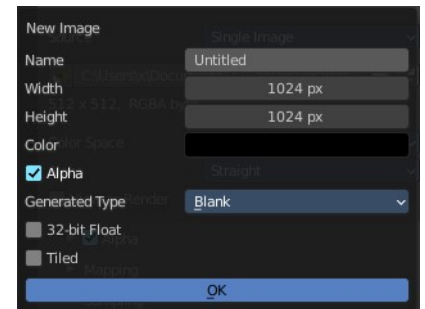

Name

The name of the new image

Width

The width of the new image.

Height

The height of the new image.

Color

Adjust the color of the new image. A click will call a color picker.

Alpha

Check this checkbox if the new image should have an alpha channel.

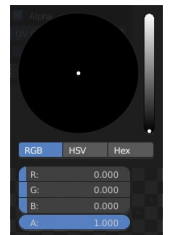

Generated Type

Here you can define what kind of texture you want to create.

Blank is one plain color.

UV Grid is a checker texture in black and white.

Color Grid is a colored checker texture.

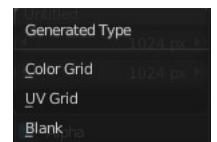

32 Bit Float

Check this checkbox if the image should be in 32 Bit floating point bit depth per channel. Else it is in 8 bit per channel.

Duplicate

Not supported here.

Unlink Datablock

This deletes the selected image. Unfortunately not immediately. You need to save the scene and to reload it.

And you need to make sure that it is not linked to anything else. A mesh or a fake user for example. Have a look if there is a number besides the F button. When this is the case then the image has still a user, and so still loads with loading the scene.

Fake User

With this button you assign a fake user to this selected image.

Data, like images, that is not longer linked to anything else gets removed when you save and reload a scene. Bforartists has the concept of fake users to go around this behavior. An image with a fake user is in fact linked to something. And so it is not lost when you save and reload the scene.

Open Image

Opens the file browser to load an image.

Unpack

Unpack packed files to a directory.

User

The number of users that uses this data. Data with a user number of 0 will be removed with closing Bforartists.

Use Image Pin



When you select another object. for UV mapping for example, then usually the connected images for this object gets displayed. Use image pin nails the currently selected image so that it stays displayed.

Display Channels

Adjust what channels of the image gets displayed.

Color and Alpha

Displays the whole image, including alpha channel.

Color

Displays the whole image, but without alpha channel.

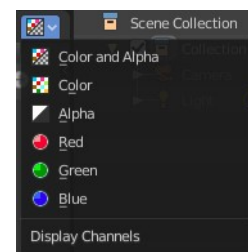

Alpha

Displays the alpha channel of the image.

Red

Displays the red channel of the image.

Green

Displays the green channel of the image.

Blue

Displays the blue channel of the image.

Mask Prop



When you are in Mask mode then you can create a new mask, and work with this mask then.

Masks have many purposes. They can be used to mask out, or influence a particular object in the footage in Motion tracking. They can be used for manual rotoscoping to pull a particular object out of the footage. They can be used as a rough matte for green-screen keying.

Masks are independent from a particular image of movie clip, and so they can also be used for creating motion graphics or other effects in the compositor.

Masks can be driven over the time so that they follow some object from the footage. For example a running actor. This can be achieved with shape keys or parenting the mask to tracking markers.

List of Masks

This is a list of the masks in the scene. Here you can switch to other masks.

Mask Edit Box

Read the name of the currently selected mask. And you can rename the image mask too.

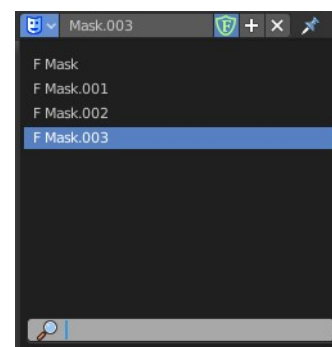

Fake User

With this button you assign a fake user to this selected mask. Masks gets created with a fake user already. Means when you save the scene and reopen it, then this mask will still be there.

Data, like images, that is not longer linked to anything else gets removed when you save and reload a scene. Bforartists has the concept of fake users to go around this behavior. An image with a fake user is in fact linked to something. And so it is not lost when you save and reload the scene.

Search form

Search for specific images.

Create Mask

Adds a new mask.

Unlink Datablock

This deletes the selected mask. Unfortunately not immediately. You need to save the scene and to reload it.

And you need to make sure that it is not linked to anything else. A mesh or a fake user for example. Have a look if there is a number besides the F button. When this is the case then the image has still a user, and so still loads with loading the scene.

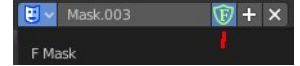

Show Gizmos

Display the viewport gizmos.

Navigate

Display the navigation gizmos in the Image Editor

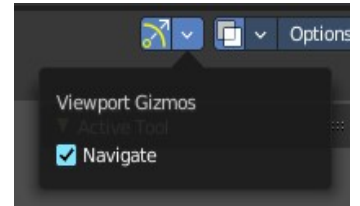

Show Overlays

Display the overlays in the viewport.

Overlays settings

Image

Show Metadata

Display existing metadata in the viewport.

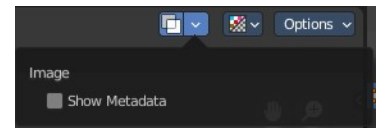

Mask Display

In Mask mode and with a Render result. Adjust the display of the mask.

Smooth

Smoothens the outline of the mask curve.

Overlay

When it's a closed curve then this closed area gets displayed as filled where it covers the image. When you tick Overlay then the drop down box becomes active where you can choose the overlay method.

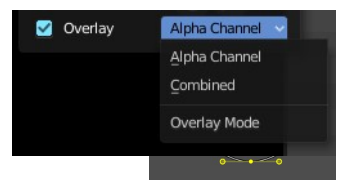
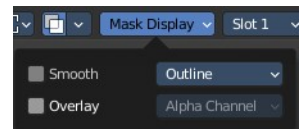

Edge Display Type

The mask curve can be displayed in different styles.

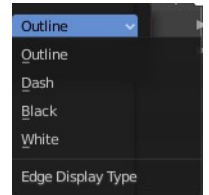

Slot

Just with a render result. Here you can render a new image into a new slot, which allows you to compare the two images then.

You need to render into this slot. So you need to choose it beforehand. Slots without a render result does not show the Render and Pass drop down boxes.

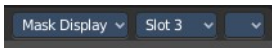

Layers

Here you can choose in which layer the render result is.

Renders can be separated into layers. This allows you to composite them back together afterwards.

For example blurring the background and foreground layers separately for depth of field, or rendering different lighting variations of the same scene.

Using View Layers can also save you from having to re-render your entire image each time you change something, allowing you to instead re-render only the layer(s) that you need.

You can create more View Layers in the Properties editor. In the View Layer Tab.

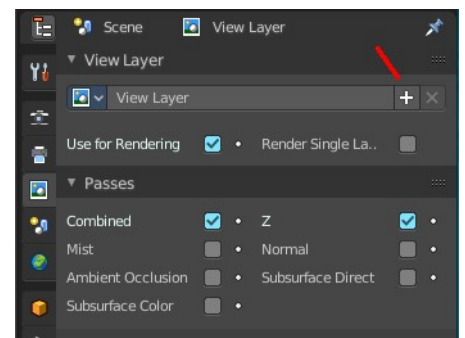
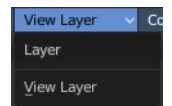

Pass

Here you can set the pass mode. Combined or Depth.

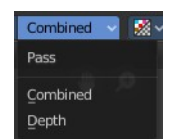

Combined

The final combination of render passes with everything included.

Depth

Just the Depth render pass.

Show Stereo

Just with stereoscopy enabled. Shows either the stereoscopic image. Or a single image from one of the cameras.

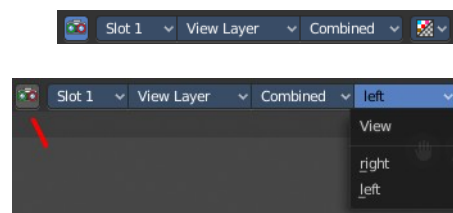

View

Show the image from one of the cameras in the list.

Options Panel

In View and Mask mode

Update Automatically

Update other editor windows simultaneously with the changes in the Image Editor.

Show Metadata

Draw Metadata properties of the image.

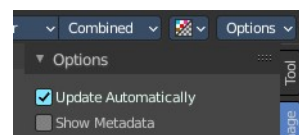

In Paint Mode

Update Automatically

Update other editor windows simultaneously with the changes in the Image Editor.

Show Metadata

Draw Metadata properties of the image.

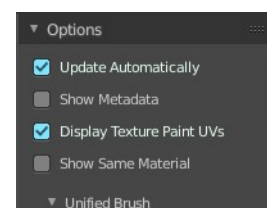

Display Texture Paint UV's

Display the UV wire from the active mesh. It needs to be in edit mode.

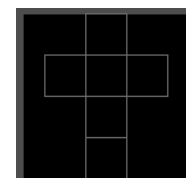

Show same material

This is for the case that you work at a texture for the current mesh. Just show faces of the mesh where the material with this texture is assigned to.



8.1.2 Editors - Image Editor - Header - Quick Menu

Table of content

Quick Menu.....	1
Adding an operator to the Quick menu.....	1
Adding a menu to the Quick menu.....	1
Order.....	2
Removing an operator from the Quick menu.....	2
Context and mode dependent content.....	2

Quick Menu

The quick menu, or in long Quick Favorites menu, is a menu that can be customized to your needs. Here you can add operators for quick access.

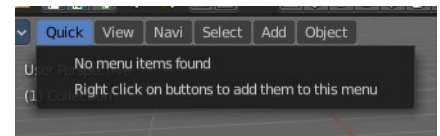

It is located in the header. But it can be called by hotkey Q directly under the mouse. This hotkey works in other editors too.

When the menu is empty, then you will see the message "No Menu Items found". This means that you first have to add some tools to the menu. It is a user configurable menu.

Note that added operators in this menu does not have icons. Just text.

Note also that the Quick menu for the Image editor shares the content with the Quick menu from the UV editor.

Adding an operator to the Quick menu

Open the panel or the menu where your operator is that you want to add.

Let's add the open command from the File menu. Open the File menu, right click at open, and choose Add to Quick Favorites.

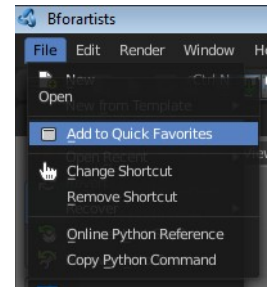

Do the same with Save As. We should now have two new menu items in the Quick menu, which you can use now.

As a rule of thumb, when the right click menu has an Add to Quick Favorites, then you can add it to the quick menu.

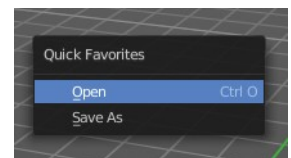

Note that you can also add operators from the tool shelf at the left. And also operators from other editor types. Some other editors have their own quick menu though. The Image Editor for example. These operators gets added in the quick menu of the image editor then. And does not show in the quick menu in the header of the 3D view.

Adding a menu to the Quick menu

It is also possible to add a menu to the Quick menu. For example the whole Add menu. The way is the same. Right click at it, and choose Add to Quick Favorites.

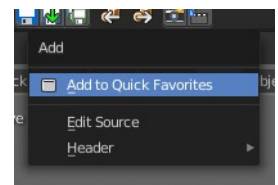

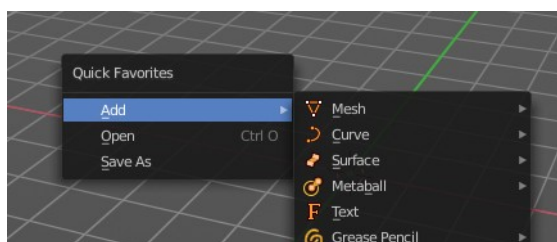

Order

You might notice that the add menu adds at the top of the menu, and not at the bottom as you would expect. First comes menus, then comes operators. And they get added in the order in which you add them.

Besides that, operators and menus gets added in the order that you add them. They cannot be sorted afterwards. So be careful how you add them. You can of course always remove operators and menus, and re-add them at the end of the list.

Removing an operator from the Quick menu

Removing is as simple as adding. Right click at the operators in the Quick menu, and choose Remove from Quick favorites.

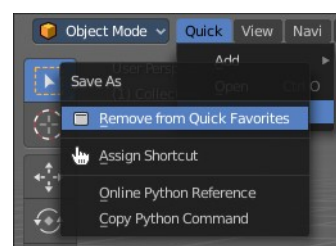

Context and mode dependent content

The quick favorites. menu exists in nearly all editors. But it is just in the 3D view available in the header. So that you know this functionality exists. In the other editors you call it with hotkey Q.

The content of the quick favorites. menu changes, dependent over which editor you are, and in what mode you are. When you add for example an operator from the image editor, then this operator just shows in the quick menu when you call the menu from the image editor. Same goes for the modes. Edit mode tools will just show in edit mode. And so on.



8.1.3 Editors - Image Editor - Header - View menu

Table of content

Image Editor - View Menu.....	2
Toolbar.....	2
Sidebar.....	2
Tool Settings.....	2
Adjust Last Operation.....	2
Set 2D Cursor.....	3
Annotations (Legacy).....	3
Draw Annotation.....	3
Draw Line Annotation.....	3
Draw Polyline Annotation.....	3
Erase Annotation.....	3
Add Annotation Layer.....	3
Erase Annotation Active Keyframe.....	3
Zoom In.....	3
Zoom Out.....	3
Zoom Border.....	4
Fractional Zoom.....	4
Frame All.....	4
View Fit.....	4
Render Region.....	4
Clear Render Region.....	4
Render Slot Cycle Next.....	4
Render Slot Cycle Previous.....	4
Center View to Cursor.....	4
Area.....	5
Horizontal Split.....	5
Vertical Split.....	5
Duplicate Area into New Window.....	5
Toggle Maximize Area.....	5
Toggle Full screen Area.....	5
Close Area.....	5
Pie menus.....	5

Image Editor - View Menu

The View menu contains all View related tools.

It is available in all sub modes. With a render result the view image shows a different content. And in mask mode it shows one more item. Set 2D cursor.

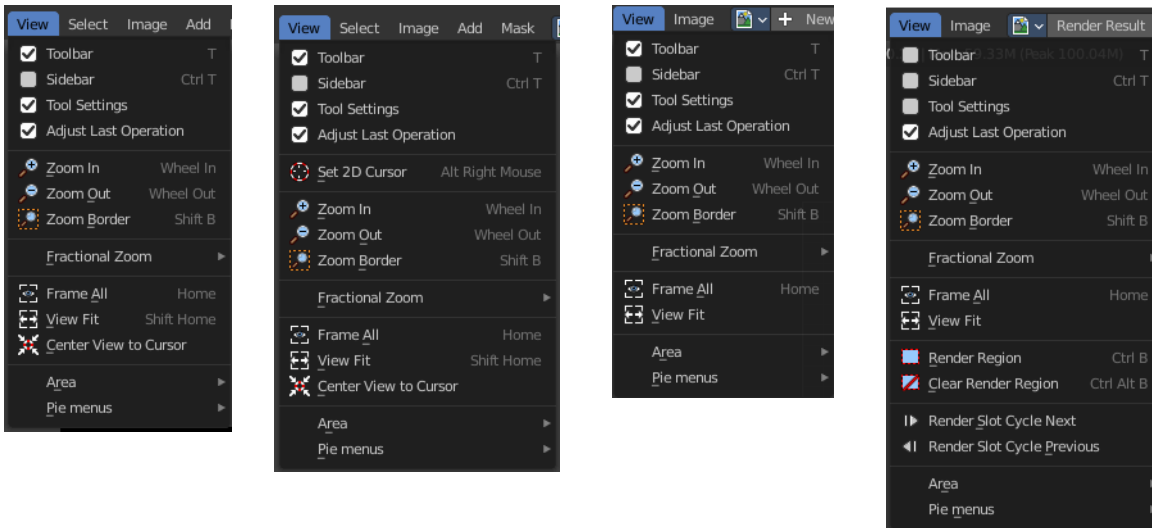

Toolbar

Shows or hides the toolbar at the left.



Sidebar

Shows or hides the sidebar at the right in the viewport.



Tool Settings

Shows or hides the tool settings above the header in the 3D view.

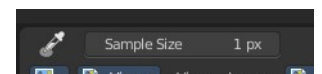

Adjust Last Operation

Shows or hides the Adjust Last Operation panel down left.



Note that the Adjust Last Operation menu item in the Edit menu in the main header and the Last button in the toolbar are not related and not functional with this last operator panel. It is an independent element.

Set 2D Cursor

Mask mode only. Set the 2D cursor position. Hotkey only tool! Please use the hotkey!

Annotations (Legacy)

This group of operators is useful to take notes without changing tool-shelf operators. These notes can be colored in the View tab of the Property Shelf. Each layer is a single color. You can also animate the notes with keyframes, editable in the dopesheet.

Note: *These are legacy operators, meaning they are equally available in the Toolshelf as a modal operator.*

Draw Annotation

Starts the annotation free hand draw tool in the editor.

Draw Line Annotation

Starts the annotation line draw tool to draw straight lines in the editor.

Draw Polyline Annotation

Starts the annotation Polyline draw tool in the editor which allows to draw multiple connected straight lines in the editor.

Erase Annotation

Starts the annotation erase tool in the editor which erases any strokes in the editor.

Add Annotation Layer

Starts a new annotation layer.

Erase Annotation Active Keyframe

Erases the active keyframe of the annotation.

Zoom In

Zooms into the viewport.

Zoom Out

Zooms out of the viewport.

Zoom Border

Draws a rectangle and zooms then to fit the size of this rectangle.

Zooming in is done with drawing the rectangle with left mouse button. Zooming out is done with drawing the rectangle with middle mouse button.

Fractional Zoom

A sub menu where you can choose between predefined zoom factors.

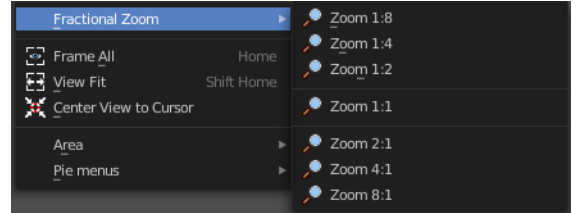

Frame All

Zooms in or out in the viewport until all objects in the scene are displayed fitting in the viewport.

View Fit

Zooms out or in to fit the image to the viewport.

Render Region

Render result only. Allows you to draw a rectangle. And when you re-render the image, just the content in this rectangle region gets rendered.

This tool does, different from the 3d view, not draw a permanent red rectangle to define the render region area. You will see what you have chosen when you render the image.

Clear Render Region

Render result only. Removes any existing render region rectangle.

Render Slot Cycle Next

Render result only. Cycle through the Render slots.

Render Slot Cycle Previous

Render result only. Cycle through the Render slots.

Center View to Cursor

Mask Mode only. Center the view to the 2D cursor.

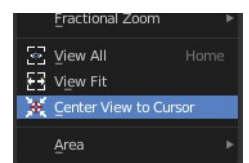

Area

This menu contains general view functionality. And exists in most other editor types too.

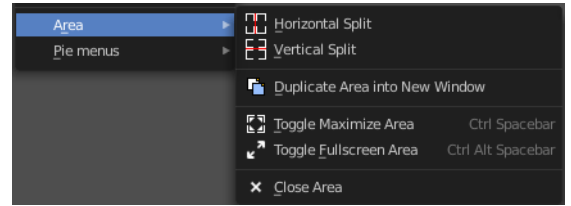

Horizontal Split

Splits the current view horizontally into two independent editor windows.

Vertical Split

Splits the current view vertically into two independent editor windows.

Duplicate Area into New Window

Duplicate Area into New Window makes the selected editor window floating. You can then drag it around at the monitor. It is not connected with the rest of the UI any more.

A separated window cannot be merged into the main window again. You have to close it when not longer needed.

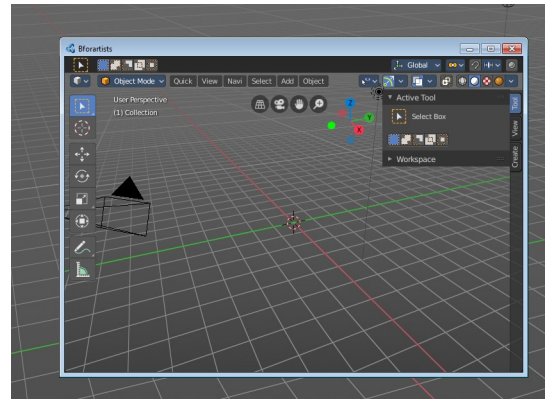

Toggle Maximize Area

Displays the editor maximized with menus.

To return from the maximized view press hotkey ctrl + spacebar. Or reuse the menu item in the area menu.

Toggle Full screen Area

Displays the editor maximized without menus.

To return from the full screen view press hotkey ctrl + alt + spacebar.

Close Area

Closes the area window.

Pie menus

Lists the available pie menus, and gives you the ability to read the hotkeys and assign own hotkeys.





8.1.4 Editors - Image Editor - Header - Image menu

Table of content

Image Editor - Image Menu.....	2
New.....	2
Name.....	2
Width.....	2
Height.....	2
Colour.....	2
Alpha.....	2
Generated Type.....	2
32 Bit Float.....	3
Open Image.....	3
Open Cached Render.....	3
Copy.....	3
Paste.....	3
Replace Image.....	3
Reload Image.....	3
Edit Externally.....	4
Save Image.....	4
Save As Image.....	4
Save Copy.....	4
Save all Images.....	4
Invert.....	4
Resize.....	4
Flip.....	4
Horizontally.....	4
Vertically.....	4
Pack Image / Pack as PNG.....	4
Extract Palette.....	5
Generate Grease Pencil.....	5

Image Editor - Image Menu

The Image menu contains the load and save functionality.

It is available in all sub modes. But not all content shows in all combinations.

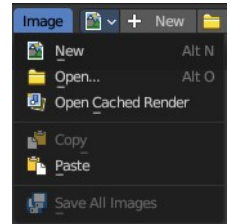
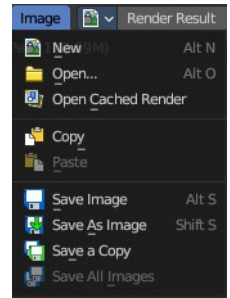
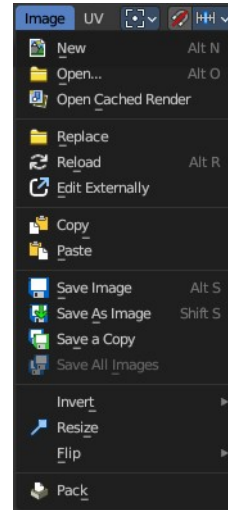

New

Creates a new image. You will get a dialogue where you can define settings for the new image.

Name

The name of the new image

Width

The width of the new image.

Height

The height of the new image.

Colour

Adjust the colour of the new image. A click will call a colour picker.

Alpha

Check this checkbox if the new image should have an alpha channel.

Generated Type

Define what kind of texture you want to create.

Blank is one plain colour.

UV Grid is a checker texture in black and white.

Colour Grid is a coloured checker texture.

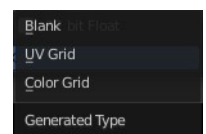
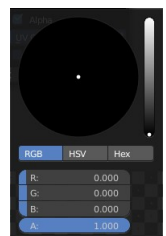
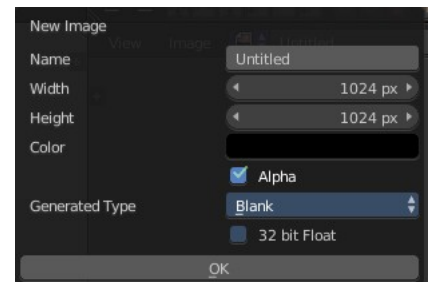

32 Bit Float

Check this checkbox if the image should be in 32 Bit floating point bit depth per channel. Else it is in 8 bit per channel.

Open Image

Opens the file browser to load an image.

Open Cached Render

To get it to work you need to have Cycles as the renderer selected. This feature does not work with Eevee or Workbench renderer.

Read all the current scene's render layers from cache, as needed. For this feature to work save Buffers needs to be activated in the Performance tab in the render settings.

This feature can be used to save RAM while rendering because the render layers do not have to be saved in RAM. It can also be used to recover some information from a fail render.

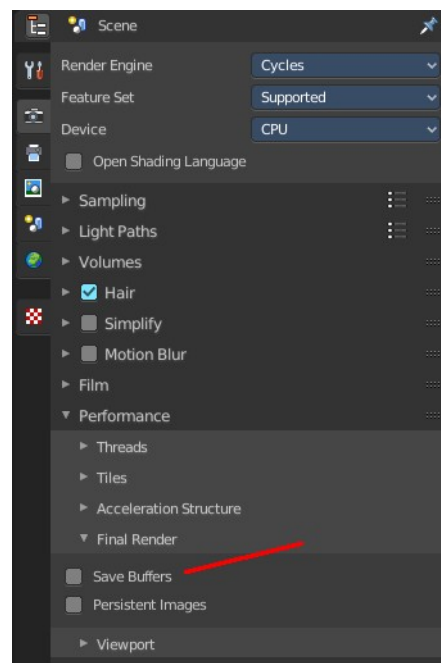

Copy

Copy the image to the clipboard.

Paste

Paste an image from the clipboard.

Replace Image

Replaces the currently active image by an image that you load.

Reload Image

Reloads the currently selected image.

Note that the images must already exist somewhere at your hard disk. When you create a new image in Bforartists, then this image isn't saved yet, and so you cannot reload it.

Edit Externally

Open the image in a defined external image editor like The Gimp or Photoshop.

The image must be saved. And the image editor must be defined in the User Preferences.

Save Image

Saves the currently selected image without any further questions. Note that the images must already exist somewhere at your hard disk.

Save As Image

Saves the currently selected image.

Save Copy

Saves a copy of the currently selected image. This will save the file to a specified name, but will keep the old one open in the Image editor.

Save all Images

Saves all images.

Note that the images must already exist somewhere at your hard disk so that they can be saved. The item is greyed out as long as the image is not saved to disk.

Invert

Invert is a sub menu where you can invert the colours of the whole image, or just specific colours.

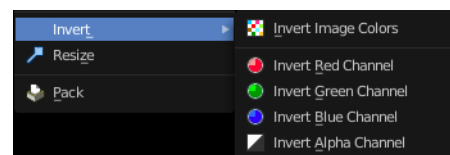

Resize

Allows you to change the dimensions of the image. The tool calls a resize panel.

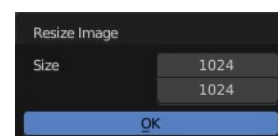

Flip

Horizontally

Flip horizontally flips the image horizontally along the Y axis.

Vertically

Flip vertically flips the image vertically along the x axis.



Pack Image / Pack as PNG

Packs the currently active image into the blend file. When you save the blend file the next



time, then this image will be embedded. The Pack menu item turns into an Unpack menu item with packed textures.

Packed images are marked with a pack icon. A click at this icon will unpack the texture, and try to save it to file. Usually to the last existing location before it was packed.



Warning

You cannot modify packed images. Changes at the image will not be saved. You need to unpack the image when you want to modify it. And repack it after you have done the changes.

Extract Palette

Allows you to extract a color palette from a loaded image. The result can then be found in the Color Palette panel in the Tools tab in the sidebar with the correct object and being in the right mode. Like with a mesh object in Vertexpaint Mode.

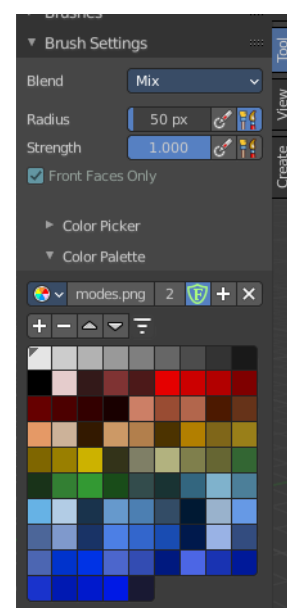

Generate Grease Pencil

Generates a Grease Pencil object from the image.



8.1.5 Editors - Image Editor - Header - Select menu

Table of content

Image Editor - Select menu.....	1
All.....	1
None.....	1
Inverse.....	1
Box Select.....	1
Circle Select.....	2
Lasso Select.....	2
Linked.....	2
More.....	2
Less.....	2

Image Editor - Select menu

This menu just appears when you are in Mask mode. And you need to create a new mask layer to set all items active. The select functionality in this menu covers the mask geometry. The splines.

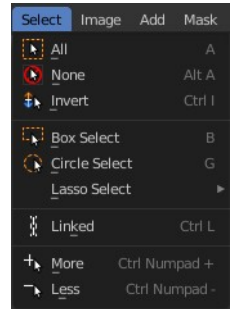

All

Toggles between select all and deselect all.

None

Select nothing.

Inverse

Inverts the current selection.

Box Select

Border select enters the Border Select mode. This is a special select mode where you can select elements by dragging a rectangle. And what's inside of the rectangle gets selected then. It adds to selection by default.

To subtract from selection hold down Shift key.

The selection gets applied when you release the mouse. You leave the mode automatically when you release the mouse.

Circle Select

Circle select enters the Circle Select mode. This is a special select mode where you can select elements by moving with the mouse over it. It adds to selection by default.

To subtract from selection hold down Shift key. To exit the Circle select click with the right mouse button.

The pencil radius of the circle select tool can be adjusted with the scroll wheel.

Lasso Select

A sub menu with the available lasso select modes.

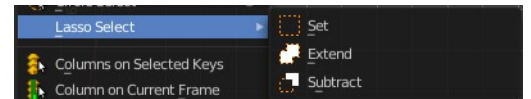

Linked

Select all vertices linked to the active spline(s). The previous selection gets cleared.

More

Select more from the current active spline(s).

Less

Select less from the current active spline(s).



8.1.6 Editors - Image Editor - Header - Add menu

Table of content

Image Editor - Add menu.....	1
Circle.....	1
Last Operator Add Circle.....	1
Size.....	1
Location X Y.....	1
Square.....	2
Last Operator Add Square.....	2
Size.....	2
Location X Y.....	2
Vertex Slide.....	2
Last Operator Add Vertex and Slide.....	2
Location X / Y.....	2
Feather vertex slide.....	2
Last Operator Add Feather Vertex and Slide.....	3
Location X / Y.....	3

Image Editor - Add menu

This menu just appears when you are in Mask mode.

In this menu you can create circle or square spline curves to use them for masking. They appear at the 2D cursor, and have four handlers.

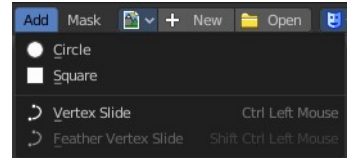

They can be moved, rotated and resized with the usual W E R keys. See also mask menu, Transform. The handlers allows to change the shape and size too.

You can add multiple spline curves to a mask layer.

Circle

Adds a circle shaped spline curve.

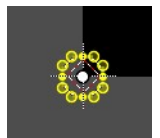

Last Operator Add Circle

Size

The size of the circle spline curve.

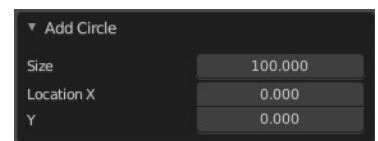

Location X Y

The location of the circle spline curve. Calculation happens from the center of the spline. 0 / 0 is down left.

Square

Adds a square shaped spline curve.

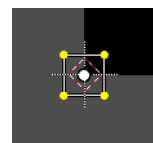

Last Operator Add Square

Size

The size of the square spline curve.

Location X Y

The location of the square spline curve. Calculation happens from the center of the spline. 0 / 0 is down left.

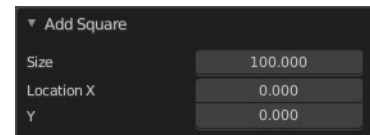

Vertex Slide

Allows you to draw freehand curves by holding down shift and clicking into the viewport. Hotkey only functionality!

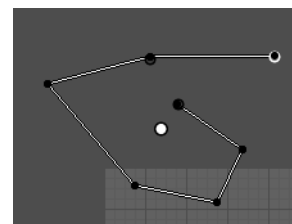

Last Operator Add Vertex and Slide

Location X / Y

Adjust the location of the last created curve point.



Feather vertex slide

Create and define a feathering outline curve.

Usage: Hold down shift + control, click at a vertex, and pull outwards. This will create the feathering outline curve, displayed in green.

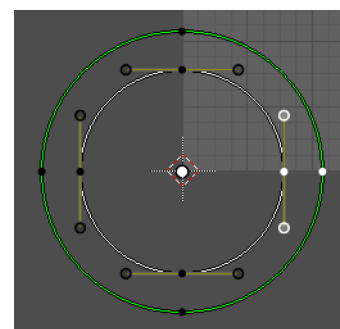

Last Operator Add Feather Vertex and Slide

Location X / Y

Adjust the location of the last created feather curve point.

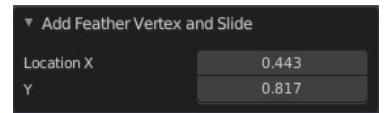



8.1.7 Editors - Image Editor - Header - Mask menu

Table of content

Image Editor - Mask menu.....	2
Delete.....	2
Duplicate.....	2
Toggle Cyclic.....	2
Switch Direction.....	2
Recalc Normals.....	2
Set Handle Type.....	3
Last Operator Set Handle Type.....	3
Type.....	3
Clear Parent.....	3
Make Parent.....	3
Copy Splines.....	3
Paste Splines.....	3
Show/Hide.....	3
Show/Hide Faces.....	3
Show Hidden.....	3
Hide Selected.....	3
Hide Unselected.....	3
Transform.....	4
Translate.....	4
Last Operator Move.....	4
Values.....	4
Axis Ortho.....	4
Orientation.....	4
Proportional Editing.....	4
Proportional Editing Falloff.....	4
Proportional size.....	4
Connected.....	4
Projected (2D).....	4
Rotate.....	5
Last Operator Rotate.....	5
Angle.....	5
Axis.....	5
Orientation.....	5
Proportional Editing.....	5
Proportional Editing Falloff.....	5
Proportional size.....	5
Connected.....	5
Projected (2D).....	5
Scale.....	5
Last Operator Resize.....	5
Scale X Y Z.....	5
Orientation.....	6
Proportional Editing.....	6
Proportional Editing Falloff.....	6
Proportional size.....	6
Connected.....	6

Projected (2D).....	6
Scale Feather.....	6
Last Operator Transform.....	6
Values.....	6
Axis.....	7
Orientation.....	7
Proportional Editing.....	7
Proportional Editing Falloff.....	7
Proportional size.....	7
Connected.....	7
Projected (2D).....	7
Clear Feather Weight.....	7
Animation.....	7
Insert Shape Key.....	7
Clear Shape Key.....	7
Feather Reset Animation.....	8
Re-Key Points of Selected Shapes.....	8

Image Editor - Mask menu

This menu appears when you are in Mask mode. It contains further functionality to modify the masking spline curves.

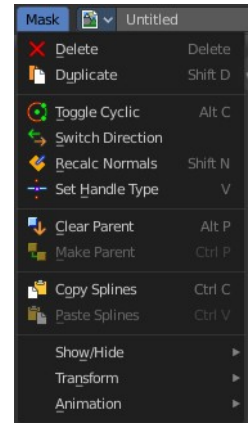

Delete

Deletes the selected spline(s) or spline points.

Duplicate

Deletes the selected spline(s) or spline points.

Toggle Cyclic

Closes or opens the spline.

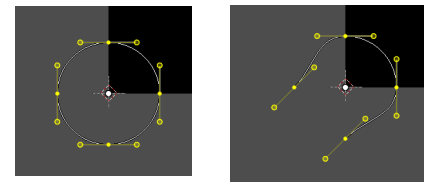

Switch Direction

A curve has a start point and a end point. Here you can switch them. The end point becomes the starting point and vice versa. As a consequence the handler can switch their location too. With handle type aligned single they can appear outside or inside of the circle.

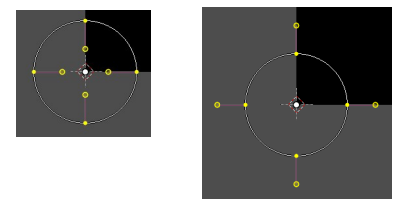

Recalc Normals

Recalculating the normals smoothens out the curve, and realigns the handlers. A

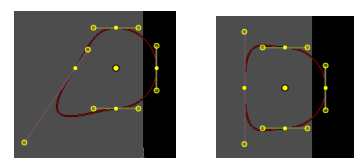

square shape with handle type aligned would become round.

Set Handle Type

Opens a sub menu where you can choose different handle types.

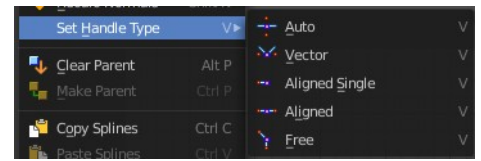

Last Operator Set Handle Type

Type

Choose the handle type again.

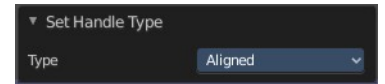

Clear Parent

Clears the parent relationship.

Make Parent

Parents the selected spline points. Mask splines can be parented to motion tracker markers.

Copy Splines

Copy the selected spline(s) or spline points.

Paste Splines

Pastes the copied spline(s) or spline points.

Show/Hide

Show/Hide Faces

This is a sub menu where you can show or hide the selection.



Show Hidden

Makes hidden splines visible again.

Hide Selected

Hides the selected spline(s).

Hide Unselected

Hides the not selected spline(s). The selected spline(s) stays visible.

Transform

This is a sub menu with some transform menu items. This menu items are hotkey tools!

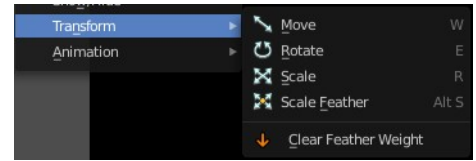

Translate

Move the selection.

Last Operator Move

Values

Adjust the move amount.

X, Y and Z defines the position.

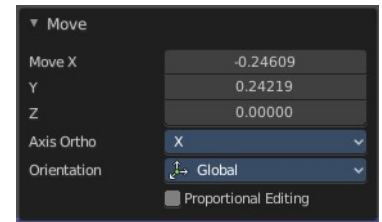

Axis Ortho

Along which axis to move

Orientation

Orientation is a drop-down box where you can choose the type of orientation for the transform action.

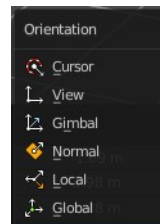

Proportional Editing

Proportional Editing is a drop-down box where you can choose to use proportional editing. When you choose one of the active methods then the neighbor geometry gets influenced too in a proportional way.

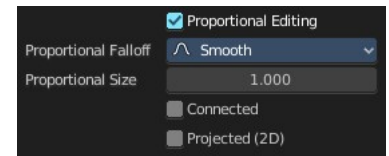

Proportional Editing Falloff

Proportional Editing Falloff is a drop-down box where you can choose a method for the falloff for the proportional editing.

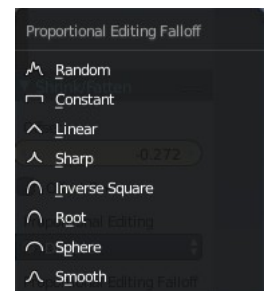

Proportional size

Proportional size is a edit box where you can adjust the strength of the Proportional falloff.

Connected

Just edit geometry that is directly connected with the current selection. 4 Bforartists 2 Reference Manual - 7.1.4 Editors - 3D View - Header - Navigation Menu

Projected (2D)

Edit geometry that is in 2d space aligned with the current selection. This one goes from the current view in depth direction.

Rotate

Rotate the selection.

Last Operator Rotate

Angle

Adjust the angle.

Axis

Along which axis to rotate

Orientation

Orientation is a drop-down box to choose the type of orientation for the transform action.

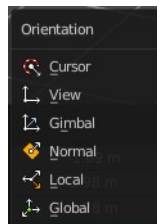
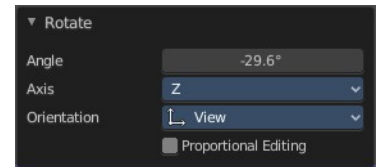

Proportional Editing

Proportional Editing is a drop-down box where you can choose to use proportional editing. When you choose one of the active methods then the neighbor geometry gets influenced too in a proportional way.

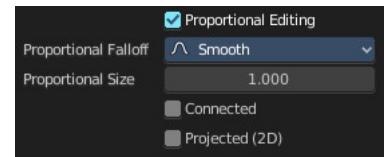

Proportional Editing Falloff

Proportional Editing Falloff is a drop-down box where you can choose a method for the falloff for the proportional editing.

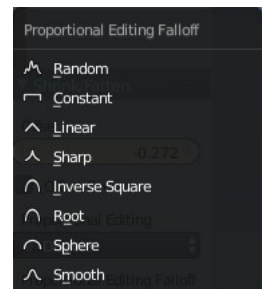

Proportional size

Proportional size is a edit box to adjust the strength of the Proportional falloff.

Connected

Just edit geometry that is directly connected with the current selection. 4 Bforartists 2 Reference Manual - 7.1.4 Editors - 3D View - Header - Navigation Menu

Projected (2D)

Edit geometry that is in 2d space aligned with the current selection. This one goes from the current view in depth direction.

Scale

Scale the selection.

Last Operator Resize

Scale X Y Z

Adjust the scaling.

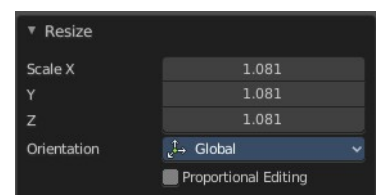

Orientation

Orientation is a drop-down box to choose the type of orientation for the transform action.

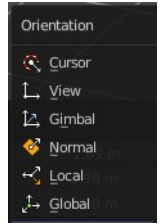

Proportional Editing

Proportional Editing is a drop-down box where you can choose to use proportional editing. When you choose one of the active methods then the neighbor geometry gets influenced too in a proportional way.

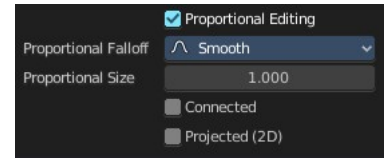

Proportional Editing Falloff

Proportional Editing Falloff is a drop-down box where you can choose a method for the falloff for the proportional editing.

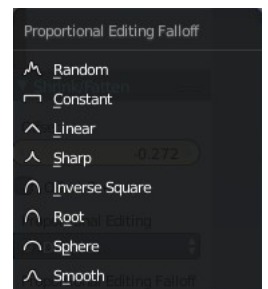

Proportional size

Proportional size is a edit box to adjust the strength of the Proportional falloff.

Connected

Just edit geometry that is directly connected with the current selection. 4 Bforartists 2 Reference Manual - 7.1.4 Editors - 3D View - Header - Navigation Menu

Projected (2D)

Edit geometry that is in 2d space aligned with the current selection. This one goes from the current view in depth direction.

Scale Feather

Scale feather weight for the selected points.

The curve type that is used to create mask splines is almost a Bezier curve. But it has some differences. Smooth edges of the mask are defined by feathering. The curve needed to support feathering in a way that stuck to the curve as you edited it, for ease of editing an animation. These are called S-Curves.

Besides the handles, every control point also has points that define the feather between the current point and the next point on the spline. Each feather point is stored in UV space, where U means position across spline segment, and V means distance between main spline and feather points.

Last Operator Transform

Values

Adjust the scale amount.

X, Y and Z defines the position. W defines the rotation.

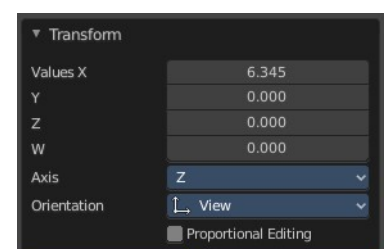

Axis

Around which axis to rotate. X, Y or Z.

Orientation

Orientation is a drop-down box to choose the type of orientation for the transform action.

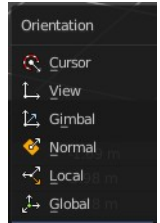

Proportional Editing

Proportional Editing is a drop-down box where you can choose to use proportional editing. When you choose one of the active methods then the neighbor geometry gets influenced too in a proportional way.

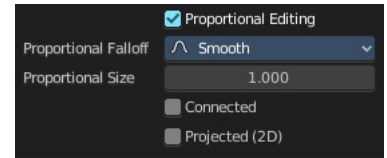

Proportional Editing Falloff

Proportional Editing Falloff is a drop-down box where you can choose a method for the falloff for the proportional editing.

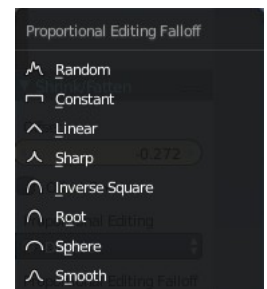

Proportional size

Proportional size is a edit box to adjust the strength of the Proportional falloff.

Connected

Just edit geometry that is directly connected with the current selection. 4 Bforartists 2 Reference Manual - 7.1.4 Editors - 3D View - Header - Navigation Menu

Projected (2D)

Edit geometry that is in 2d space aligned with the current selection. This one goes from the current view in depth direction.

Clear Feather Weight

Resets the scale to its original dimensions.

Animation

Masks can be animated.

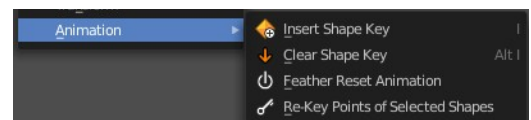

Insert Shape Key

Inserts a shape key for the currently selected curve points

Clear Shape Key

Removes the shape keys for the currently selected curve points at the current frame.

Feather Reset Animation

Resets the feather weight on all selected curve points at the current frame.

Re-Key Points of Selected Shapes

Recalculate animation data for the currently selected curve points for frames that are selected in the dope sheet.



8.2 Editors - Image Editor - Tool Shelf

Table of content

Tool Shelf in View Mode.....	1
Sample.....	2
Annotate Tools group.....	2
Annotate.....	2
Tool Settings.....	2
Color.....	2
Stabilize Stroke.....	2
Radius.....	2
Factor.....	2
Annotate Line.....	3
Tool Settings.....	3
Color.....	3
Style Start.....	3
End.....	3
Annotate Polygon.....	3
Tool Settings.....	3
Color.....	3
Annotate Eraser.....	4
Tool Settings.....	4
Radius.....	4
Tool Shelf in Paint Mode.....	4
Draw.....	4
Soften.....	4
Smear.....	4
Clone.....	4
Last Operator Grab Clone.....	5
Delta X Y.....	5
Fill.....	5
Mask.....	5

Tool Shelf in View Mode

This menu just appears when you are in Mask mode.

In this menu you can create circle or square spline curves to use them for masking. They appear at the 2D cursor, and have four handlers.

They can be moved, rotated and resized with the usual W E R keys. See also mask menu, Transform. The handlers allows to change the shape and size too.

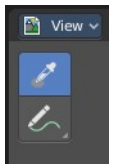

You can add multiple spline curves to a mask layer.

Sample

Samples the color under the mouse cursor. This sampled information is just an information. It has no real use, you don't pick up the color. There is no tool that could use it.

The sample result gets displayed in the footer.

X:256 Y:753 | R:1.00000 G:1.00000 B:1.00000 A:1.0000 | CM R:1.0000 G:1.0000 B:1.0000 H:0.0000 S:0.0000 V:1.0000 L:1.0000

Annotate Tools group

The annotation tool is available in multiple editors. With this tool you can write notes at the screen. The annotate tools is the little brother of the grease pencil objects.

Further settings for annotate can be found in the sidebar. Here you can also remove an annotation when you don't longer need it. And here you can also adjust the size of the stroke.

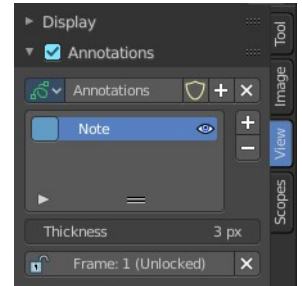
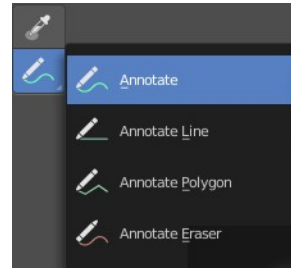

Annotate

Draw free-hand strokes in the main window.

Tool Settings

The tool settings for Annotate.

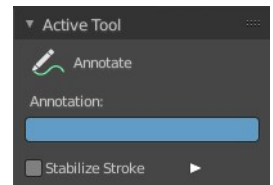

Color

Clicking at the left color field reveals a color picker. Define the color for the annotation stroke.



Stabilize Stroke

Helper to draw smooth and clean lines. Pressing shift inverts the effect.



Radius

The radius for the stroke stabilization.

Factor

Stabilizer stroke factor. Higher values gives a smoother stroke.

Annotate Line

Click and drag to create a line.

Tool Settings

The tool settings for the Annotate tool.

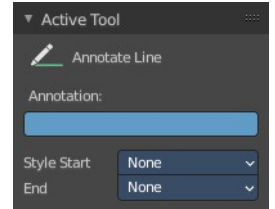

Color

Clicking at the left color field reveals a color picker. Define the color for the annotation stroke.



Style Start

The stroke start style. With an arrow for example you place an arrow at the start of the stroke.

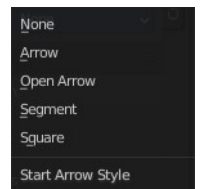

End

The stroke end style. With an arrow for example you place an arrow at the end of the stroke.

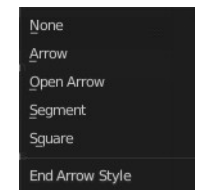

Annotate Polygon

Click multiple times to create multiple connected lines. The current polygon is finished when Esc or RMB is pressed.

Tool Settings

The tool settings for Annotate.

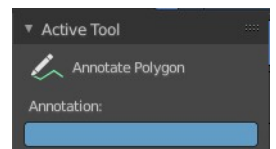

Color

Clicking at the left color field reveals a color picker where you can define the color for the annotation stroke.



Annotate Eraser

Click and drag to remove annotate lines.

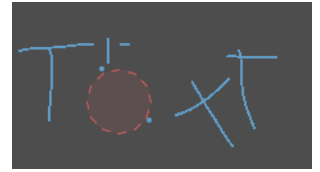

Tool Settings

Radius

The radius of the eraser pencil.

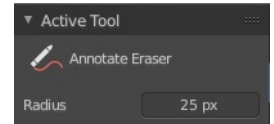

Tool Shelf in Paint Mode

The settings for these tools are in the tools tab in the sidebar. This content is explained in the chapter Image Editor - Sidebar. Here we just explain what the tool does and how to use it.

Draw

The draw brush allows you to draw at the canvas. The color can be adjusted in the brush panel in the sidebar.

The Tools Tab provides you with further options and settings.



Soften

Softens the image under the brush.

Smear

Smears the image under the brush.

Clone

Despite the name it is not a clone tool. It is a stencil map paint tool. You load an image, and can then use it to paint parts of this stencil image onto the canvas.

You can move the stencil image around with the right mouse button.

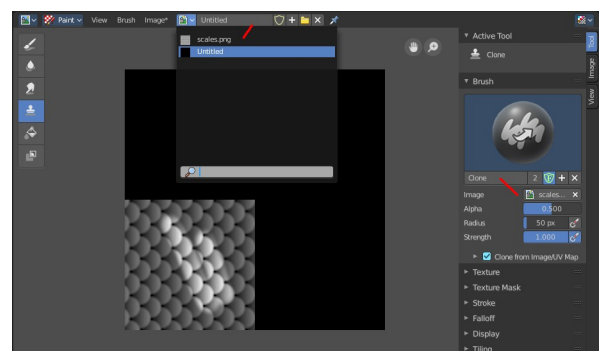
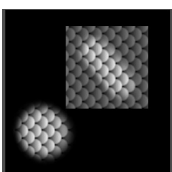

Last Operator Grab Clone

Delta X Y

The position of the stencil image. The position gets calculated from the lower left corner. It is not calculated in pixels, but relative to the source image. The width and height of it is the range between 0 and 1



Fill

Fills areas with the same color with another color of your choice. The color can be set in the Brush panel in the sidebar.

Mask

This tool allows you to mask out image parts.



8.3 Editors - Image Editor - Sidebar

Table of content

Introduction.....1
 Right Click menus.....1

Introduction

The Image Editor is made of several areas. At the right side you will find the sidebar. Here you will find further options and settings for the Image Editor and its tools.

The tools tab in paint mode contains several panels with functionality for the brushes. The Image tab contains image related settings. And so on.

The Scopes tab just appears with an image selected.

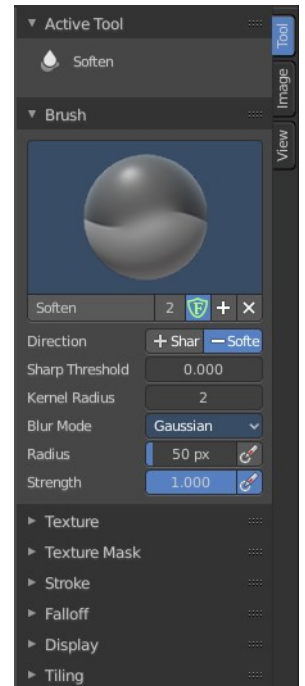
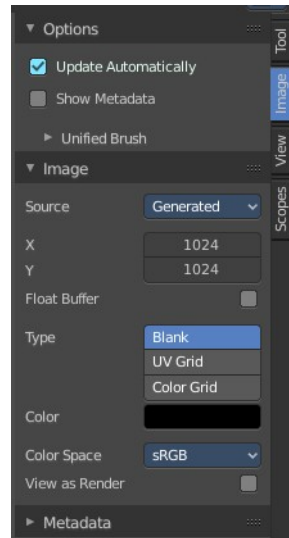

Right Click menus

You will open the usual right click menus when clicking with the right mouse at elements in the sidebar. Its content is in big parts self explaining.

The right click menus are explained in the chapter 6 Editors Introduction.

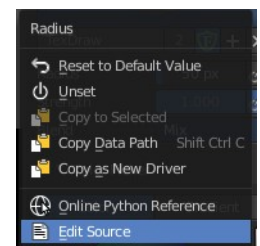



8.3.1 Editors - Image Editor - Sidebar - Tools Tab in Paint Mode

Table of content

Detailed Table of Content.....	4
Tools Tab.....	9
Save Image.....	9
Brushes Panel.....	9
Browse Brush.....	9
Custom Icon.....	10
Brush settings Panel.....	10
Brush Panel.....	10
Blend.....	10
Radius.....	11
Size Pressure.....	11
Use Unified Radius.....	11
Strength.....	11
Size Pressure.....	11
Use Unified Radius.....	11
Brush Settings Panel - Color Picker Sub panel.....	11
Brush colors flip.....	11
Use unified Color.....	11
Brush Settings Panel - Color Palette Sub panel.....	12
Palette browser.....	13
Edit Box.....	13
Number of users.....	13
Fake User.....	13
Add palette.....	13
Remove Palette.....	13
Brush Settings Panel - Advanced Sub panel.....	13
Accumulate.....	13
Affect Alpha.....	13
Sharpen / Soften (Soften Brush).....	14
Sharp Threshold.....	14
Kernel Radius.....	14
Blur Mode (Soften Brush).....	14
Image (Clone Brush).....	14
Alpha.....	14
Anti Aliasing.....	14
Mask Value (Mask brush).....	14
Brush Settings Panel - Texture Sub panel.....	14
Texture Panel.....	14
Browse Texture to be linked.....	15
Texture Edit box.....	16
Brush Mapping.....	16
Brush Mapping with mapping method Tiled.....	17
Angle.....	17
Offset.....	17
Size.....	17
Brush Mapping with mapping method View Plane.....	17
Angle.....	17

Rake.....	17
Random.....	17
Offset.....	17
Size.....	17
Brush Mapping with mapping method 3D.....	18
Offset.....	18
Size.....	18
Brush Mapping with mapping method Random.....	18
Angle.....	18
Rake.....	18
Random.....	18
Brush Mapping with mapping method Stencil.....	18
Image Aspect.....	19
Reset Transform.....	19
Angle edit box.....	19
Offset.....	19
Size.....	19
Brush Settings Panel - Texture Mask Sub panel.....	19
Texture Mask Panel.....	19
Browse Texture to be linked.....	20
Brush Mapping with mapping method Tiled.....	21
Pressure Masking.....	21
Angle.....	21
Offset.....	21
Size.....	22
Brush Mapping with mapping method View Plane.....	22
Pressure Masking.....	22
Angle.....	22
Rake.....	22
Random.....	22
Offset.....	22
Size.....	22
Brush Mapping with mapping method Random.....	22
Pressure Masking.....	22
Mask Pressure Mode.....	22
Angle.....	22
Rake.....	23
Random.....	23
Offset.....	23
Size.....	23
Brush Mapping with mapping method Stencil.....	23
Image Aspect.....	23
Reset Transform.....	23
Pressure Masking.....	23
Angle edit box.....	23
Offset.....	23
Size.....	24
Stroke Panel.....	24
Stroke Panel.....	24
Stroke method Space.....	24
Spacing Edit Box.....	24
Spacing Pressure.....	24
Adjust Strength for Spacing.....	24

Dash Ratio.....	24
Dash Length.....	24
Jitter Edit Box.....	25
Spacing Pressure.....	25
Jitter Unit.....	25
Input Samples Edit Box.....	25
Smooth Stroke.....	25
Smooth Stroke Radius Edit Box.....	25
Smooth Stroke Factor Edit Box.....	25
Stroke method Curve.....	25
Spacing Edit Box.....	26
Paint Curve edit box.....	26
Draw Curve Button.....	26
Jitter Edit Box.....	26
Jitter Pressure.....	26
Jitter Unit.....	26
Input Samples Edit Box.....	26
Stabilize Stroke.....	27
Smooth Stroke Radius Edit Box.....	27
Smooth Stroke Factor Edit Box.....	27
Stroke method Line.....	27
Spacing Edit Box.....	27
Jitter Edit Box.....	27
Jitter Pressure.....	27
Jitter Unit.....	27
Input Samples Edit Box.....	27
Stabilize Stroke.....	28
Smooth Stroke Radius Edit Box.....	28
Smooth Stroke Factor Edit Box.....	28
Stroke method Anchored.....	28
Edge to edge.....	28
Jitter Edit Box.....	28
Jitter Pressure.....	28
Jitter Unit.....	28
Input Sample Edit Box.....	28
Stabilize Stroke.....	28
Smooth Stroke Radius Edit Box.....	28
Smooth Stroke Factor Edit Box.....	28
Stroke method Airbrush.....	28
Rate Edit Box.....	29
Jitter Edit Box.....	29
Jitter Pressure.....	29
Jitter Unit.....	29
Input Samples Edit Box.....	29
Stabilize Stroke.....	29
Smooth Stroke Radius Edit Box.....	29
Smooth Stroke Factor Edit Box.....	29
Stroke method Drag Dot.....	29
Jitter Edit Box.....	29
Jitter Pressure.....	29
Jitter Unit.....	29
Input Samples Edit Box.....	30
Stabilize Stroke.....	30

Smooth Stroke Radius Edit Box.....	30
Smooth Stroke Factor Edit Box.....	30
Stroke method Dots.....	30
Jitter Edit Box.....	30
Jitter Pressure.....	30
Jitter Unit.....	30
Input Samples Edit Box.....	30
Stabilize Stroke.....	30
Smooth Stroke Radius Edit Box.....	30
Smooth Stroke Factor Edit Box.....	30
Brush Settings Panel - Falloff Sub panel.....	31
Selecting Points.....	31
Adding Points.....	31
Navigation elements.....	31
Zoom in and out.....	31
Tools.....	31
Reset View.....	31
Vector Handle.....	31
Auto Handle.....	32
Auto Clamped Handle.....	32
Reset Curve.....	32
Use Clipping.....	32
Delete Points.....	32
Curve window.....	32
Curve Presets.....	32
Brush Settings Panel - Brush Tip Sub panel.....	32
Brush Tip Checkbox.....	32
Cursor Color.....	32
Falloff Opacity.....	33
Override Overlay.....	33
Use Cursor Overlay.....	33
Texture Opacity.....	33
Override Overlay.....	33
Use Cursor Overlay.....	33
Mask Texture Opacity.....	33
Override Overlay.....	33
Use Cursor Overlay.....	33
Tiling panel.....	33

Detailed Table of Content

Detailed Table of Content

Detailed Table of Content.....	1
Tools Tab.....	6
Save Image.....	6
Brushes Panel.....	6
Browse Brush.....	6
Custom Icon.....	7
Brush settings Panel.....	7

Brush Panel.....	7
Blend.....	7
Radius.....	8
Size Pressure.....	8
Use Unified Radius.....	8
Strength.....	8
Size Pressure.....	8
Use Unified Radius.....	8
Brush Settings Panel - Color Picker Sub panel.....	8
Brush colors flip.....	8
Use unified Color.....	8
Brush Settings Panel - Color Palette Sub panel.....	9
Palette browser.....	9
Edit Box.....	9
Number of users.....	9
Fake User.....	9
Add palette.....	9
Remove Palette.....	9
Brush Settings Panel - Advanced Sub panel.....	10
Accumulate.....	10
Affect Alpha.....	10
Sharpen / Soften (Soften Brush).....	10
Sharp Threshold.....	10
Kernel Radius.....	10
Blur Mode (Soften Brush).....	10
Image (Clone Brush).....	10
Alpha.....	10
Anti Aliasing.....	10
Mask Value (Mask brush).....	10
Brush Settings Panel - Texture Sub panel.....	11
Texture Panel.....	11
Browse Texture to be linked.....	11
Texture Edit box.....	12
Brush Mapping.....	12
Brush Mapping with mapping method Tiled.....	13
Angle.....	13
Offset.....	13
Size.....	13
Brush Mapping with mapping method View Plane.....	13
Angle.....	13
Rake.....	13
Random.....	13
Offset.....	13
Size.....	13
Brush Mapping with mapping method 3D.....	14
Offset.....	14
Size.....	14
Brush Mapping with mapping method Random.....	14
Angle.....	14
Rake.....	14
Random.....	14
Brush Mapping with mapping method Stencil.....	14
Image Aspect.....	15

Reset Transform.....	15
Angle edit box.....	15
Offset.....	15
Size.....	15
Brush Settings Panel - Texture Mask Sub panel.....	15
Texture Mask Panel.....	15
Browse Texture to be linked.....	16
Brush Mapping with mapping method Tiled.....	17
Pressure Masking.....	17
Angle.....	17
Offset.....	17
Size.....	17
Brush Mapping with mapping method View Plane.....	17
Pressure Masking.....	17
Angle.....	17
Rake.....	17
Random.....	17
Offset.....	18
Size.....	18
Brush Mapping with mapping method Random.....	18
Pressure Masking.....	18
Mask Pressure Mode.....	18
Angle.....	18
Rake.....	18
Random.....	18
Offset.....	18
Size.....	18
Brush Mapping with mapping method Stencil.....	18
Image Aspect.....	19
Reset Transform.....	19
Pressure Masking.....	19
Angle edit box.....	19
Offset.....	19
Size.....	19
Stroke Panel.....	19
Stroke Panel.....	19
Stroke method Space.....	19
Spacing Edit Box.....	20
Spacing Pressure.....	20
Adjust Strength for Spacing.....	20
Dash Ratio.....	20
Dash Length.....	20
Jitter Edit Box.....	20
Spacing Pressure.....	20
Jitter Unit.....	20
Input Samples Edit Box.....	20
Smooth Stroke.....	20
Smooth Stroke Radius Edit Box.....	20
Smooth Stroke Factor Edit Box.....	20
Stroke method Curve.....	21
Spacing Edit Box.....	21
Paint Curve edit box.....	21
Draw Curve Button.....	22

Jitter Edit Box.....	22
Jitter Pressure.....	22
Jitter Unit.....	22
Input Samples Edit Box.....	22
Stabilize Stroke.....	22
Smooth Stroke Radius Edit Box.....	22
Smooth Stroke Factor Edit Box.....	22
Stroke method Line.....	22
Spacing Edit Box.....	23
Jitter Edit Box.....	23
Jitter Pressure.....	23
Jitter Unit.....	23
Input Samples Edit Box.....	23
Stabilize Stroke.....	23
Smooth Stroke Radius Edit Box.....	23
Smooth Stroke Factor Edit Box.....	23
Stroke method Anchored.....	23
Edge to edge.....	23
Jitter Edit Box.....	23
Jitter Pressure.....	23
Jitter Unit.....	24
Input Sample Edit Box.....	24
Stabilize Stroke.....	24
Smooth Stroke Radius Edit Box.....	24
Smooth Stroke Factor Edit Box.....	24
Stroke method Airbrush.....	24
Rate Edit Box.....	24
Jitter Edit Box.....	24
Jitter Pressure.....	24
Jitter Unit.....	24
Input Samples Edit Box.....	24
Stabilize Stroke.....	24
Smooth Stroke Radius Edit Box.....	24
Smooth Stroke Factor Edit Box.....	25
Stroke method Drag Dot.....	25
Jitter Edit Box.....	25
Jitter Pressure.....	25
Jitter Unit.....	25
Input Samples Edit Box.....	25
Stabilize Stroke.....	25
Smooth Stroke Radius Edit Box.....	25
Smooth Stroke Factor Edit Box.....	25
Stroke method Dots.....	25
Jitter Edit Box.....	25
Jitter Pressure.....	26
Jitter Unit.....	26
Input Samples Edit Box.....	26
Stabilize Stroke.....	26
Smooth Stroke Radius Edit Box.....	26
Smooth Stroke Factor Edit Box.....	26
Brush Settings Panel - Falloff Sub panel.....	26
Selecting Points.....	26
Adding Points.....	26

Navigation elements.....	27
Zoom in and out.....	27
Tools.....	27
Reset View.....	27
Vector Handle.....	27
Auto Handle.....	27
Auto Clamped Handle.....	27
Reset Curve.....	27
Use Clipping.....	27
Delete Points.....	27
Curve window.....	27
Curve Presets.....	28
Brush Settings Panel - Brush Tip Sub panel.....	28
Brush Tip Checkbox.....	28
Cursor Color.....	28
Falloff Opacity.....	28
Override Overlay.....	28
Use Cursor Overlay.....	28
Texture Opacity.....	28
Override Overlay.....	28
Use Cursor Overlay.....	29
Mask Texture Opacity.....	29
Override Overlay.....	29
Use Cursor Overlay.....	29
Tiling panel.....	29

Tools Tab

In View and Mask mode you don't have any further content in the Tool tab. But in Paint mode the tools tab contains several panels with functionality for the brushes. It is in big parts similar functionality to the paint tools in the 3D view.

The Brush panel shows different content, dependent of which brush is chosen in the tool shelf.

Save Image

A short warning. A modified image does NOT save with the scene. You have to save out the image when you want to save the changes at the texture. There is no warning. So DON'T FORGET TO SAVE THE IMAGE.

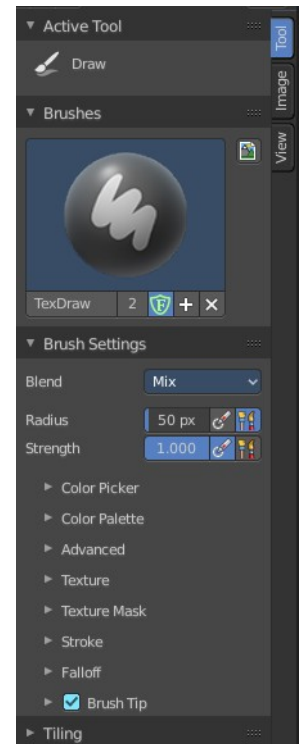

Brushes Panel

The Brush Panel contains the different Brushes and some Brush settings. Choose and adjust your current active brush.



Browse Brush

The big image at the top is a drop down box where you can see the current active brush. The content differs, dependent of the active brush. You can add duplicates of this active brush, and customize it to your needs. But the active brush gets chosen in the Tool Shelf at the left of the 3D View.

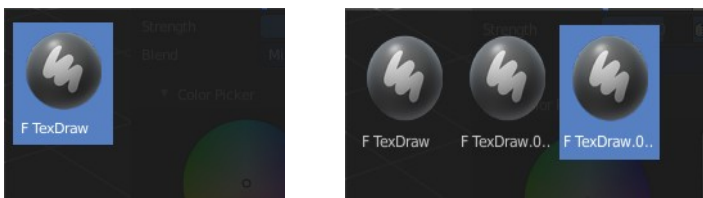

brushes are hidden before or after the current display.

When you have added a few more brushes then the drop down box may be more than full. You will see some little white arrows then. Either in the top left or in the bottom right corner. They indicate that some

To scroll to this hidden content use the mouse wheel, or the arrow up and down buttons at the keyboard.

Custom Icon

The button at the right allows you to load a custom icon for your brush. It reveals a file browser below the image browser.

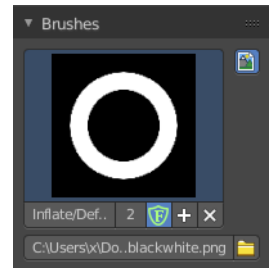

The edit box below the Image shows you the name of the current active brush.



The number right of it, **in this case 2**, indicates how much number of users (internally) this brush uses. This means that this data block (the brush) shares currently settings with at least one other object. Most probably the parent brush where we have created it from. Click at the value to make this brush a single user. The button will vanish then.

The shield icon set the brush to have a fake user. Zero user data-blocks are normally not saved. But sometimes you want to force the data to be kept even when the data block has no user.

The + button allows you to add a new pencil with the current settings. Note that the brushes are NOT saved when you close Bforartists. You can save them into the current blend file. Or you can save the startup file. But be careful here. This saves everything else of the current state of Bforartists too.

The X button deletes the brush as the active one. It does NOT delete it from the brushes list.

Brush settings Panel

Brush Panel

The Brush Panel contains the different paint brushes, a color dialog, and some brush settings.

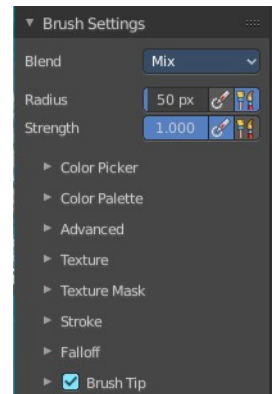

Blend

Define how the stroke will blend. You can choose between various blend modes.

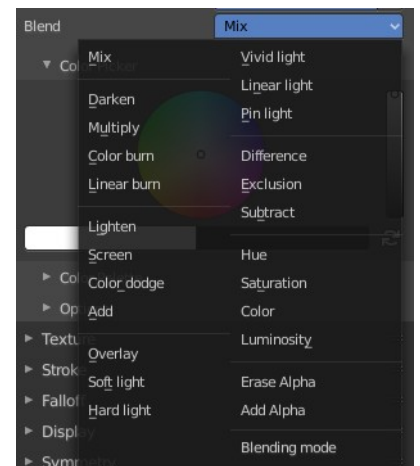

Radius

The Radius edit box allows you to adjust the radius of the brush. The button behind the edit box enables tablet pressure sensitivity for radius.

Size Pressure

The first button behind the edit box enables tablet pressure sensitivity for radius.

Use Unified Radius

The second button behind the edit box enables global radius size. Any modification at the radius will also modify the radius value for other paint tools.

Strength

The Strength edit box allows you to adjust the strength of the brush. The button behind the edit box enables tablet pressure sensitivity for strength.

Size Pressure

The first button behind the edit box enables tablet pressure sensitivity for radius.

Use Unified Radius

The second button behind the edit box enables global radius size. Any modification at the radius will also modify the radius value for other paint tools.

Brush Settings Panel - Color Picker Sub panel

Define the color for your brush.

The active color is the left one. When you click the button with the two arrows down right then you can swap the color with the secondary color. Then this secondary color becomes the primary color, and is active.



A click at one of the color fields will open a more detailed color dialog, to set up the color by using rgb, hsv and hex colors and with value sliders.



Brush colors flip

Flips the primary color with the secondary color.

Use unified Color

Choose if you want to use global colors or local color just for vertex painting.

Brush Settings Panel - Color Palette Sub panel

Create a color palette for later reuse.

First create a new palette by clicking at New. Then adjust the color in the color picker. And then click at the add button to add this color to the palette.

To set the color picker to a palette color simply click at this palette color.

To remove a color from the palette, choose it, then click at the remove button. The active palette color that gets removed is the one with the triangle at it.

The color palette cannot be saved externally. It is part of the current blend file. You can however append color palettes from other blend files.

The elements are explained from left to right.

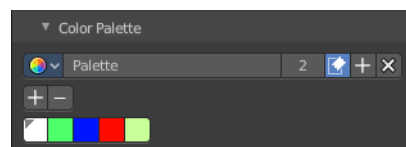
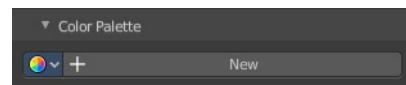

Palette browser

The button at the left opens a drop down list where you can choose between your palettes.

Edit Box

Read the name of the currently active palette. You can also rename the palette here. A click into the edit box makes the name editable.

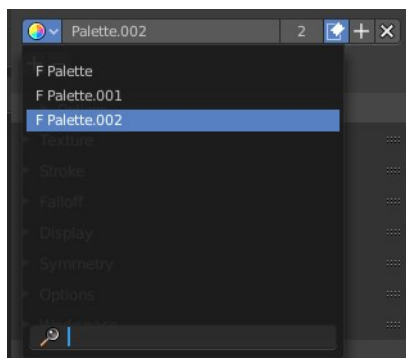

Number of users

See how many users the palette currently has.

Fake User

Fake User sets the element to have a fake user. Zero user data-blocks are normally not saved. But sometimes you want to force the data to be kept even when the data block has no user.

Add palette

Add a new palette.

Remove Palette

Clicking at this button removes the palette. Note that you need to save, close Bforartists and reload the blend file to remove the palette completely.

Brush Settings Panel - Advanced Sub panel

This sub panel contains brush specific settings.

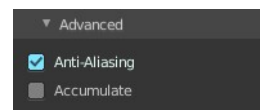

Accumulate

Accumulate stroke daubs on top of each other.

Affect Alpha

When disabled then the alpha is locked while painting.

Sharpen / Soften (Soften Brush)

Sharp Threshold

The threshold below which no sharpening is performed.

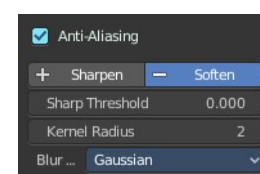

Kernel Radius

Radius of kernel used for soften and sharpen in pixels.

Blur Mode (Soften Brush)

Choose the blur method. Gaussian or Box.

Image (Clone Brush)

Choose an image to clone from.

Alpha

The alpha value for the clone image.

Anti Aliasing

Smooths the edges of the strokes.

Mask Value (Mask brush)

The vertex weight when brush is applied.



Brush Settings Panel - Texture Sub panel

Texture Panel

The Texture panel allows you to paint with textures. This allows you for example to grab a photo from some fish scales, and simply paint them onto the mesh by using this image as a pencil. Or as a blueprint where you walk through (Stencil method).

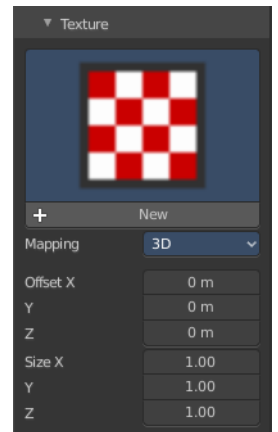

Browse Texture to be linked

The image at the top of the panel is an image browser. Choose a texture that you can choose for painting then. You can also have more than one image loaded at once.

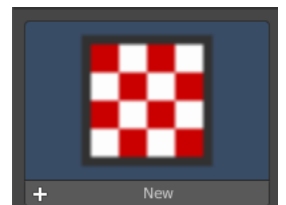
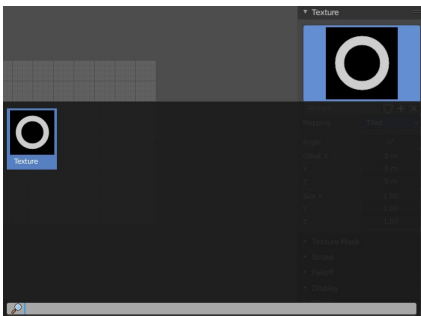

In this shot there is already a texture added. The way to add the texture here is a bit more complicated. And not done with clicking at the New button.

First click at the New button below the image. This will create a new texture slot. This slot is still empty, it displays black.

We need to load a texture in this slot. This must be done in the Properties editor in the Textures tab.

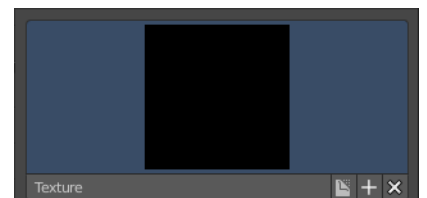

The problem is, we have an object with a material and a texture already selected. And when we change this texture, then we don't get the pencil texture loaded. But we change the texture at our mesh.

What we need to do is to create a material first. And in this material we load our pencil texture then. And then this texture becomes available in the image browser of the Texture panel.

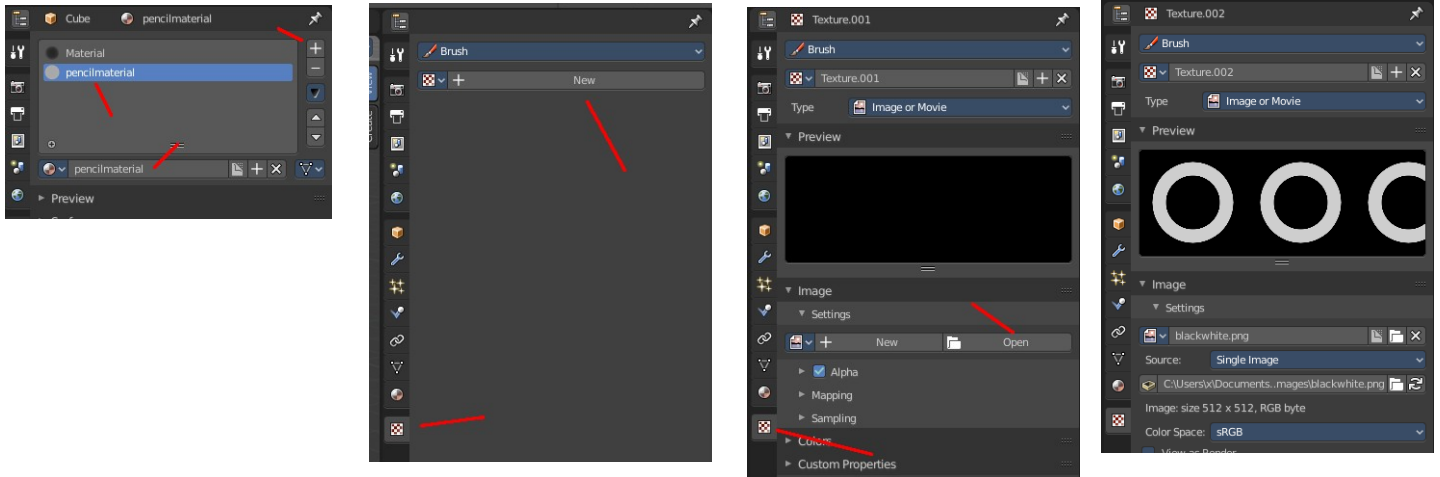

And when we go back to the texture panel, then the texture should be loaded here. And we can work with this texture.

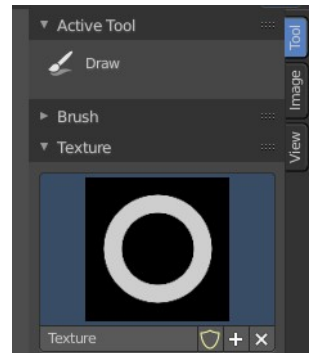

Texture Edit box



The Texture edit box is the edit box below the Image browser. When there's no image loaded then it displays the New button. When there's an image (or more) loaded, then you will see the name of the current texture.

The F button turns this texture into a data block with a fake user. Means it will exist even when there is no data connected to it anymore.

When you activate Fake User, then you may get a value in front of it, which displays how much users this data block (our texture slot) currently has.

The + Button adds another texture slot. Note that you will have to load a texture too, as explained above.

The X button deletes the texture slot.

Brush Mapping

Our texture can be mapped in different methods. The Brush mapping is a drop down box where you can choose this different brush mapping methods.

The settings vary. So we will go through them by the different brush

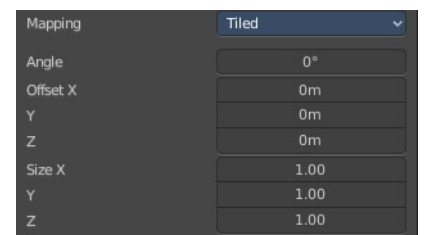

mapping methods.

Brush Mapping with mapping method Tiled

The brush mapping method Tiled tiles the brush stroke at the surface. The mapping happens from the current view. The result may be distorted when the view does not align with the surface of the object.

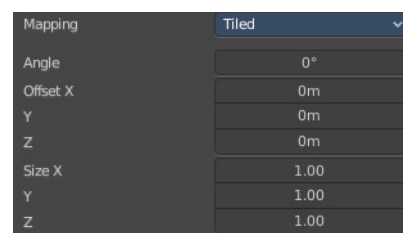

Angle

The angle of the brush.

Offset

The offset of the texture in the brush.

Size

The size of the texture in the brush.

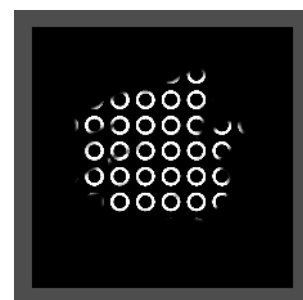

Brush Mapping with mapping method View Plane

The brush mapping method View Plane simply paints onto the surface. The mapping happens from the current view. The result may be distorted when the view does not align with the surface of the object.



Angle

The angle of the brush.

Rake

The angle follows the direction of the brush stroke.

Random

The brush angle gets set random.

Offset

The offset of the texture in the brush.

Size

The size of the texture in the brush.

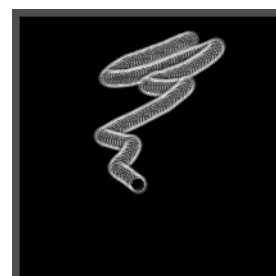

Brush Mapping with mapping method 3D

The brush mapping method 3D paints the texture at the surface, by tiling it 1/1 at the object surface.



Offset

The offset of the texture in the brush.

Size

The size of the texture in the brush.



Brush Mapping with mapping method Random

The brush mapping method Random paints onto the surface, and randomizes the texture position in the brush while that. The mapping happens from the current view. The result may be distorted when the view does not align with the surface of the object.



Angle

The angle of the brush.

Rake

The angle follows the direction of the brush stroke.

Random

The brush angle gets set random.



Brush Mapping with mapping method Stencil

The former methods uses the textures for the brush. The method Stencil works different. You have your texture displayed in the workspace above the object, and you paint this texture onto your object with your pencil strokes.

Note that the texture in the 3d space is just visible when you are with the mouse over the viewport.

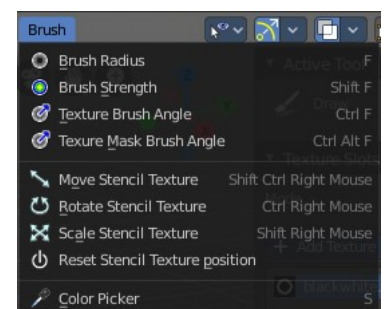

It gets by default displayed down left. You have to position it where you need it. See Brush menu in the 3D view, Stencil Texture controls.

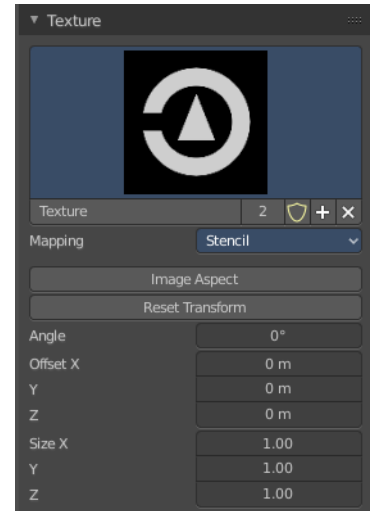
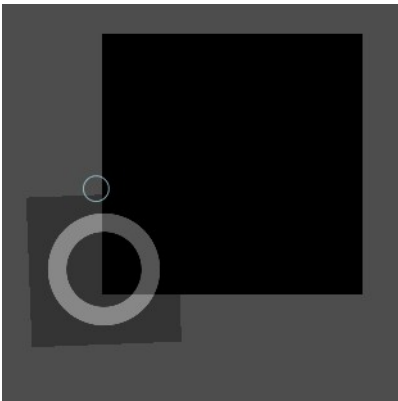

Image Aspect

Adjust the stencil size to fit to the image aspect ratio.

Reset Transform

Resets the stencil image to be down right in the 3D view.

Angle edit box

Adjust the angle of the brush. The button at the end allows you to set the radius by dragging the mouse. This should be done in the viewport and with the hotkey. This button is just a visible reminder.

Offset

Fine tune the offset of the texture in the brush.

Size

Fine tune the size of the texture in the brush.

Brush Settings Panel - Texture Mask Sub panel

Texture Mask Panel

The texture mask panel allows you to use a texture as a mask to define the strength of painting. It paints just where the mask texture is bright. You can also use gradients to define the paint strength.

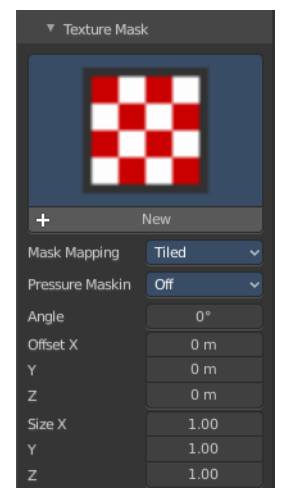

Browse Texture to be linked

The image at the top of the panel is an image browser. Choose a texture that you can choose for painting then. You can also have more than one image loaded at once.

In this shot there is already two textures added. The way to add the texture here is a bit more complicated. And not done with clicking at the New button.

First click at the New button below the image. This will create a new texture slot. This slot is still empty, it displays black.

We need to load a texture in this slot. This must be done in the Properties editor in the Textures tab.

The problem is, we have an object with a material and a texture already selected. And when we change this texture , then we don't get the pencil texture loaded. But we change the texture at our mesh.

What we need to do is to create a material first. And in this material we load our pencil texture then. And then we can choose this texture in the image browser of the texture.

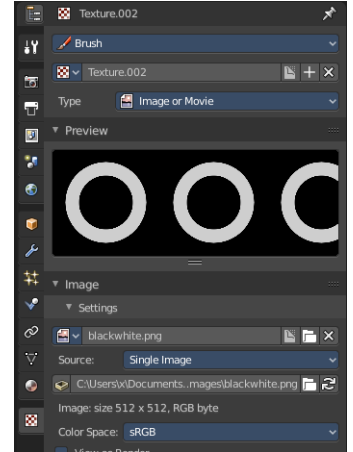
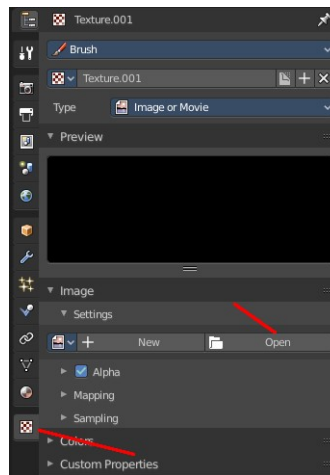
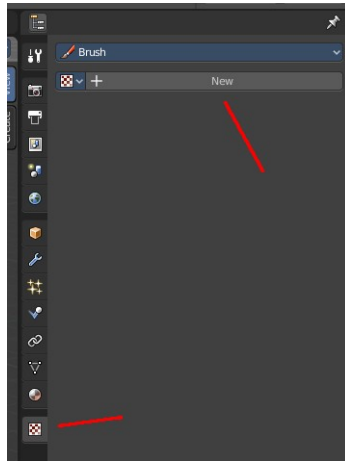
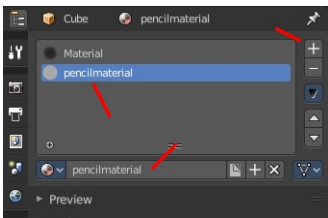
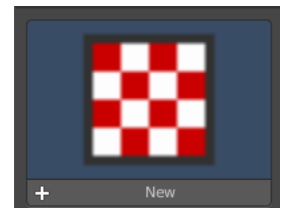
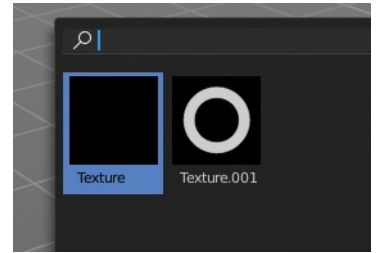

And when we switch back to the tools tab, then the texture is loaded. And we can work with this texture.

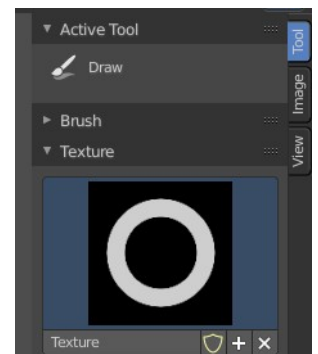

Make sure that you use another texture in the Texture panel than in the Texture Mask panel, or no texture at all. When both is the same then you will get the same result with all Mask Mapping methods since they overlap each other at the very same positions.

Brush Mapping with mapping method Tiled

The brush mapping method Tiled tiles the brush stroke at the surface. The mapping happens from the current view. The result may be distorted when the view does not align with the surface of the object.

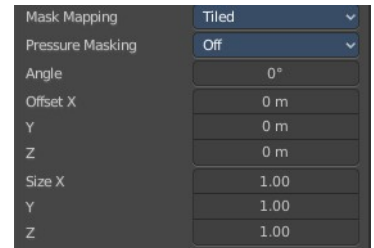

Pressure Masking

Enable pressure masking when you use a tablet.



Angle

The angle of the brush.

Offset

The offset of the texture in the brush.

Size

The size of the texture in the brush.

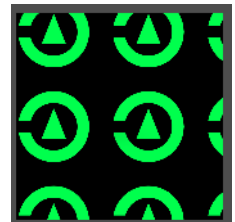

Brush Mapping with mapping method View Plane

The brush mapping method View Plane simply paints onto the surface. The mapping happens from the current view. The result may be distorted when the view does not align with the surface of the object.

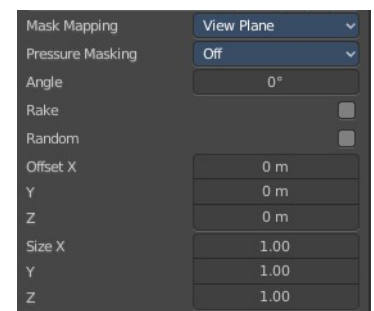

Pressure Masking

Enable pressure masking when you use a tablet.



Angle

The angle of the brush.

Rake

The angle follows the direction of the brush stroke.

Random

The brush angle gets set random.



Offset

The offset of the texture in the brush.

Size

The size of the texture in the brush.

Brush Mapping with mapping method Random

The brush mapping method Random paints onto the surface, and randomizes the texture position in the brush while that.

Pressure Masking

Enable pressure masking when you use a tablet.



Mask Pressure Mode

A drop down box to choose the mask pressure mode for tablets.



Angle

The angle of the brush.

Rake

The angle follows the direction of the brush stroke.

Random

The brush angle gets set random.

Offset

The offset of the texture in the brush.

Size

The size of the texture in the brush.

Brush Mapping with mapping method Stencil

The former methods uses the textures for the brush. The method Stencil works different. You have your texture displayed in the workspace above the image, and you paint this texture onto your object with your pencil strokes.

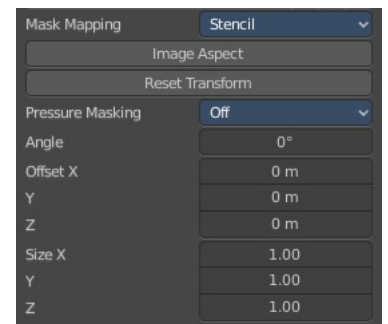
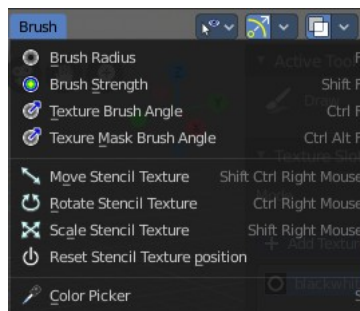

Note that the stencil texture is just visible when you are with the mouse over the viewport. It gets by default

displayed down left. You have to position it where you need it. See Brush menu, Stencil Texture controls.

Image Aspect

Adjust the stencil size to fit to the image aspect ratio.

Reset Transform

Resets the stencil image to be down right in the 3D view.

Pressure Masking

Enable pressure masking when you use a tablet.



Angle edit box

Adjust the angle of the brush. The button at the end allows you to set the radius by dragging the mouse. This should be done in the viewport and with the hotkey. This button is just a visible reminder.



Offset

Fine tune the offset of the texture in the brush.

Size

Fine tune the size of the texture in the brush.

Stroke Panel

Stroke Panel

The Stroke panel contains settings to influence the behavior of the brush stroke. There are various stroke methods available. We will go through them one by one.

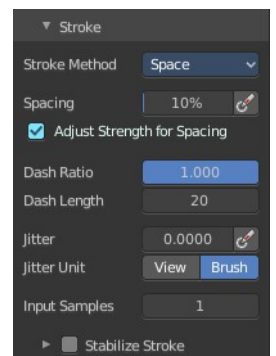

Stroke method Space

This is the default Stroke method. The stroke gets added continuously with given settings.

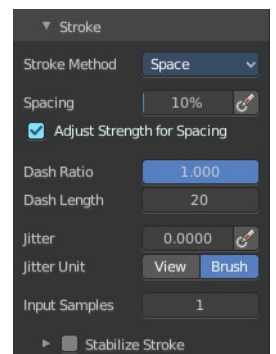
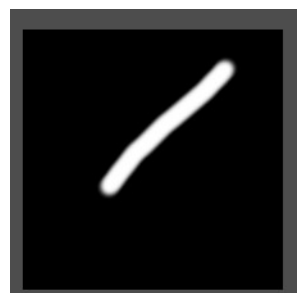

Spacing Edit Box

The sculpt drawing happens by mapping the pencil onto the mouse position. And when you move the mouse then the next mapping happens. Adjust the spacing after what mouse movement the next mapping should happen. The lower the value, the lower the distance between the single dots.

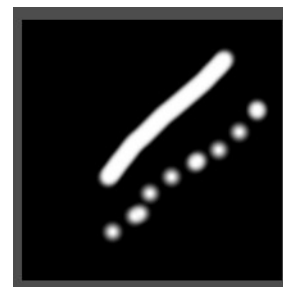

Spacing Pressure

The icon behind the edit box enables tablet pressure sensitivity for tablets.

Adjust Strength for Spacing

Automatically adjust strength to give consistent results for different spacing.

Dash Ratio

Ratio of samples in a cycle that the brush is covering.

Dash Length

Length of a dash cycle measured in stroke samples.

Jitter Edit Box

Add Jitter to the brush while painting.

Spacing Pressure

The icon behind the edit box enables tablet pressure sensitivity for tablets.

Jitter Unit

Jitter in screen space, or relative to the brush size.

Input Samples Edit Box

Average multiple input samples together to smooth the brush stroke.

Smooth Stroke

The brush lags behind the mouse position, and produces a much smoother stroke by that.

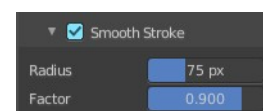

Smooth Stroke Radius Edit Box

Is just active when Smooth Stroke is activated. Adjust the radius of the smoothing.

Smooth Stroke Factor Edit Box

Is just active when Smooth Stroke is activated. Adjust the factor of the smoothing.

Stroke method Curve

The Stroke method curve doesn't simply influence the way how the stroke is painted. It is a special method.

First you draw a curve object by holding down ctrl and clicking with right mouse button. Then you tweak the curve. You can click at the curve point, and drag out handlers to make the curve points smooth. This way you get one handler. When you click and drag then you will get two handlers at the curve point.

When done you hit the Draw Curve button or click left outside of the image. And the curve gets drawn onto the surface.

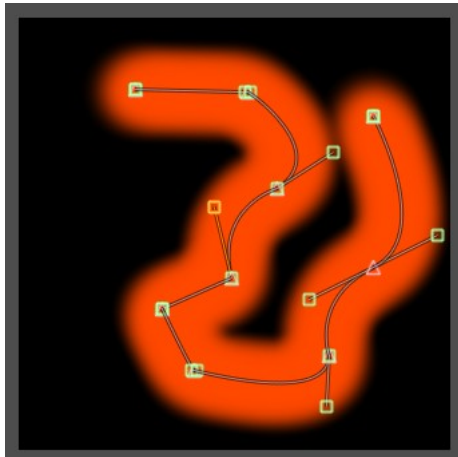
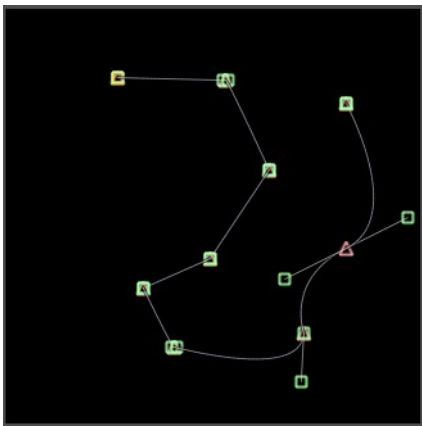
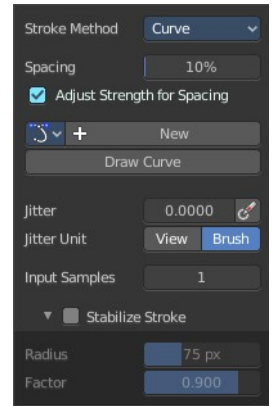

Spacing Edit Box

The drawing happens by mapping the pencil onto the mouse position. And when you move the mouse then the next mapping happens. Adjust the spacing after what mouse movement the next mapping should happen. The lower the value, the lower the distance between the single dots.

The icon behind the edit box enables tablet pressure sensitivity for tablets.

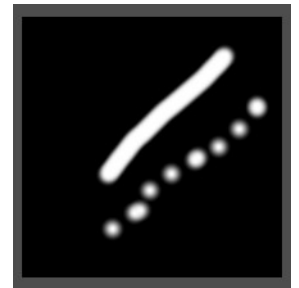

Paint Curve edit box

Here you set the active curve.

The first element is a drop down box where you will find your curves objects. You can have more than one.

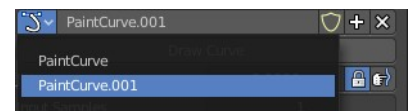

The second element is the edit box that displays the active curve.

The number right of it, **in this case 2**, indicates how much number of users (internally) this brush uses. This means that this data block (the brush) shares currently settings with at least one other object. Most probably the parent brush where we have created it from. Click at the value to make this brush a single user. The button will vanish then.

F set the brush to have a fake user. Zero user data-blocks are normally not saved. But sometimes you want to force the data to be kept even when the data block has no user.

The + button allows you to add a new pencil with the current settings. Note that the brushes are NOT saved when you close Bforartists. You can save them into the current blend file. Or you can save the startup file. But be careful here. This saves everything else of the current state of Bforartists too.

The X button deletes the brush as the active one. It does NOT delete it from the brushes list.

Draw Curve Button

A click at it to turns the curve into curve.

Jitter Edit Box

Add Jitter to the brush while painting.

Jitter Pressure

The icon behind the edit box enables tablet pressure sensitivity for tablets.

Jitter Unit

Jitter in screen space, or relative to the brush size.

Input Samples Edit Box

Average multiple input samples together to smooth the brush stroke.

Stabilize Stroke

The brush lags behind the mouse position, and produces a much smoother stroke by that.

Smooth Stroke Radius Edit Box

Is just active when Smooth Stroke is activated. Adjust the radius of the smoothing.

Smooth Stroke Factor Edit Box

Is just active when Smooth Stroke is activated. Adjust the factor of the smoothing.

Stroke method Line

With Stroke method line you draw a line between a starting point and an endpoint. And when you release the mouse then the line gets drawn.

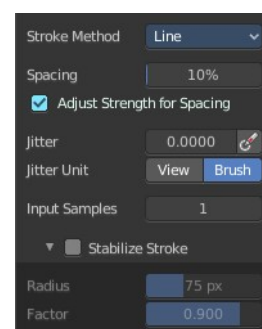
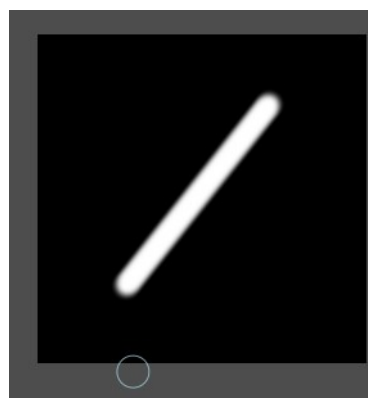

Spacing Edit Box

The drawing happens by mapping the pencil onto the mouse position. And when you move the mouse then the next mapping happens. Adjust the spacing after what mouse movement the next mapping should happen. The lower the value, the lower the distance between the single dots.

The icon behind the edit box enables tablet pressure sensitivity for tablets.

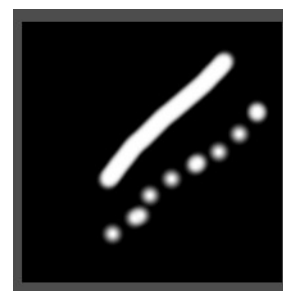

Jitter Edit Box

Add Jitter to the brush while painting.

Jitter Pressure

The icon behind the edit box enables tablet pressure sensitivity for tablets.

Jitter Unit

Jitter in screen space, or relative to the brush size.

Input Samples Edit Box

Average multiple input samples together to smooth the brush stroke.

Stabilize Stroke

The brush lags behind the mouse position, and produces a much smoother stroke by that.

Smooth Stroke Radius Edit Box

Is just active when Smooth Stroke is activated. Adjust the radius of the smoothing.

Smooth Stroke Factor Edit Box

Is just active when Smooth Stroke is activated. Adjust the factor of the smoothing.

Stroke method Anchored

Click and drag to place a dot and to scale it.

Edge to edge

Drag Anchor Brush from edge to edge.

Jitter Edit Box

Add Jitter to the brush while painting.

Jitter Pressure

The icon behind the edit box enables tablet pressure sensitivity for tablets.

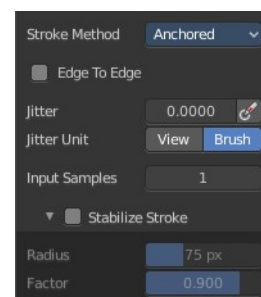
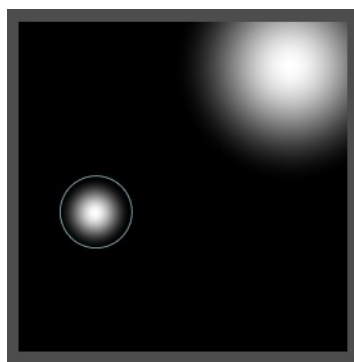

Jitter Unit

Jitter in screen space, or relative to the brush size.

Input Sample Edit Box

Average multiple input samples together to smooth the brush stroke.

Stabilize Stroke

The brush lags behind the mouse position, and produces a much smoother stroke by that.

Smooth Stroke Radius Edit Box

Is just active when Smooth Stroke is activated. Adjust the radius of the smoothing.

Smooth Stroke Factor Edit Box

Is just active when Smooth Stroke is activated. Adjust the factor of the smoothing.

Stroke method Airbrush

The stroke acts like an airbrush pencil. The dots gets placed randomly.

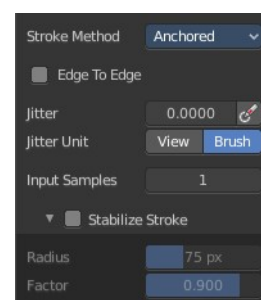
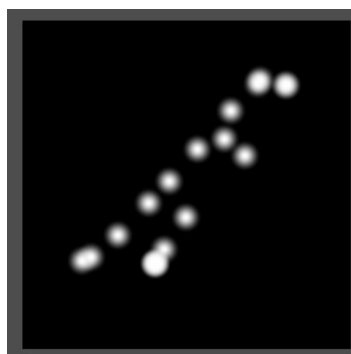

Rate Edit Box

Define the rate of the drawing.

Jitter Edit Box

Add Jitter to the brush while painting.

Jitter Pressure

The icon behind the edit box enables tablet pressure sensitivity for tablets.

Jitter Unit

Jitter in screen space, or relative to the brush size.

Input Samples Edit Box

Average multiple input samples together to smooth the brush stroke.

Stabilize Stroke

The brush lags behind the mouse position, and produces a much smoother stroke by that.

Smooth Stroke Radius Edit Box

Is just active when Smooth Stroke is activated. Adjust the radius of the smoothing.

Smooth Stroke Factor Edit Box

Is just active when Smooth Stroke is activated. Adjust the factor of the smoothing.

Stroke method Drag Dot

Paint a dot and drag it around. The actual painting happens then at releasing the mouse.

Jitter Edit Box

Add Jitter to the brush while painting.

Jitter Pressure

The icon behind the edit box enables tablet pressure sensitivity for tablets.

Jitter Unit

Jitter in screen space, or relative to the brush size.

Input Samples Edit Box

Average multiple input samples together to smooth the brush stroke.

Stabilize Stroke

The brush lags behind the mouse position, and produces a much smoother stroke by that.

Smooth Stroke Radius Edit Box

Is just active when Smooth Stroke is activated. Adjust the radius of the smoothing.

Smooth Stroke Factor Edit Box

Is just active when Smooth Stroke is activated. Adjust the factor of the smoothing.

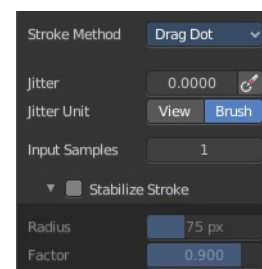
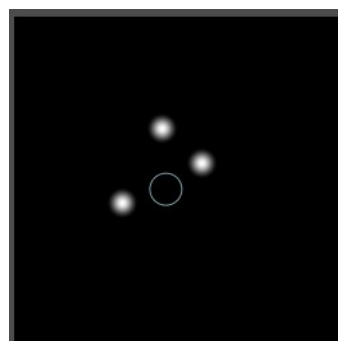

Stroke method Dots

The stroke method Dots draws dots of the pencil onto the surface. The mapping happens from the current view. Means you will get distortions when your view is not aligned with the surface of the object.

Jitter Edit Box

Add Jitter to the brush while painting.

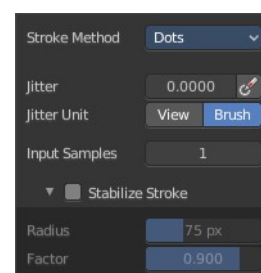

Jitter Pressure

The icon behind the edit box enables tablet pressure sensitivity for tablets.

Jitter Unit

Jitter in screen space, or relative to the brush size.

Input Samples Edit Box

Average multiple input samples together to smooth the brush stroke.

Stabilize Stroke

The brush lags behind the mouse position, and produces a much smoother stroke by that.

Smooth Stroke Radius Edit Box

Is just active when Smooth Stroke is activated. Adjust the radius of the smoothing.

Smooth Stroke Factor Edit Box

Is just active when Smooth Stroke is activated. Adjust the factor of the smoothing.

Brush Settings Panel - Falloff Sub panel

The curve panel allows you to define different falloffs methods for the border of the brush.

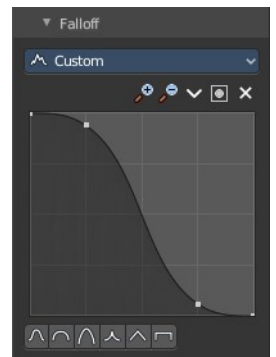

Selecting Points

You can select curve points. This reveals two edit boxes for the x and y coordinate of this point.

Selected points can be moved around. Left click at them, hold the mouse button down and move them to a new location.

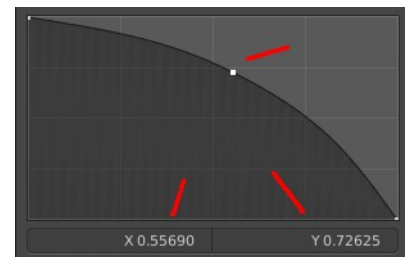

Adding Points

You can add new curve points by simply left clicking at the curve. Move the mouse to position them where you need it.

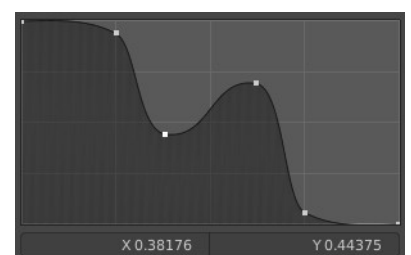

Navigation elements



The navigation elements at the top are described from left to right.

Zoom in and out

The two buttons with the magnifying glass at it zooms in and out in the curve window.

Tools

Tools is a menu where you can find some curve related tools.

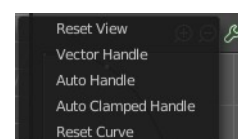

Reset View

Resets the curve windows zoom.

Vector Handle

Set handle type to Vector.

Auto Handle

Set handle type to Auto.

Auto Clamped Handle

Set handle type to Auto Clamped.

Reset Curve

Resets the curve to the initial shape.

Use Clipping

Clipping options. Set up clipping for the stroke.

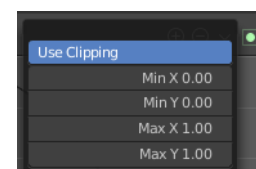

Delete Points

Deletes selected curve points.

Curve window

Tweak and adjust the falloff curve by clicking at a curve point and dragging it around.

Double click adds a new point.

Holding down ctrl activates temporary snapping.

Holding down shift enables slower movement, which allows more accurate setting.

Curve Presets

Predefined curve presets.



Brush Settings Panel - Brush Tip Sub panel

Adjust the color and appearance of the brush cursor to custom values.

Brush Tip Checkbox

Activate the custom settings.

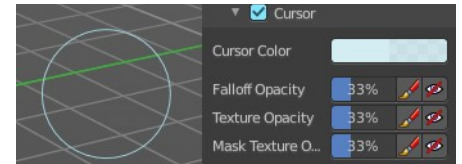

Cursor Color

Choose another color for the brush cursor. Double clicking at the color field will open a color picker.



Falloff Opacity

You can turn on the cursor overlay with the eye button at the end. The falloff opacity slider allows you to adjust the opacity of this cursor overlay.

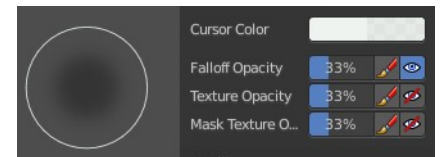

Override Overlay

Hide the Cursor Overlay when painting.

Use Cursor Overlay

Turn on Cursor Overlay.

Texture Opacity

This is for the case when you paint with a texture brush. You can turn on the Texture overlay with the eye button at the end. The falloff opacity slider allows you to adjust the opacity of this cursor overlay.

Override Overlay

Hide the Texture Overlay when painting.

Use Cursor Overlay

Turn on Texture Overlay.

Mask Texture Opacity

This is for the case when you mask paint with a texture brush. You can turn on the Texture overlay with the eye button at the end. The falloff opacity slider allows you to adjust the opacity of this cursor overlay.

Override Overlay

Hide the Texture Overlay when painting.

Use Cursor Overlay

Turn on Texture Overlay.

Tiling panel

Tiling allows you to draw over the borders and continue the stroke at the other side of the image. You can tile in X and Y direction.

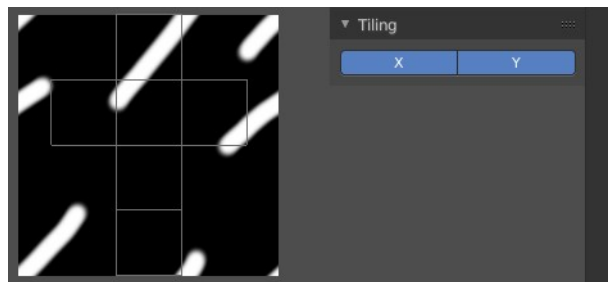



8.3.2 Editors - Image Editor - Sidebar - Image Tab

Table of content

Introduction.....	2
Image Panel.....	3
Source.....	3
Source Type Generated.....	3
X / Y.....	3
Float Buffer.....	3
Generated Type Blank.....	3
Color.....	3
Generated Type UV Grid.....	3
Generated Type Color Grid.....	3
Color Space.....	4
Half Float Precision.....	4
View as Render.....	4
Seam Margin.....	4
Source Type Movie + Image Sequence.....	4
Path edit box.....	4
Pack.....	4
Path edit box.....	4
Open.....	5
Refresh.....	5
Info string.....	5
Frames.....	5
Match Movie Length.....	5
Start.....	5
Offset.....	5
Cyclic.....	5
Auto Refresh.....	5
Deinterlace.....	5
Color Space.....	5
Alpha.....	6
Half Float Precision.....	6
View as Render.....	6
Seam Margin.....	6
Source Type Single Image.....	6
Path edit box.....	6
Pack.....	6
Path edit box.....	6
Open.....	6
Refresh.....	6
Color Space.....	6
Alpha.....	7
Half Float Precision.....	7
View as Render.....	7
Seam Margin.....	7
Source Type Udim.....	7
Info string.....	7
Color Space.....	7

Alpha.....	7
Half Float Precision.....	7
View as Render.....	8
Seam Margin.....	8
UDIM Tiles Panel.....	8
UDIM Tile List.....	8
Number.....	8
Drag Handler.....	8
Search Field.....	8
Invert.....	8
Sort by Name.....	8
Add Tile.....	8
Add Tile dialog.....	9
Number.....	9
Count.....	9
Label.....	9
Fill.....	9
Color.....	9
Width / Height.....	9
Alpha.....	9
Generated Type.....	9
32 bit float.....	9
Remove Tile.....	9
Fill Tile.....	9
Fill tile dialog.....	10
Color.....	10
Width / Height.....	10
Alpha.....	10
Generated Type.....	10
32 bit float.....	10
UDIM Workflow.....	10
Metadata Panel.....	12

Introduction

In the Image tabs you can find further options and image settings. These settings changes, dependent of what you have selected. And in what mode you are

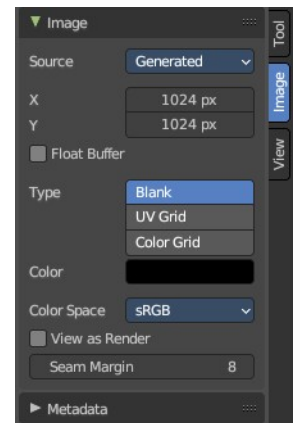

Image Panel

Find image related settings. Size, type, and so on.

Source

Choose the image type. This type gets usually automatically set. When you create a new image, then this image is generated. When you load an image then the Source switches to Single Image.

Generated images does not have a path.

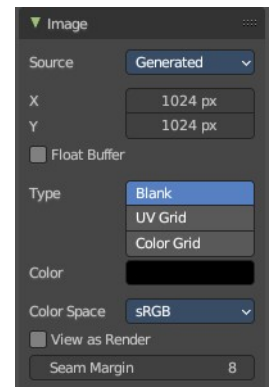
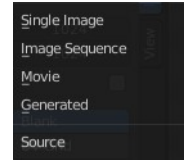

Source Type Generated

X / Y

The image width and height.

Float Buffer

Use a floating point buffer. 8 Bit images uses integers. 32 Bit works with floats.

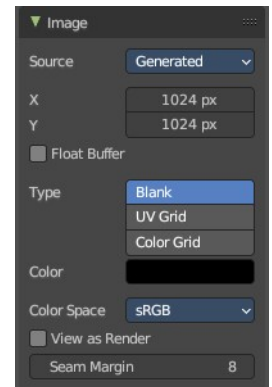

Generated Type Blank

This type displays an image with one blank color

Color

The color of the blank image.

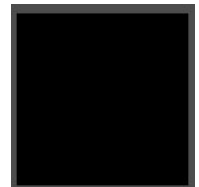

Generated Type UV Grid

This type displays a with a black and white checker texture but colored dots.



Generated Type Color Grid

This type displays a with a colored checker texture with numbers.

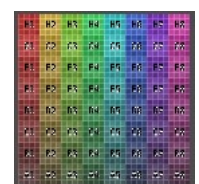

Color Space

Choose the color space type for the image.

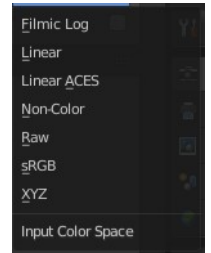

Half Float Precision

Just with image material that uses 32 bit float. Use just 16 Bit per channel instead of the full 32 bit. This lowers the memory usage while rendering.

View as Render

Display the image with using the color management settings. The color management can be adjusted in the properties editor in the Render tab.

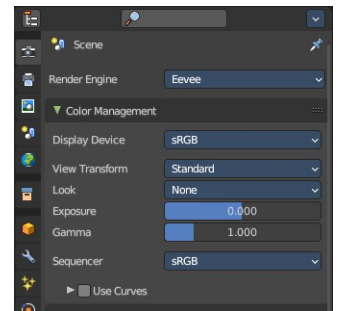

Seam Margin

This option belongs to the UV Editor, and has no effect in the Image editor. Take a margin into account when fixing UV seams during painting.

Source Type Movie + Image Sequence

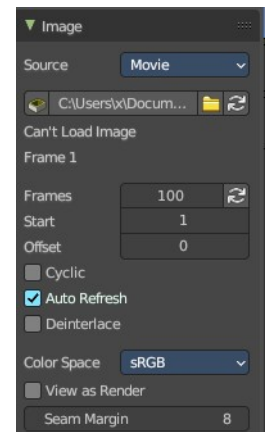
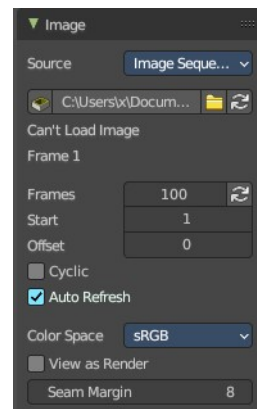

Path edit box

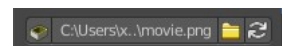

Pack

With this button you can pack the movie or the image sequence into the blend file. It gets packed when you save the blend file the next time.

Path edit box

See and edit the path to your movie or image sequence files.

Open

Open a new movie or image sequence files. A file dialog will appear.

Refresh

Reread the movie or image sequence files.

Info string

Some information about the currently loaded movie. Frames, resolution and color space.

Frames

The number of frames of the movie or image sequence.

Match Movie Length

Set Users Image Length to the one of this video.

Start

The start frame of the movie or image sequence

Offset

Offset the number of the frame to use in the animation. -1 means off.

Cyclic

Cycle the images in the movie.

Auto Refresh

Always refresh image on frame changes.

Deinterlace

Deinterlace the movie file on load.

Color Space

Choose the color space type for the movie or image sequence files.

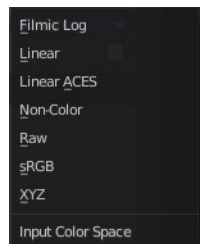

Alpha

Choose the alpha channel mode. Straight or Premultiplied.

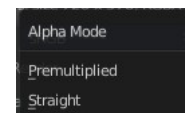

Half Float Precision

Just with image material that uses 32 bit float. Use just 16 Bit per channel instead of the full 32 bit. This lowers the memory usage while rendering.

View as Render

Display the image with using the color management settings. The color management can be adjusted in the properties editor in the Render tab.

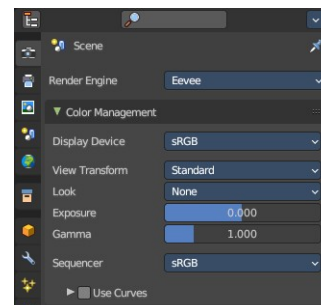

Seam Margin

This option belongs to the UV Editor, and has no effect in the Image editor. Take a margin into account when fixing UV seams during painting.

Source Type Single Image

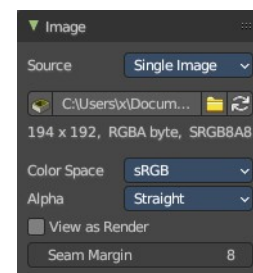

Path edit box

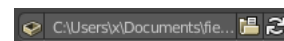

Pack

With this button you can pack the movie or the image sequence into the blend file. It gets packed when you save the blend file the next time.

Path edit box

See and edit the path to your movie or image sequence files.

Open

Open a new movie or image sequence files. A file dialog will appear.

Refresh

Reread the movie or image sequence files.

Color Space

The color space for the image.

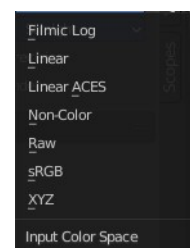

Alpha

How to calculate the alpha channel.

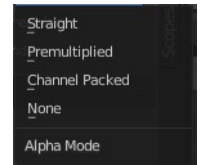

Half Float Precision

Just with image material that uses 32 bit float. Use just 16 Bit per channel instead of the full 32 bit. This lowers the memory usage while rendering.

View as Render

Display the image with using the color management settings. The color management can be adjusted in the properties editor in the Render tab.

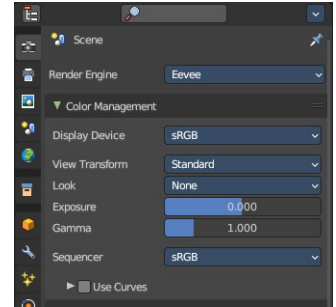

Seam Margin

This option belongs to the UV Editor, and has no effect in the Image editor. Take a margin into account when fixing UV seams during painting.

Source Type Udim

UDIM is an enhancement to the UV mapping and texturing workflow. And does not belong here. But in the UV Editor. It is just in the list because it shares the same menus with the UV Editor.

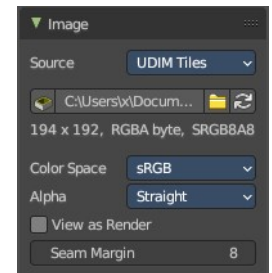

Info string

Some information about the currently loaded image. Resolution and color space.

Color Space

Choose the color space type for the movie or image sequence files.

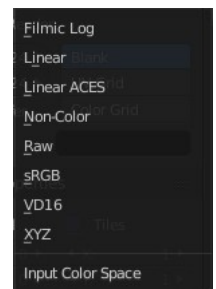

Alpha

Choose the alpha channel mode. Straight or Premultiplied.

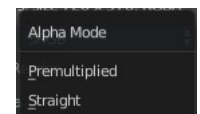

Half Float Precision

Just with color space sRGB. Use just 16 Bit per channel instead of the full 32 bit. This lowers the memory usage while rendering.

View as Render

Display the image with using the color management settings. The color management can be adjusted in the properties editor in the Render tab.

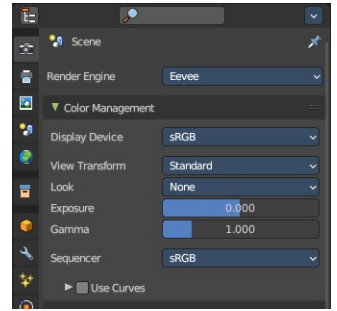

Seam Margin

This option belongs to the UV Editor, and has no effect in the Image editor. Take a margin into account when fixing UV seams during painting.

UDIM Tiles Panel

Manage UDIM tiles. This panel shows with source type UDIM.

UDIM Tile List

List all UDIM tiles associated with the main index (1000 tile). Double clicking on the tile name allows renaming.

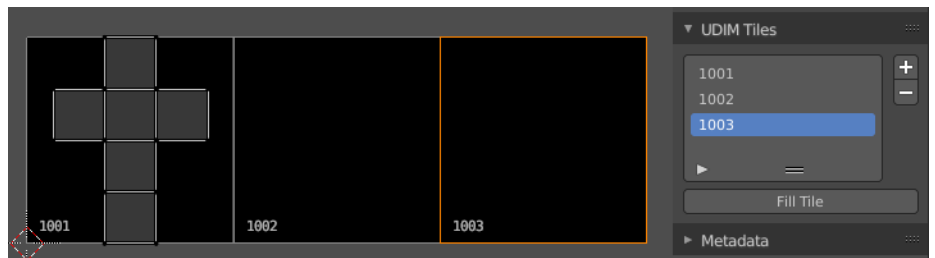

Number

The starting tile index number. UDIMs must start with the 1001 tile and typically increase in incremental order.

Drag Handler

The two vertical lines at the end is a handler with which you can expand the list.

Search Field

You can expand a search field at the bottom of the list. Type in your term and hit enter to filter for your term.



Invert

Exclude the search term instead of searching for it.

Sort by Name

Sort the List by name.

Add Tile

Adds new UDIM tiles to the group.

Add Tile dialog

Number

The UDIM tiles are identified by the number. It is four digits, and with increasing number.

Count

How many tiles to add.

Label

Leave blank to use the Number as the name in the list.

Fill

Fill the new tile with a generated image.

Color

The fill color for generated type Blank.

Width / Height

The dimensions of the image.

Alpha

Does the image have an alpha channel.

Generated Type

The generated texture type.

32 bit float

Generate an image with 32 bit floating point bit depth.

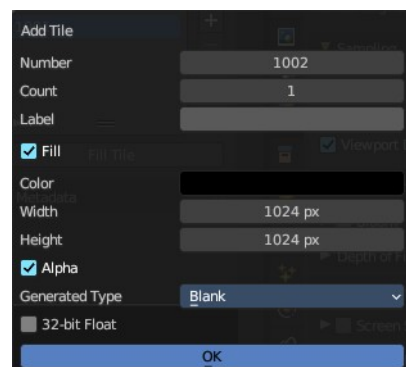

Remove Tile

Remove the selected UDIM tile. Note that the place in the texture will then be blank. The tiles does not resort. The next created UDIM tile will then be placed in this gap.

Fill Tile

Occupy the UDIM tile with a Generated Image. You can change the fill type and texture tile size of a UDIM tile also afterwards with this fill tool. Note that this overwrites the settings of the currently active UDIM tile.

Warning! If a tile is not filled, it will not be saved with the image.

Fill tile dialog

Color

The fill color for generated type Blank.

Width / Height

The dimensions of the image.

Alpha

Does the image have an alpha channel.

Generated Type

The generated texture type.

32 bit float

Generate an image with 32 bit floating point bit depth.

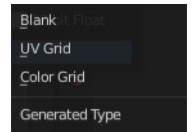
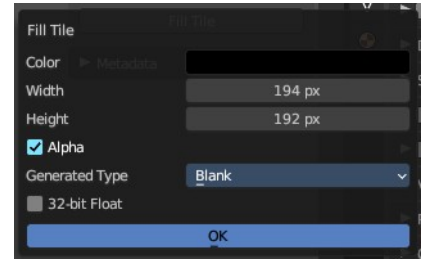

UDIM Workflow

First set up the grid shape for the UDIM tiles.

This panel is in the View tab. And will vanish in the moment you add any texture. So do this setup beforehand. There is no way to show and change this grid panel afterwards.

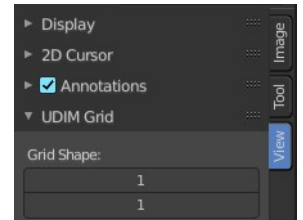

Unwrap your mesh.

Add a generated texture, with generated type Color Grid (optional), and Tiled ticked.

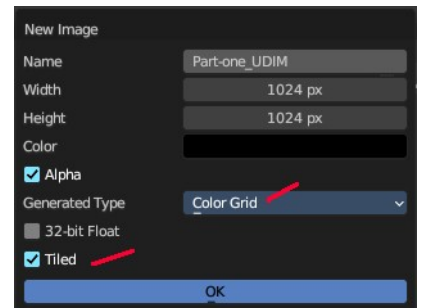

In the viewport you will now see one square UV space again, with the colored background image. And we have our first UDIM tile in the UDIM Tile list.



In the Tile list click at the Add button. And add another image. This time with another resolution.

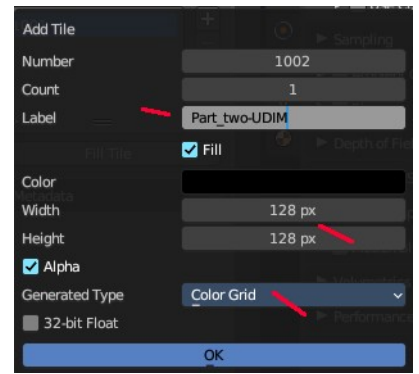

The result is that we have two tiles besides each other, with different resolution.

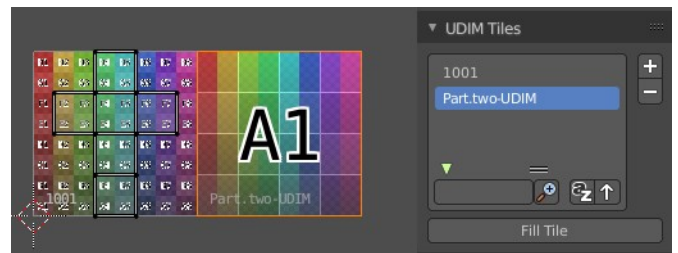

Create a third one. Or as much as you need.



Next move the UV parts to the texture areas where you need them.

Now save the image. And by saving the one UDIM image all the sub images of this UDIM texture gets saved too.

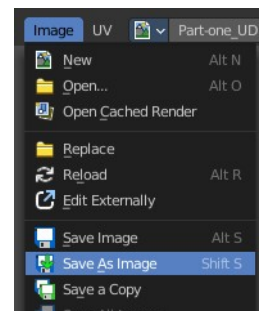
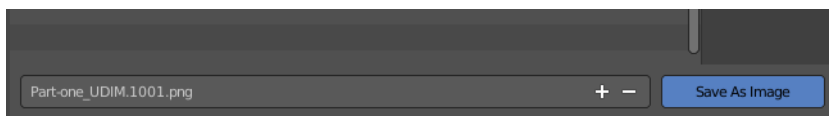

Save the blend file. Modify the textures to your needs.

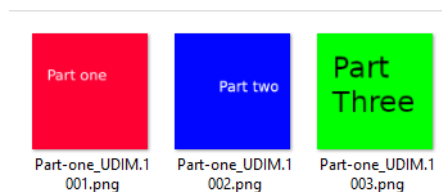
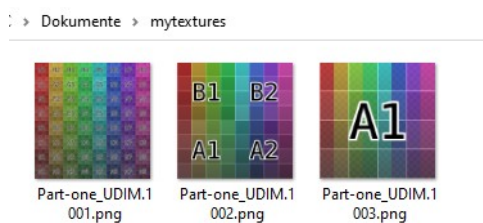

To reload the modified textures either save, close and open Bforartists and reload the scene. Or use Open Image to open the first image of the UDIM textures. The rest will load automatically.

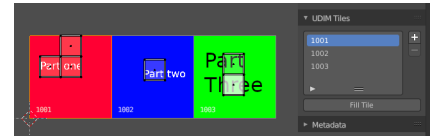

Next create a material. Add a texture. Choose the UDIM texture. And the material will now render with the UDIM textures applied.

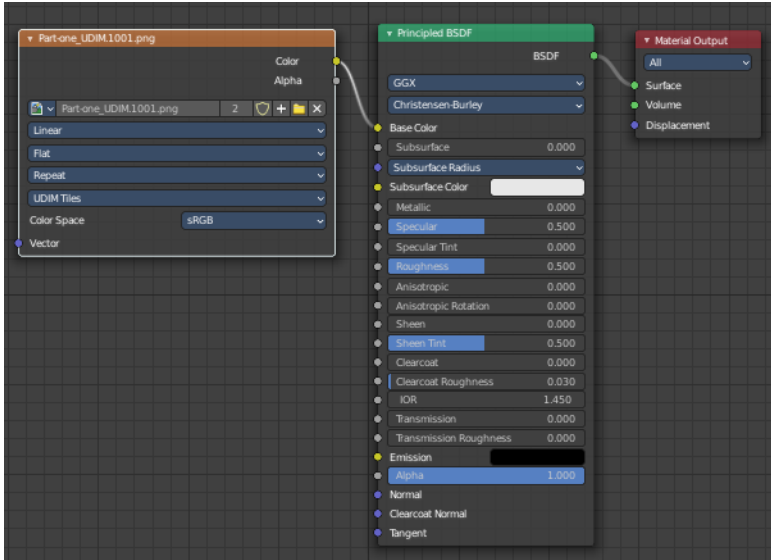
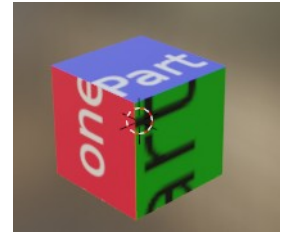

Metadata Panel

Displays existing meta data of the image file.

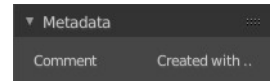



8.3.3 Editors - Image Editor - Sidebar - View Tab

Table of content

Introduction.....	1
Display Panel.....	1
Aspect Ratio X , Y.....	1
Repeat.....	1
2D Cursor Panel.....	2
Annotations Panel.....	2
Annotations prop.....	2
Drop down box.....	2
Edit Box.....	2
Fake User.....	2
Add Annotation.....	2
Delete Annotation.....	2
List of Annotation Strokes.....	2
Thickness.....	3
Frame Locked/Unlocked.....	3

Introduction

The View tab contains some view related settings. And it contains the annotation panel.

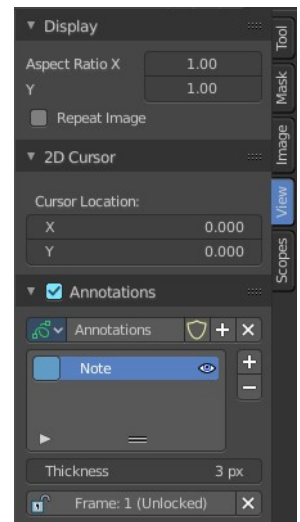

Display Panel

Aspect Ratio X , Y

Set the aspect ratio of the image.

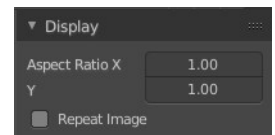

Repeat

With this ticked the image is repeated in the UV Image canvas.

2D Cursor Panel

See and set the 2D cursor location.

This panel is just visible in Mask mode.

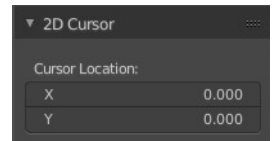

Annotations Panel

Manage the Annotation layers and materials.

When you don't have drawn an annotation yet then the panel just contains a New button.

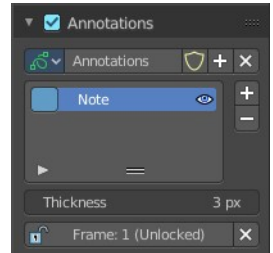
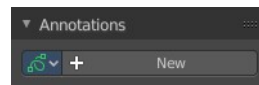

Annotations prop

Add, remove and rename new annotations.

Drop down box

A list of the available annotation layers.

Edit Box

The name of the current annotation. You can rename the annotation to your needs here.

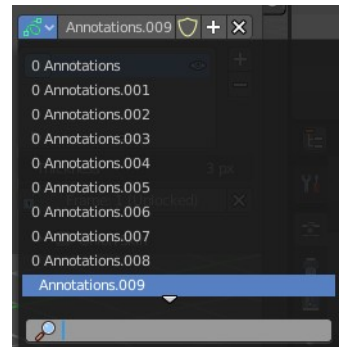

Fake User

Assign a fake user to this annotation. Fake users is an odd concept to keep data in the scene even if it has no user somewhere. The fake user is then a dummy user so that the object is not deleted when saving the scene.

Add Annotation

Add a new annotation.

Delete Annotation

Delete the annotation.

List of Annotation Strokes

Here you see your Annotation layers for the current Annotation. Every layer can have an own color.

At the right side you find buttons to sort them and to add and remove new Annotation layers.

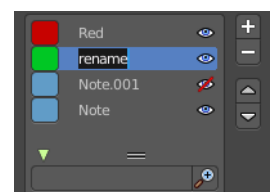

You can change the color by clicking at the color field. A color dialog will pop up. You can rename annotation layers by double clicking at it.

The eye icon allows you to make it invisible And it has a search field.

Thickness

The thickness of the annotation stroke.

Frame Locked/Unlocked

Lock frame displayed by current layer. This toggles whether the active layer is the only one that can be edited.



8.3.4 Editors - Image Editor - Sidebar - Scopes Tab

Table of content

Scopes Tab.....	1
Histogram.....	1
Luma.....	2
RGB.....	2
R/G/B/A.....	2
Show line.....	2
Waveform.....	2
Waveform Opacity.....	2
Waveform Mode.....	2
Luma.....	2
Parade.....	2
YCbCr (jpeg).....	2
YCbCr (ITU 709).....	2
YCbCr (ITU 601).....	2
Red Green Blue.....	2
Vectorscope.....	3
Vectorscope Opacity.....	3
Sample Line.....	3
Luma.....	3
RGB.....	3
R/G/B/A.....	3
Show line.....	3
Samples.....	3
Full Sample.....	3
Accuracy.....	3

Scopes Tab

The Scopes tab contains several panels with analytic tools.

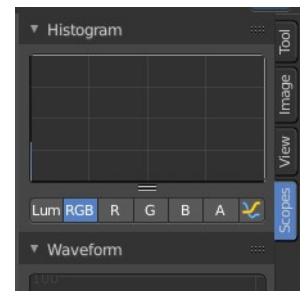

Histogram

Histogram is a graph that displays the color distribution of the pixels in the image. The range from left to right goes from 0, which represents black, to 255, which represents white. And the height represents how much pixels in the image have this specific color.

The different display modes are:

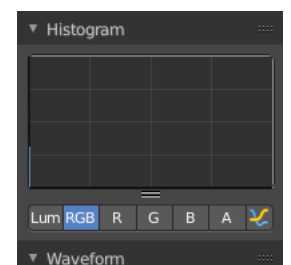

Luma

Shows the luminosity of an image.

RGB

Shows the RGB channels.

R/G/B/A

Shows the R, G, B, A channels.

Show line

Displays lines instead of filled shapes.

Waveform

The waveform graph is another way to display the color information of the image.

Waveform Opacity

Adjust the opacity of the pixels in the waveform histogram.

Waveform Mode

This is a drop down box menu where you can choose further options.

Luma

Shows the luminosity of an image.

Parade

The RGB channels are shown side-by-side.

YCbCr (jpeg)

Displays the channels in the YCbCr standard, fitting to Jpg.

YCbCr (ITU 709)

Displays the channels in the YCbCr standard, fitting to ITU 709 standard.

YCbCr (ITU 601)

Displays the channels in the YCbCr standard, fitting to ITU 601 standard.

Red Green Blue

Shows the RGB channels overlaid as a “Full color” waveform.

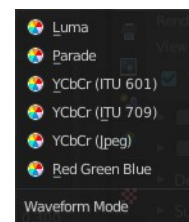
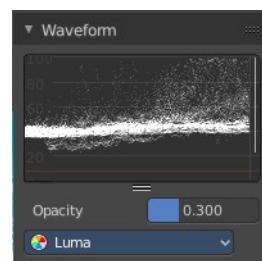

Vectorscope

This is a graph to display the pixel color distribution in the image in a radial way. The radial arrangement allows to display data that is behind the maximum 255 of the normal histogram. This can happen with 32 bit float images for example.

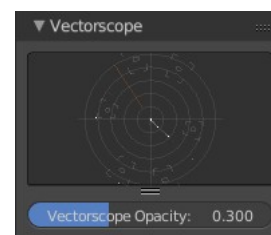

Vectorscope Opacity

Adjust the opacity of the pixels in the waveform histogram.

Sample Line

The Sample Line scope is a graph that allows you to get the sample data from a line.

Click at the Sample Line button above the histogram to draw a line. The pixels under this line will then be used to read the sample data from.

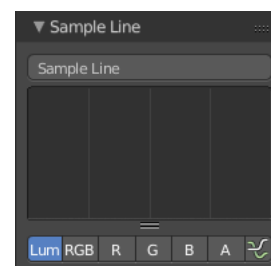

The different display modes are:

Luma

Shows the luminosity of an image.

RGB

Shows the RGB channels.

R/G/B/A

Shows the R, G, B, A channels.

Show line

Displays lines instead of filled shapes.

Samples

The general sample settings for the above histograms. More accurate or more fast.

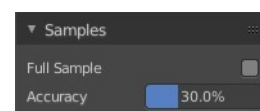

Full Sample

Sample every pixel of the image.

Accuracy

Proportion of original image source pixel lines to sample.



8.3.5 Editors - Image Editor - Sidebar - Mask Tab

Table of content

Introduction.....	2
Mask Settings Panel.....	2
Start Frame.....	2
End Frame.....	2
Mask Layers Panel.....	2
Mask Layer List.....	2
Restrict View.....	2
Restrict Select.....	3
Restrict Render.....	3
Drag Handler.....	3
Search Field.....	3
Invert.....	3
Sort by Name.....	3
Revert.....	3
Add Mask Layer.....	3
Last Operator Add Mask Layer.....	3
Name.....	3
Remove Mask Layer.....	3
Move Layer.....	3
Opacity.....	4
Invert.....	4
Blend.....	4
Falloff.....	4
Overlap.....	4
Holes.....	4
Mask Layers Panel.....	4
Feather Offset.....	4
Interpolation.....	4
Cyclic.....	5
Fill.....	5
Self Intersection Check.....	5
Active Point Panel.....	5
Parent.....	5
Parent Type.....	5
Object.....	5
Track.....	5

Introduction

The mask tab just shows in Mask mode and with an existing mask.

It contains tools and settings for the mask mode. Like a layer system.

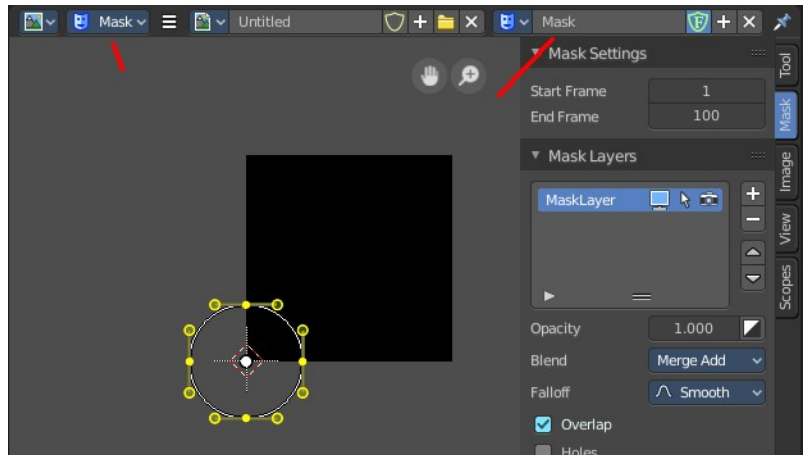

Mask Settings Panel

This values are of interest for the Sequencer, where you work with movies and image sequences.

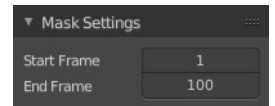

Start Frame

Set the first Frame of the mask.

End Frame

Set the last Frame of the mask.

Mask Layers Panel

When you add a spline, a circle or a square or a freehand one, then a Mask Layer gets created.

You can create several mask layers and work with them in the sequencer or the Node editors. They can be used to create complex shapes, and define how the splines interact with each other. Splines at the same layer can be animated together.

Splines can be copied and pasted from one layer to another.

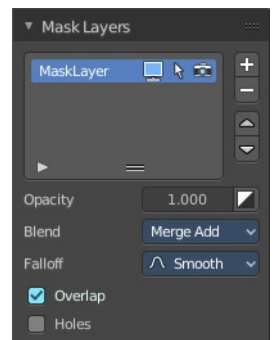

Mask Layer List

The list of available mask layers.

Restrict View

Don't show this mask layer in the viewport.

Restrict Select

Selection in the viewport is enabled or disabled. The spline handlers becomes invisible.

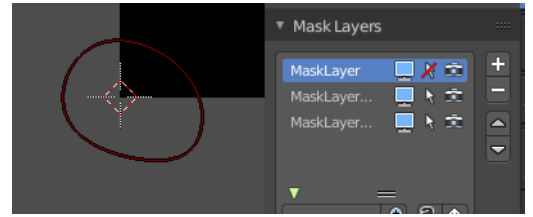

Restrict Render

Don't render this mask layer for the final image(s).

Drag Handler

The two vertical lines at the end is a handler with which you can expand the list.



Search Field

You can expand a search field at the bottom of the list. Type in your term and hit enter to filter for your term.



Invert

Exclude the search term instead of searching for it.

Sort by Name

Sort the List by name.

Revert

Revert the list. The last list item becomes the first, and vice versa.

Add Mask Layer

Add a new mask layer to the list.

Last Operator Add Mask Layer

Name

Rename the new created mask layer.

Note that you can also rename it in the list.

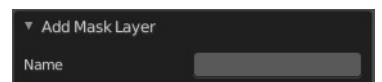

Remove Mask Layer

Remove the currently selected mask layer from the list.

Move Layer

Move the selected layer up or downwards in the list.

Opacity

Set the opacity of the mask layer.

Invert

Inverts the values (colors) in the mask layer.

Blend

Adjust the layer blending.

Note, Merge add and Merge subtract should be used with a Feather on overlapping masks to get a better result.

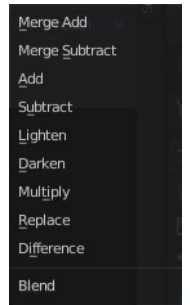

Falloff

Adjust the Feather falloff

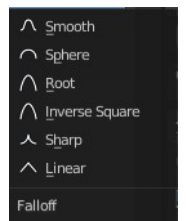

Overlap

Fill self-intersecting areas.

Holes

Overlapping splines from the same layer will generate holes in the mask.

Mask Layers Panel

When there is a spline in the current mask layer, then the Active Spline Panel shows. Adjust some settings for the currently active spline.

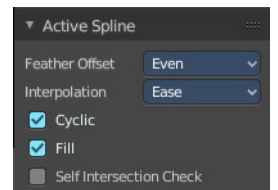

Feather Offset

The method to calculate the feather offset.

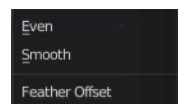

Interpolation

The weight interpolation method.

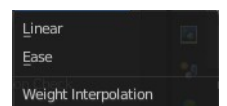

Cyclic

Make the spline closed or open.

Fill

Fill the spline.

Self Intersection Check

Prevent feather from self intersecting.

Active Point Panel

When you select a point of one of the splines, then the Active Point Panel will show up.

This panel is of interest for motion tracking. Control Points can be parented to motion tracks. And this allows to mask out parts of the motion tracked footage.

The masking happens at the Viewer Node.

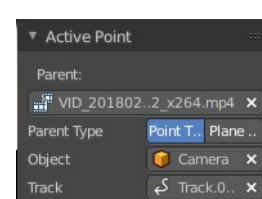
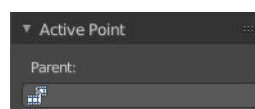

Parent

Choose the motion track that you want to parent the control point to.

Parent Type

Choose between the methods Point Track or Plane Track.

Object

The parent object. Usually the camera where you track from.

Track

Choose the tracking point that you want to follow with the mask.



9 Editors - UV Editor

Table of content

UV Editor.....	3
Navigating in the UV Image Editor viewport.....	3
Hotkeys.....	4
Navigation Elements.....	4
2D Cursor.....	4
UV context menu.....	4
Unwrap.....	4
Last Operator Unwrap.....	4
Method.....	4
Fill Holes.....	5
Correct Aspect.....	5
Use Subsurf Modifier.....	5
Margin.....	5
Follow Active Quads.....	5
Last Operator Follow Active Quads.....	5
Edge Length Mode.....	5
Pin.....	5
Unpin.....	5
Snap.....	6
Last Operator Snap Selection and Snap Cursor.....	6
Target.....	6
Last operator Pin.....	6
Clear.....	6
Mirror X.....	6
Mirror Y.....	6
Last Operator Mirror.....	6
Orientation.....	6
Constraint Axis.....	6
Proportional Editing.....	7
Proportional Editing Falloff.....	7
Connected.....	7
Projected(2D).....	7
Straighten.....	7
Straighten X.....	7
Straighten Y.....	7
Align Auto.....	7
Align X.....	7
Align Y.....	7
Last operator Align.....	8
Axis.....	8
Merge.....	8
At Center.....	8
At Cursor.....	8
Last operator Snap Selection.....	8
Target.....	8
By Distance.....	8
Last operator Merge UVs by Distance.....	8

Merge Distance.....	8
Unselected.....	8
Stitch.....	9
Last Operator Stitch.....	9
Use Limit.....	9
Snap Island.....	9
Limit.....	9
Static Island.....	9
Active Object.....	9
Snap at Midpoint.....	9
Clear Seams.....	9
Operation Mode.....	9
Split.....	10
Selection.....	10
Quick Favorites menu.....	10
Slider snapping.....	10
Hotkey only functionality.....	10
Loop Select - Alt Left Mouse.....	10
Loop Select - Shift Alt Left Mouse.....	11
Edge Ring Select - Ctrl Alt Left Mouse.....	11
Edge Ring Select - Shift Ctrl Alt Left Mouse.....	11
Unwrap - U.....	11
Last Operator Unwrap.....	11
Method.....	11
Fill Holes.....	11
Correct Aspect.....	11
Use Subsurf Modifier.....	11
Margin.....	11
Pick shortest path.....	11
Last operator Pick shortest path.....	12
Face stepping.....	12
Topology Distance.....	12
Deselected.....	12
Selected.....	12
Offset.....	12

UV Editor

The UV Image Editor is the place where you can display and edit the UV mapping, which doesn't necessarily require to have an image to be loaded.

The functionality of the UV Editor is connected to the 3D view. You need to have a mesh object selected, and you need to be in Edit mode to show the UV wire.

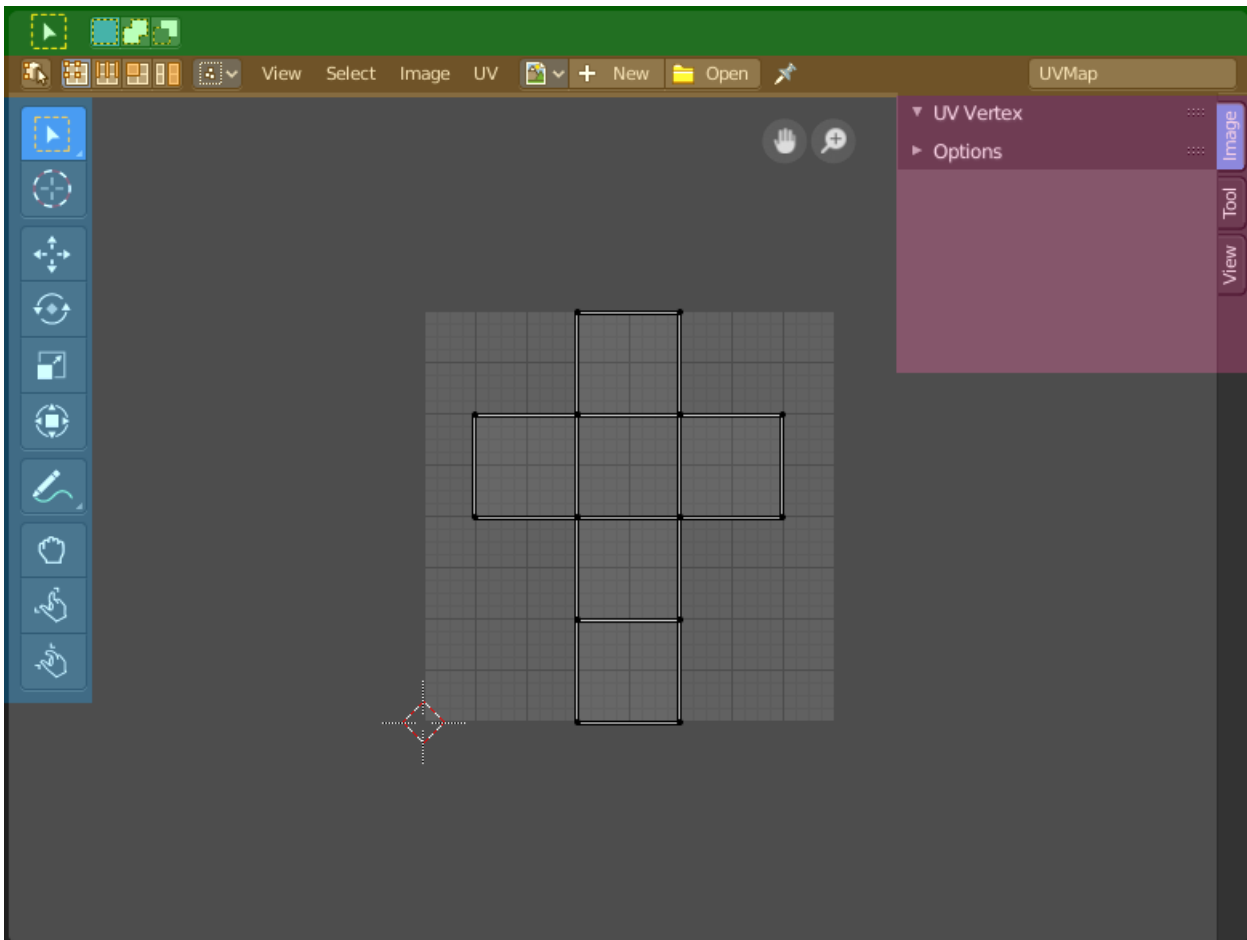

The UV editor is divided into several areas has several tool areas.

Green - Tool Settings Area

Grey - Viewport

Orange - Header

Blue - Tool Shelf

Pink - Sidebar

The Tool Settings area contains the same functionality than the Tools tab in the Sidebar. So we won't cover it.

Navigating in the UV Image Editor viewport

Hotkeys

Pan the view - MMB

Zoom - Mouse Wheel, LMB+CTRL, Numpad + / -

Navigation Elements

There are also two navigation elements for panning and zoom in the upper right corner. Click at them, hold the mouse button down, and move.

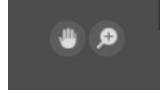

2D Cursor

The 2D Cursor is the center point for tool operations. It can be set to mouse position with Alt + Right Mouse click. Or with the Cursor tool in the

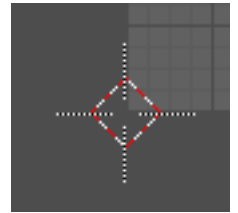

UV context menu

When you double right click into the viewport, then you will open a menu. The UV Context menu. Its content is to 100% double content to already existing menus. And it is despite the name not contextual.

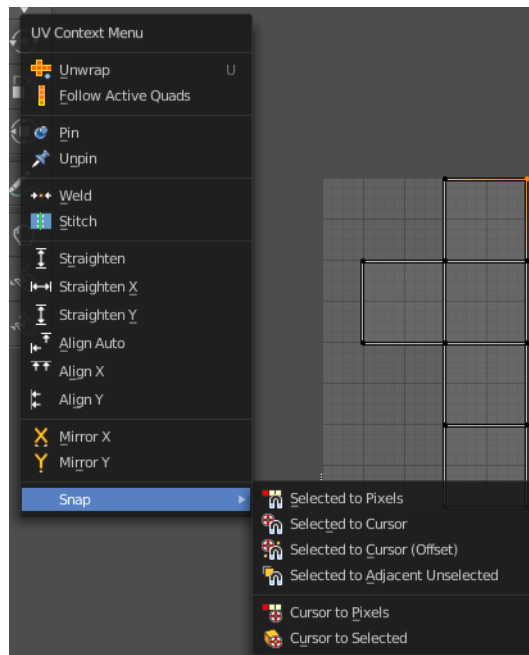

Unwrap

Unwraps the selected geometry with the method Angle based. ABF stands for Angle Based Flattening.

Last Operator Unwrap

The last operator appears in the 3D view. Unwrap ABF and Unwrap LSCM shares the same Last Operator.

Method

Method is a drop down box where you can choose between Unwrap method Angle Based and Conformal.

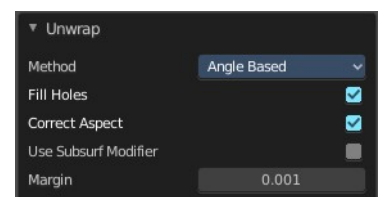

Fill Holes

Fill holes in the mesh before unwrapping.

Correct Aspect

Take the Image Aspect Ratio into account.

Use Subsurf Modifier

Unwraps an existing Subsurf Modifier. You need to add a Subsurf Modifier first.

Margin

The distance between the single UV patches.

Follow Active Quads

Follow Active quads maps UV coordinates starting from an active face, and maps all adjacent faces in quad shape then. This way you can for example unwrap a pipe or a road. You first need to have a face selected. Then select everything. And then click at Follow Active Quads.

Last Operator Follow Active Quads

The Last Operator contains the same settings than the Settings dialogue.

Edge Length Mode

Edge Length Mode is a drop-down box where you can choose the Length method.

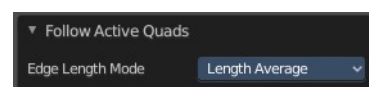

Pin

Pins the selected vertices . This vertices are now nailed for the unwrap algorithms Angle based and Conformal. Their positions will not change when you repeat the unwrapping. And the algorithms will try to fit the rest of the geometry to this pinned vertices.

Pinned vertices are marked red.

A use case is for example when you have a distorted result for symmetric geometry like a face with the Conformal method. Then you can try to align two center vertices, pin them, and repeat the conformal method. It may be more symmetrical afterwards.

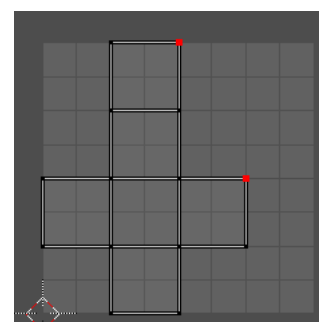

Unpin

Unpins pinned geometry.

Snap

Snap is a sub menu with some snapping tools. The menu items should be pretty self explaining. Selected to Pixels snaps the selected geometry to the pixels of the image, and so on.

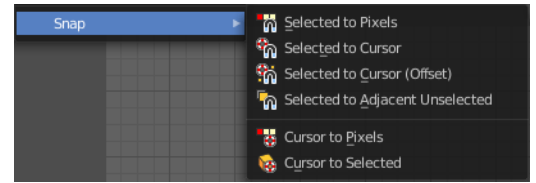

Last Operator Snap Selection and Snap Cursor

Target

Set the snap target method again.

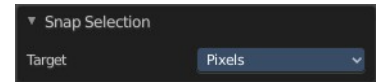
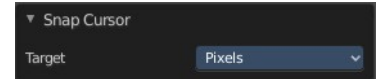

Last operator Pin

This last operator appears in the 3D view. Pin and unpin shares the same last operator.



Clear

Unpins pinned geometry.

Mirror X

Mirrors the selection along the X axis. The mirror point is the pivot of the selection.

Mirror Y

Mirrors the selection along the Y axis. The mirror point is the pivot of the selection.

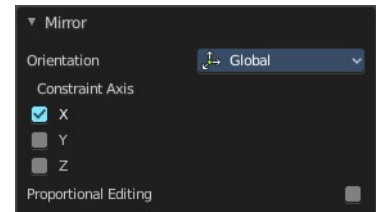

Last Operator Mirror

The Last Operator Mirror panel gives you tools to adjust the mirror action.

Orientation

Orientation is a drop-down box where you can choose the type of orientation for the mirroring action.

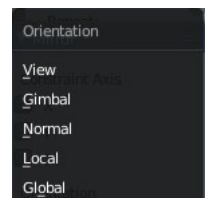

Constraint Axis

Constraint Axis gives you the possibility to define the mirror axis. You can choose more than one axis here.

Proportional Editing

Activates proportional editing

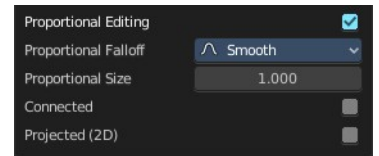

Proportional Editing Falloff

Proportional Editing Falloff is a drop-down box where you can choose a method for the falloff for the proportional editing.

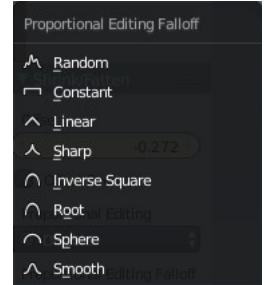

Connected

The proportional falloff gets calculated for connected parts only.

Projected(2D)

The proportional falloff gets calculated in the screen space. Depth doesn't play a role. When it's in the radius, then it gets calculated.

Straighten

Straightens the selected geometry in both directions, X and Y axis.

Straighten X

Straightens the selected geometry along the X axis.

Straighten Y

Straightens the selected geometry along the Y axis.

Align Auto

Aligns the selection. The align axis gets chosen from the selection itself. When it's higher than tall, then it aligns along the Y axis. When it's taller than high, then it aligns along the X axis.

The align point is the pivot of the selection.

Align X

Aligns the selection along the X axis. The align point is the pivot of the selection.

Align Y

Aligns the selection along the Y axis. The align point is the pivot of the selection.

Last operator Align

The Last operator Align unions all the single straighten and align actions in one operator.



Axis

Lists the straighten and align methods again.

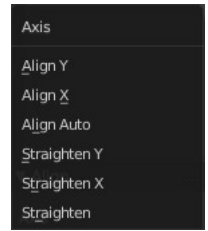

Merge

At Center

Merges the selected vertices at the center.

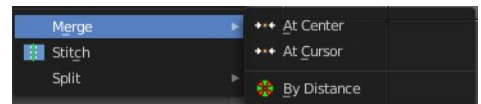

At Cursor

Merges the selected vertices at the 2d cursor

Last operator Snap Selection

Target

To which element to snap to.

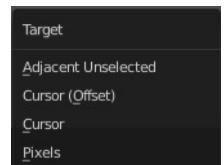
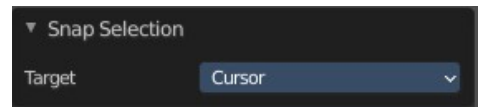

By Distance

Merge vertices that are below a specified distance to each other.

Last operator Merge UVs by Distance

Merge Distance

Maximum distance for welding vertices.

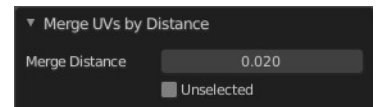

Unselected

Merge selected vertices to other unselected vertices.

Stitch

Stitch tries to union UV patches along the selected edges or vertices.

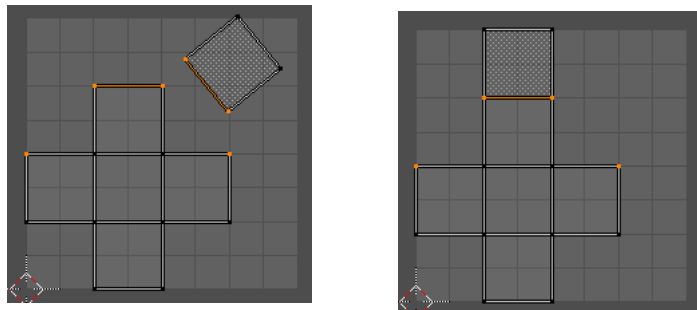

Last Operator Stitch

This last operator appears in the 3D view.

Use Limit

Just snap when the elements are below a given distance.

Snap Island

Snap the whole UV patch, or just the selected edge(s)/vertices

Limit

The limit distance for Use Limit.

Static Island

Adjust which island stays in place when stitching.

Active Object

Index of the active object.

Snap at Midpoint

Snap at the center point of the two elements instead the first to the last.

Clear Seams

Unmarks seams when stitching.

Operation Mode

The operation mode. Calculate with Edges or Vertices.

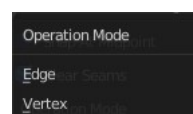
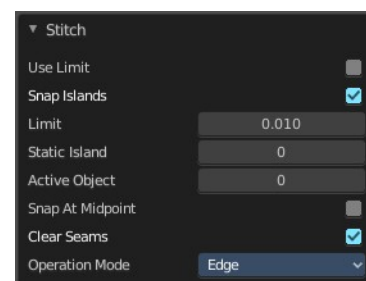

Split



Selection

Split the selected geometry from the not selected geometry.

Quick Favorites menu

When you right click at a menu or a button, then a right click menu will open. Tools have usually an Add to Quick Favorites menu entry.

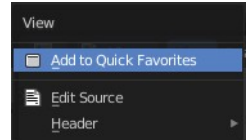

The Quick Favorites Menu is empty by default. With Add to Quick favorites you can add this menu to the Quick menu.

In the 3D view we have a menu called Quick in the header, which shows this content then. In the Image Editor you can just call it with its hotkey. Q. It has no regular menu entry here.

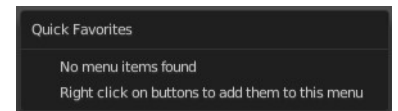

Slider snapping

Snapping also works at sliders. Hover with the mouse over the slider, start to slide, and holding down **Ctrl** will snap the sliders in incremental steps.

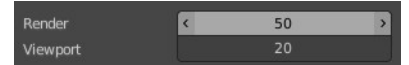

When it's a default value between 0 and 1 then it usually snaps in 0.1 steps. When it's a default value over 1 then it usually snaps in steps of 10.

Hotkey only functionality

Important! These hotkeys works with the default Bforartists key map And they do not list the N dof hotkeys. N dof is a 3d connexion mouse device that is also used for tablets.

Most of the tools can be found in the graphical UI. But there are still some tools that are hotkey only. Some have a UI brother with equal functionality. For example, Pick shortest path is the hotkey sister of Select shortest path. Some are hotkey only since they cannot be integrated in the graphical UI. Like calling the File menu under the mouse. Or mouse position dependent functionality like selecting an edge loop.

The navigation hotkeys and the context menus are excluded here since they are already covered.

Loop Select - Alt Left Mouse

Select an edge loop.

Loop Select - Shift Alt Left Mouse

Select an edge loop. Adds to selection.

Edge Ring Select - Ctrl Alt Left Mouse

Select an edge ring.

Edge Ring Select - Shift Ctrl Alt Left Mouse

Select an edge ring. Adds to selection.

Unwrap - U

Unwraps the selected geometry. This operator starts with the method Angle based.

Last Operator Unwrap

The last operator appears in the 3D view. Unwrap ABF and Unwrap LSCM shares the same Last Operator.

Method

Method is a drop down box to choose between Unwrap method Angle Based and Conformal.

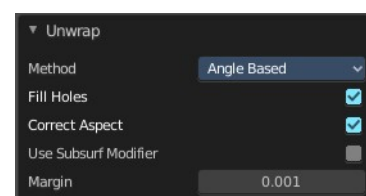

Fill Holes

Fill holes in the mesh before unwrapping.

Correct Aspect

Take the Image Aspect Ratio into account.

Use Subsurf Modifier

Unwraps an existing Subsurf Modifier. You need to add a Subsurf Modifier first.

Margin

The distance between the single UV patches.

Pick shortest path

Click at the first edge or vertice, hold down ctrl, click at the last edge or vertice.

Last operator Pick shortest path

Face stepping

Traverse connected faces. Including diagonals and edge rings.

Topology Distance

Find the minimum number of steps. And ignore the spatial distance.

Deselected

Don't select the whole path, but just every nth element of it.

Selected

This is connected to nth element. Number of elements to skip at once.

Offset

This is connected to nth element. Start with an offset.

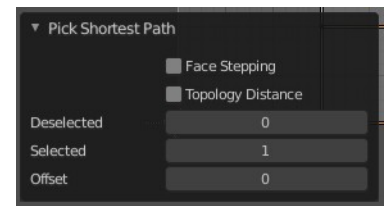



9.1 Editors - UV Editor - Header

Table of content

UV Editor - Header.....	1
Switch to UV / Image editor.....	1
Header right click menus.....	1
Editor type Menu.....	2
Sub Modes.....	2
UV Select Sync off.....	2
Vertex selection mode.....	2
Edge selection mode.....	2
Face selection mode.....	2
Island selection mode.....	2
Sticky Selection mode.....	3
Disabled.....	3
Shared Location.....	3
Shared Vertex.....	3
UV Select Sync on.....	3
Vertex selection mode.....	4
Edge selection mode.....	4
Face selection mode.....	4

UV Editor - Header

The Header contains various menus, navigation elements, settings and tools for the viewport. This content differs, dependent of the sub mode.

The header is divided into two areas. Left mode and menus. Right settings.



Switch to UV / Image editor

Sometimes you want to switch from the UV Editor to the Image Editor. Or vice versa. To continue at the unwrap or to paint a texture.

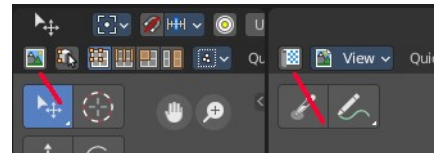

This two editors are connected by a menu that allows exactly that. A button in each header that switches to the other editor.

Header right click menus

The general right click menu functionality is explained in chapter 6 Editors introduction.

Editortype Menu

Bforartists is made of several editor types. Headers can display a menu where you can switch to other editor types.

This menu is hidden by default. It is meant to edit the layouts, and should not be necessary for regular work. You can reveal it in the header right click menu.

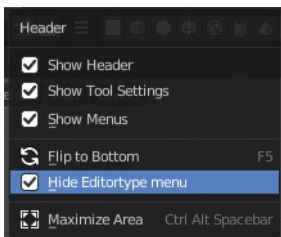
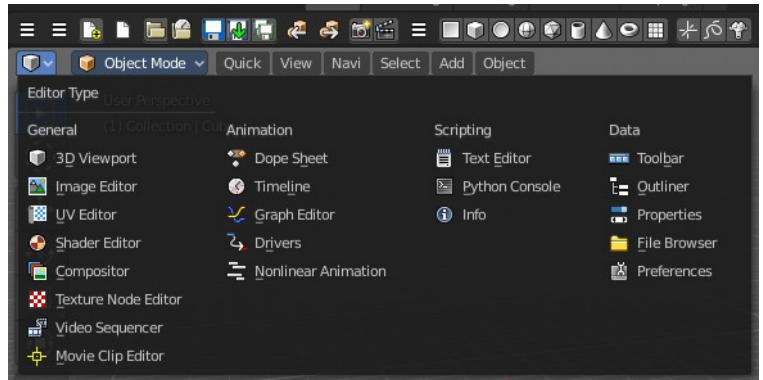

Sub Modes

The UV Editor has two sub modes. Sync Off and Sync On.

UV Select Sync off

With **UV Select Sync off** you will be able to modify single UV elements, like whole UV patches. And the 3D view will not change its selection.



When you have some geometry in the 3D view not selected, then it will not show up in the UV image editor neither.

You can switch between the selection modes with hotkeys 1, 2, 3, 4

Vertex selection mode

Select vertices in the UV geometry.

Edge selection mode

Select edges in the UV geometry.

Face selection mode

Select single faces in the UV geometry

Island selection mode

Select whole UV patches in the UV geometry.

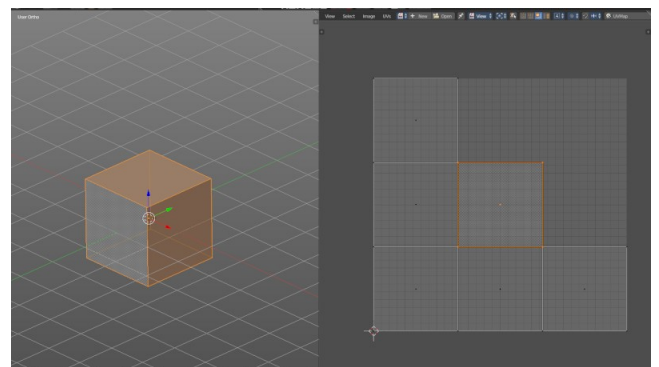

Sticky Selection mode

This options controls how UV's are selected when Sync Selection is off. This mainly affects vertices. But edge and face selection relies at vertices too.

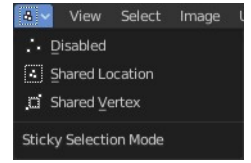

Disabled

No sticky selection. You can just move one UV vertice at time. In case you have two vertices above each other, like with a UV patch with two faces, then just one vertice gets selected. Even when it's the same UV patch.

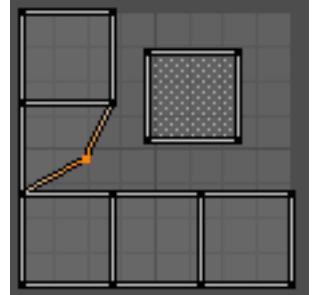

Shared Location

Selects all UV vertices under the mouse in case it's part of the same UV patch. Vertices of other UV patches gets ignored.

In this shot the two down left faces are one UV patch.

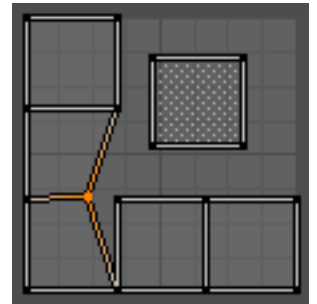

Shared Vertex

Selects all UV vertices that shares the same vertice at the 3D mesh. Regardless if it's the same UV patch or not.

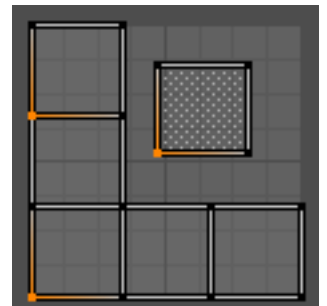

UV Select Sync on

With **UV Select Sync on** you will keep selections of UV space and 3D view in sync. But you cannot modify single UV elements anymore. In this mode you work with Vertices, Edges and Faces.



All UV geometry of the object will show up, no matter what's selected in the 3D view.

You can switch between the selection modes with hotkeys 1, 2, 3. Note that this selection mode is in sync with the selection modes in the 3D view. When you change it in the one editor, then it changes in the other editor too.

Vertex selection mode

Select vertices in the UV geometry and at the 3D mesh object.

Edge selection mode

Select edges in the UV geometry and at the 3D mesh object.

Face selection mode

Select single faces in the UV geometry and at the 3D mesh object.

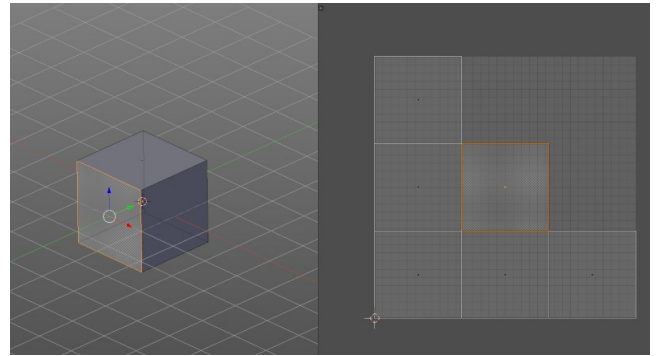



9.1.1 Editors - UV Editor - Header - Header Tools and Options

Table of content

UV Editor - Header Tools.....	2
Pivot.....	2
Snapping.....	2
Snapping Settings.....	2
Absolute Grid Snapping.....	2
Affect.....	3
Proportional Editing.....	3
Settings.....	3
Proportional Size.....	3
UV Map Property.....	3
Image Prop.....	4
List of images in the scene.....	4
Search form.....	4
Image Edit Box.....	4
Number of Fake Users.....	4
Fake User.....	4
Open.....	4
Remove.....	4
New Image.....	4
Name.....	4
Width.....	5
Height.....	5
Color.....	5
Alpha.....	5
Generated Type.....	5
32 Bit Float.....	5
Duplicate.....	5
Unlink Datablock.....	5
Fake User.....	5
Open Image.....	5
Unpack.....	6
User.....	6
Use Image Pin.....	6
Show Overlays.....	6
Guides.....	6
Grid.....	6
Dynamic / Fixed / Pixel.....	6
Grid over Image.....	6
Tiles.....	6
Display Stretch.....	7
Display Stretch Type.....	7
Area.....	7
Angle.....	7
Geometry.....	7
UV Opacity.....	7
Display as.....	7
Modified Edges.....	7

Faces.....	7
Image.....	8
Show Metadata.....	8
Display Channels.....	8
Color and Alpha.....	8
Color.....	8
Alpha.....	8
Red.....	8
Green.....	8
Blue.....	8
Options Panel.....	8
Constrain to Image Bounds.....	8
Live Unwrap.....	8
Update Automatically.....	9
UV local view.....	9
Show Metadata.....	9
Snap to Pixels.....	9

UV Editor - Header Tools

The header contains several tools, dependent of what you do and what tool set is selected.



Pivot

What pivot point to use for selected elements.

When you rotate or scale an UV patch, or a group of vertices/edges/faces, you may want to set the pivot point to a specific location of the selection. The names should be self explaining.

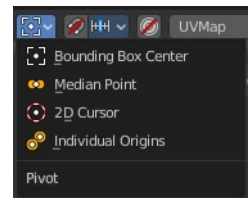

Snapping

Activate snapping when transforming an element.

Snapping can be temporarily activated by holding CTRL key. So no need to turn snapping on and off all the time.

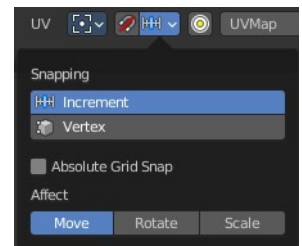

Snapping Settings

You can snap to various scene elements. This menu allows you to define to which other elements the current active element should snap to. The names should be self explaining. Increment snaps by a grid unit.

Absolute Grid Snapping

Absolute grid alignment while translation, based on the pivot center.

Affect

Adjust what transform methods should be affected by snapping.

Proportional Editing

Enables proportional editing.

Proportional Editing is a way of transforming selected elements (such as vertices) while having that transformation affect other nearby elements with a falloff. For example, moving a single vertex will move unselected vertices within a given range. And the falloff means that selected vertices that are closer to the selected vertex will move more than those farther from it.

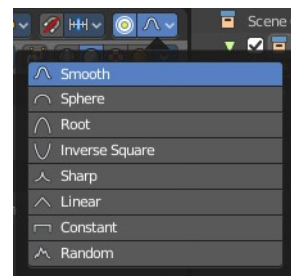

Settings

The settings appears when you activate Proportional Editing. Choose between different falloff methods for the proportional editing. The settings hides when proportional editing is off.

Proportional Size

When proportional editing is on then you will see a black circle around the selection that defines the influence area of the proportional editing.

This value can be adjusted with the scroll wheel, the page up and page down hotkeys, and in the last operator panel of the transform tools.

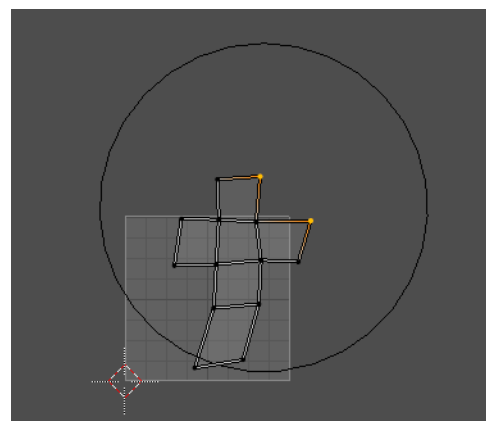

UV Map Property

A mesh can have more than one UV map. You create them in the Properties editor in the Object Data Properties tab in the UV Map Panel.

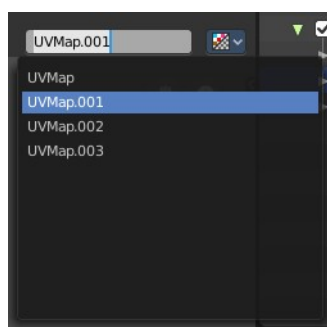

The property in the header allows you to switch to another UV map, and to rename the UV map.

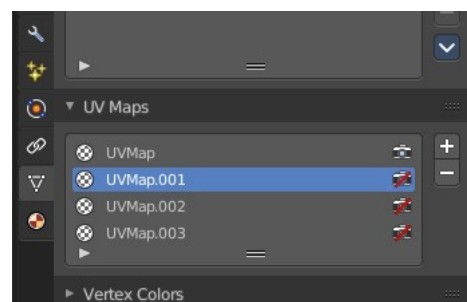
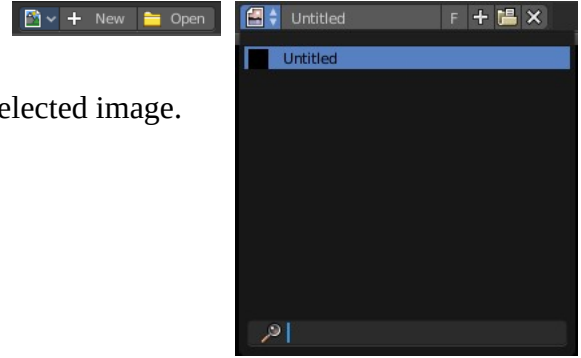

Image Prop

This property contains the list of loaded images. When no image is loaded then it displays the New and Open Buttons.

When an image exists then it displays the name of the currently selected image.



From left to right ...



List of images in the scene

This is a list of the images in the scene. This list allows you to switch to other images.

Search form

Search for specific images.

Image Edit Box

Read the name of the currently selected image. And you can rename the image here too.

Number of Fake Users

In case this file has a fake user assigned, then this number displays the number of fake users.

Fake User

With this button you assign a fake user to this selected image.

Data, like images, that is not longer linked to anything else gets removed when you save and reload a scene. Bforartists has the concept of fake users to go around this behavior. An image with a fake user is in fact linked to something. And so it is not lost when you save and reload the scene.

Open

Open a new image.

Remove

Removes the image.

New Image

Create a new image.

Creates a new image. You will get a dialog where you can define settings for the new image.

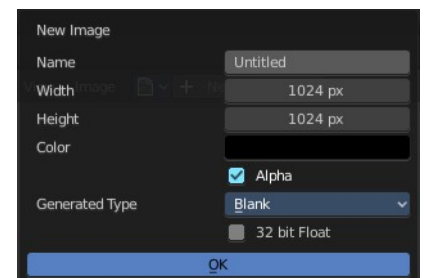

Name

The name of the new image

Width

The width of the new image.

Height

The height of the new image.

Color

Adjust the color of the new image. A click will call a color picker.

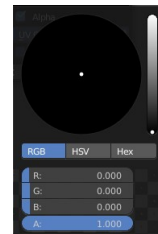

Alpha

Check this checkbox if the new image should have an alpha channel.

Generated Type

Here you can define what kind of texture you want to create.

Blank is one plain color.

UV Grid is a checker texture in black and white.

Color Grid is a colored checker texture.

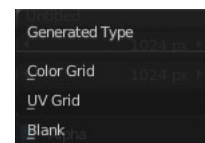

32 Bit Float

Check this checkbox if the image should be in 32 Bit floating point bit depth per channel. Else it is in 8 bit per channel.

Duplicate

Not supported here.

Unlink Datablock

This deletes the selected image. Unfortunately not immediately. You need to save the scene and to reload it.

And you need to make sure that it is not linked to anything else. A mesh or a fake user for example. Have a look if there is a number besides the F button. When this is the case then the image has still a user, and so still loads with loading the scene.

Fake User

With this button you assign a fake user to this selected image.

Data, like images, that is not longer linked to anything else gets removed when you save and reload a scene. Bforartists has the concept of fake users to go around this behavior. An image with a fake user is in fact linked to something. And so it is not lost when you save and reload the scene.

Open Image

Opens the file browser to load an image.

Unpack

Unpack packed files to a directory.

User

The number of users that uses this data. Data with a user number of 0 will be removed with closing Bforartists.

Use Image Pin



When you select another object. for UV mapping for example, then usually the connected images for this object gets displayed. Use image pin nails the currently selected image so that it stays displayed.

Show Overlays

Guides

Grid

Display the ground grid.

Dynamic / Fixed / Pixel

Display the ground grid in defined resolution.

Dynamic adapts to the image size.

Fixed uses a fixed grid resolution. The method Fixed reveals x y edit boxes to set up the fixed resolution.

Pixel orients the grid size at the pixel resolution.

Grid over Image

Display the grid over the image.

Tiles

Display more tiles in the viewport than just the one in the 0-1 range. This is needed in conjunction with UDIM tiles.

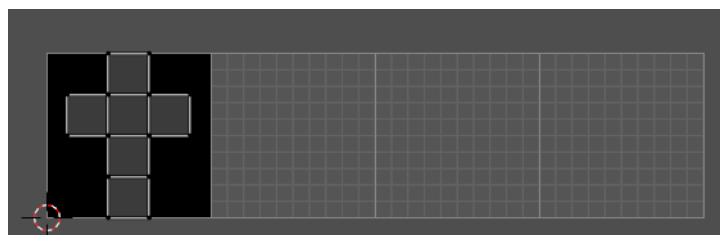
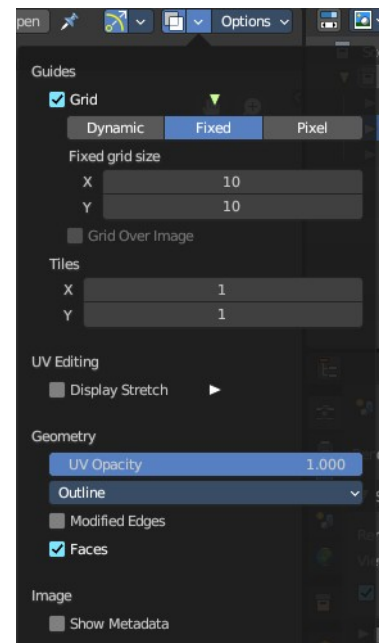

Display Stretch

Display the uv mapping with different colors, dependant of the stretchiness of the uv mapped mesh. The different colors shows you how distorted the texture at the mesh is displayed. Blue is no stretching. Red is highly distorted stretching.

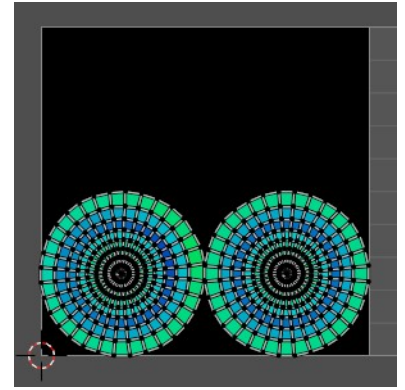

Display Stretch Type

Area

Calculates the stretch between UV and 3D faces.

Angle

Calculates the angular distortion between UV and 3D faces.

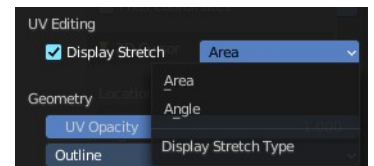

Geometry

UV Opacity

The opacity of the UV wireframe.

Display as

How to display the UV wireframe.

Modified Edges

Display the edges after the modifiers is applied. Else it shows the edges before the influence of the modifiers.

Faces

Show the faces in the UV Wireframe. Not available with Display Stretch since Display Stretch needs to display the faces to work.

Image

Show Metadata

Display existing metadata in the viewport.

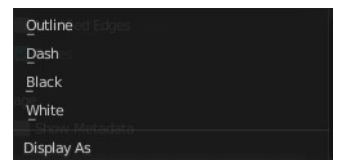
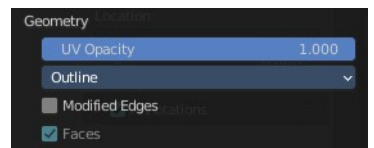

Display Channels

Adjust what channels of the image gets displayed. It just shows when an image is loaded and active.

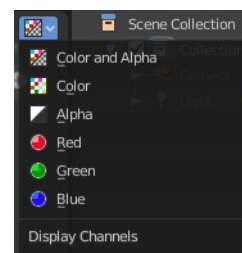

Color and Alpha

Displays the whole image, including alpha channel.

Color

Displays the whole image, but without alpha channel.

Alpha

Displays the alpha channel of the image.

Red

Displays the red channel of the image.

Green

Displays the green channel of the image.

Blue

Displays the blue channel of the image.

Options Panel

Constrain to Image Bounds

Forces the UV geometry to stay within the image bounds when editing.

Live Unwrap

Continuously unwrap the selected UV island while transforming pinned vertices.

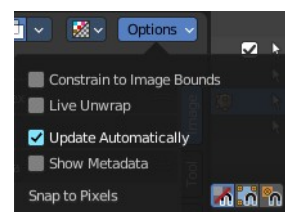

Update Automatically

Update other editor windows simultaneously with the changes in the Image Editor.

UV local view

A mesh can have more than one material, and so more than one texture. Display only faces that are assigned to the currently displayed image.

Show Metadata

Draw Metadata properties of the image.

Snap to Pixels

Enables the pixel snapping with two methods. Corner or center.



9.1.2 Editors - UV Editor - Header - Quick Menu

Table of content

Quick Menu.....	1
Adding an operator to the Quick menu.....	1
Adding a menu to the Quick menu.....	1
Order.....	2
Removing an operator from the Quick menu.....	2
Context and mode dependent content.....	2

Quick Menu

The quick menu, or in long Quick Favorites menu, is a menu that can be customized to your needs. Here you can add operators for quick access.

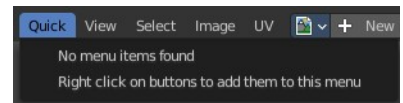

It is located in the header. But it can be called by hotkey Q directly under the mouse. This hotkey works in other editors too.

When the menu is empty, then you will see the message "No Menu Items found". This means that you first have to add some tools to the menu. It is a user configurable menu.

Note that added operators in this menu does not have icons. Just text.

Note also that the Quick menu for the UV editor shares the content with the Quick menu from the Image editor.

Adding an operator to the Quick menu

Open the panel or the menu where your operator is that you want to add.

Let's add the open command from the File menu. Open the File menu, right click at open, and choose Add to Quick Favorites.

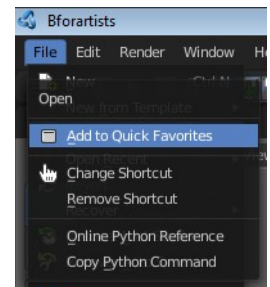

Do the same with Save As. We should now have two new menu items in the Quick menu, which you can use now.

As a rule of thumb, when the right click menu has an Add to Quick Favorites, then you can add it to the quick menu.

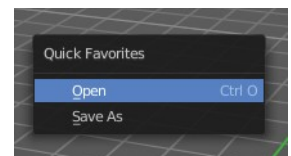

Note that you can also add operators from the tool shelf at the left. And also operators from other editor types. Some other editors have their own quick menu though. The Image Editor for example. These operators gets added in the quick menu of the image editor then. And does not show in the quick menu in the header of the 3D view.

Adding a menu to the Quick menu

It is also possible to add a menu to the Quick menu. For example the whole Add menu. The way is the same. Right click at it, and choose Add to Quick Favorites.

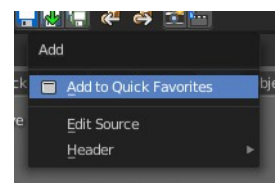

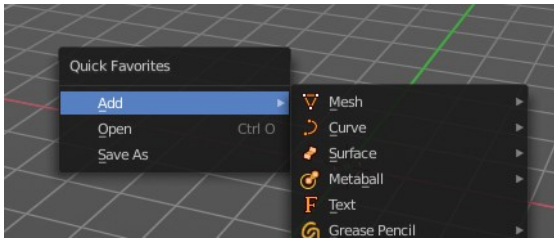

Order

You might notice that the add menu adds at the top of the menu, and not at the bottom as you would expect. First comes menus, then comes operators. And they get added in the order in which you add them.

Besides that, operators and menus gets added in the order that you add them. They cannot be sorted afterwards. So be careful how you add them. You can of course always remove operators and menus, and re-add them at the end of the list.

Removing an operator from the Quick menu

Removing is as simple as adding. Right click at the operators in the Quick menu, and choose Remove from Quick favorites.

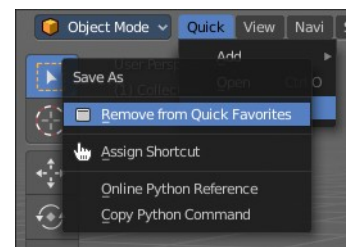

Context and mode dependent content

The quick favorites. menu exists in nearly all editors. But it is just in the 3D view available in the header. So that you know this functionality exists. In the other editors you call it with hotkey Q.

The content of the quick favorites. menu changes, dependent over which editor you are, and in what mode you are. When you add for example an operator from the image editor, then this operator just shows in the quick menu when you call the menu from the image editor. Same goes for the modes. Edit mode tools will just show in edit mode. And so on.



9.1.3 Editors - UV Editor - Header - View Menu.odt

Table of content

Image Editor - View Menu.....	1
Toolbar.....	2
Sidebar.....	2
Tool Settings.....	2
Adjust Last Operation.....	2
Tool Shelf Tabs.....	2
Legacy.....	2
Set 2D cursor.....	2
Annotations (Legacy).....	2
Draw Annotation.....	3
Draw Line Annotation.....	3
Draw Polyline Annotation.....	3
Erase Annotation.....	3
Add Annotation Layer.....	3
Erase Annotation Active Keyframe.....	3
View Zoom In.....	3
View Zoom Out.....	3
Zoom Border.....	3
Fractional Zoom.....	3
View Selected.....	3
View All.....	4
View Fit.....	4
Center View to Cursor.....	4
Cursor to Center View.....	4
Area.....	4
Horizontal Split.....	4
Vertical Split.....	4
Duplicate Area into New Window.....	4
Toggle Maximize Area.....	4
Toggle Full screen Area.....	4
Close Area.....	5
Pie menus.....	5

Image Editor - View Menu

The View menu contains all View related tools.

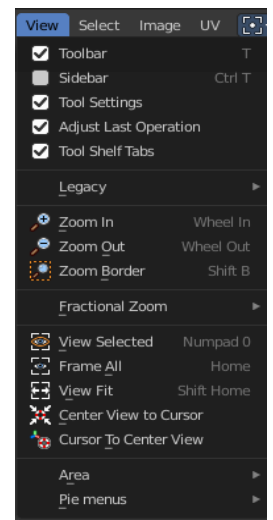

Toolbar

Shows or hides the tool shelf at the left.



Sidebar

Shows or hides the sidebar at the right in the viewport

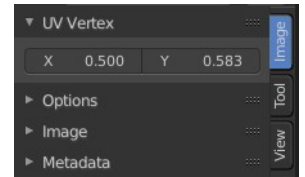

Tool Settings

Shows or hides the tool settings above the header in the 3D view.

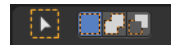

Adjust Last Operation

Shows or hides the Adjust Last Operation panel down left.

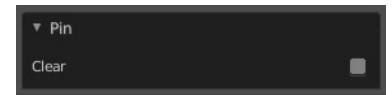

Note that the Adjust Last Operation menu item in the Edit menu in the main header and the Last button in the toolbar are not related and not functional with this last operator panel. It is an independent element.

Tool Shelf Tabs

Show or hide the tabs in the tool shelf.

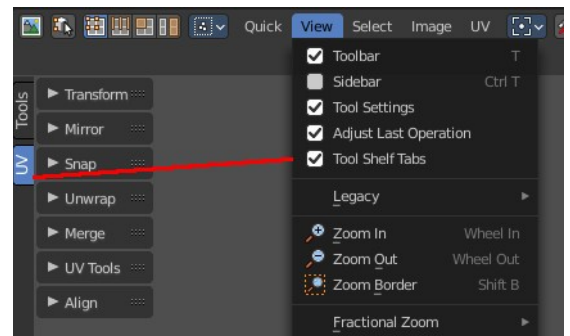

Legacy

Set 2D cursor

The old way to set the 2d cursor. Not by the tool shelf tool. Hotkey only tool! Please use the hotkey.



Annotations (Legacy)

This group of operators is useful to take notes without changing tool-shelf operators. These notes can be colored in the View tab of the Property Shelf. Each layer is a single color. You can also animate the notes with keyframes, editable in the dopesheet.

Note: These are legacy operators, meaning they are equally available in the Toolshelf as a modal operator.

Draw Annotation

Starts the annotation free hand draw tool in the editor.

Draw Line Annotation

Starts the annotation line draw tool to draw straight lines in the editor.

Draw Polyline Annotation

Starts the annotation Polyline draw tool in the editor which allows to draw multiple connected straight lines in the editor.

Erase Annotation

Starts the annotation erase tool in the editor which erases any strokes in the editor.

Add Annotation Layer

Starts a new annotation layer.

Erase Annotation Active Keyframe

Erases the active keyframe of the annotation.

View Zoom In

Zooms into the viewport.

View Zoom Out

Zooms out of the viewport.

Zoom Border

Draws a rectangle and zooms then to fit the size of this rectangle.

Zooming in is done with drawing the rectangle with left mouse button. Zooming out is done with drawing the rectangle with middle mouse button.

Fractional Zoom

A sub menu where you can choose between predefined zoom factors.

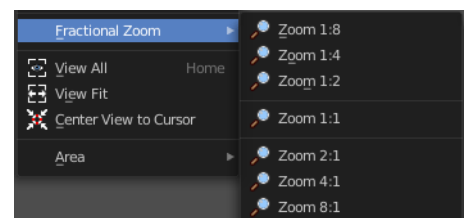

View Selected

View Selected centers the view at the currently selected UV mesh parts.

View All

View all zooms in or out in the viewport until all objects in the scene are displayed fitting in the viewport.

View Fit

Zooms out or in to fit the image to the viewport.

Center View to Cursor

Centers the view to the 2D cursor.

Cursor to Center View

Centers the cursor and the view to the center of the viewport.

Area

This menu contains general view functionality. And exists in most other editor types too.

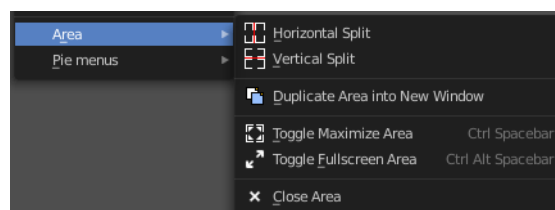

Horizontal Split

Splits the current view horizontally into two independent editor windows.

Vertical Split

Splits the current view vertically into two independent editor windows.

Duplicate Area into New Window

Duplicate Area into New Window makes the selected editor window floating. You can then drag it around at the monitor. It is not connected with the rest of the UI anymore.

A separated window cannot be merged into the main window again. You have to close it when not longer needed.

Toggle Maximize Area

Displays the editor maximized with menus.

To return from the maximized view press hotkey ctrl + spacebar. Or reuse the menu item in the area menu.

Toggle Full screen Area

Displays the editor maximized without menus.

To return from the full screen view press hotkey ctrl + alt + spacebar.

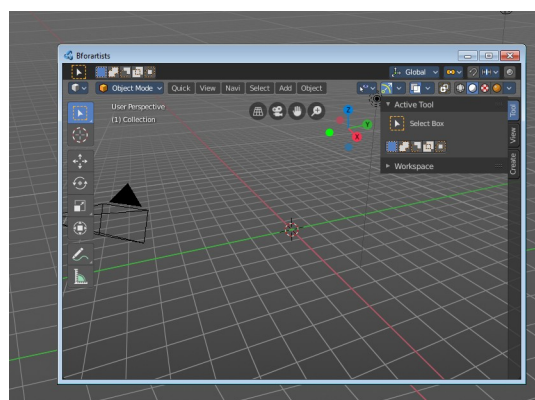

Close Area

Closes the editor.

Pie menus

Lists the available pie menus, and gives you the ability to read the hotkeys and assign own hotkeys.





9.1.4 Editors - UV Editor - Header - Select Menu

Table of content

Select menu.....	2
Legacy.....	2
Box select.....	2
Circle select.....	2
All.....	2
None.....	2
Inverse.....	2
Box Select Pinned.....	3
Circle Select.....	3
Linked.....	3
Linked Pick.....	3
Last Operator Select Linked Pick.....	3
Extend.....	3
Deselect.....	3
Location X / Y.....	3
Pinned.....	3
Split.....	4
Overlap.....	4
Last Operator Select Overlap.....	4
Extend.....	4
Select Similar.....	4
Pinned.....	4
Length.....	4
Length 3D.....	4
Area.....	4
Area 3D.....	4
Material.....	4
Object.....	4
Polygon Sides.....	5
Winding.....	5
Amount of Faces.....	5
Last Operator Select Similar.....	5
Type.....	5
Compare.....	5
Threshold.....	5
Shortest Path.....	5
Last Operator Pick Shortest Path.....	5
Face Stepping.....	5
Topology Distance.....	5
Fill Region.....	6
Nth Element.....	6
Skip.....	6
Offset.....	6
More.....	6
Less.....	6

Select menu

This menu just appears when you are in Mask mode. And you need to create a new mask layer to set all items active. The select functionality in this menu covers the mask geometry. The splines.

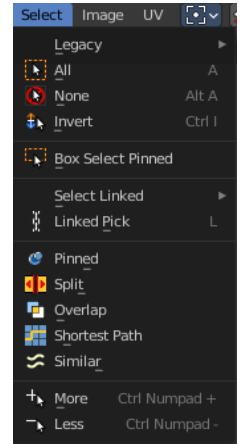

Legacy

The legacy sub menu contains tools that exists in the tool shelf already. It's the old way to do things. Different to the tools in the tool shelf, these tools are usually modal. And performs once. You have to call them again in case you want to repeat the tool.



Box select

Draw a rectangle to select everything inside of the rectangle.

It automatically adds to the current selection. Holding down shift subtracts from the selection.

Circle select

Brush select content. The radius of the brush can be adjusted by holding down left mouse button and using the scroll wheel or the + or - button at the numpad.

It automatically adds to the current selection. Holding down shift subtracts from the selection. To exit the circle select tool click with the right mouse button.

All

Select everything.

None

Select nothing.

Inverse

Invert the current selection.

Box Select Pinned

Box select enters the Border Select mode. This is a special select mode where you can select elements by dragging a rectangle. And what's inside of the rectangle gets selected then. It adds to selection by default. Box Select Pinned just selects pinned UV vertices. The other box select method can be found in the tool shelf.

To subtract from selection hold down Shift key.

The selection gets applied when you release the mouse. You leave the mode automatically when you release the mouse.

Circle Select

Circle select enters the Circle Select mode. This is a special select mode where you can select elements by moving with the mouse over it. It adds to selection by default.

To subtract from selection hold down Shift key. To exit the Circle select click with the right mouse button.

The pencil radius of the circle select tool can be adjusted with the scroll wheel.

Linked

Select all UV vertices linked to the active UV map. The previous selection gets cleared.

Linked Pick

Hotkey Only Tool!

Select all UV vertices linked to the active UV map. The previous selection gets cleared.

Last Operator Select Linked Pick

Extend

The previous selection gets kept, the selection gets extended.

Deselect

Deselect instead of select

Location X / Y

The mouse position in the UV space, normalized to the 0.0 to 1.0 range of the UV space.

Pinned

Select pinned UV vertices.

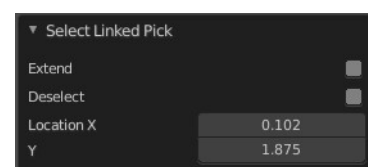

Split

Select only entirely selected faces.

Overlap

Select all UV faces that overlaps each other.

Last Operator Select Overlap

Extend

Extend the current selection.



Select Similar

Select Similar selects similar elements to the already selected parts. It is mode dependant. When you are in Vertex mode, then it shows just a Vertex related menu. When you are in edge select mode, then a edge related menu. And when you are in face select mode, then a face related menu. And this for both, the UV sync selection off and on.

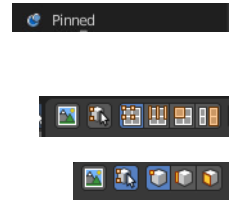

Pinned

Select UV patches with pinned vertices.

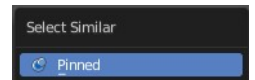

Length

Select UV edges that has the same length in the UV Space.

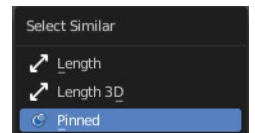

Length 3D

Select UV edges that has the same length in the 3D View.

Area

Select UV edges that has the same area in the UV Space.

Area 3D

Select UV edges that has the same area in the 3D View.

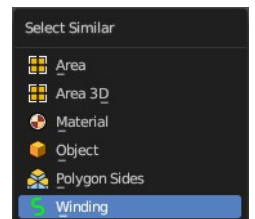

Material

Select UV faces with the same material.

Object

Select UV faces at the same object.

Polygon Sides

Select UV faces that points into the same side in the 3D view.

Winding

Select UV faces in winding order.

Amount of Faces

With UV Select Mode Islands. Selects all UV Islands with the same amount of faces.

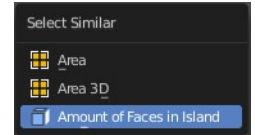

Last Operator Select Similar

Type

The select similar method.

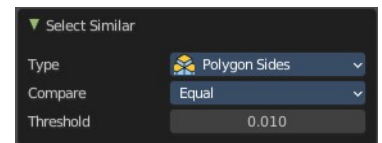

Compare

Compare if the element to select should be greater, equal or less big than the current selection.

Threshold

A tolerance setting.

Shortest Path

Select the shortest path between two selected elements.

Note that shortest path is a hotkey tool. Select the first element, hold down ctrl, select the second element.

Last Operator Pick Shortest Path

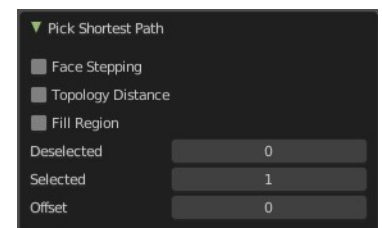

Face Stepping

Traverse connected faces.

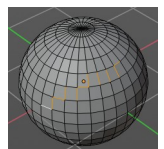

Topology Distance

Find the minimum number of steps instead of the shortest distance.

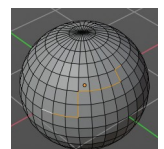

Fill Region

Select the region faces too.

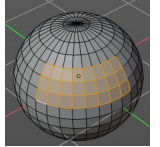

Nth Element

Don't select the whole path, but just every nth element of it.

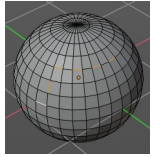

Skip

This is connected to nth element. Number of elements to skip at once.

Offset

This is connected to nth element. Start with an offset.

More

Grow the selection.

Less

Shrink the selection.



9.1.5 Editors - UV Editor - Header - Image Menu

Table of content

UV Editor - Image Menu.....	1
New.....	2
Name.....	2
Width.....	2
Height.....	2
Color.....	2
Alpha.....	2
Generated Type.....	2
32 Bit Float.....	2
Open.....	2
Open Cached Render.....	3
Replace Image.....	3
Reload Image.....	3
Edit Externally.....	3
Save Image.....	3
Save As Image.....	3
Save Copy.....	3
Save all Images.....	4
Invert.....	4
Resize.....	4
Flip.....	4
Pack Image / Pack as PNG.....	4

UV Editor - Image Menu

The Image menu contains the load and save functionality.

Not all content shows with all image types. A Render Result shows a different menu content.

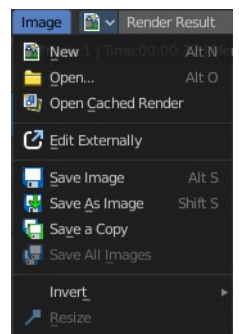
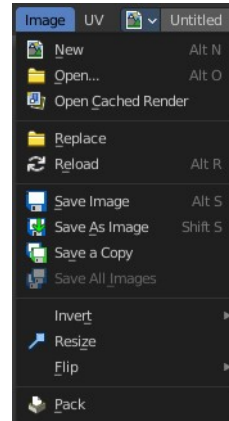
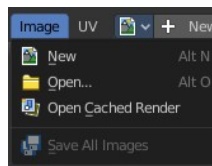

New

Creates a new image. You will get a dialog where you can define settings for the new image.

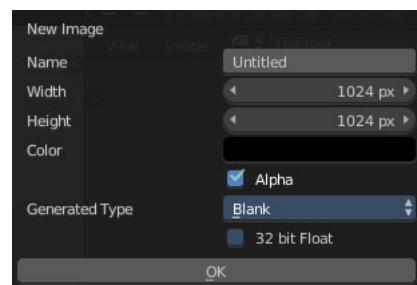

Name

The name of the new image

Width

The width of the new image.

Height

The height of the new image.

Color

Adjust the color of the new image. A click will call a color picker.

Alpha

Check this checkbox if the new image should have an alpha channel.

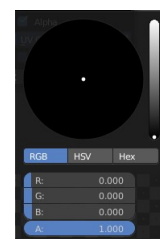

Generated Type

Define what kind of texture you want to create.

Blank is one plain color.

UV Grid is a checker texture in black and white.

Color Grid is a colored checker texture.

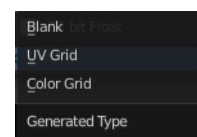

32 Bit Float

Check this checkbox if the image should be in 32 Bit floating point bit depth per channel. Else it is in 8 bit per channel.

Open

Opens the file browser to load an image.

Open Cached Render

To get it to work you need to have Cycles as the renderer selected. This feature does not work with Eevee or Workbench renderer.

Read all the current scene's render layers from cache, as needed. For this feature to work save Buffers needs to be activated in the Performance tab in the render settings.

This feature can be used to save RAM while rendering because the render layers do not have to be saved in RAM. It can also be used to recover some information from a fail render.

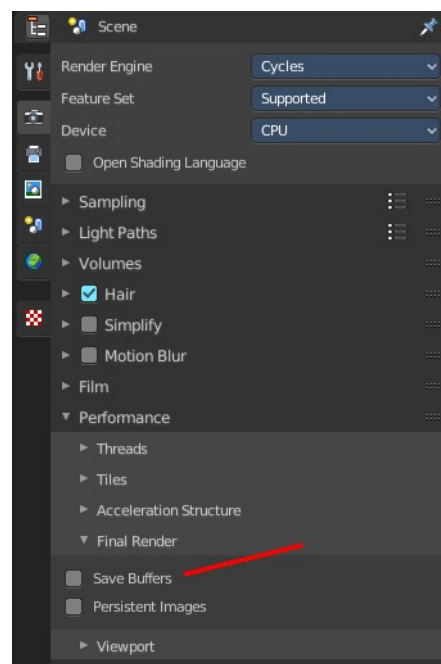

Replace Image

Replaces the currently active image by an image that you load.

Reload Image

Reloads the currently selected image.

Note that the images must already exist somewhere at your hard disk. When you create a new image in Bforartists, then this image isn't saved yet, and so you cannot reload it.

Edit Externally

Open the image in a defined external image editor like The Gimp or Photoshop.

The image must be saved. And the image editor must be defined in the User Preferences.

Save Image

Saves the currently selected image without any further questions. Note that the images must already exist somewhere at your hard disk.

Save As Image

Saves the currently selected image.

Save Copy

Saves a copy of the currently selected image. This will save the file to a specified name, but will keep the old one open in the Image editor.

Save all Images

Saves all images.

Note that the images must already exist somewhere at your hard disk so that they can be saved. The item is greyed out as long as the image is not saved to disk.

Invert

Invert is a sub menu where you can invert the colors of the whole image, or just specific colors.

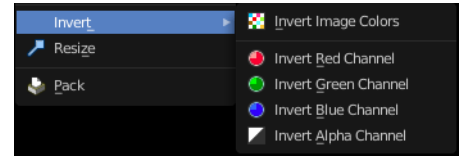

Resize

Allows you to change the dimensions of the image. The tool calls a resize panel.

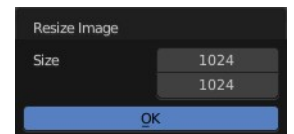

Flip

Flip the image horizontally or vertically.



Pack Image / Pack as PNG

Packs the currently active image into the blend file. When you save the blend file the next time, then this image will be embedded. The Pack menu item turns into an Unpack menu item with packed textures.



Packed images are marked with a pack icon. A click at this icon will unpack the texture, and try to save it to file. Usually to the last existing location before it was packed.



Warning

You cannot modify packed images. Changes at the image will not be saved. You need to unpack the image when you want to modify it. And repack it after you have done the changes.



9.1.6 Editors - UV Editor - Header - UV menu

Table of content

Detailed table of content.....	1
UV menu.....	6
Transform.....	6
Mirror.....	8
Snap.....	9
Pin.....	10
Unpin.....	10
Invert Pins.....	10
Unwrap.....	11
Follow Active Quads.....	13
Merge.....	15
Split.....	15
Pack Islands.....	15
Average Island Scale.....	17
Minimize Stretch.....	18
Stitch.....	19
Mark Seam.....	20
Seams from Islands.....	21
Align.....	21
UV Select Mode.....	22
Copy UV.....	22
Paste UV.....	22
Show / Hide Faces.....	22
Reset.....	23
Export UV Layout.....	23

Detailed table of content

Detailed table of content

Detailed table of content.....	1
UV menu.....	6
Transform.....	6
Rotate + 90°.....	6
Rotate - 90°.....	6
Last Operator Rotate.....	6
Angle.....	6
Axis.....	6
Orientation.....	6
Proportional editing.....	7
Proportional Falloff.....	7
Proportional Size.....	7
Connected.....	7
Projected(2D).....	7
Shear.....	7

Last Operator Shear.....	7
Offset.....	7
Axis.....	7
Axis Ortho.....	7
Orientation.....	7
Proportional editing.....	7
Proportional Falloff.....	7
Proportional Size.....	7
Connected.....	7
Projected(2D).....	8
Randomize.....	8
Last Operator Randomize.....	8
Random Seed.....	8
Randomize Location.....	8
Location.....	8
Randomize Rotation.....	8
Rotation.....	8
Randomize Scale.....	8
Scale Even.....	8
Scale.....	8
Mirror.....	8
Copy Mirrored UV coords.....	8
X.....	8
Y.....	9
Last Operator Mirror.....	9
Orientation.....	9
Constraint Axis.....	9
Proportional Editing.....	9
Proportional Editing Falloff.....	9
Connected.....	9
Projected(2D).....	9
Snap.....	9
Last Operator Snap Selection and Snap Cursor.....	10
Target.....	10
Pin.....	10
Unpin.....	10
Invert Pins.....	10
Last operator Pin.....	10
Clear.....	10
Invert.....	10
Unwrap.....	11
Unwrap ABF.....	11
Unwrap Conformal.....	11
Last Operator Unwrap.....	11
Method.....	11
Fill Holes.....	11
Correct Aspect.....	11
Use Subsurf Modifier.....	11
Margin.....	11
Smart UV Project.....	12
Smart UV Project Settings dialogue.....	12
Angle Limit.....	12
Island Margine9i.....	12

Area Weight.....	12
Correct Aspect.....	12
Last Operator Smart UV Project.....	12
Lightmap Pack.....	12
Settings.....	12
Selection.....	12
Share Tex Space.....	12
New UV Map.....	12
New Image.....	12
Image Size.....	12
Pack Quality.....	13
Margin.....	13
Follow Active Quads.....	13
Settings.....	13
Edge Length Mode.....	13
Last Operator Follow Active Quads.....	13
Cube Projection.....	13
Last Operator Cube Projection.....	13
Cube Size.....	13
Correct Aspect.....	13
Clip to Bounds.....	13
Scale to Bounds.....	13
Cylinder Projection.....	13
Last Operator Cylinder Projection.....	14
Direction.....	14
Align.....	14
Radius.....	14
Correct Aspect.....	14
Clip to Bounds.....	14
Scale to Bounds.....	14
Sphere Projection.....	14
Last Operator Sphere Projection.....	14
Direction.....	14
Align.....	14
Correct Aspect.....	14
Clip to Bounds.....	14
Scale to Bounds.....	14
Merge.....	15
At Center.....	15
At Cursor.....	15
Last Operator Snap Selection.....	15
Target.....	15
By Distance.....	15
Last Operator Merge UV's by Distance.....	15
Merge Distance.....	15
Split.....	15
Pack Islands.....	15
Pack Islands Popup.....	16
Shape Method.....	16
Exact Shape (Concave).....	16
Boundary Shape (Convex).....	16
Bounding Box.....	16
Scale.....	16

Rotate.....	16
Rotation Method.....	16
Axis - aligned.....	16
Cardinal.....	16
Any.....	16
Margin.....	16
Margin Method.....	16
Scaled.....	17
Add.....	17
Fraction.....	17
Lock Pinned Islands.....	17
Lock Method.....	17
Scale.....	17
Rotation.....	17
Rotation and Scale.....	17
All.....	17
Merge Overlapping.....	17
Pack To.....	17
Closest Udim.....	17
Active Udim.....	17
Original Bounding Box.....	17
Average Island Scale.....	17
Minimize Stretch.....	18
Last Operator Minimize Stretch.....	19
Fill Holes.....	19
Blend.....	19
Iterations.....	19
Stitch.....	19
Last Operator Stitch.....	19
Use Limit.....	19
Snap Island.....	19
Limit.....	19
Static Island.....	20
Active Object.....	20
Snap at Midpoint.....	20
Clear Seams.....	20
Operation Mode.....	20
Mark Seam.....	20
Last Operator Mark Seam.....	20
Clear.....	20
Clear Seam.....	20
Seams from Islands.....	21
Align.....	21
Straighten.....	21
Straighten X.....	21
Straighten Y.....	21
Align Auto.....	21
Align X.....	21
Align Y.....	21
Last operator Align.....	21
Axis.....	21
Align Rotation.....	22
Last operator Align Rotation.....	22

Method.....	22
Geometry.....	22
Edge.....	22
Auto.....	22
UV Select Mode.....	22
Copy UV.....	22
Paste UV.....	22
Show / Hide Faces.....	22
Reveal Hidden.....	22
Hide Selected.....	23
Hide Unselected.....	23
Last Operator Reveal Hidden / Hide Selected.....	23
Select.....	23
Reset.....	23
Export UV Layout.....	23
All UV's.....	23
Modified.....	23
Format.....	23
Size.....	23
Fill Opacity.....	23

UV menu

The UV header menu contains all the UV related operators in the UV Editor.

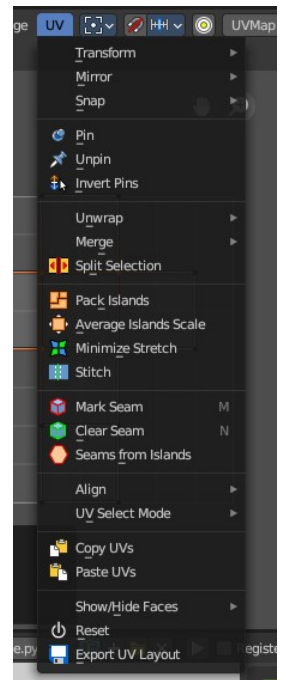

Transform

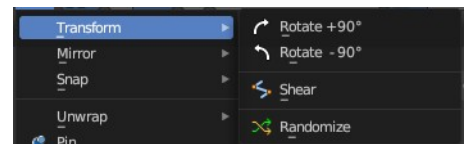

Rotate + 90°

Rotates the selection by 90 degree clockwise.

Rotate - 90°

Rotates the selection by 90 degree counter clockwise.

Last Operator Rotate

Angle

The rotation angle.

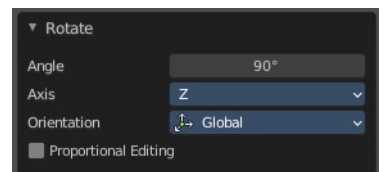

Axis

Defines one axis of the imaginary shear axis plane.

Orientation

Choose the orientation for the shear action.

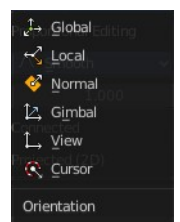

Proportional editing

Enables proportional editing. Activating proportional editing reveals further settings.

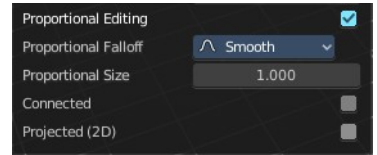

Proportional Falloff

Adjust the falloff methods.

Proportional Size

See and adjust the falloff radius.

Connected

The proportional falloff gets calculated for connected parts only.

Projected(2D)

The proportional falloff gets calculated in the screen space. Depth doesn't play a role. When it's in the radius, then it gets calculated.

Shear

Shear shears the selection.

Last Operator Shear

Offset

Adjust an offset.

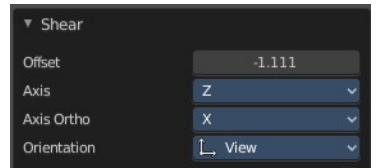

Axis

Defines one axis of the imaginary shear axis plane.

Axis Ortho

Defines the other axis of the imaginary shear axis plane.

Orientation

Choose the orientation for the shear action.

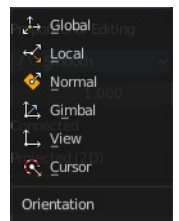

Proportional editing

Enables proportional editing. Activating proportional editing reveals further settings.

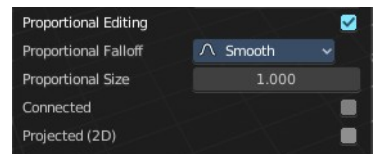

Proportional Falloff

Adjust the falloff methods.

Proportional Size

See and adjust the falloff radius.

Connected

The proportional falloff gets calculated for connected parts only.

Projected(2D)

The proportional falloff gets calculated in the screen space. Depth doesn't play a role. When it's in the radius, then it gets calculated.

Randomize

Last Operator Randomize

Random Seed

The seed for the randomization.

Randomize Location

Randomize the location values.

Location

The maximum distance the objects can spread over each axis.

Randomize Rotation

Randomize the rotation values.

Rotation

The maximum allowed rotation

Randomize Scale

Randomize the scale values.

Scale Even

Randomize the scale values.

Scale

The maximum scale the objects can scale over each axis.

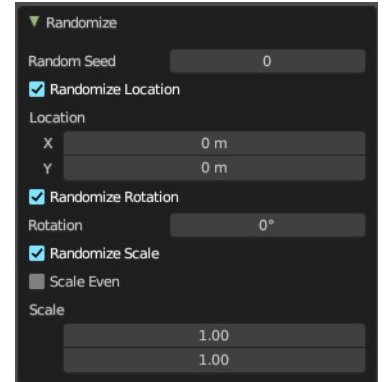

Mirror

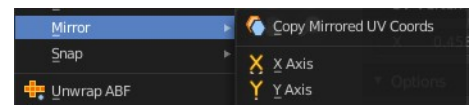

Copy Mirrored UV coords

Copies and pastes the selected UV geometry on the X axis based on a mirrored mesh.

Use UV Select Sync must be off. The tool does not work with Use UV Select Sync on. And it is not fully reliable as our example shows.



X

Mirrors the selection in X axis. The mirror point is the pivot of the selection.

Y

Mirrors the selection in Y axis. The mirror point is the pivot of the selection.

Last Operator Mirror

The Last Operator Mirror panel gives you tools to adjust the mirror action.

Orientation

Orientation is a drop-down box to choose the type of orientation for the mirroring action.

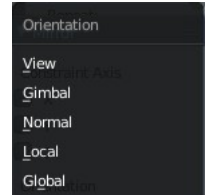
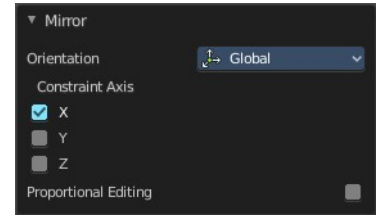

Constraint Axis

Constraint Axis gives you the possibility to define the mirror axis. You can choose more than one axis here.

Proportional Editing

Activates proportional editing.

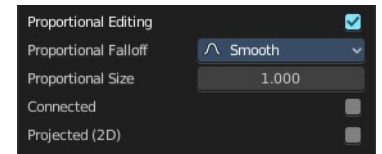

Proportional Editing Falloff

Proportional Editing Falloff is a drop-down box to Choose a method for the falloff for the proportional editing.

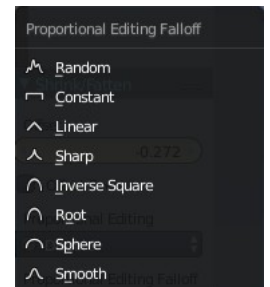

Connected

The proportional falloff gets calculated for connected parts only.

Projected(2D)

The proportional falloff gets calculated in the screen space. Depth doesn't play a role. When it's in the radius, then it gets calculated.

Snap

Snap is a sub menu with some snapping tools. The menu items should be pretty self explaining. Selected to Pixels snaps the selected geometry to the pixels of the image, and so on.

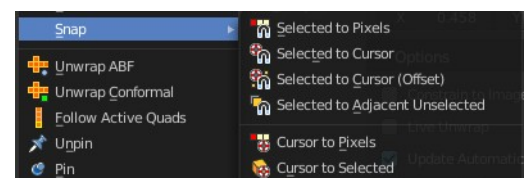

Last Operator Snap Selection and Snap Cursor

Target

Set the snap target method again.



Pin

Pins the selected vertices. These vertices are now nailed for the unwrap algorithms Angle based and Conformal. Their positions will not change when you repeat the unwrapping. And the algorithms will try to fit the rest of the geometry to this pinned vertices.

Pinned vertices are marked red.

A use case is for example when you have a distorted result for symmetric geometry like a face with the Conformal method. Then you can try to align two center vertices, pin them, and repeat the conformal method. It may be more symmetrical afterwards.

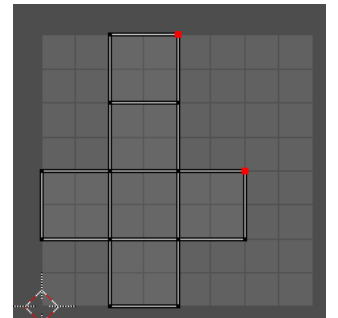
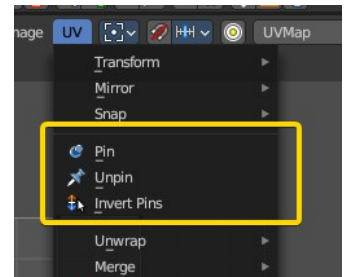

Unpin

Unpins pinned geometry.

Invert Pins

This operator inverts the pins to all selected pins, and unpins the set pins. This will only work if you have geometry selected.

Last operator Pin

This last operator appears in the 3D view to the bottom left of the editor. Pin, Unpin and Invert Pins shares the same last operator.



Clear

Unpins pinned geometry.

Invert

Inverts the pinned geometry to selected geometry, and unpins the set pins.

Unwrap

Unwrap ABF

Unwrap ABF unwraps the selected geometry with the method Angle based. ABF stands for Angle Based Flattening. ABF can give a bit better result than LSCM when unwrapping organic shapes.

Note that you need to have the geometry selected in the 3D view.

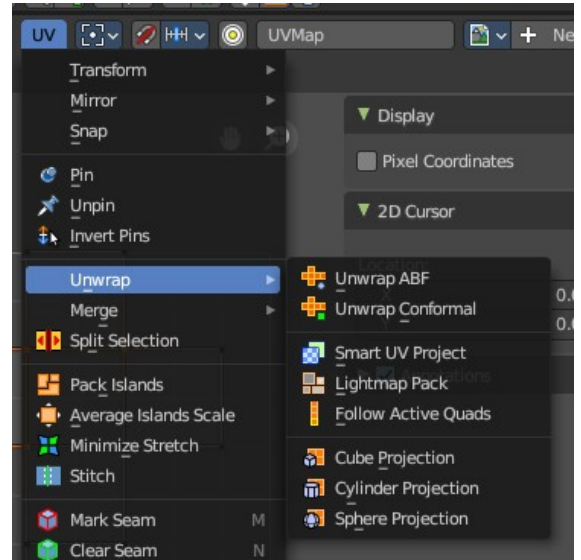

Unwrap Conformal

Unwrap ABF unwraps the selected geometry with the method Angle based. ABF stands for Angle Based Flattening. Conformal, also called LSCM, can give a bit better results than ABF with geometric shapes.

Note that you need to have the geometry selected in the 3D view.

Last Operator Unwrap

The last operator appears in the 3D view. Unwrap ABF and Unwrap LSCM shares the same Last Operator.

Method

Method is a drop down box to Choose between Unwrap method Angle Based and Conformal.

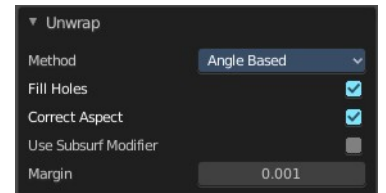

Fill Holes

Fill holes in the mesh before unwrapping.

Correct Aspect

Take the Image Aspect Ratio into account.

Use Subsurf Modifier

Unwraps an existing Subsurf Modifier. You need to add a Subsurf Modifier first.

Margin

The distance between the single UV patches.

Smart UV Project

Smart UV Project projects the UV mapping from different angles.

Smart UV Project Settings dialogue

Angle Limit

The Angle Limit defines after which angle the mapping happens from the next side. With an angle of 66 you have around six sides to map from. The calculation is $360/66$.

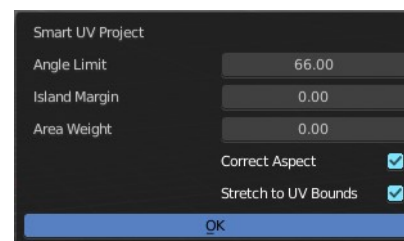

Island Margin

Island Margin defines the distance between the UV patches.

Area Weight

Weight Projection Vector by faces with larger areas.

Correct Aspect

Take the Image Aspect Ratio into account.

Last Operator Smart UV Project

The Last Operator for Smart UV Project contains the same settings than the Smart UV Project Settings dialogue.

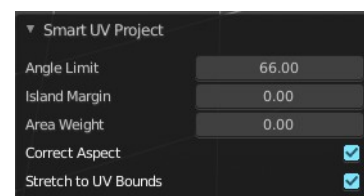

Lightmap Pack

Lightmap Pack maps each face individually, and puts the result into the UV space. Without margin.

Lightmap Pack has no Last Operator.

Settings

Selection

Selection is a drop-down box where you can choose what will be packed.

Share Tex Space

Map all objects into one lightmap.

New UV Map

Create a new UV map for every new mesh.

New Image

Assign new Image to every new mesh.

Image Size

The size for new images.

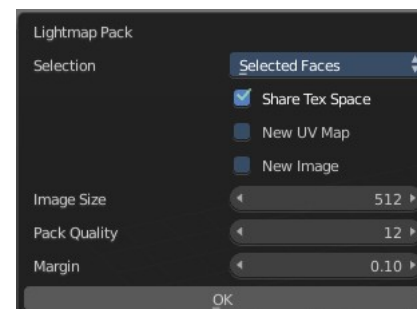

Pack Quality

The pack quality.

Margin

The distance between the single UV patches.

Follow Active Quads

Follow Active quads maps UV coordinates starting from an active face, and maps all adjacent faces in quad shape then. This way you can for example unwrap a pipe or a road. You first need to have a face selected. Then select everything. And then click at Follow Active Quads.

Settings

Edge Length Mode

Edge Length Mode is a drop-down box where you can choose the Length method.

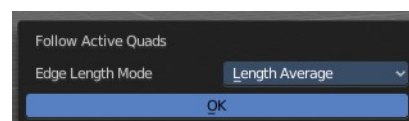

Last Operator Follow Active Quads

The Last Operator contains the same settings than the Settings dialogue.

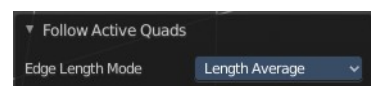

Cube Projection

Cube Projection maps the mesh from six sides, means cubic.

Last Operator Cube Projection

Cube Size

Cube Size defines the size of the UV mesh in the UV space.

Correct Aspect

Take Image Aspect ratio into account.

Clip to Bounds

Clip UV Coordinates to bounds after unwrapping.

Scale to Bounds

Scale UV Coordinates to bounds after unwrapping.

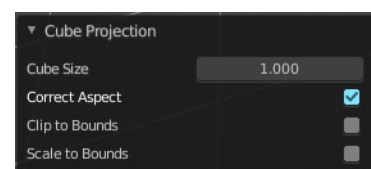

Cylinder Projection

Cylinder Projection tries to map the geometry cylindric.

Last Operator Cylinder Projection

Direction

Direction is a drop-down box where you can choose in which direction the cylindrical projection will be mapped.

Align

Align is a drop-down box where you can choose the Align method.

Radius

Radius defines the Polar size of the UV mesh in the UV space.

Correct Aspect

Take Image Aspect ratio into account.

Clip to Bounds

Clip UV Coordinates to bounds after unwrapping.

Scale to Bounds

Scale UV Coordinates to bounds after unwrapping.

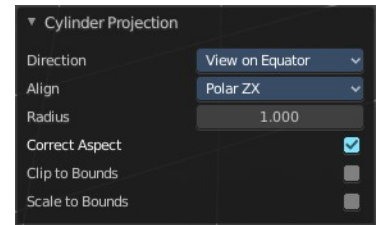

Sphere Projection

Sphere Projection tries to map the geometry spherical.

Last Operator Sphere Projection

Direction

Direction is a drop-down box where you can choose in which direction the spherical projection will be mapped.

Align

Align is a drop-down box where you can choose the Align method.

Correct Aspect

Take Image Aspect ratio into account.

Clip to Bounds

Clip UV Coordinates to bounds after unwrapping.

Scale to Bounds

Scale UV Coordinates to bounds after unwrapping.

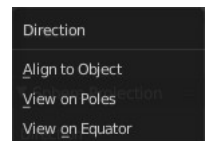
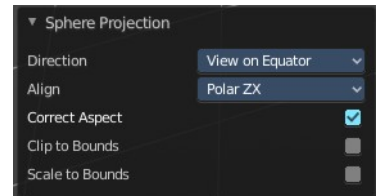

Merge

At Center

Merges the selected vertices at the center point.

At Cursor

Merges the selected vertices not only at the cursor. The last operator provides you with four methods.

Last Operator Snap Selection

Target

The snapping target. Snap and merge at the following locations.

Adjacent unselected

Cursor (Offset)

Cursor

Pixels

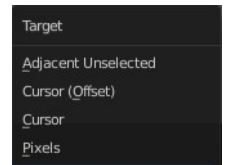
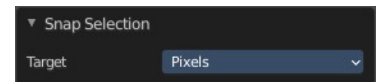
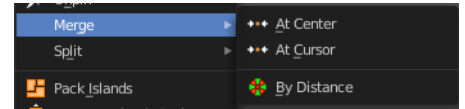

By Distance

Merge UV vertices when they are below a merge distance.

Last Operator Merge UV's by Distance

Merge Distance

The merge distance below the vertices gets merged.

Unselected

Merge selected vertices to unselected vertices.

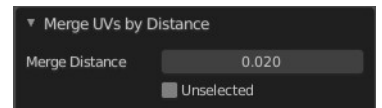

Split

Splits the selected geometry. UV Sync Selection needs to be off.

Pack Islands

Pack Islands tries to pack the selected UV geometry as close together as possible. Without to waste too much empty space.

Note that the algorithm fails at round geometry. It calculates with rectangle shapes.

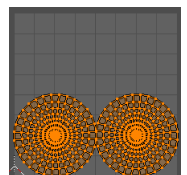

Pack Islands Popup

When you click the operator then you will see a popup panel where you can adjust the further settings.

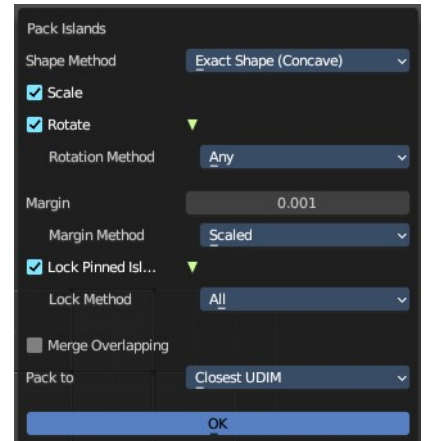

Shape Method

How the islands are packed.

Exact Shape (Concave)

Use exact geometry.

Boundary Shape (Convex)

Use a convex hull.

Bounding Box

Use a bounding box.

Scale

Scale islands to fill the unit square.

Rotate

Rotate islands to improve layout.

Rotation Method

The rotation method.

Axis - aligned

Rotate to a minimal rectangle. Either horizontal or vertical.

Cardinal

Only 90 degrees rotation are allowed

Any

Any angle is allowed for rotation.

Margin

Adjust the margin amount.

Margin Method

What method to use for the margin. UV patches needs a margin between the single

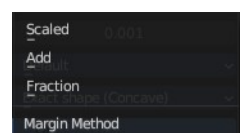
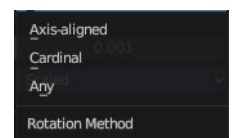
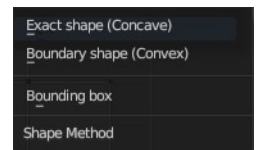

patches. So that the pixels of the texture doesn't bleed into other areas.

Scaled

Use scale of existing UV's to multiply margin.

Add

Just add the margin. And don't use the UV scale for calculation too.

Fraction

Specify a precise fraction of final UV output.

Lock Pinned Islands

Constrain islands that contains any pinned UV's

Lock Method

How to deal with pinned UV islands.

Scale

Pinned islands won't scale.

Rotation

Pinned islands won't rotate.

Rotation and Scale

Pinned islands won't scale and rotate

All

Pinned islands will remain at their initial position and are locked in place.

Merge Overlapping

Overlapping islands stick together.

Pack To

Closest Udim

Pack islands to closest UDIM image tile

Active Udim

Pack islands to active UDIM image tile, or to the UDIM grid tile where the 2d cursor is located.

Original Bounding Box

Pack to the starting bounding box of islands.

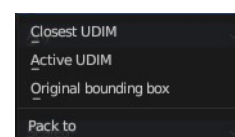
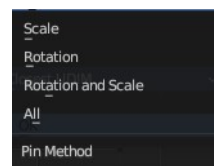

Average Island Scale

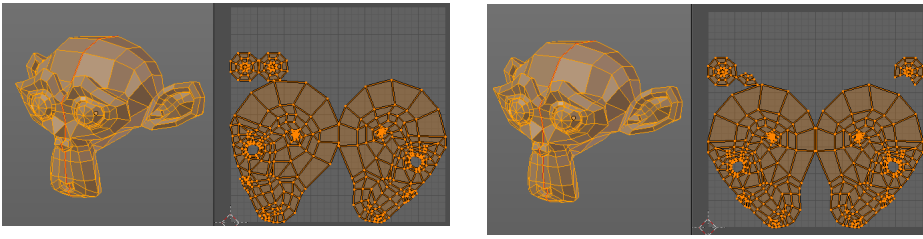

Scales the selected UV geometry to have the same relative size than the rest of the mesh. So that the texels at the mesh have roughly the same size everywhere.

Minimize Stretch

You might end in a UV mapping result that still shows unwanted distortions here and there. For example when you UV map a human face. Minimize Stretch tries to minimize this stretching effects in the UV patches.

To view stretched areas at your UV patches, tick Display Stretch in the Overlays panel, and switch from Angle to Area. Then a stretch mask gets displayed. The color range goes from blue to green to red, where blue is minimal stretch and red is maximal stretch.

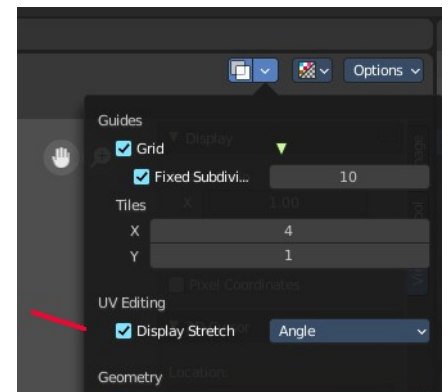

Let's explain it with an example. A sphere where the cut is nearly at the pole. And UV mapped with Angle Based. The result will of course show heavy stretched areas.

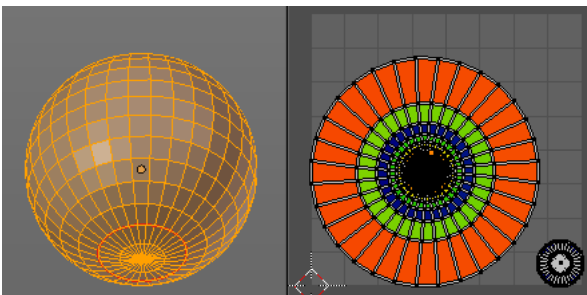

Note that the UV geometry must be selected in the UV Image editor. Now let's use the Minimize stretch tool. The algorithm now first tries its best to find the best fitting result that shows fewest stretching across the overall UV geometry.

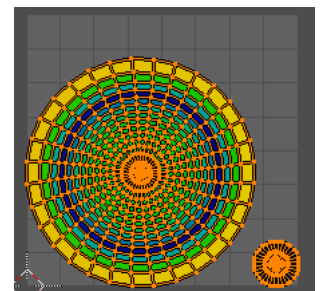

The header shows a help text while the algorithm works. The Blend factor is the value between the original unwrapped UV mesh, and the maximum minimized stretch. You can set this value manually by using the scroll wheel at your mouse, or with the + and - keys.

Minimize Stretch. Blend 0.00

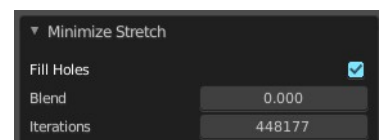

Last Operator Minimize Stretch

Fill Holes

Fill holes virtually fills holes before unwrapping to avoid overlapping and to preserve the geometry.

Blend

The Blend factor is the value between the original and the maximum minimized stretch.

Iterations

Number of iterations for the Minimize stretch algorithm.

Stitch

Stitch tries to union UV patches along the selected edges or vertices.

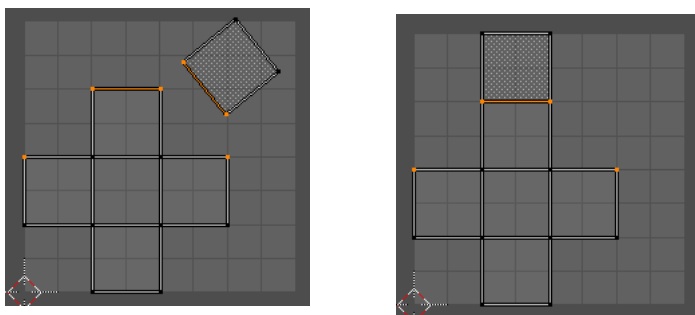

Last Operator Stitch

This last operator appears in the 3D view.

Use Limit

Just snap when the elements are below a given distance.

Snap Island

Snap the whole UV patch, or just the selected edge(s)/vertices

Limit

The limit distance for Use Limit.

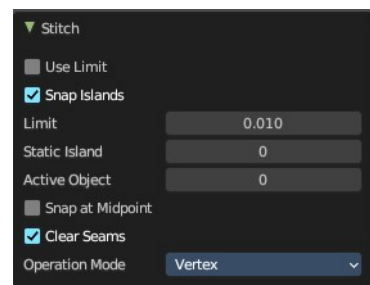

Static Island

Adjust which island stays in place when stitching.

Active Object

Index of the active object.

Snap at Midpoint

Snap at the center point of the two elements instead the first to the last.

Clear Seams

Unmarks seams when stitching.

Operation Mode

The operation mode. Calculate with Edges or Vertices.

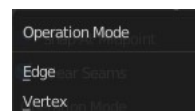

Mark Seam

The unwrap algorithms Angle based and Conformal requires to have edges marked as seams. Think of it as a cutting pattern for a trouser for example. Such a trouser is also made of fabric patterns.

Same goes for the UV patches when you use Angle based or conformal unwrapping. You need to cut your mesh into parts and mark edges as seams, so that the algorithm knows where the seams are.

Mark seam marks the currently selected edge(s) as a seam. Seam edges will be displayed as red in the 3D viewport. But not in the UV Image Editor. The UV patches represents the seams.

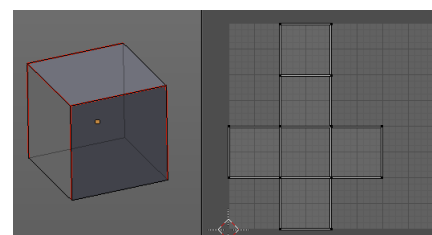

You need to unwrap the mesh again when you want to apply changes by the new marked seams.

Last Operator Mark Seam

Clear

Clears the seam instead of marking it.



Clear Seam

Clear seam removes the seam from the currently selected edge(s) in the 3D view.

Seams from Islands

Unwrapping creates the UV geometry from the 3D object. You mark the seams, then you click at unwrap, and the UV mesh gets created.

Mark Seams from islands goes the other way around for marking seams. It creates the seams at the mesh object in the 3D view from the UV geometry in the UV Image Editor.

A use case is when you import meshes. Then you usually just have the UV patches in the UV Image editor. And when you want to modify the UV's further, then you need the seams at the mesh.

Align

Align the selected geometry. Affected are the vertices.

Straighten

Straightens the selected geometry in both directions, X and Y axis.

Straighten X

Straightens the selected geometry along the X axis.

Straighten Y

Straightens the selected geometry along the Y axis.

Align Auto

Aligns the selection. The align axis gets chosen from the selection itself. When it's higher than tall, then it aligns along the Y axis. When it's taller than high, then it aligns along the X axis.

The align point is the pivot of the selection.

Align X

Aligns the selection along the X axis. The align point is the pivot of the selection.

Align Y

Aligns the selection along the Y axis. The align point is the pivot of the selection.

Last operator Align

The Last operator Align unions all the single straighten and align actions in one operator.

Axis

Lists the straighten and align methods again.

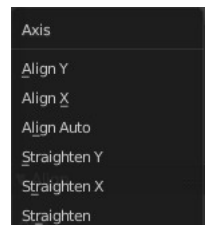
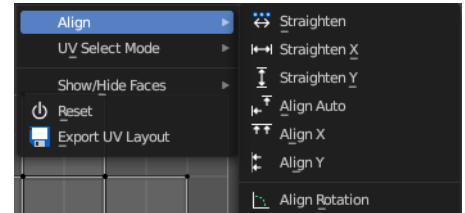

Align Rotation

Aligns the selected geometry horizontally or vertically. It aligns to the closest angle.

Last operator Align Rotation

Method

Geometry

Aligns the whole geometry.

Edge

Aligns the geometry along the selected edge.

Auto

Checks for selection, and aligns then either the whole geometry or by the selected edge.

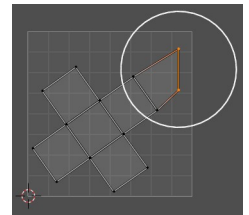
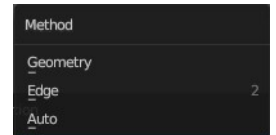
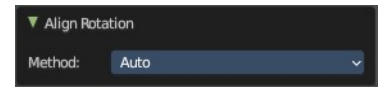

UV Select Mode

This is a double menu by design. It allows you to show and assign shortcuts to the UV Sync selection mode buttons in the header.

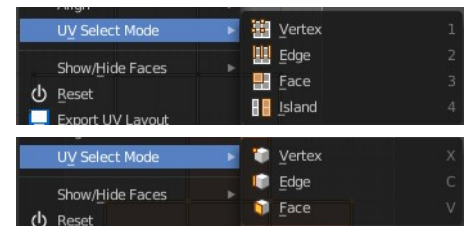

Copy UV

Copy selected UV vertices.

Paste UV

Pastes copied UV vertices.

Show / Hide Faces

Show or hide faces. This happens in both, the 3D View and the UV editor.



Reveal Hidden

Makes all geometry visible again.

Hide Selected

Hides the selected geometry.

Hide Unselected

Hides the not selected geometry. The selected geometry stays visible.

Last Operator Reveal Hidden / Hide Selected

Select

Define if the selected or the unselected elements gets hidden or revealed.

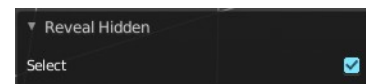

Reset

Resets the UV projection. Every single face gets fit into the UV space range of 0/1

Export UV Layout

Export the UV layout to an image, so that you can use it as a mask to build your texture in your favorite image editing software like Photoshop. It will open a file dialog, where you can define further export settings down left.

All UV's

Export all UV's, not just the visible ones.

Modified

Export UV's from the modified mesh.

Format

Choose the export format.

Size

Define the size of the image.

Fill Opacity

How opaque the wire frame lines are.

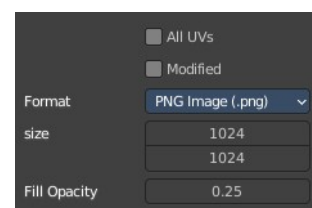



9.2 Editors - UV Editor - Tool Shelf

Table of content

Detailed table of content.....	1
Tool Shelf.....	4
Select Tools Group.....	4
Cursor.....	6
Move.....	6
Rotate.....	8
Scale.....	9
Transform.....	11
Annotate Tools group.....	11
Rip Region.....	13
Grab.....	14
Relax.....	14
Pinch.....	15

Detailed table of content

Detailed table of content

Detailed table of content.....	1
Tool Shelf.....	4
Select Tools Group.....	4
Tweak.....	4
Select Box.....	4
Tool Settings.....	4
Mode.....	4
Set a new selection.....	4
Extend existing selection.....	4
Subtract existing selection.....	4
Select Circle.....	5
Tool Settings.....	5
Mode.....	5
Set a new selection.....	5
Extend existing selection.....	5
Subtract existing selection.....	5
Radius.....	5
Select Lasso.....	5
Tool Settings.....	5
Mode.....	5
Set a new selection.....	5
Extend existing selection.....	5
Subtract existing selection.....	5
Cursor.....	6
Move.....	6
Snapping.....	6
Precision movement.....	6
Header Values.....	6

Numerical Input.....	6
Move without widget.....	6
Limit Axis.....	7
Last Operator Move.....	7
Move X, Y Z.....	7
Orientation.....	7
Proportional editing.....	7
Proportional Falloff.....	7
Proportional Size.....	7
Connected.....	7
Projected(2D).....	7
Rotate.....	8
Snapping.....	8
Precision rotation.....	8
Header Values.....	8
Numerical Input.....	8
Rotate without widget.....	8
Limit Axis.....	8
Last Operator Rotate.....	8
Angle.....	8
Axis.....	8
Orientation.....	9
Proportional editing.....	9
Proportional Falloff.....	9
Proportional Size.....	9
Connected.....	9
Projected(2D).....	9
Scale.....	9
Snapping.....	9
Precision Scale.....	9
Header Values.....	9
Numerical Input.....	10
Scale without widget.....	10
Limit Axis.....	10
Last Operator Resize.....	10
Angle.....	10
Axis.....	10
Orientation.....	10
Proportional editing.....	10
Proportional Falloff.....	10
Proportional Size.....	10
Connected.....	10
Projected(2D).....	11
Transform.....	11
Annotate Tools group.....	11
Annotate.....	11
Tool Settings.....	11
Color.....	11
Stabilize Stroke.....	12
Radius.....	12
Factor.....	12
Annotate Line.....	12
Tool Settings.....	12

Color.....	12
Style Start.....	12
End.....	12
Annotate Polygon.....	12
Tool Settings.....	12
Color.....	13
Annotate Eraser.....	13
Tool Settings.....	13
Radius.....	13
Rip Region.....	13
Last Operator UV Rip Move.....	13
Location X , Y.....	13
Move X , Y , Z.....	13
Constraint Axis.....	13
Orientation.....	14
Proportional editing.....	14
Proportional Falloff.....	14
Proportional Size.....	14
Connected.....	14
Projected(2D).....	14
Grab.....	14
Relax.....	14
Pinch.....	15

Tool Shelf



Select Tools Group

Tools with a triangle down right are a group of tools. Click and hold to reveal the content. Then choose the tool that you need.

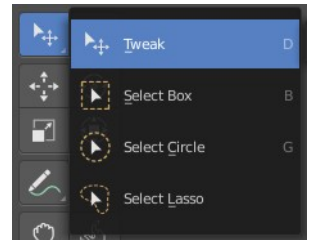

Tweak

Allows you to select or tweak single elements by clicking at it.

Select Box

Draws a box to select several elements at once. Click at the start point, then drag.

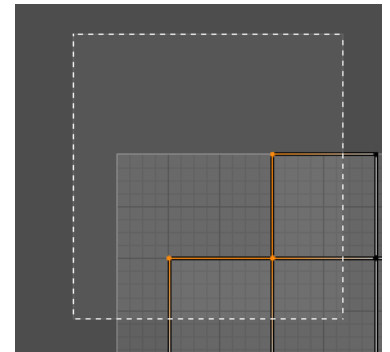

Tool Settings

Mode

The available selection modes. The mode titles are pretty self explaining. So i won't go into detail here.

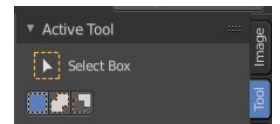

Set a new selection

Extend existing selection

Subtract existing selection

Select Circle

Draws a box to select several elements at once. Click at the start point, then drag.

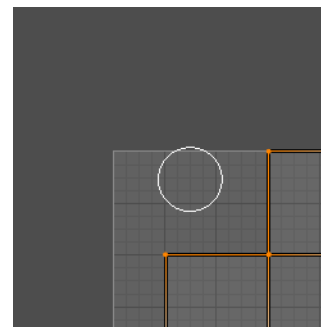

Tool Settings

Mode

The available selection modes. The mode titles are pretty self explaining. So i won't go into detail here.

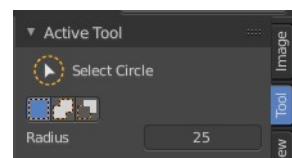

Set a new selection

Extend existing selection

Subtract existing selection

Radius

The brush radius.

Select Lasso

Draws a box to select several elements at once. Click at the start point, then drag.

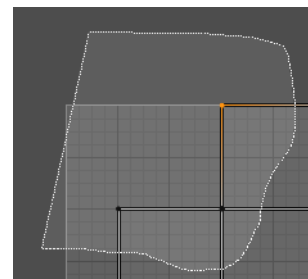

Tool Settings

Mode

The available selection modes. The mode titles are pretty self explaining. So i won't go into detail here.

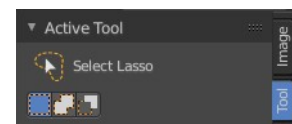

Set a new selection

Extend existing selection

Subtract existing selection

Cursor

The cursor tool allows you to move the 2d cursor around.



Move

Activates the move tool. Activating the move tool also reveals a move widget at the object. This widget allows you to move the object around, by using the corresponding axis.

When you click at one of the square buttons at the icon, then you can move the object along the plane of the two adjacent axis. The rectangle buttons between the arrows allows you to move in direction of the blue and green arrows. This can also be done by clicking at the tip of the arrow and holding down shift. Then you can move the cube along the two other axis.

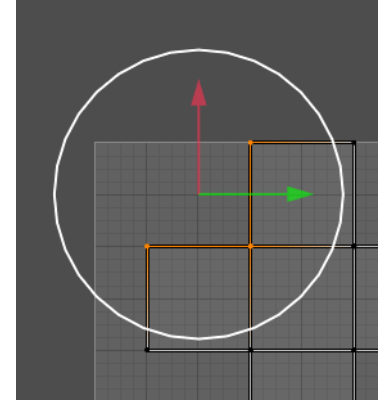

Snapping

Holding down Ctrl activates temporary global snapping.

Precision movement

When you hold down shift, then you will have a much slower but also much preciser movement.

Header Values

When you move your object then you will see some values in the header, which defines the current position of the object.

D: 0.1529 m (0.1529 m) along global Z

The value m stands for the default metric system. Meters. You can change the units in the Properties editor in the Scene properties in the Units panel. When you choose kilometers here then you will see a km instead m.

The value D stands for the distance of the current selected axis. This can also be two axis. Then you have two d values. The value in the brackets is then the direct distance to the starting point.

D: 0.7057 m D: -0.2678 m (0.7548 m) global

These values are always relative to the starting point. You always start with zero, regardless of the real world position.

Numerical Input

When you move the object, and hold down the mouse and type in a value, like 20, then the movement will be performed by the value that you have typed in. In this case by 20 units in direction of the selected axis.

Move without widget

You don't have to use the widget to move the object. You can also click aside of it, and drag the selection around.

Limit Axis

When you want to move into a specific axis, then press X or Y to limit the movement to this axis. This can be combined with the numerical input.



Last Operator Move

Move X, Y Z

The position. Attention, the actual world orientation and rotation does not matter here. It always starts with a value of zero, and moves relative to this zero then. For the actual location values have a look in the sidebar in the transform panel.

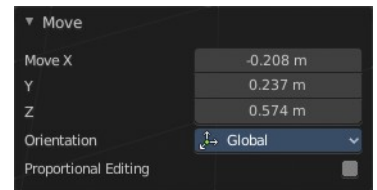

Orientation

The widget can have different orientations. The menu items should be self explaining.

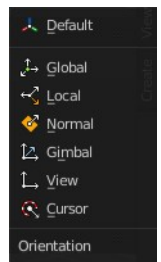

Proportional editing

Enables proportional editing. Activating proportional editing reveals further settings.

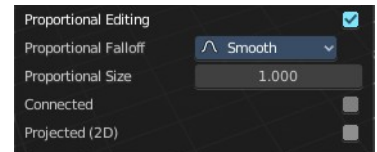

Proportional Falloff

Adjust the falloff methods.

Proportional Size

See and adjust the falloff radius.

Connected

The proportional falloff gets calculated for connected parts only.

Projected(2D)

The proportional falloff gets calculated in the screen space. Depth doesn't play a role. When it's in the radius, then it gets calculated.

Rotate

Activates the Rotate tool. Activating the move tool also reveals a rotate widget at the object. This widget allows you to rotate the object, by using the corresponding axis.



Snapping

Holding down Ctrl activates temporary global snapping.

Precision rotation

When you hold down shift, then you will have a much slower but also much preciser rotation.

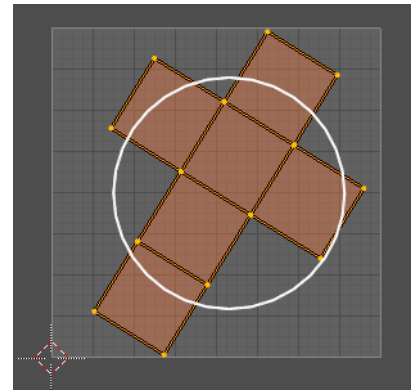

Header Values

When you rotate your object then you will see some values in the header, which defines the current rotation of the object. The rotation is shown in degrees.

Rot: -3.57 global

Numerical Input

When you rotate the object, and hold down the mouse and type in a value, like 20, then the rotation will be performed by the value that you have typed in.

Rotate without widget

You don't have to use the widget to rotate the object. You can also click asides and drag the selection around. This can be combined with the numerical input.

Limit Axis

When you want to rotate a specific axis, then press X or Y to limit the rotation to this axis.

Rot: -0.08 along normal X

By holding down the mouse button and pressing the X, Y or Z key twice you can toggle this to local. But also to other orientations. This depends in what orientation you start. With normal you can toggle that way between Normal and Global.

Last Operator Rotate

Angle

The rotation. Attention, the actual world orientation and rotation does not matter here. It always starts with a value of zero, and rotates relative to this zero then. For the actual rotation values have a look in the sidebar in the transform panel.

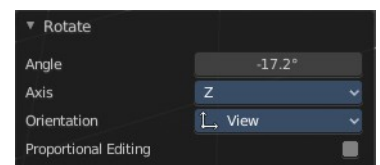

Axis

Which axis to rotate.

Orientation

The widget can have different orientations. The menu items should be self explaining.

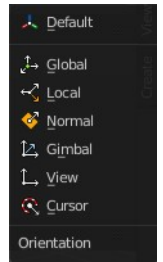

Proportional editing

Enables proportional editing. Activating proportional editing reveals further settings.

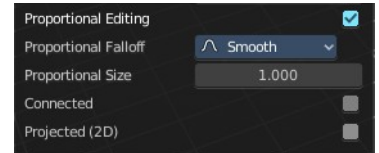

Proportional Falloff

Adjust the falloff methods.

Proportional Size

See and adjust the falloff radius.

Connected

The proportional falloff gets calculated for connected parts only.

Projected(2D)

The proportional falloff gets calculated in the screen space. Depth doesn't play a role. When it's in the radius, then it gets calculated.

Scale

Activates the Scale tool. Activating the scale tool also reveals a traditional scale widget at the object. This widget allows you to scale the object, by using the corresponding axis. When you click at the outer white circle and drag, then you can scale the object uniformly.

The rectangle buttons between the arrows allows you to scale in direction of the adjacent arrows. This can also be done by clicking at the tip of the arrow and holding down shift. Then you can scale the cube along the two other axis.

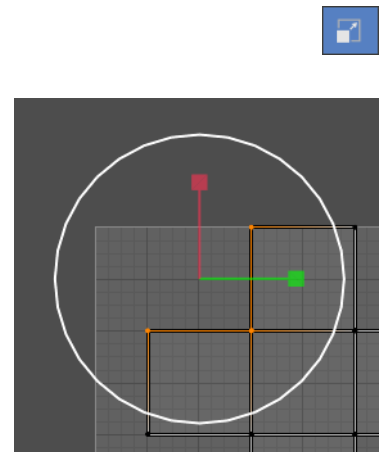

Snapping

Holding down Ctrl activates temporary global snapping.

Precision Scale

When you hold down shift, then you will have a much slower but also much preciser scale.

Header Values

When you scale your object then you will see some values in the header, which defines the



current scale of the object.

These values are always relative to the starting point. You always start with 1, regardless of the real world scale.

Numerical Input

When you scale the object, and hold down the mouse and type in a value, like 20, then the scale will be performed by the value that you have typed in.

Scale without widget

You don't have to use the widget to scale the object. You can also click asides and drag the selection around.

Limit Axis

When you want to rotate a specific axis, then press X or Y to limit the scale to this axis. This can be combined with the numerical input.

Last Operator Resize

Angle

The rotation. Attention, the actual world orientation and rotation does not matter here. It always starts with a value of zero, and rotates relative to this zero then. For the actual rotation values have a look in the sidebar in the transform panel.

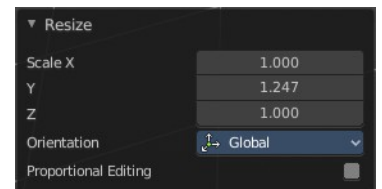

Axis

Which axis to rotate.

Orientation

The widget can have different orientations. The menu items should be self explaining.

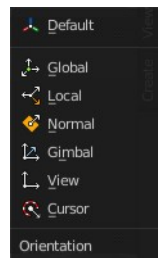

Proportional editing

Enables proportional editing. Activating proportional editing reveals further settings.

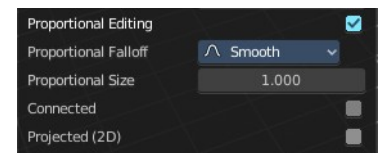

Proportional Falloff

Adjust the falloff methods.

Proportional Size

See and adjust the falloff radius.

Connected

The proportional falloff gets calculated for connected parts only.

Projected(2D)

The proportional falloff gets calculated in the screen space. Depth doesn't play a role. When it's in the radius, then it gets calculated.

Transform

Transform reveals a multi transform widget with all three transform methods available at once. Move, Rotate and Scale.

The rules are the same than for the single tools, and also the last operators. Dependent of which widget part you pull here. So i won't go into detail again here.

Clicking into the area of the widget allows you to move the selection.

Grabbing the sticking out round circle part allows to rotate the selection.

Grabbing one of the corner points allows you to scale the selection.

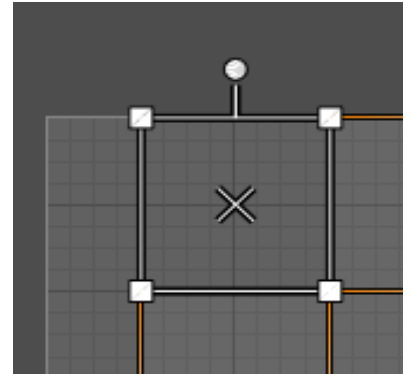

Annotate Tools group

The annotation tool is available in multiple editors. With this tool you can write notes at the screen. The annotate tools is the little brother of the grease pencil objects.

Further settings for annotate can be found in the sidebar. Here you can also remove an annotation when you don't longer need it. And here you can also adjust the size of the stroke.

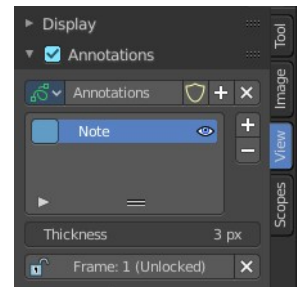
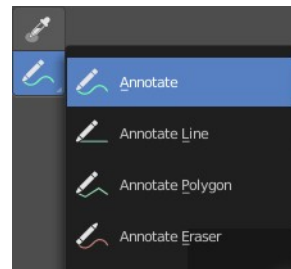

Annotate

Draw free-hand strokes in the main window.

Tool Settings

The tool settings for Annotate.

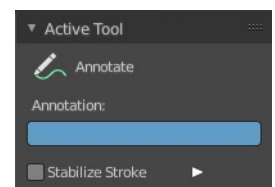

Color

Clicking at the left color field reveals a color picker. Define the color for the annotation stroke.



Stabilize Stroke

Helper to draw smooth and clean lines. Pressing shift inverts the effect.

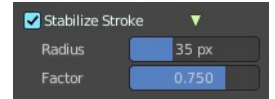

Radius

The radius for the stroke stabilization.

Factor

Stabilizer stroke factor. Higher values gives a smoother stroke.

Annotate Line

Click and drag to create a line.

Tool Settings

The tool settings for the Annotate tool.

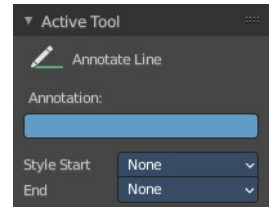

Color

Clicking at the left color field reveals a color picker. Define the color for the annotation stroke.



Style Start

The stroke start style. With an arrow for example you place an arrow at the start of the stroke.

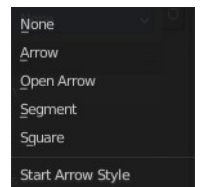

End

The stroke end style. With an arrow for example you place an arrow at the end of the stroke.

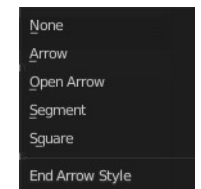

Annotate Polygon

Click multiple times to create multiple connected lines. The current polygon is finished when Esc or RMB is pressed.

Tool Settings

The tool settings for Annotate.

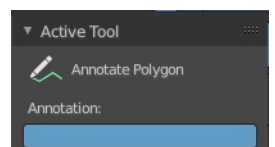

Color

Clicking at the left color field reveals a color picker where you can define the color for the annotation stroke.



Annotate Eraser

Click and drag to remove annotate lines.

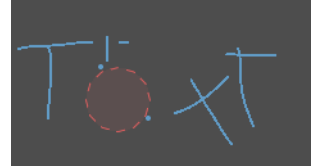

Tool Settings

Radius

The radius of the eraser pencil.

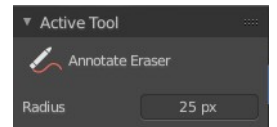

Rip Region

Rip splits the selected UV edge, and moves it with the mouse.

You need to be in UV selection mode Vertice, Edge or Face, and with Use UV Selection mode off. And you need to select at least one edge that is inside of the UV patch so that there is something to rip at all. In the wrong mode and at the wrong edges you will get an error message.

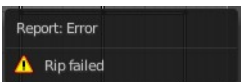
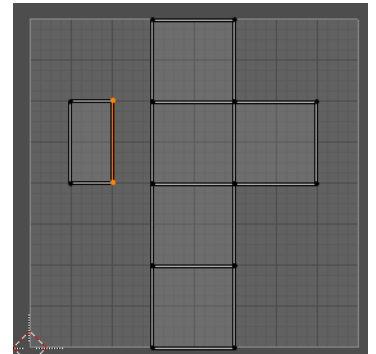

Last Operator UV Rip Move

Please ignore the Proportional Editing at the top. That's a bug that will most probably be fixed soon.

Location X , Y

Mouse location

Move X , Y , Z

Adjust the position.

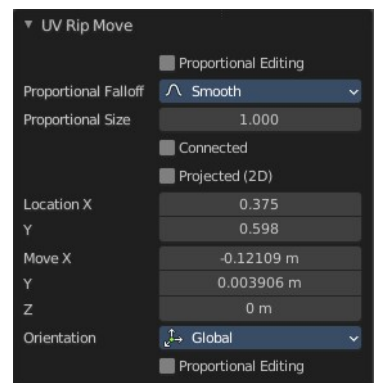

Constraint Axis

Limit the position relative to the source object.

Orientation

Orientation is a drop-down box to choose the type of orientation for the mirroring action.

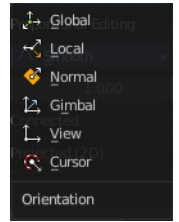

Proportional editing

Enables proportional editing. Activating proportional editing reveals further settings.

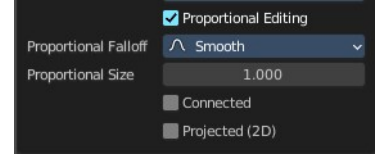

Proportional Falloff

Adjust the falloff methods.

Proportional Size

See and adjust the falloff radius.

Connected

The proportional falloff gets calculated for connected parts only.

Projected(2D)

The proportional falloff gets calculated in the screen space. Depth doesn't play a role. When it's in the radius, then it gets calculated.

Grab

This is a brush tool that has further settings in the Tool tab in the sidebar at the right. Grab allows you to grab and move the geometry under the brush.

The brush radius can be changed with hotkey F. See also the Tool settings in the Brush panel.

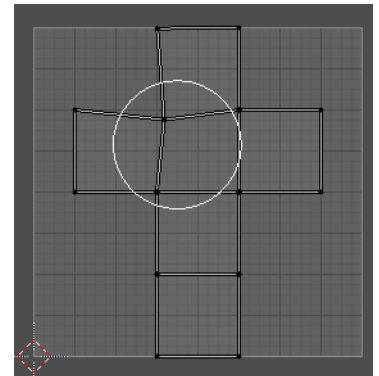

Relax

This is a brush tool that has further settings in the Tool tab in the sidebar at the right. Relax allows you to relax the geometry under the brush. The vertices are more evenly distributed.

The brush radius can be changed with hotkey F. See also the Tool settings in the Brush panel.

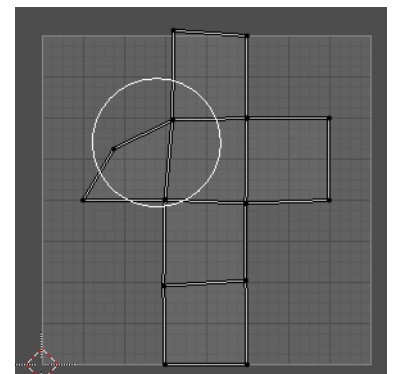

Pinch

This is a brush tool that has further settings in the Tool tab in the sidebar at the right. Pinch allows you to pinch the geometry under the brush. The vertices comes closer to each other.

The brush radius can be changed with hotkey F. See also the Tool settings in the Brush panel.

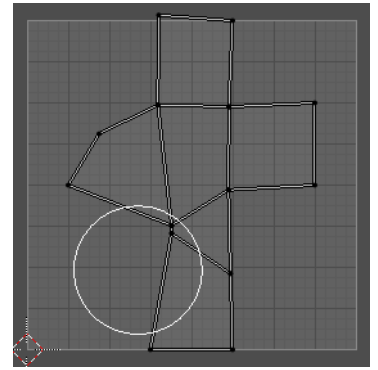



9.3 Editors - UV Editor - Sidebar

Table of content

Introduction..... 1
Right Click menus..... 1

Introduction

The Image Editor is made of several areas. At the right side you will find the sidebar. Here you will find further options and settings for the Image Editor and its tools.

The tools tab contains panels for functionality of the active tools. The Image tab contains image related settings. And the View tab contains view related options and settings.

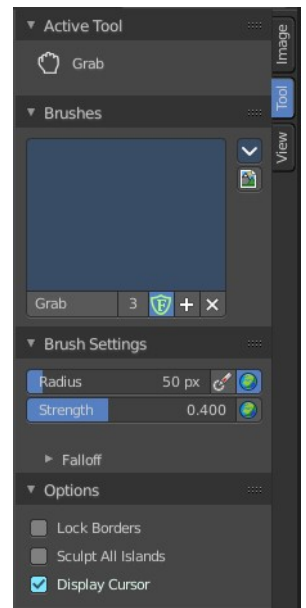

Right Click menus

You will open the usual right click menus when clicking with the right mouse at elements in the sidebar. Its content is in big parts self explaining.

The right click menus are explained in the chapter 6 Editors Introduction.

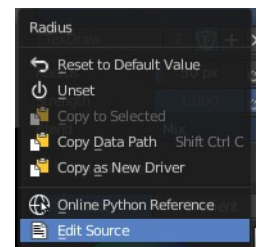



9.3.1 Editors - UV Editor - Sidebar - Image Tab

Table of content

Introduction.....	3
UV Vertex Panel.....	3
Image Panel.....	3
Source.....	3
Source Type Single Image.....	4
Path edit box.....	4
Pack.....	4
Path edit box.....	4
Open.....	4
Refresh.....	4
Info string.....	4
Color Space.....	4
Alpha.....	4
View as Render.....	4
Seam Margin.....	5
Source Type Movie + Image Sequence.....	5
Path edit box.....	5
Pack.....	5
Path edit box.....	5
Open.....	5
Refresh.....	5
Info string.....	5
Frames.....	5
Match Movie Length.....	5
Start.....	5
Offset.....	6
Cyclic.....	6
Auto Refresh.....	6
Deinterlace.....	6
Color Space.....	6
Alpha.....	6
View as Render.....	6
Seam Margin.....	6
Source Type Generated.....	6
X / Y.....	6
Float Buffer.....	6
Generated Type Blank.....	7
Color.....	7
Generated Type UV Grid.....	7
Generated Type Color Grid.....	7
Color Space.....	7
View as Render.....	7
Seam Margin.....	7
Source Type UDIM Tile.....	7
Path edit box.....	8
Pack.....	8
Path edit box.....	8

Open.....	8
Refresh.....	8
Color Space.....	8
Alpha.....	8
View as Render.....	8
Seam Margin.....	8
UDIM Tiles Panel.....	9
UDIM Tile List.....	9
Number.....	9
Drag Handler.....	9
Search Field.....	9
Invert.....	9
Sort by Name.....	9
Add Tile.....	9
Add Tile dialog.....	9
Number.....	9
Count.....	9
Label.....	9
Fill.....	10
Color.....	10
Width / Height.....	10
Alpha.....	10
Generated Type.....	10
32 bit float.....	10
Remove Tile.....	10
Fill Tile.....	10
Fill tile dialog.....	10
Color.....	10
Width / Height.....	10
Alpha.....	10
Generated Type.....	10
32 bit float.....	11
UDIM Workflow.....	11
Metadata Panel.....	13

Introduction

In the Image tabs you can find further options and image settings. These settings changes, dependent of what you have selected. And in what mode you are.

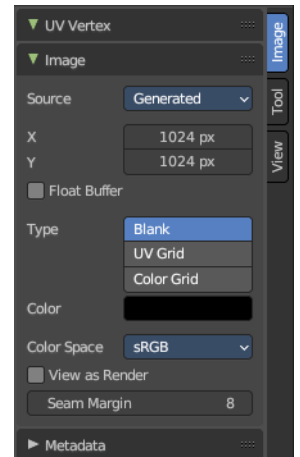

UV Vertex Panel

This Panel shows the position of the current selection. And here you can change the position too. The range goes from 0 to 1 of the UV space.

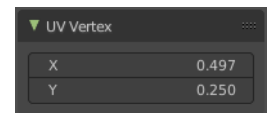
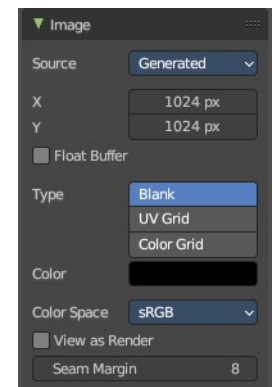

Image Panel

This panel contains image related settings. Size, type, and so on. This panel just shows when an image is loaded.



Source

Choose the image type. This type gets usually automatically set. When you create a new image, then this image is generated. When you load an image then the Source switches to Single Image.

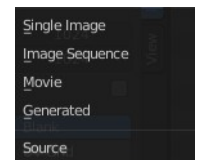

Generated images does not have a path.

Source Type Single Image

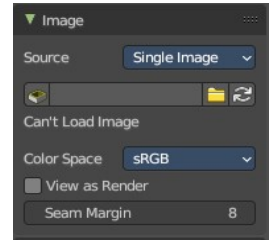

Path edit box

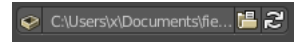

Pack

With this button you can pack the movie or the image sequence into the blend file. It gets packed when you save the blend file the next time.

Path edit box

See and edit the path to your movie or image sequence files.

Open

Open a new movie or image sequence files. A file dialog will appear.

Refresh

Reread the movie or image sequence files.

Info string

Some information about the currently loaded image. Resolution and color space.

Color Space

Choose the color space type for the movie or image sequence files.

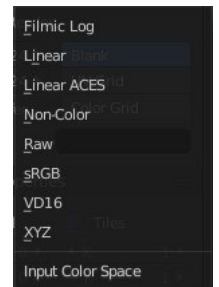

Alpha

Choose the alpha channel mode. Straight or Premultiplied.

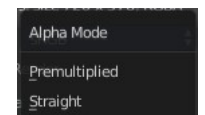

View as Render

Display the image with using the color management settings.

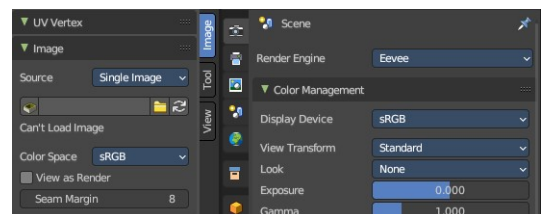

Seam Margin

This belongs to the UV Editor, and has no effect in Image Editor. Take a margin into account when fixing UV seams during painting.

Source Type Movie + Image Sequence

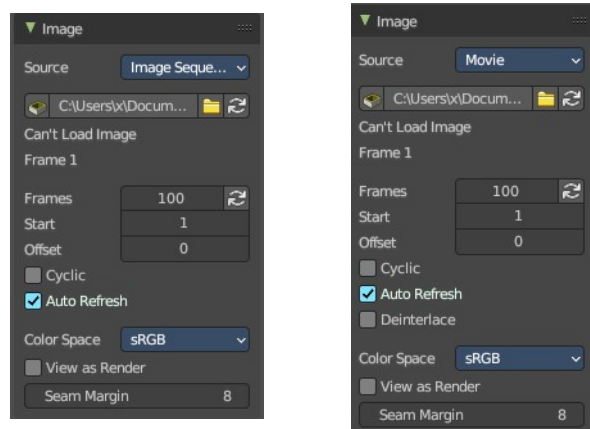

Path edit box

Pack

With this button you can pack the movie or the image sequence into the blend file. It gets packed when you save the blend file the next time.

Path edit box

See and edit the path to your movie or image sequence files.

Open

Open a new movie or image sequence files. A file dialog will appear.

Refresh

Reread the movie or image sequence files.

Info string

Some information about the currently loaded movie. Frames, resolution and color space.

Frames

The number of frames of the movie or image sequence.

Match Movie Length

Set Users Image Length to the one of this video.

Start

The start frame of the movie or image sequence

Offset

Offset the number of the frame to use in the animation. -1 means off.

Cyclic

Cycle the images in the movie.

Auto Refresh

Always refresh image on frame changes.

Deinterlace

Deinterlace the movie file on load.

Color Space

Choose the color space type for the movie or image sequence files.

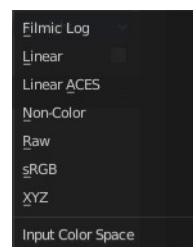

Alpha

Choose the alpha channel mode. Straight or Premultiplied.

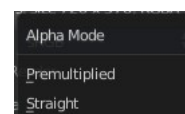

View as Render

Display the image with using the color management settings. The color management can be adjusted in the properties editor in the Render tab.

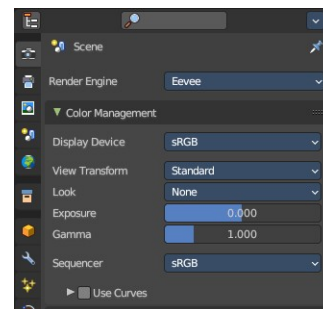

Seam Margin

Take a margin into account when fixing UV seams during painting.

Source Type Generated

X / Y

The image width and height.

Float Buffer

Use a floating point buffer. 8 Bit images uses integers. 32 Bit works with floats.

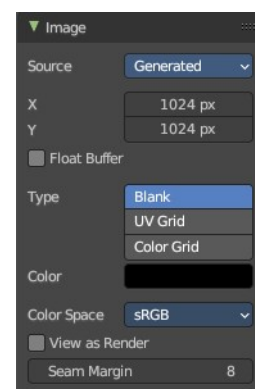

Generated Type Blank

This type displays an image with one blank color

Color

The color of the blank image.

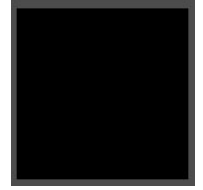

Generated Type UV Grid

This type displays a with a black and white checker texture but colored dots.

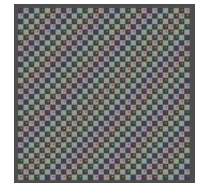

Generated Type Color Grid

This type displays a with a colored checker texture with numbers.



Color Space

Choose the color space type for the image.

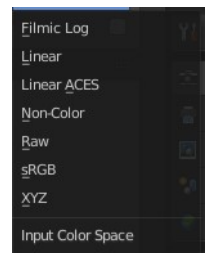

View as Render

Display the image with using the color management settings. The color management can be adjusted in the properties editor in the Render tab.

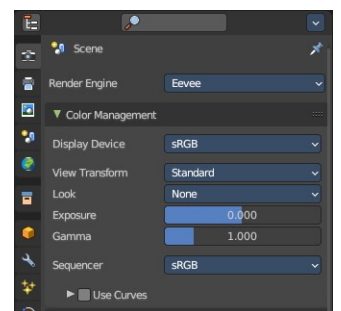

Seam Margin

Take a margin into account when fixing UV seams during painting.

Source Type UDIM Tile

UDIM tiles is a way to deal with several textures in different resolution as one texture. Other software like Substance Painter also works with UDIM textures.

Note that you need to have a fitting numbers of UDIM tiles in the UDIM tiles panel. Or not all UDIM textures will be loaded.

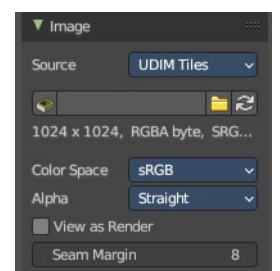

Path edit box

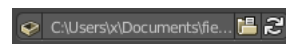

Pack

With this button you can pack the movie or the image sequence into the blend file. It gets packed when you save the blend file the next time.

Path edit box

See and edit the path to your movie or image sequence files.

Open

Open a new movie or image sequence files. A file dialog will appear.

Refresh

Reread the file.

Color Space

Choose the color space type for the image.

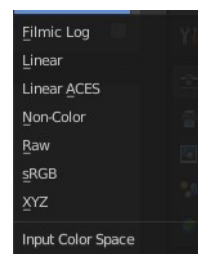

Alpha

Choose the alpha channel mode. Straight or Premultiplied.

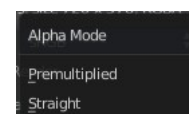

View as Render

Display the image with using the color management settings. The color management can be adjusted in the properties editor in the Render tab.

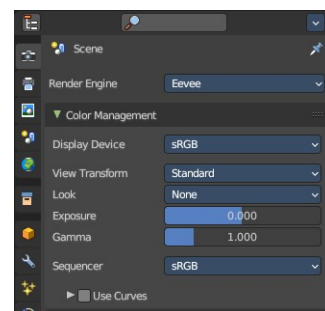

Seam Margin

Take a margin into account when fixing UV seams during painting.

UDIM Tiles Panel

Manage UDIM tiles. This panel shows with source mode UDIM.

UDIM Tile List

List all UDIM tiles associated with the main index (1000 tile). Double clicking on the tile name allows renaming.



Number

The starting tile index number. UDIMs must start with the 1001 tile and typically increase in incremental order.

Drag Handler

The two vertical lines at the end is a handler with which you can expand the list.

Search Field

You can expand a search field at the bottom of the list. Type in your term and hit enter to filter for your term.



Invert

Exclude the search term instead of searching for it.

Sort by Name

Sort the List by name.

Add Tile

Adds new UDIM tiles to the group.

Add Tile dialog

Number

The UDIM tiles are identified by the number. It is four digits, and with increasing number.

Count

How many tiles to add.

Label

Leave blank to use the Number as the name in the list.

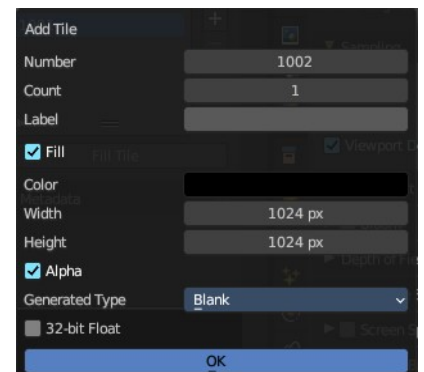

Fill

Fill the new tile with a generated image.

Color

The fill color for generated type Blank.

Width / Height

The dimensions of the image.

Alpha

Does the image have an alpha channel.

Generated Type

The generated texture type.

32 bit float

Generate an image with 32 bit floating point bit depth.

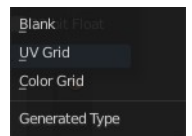

Remove Tile

Remove the selected UDIM tile. Note that the place in the texture will then be blank. The tiles does not resort. The next created UDIM tile will then be placed in this gap.

Fill Tile

Occupy the UDIM tile with a Generated Image. You can change the fill type and texture tile size of a UDIM tile also afterwards with this fill tool. Note that this overwrites the settings of the currently active UDIM tile.

Warning! If a tile is not filled, it will not be saved with the image.

Fill tile dialog

Color

The fill color for generated type Blank.

Width / Height

The dimensions of the image.

Alpha

Does the image have an alpha channel.

Generated Type

The generated texture type.

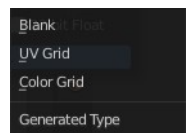
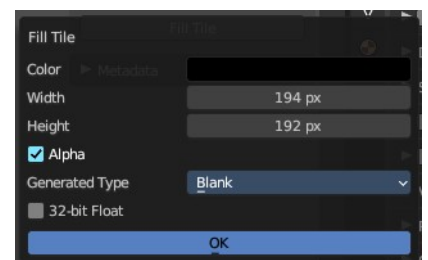

32 bit float

Generate an image with 32 bit floating point bit depth.

UDIM Workflow

First set up the grid shape for the UDIM tiles.

This panel is in the View tab. And will vanish in the moment you add any texture. So do this setup beforehand. There is no way to show and change this grid panel afterwards.

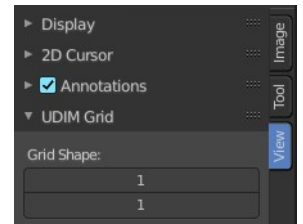

Unwrap your mesh.

Add a generated texture, with generated type Color Grid (optional), and Tiled ticked.

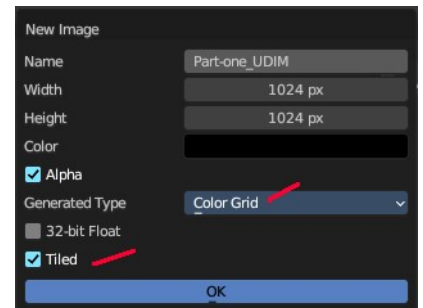

In the viewport you will now see one square UV space again, with the colored background image. And we have our first UDIM tile in the UDIM Tile list.



In the Tile list click at the Add button. And add another image. This time with another resolution.

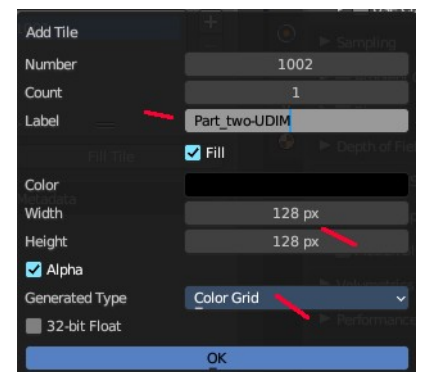

The result is that we have two tiles besides each other, with different resolution.

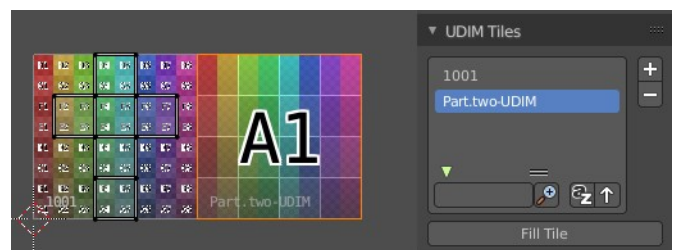

Create a third one. Or as much as you need.



Next move the UV parts to the texture areas where you need them.

Now save the image. And by saving the one UDIM image all the sub images of this UDIM texture gets saved too.

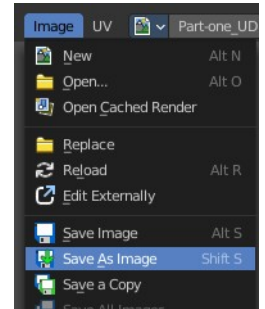
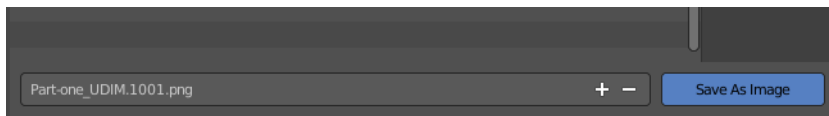

Save the blend file. Modify the textures to your needs.

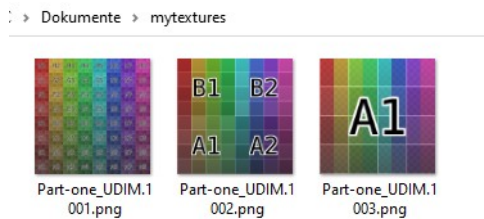

To reload the modified textures either save, close and open Bforartists and reload the scene. Or use Open Image to open the first image of the UDIM textures. The rest will load automatically.

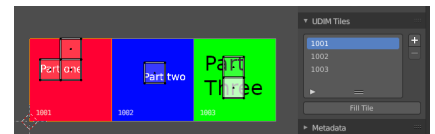

Next create a material. Add a texture. Choose the UDIM texture. And the material will now render with the UDIM textures applied.

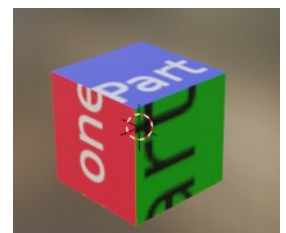

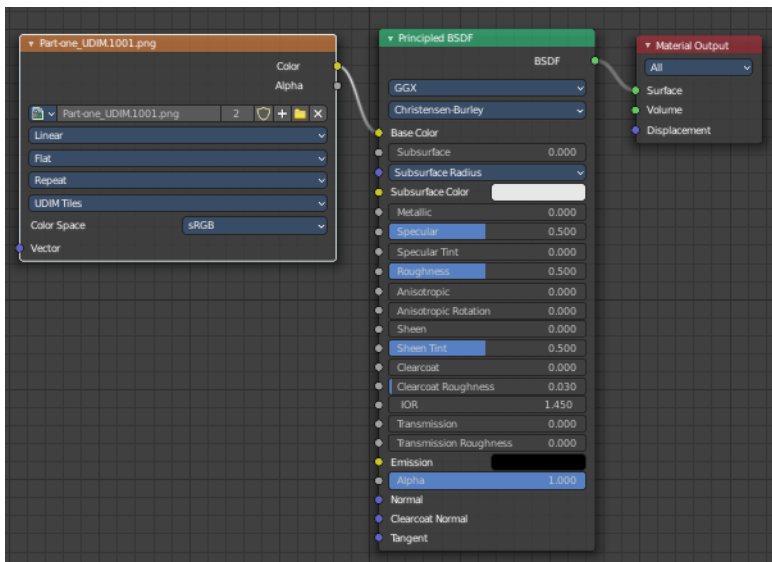

Metadata Panel

Displays existing meta data of the image file.

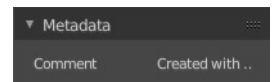



9.3.2 Editors - UV Editor - Sidebar - Tools Tab

Table of content

- Grab Relax and Pinch Brush tools..... 1
- Brush Panel..... 2
 - Browse Brush..... 2
 - Custom Icon..... 2
 - Edit Box..... 2
- Brush Settings Panel..... 3
 - Radius..... 3
 - Strength..... 3
 - Relax..... 3
 - Falloff..... 3
 - Custom falloff panel..... 3
 - Navigation elements..... 3
 - Zoom in and out..... 4
 - Tools..... 4
 - Reset View..... 4
 - Vector Handle..... 4
 - Auto Handle..... 4
 - Auto Clamped Handle..... 4
 - Reset Curve..... 4
 - Use Clipping..... 4
 - Delete Points..... 4
 - Curve window..... 4
 - Curve Presets..... 4

- Options Panel..... 4
- Lock Borders..... 5
- Sculpt all Islands..... 5
- Display Cursor..... 5

Grab Relax and Pinch Brush tools

Grab Relax and Pinch tools are drawing tools. And shows some brush related settings when activated. They are equal. Only the Pinch tool shows some extra settings for the relax method.

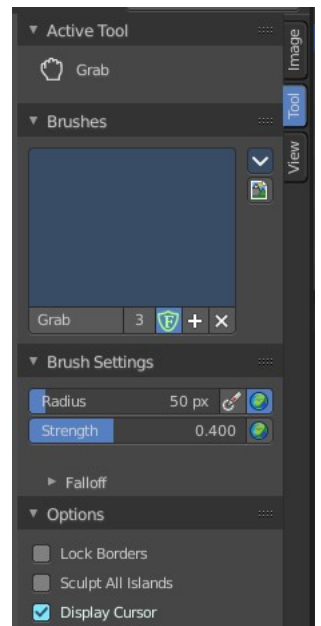

Brush Panel

The Brush Panel contains the different brushes. It is in case of Grab Relax and Pinch tools pretty meaningless. Those tools just have a radius, not a brush. But the brush system is global, and reused in this place here.

Browse Brush

The big image at the top is a drop down box where you can see the current active brush. You can add duplicates of this active brush, and customize it to your needs. But the active brush gets chosen in the Tool Shelf at the left of the 3D View.

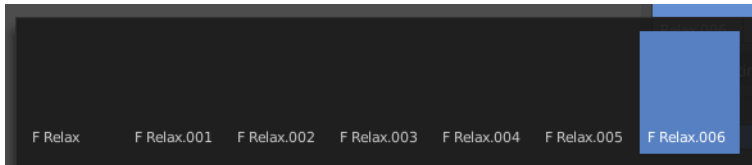
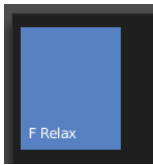
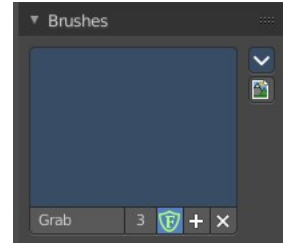

When you have added a few more brushes then the drop down box may be more than full. You will

see some little white arrows then. Either in the top left or in the bottom right corner. They indicate that some brushes are hidden before or after the current display.

To scroll to this hidden content use the mouse wheel, or the arrow up and down buttons at the keyboard.

Custom Icon

Clicking at the custom icon button reveals an edit box to choose a custom icon for the currently active brush.

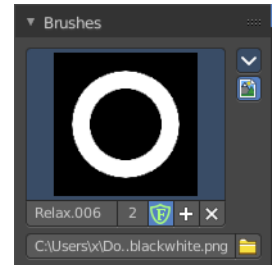
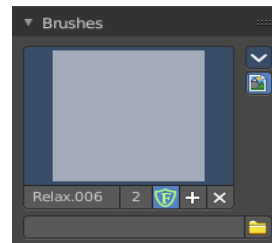

Edit Box

The edit box below the Image shows you the name of the current active brush.

The number right of it, **in this case 2**, indicates how much number of users (internally) this brush uses. This means that this data block (the brush) shares currently settings with at least one other object. Most probably the parent brush where we have created it from. Click at the value to make this brush a single user. The button will vanish then.

Fake user set the brush to have a fake user. Zero user data-blocks are normally not saved. But sometimes you want to force the data to be kept even when the data block has no user.



The + button allows you to add a new pencil with the current settings. Note that the brushes are NOT saved when you close Bforartists. You can save them into the current blend file. Or you can save the startup file. But be careful here. This saves everything else of the current state of Bforartists too.

The X button deletes the brush as the active one. It does NOT delete it from the brushes list.

Brush Settings Panel

Radius

The radius of the brush.

The first button behind the edit box enables tablet pressure sensitivity for radius.

The second button is to adjust if the brush radius uses and changes the global radius values. Or if the radius is just adjusted locally for the current tool set.

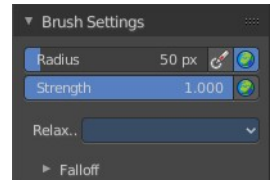

Strength

How powerful the effect is applied.

The button behind the edit box is to adjust if the brush strength uses and changes the global strength values. Or if the strength is just adjusted locally for the current tool set.

Relax

Choose another relaxation method. Default is Laplacian.

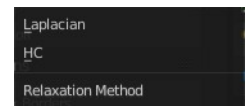

Falloff

Adjust the falloff method of the brush. The drop down box at the top allows you to choose between predefined falloff methods.

The method Custom allows you to create your own falloff curve.

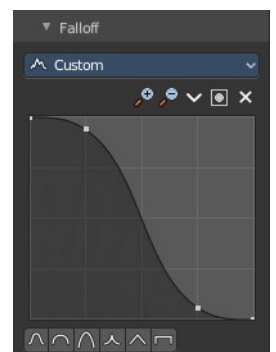
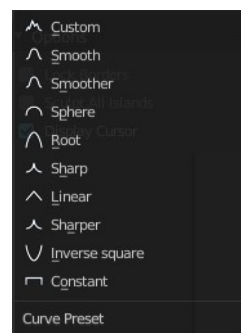

Custom falloff panel

Navigation elements

The navigation elements at the top are described from left to right.

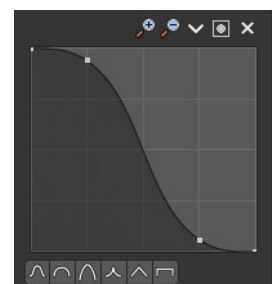

Zoom in and out

The two buttons with the magnifying glass at it zooms in and out in the curve window.

Tools

Tools is a menu where you can find some curve related tools.

Reset View

Resets the curve windows zoom.



Vector Handle

Set handle type to Vector.

Auto Handle

Set handle type to Auto.

Auto Clamped Handle

Set handle type to Auto Clamped.

Reset Curve

Resets the curve to the initial shape.

Use Clipping

Clipping options. Set up clipping for the stroke.

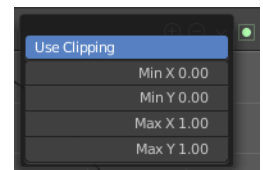

Delete Points

Deletes selected curve point.

Curve window

Tweak and adjust the falloff curve by clicking at a curve point and dragging it around.

Double click adds a new point.

Holding down ctrl activates temporary snapping.

Holding down shift enables slower movement, which allows more accurate setting.

Curve Presets

Predefined curve presets.



Options Panel

Lock Borders

Disable editing of boundary edges.

Sculpt all Islands

Brush operates on all islands.

Display Cursor

Displays the cursor at drawing.





9.3.3 Editors - UV Editor - Sidebar - View Tab

Table of content

View Tab.....	1
Display Panel.....	1
Aspect Ratio.....	1
Repeat Image.....	1
Pixel Coordinates.....	2
2D Cursor panel.....	2
Annotations Panel.....	2
Annotations prop.....	2
Drop down box.....	2
Edit Box.....	2
Fake User.....	2
Add Annotation.....	2
Delete Annotation.....	3
List of Annotation Strokes.....	3
Thickness.....	3
Frame Locked/Unlocked.....	3
Onion Skin.....	3

View Tab

The view tab contains some view related settings.

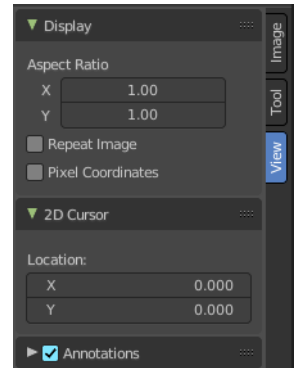

Display Panel

Aspect Ratio

Set the aspect ratio of the image.

Repeat Image

Shows the image not only in the UV range of 0 to 1, but repeats it across the whole canvas. It tiles.

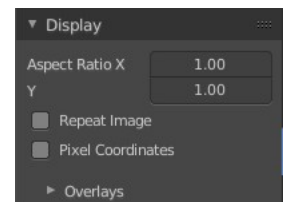

Pixel Coordinates

Shows the coordinates in the image tab in the UV Vertex panel in pixel coordinates instead of the UV range of 0 to 1.

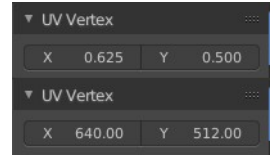

2D Cursor panel

See and edit the position of the 2D cursor.

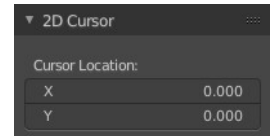

Annotations Panel

Manage the Annotation layers and materials.

When you don't have drawn an annotation yet then the panel just contains a New button.

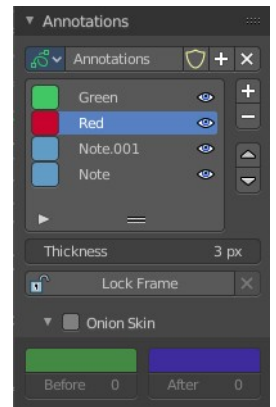
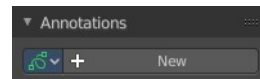

Annotations prop

Add, remove and rename new annotations.

Drop down box

A list of the available annotation layers.

Edit Box

The name of the current annotation. You can rename the annotation to your needs here.

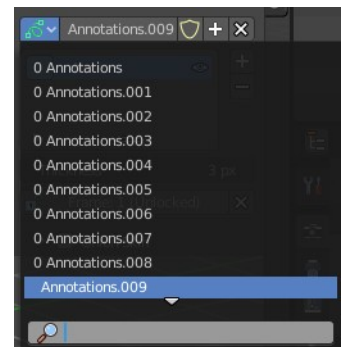

Fake User

Assign a fake user to this annotation. Fake users is an odd concept to keep data in the scene even if it has no user somewhere. The fake user is then a dummy user so that the object is not deleted when saving the scene.

Add Annotation

Add a new annotation.

Delete Annotation

Delete the annotation.

List of Annotation Strokes

Here you see your Annotation layers for the current Annotation. Every layer can have an own color.

At the right side you find buttons to sort them and to add and remove new Annotation layers.

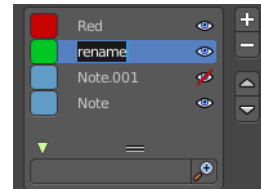

You can change the color by clicking at the color field. A color dialog will pop up. You can rename annotation layers by double clicking at it.

The eye icon allows you to make it invisible And it has a search field.

Thickness

The thickness of the annotation stroke.

Frame Locked/Unlocked

Lock frame displayed by current layer. This toggles whether the active layer is the only one that can be edited.

Onion Skin

Enable Onion Skinning.

Onion Skinning allows to show ghosts of the keyframes before and after the current frame. In this sub panel you can adjust the color of the onion skin frames.



With the numbers below the colors you can define how many frames before or after are displayed that way.



10 Editors - Compositor

Table of content

Compositor Editor.....	2
Navigating in the Compositing Editor viewport.....	2
Hotkeys.....	2
Preview Image in nodes.....	3
Node context menu.....	3
Add.....	3
Find.....	3
Cut Links.....	3
Mute Links.....	4
Exit Group.....	4
Copy.....	4
Paste.....	4
Duplicate.....	4
Rename.....	4
Delete.....	4
Delete with Reconnect.....	4
Make Links.....	4
Make and Replace Links.....	4
Detach Links.....	4
Make Group.....	5
Insert into Group.....	6
Toggle Edit Group.....	6
Ungroup.....	6
Join new Frame.....	6
Remove from Frame.....	6
Rename.....	6
Select submenu.....	7
Grouped.....	7
Linked From.....	7
Linked To.....	7
Activate same type previous.....	7
Activate same type next.....	7
Show/Hide submenu.....	7
Hide.....	7
Toggle Node Mute.....	7
Toggle Node Preview.....	7
Toggle hidden node sockets.....	8
Toggle Node Options.....	8
Collapse and Hide Unused Sockets.....	8
Toggle Node Options.....	8
Collapse and Hide Unused Sockets.....	8
Quick Favorites menu.....	8
Slider snapping.....	9
Hotkey only functionality.....	9
Back image Sample - Alt Right Mouse.....	9

Compositor Editor

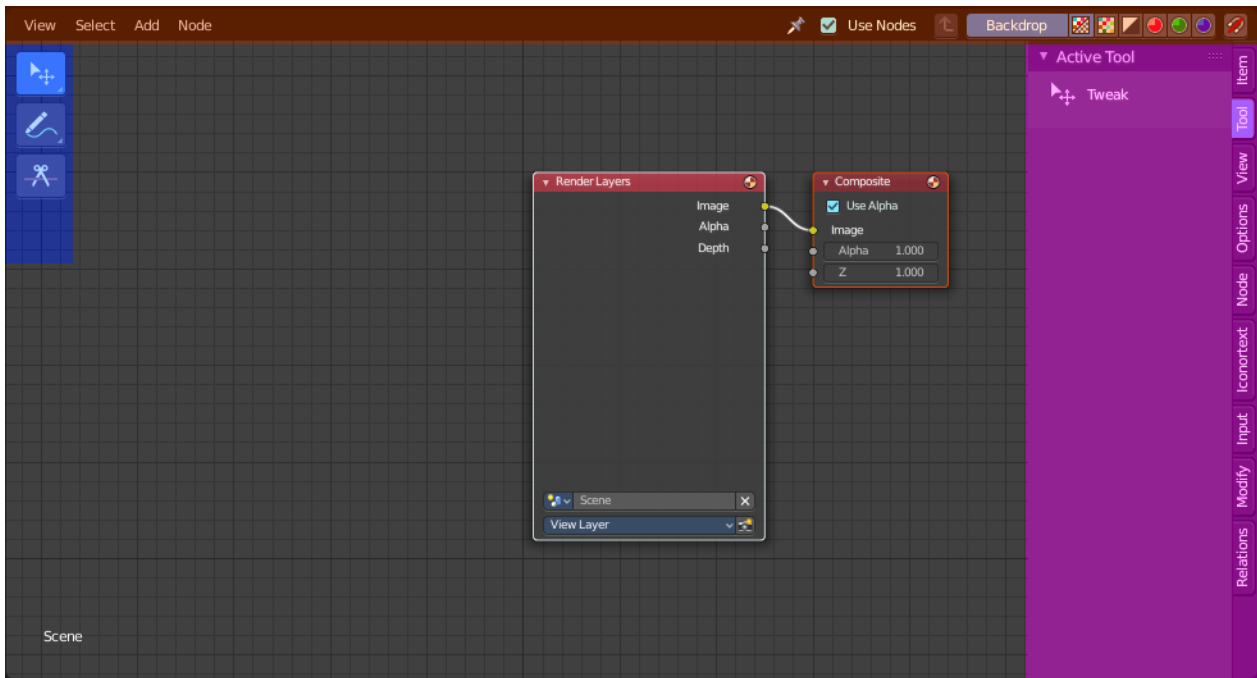

The Compositing editor allows you to do compositing. This means to modify and combine image layers in many different ways and by lots of available nodes. You can glue two pieces of footage together, colorize a whole image sequence at once and do all the traditional compositing steps that you usually would do in a 2d software.

The editor is divided into several areas.

Yellow – Header

Blue - Tool Shelf

Pink - Sidebar

Note that the editor does not have a tool area above the header. All tool settings are in the sidebar in the Tool tab.

Navigating in the Compositing Editor viewport

Hotkeys

Pan the view - MMB

Zoom - Mouse Wheel, MMB+CTRL, Numpad + / -

View All - Home

Preview Image in nodes

Some nodes has two icons up right. The right icon is a button that allows you to expand the node and to show a preview image.

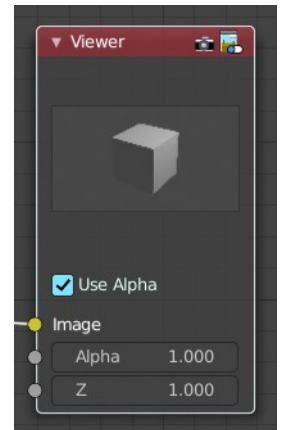
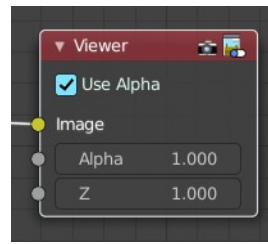

Node context menu

When you double right click into the viewport, then you will open a menu. The UV Context menu. Its content is to 100% double content to already existing menus. And it is despite the name not contextual. It does though show different content under different circumstances.

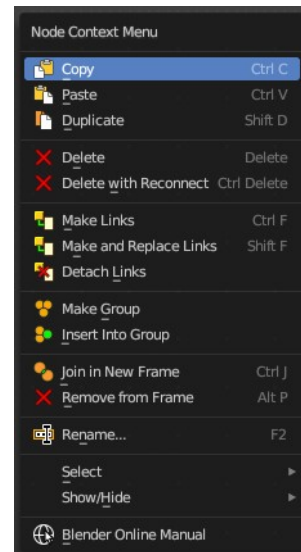
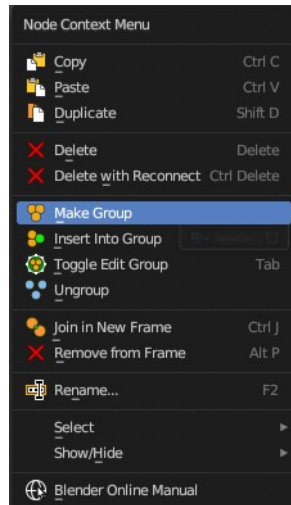
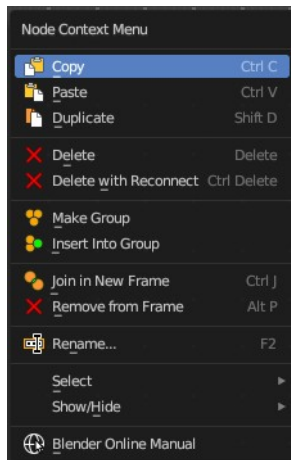
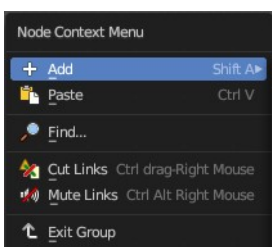

Add

The whole add menu from the header.

Find

Search for nodes, and hilight them. When you are in a node group then it lists the content of the node group.

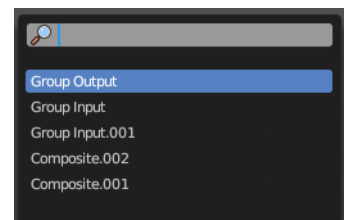
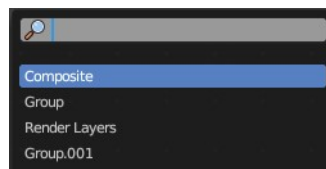

Cut Links

Calls a cut tool with which you can cut links between nodes

Mute Links

Calls a cut tool with which you mute cut links between nodes. To unmute the links use the same tool again.

Exit Group

Same as Edit Group. When you are in a group then you can end editing with this operator.

Copy

Copies the selected nodes.

Paste

Pastes the copied nodes.

Duplicate

Duplicates the selected nodes.

Rename

Allows you to rename the current active node. A popup opens up where you can type in another name.

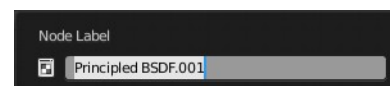

Delete

Deletes the selected nodes. All Connections gets removed.

Delete with Reconnect

Deletes the selected nodes. Existing connections gets bypassed as if the node would not have existed.

Make Links

Shows when you have at least two nodes connected.

Tries to connect nodes where it makes sense. For example, the BSDF output of a Principled shader with the Surface input of the Material Output node.

Make and Replace Links

Shows when you have at least two nodes connected.

Same as Make Links. But it will replace existing links.

Detach Links

Shows when you have at least two nodes connected.

Removes all connections from the selected node, but tries to reconnect the remaining nodes.

Make Group

Groups the selected nodes together.

Select the nodes that you want to group together. Choose Make Group. You will now see a green background. This indicates that the group is created, and that you are in edit mode for the group now.

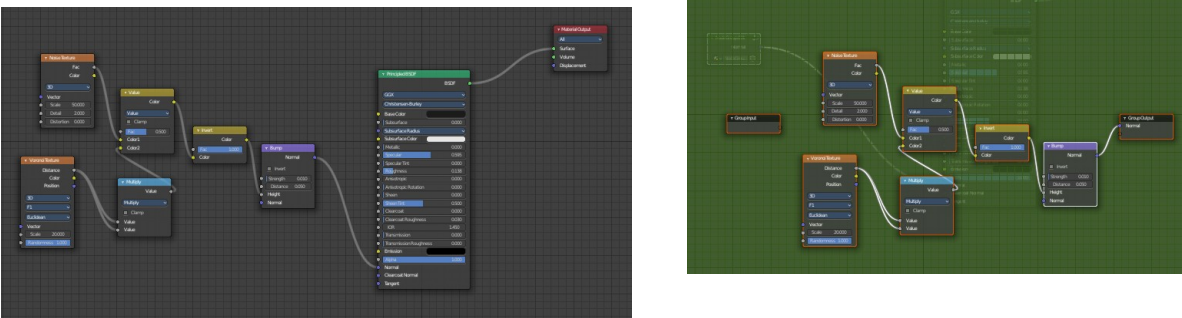

To exit the group edit mode press Tab key, or choose Toggle Edit Group menu item in the sidebar in the Relations tab in the Group panel. That way you can also enter the Group Edit mode again.

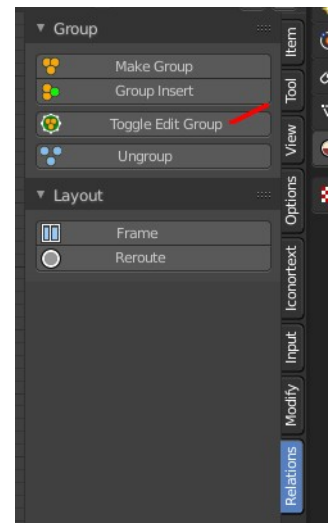
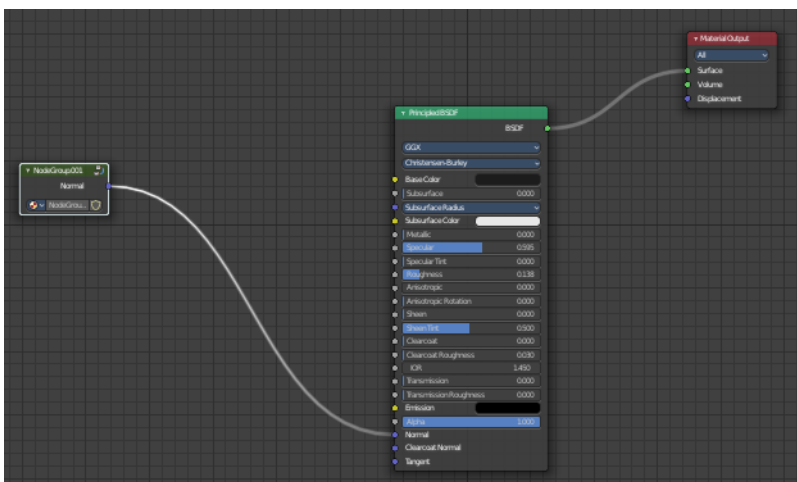

There is a third way to enter the group edit mode. Click at the right upper icon of the group node.

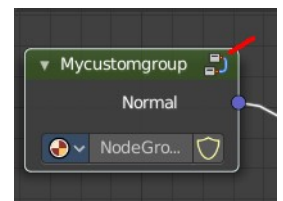

A group can be further collapsed by clicking at the triangle button in the upper left corner.

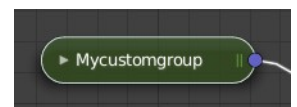

The group can be renamed in the sidebar in the Item tab and in the Properties tab in the Node panel.

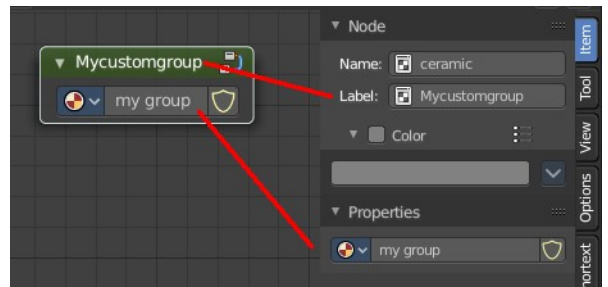

Insert into Group

Allows you to insert a node into a node group.

Select the node, hold down Shift, then select the node group so that both are selected. Then perform the operator.

Toggle Edit Group

Enters a node group for editing. Or when you are in a node group, exits the node group editing.

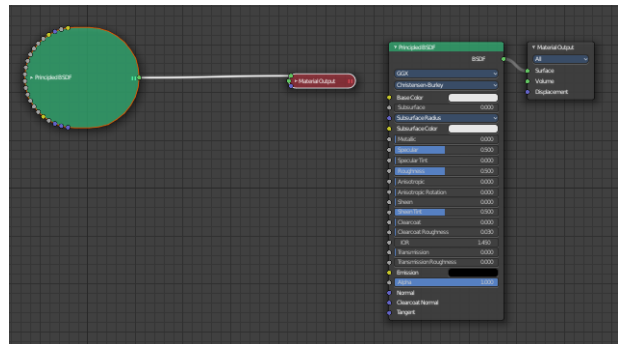

Ungroup

Removes the selected nodes from a group.

Join new Frame

Frame node functionality. Adds the selected node to a frame.

Remove from Frame

Frame node functionality. Removes the selected node from a frame.

Rename

Allows you to rename a node.

Select submenu

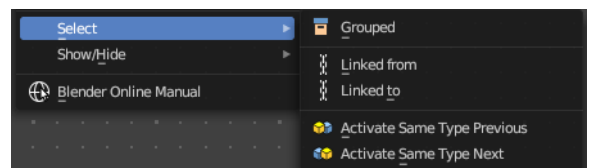

Grouped

Select grouped nodes.

Linked From

Select the nodes that are linked from the currently selected nodes. The nodes before in the hierarchy.

Linked To

Select the nodes that are linked to the currently selected nodes. The nodes behind in the hierarchy.

Activate same type previous

Activate same node type before the current selection, step by step.

Activate same type next

Activate same node type after the current selection, step by step.

Show/Hide submenu

Here you find hide options to make the display of nodes more compact.

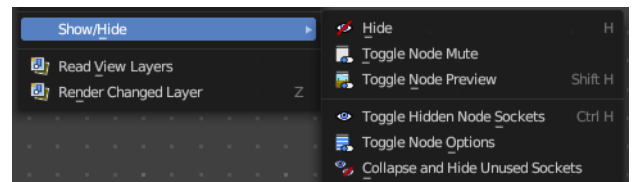

Demonstration happens at an image node.

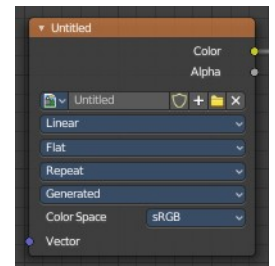

Hide

Hides everything but input and output dots. To view the full node again perform the operator again. It's a toggle. Or click at the triangle left besides the node name.

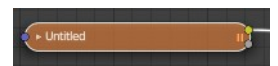

Toggle Node Mute

Deactivates the node.

Toggle Node Preview

This is a compositor feature for the preview image. It does not belong here, but shares the same menu. It shows or hides the preview image.

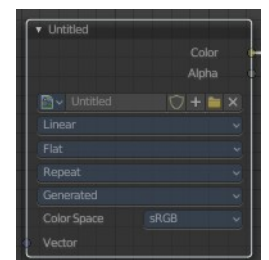

Toggle hidden node sockets

Toggles away the unused node sockets. In this case the vector input node socket and the alpha output node socket will be hidden.

Toggle Node Options

Hides away the properties.

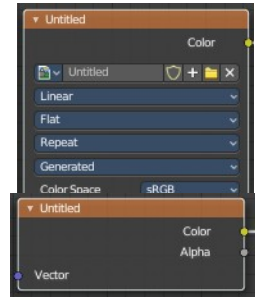

Collapse and Hide Unused Sockets

Like Hide. Hides everything but the node sockets. But it also hides the unused node sockets.



Toggle Node Options

Shows or hides the node options.

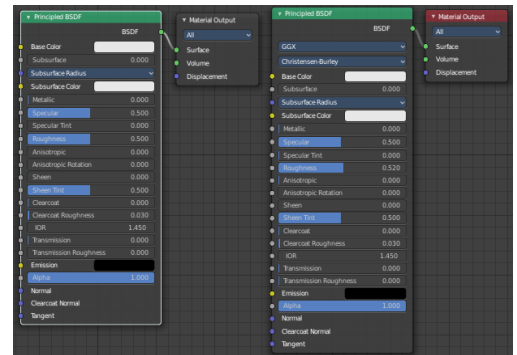

Collapse and Hide Unused Sockets

Shows or hides unused sockets.

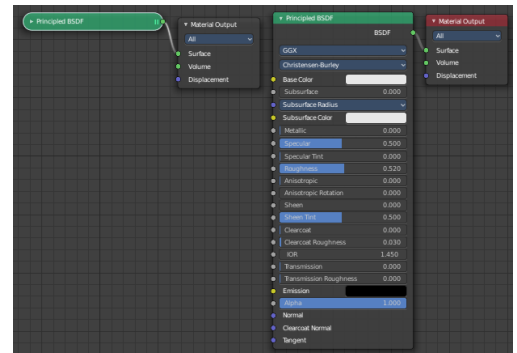

Quick Favorites menu

When you right click at a menu or a button, then a right click menu will open. Tools have usually a Add to Quick Favorites menu entry.

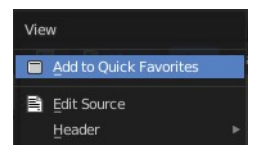

The Quick Favorites Menu is empty by default. With Add to Quick favorites you can add this menu to the Quick menu.

In the 3D view we have a menu called Quick in the header, which shows this content then. In the Image Editor you can just call it with its hotkey. Q. It has

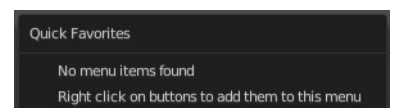

no regular menu entry here.

Slider snapping

Snapping also works at sliders. Hover with the mouse over the slider, start to slide, and holding down **Ctrl** will snap the sliders in incremental steps.

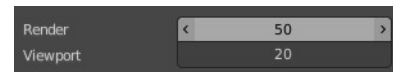

When it's a default value between 0 and 1 then it usually snaps in 0.1 steps. When it's a default value over 1 then it usually snaps in steps of 10.

Hotkey only functionality

Important! These hotkeys works with the default Bforartists key map And they do not list the N dof hotkeys. N dof is a 3d connexion mouse device that is also used for tablets.

Most of the tools can be found in the graphical UI. But there are still some tools that are hotkey only. Some have a UI brother with equal functionality. For example, Pick shortest path is the hotkey sister of Select shortest path. Some are hotkey only since they cannot be integrated in the graphical UI. Like calling the File menu under the mouse. Or mouse position dependent functionality like selecting an edge loop.

The navigation hotkeys and the context menus are excluded here since they are already covered.

Back image Sample - Alt Right Mouse

Displays the color information of the Background Image under the current mouse position. Position, RGB Values, HSV, etc. . You need to have a Viewer node in the compositing chain, and the background image must show.



10.1 Editors - Compositor - Header

Table of content

- Shader Editor - Header.....1
- Header Tabs.....1
- Header right click menus.....1
- Editortype Menu.....1

Compositor Editor - Header

The Header contains various menus, navigation elements, settings and tools for the viewport. The content of the menus may differ, dependent of the chosen renderer.

The header is divided into two areas. Left menus. Right settings.

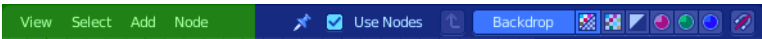

Header Tabs

The tabs at the very left allows you to switch between the most important node editor types by one click. Compositor Editor, Geometry Nodes Editor and Shader Editor.



Header right click menus

The general right click menu functionality is explained in chapter 6 Editors introduction.

Editortype Menu

Bforartists is made of several editor types. Headers can display a menu where you can switch to other editor types.

This menu is hidden by default. It is meant to edit the layouts, and should not be necessary for regular work. You can reveal it in the header right click menu.

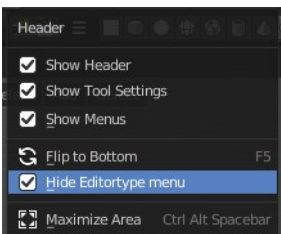
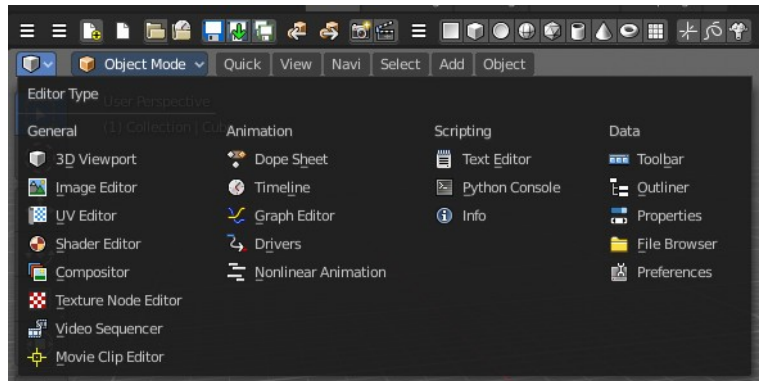



10.1.1 Editors - Compositor - Header - Tools and Options

Table of content

- Options..... 1
- Use Nodes..... 1
- Pin (pin icon)..... 1
- Parent Node Tree..... 1
- Backdrop..... 1
- Background Image Move..... 1
- Background Image Zoom in and out..... 2
- Background Image Fit..... 2
- Display channels..... 2
- Snap..... 2

Options

At the right side of the header you will see the options.



Use Nodes

The Use Nodes setting is mostly a legacy setting and should always be checked for materials.

Pin (pin icon)

The pin button will keep the current material selection fixed. When a material is pinned, it will remain visible in the shader editor even when another object or material is selected elsewhere.

Parent Node Tree

Grouping nodes can simplify a node tree by allowing instancing and hiding parts of the tree. Both material and composite nodes can be grouped. This button becomes active when you work with such grouped nodes, and you are in a child group. it allows you to switch to the parent group.

Backdrop



By adding a viewer node you can display the compositing result as a background in the viewport. Here you can activate it, and adjust the look. It also contains controls to adjust the zoom and position of the backdrop image.

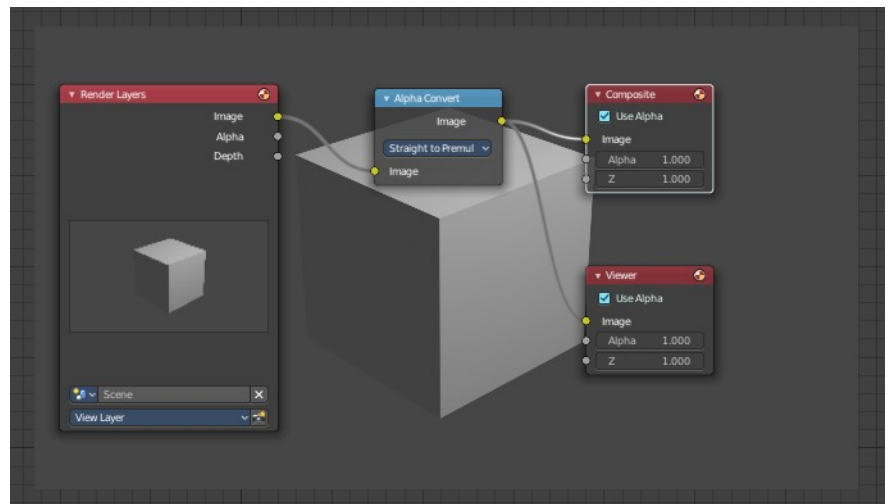

Background Image Move

Move the background image. A click confirms. Watch the hotkey.

Background Image Zoom in and out

Zoom in and out the Background image.

Background Image Fit

Fits the background image into the view.

Display channels

What channels to display in the backdrop.

Snap

Activates snapping. When the tool is activated, then you will also reveal the snap settings where you can choose different snap methods.

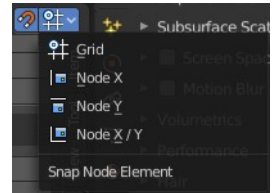

10.1.10 Editors - Compositor Editor - Header - Add Menu - Filter

Table of content

Detailed table of content.....	1
Add menu - Filter.....	6
Anti-Aliasing.....	6
Bilateral Blur.....	7
Blur.....	7
Bokeh Blur.....	9
Defocus.....	10
Denoise.....	12
Despeckle.....	12
Dilate/Erode.....	13
Directional Blur.....	14
Filter.....	15
Glare.....	16
Inpaint.....	17
Kuwahara.....	18
Pixelate.....	19
Sun Beams.....	19
Vector Blur.....	20

Detailed table of content

Detailed table of content

Detailed table of content.....	1
Add menu - Filter.....	6
Anti-Aliasing.....	6
Inputs.....	6
Image.....	6
Properties.....	6
Threshold.....	6
Contrast Limit.....	6
Corner Rounding.....	6
Outputs.....	6
Image.....	6
Bilateral Blur.....	7
Inputs.....	7
Image.....	7
Determinator.....	7
Properties.....	7
Iterations.....	7
Color Sigma.....	7
Space Sigma.....	7
Outputs.....	7
Image.....	7
Blur.....	7

Inputs.....	8
Image.....	8
Size.....	8
Properties.....	8
Filter Type.....	8
Flat.....	8
Tent.....	8
Quadratic.....	8
Cubic.....	8
Gaussian.....	8
Fast Gaussian.....	8
Catmull-Rom.....	8
Mitch.....	8
Variable Size.....	8
Bokeh.....	8
Gamma.....	9
Relative.....	9
Aspect Correction.....	9
X, Y.....	9
Extend Bounds.....	9
Outputs.....	9
Image.....	9
Bokeh Blur.....	9
Inputs.....	9
Image.....	9
Bokeh.....	9
Size.....	9
Bounding Box.....	10
Properties.....	10
Variable Size.....	10
Max blur.....	10
Extend Bounds.....	10
Outputs.....	10
Image.....	10
Defocus.....	10
Inputs.....	10
Image.....	10
Z.....	10
Properties.....	10
Bokeh Type.....	10
Angle.....	11
Gamma Correction.....	11
F-Stop.....	11
Max Blur.....	11
Threshold.....	11
Preview.....	11
Scene.....	11
Use Z-buffer.....	11
Z Scale.....	11
Outputs.....	12
Image.....	12
Denoise.....	12
Inputs.....	12

Image.....	12
Normal.....	12
Albedo.....	12
Properties.....	12
HDR.....	12
Outputs.....	12
Image.....	12
Despeckle.....	12
Inputs.....	13
Factor.....	13
Image.....	13
Properties.....	13
Threshold.....	13
Neighbor.....	13
Outputs.....	13
Image.....	13
Dilate/Erode.....	13
Inputs.....	13
Mask.....	13
Properties.....	13
Mode.....	13
Distance.....	13
Outputs.....	14
Mask.....	14
Directional Blur.....	14
Inputs.....	14
Image.....	14
Properties.....	14
Iterations.....	14
Center X, Y.....	14
Distance.....	14
Angle.....	14
Spin.....	14
Zoom.....	14
Outputs.....	14
Image.....	14
Filter.....	15
Inputs.....	15
Factor.....	15
Image.....	15
Properties.....	15
Filter Type.....	15
Soften.....	15
Sharpen.....	15
Laplace.....	15
Sobel.....	15
Prewitt.....	15
Kirsch.....	15
Shadow.....	15
Outputs.....	15
Image.....	15
Glare.....	16
Inputs.....	16

Image.....	16
Properties.....	16
Glare Type.....	16
Ghosts.....	16
Streaks.....	16
Fog Glow.....	16
Simple Star.....	16
Streaks.....	16
Angle Offset.....	16
Fade.....	16
Size.....	16
Fade.....	16
Rotate 45.....	17
Quality.....	17
Iterations.....	17
Color Modulation.....	17
Mix.....	17
Threshold.....	17
Outputs.....	17
Image.....	17
Inpaint.....	17
Inputs.....	17
Image.....	17
Properties.....	18
Distance.....	18
Outputs.....	18
Image.....	18
Kuwahara.....	18
Inputs.....	18
Image.....	18
Properties.....	18
Kuwahara Filter.....	18
Classic.....	18
Size.....	18
Anisotropic.....	18
Size.....	18
Smoothing.....	18
Outputs.....	18
Image.....	18
Pixelate.....	19
Inputs.....	19
Color.....	19
Outputs.....	19
Color.....	19
Sun Beams.....	19
Inputs.....	19
Image.....	19
Properties.....	19
Source width, height.....	19
Ray length.....	19
Outputs.....	19
Image.....	19
Vector Blur.....	20

Inputs.....	20
Image.....	20
Z.....	20
Speed.....	20
Properties.....	20
Samples.....	20
Blur.....	20
Speed.....	20
Min.....	20
Max.....	20
Outputs.....	20
Image.....	20

Add menu - Filter

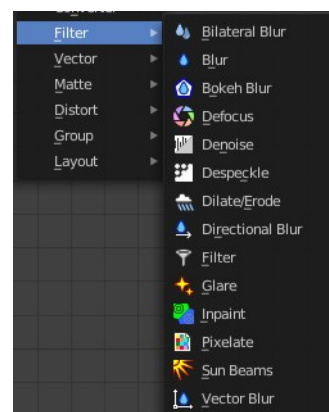

Anti-Aliasing

Adds antialiasing to edges in an image.

Inputs

Image

Standard image input.

Properties

Threshold

Threshold to detect edges.

Contrast Limit

How much to eliminate suspicious edges to avoid artifacts.

Corner Rounding

How much sharp corners will be rounded.

Outputs

Image

Standard image output.

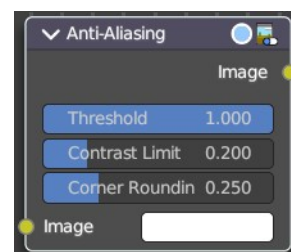
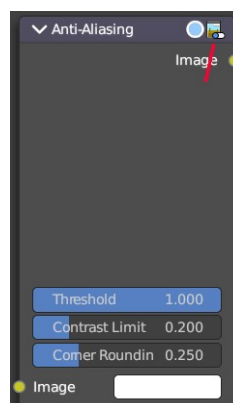

Bilateral Blur

The Bilateral Blur node performs a high-quality adaptive blur on the source image, allowing to blur images while retaining their sharp edges.

It can be used for various purposes like: smoothing noisy render passes to avoid longer computation times in example ray-traced ambient occlusion, blurry refraction's/reflections, soft shadows, or to make non-photo realistic compositing effects.

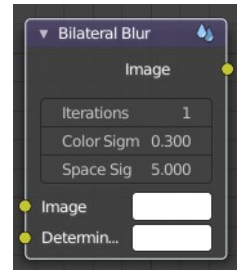

Inputs

Image

Standard image input. If only the image input is connected, the node blurs the image depending on the edges present in the source image.

Determinator

Which is non-obligatory and if the Determinator is connected, it serves as the source for defining edges/borders for the blur in the image. This has great advantage in case the source image is too noisy, but normals in combination with Z-buffer can still define exact borders/edges of objects.

Properties

Iterations

Defines how many times the filter should perform the operation on the image. It practically defines the radius of blur.

Color Sigma

Defines the threshold for which color differences in the image should be taken as edges.

Space Sigma

A fine-tuning variable for blur radius.

Outputs

Image

Standard image output.

Blur

The Blur node provides several blur modes to blur an image. The icon top right allows you to collapse and show the image part of the node.

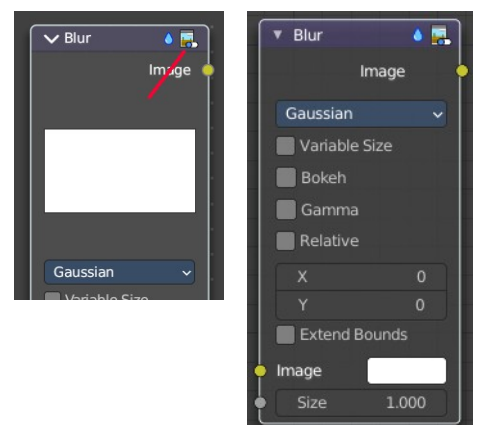

Inputs

Image

Standard image input.

Size

The optional Size input will be multiplied with the X and Y blur radius values. It accepts also a value image, to control the blur radius with a mask. The values should be mapped between (0 to 1) for an optimal effect.

Properties

Filter Type

The difference between the types is in the way they handle sharp edges, smooth gradients and preserve the highs and the lows.

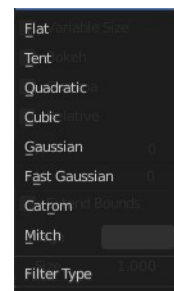

Flat

Simply blurs everything uniformly.

Tent

Preserves the high and the lows better by making a linear falloff.

Quadratic

Looks similar to Gaussian but can be a little faster but slightly worse looking.

Cubic

Preserve the highs, but give an almost out-of-focus blur while smoothing sharp edges.

Gaussian

Gives the best looking results but tends to be the slowest.

Fast Gaussian

An approximation of the Gaussian.

Catmull-Rom

Catmull-Rom keeps sharp contrast edges crisp.

Mitch

Preserve the highs, but give an almost out-of-focus blur while smoothing sharp edges.

Variable Size

Allows a variable blur radius, if the size input is an image.

Bokeh

The Bokeh button will force the Blur node to use a circular blur filter. This gives higher quality results, but is slower than using a normal filter.

Gamma

The Gamma button applies a gamma correction on the image before blurring it.

Relative

Percentage Value of the blur radius relative to the image size.

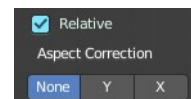

Aspect Correction

A subset of the Relative property. None, Y, X

X, Y

Values set the ellipsoid radius in numbers of pixels over which to spread the blur effect.

Extend Bounds

Allows the image, that is being blurred, to extend past its original dimension.

Outputs

Image

Standard image output.

Bokeh Blur

The Bokeh Blur node generates a bokeh type blur similar to Defocus. Unlike defocus an in-focus region is defined in the Compositor.

Several performance optimizations are also available such as OpenCL support, calculation area restriction and masking.

Inputs

Image

Standard image input.

Bokeh

This is an input for the Bokeh Image node.

Size

Size controls the amount of blur. Size can either be a single value across the entire image or a variable value controlled by an input image. In order to use the latter, the Variable Size option must be selected. See the examples section below for more on how to use this.

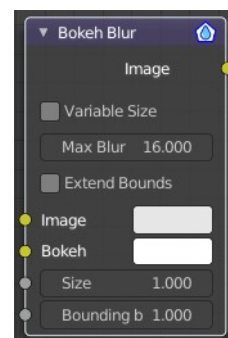

Bounding Box

This can be used with a Box Mask matte node or with a Mask input node to restrict the area of the image the blur is applied to. This could be helpful, for example, when developing a node system by allowing only a small area of the image to be filtered thus saving composite time each time adjustments are made.

Properties

Variable Size

Allows a variable blur radius, if the Size input is an image.

Max blur

Max blur is intended to act as an optimization tool by limiting the number of pixels across which the blur is calculated.

Extend Bounds

Extend the bounds of the input image to fully fit the blurred image.

Outputs

Image

Image output.

Defocus

It is typically used to emulate depth of field (DOF) using a post-processing method with a Z-buffer input. But also allows to blur images that are not based on Z depth too.

Inputs

Image

Standard image input.

Z

Z-buffer input, but could also be a (greyscale) image used as a mask, or a single value input.

Properties

Bokeh Type

The number of iris blades of the virtual camera's diaphragm.

Disk (to emulate a perfect circle) or Triangle (3 blades), Square (4 blades), Pentagon (5 blades), Hexagon (6 blades), Heptagon (7 blades) or Octagon (8 blades).

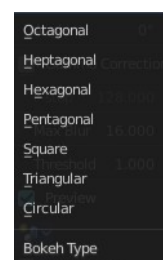
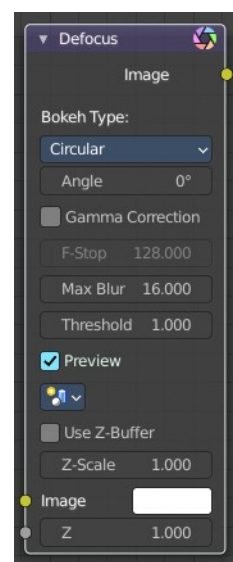

Angle

This button is deactivated, if the Bokeh Type is set to Disk. It can be used to add a rotation offset to the Bokeh shape. The value is the angle in degrees.

Gamma Correction

Applies a gamma correction on the image before and after blurring it.

F-Stop

This option controls the amount of focal blur in the same way as a real camera. It simulates the aperture f of a real lens' iris, without modifying the luminosity of the picture. The default value 128 is assumed to be infinity: everything is in perfect focus. Half the value will double the amount of blur. This button is deactivated, if No Z-buffer is enabled.

Max Blur

This value limits the amount of blur by setting a maximum blur radius. Could be used to optimize the performance. The default value of 0 means no limit.

Threshold

Some artifacts, like edge bleed, may occur, if the blur difference between pixels is large. This value controls how large that blur difference considered to be safe.

Tip! Only change this value, if there is an occurring problem with an in-focus object.

Preview

If enabled a limited amount of (quasi-)random samples are used to render the preview. This way of sampling introduces additional noise, which will not show up in the final render.

Scene

Select the linked scene. Scenes can be created in the properties editor in the Scene properties tab in the Scene panel.

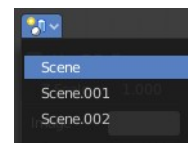

Use Z-buffer

Should be activated for a non Z-buffer in the Z input. No Z-buffer will be enabled automatically whenever a node that is not image based is connected to the Z input.

Z Scale

Only active when No Z-buffer is enabled. When No Z-buffer is used, the input is used directly to control the blur radius (similar to F-Stop when using the Z-buffer). This parameter can be used to scale the range of the Z input.

Outputs

Image

Image output.

Denoise

The Denoise node is used to denoise renders from Cycles and other ray tracing renderers. This helps to significantly reduce render time by rendering with fewer samples.

It uses Open Image Denoise, which transforms noisy images into clean images with machine learning.



Inputs

Image

Noise image input.

Normal

Optional normal render pass to better preserve detail. For Cycles, it is recommended to use the Denoising Normal render pass, which is available when enabling the Denoising Data passes.

Albedo

Optional Albedo render pass to better preserve detail. For Cycles, it is recommended to use the Denoising Albedo render pass, which is available when enabling the Denoising Data passes.

Properties

HDR

Preserve colors outside the 0 to 1 range.

Outputs

Image

Denoised image output.

Despeckle

The Despeckle node is used to smooth areas of an image in which noise is noticeable, while leaving complex areas untouched.

This works by the standard deviation of each pixel and its neighbors is calculated to

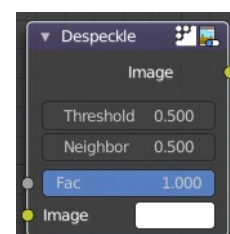

determine if the area is one of high complexity or low complexity. If the complexity is lower than the threshold then the area is smoothed using a simple mean filter.

Inputs

Factor

Controls the amount the filter effects the image.

Image

Standard image input.

Properties

Threshold

The threshold to control high/low complexity.

Neighbor

The threshold to control the number of pixels that must match.

Outputs

Image

Standard image output.

Dilate/Erode

The Dilate/Erode node provides a morphology (mathematical shape analysis) filter.

Inputs

Mask

Single color channel (or a black-and-white image) input.

Properties

Mode

There are four different dilate / erode modes. Step, Threshold, Distance and Feather.

Distance

The Distance is the filter radius. A positive value of Distance dilates (expands) the influence of a pixel on its surrounding pixels. A negative value erodes (shrinks) its influence.

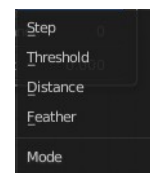
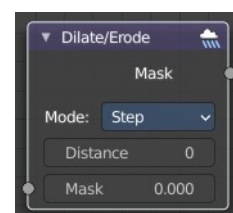

Outputs

Mask

The filtered mask output.

Directional Blur

Blurs an image in a specified direction and magnitude. Can be used to fake motion blur.

Inputs

Image

Standard image input.

Properties

Iterations

Controls how many times the image is duplicated to create the blur effect. Higher values give smoother results.

Center X, Y

Sets the position where the blur center is. This makes a difference if the angle, spin, and/or zoom are used.

Distance

How large the blur effect is.

Angle

Image is blurred at this angle from the center.

Spin

Rotates the image each iteration to create a spin effect, from the center point.

Zoom

Scales the image each iteration, creating the effect of a zoom.

Outputs

Image

Image output.

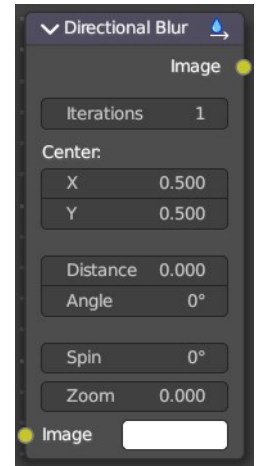

Filter

The Filter node implements various common image enhancement filters.

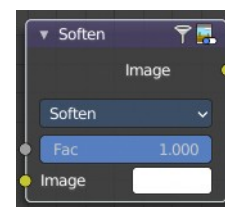

Inputs

Factor

Controls the amount of influence the node exerts on the output image.

Image

Standard image input.

Properties

Filter Type

The available filter types. Soften, Laplace, Sobel, Prewitt and Kirsch all perform edge detection (in slightly different ways) based on vector calculus and set theory equations.

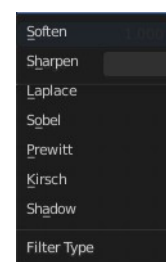

Soften

Slightly blurs the image.

Sharpen

Increases the contrast, especially at edges.

Laplace

Softens around edges.

Sobel

Creates a negative image that highlights edges.

Prewitt

Tries to do Sobel one better.

Kirsch

Giving a better blending than Sobel or Prewitt, when approaching an edge.

Shadow

Performs a relief, emboss effect, darkening outside edges.

Outputs

Image

Standard image output.

Glare

The Glare node is used to add lens flares, fog, glows around exposed parts of an image and much more.

Inputs

Image

Standard image input.

Properties

Note that some of the properties just appears with the corresponding glare type and the corresponding quality setting.

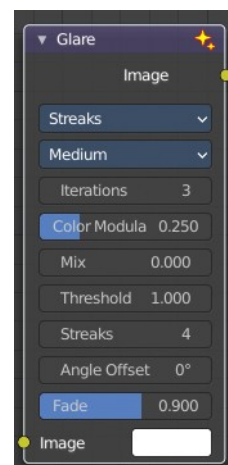

Glare Type

Ghosts

Creates a haze over the image.

Streaks

Creates bright streaks used to simulate lens flares.

Fog Glow

Looks similar to Ghost. However, it is much smaller in size and gives more of an atmospheric haze or “glow” around the image.

Simple Star

Works similar to Streaks but gives a simpler shape looking like a star.

Streaks

Total number of streaks.

Angle Offset

The rotation offset factor of the streaks.

Fade

Fade out factor for the streaks.

Size

Scale of the glow relative to the size of the original bright pixels.

Fade

Fade out factor for the streaks.



Rotate 45

Rotate the streaks by 45°.

Quality

If not set to something other the High, then the glare effect will only be applied to a low resolution copy of the image. This can be helpful to save render times while only doing preview renders.

Iterations

The number of times to run through the filter algorithm. Higher values will give more accurate results but will take longer to compute. Note that, this is not available for Fog Glow as it does not use an iterative-based algorithm.

Color Modulation

Used for Streaks and Ghosts to create a special dispersion effect.

Johannes Itten describes this effect, Color Modulation, as subtle variations in tones and chroma.

Mix

Value to control how much of the effect is added on to the image. A value of -1 would give just the original image, 0 gives a 50/50 mix, and 1 gives just the effect.

Threshold

Pixels brighter than this value will be affected by the glare filter.

Outputs

Image

Standard image output.

Inpaint

The Inpaint node is used to extend borders of an image into transparent or masked regions. This can be useful to solve problems like “wire removal” and holes created during chroma keying.

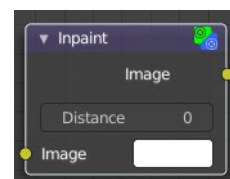

Inputs

Image

Standard image input.

Properties

Distance

The number of times to extend the image.

Outputs

Image

Standard image output.

Kuwahara

Kuwahara is a filter that converts a realistic image into a stylized image.

Inputs

Image

Standard image input.

Properties

Kuwahara Filter

There are two Kuwahara variations available. Classic and Anisotropic.

Classic

Size

The size of the Kuwahara filter.

Anisotropic

Size

The size of the Kuwahara filter.

Smoothing

Smoothing degree before applying filter.

Outputs

Image

Standard image output.

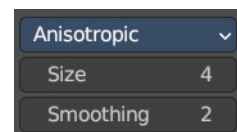
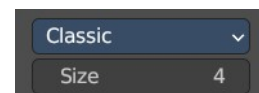
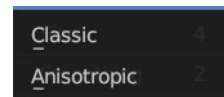

Pixelate

Add this node in front of a Scale node to get a pixelated (non-smoothed) image from the resultant upscaled image.

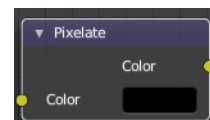

Inputs

Color

Standard image input.

Outputs

Color

Image output.

Sun Beams

The Sun Beams node provides a computationally cheap way of creating the name giving effect based on the image brightness alone.

Sun Beams is a 2D effect for simulating the effect of bright light getting scattered in a medium (Crepuscular Rays). This phenomenon can be created by renderers, but full volumetric lighting is a rather arduous approach and takes a lot of render time.

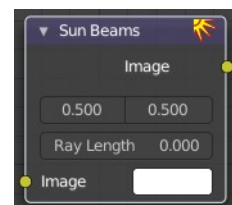

Inputs

Image

Standard image input.

Properties

Source width, height

Source point of the rays as a factor of the image dimensions.

Ray length

Length of the rays as a factor of the image size.

Outputs

Image

Image output.

Vector Blur

The Vector Blur node is a fast method for simulating Motion blur in compositing. It uses the vector speed render pass to blur the image pixels in 2D.

Inputs

Image

Image input, to be linked to the “Combined” render pass.

Z

Z depth, to be linked to the “Depth” render pass.

Speed

Input for the “Vector” render pass. See Cycles render passes.

Properties

Samples

Quality factor.

Blur

Scaling factor for the motion vector (actually the “shutter speed” in frames).

Speed

The vector blur could produce artifacts like streaks, lines and other. To tackle these problems, the filter applies clamping, which can be used to limit which pixels get blurred. The speed is set in pixel units.

Min

The minimum threshold for moving pixels can separate the hardly moving pixels from the moving ones. Especially when the camera itself moves, the vector mask can become the entire image.

Max

The maximum threshold. The majority of artifacts are caused by pixels moving too fast.

Outputs

Image

Motion blurred image output.

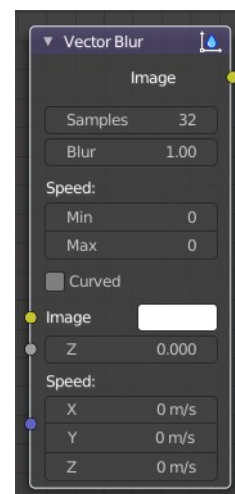

10.1.11 Editors - Compositor Editor - Header - Add Menu - Vector

Table of content

Detailed table of content.....	1
Add menu - Vector.....	2
Map Range.....	2
Map Value.....	3
Normal.....	4
Normalize.....	4
Vector Curves.....	5

Detailed table of content

Detailed table of content

Detailed table of content.....	1
Add menu - Vector.....	2
Map Range.....	2
Usage.....	2
Inputs.....	3
Value.....	3
From Min/Max.....	3
To Min/Max.....	3
Properties.....	3
Clamp.....	3
Outputs.....	3
Value.....	3
Map Value.....	3
Inputs.....	3
Value.....	3
Properties.....	3
Offset.....	3
Size.....	3
Use Minimum, Maximum.....	3
Min, Max.....	3
Outputs.....	4
Value.....	4
Normal.....	4
Inputs.....	4
Normal.....	4
Properties.....	4
Normal Direction.....	4
Outputs.....	4
Normal.....	4
Dot.....	4
Normalize.....	4
Inputs.....	4
Value.....	4
Outputs.....	5

- Value.....5
- Vector Curves.....5
 - Inputs.....5
 - Vector.....5
 - Properties.....5
 - Channel.....5
 - Channel buttons.....5
 - Curve edit field.....5
 - Selecting Points.....5
 - Adding Points.....5
 - Navigation elements.....5
 - Zoom in and out.....5
 - Tools.....6
 - Reset View.....6
 - Vector Handle.....6
 - Auto Handle.....6
 - Auto Clamped Handle.....6
 - Extend horizontal.....6
 - Extend extrapolated.....6
 - Reset Curve.....6
 - Use Clipping.....6
 - Delete Points.....6
- Outputs.....6
 - Vector.....6

Add menu - Vector

Here you find nodes that deals with vector data.

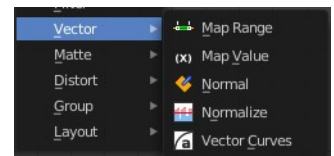

Map Range

This node allows to convert (map) an input value range into a destination range. By default, values outside the specified input range will be proportionally mapped as well. This node is similar to Map Value node but provides a more intuitive way to specify the desired output range.

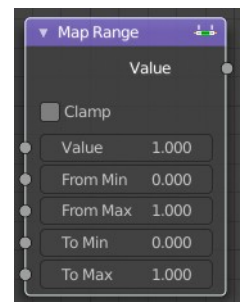

Usage

One important use case is to easily map the original range of the Z-depth channel to a more usable range (i.e: 0.0 - 1.0) for use as a matte for colorization or filtering operations.

Inputs

Value

Standard value input.

From Min/Max

Start/End of the input value range.

To Min/Max

Start/End of the destination range.

Properties

Clamp

Clamps values to Min/Max of the destination range.

Outputs

Value

Standard value output.

Map Value

Map Value node is used to scale, offset and clamp values.

Inputs

Value

Standard Value input. (Value refers to each vector in the set.)

Properties

Offset

Factor added to the input value.

Size

Scales (multiply) the input value.

Use Minimum, Maximum

Enable this to activate their related operation.

Min, Max

Defines a range between minimum and maximum to clamp the input value to.

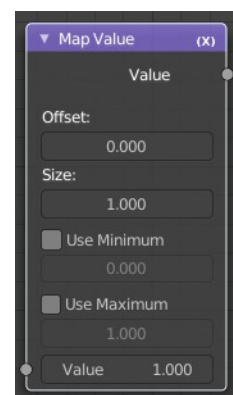

Outputs

Value

Standard value output.

Normal

The Normal node generates a normal vector and a dot product.

Inputs

Normal

Normal vector input.

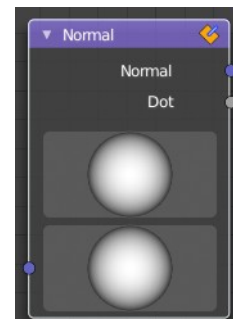

Properties

Normal Direction

To manually set a fixed normal direction vector. LMB click and drag on the sphere to set the direction of the normal. Holding Ctrl while dragging snaps to 45 degree rotation increments.

Outputs

Normal

Normal vector output.

Dot

Dot product output. The dot product is a scalar value.

If two normals are pointing in the same direction the dot product is 1.

If they are perpendicular the dot product is zero (0).

If they are anti parallel (facing directly away from each other) the dot product is -1.

Normalize

Find the minimum and maximum values of a single channel. Then map the values to a range of 0 and 1.

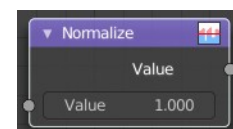

Inputs

Value

Standard value input.

Outputs

Value

Standard value output.

Vector Curves

The Vector Curves node maps an input vector components to a curve.

Inputs

In the shader context the node also has an additional Factor property.

Vector

Standard vector input.

Properties

Channel

Channel buttons

X, Y, Z. Clicking on one of the channels displays the curve for each.



Curve edit field

Create and tweak a Bezier curve that varies the input levels (X axis) to produce an output level (Y axis).

Selecting Points

You can select curve points. This reveals two edit boxes for the x and y coordinate of this point.

Selected points can be moved around. Left click at them, hold the mouse button down and move them to a new location.

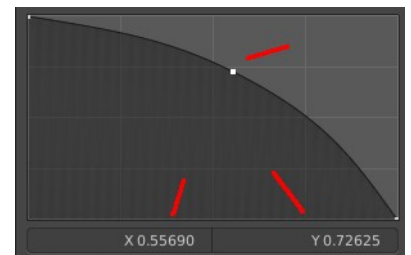

Adding Points

You can add new curve points by simply left clicking at the curve. Move the mouse to position them where you need it.

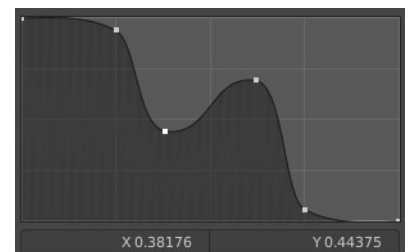

Navigation elements

The navigation elements at the top are described from left to right.

Zoom in and out

The two buttons with the magnifying glass at it zooms in and out in the curve window.



Tools

Tools is a menu where you can find some curve related tools.

Reset View

Resets the curve windows zoom.

Vector Handle

Set handle type to Vector.

Auto Handle

Set handle type to Auto.

Auto Clamped Handle

Set handle type to Auto Clamped.

Extend horizontal

Extends the curve before the first curve point and behind the last curve point horizontally.

Extend extrapolated

Extends the curve before the first curve point and behind the last curve point extrapolated.

Reset Curve

Resets the curve to the initial shape.

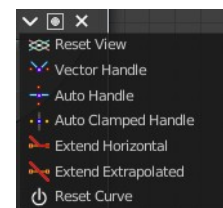

Use Clipping

Clipping options. Set up clipping for the stroke.

Delete Points

Deletes selected curve points.

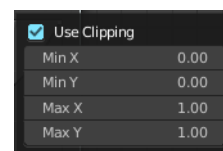

Outputs

Vector

Standard vector output.

10.1.12 Editors - Compositor Editor - Header - Add Menu - Matte

Table of content

Detailed table of content.....	1
Add menu - Matte.....	5
Box Mask.....	5
Channel Key.....	7
Chroma Key.....	8
Color Key.....	8
Color Spill.....	9
Cryptomatte.....	10
Cryptomatte (Legacy).....	12
Difference Key.....	13
Distance Key.....	14
Ellipse Mask.....	16
Keying.....	17
Keying Screen.....	20
Luminance Key.....	20

Detailed table of content

Detailed table of content

Detailed table of content.....	1
Add menu - Matte.....	5
Box Mask.....	5
Inputs.....	5
Mask.....	5
Value.....	5
Properties.....	6
X, Y.....	6
Width.....	6
Height.....	6
Rotation.....	6
Mask Type.....	6
Add.....	6
Subtract.....	6
Not.....	6
Outputs.....	6
Mask.....	6
Channel Key.....	7
Inputs.....	7
Image.....	7
Properties.....	7
Color Space.....	7
Key channel.....	7
Algorithm.....	7
Limit.....	7
High.....	7

Low.....	7
Outputs.....	7
Image.....	7
Matte.....	7
Chroma Key.....	8
Inputs.....	8
Image.....	8
Key Color.....	8
Properties.....	8
Acceptance.....	8
Cutoff.....	8
Falloff.....	8
Outputs.....	8
Image.....	8
Matte.....	8
Color Key.....	8
Inputs.....	9
Image.....	9
Properties.....	9
Color.....	9
Outputs.....	9
Image.....	9
Matte.....	9
Color Spill.....	9
Inputs.....	9
Image.....	9
Factor.....	9
Properties.....	10
Despill Channel.....	10
Algorithm.....	10
Limiting Channel.....	10
R, G, B.....	10
Ratio.....	10
Unspill.....	10
R, G, B.....	10
Outputs.....	10
Image.....	10
Cryptomatte.....	10
Usage.....	11
Inputs.....	11
Image.....	11
Properties.....	11
Render / Image.....	11
Render.....	11
Scene Property.....	11
Cryptomatte Layer.....	11
Image.....	11
Image Property.....	11
Cryptomatte Layer.....	11
Matte ID.....	11
Outputs.....	12
Image.....	12
Matte.....	12

Pick.....	12
Cryptomatte (Legacy).....	12
Usage.....	12
Adding/Removing Layers.....	12
Inputs.....	13
Image.....	13
Crypto Passes.....	13
Properties.....	13
Add/Remove.....	13
Matte ID.....	13
Outputs.....	13
Image.....	13
Matte.....	13
Pick.....	13
Difference Key.....	13
Inputs.....	13
Image.....	13
Image.....	13
Properties.....	14
Tolerance.....	14
Falloff.....	14
Outputs.....	14
Image.....	14
Matte.....	14
Distance Key.....	14
Inputs.....	14
Image.....	14
Key Color.....	14
Properties.....	14
Tolerance.....	14
Falloff.....	14
Color Space.....	15
Outputs.....	15
Image.....	15
Matte.....	15
Double Edge Mask.....	15
Inputs.....	15
Inner Mask.....	15
Outer Mask.....	15
Properties.....	15
Inner Edge.....	15
All.....	15
Adjacent Only.....	15
Buffer Edge.....	15
Keep In.....	15
Bleed Out.....	15
Outputs.....	16
Mask.....	16
Ellipse Mask.....	16
Inputs.....	16
Mask.....	16
Value.....	16
Properties.....	16

X, Y.....	16
Width.....	16
Height.....	16
Rotation.....	16
Mask Type.....	16
Add.....	16
Subtract.....	17
Multiply.....	17
Not.....	17
Outputs.....	17
Mask.....	17
Keying.....	17
Inputs.....	17
Image.....	17
Key Color.....	17
Garbage Matte.....	17
Core Matte.....	17
Properties.....	18
Pre Blur.....	18
Screen Balance.....	18
Despill Factor.....	18
Despill Balance.....	18
Edge Kernel Radius.....	18
Edge Kernel Tolerance.....	18
Clip Black.....	18
Clip White.....	18
Dilate/Erode.....	19
Feather Falloff.....	19
Feather Distance.....	19
Post Blur.....	19
Outputs.....	19
Image.....	19
Matte.....	19
Edges.....	19
Keying Screen.....	20
Properties.....	20
Movie Clip.....	20
Tracking Object.....	20
Outputs.....	20
Screen.....	20
Luminance Key.....	20
Inputs.....	21
Image.....	21
Properties.....	21
Limit.....	21
High.....	21
Low.....	21
Outputs.....	21
Image.....	21
Matte.....	21

Add menu - Matte

These nodes give you the essential tools for creating a Matte for images that do not already have their own Alpha Channel. One usage scenario is blue-screen or green-screen footage, where live action is shot in front of a blue or green backdrop for replacement by a matte painting or virtual background.

In general, hook up these nodes to a viewer, set your Image Editor to show the Viewer node, and play with the sliders in real-time using a sample image from the footage, to get the settings right. In some cases, small adjustments can eliminate artifacts or foreground image degradation. Taking out too much green can result in foreground actors looking flat or blueish/purplish.

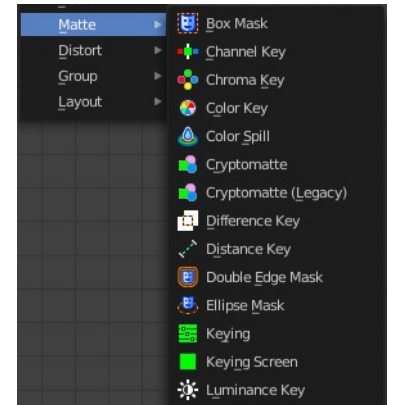

You can and should chain these nodes together, improving your masking and color correction in successive refinements, using each node's strengths to operate on the previous node's output. Keying Node is the closest to a "does-it-all" node for green screens, but the best results stem from a combination of techniques.

Note!

Garbage Matte is not a node, but a technique selecting what to exclude from an image. It is a Mask used to identify content to be removed from an image that cannot be removed by an automatic process like chroma keying. It is used either to select specific content to be removed, or it is the inverse of a rough selection of the subject; removing everything else.

Some nodes accept a garbage matte directly. For those that don't, you can still apply one by subtracting the garbage matte from the matte generated by the node.

Simple garbage mattes can be created with the Box Mask or the Ellipse Mask. More complicated matte shapes using a Double Edge Mask or using a Mask.

Box Mask

The Box Mask node creates an image suitable for use as a simple matte.

Inputs

Mask

An optional mask to use as the base for mask operations.

Value

Intensity of the generated mask.

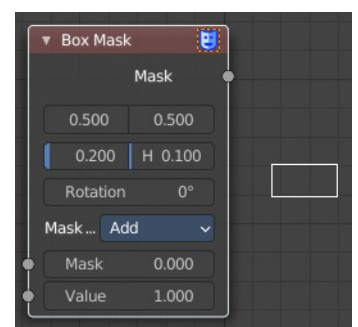

Properties

X, Y

Position of the center of the box as a fraction of the total width or height. (0.5, 0.5 creates a centered box; 0.0, 0.0 creates a box in the lower left.)

Width

Width of the box as a fraction of the total image width.

Height

Height of the box as a fraction of the total image width, not height.

Rotation

Rotation of the box around its center point.

Mask Type

Operation to use against the input mask.

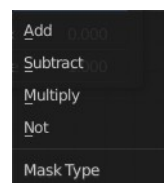

Add

This yields the union of the input mask and the generated mask: Areas covered by the generated mask are set to the specified Value. Other parts of the input masked are passed through unchanged, or set to black if there is no input mask.

Subtract

Values of the input mask have the specified Value subtracted from them.

Multiply

This yields the intersection of this generated mask and the input mask: Values of the input mask are multiplied by the specified Value for the area covered by the generated mask. All other areas become black.

Not

Any area covered by both the input mask and the generated mask becomes black. Areas covered by the generated mask that are black on the input mask become the specified Value. Areas uncovered by the generated mask remain unchanged.

Outputs

Mask

A generated rectangular mask merged with the input mask. The created mask is the size of the current scene render dimensions.

Tip. For soft edges, pass the output mask through a slight Blur node.

Channel Key

The Channel Key node determines background objects from foreground objects by the difference in the selected channel's levels.

For example in YUV color space, this is useful when compositing stock footage of explosions (very bright) which are normally shot against a solid, dark background.

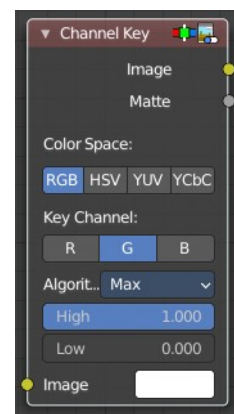

Inputs

Image

Standard image input.

Properties

Color Space

This button selects what color space the channels will represent.

RGB, HSV, YUV, YCbCr

Key channel

This button selects the channel, defined by the Color Space, to use to determine the matte.

Algorithm

Max or Single.

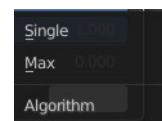

Limit

It is possible to have a separation between the two values to allow for a gradient of transparency between foreground and background objects.

High

Determines the lowest values that are considered foreground. (Which is supposed to be – relatively – height values: from this value to 1.0.)

Low

Determines the highest values that are considered to be background objects. (Which is supposed to be – relatively – low values: from 0.0 to this value.)

Outputs

Image

Image with an alpha channel adjusted for the keyed selection.

Matte

A black-and-white alpha mask of the key.

Chroma Key

The Chroma Key node determines if a pixel is a foreground or background (and thereby should be transparent) based on its chroma values.

Use this, for example, to composite images that have been shot in front of a green or blue screen.

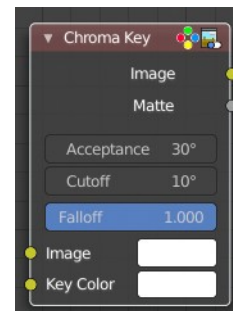

Inputs

Image

Standard image input.

Key Color

The background color usually selected using the color picker and the original image.

Properties

Acceptance

An angle on the color wheel that represents how tolerant the keying color is. Larger angles allow for larger variation in the keying color to be considered background pixels.

Cutoff

Controls the level that is considered the pure background. Higher cutoff levels mean more pixels will be 100% transparent if they are within the angle tolerance.

Falloff

Increase to make nearby pixels partially transparent producing a smoother blend along the edges.

Outputs

Image

Image with its alpha channel adjusted for the keyed selection.

Matte

A black-and-white alpha mask of the key.

Color Key

The Color Key node creates a matte based on a specified color of the input image.

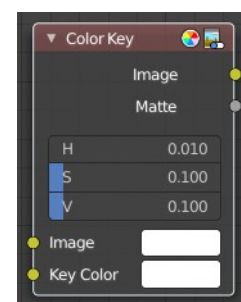

Inputs

Image

Standard image input.

Properties

Color

The sliders represent threshold values. Higher values in this node's context mean a wider range of colors from the specified will be added to the matte.

Hue, Saturation, Value

Outputs

Image

Image with its alpha channel adjusted for the keyed selection.

Matte

A black-and-white alpha mask of the key.

Color Spill

The Color Spill node reduces one of the RGB channels so that it is not greater than any of the others.

This is common when compositing images that were shot in front of a green or blue screen. In some cases, if the foreground object is reflective, it will show the green or blue color; that color has “spilled” onto the foreground object. If there is light from the side or back, and the foreground actor is wearing white, it is possible to get “spill” green (or blue) light from the background onto the foreground objects, coloring them with a tinge of green or blue. To remove the green (or blue) light, you use this fancy node.

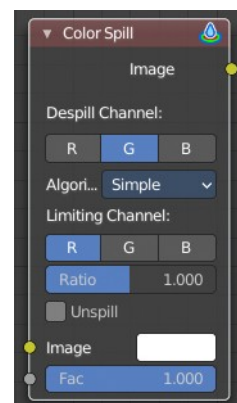

Inputs

Image

Standard image input.

Factor

Standard Factor.

Properties

Despill Channel

R, G, B

Algorithm

Simple or Average.

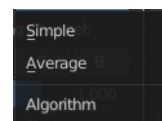

Limiting Channel

R, G, B

Ratio

Scale limit by value.

Unspill

Allows you to reduce the selected channel's input to the image greater than the color spill algorithm normally allows. This is useful for exceptionally high amounts of the color spill.

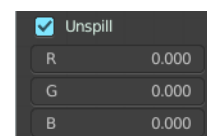

R, G, B

Outputs

Image

The image with the corrected channels.

Cryptomatte

The Cryptomatte node uses the Cryptomatte standard to efficiently create mattes for compositing. Cycles outputs the required render passes, which can then be used in the Compositor or another Compositor with Cryptomatte support to create masks for specified objects.

Unlike the Material and Object Index passes, the objects to isolate are selected in compositing, and mattes will be anti-aliased and take into account effects like motion blur and transparency.

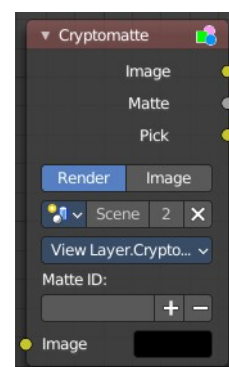

Usage

Enable Cryptomatte Object render pass in the Passes panel, and render.

In the compositing nodes, create a Cryptomatte node and link the Render Layer matching Image and Cryptomatte passes to it.

Attach a Viewer node to the Pick output of the Cryptomatte node.

Use the Cryptomatte Add/Remove button to sample objects in the Pick Viewer node.

Use the Matte output of the Cryptomatte node to get the alpha mask.

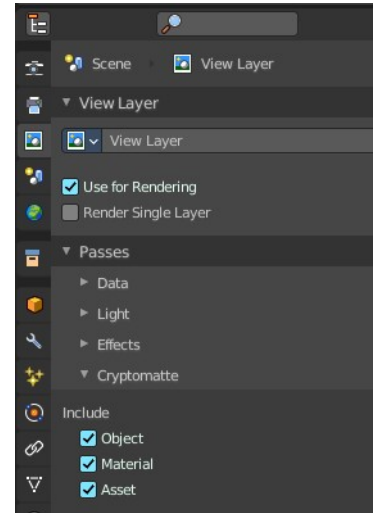

Inputs

Image

Standard image input.

Properties

Render / Image

Use the render result or an external image as the base image for cryptomatte.

Render

Use Cryptomatte data that are stored as part of the render.

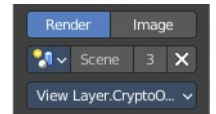

Scene Property

Pick the scene that you want to use.

Cryptomatte Layer

Pick the cryptomatte layer that you want to use.

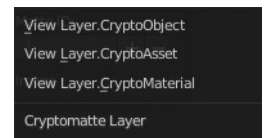

Image

Use Cryptomatte data that are stored inside a multilayered OpenEXR image.

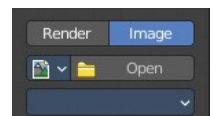

Image Property

Pick the image that you want to use.

Cryptomatte Layer

Pick the cryptomatte layer that you want to use.



Matte ID

List of object and material crypto IDs to include in matte. This can be used for example to quickly clear all mattes by deleting the text or used to copy-and-paste crypto IDs from other software.

Outputs

Image

A colored output of the input image with the matte applied to only include selected layers.

Matte

A black-and-white alpha mask of the all the selected crypto layers.

Pick

A colored representation of the Cryptomatte pass which can be used with a Viewer node to select which crypto passes are used to create the matte image.

Cryptomatte (Legacy)

This is the legacy node version.

The Cryptomatte node uses the Cryptomatte standard to efficiently create mattes for compositing. Cycles outputs the required render passes, which can then be used in the Compositor or another Compositor with Cryptomatte support to create masks for specified objects.

Unlike the Material and Object Index passes, the objects to isolate are selected in compositing, and mattes will be anti-aliased and take into account effects like motion blur and transparency.



Usage

Enable Cryptomatte Object render pass in the Passes panel, and render.

In the compositing nodes, create a Cryptomatte node and link the Render Layer matching Image and Cryptomatte passes to it.

Attach a Viewer node to the Pick output of the Cryptomatte node.

Use the Cryptomatte Add/Remove button to sample objects in the Pick Viewer node.

Use the Matte output of the Cryptomatte node to get the alpha mask.

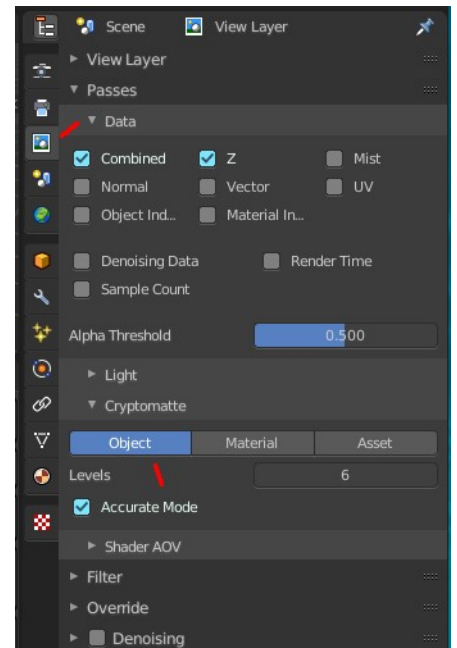

Adding/Removing Layers

By default there are only four crypto layers available as inputs to the Cryptomatte node. You can add or remove layer inputs through Sidebar > Item > Properties > Add/Remove Crypto Layer. These operators will add/remove layers from the bottom of the pass inputs.

Inputs

Image

Standard image input.

Crypto Passes

Each crypto layer will be given its own render pass; each of these render passes must be connected to one of these crypto layer inputs. By default there are only four layers, see [Adding/Removing Layers](#) to add more.

Properties

Add/Remove

Adds/Removes an object or material from matte, by picking a color from the Pick output.

Matte ID

List of object and material crypto IDs to include in matte. This can be used for example to quickly clear all mattes by deleting the text or used to copy-and-paste crypto IDs from other software.

Outputs

Image

A colored output of the input image with the matte applied to only include selected layers.

Matte

A black-and-white alpha mask of the all the selected crypto layers.

Pick

A colored representation of the Cryptomatte pass which can be used with a Viewer node to select which crypto passes are used to create the matte image.

Difference Key

This node produces a matte that isolates foreground content by comparing it with a reference background image.

Inputs

Image

Contains foreground content against the background that is to be removed.

Image

The reference background image.

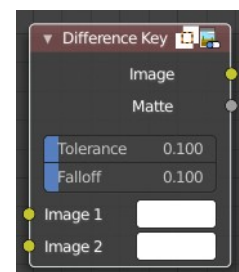

Properties

Tolerance

Where pixels match the reference background to within the specified threshold, the matte is made transparent.

Falloff

Increase to make nearby pixels partially transparent producing a smoother blend along the edges.

Outputs

Image

Image with its alpha channel adjusted for the keyed selection.

Matte

A black-and-white alpha mask of the key.

Distance Key

The Distance Key node determines a pixel's alpha value based on the three-dimensional distance between the image pixel color and the key color in a 3D color space.

This key works well when trying to single out a specific color in a background (not necessarily green).

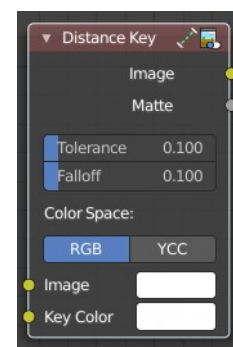

Inputs

Image

Standard image input.

Key Color

The color that is to be keyed.

Properties

Tolerance

A threshold what the node considers a match between the key color and the foreground pixel. The tolerance affects how close a pixel needs to be to the background pixel to be considered an absolute match.

Falloff

When the Falloff value is high, pixels that are close to the Key Color are more transparent than pixels that are not as close to the Key Color (but still considered close enough to be keyed). When the Falloff value is low, it does not matter how close the pixel color (Image) is to the Key Color, it is transparent.

Color Space

RGB, YCC

It is also possible to work with YCbCr color space, but only the Cb and Cr channels are taken into consideration for determining the distance between the foreground and background pixels.

Outputs

Image

The image with an alpha channel adjusted for the keyed selection.

Matte

A black-and-white alpha mask of the key.

Double Edge Mask

The Double Edge Mask node creates a gradient between two masks.

Inputs

Inner Mask

A mask representing the inside shape, which will be fully white.

Outer Mask

A mask representing the outside shape, which will fade from black at its edges to white at the Inner Mask.

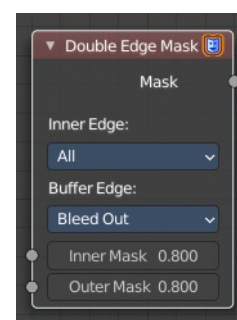

Properties

Inner Edge

All

All shapes in the Inner Mask contribute to the gradient, even ones that do not touch the Outer Mask shape.

Adjacent Only

Only shapes in the Inner Mask that overlap with the Outer Mask contribute to the gradient.

Buffer Edge

Keep In

Parts of the Outer Mask that touch the edge of the image are treated as if they stop at the edge.

Bleed Out

Parts of the Outer Mask that touch the edge of the image are extended beyond the boundary of the image.

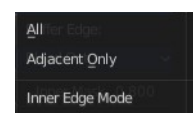

Outputs

Mask

Standard mask output.

Ellipse Mask

The Ellipse Mask node creates an image suitable for use as a simple matte or vignette mask.

Inputs

Mask

An optional mask to use as the base for mask operations.

Value

Intensity of the generated mask.

Properties

X, Y

Position of the center of the ellipse as a fraction of the total width or height. (0.5, 0.5 creates a centered ellipse; 0.0, 0.0 creates an ellipse with its center in the lower left.)

Width

Width of the ellipse as a fraction of the total image width.

Height

Height of the ellipse as a fraction of the total image width, not height. Equal Width and Height values with produce a circle.

Rotation

Rotation of the ellipse around its center point.

Mask Type

What operation to use against the input mask.

Add

This yields the union of the input mask and the generated mask: Areas covered by the generated mask are set to the specified Value. Other parts of the input masked are passed through unchanged, or set to black if there is no input mask.

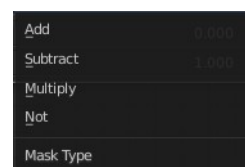
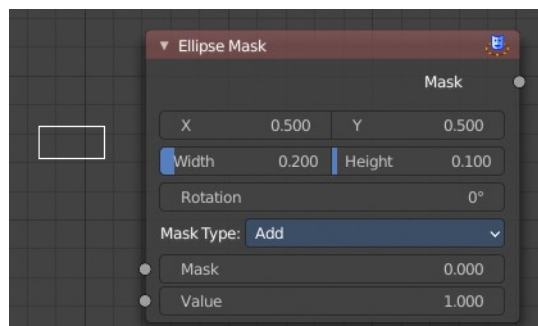

Subtract

Values of the input mask have the specified Value subtracted from them.

Multiply

This yields the intersection of this generated mask and the input mask: Values of the input mask are multiplied by the specified Value for the area covered by the generated mask. All other areas become black.

Not

Any area covered by both the input mask and the generated mask becomes black. Areas covered by the generated mask that are black on the input mask become the specified Value. Areas uncovered by the generated mask remain unchanged.

Outputs

Mask

A generated elliptical mask merged with the input mask. The created mask is the size of the current scene render dimensions.

Tip. For soft edges, pass the output mask through a slight Blur node. For a vignette, pass the output of this through a heavy blur.

Keying

The Keying node is a one-stop-shop for “green screen” / “blue screen” removal. It performs both chroma keying to remove the backdrop and despill to correct color cast from the backdrop. Additionally, you can perform common operations used to tweak the resulting matte.

Inputs

Image

Standard image input.

Key Color

The color of content to be removed. This may be a single color, or a reference image such as generated by the Keying Screen Node.

Garbage Matte

An optional mask of area(s) to always exclude from the output. This is removed from the chroma key generated matte.

Core Matte

An optional mask of area(s) to always include in the output. This is merged with the chroma key generated

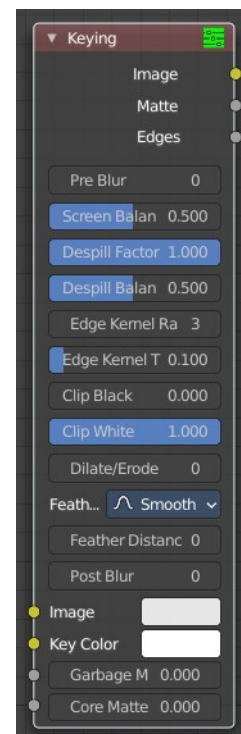

matte.

Properties

Pre Blur

Reduce the effects of color noise in the image by blurring only color by the given amount, leaving luminosity intact. This will affect matte calculation only, not the result image.

Screen Balance

This is the balance between color channels compared with the key color. 0.5 will average the other channels (red and blue in the case of a green screen).

This may be tweaked in tandem with Clip Black and Clip White while checking the Matte output to create a mask with optimal separation.

Despill Factor

Controls how much color bleed from the key color is removed from the input image: 0 means no despill, 1 means all possible spilling will be removed. The underlying implementation is the same as adjusting the Unspill amount of the Color Spill Node.

Despill Balance

This controls how the color channels are compared when computing spill, affecting the hue and shade of the corrected colors. It is similar to setting the Limiting Channel in the Color Spill Node.

Edge Kernel Radius

Defines the radius in pixel used to detect an edge.

Edge Kernel Tolerance

Defines threshold used to check if pixels in radius are the same as current pixel: if the difference between pixel colors is higher than this threshold then the point will be considered an edge.

Clip Black

This sets the threshold for what becomes fully transparent in the output (black in the matte). It should be set as low as possible. Uneven backdrops will require this value to be increased. Use of the Keying Screen Node can help keep this value low. You may also use a Garbage Matte to exclude problematic areas.

This value does not impact areas detected as edges to ensure edge detail is preserved.

Clip White

This sets the threshold for what becomes fully opaque in the output (white in the matte). It should be set as high as possible. Colors close to green in the foreground may require reducing this value and/or adjusting the Screen Balance. Particularly problematic parts can be fixed with a Core Matte instead of a low Clip White.

This value does not impact areas detected as edges to ensure edge detail is preserved.

Dilate/Erode

Enlarge (positive numbers) or shrink (negative numbers) the matte by the specified number of pixels. This is similar to using the Dilate/Erode Node on the matte.

This a simple way to include more or less along the edges of the matte, particularly combined with Post Blur.

Feather Falloff

The rate of the falloff at the edges of the matte when feathering, to manage edge detail.

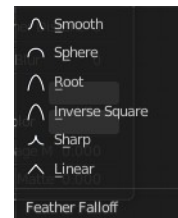

Feather Distance

Controls how much the matte is feathered inwards (negative number) or outwards (positive number).

Post Blur

Make the matte less sharp, for smoother transitions to the background and noise reduction.

Outputs

Image

Processed image with the Matte applied to the images' alpha channel.

Matte

Output matte to use for checking the quality of the key, or to manually apply using a Set Alpha Node or Mix Node.

Edges

Shows what edges were detected on the matte. Useful for adjusting the Edge Kernel Radius and Edge Kernel Tolerance.

Tip

If there are problems with the edges of the matte, it may help to start with adjusting the Edge Kernel parameters before adjusting feathering. Detected edges are not subject to Clip Black / Clip White thresholds to preserve fine edge detail. You can check edge detection by connecting a Viewer Node to the Edges output.

Sharper detected edges (smaller Edge Kernel Radius, like 2 / larger Edge Kernel Tolerance, like 0.4) will create a sharper matte, but may lose some detail like stray hairs. A sharp matte is good, but disappearing or flickering hairs are distracting.

Fat edges (larger Edge Kernel Radius, like 8 / smaller Edge Kernel Tolerance, like 0.05) will capture more edge detail, but may also produce a halo around the subject. The halo can be adjusted with Feather controls along with Dilate/Erode.

Keying Screen

The Keying Screen node creates plates for use as a color reference for keying nodes. It generates gradients from sampled colors on motion tracking points on movie clips. It can be used to deal with uneven colors of green screens.



Properties

Movie Clip

The selectable clip data-block used as input for the gradient colors.

The movie needs to be loaded already. You cannot load it from here, just choose.

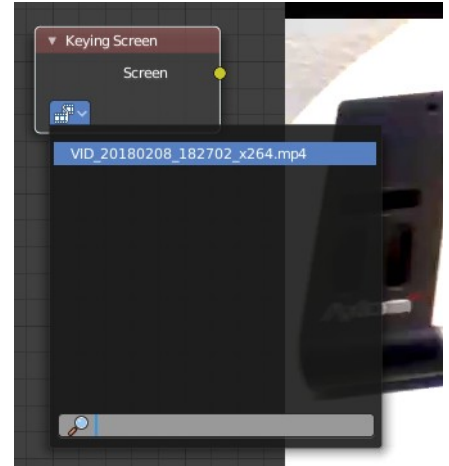

Tracking Object

Tracking Object to generate the gradient. You will probably want to create new a tracking object in the Object panel, because tracks used for gradients can not actually be used for camera/object tracking. After this tracks might be placed in places where gradient colors should be sampled. These tracks could be tracked or moved manually, so gradients would be updating automatically along the movie. Tracks might have an offset for easier tracking of feature-less screens.

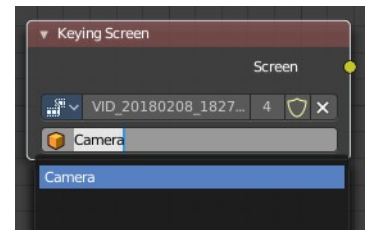

Outputs

Screen

Gradient image output.

Luminance Key

The Luminance Key node determines background objects from foreground objects by the difference in the luminance (brightness) levels.

Stock footage of explosions, smoke or debris are normally shot against a solid, dark background rather than a green screen. This node can separate the foreground effect from the background. It can also be used for sky replacement for overexposed or gray skies that aren't suitable for chroma keying.

Tip

When compositing footage of something that emits light and has a dark background, like fire, a Mix Node using a Screen or Add operator will produce better results.

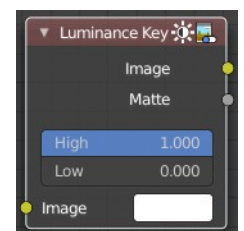

Inputs

Image

Standard image input.

Properties

Limit

High

Determines the lowest values that are considered foreground. (Which is supposed to be – relatively – light: from this value to 1.0.)

Low

Determines the highest values that are considered to be background objects. (Which is supposed to be – relatively – dark: from 0.0 to this value.)

Note. Brightness levels between the two values form a gradient of transparency between foreground and background objects.

Outputs

Image

Image with an alpha channel adjusted for the keyed selection.

Matte

A black-and-white alpha mask of the key.

10.1.13 Editors - Compositor Editor - Header - Add Menu - Distort

Table of content

Detailed table of content.....	1
Add menu - Distort.....	4
Corner Pin.....	4
Crop.....	4
Displace.....	5
Flip.....	6
Lens Distortion.....	6
Map UV.....	7
Movie Distortion.....	8
Plane Track Deform.....	9
Rotate.....	10
Scale.....	11
Stabilize 2D.....	12
Transform.....	12
Translate.....	13

Detailed table of content

Detailed table of content

Detailed table of content.....	1
Add menu - Distort.....	4
Corner Pin.....	4
Inputs.....	4
Image.....	4
Corners.....	4
Outputs.....	4
Image.....	4
Plane.....	4
Crop.....	4
Inputs.....	5
Image.....	5
Properties.....	5
Crop Image Size.....	5
Relative.....	5
Crop Region Values.....	5
Outputs.....	5
Image.....	5
Displace.....	5
Inputs.....	5
Image.....	5
Vector.....	5
Scale X, Y.....	5
Outputs.....	6
Image.....	6
Flip.....	6

Inputs.....	6
Image.....	6
Properties.....	6
Axis.....	6
Outputs.....	6
Image.....	6
Lens Distortion.....	6
Inputs.....	6
Image.....	6
Distort.....	6
Dispersion.....	6
Properties.....	7
Projector.....	7
Jitter.....	7
Fit.....	7
Outputs.....	7
Image.....	7
Map UV.....	7
Inputs.....	7
Image.....	7
UV.....	7
Properties.....	7
Alpha.....	7
Outputs.....	7
Image.....	7
Movie Distortion.....	8
Distortion vs Undistortion.....	8
Calculating Distortion.....	8
Inputs.....	8
Image.....	8
Properties.....	8
Movie Clip.....	8
Distortion Method.....	9
Undistort.....	9
Distort.....	9
Outputs.....	9
Image.....	9
Plane Track Deform.....	9
Properties.....	9
Movie Clip.....	9
Object.....	9
Track.....	9
Motion Blur.....	9
Samples.....	9
Shutter.....	10
Outputs.....	10
Image.....	10
Plane.....	10
Rotate.....	10
Inputs.....	10
Image.....	10
Degr.....	10
Properties.....	10

Filter.....	10
Nearest.....	10
Bilinear.....	10
Bicubic.....	10
Outputs.....	11
Image.....	11
Scale.....	11
Inputs.....	11
Image.....	11
X, Y.....	11
Properties.....	11
Space.....	11
Relative.....	11
Absolute.....	11
Scene Size.....	11
Render Size.....	11
Stretch, Fit, Crop.....	11
X, Y.....	11
Outputs.....	12
Image.....	12
Stabilize 2D.....	12
Inputs.....	12
Image.....	12
Properties.....	12
Movie Clip.....	12
Filter.....	12
Invert.....	12
Outputs.....	12
Image.....	12
Transform.....	12
Inputs.....	12
Image.....	12
X, Y.....	13
Angle.....	13
Scale.....	13
Properties.....	13
Filter.....	13
Nearest.....	13
Bilinear.....	13
Bicubic.....	13
Outputs.....	13
Image.....	13
Translate.....	13
Inputs.....	13
Image.....	13
X, Y.....	13
Properties.....	14
Relative.....	14
Wrapping.....	14
Outputs.....	14
Image.....	14

Add menu - Distort

These nodes distort the image in some fashion. They work either on the whole image, or by using a mask to vary the effect over the image.

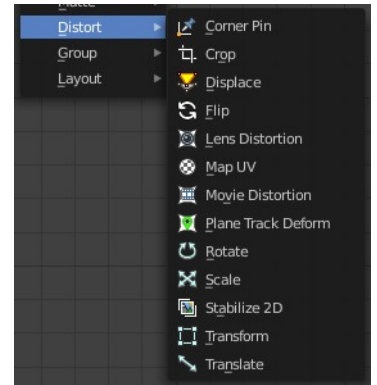

Corner Pin

The Corner Pin node uses explicit corner values for a plane warp transformation. It works like the Plane Track Deform node, but without using “plane track” data from the Movie Clip Editor.

Inputs

Image

Standard image input.

Corners

Four vector inputs to define the plane warping. (Z component of vector inputs is ignored.)

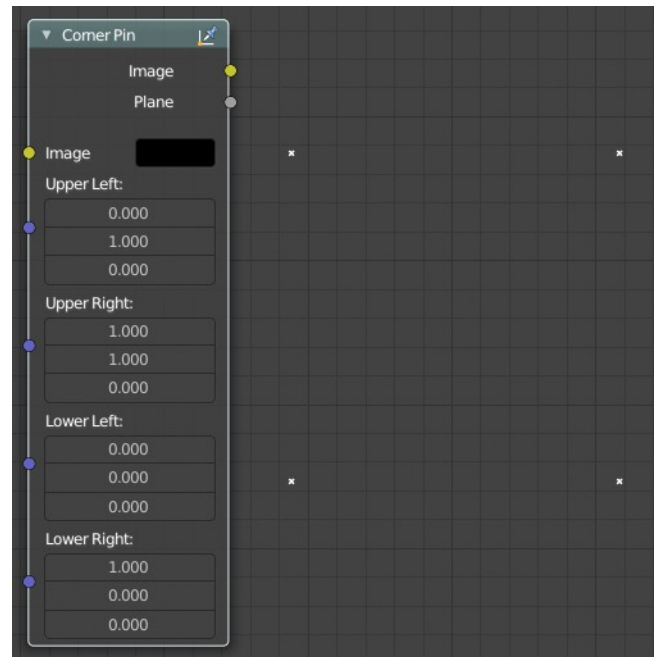

Outputs

Image

Standard image output. (The image after distorting.)

Plane

A black-and-white alpha mask of the plane.

Crop

The Crop Node takes an input image and crops it to a selected region.

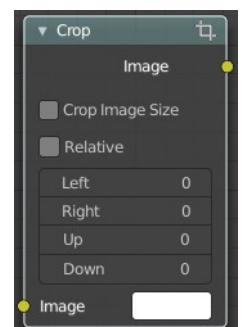

Inputs

Image

Standard image input.

Properties

Crop Image Size

When enabled, the image size is cropped to the specified region. When disabled, the image remains the same size, and uncropped areas become transparent pixels.

Relative

When enabled, crop dimensions are a percentage of the image's width and height. When disabled, the range of the Crop Region Values are the width and height of the image in pixels.

Crop Region Values

Define borders of the crop region. Lower, upper, left, right.

Outputs

Image

Standard image output.

Displace

The Displace Node displaces the pixel position based on an input vector.

This node could be used to model phenomena, like hot air distortion, refraction's of uneven glass or for surreal video effects.

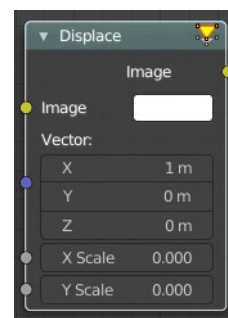

Inputs

Image

Standard image input.

Vector

Input of the displacement map. If the a color output is implicitly converted in the vector input, the first channel (red) value determines displacement along X axis. The second channel (green) the displacement along Y axis. If the input is a greyscale image, where both the channel values are equal, the input image will be displaced equally in both X and Y directions.

Scale X, Y

Separate scaling of the vector input in X and Y direction. Acting as multipliers by increasing or decreasing the strength of the displacement along their respective axes.

Outputs

Image

Standard image output.

Flip

This node flips an image at defined axis.

You can use this node to just flip or use it as a part of mirror setting. Mix half of the image to be mirrored with its flipped version to produce mirrored image.

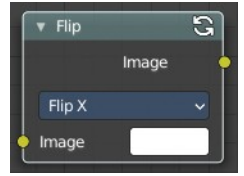

Inputs

Image

Standard image input.

Properties

Axis

This can be either X or Y. Also, flipping can be done on both X and Y axis simultaneously.

Flip X, Flip Y, Flip X & Y

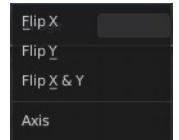

Outputs

Image

Standard image output.

Lens Distortion

Use this node to simulate distortions that real camera lenses produce.

Inputs

Image

Standard image input.

Distortion

This creates a bulging or pinching effect from the center of the image.

Dispersion

This simulates chromatic aberrations, where different wavelengths of light refract slightly differently, creating a rainbow colored fringe.

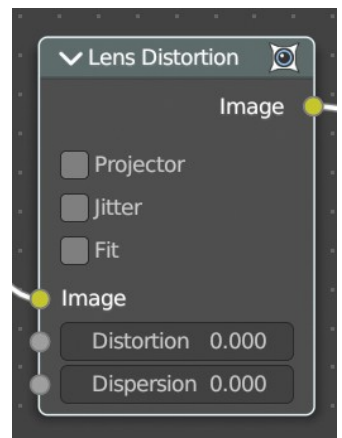

Properties

Projector

Enable or disable slider projection mode. When on, distortion is only applied horizontally. Disables Jitter and Fit.

Jitter

Adds jitter to the distortion. Faster, but noisier.

Fit

Scales image so black areas are not visible. Only works for positive distortion.

Outputs

Image

Standard image output.

Map UV

With the Map UV node objects can be “re-textured” after they have been rendered.

To apply a texture to individual enumerated objects the ID Mask Node could be used.

Inputs

Image

The new 2D texture.

UV

The input for UV render pass. See Cycles render passes.

Hint. To store the UV pass a multi-layer OpenEXR format could be used.

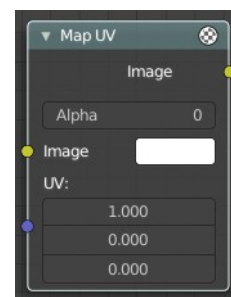

Properties

Alpha

Alpha threshold is used to fade out pixels on boundaries.

Outputs

Image

The resulting image is the input image texture distorted to match the UV coordinates. That image can then be overlay mixed with the original image to paint the texture on top of the original. Adjust alpha and the mix factor to control how much the new texture overlays the old.

Hint. When painting the new texture, it helps to have the UV maps for the original objects in the scene, it is recommended to keep those UV texture outlines around even, when shooting is done.

Movie Distortion

In the real world, all camera lenses produce some or the other sort of lens distortion. But, whatever we render has got no distortion. So, this node helps in removing distortion from movies or adding distortion to render to make our render blend in with the movie clip.

Usually, it is used while motion tracking.

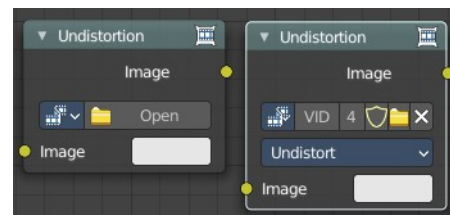

Distortion vs Undistortion

Although, both, distortion of render and undistortion of movie clip are possible, and produce similar results, there is a difference between these two methods.

There are two kinds of lens distortion possible and, in simple terms, they can be said as:

When the movie clip is bulging out.

When the movie clip is bulging in.

For the first case, it is recommended to distort the render and leave the movie clip as it is, because, undistorting the movie clip will require extra pixel information, which is not available to Blender. Similarly, in the second case, it is recommended to undistort the movie clip and leave the render as it is, because, distorting the render will require those extra unavailable pixels. Doing the wrong method in the wrong case can create weird results around the edges, such as in the image shown.

Calculating Distortion

Before using this node, one has to calculate the lens distortion of the clip. This can be done by adjusting K1, K2 and K3 values in Movie Clip Editor > Properties ? Lens. For more information on how to edit those values, check this out.

Inputs

Image

Standard image input.

Properties

Movie Clip

Used to select the movie clip whose distortion is to be used. This can be useful if more than one movie clips are present, each having a different distortion setting. For controls see Data-Block Menu.

Distortion Method

Undistort

Used to undistort the image received, and is usually used for the raw distorted movie clip.

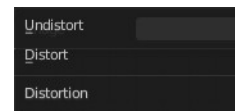

Distort

Used to distort the image received, and is usually used for rendered images.

Outputs

Image

Standard image output.

Plane Track Deform

The Plane Track Deform Node is used to incorporate the special “plane track” in your composite by checking areas which are planes, and replacing their footage with some other image.

Plane Track

Before using this node, plane track for the footage should be made in the Movie Clip Editor.

Inputs

Image

Image to put in place of the plane track, and thus, override that area in the movie clip.

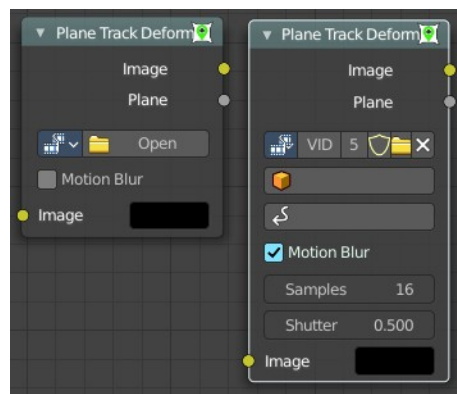

Properties

Movie Clip

Used to select the movie clip whose plane track to use. For controls see Data-Block Menu.

Object

Used to select the object to which the plane track is linked.

Track

Used to select the plane track to use.

Motion Blur

Specify whether to use blur caused by motion of the plane track or not.

Samples

Motion Blur setting. Set the number of samples to take for each frame. The higher this number, the smoother the blur effect, but the longer the render, as each virtual intermediate frame has to be rendered.

Note. Samples are taken only from the next frame, not the previous one. Therefore the blurred object will appear to be slightly ahead of how it would look without motion blur.

Shutter

Motion Blur setting. Time (in frames) the shutter is open. If you are rendering at 24 fps, and the Shutter is set to 0.5, the time in between frames is 41.67 ms, so the shutter is open for half that, 20.83 ms.

Outputs

Image

The output by perspective wrapping the image to that plane track.

Plane

Produces a black-and-white mask of the plane track.

Rotate

This node rotates an image.

Inputs

Image

Standard image input.

Degr

Rotation angle in degree. Positive values rotate clockwise and negative ones counterclockwise.

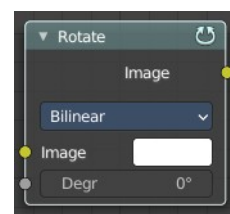

Properties

Filter

Interpolation Methods.

Nearest

No interpolation. This method uses the nearest neighboring pixel.

Bilinear

Simple interpolation between adjacent pixels.

Bicubic

Highest quality interpolation.

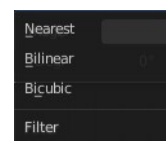

Outputs

Image

Standard image output.

Scale

The Scale node scales the size of an image.

Inputs

Image

Standard image input.

X, Y

Scale in the axis directions, only available if Space is set to Relative or Absolute.

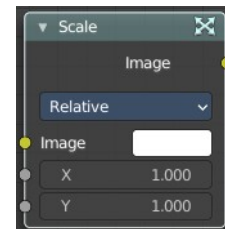

Properties

Space

Coordinate Space to scale relative to.

Relative

Percentage values relative to the dimensions of the image input.

Absolute

Size of an image by using absolute pixel values.

Scene Size

Sizes an image to the size of the final render resolution for the scene. For example, rendering a scene at the standard 1080p resolution but setting the render percentage at 50%, will produce a 1080p image with the scene scaled down 50% and leaving the rest of the image as alpha.

Render Size

Image dimensions set in the Render panel.

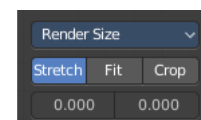

Stretch, Fit, Crop

Render Size setting. Stretch distorts the image so that it fits into the render size. Fit scales the image until the bigger axis “fits” into the render size. Crop cuts the image so that it is the same aspect ratio as the render size.

X, Y

Render Size setting. Offset factor for the final scaled image.

Outputs

Image

Standard image output.

Stabilize 2D

The Stabilize 2D node stabilizes the footage according to the settings set in Movie Clip Editor in the Sidebar in the Stabilization tab in the 2D Stabilization panel. For more information, see the chapter there.

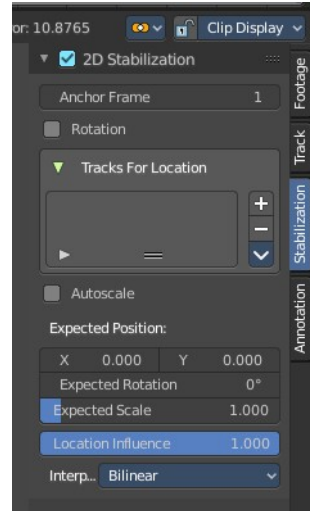

Inputs

Image

Standard image input.

Properties

Movie Clip

The movie clip whose stabilization to use.

Filter

Filter methods for the stabilization.

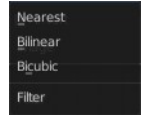

Invert

Invert the stabilization. If the stabilization calculated is to move the movie clip up by 5 units, this will move the movie clip down by 5 units.

Outputs

Image

Standard image input.

Transform

The Transform node combines the functionality of three other nodes: Scale, translate, and rotate nodes.

Inputs

Image

Standard image input.

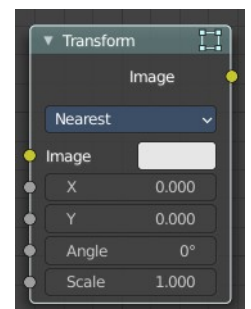

X, Y

Used to move the input image horizontally and vertically.

Angle

Used to rotate an image around its center. Positive values rotate counter-clockwise and negative ones clockwise.

Scale

Used to resize the image. The scaling is relative, meaning a value of 0.5 gives half the size and a value of 2.0 gives twice the size of the original image.

Properties

Filter

Interpolation Methods.

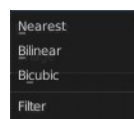

Nearest

No interpolation, uses nearest neighboring pixel.

Bilinear

Simple interpolation between adjacent pixels.

Bicubic

Highest quality interpolation.

Outputs

Image

Standard image output.

Translate

The Translate node moves an image.

Could also be used to add a 2D camera shake.

Inputs

Image

Standard image input.

X, Y

Used to move the input image horizontally and vertically.

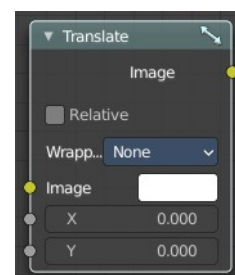

Properties

Relative

Percentage translation values relative to the input image size.

Wrapping

Repeat pixels on the other side when they extend over the image dimensions.

None, X Axis, Y Axis, Both Axis

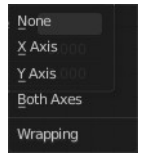

Outputs

Image

Standard image output.



10.1.14 Editors - Compositor Editor - Header - Add Menu - Group

Table of content

- Add menu - Group.....1
- Make Group.....1
- Insert into Group.....2
- Ungroup.....2
- Toggle Edit Group.....3
- Group Input.....3
- Group Output.....3
- List of Node Groups.....3

Add menu - Group

Node groups allows you to group different nodes of the material together to reduce the visual complexity. A node group acts like any other node.

Material node groups should not include Input nodes, like Image nodes, or Output nodes.

If you include a source node in your group, you will end up having the source node appearing twice: once inside the group, and once outside the group in the new material node tree.

If you include an output node in the group, there will not be an output socket available from the group!

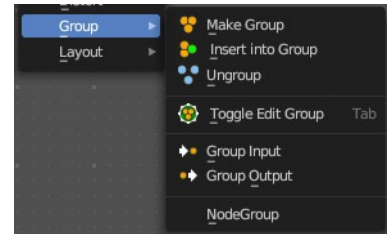

Make Group

Groups the selected nodes together.

Select the nodes that you want to group together. Choose Make Group. You will now see a green background. This indicates that the group is created, and that you are in edit mode for the group now.

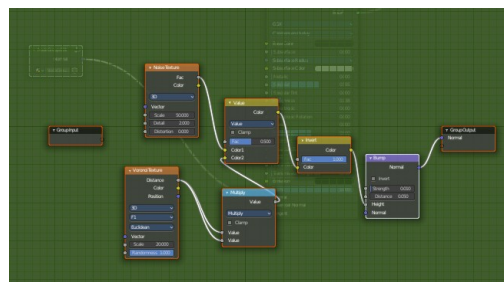
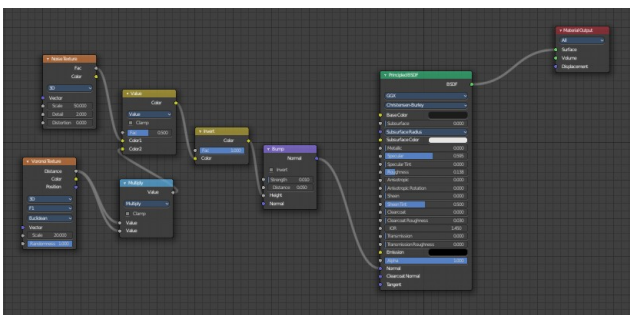

To exit the group edit mode press Tab key, or choose Toggle Edit Group menu item in the sidebar in the Relations tab in the Group panel. That way you can also enter the Group Edit mode again.

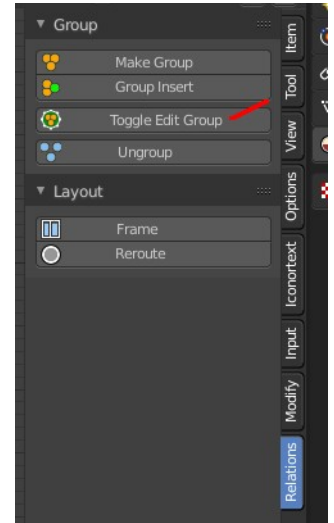
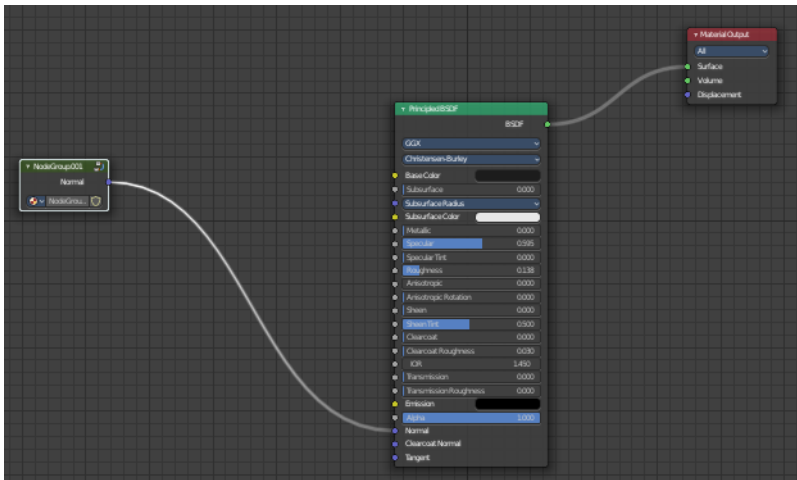

There is a third way to enter the group edit mode. Click at the right upper icon of the group node.

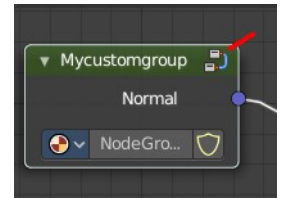

A group can be further collapsed by clicking at the triangle button in the upper left corner.

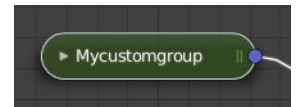

The group can be renamed in the sidebar in the Item tab and in the Properties tab in the Node panel.

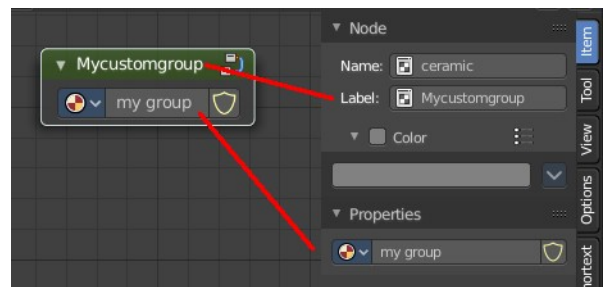

Insert into Group

Allows you to insert a node into a node group.

Select the node, hold down Shift, then select the node group so that both are selected. Then perform the operator.

Ungroup

Ungroups an existing group. You need to be outside of the group edit mode.

Toggle Edit Group

Enters a node group for editing. Or when you are in a node group, exits the node group editing.

Group Input

Adds a Group Input node. This node is usually already part of a new created group.

Group Output

Adds a Group Output node. This node is usually already part of a new created group.

List of Node Groups

Once you have created a node group it will also show up in the group menu. Groups can be inserted to other materials too.

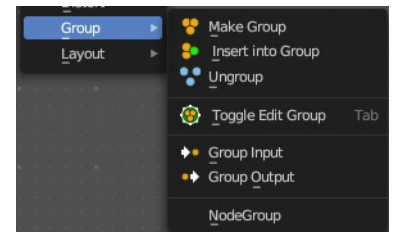

10.1.15 Editors - Compositor Editor - Header - Add Menu - Layout

Table of content

- Add menu - Layout.....1
- Frame.....1
 - Adding and Removing Nodes.....1
 - Resizing Frame.....2
 - Label and Color.....2
- Reroute.....2
 - Move, Rotate, Scale.....2
- Switch.....2

Add menu - Layout

These nodes helps organizing the node layout.



Frame

The Frame node allows you to drop nodes into a frame. This frame can be dragged around as a whole.

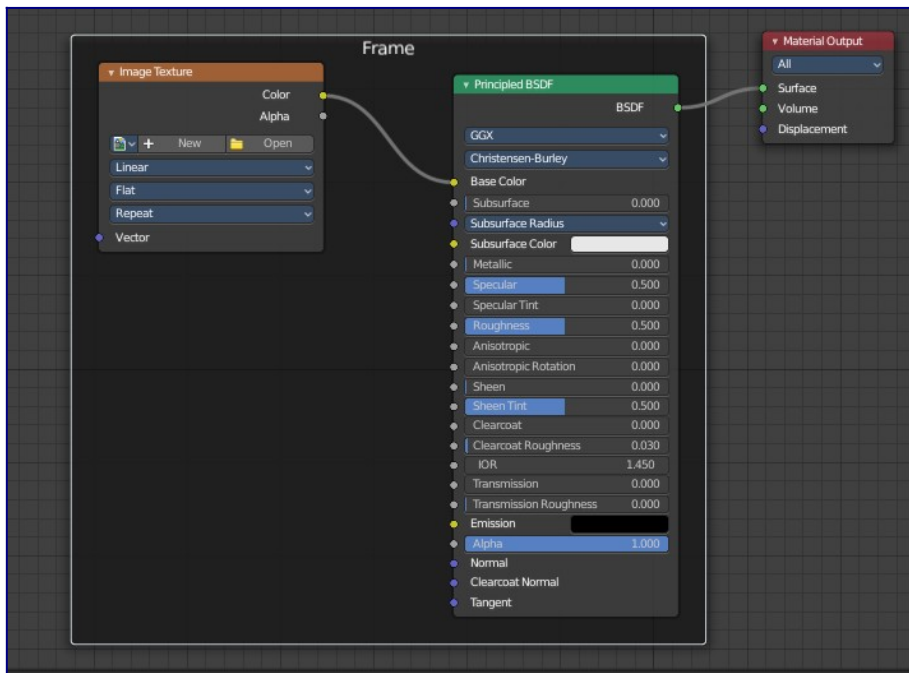
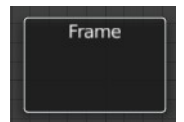

Adding and Removing Nodes

Nodes can be added by simply dropping them onto the frame. Or with the Join in New Frame menu item in the Node menu.

To remove a node from the frame use Remove from Frame.

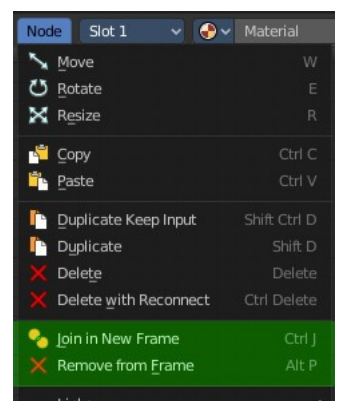

Resizing Frame

When the Frame node is first placed in the node editor workspace you can resize it by dragging one of the edges.

Once a node is placed in the Frame, the Frame shrinks around the nodes. You cannot resize it anymore with handlers. Just by dragging around the nodes inside of the frame.

This behavior can be changed by disabling the *Shrink* option in the Item tab in the Properties panel. Then you can resize the frame again by dragging the edges.

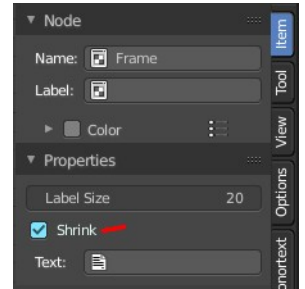

Label and Color

You can change the name of a frame in the Node panel. And you can give it a custom color by checking the Color checkbox and adjusting the color then.

Reroute

Adds a reroute point that can be used to reroute connections. It allows just one input, but allows multiple output connections.

To quickly add a Reroute node into an existing connection, hold Shift and Right Mouse and drag the mouse to cut through the link. A new reroute node will be added.

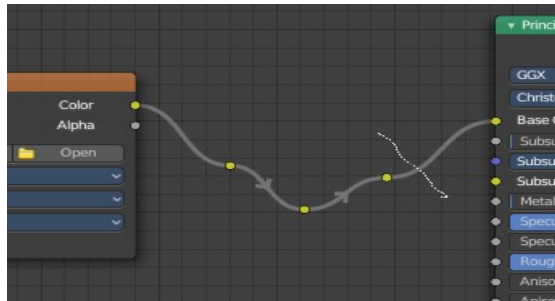
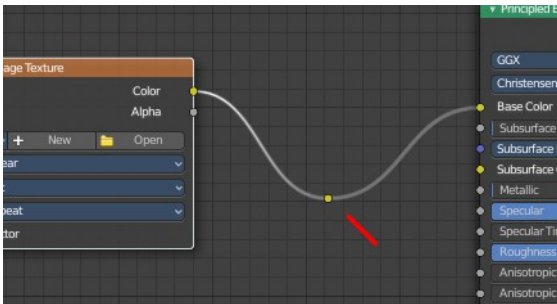

When you exceed a specific angle amount between the reroute nodes, then the node connection becomes a sharp corner, and not longer a Bezier like soft curve.

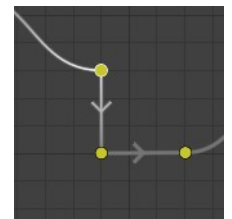

Move, Rotate, Scale

A normal node has a handler. The reroute dot not. You can't simply move it around with the mouse by clicking at the top area. It has none. You have to use the move, rotate and scale commands. They can be found in the View menu.

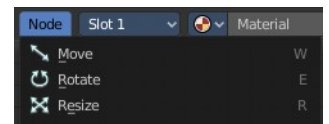

Switch

Allows you to switch between two images.

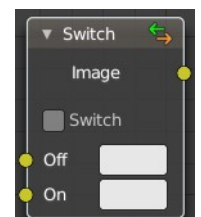



13.1.16 Editors - Compositor Editor - Header - Node menu

Table of content

Node menu.....	2
Move.....	2
Rotate.....	2
Resize.....	2
Copy.....	2
Paste.....	2
Duplicate Keep Input.....	2
Duplicate.....	2
Duplicate Linked.....	2
Delete.....	2
Delete with Reconnect.....	3
Join new Frame.....	3
Remove from Frame.....	3
Frame Make Parent.....	3
Links.....	3
Make Links.....	3
Make and Replace Links.....	3
Detach Links.....	3
Detach Links Move.....	3
Mute Links.....	3
Separate.....	3
Copy.....	4
Move.....	4
Hide / Toggle.....	4
Hide.....	4
Toggle Node Mute.....	4
Toggle Node Preview.....	4
Toggle hidden node sockets.....	4
Toggle Node Options.....	4
Collapse and Hide Unused Sockets.....	5

Node menu

This menu contains further node functionality.

Move

Moves the selected nodes.

Rotate

You can't rotate single nodes, obviously. But when you have more than one selected then you can rotate them around their center point.

Resize

You can't resize single nodes, obviously. But when you have more than one selected then you can scale them around their center point.

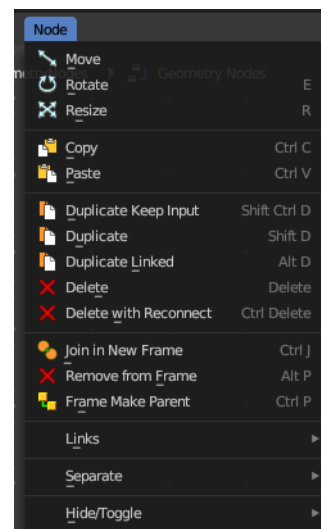

Copy

Copies the selected node(s).

Paste

Pastes the selected node(s).

Duplicate Keep Input

This works at nodes that have a connected input. Duplicating will keep the input connections established in the duplicated node. The output connections will be removed.

Duplicate

Duplicates the selected node(s). All connections will be removed in the duplicated node.

Duplicate Linked

Duplicates the selected node(s), but not their node trees.

Delete

Deletes the selected node(s).

Delete with Reconnect

Deletes the selected node(s). When this node is in the middle of a connection, then the connections will be reconnected.

Join new Frame

Frame node functionality. Adds the selected node to a frame.

Remove from Frame

Frame node functionality. Removes the selected node from a frame.

Frame Make Parent

Frame node functionality. Adds the selected node to a frame.

Links

Make Links

Tries to connect nodes where it makes sense. For example, the BSDF output of a Principled shader with the Surface input of the Material Output node.

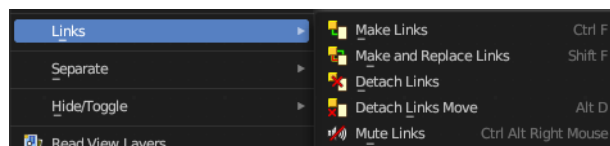

Make and Replace Links

Same as Make Links. But it will replace existing links.

Detach Links

Removes all connections from the selected node, but tries to reconnect the remaining nodes.

Detach Links Move

Removes all connections from the selected node by dragging.

Mute Links

Mute links with the mouse.

Separate

Node group functionality. You need to be in edit group mode.



Copy

Copies the selected node, and pastes a copy of it outside of the node group. The node group remains unchanged.

Move

Moves the selected to outside of the node group, and removes it from the node group.

Show/Hide

Here you find hide options to make the display of nodes more compact.

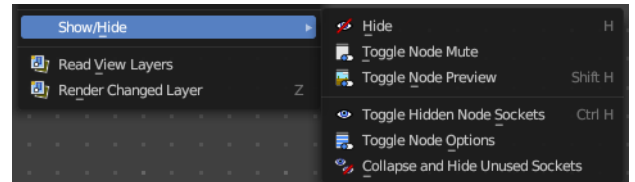

Demonstration happens at an image node.



Hide

Hides everything but input and output dots. To view the full node again perform the operator again. It's a toggle. Or click at the triangle left besides the node name.



Toggle Node Mute

Deactivates the node.

Toggle Node Preview

This is a compositor feature for the preview image. It does not belong here, but shares the same menu. It shows or hides the preview image.

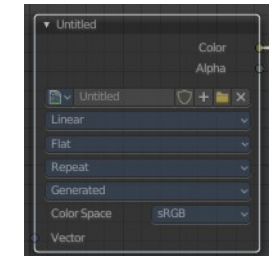

Toggle hidden node sockets

Toggles away the unused node sockets. In this case the vector input node socket and the alpha output node socket will be hidden.

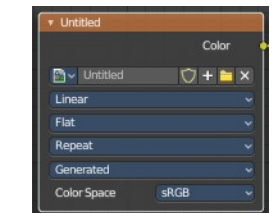

Toggle Node Options

Hides away the properties.

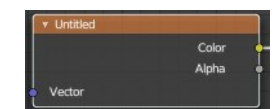

Collapse and Hide Unused Sockets

Like Hide. Hides everything but the node sockets. But it also hides the unused node sockets.

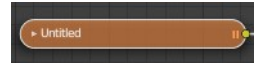



10.1.2 Editors - Compositor - Header - Quick Menu

Table of content

- Quick Menu.....1
- Adding an operator to the Quick menu.....1
- Adding a menu to the Quick menu.....1
- Order.....2
- Removing an operator from the Quick menu.....2
- Context and mode dependent content.....2

Quick Menu

The quick menu, or in long Quick Favorites menu, is a menu that can be customized to your needs. Here you can add operators for quick access.

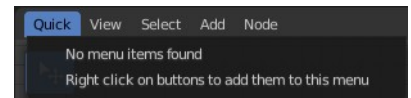

It is located in the header. But it can be called by hotkey Q directly under the mouse. This hotkey works in other editors too.

When the menu is empty, then you will see the message "No Menu Items found". This means that you first have to add some tools to the menu. It is a user configurable menu.

Note that added operators in this menu does not have icons. Just text.

Adding an operator to the Quick menu

Open the panel or the menu where your operator is that you want to add.

Let's add the open command from the File menu. Open the File menu, right click at open, and choose Add to Quick Favorites.

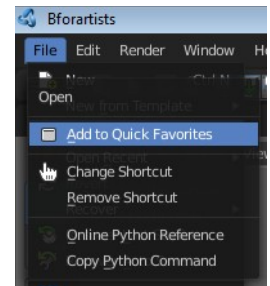

Do the same with Save As. We should now have two new menu items in the Quick menu, which you can use now.

As a rule of thumb, when the right click menu has an Add to Quick Favorites, then you can add it to the quick menu.

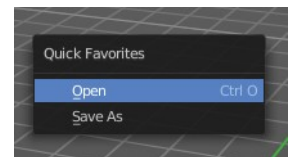

Note that you can also add operators from the tool shelf at the left. And also operators from other editor types. Some other editors have their own quick menu though. The Image Editor for example. These operators gets added in the quick menu of the image editor then. And does not show in the quick menu in the header of the 3D view.

Adding a menu to the Quick menu

It is also possible to add a menu to the Quick menu. For example the whole Add menu. The way is the same. Right click at it, and choose Add to Quick Favorites.

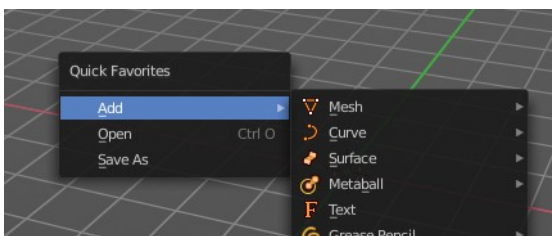
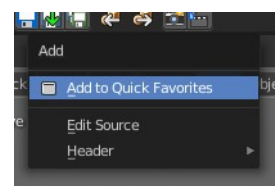

Order

You might notice that the add menu adds at the top of the menu, and not at the bottom as you would expect. First comes menus, then comes operators. And they get added in the order in which you add them.

Besides that, operators and menus gets added in the order that you add them. They cannot be sorted afterwards. So be careful how you add them. You can of course always remove operators and menus, and re-add them at the end of the list.

Removing an operator from the Quick menu

Removing is as simple as adding. Right click at the operators in the Quick menu, and choose Remove from Quick favorites.

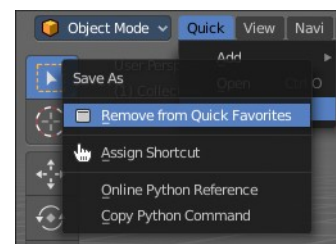

Context and mode dependent content

The quick favorites. menu exists in nearly all editors. But it is just in the 3D view available in the header. So that you know this functionality exists. In the other editors you call it with hotkey Q.

The content of the quick favorites. menu changes, dependent over which editor you are, and in what mode you are. When you add for example an operator from the image editor, then this operator just shows in the quick menu when you call the menu from the image editor. Same goes for the modes. Edit mode tools will just show in edit mode. And so on.



10.1.3 Editors - Compositor Editor - Header - View Menu

Table of content

View Menu.....	1
Toolbar.....	1
Sidebar.....	2
Annotations (Legacy).....	2
Draw Annotation.....	2
Draw Line Annotation.....	2
Draw Polyline Annotation.....	2
Erase Annotation.....	2
Add Annotation Layer.....	2
Erase Annotation Active Keyframe.....	2
Zoom In.....	2
Zoom Out.....	2
Zoom Border.....	3
View Selected.....	3
View All.....	3
Pie menus.....	3
Area.....	3
Horizontal Split.....	3
Vertical Split.....	3
Duplicate Area into New Window.....	3
Toggle Maximize Area.....	3
Toggle Full screen Area.....	4
Close Area.....	4
View Menu with Backdrop.....	4
Set Viewer Region.....	4
Clear Viewer Region.....	4

View Menu

The View menu contains all View related tools.

The content is the same in all sub modes.

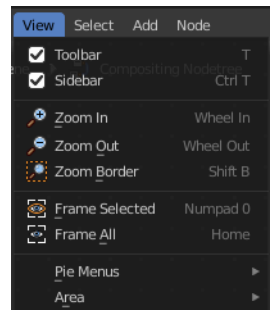

Toolbar

Shows or hides the toolbar at the left.



Sidebar

Shows or hides the sidebar at the right in the viewport.

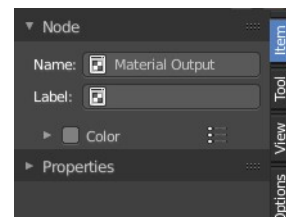

Annotations (Legacy)

This group of operators is useful to take notes without changing tool-shelf operators. These notes can be colored in the View tab of the Property Shelf. Each layer is a single color. You can also animate the notes with keyframes, editable in the dopesheet.

Note: *These are legacy operators, meaning they are equally available in the Toolshelf as a modal operator.*

Draw Annotation

Starts the annotation free hand draw tool in the editor.

Draw Line Annotation

Starts the annotation line draw tool to draw straight lines in the editor.

Draw Polyline Annotation

Starts the annotation Polyline draw tool in the editor which allows to draw multiple connected straight lines in the editor.

Erase Annotation

Starts the annotation erase tool in the editor which erases any strokes in the editor.

Add Annotation Layer

Starts a new annotation layer.

Erase Annotation Active Keyframe

Erases the active keyframe of the annotation.

Zoom In

Zooms into the viewport.

Zoom Out

Zooms out of the viewport.

Zoom Border

Draws a rectangle and zooms then to fit the size of this rectangle.

Zooming in is done with drawing the rectangle with left mouse button. Zooming out is done with drawing the rectangle with middle mouse button.

View Selected

Zooms to the selection.

View All

View all zooms in or out in the viewport until all objects in the scene are displayed fitting in the viewport.

Pie menus

Lists the available pie menus, and gives you the ability to read the hotkeys and assign own hotkeys.



Area

This menu contains general view functionality. And exists in most other editor types too.

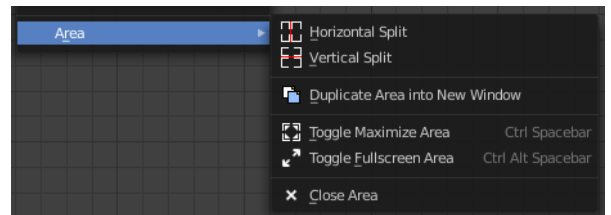

Horizontal Split

Splits the current view horizontally into two independent editor windows.

Vertical Split

Splits the current view vertically into two independent editor windows.

Duplicate Area into New Window

Duplicate Area into New Window makes the selected editor window floating. You can then drag it around at the monitor. It is not connected with the rest of the UI anymore.

A separated window cannot be merged into the main window again. You have to close it when not longer needed.

Toggle Maximize Area

Displays the editor maximized with menus.

To return from the maximized view press hotkey ctrl + spacebar. Or reuse the menu item in the area menu.

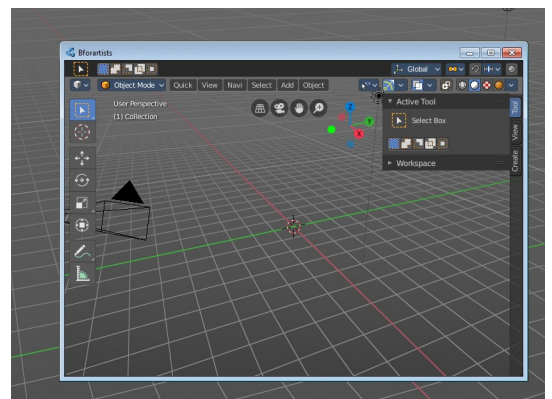

Toggle Full screen Area

Displays the editor maximized without menus.

To return from the full screen view press hotkey ctrl + alt + spacebar.

Close Area

Closes the editor.

View Menu with Backdrop

When you activate the Backdrop in the header, then the View menu reveals some more functionality.

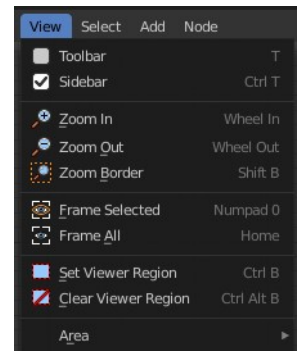

Set Viewer Region

Allows you to define an area of the Backdrop. Then just this area gets processed.

Clear Viewer Region

Removes the Viewer Region.

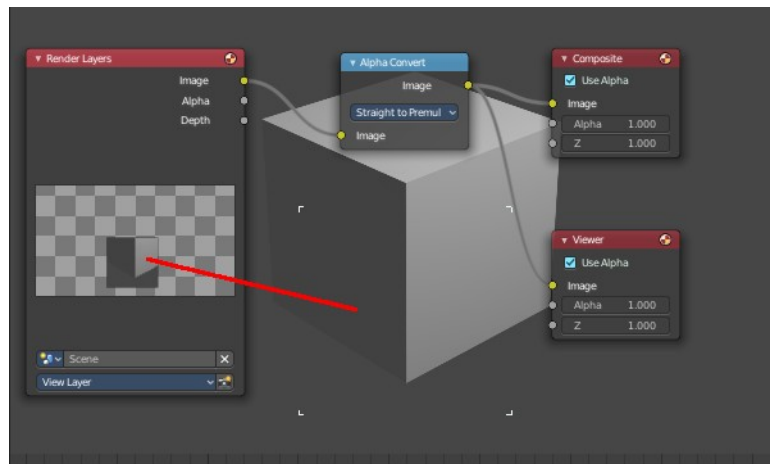



10.1.4 Editors - Compositor Editor - Header - Select Menu

Table of content

Select menu.....	1
Legacy.....	1
Box select.....	1
Circle select.....	1
All.....	2
None.....	2
Inverse.....	2
Linked From.....	2
Linked To.....	2
Grouped.....	2
Grouped Extend.....	2
Activate same type previous.....	2
Activate same type next.....	2
Find Node.....	2

Select menu

Here you will find the select functionality.

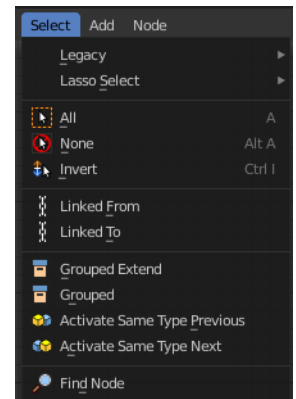

Legacy

The legacy sub menu contains tools that exists in the tool shelf already. It's the old way to do things. Different to the tools in the tool shelf, these tools are usually modal. And performs once. You have to call them again in case you want to repeat the tool.



Box select

Draw a rectangle to select everything inside of the rectangle.

It automatically adds to the current selection. Holding down shift subtracts from the selection.

Circle select

Brush select content. The radius of the brush can be adjusted by holding down left mouse button and using the scroll wheel or the + or - button at the numpad.

It automatically adds to the current selection. Holding down shift subtracts from the selection. To exit the circle select tool click with the right mouse button.

Lasso Select

A sub menu with the available lasso select modes.

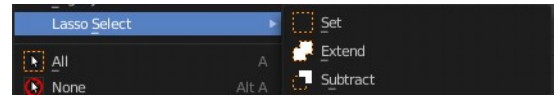

All

Select everything.

None

Select nothing.

Inverse

Invert the current selection.

Linked From

Select the nodes that are linked from the currently selected nodes. The nodes before in the hierarchy.

Linked To

Select the nodes that are linked to the currently selected nodes. The nodes behind in the hierarchy.

Grouped

Select grouped nodes.

Grouped Extend

Select grouped nodes, and extend from the current selection.

Activate same type previous

Activate same node type before the current selection, step by step.

Activate same type next

Activate same node type after the current selection, step by step.

Find Node

This button will open a search dialog where you can search for node types and select them in the current hierarchy.

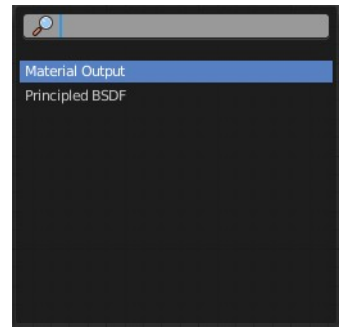



10.1.5 Editors - Compositor Editor - Header - Add Menu

Table of content

Add menu.....1
 Add menu - Search.....1

Add menu

Here you will find all the nodes that you need for compositing. A click at one of the items will create the node in the workspace at the mouse position right under the menu. It is already selected, and you can drag it around.

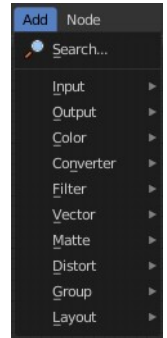

Note that the content may differ, dependent of which renderer you use. Some nodes just works with specific renderers. They will be marked as such.

Note also that some shaders are real resource hogs, and can slow down rendering times significantly.

Add menu - Search

This is a search menu where you can search for specific node types in all categories.

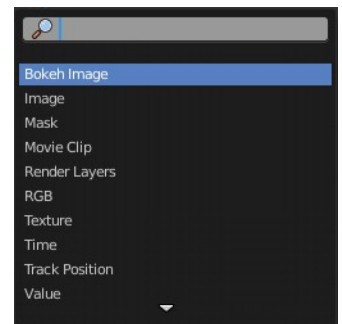

10.1.6 Editors - Compositor Editor - Header - Add Menu - Input

Table of content

Detailed table of content.....	1
Add menu - Input.....	5
Bokeh Image.....	5
Image.....	6
Mask.....	9
Movie Clip.....	10
Render Layers.....	11
RGB.....	12
Scene time.....	13
Texture.....	13
Time Curve.....	14
Track Position.....	16
Value.....	17

Detailed table of content

Detailed table of content

Detailed table of content.....	1
Add menu - Input.....	5
Bokeh Image.....	5
Properties.....	5
Flaps.....	5
Angle.....	5
Rounding.....	5
Catadioptric.....	5
Lens Shift.....	5
Outputs.....	5
Image.....	5
Image.....	6
Properties.....	6
Image Prop.....	6
List of images in the scene.....	6
Search form.....	6
Image Edit Box.....	6
Number of Fake Users.....	6
Fake User.....	6
Open.....	6
Remove.....	7
New.....	7
Name.....	7
Width.....	7
Height.....	7
Color.....	7
Alpha.....	7

Generated Type.....	7
32 Bit Float.....	7
Duplicate.....	7
Unlink Datablock.....	7
Fake User.....	8
Open Image.....	8
Unpack.....	8
User.....	8
Source.....	8
Color Space.....	8
Alpha Mode.....	8
Outputs.....	9
Image.....	9
Alpha.....	9
Depth.....	9
Mask.....	9
Properties.....	9
Masks.....	9
Feather.....	9
Size Source.....	9
Motion Blur.....	9
Samples.....	9
Shutter.....	10
Outputs.....	10
Mask.....	10
Movie Clip.....	10
Properties.....	10
Movie Clip.....	10
File browser.....	10
Name.....	10
Fake User.....	10
Load File.....	10
Delete File.....	10
Outputs.....	11
Image.....	11
Alpha.....	11
Offset X.....	11
Offset Y.....	11
Scale.....	11
Angle.....	11
Render Layers.....	11
Properties.....	11
Scene.....	11
Render layer.....	12
Outputs.....	12
Image.....	12
Alpha.....	12
Render passes sockets.....	12
Depth.....	12
RGB.....	12
Properties.....	12
Outputs.....	12
Color / RGBA.....	12

Scene time.....	13
Outputs.....	13
Seconds.....	13
Frame.....	13
Texture.....	13
Inputs.....	13
Offset.....	13
Scale.....	13
Properties.....	13
Texture.....	13
Outputs.....	13
Value.....	13
Color.....	13
Time Curve.....	14
Properties.....	14
Navigation elements.....	14
Zoom in and out.....	14
Tools.....	14
Reset View.....	14
Extend Horizontal.....	14
Extend Extrapolated.....	14
Reset Curve.....	14
Use Clipping.....	14
Curve window.....	15
Selecting Points.....	15
Adding Points.....	15
Vector Handle.....	15
Auto Handle.....	15
Auto Clamped Handle.....	15
X and Y value edit box.....	15
Start / End.....	15
Delete Points.....	15
Outputs.....	15
Factor.....	15
Track Position.....	16
Properties.....	16
Movie Clip browser.....	16
Open.....	16
Name.....	16
Fake User.....	16
Load File.....	16
Delete File.....	16
Tracking Object.....	16
Track Name.....	16
Position.....	16
Absolute.....	16
Relative Start.....	17
Relative Frame.....	17
Absolute Frame.....	17
Outputs.....	17
X/Y.....	17
Speed.....	17
Value.....	17

Properties.....	17
Default Value.....	17
Outputs.....	17
Value.....	17

Add menu - Input

The Input menu contains Input node types.

The content is the same for all three sub modes. Note that you need to tick Use Nodes to activate the menu items when you are in Line Style sub mode.

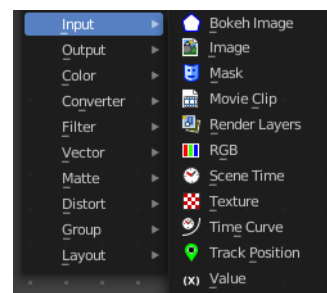

Bokeh Image

The Bokeh Image node generates a special input image for use with the Bokeh Blur filter node.

The Bokeh Image node is designed to create a reference image which simulates optical parameters such as aperture shape and lens distortions which have important impacts on bokeh in real cameras.

Properties

The first three settings simulate the aperture of the camera.

Flaps

Sets an integer number of blades for the cameras iris diaphragm.

Angle

Gives these blades an angular offset relative to the image plane.

Rounding

Sets the curvature of the blades with (0 to 1) from straight to bringing them to a perfect circle.

Catadioptric

Provides a type of distortion found in mirror lenses and some telescopes. This can be useful to produce a visual complex bokeh.

Lens Shift

Introduces chromatic aberration into the blur such as would be caused by a tilt-shift lens.

Outputs

Image

The generated bokeh image.

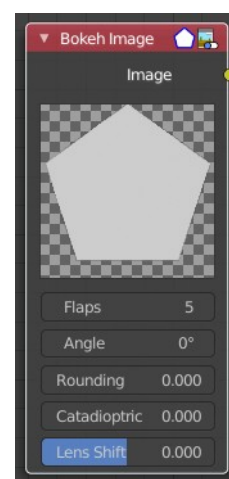

Image

Image input. For further image settings see also the Properties Panel in the Item Tab in the Sidebar.

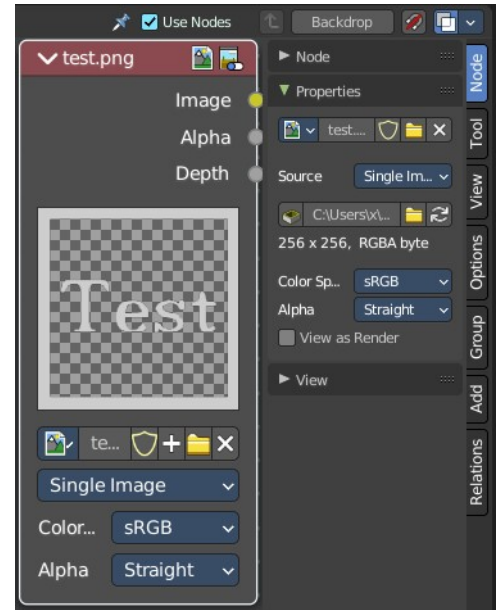

Properties

Image Prop

This property contains the list of loaded images. When no image is loaded then it displays the New and Open Buttons. When an image exists then it displays the name of the currently selected image.

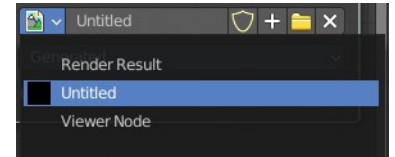

From left to right ...



List of images in the scene

This is a list of the images in the scene. This list allows you to switch to other images.

Search form

Search for specific images.

Image Edit Box

Read the name of the currently selected image. And you can rename the image here too.

Number of Fake Users

In case this file has a fake user assigned, then this number displays the number of fake users.

Fake User

With this button you assign a fake user to this selected image.

Data, like images, that is not longer linked to anything else gets removed when you save and reload a scene. Bforartists has the concept of fake users to go around this behavior. An image with a fake user is in fact linked to something. And so it is not lost when you save and reload the scene.

Open

Open a new image.

Remove

Removes the image.

New

Create a new image.

Creates a new image. You will get a dialog where you can define settings for the new image.

Name

The name of the new image

Width

The width of the new image.

Height

The height of the new image.

Color

Adjust the color of the new image. A click will call a color picker.

Alpha

Check this checkbox if the new image should have an alpha channel.

Generated Type

Here you can define what kind of texture you want to create.

Blank is one plain color.

UV Grid is a checker texture in black and white.

Color Grid is a colored checker texture.

32 Bit Float

Check this checkbox if the image should be in 32 Bit floating point bit depth per channel. Else it is in 8 bit per channel.

Duplicate

Not supported here.

Unlink Datablock

This deletes the selected image. Unfortunately not immediately. You need to save the scene and to reload it.

And you need to make sure that it is not linked to anything else. A mesh or a fake user for example. Have a look if there is a number besides the F button. When this is the case then the image has still a user, and so still loads with loading the scene.

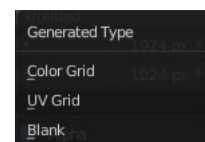
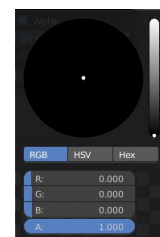
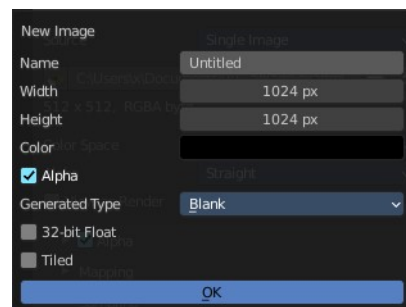

Fake User

With this button you assign a fake user to this selected image.

Data, like images, that is not longer linked to anything else gets removed when you save and reload a scene. Bforartists has the concept of fake users to go around this behavior. An image with a fake user is in fact linked to something. And so it is not lost when you save and reload the scene.

Open Image

Opens the file browser to load an image.

Unpack

Unpack packed files to a directory.

User

The number of users that uses this data. Data with a user number of 0 will be removed with closing Bforartists.

Source

What kind of image it is. The terms should be self explaining.

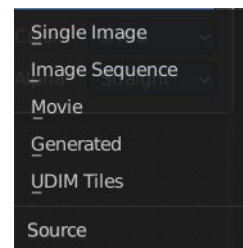

Color Space

What color space is used for the image.

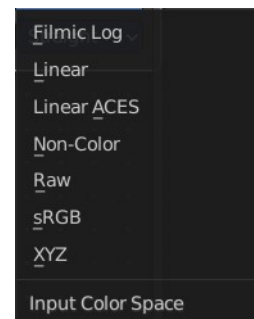

Alpha

What alpha mode is used for the image.

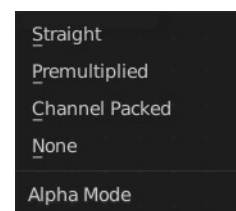

Outputs

Image

Standard image output.

Alpha

Separate Alpha value.

Depth

Z depth layer. This output just shows with specific image types.

Note. When a multi-layer file format, like EXR, is loaded, each layer is made available as a socket.

Mask

The Mask node can be used to select a Mask data. This node can be used with other nodes, for example to Invert, Multiply or Mix, or used as a factor input.

Masks can be created in the Image and Movie Clip editors, by changing the mode to Mask in the header. So you first need to create one in one of those editors.

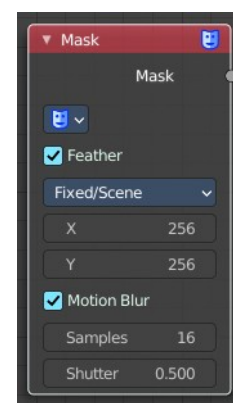

Properties

Masks

The available mask data. If the label is left blank, the mask name will be set.

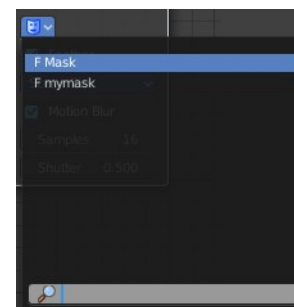

Feather

Use or ignore feather points defined for splines see Mask Feathers for more details.

Size Source

Scene Size will give an image the size of the render resolution for the scene, scaling along when rendering with different resolutions. Fixed gives a fixed size in pixels. Fixed/Scene gives a size in pixels that still scales along when changing the render resolution percentage in the scene.

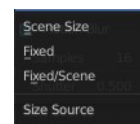

Motion Blur

For animated masks, creating a motion blurred mask from the surrounding frames, with a given number of samples (higher gives better quality), and a camera shutter time in seconds.

Samples

The number of motion blur samples.

Shutter

Expose for motion blur as a factor of Frames per Seconds.

Outputs

Mask

The black-and-white output of the mask.

Movie Clip

This node is a special node that uses some of the values taken from footage cameras and trackings and links them to the output. It is possible to load image sequences, but only Image and Alpha values will be available, because the other outputs will not have any values associated with them. When a tracked clip is chosen, Blender will fulfill the outputs using internal values taken from the tracking. So the controls for start and end frames will be defined at the Movie Clip editor.

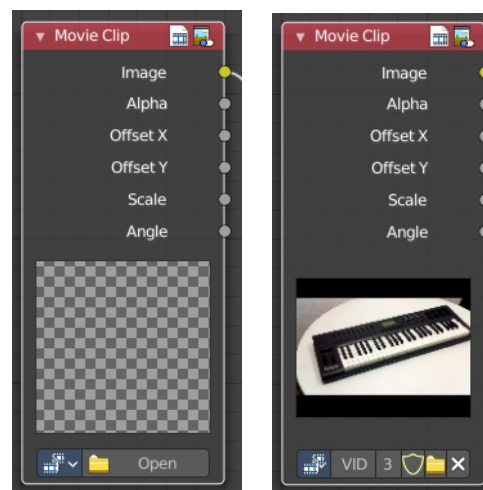

Properties

Movie Clip

Select the movie clip.

Once loaded you will see a preview image of the movie. Scrolling through the timeline will display the corresponding frame in this preview image.

File browser

Choose an already loaded video.

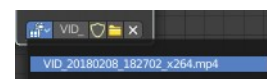

Name

Read and edit the name of the video.

Fake User

Assign a fake user to this video. Fake users is an odd concept to keep data in the scene even if it has no user somewhere. The fake user is then a dummy user so that the object is not deleted when saving the scene.

Load File

Load a new video.

Delete File

Delete this video.

Outputs

Image

Outputs the entire image at the specified color space.

Alpha

The alpha value taken from the movie or image.

Offset X

The X offset value from the footage camera or tracking.

Offset Y

The Y offset value from the footage camera or tracking.

Scale

The scale of the image taken from the footage camera or tracking.

Angle

The lens angle taken from the footage camera or tracking.

Render Layers

Inputs the available render layers.

This node is the starting place for getting a picture of your scene into the compositing node map.

The input happens through the properties.

Properties

Scene

Usually you don't need to select anything here when you work with just one Scene file. But in Bforartists you can work with more than one scene in a blend file. The scene information taken is the raw footage (pre-compositing and pre-sequencing).



Hint. To use composited footage from another scene, it has to be rendered into a multi-layer frame set (e.g. OpenEXR) as an intermediate file store and then imported with Image input node again.

Render layer

A list of available Render Layers. The render button allows you to re-render the active scene with one click.

Outputs

Image

The rendered image.

Alpha

The Alpha channel.

Render passes sockets

Depending on the Render passes that are enabled, other sockets are available. See Cycles and Eevee render passes. The Workbench renderer does not have extra render passes sockets. It just provides Image and Alpha output.

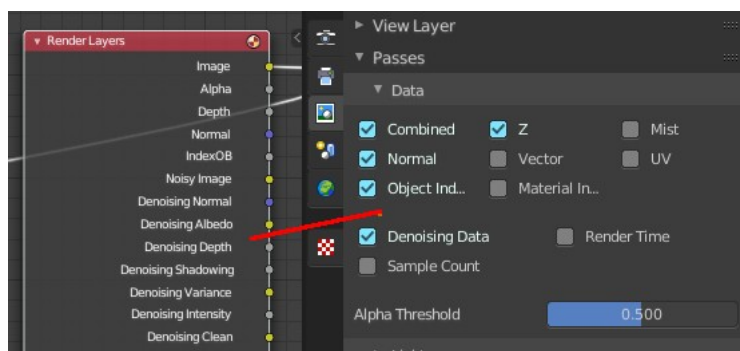

Depth

By default the Z depth pass is enabled.

RGB

Set a color.

Properties

The RGB node uses the color picker widget.

Outputs

Color / RGBA

A single RGBA color value.



Scene time

Outputs the current scene time in seconds or in frames.

The Frame output is a float value to make subframe rendering for motion blur possible.

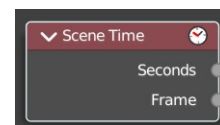

Outputs

Seconds

Output in seconds.

Frame

Output in Frames.

Texture

The Texture node allows you to use 3D textures in the Compositor. They can be created in the Texture tab in the Properties editor.

Inputs

Offset

A vector (XYZ) transforming the origin of the texture.

Scale

A vector (XYZ) to scale the texture.

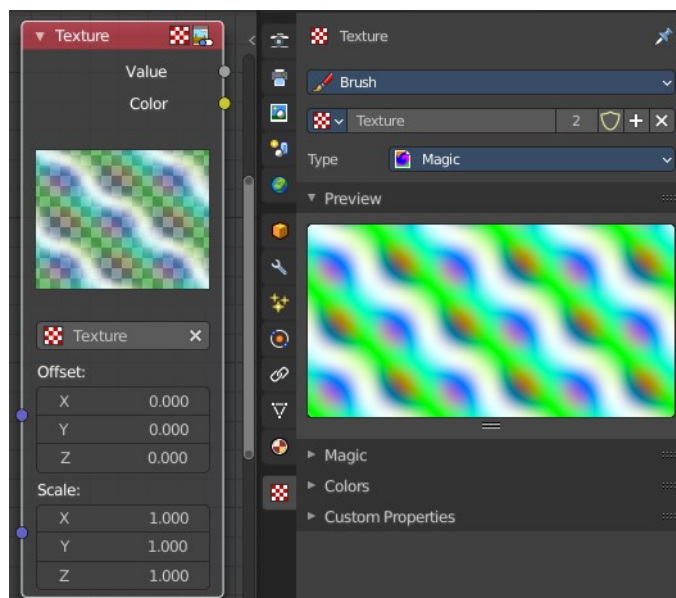

Properties

Texture

The texture could be selected from a list of textures available in the current blend-file or link in textures. The textures themselves could not be edited in this note, but in the Texture panel.

Outputs

Value

Gray-scale color values.

Color

Color values.

Time Curve

The Time node generates a factor value that changes according to the curve as time progresses through the Timeline. The range goes from 0.0 to 1.0. The default is a linear line from 0.0 to 1.0. But the curve can be adjusted.

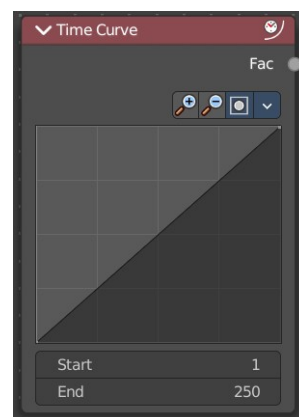

Properties

Navigation elements

The navigation elements for the curve. They are described from left to right.

Zoom in and out

The two buttons with the magnifying glass at it zooms in and out in the curve window.



Tools

Tools is a menu where you can find some curve related tools.

Reset View

Resets the curve windows zoom.

Extend Horizontal

Extends the curve horizontally before the first point and behind the last point.

Extend Extrapolated

Extends the curve extrapolated before the first point and behind the last point.

Reset Curve

Resets the curve to the initial shape.

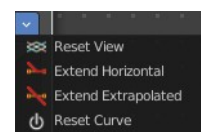

Use Clipping

Clipping options. Set up clipping for the stroke.

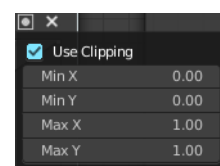

Curve window

Tweak and adjust the falloff curve by clicking at a curve point and dragging it around.

Double click adds a new point.

Holding down ctrl activates temporary snapping.

Holding down shift enables slower movement, which allows more accurate setting.

Selecting Points

You can select curve points. This reveals two edit boxes for the x and y coordinate of this point.

Selected points can be moved around. Left click at them, hold the mouse button down and move them to a new location.

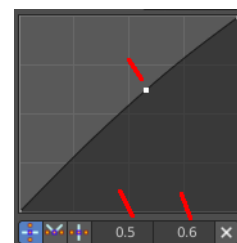

Adding Points

You can add new curve points by simply left clicking at the curve. Move the mouse to position them where you need it.

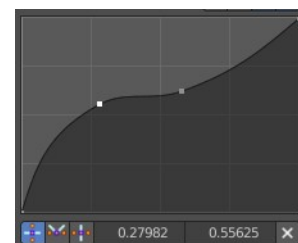

Vector Handle

Set handle type to Vector.

Auto Handle

Set handle type to Auto.

Auto Clamped Handle

Set handle type to Auto Clamped.

X and Y value edit box

The X and Y value for the currently selected curve point.

Start / End

Start frame and End frame of the range of time specifying the values the output should last. This range becomes the X axis of the graph. The time input could be reversed by specifying a start frame greater than the end frame.

Delete Points

Deletes selected curve points.

Outputs

Factor

A speed of time factor (from 0.00 to 1.00) relative to the frame rate defined in the Render Dimensions Panel. The factor changes according to the defined curve.

Hint. By using curves it is possible that the Time node may output a number larger than one or less than zero. To be safe, you should use the Min/Max clamping function of the Map Value node to limit output.

Track Position

The Track Position node is used to return information about a tracking marker to the Compositor. You need a tracking project here.



Properties

Movie Clip browser

Choose a loaded movie file.

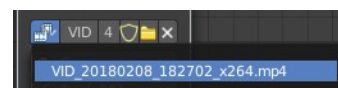

Open

Open a movie file.

Name

Read and edit the name of the video.

Fake User

Assign a fake user to this video. Fake users is an odd concept to keep data in the scene even if it has no user somewhere. The fake user is then a dummy user so that the object is not deleted when saving the scene.

Load File

Load a new video.

Delete File

Delete this video.

Tracking Object

Camera object to get track information from.

Track Name

The name of the track to get track information from.

Position

Which marker position to use for output.

Absolute

Outputs an absolute position of a marker.

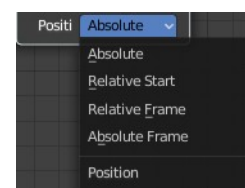

Relative Start

Outputs the positions of a marker relative to the first marker of a track.

Relative Frame

Outputs the positions of a marker relative to the markers of the given Frame.

Absolute Frame

Outputs the absolute positions of a marker at the given Frame.

Outputs

X/Y

The marker's X and Y location.

Speed

The velocity of the marker, measured in pixels per frame. This could be used to fake effects like motion blur by connecting it to the Vector Blur Node.

Value

The Value Node is a simple node to input numerical values to other nodes in the tree.

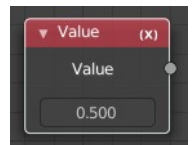

Properties

Default Value

Type in a single numerical value (floating point).

Outputs

Value

The value set in the options.



10.1.7 Editors - Compositor Editor - Header - Add Menu - Output

Table of content

Detailed table of content.....	1
Add menu - Output.....	3
Composite.....	3
File Output.....	3
Levels.....	4
Split Viewer.....	5
Viewer.....	6

Detailed table of content

Detailed table of content

Detailed table of content.....	1
Add menu - Output.....	3
Composite.....	3
Inputs.....	3
Image.....	3
Alpha.....	3
Z.....	3
Properties.....	3
Use Alpha.....	3
File Output.....	3
Inputs.....	4
Image.....	4
Properties.....	4
Base Path.....	4
File Format label.....	4
Levels.....	4
Inputs.....	4
Image.....	4
Properties.....	4
Channel.....	4
Outputs.....	5
Mean.....	5
Std Dev (Standard deviation).....	5
Split Viewer.....	5
Inputs.....	5
Image.....	5
Image.....	5
Properties.....	5
Axis.....	5
Factor.....	6
Viewer.....	6
Input.....	6
Image.....	6

Alpha.....	6
Z.....	6
Properties.....	6
Use Alpha.....	6

Add menu - Output

Here you will find nodes to output the result.

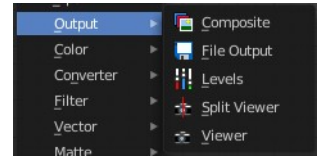

Composite

The Composite node is where the actual output from the Compositor is connected to the renderer. This node is updated after each render, but also reflects changes in the node tree (provided at least one finished input node is connected).

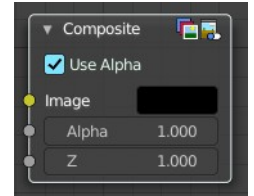

Inputs

Connecting a node to the Composite node will output the result of the prior tree of that node to the Compositor.

Image

RGB image. The default is black, so leaving this node unconnected will result in a blank image.

Alpha

Alpha channel.

Z

Z depth.

Properties

Use Alpha

Used alpha channel, colors are treated alpha premultiplied. If disabled, alpha channel gets set to 1, and colors are treated alpha straight, i.e. color channels does not change.

Note that if multiple Composite nodes are added, only the active one will be used.

File Output

This node writes out an image as part of a frame set sequence. This happens for each specified frame range and specified to the entered filename.

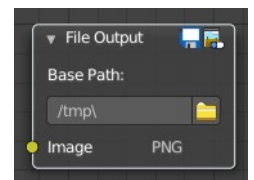

This node can be used as a way to automatically save the image after a render; In addition, since this node can be hooked in anywhere in the node tree, it can also save intermediate images automatically.

Inputs

Image

The image(s) will be saved on rendering, writing to the current frame. An entire sequence of images will be saved, when an animation is rendered.

Note. To support subsequent arrangement and layering of images, the node can supply a Z-depth map. However, please note that only the OpenEXR image formats save the Z information.

Properties

Base Path

Unlike the render output file path, this node uses a base directory and an image name, by default the output path is composed of: {base path}/{file name}{frame number}.{extension}.

Besides being split into two settings, in all other respects, this setting is treated the same as the render output path.

File Format label

Shows the selected File Format.

You can find further export options in the sidebar in the Item tab in the Properties panel.

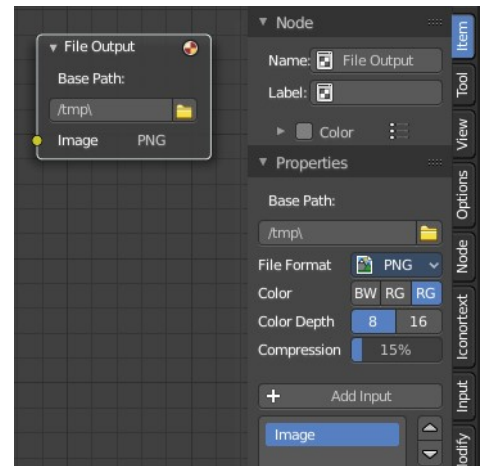

Levels

The Levels Node read the inputs color channels and outputs analytical values.

Inputs

Image

The image input.

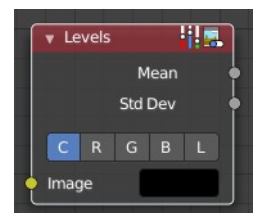

Properties

Channel

The channels. C (Combined RGB), R (Red), G (Green), B (Blue), L (Luminance)

Outputs

1D values based on the levels of an image.

Mean

The mean is the average value of all image pixels in specified channel (combined, red, green, blue, luminance). It tells you how dark or bright the image is and can be used as such for setups that depend on how is input “bright” or “dark”.

Std Dev (Standard deviation)

How much those pixel values differ from the mean. A low standard deviation indicates that the pixel values tend to be very close to the mean. A high standard deviation indicates that the values are spread out over a large range of values.

The visualization of such data is just a gray rectangle.

Split Viewer

The Split Viewer node takes two images and displays them side-by-side as backdrop or as a Viewer Node output. This allows you to toy around with values in direct comparison to the original. Or to compare frames with each other.

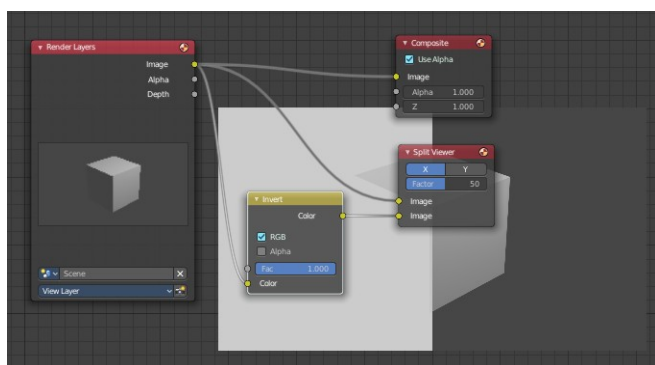
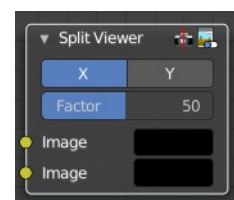

Inputs

Image

The first image input

Image

The second image input

Properties

Axis

X tiles the images horizontal. Y tiles the images vertical.

Factor

Percentage factor setting the space distribution between the two images.

Viewer

Displays the output as a backdrop in the viewport or in the Image editor. This allows you to inspect the outputs everywhere in the node hierarchy.

You can have more than one viewer nodes in the node editor. Just the output of the active Viewer node will be displayed. Click at a node to set it active.

When a Viewer node is selected, then the backdrop shows a widget cage that allows you to resize the backdrop image by its handlers.

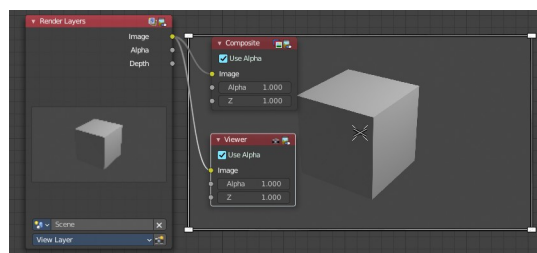
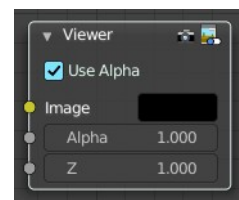

Input

Image

RGB image. The default is black, so leaving this node unconnected will result in a blank image.

Alpha

Alpha channel.

Z

Z depth.

Properties

Use Alpha

Used alpha channel, colors are treated alpha premultiplied. If disabled, alpha channel gets set to 1, and colors are treated alpha straight, i.e. color channels does not change.

10.1.8 Editors - Compositor Editor - Header - Add Menu - Color

Table of content

Detailed Table of Content.....	1
Add menu - Color.....	6
Alpha Over.....	6
Bright/Contrast.....	7
Color Balance.....	8
Color Correction.....	9
Gamma.....	10
Exposure.....	11
Hue Correct.....	11
Hue Saturation.....	13
Invert Color.....	14
Posterize.....	15
Mix.....	15
RGB Curves.....	16
Tonemap.....	18
Z Combine.....	19

Detailed Table of Content

Detailed table of content

Detailed Table of Content.....	1
Add menu - Color.....	6
Alpha Over.....	6
Inputs.....	6
Factor.....	6
Image.....	6
Image.....	6
Properties.....	6
Convert Premultiplied.....	6
Premultiply.....	6
Outputs.....	7
Image.....	7
Bright/Contrast.....	7
Inputs.....	7
Color.....	7
Brightness.....	7
Contrast.....	7
Properties.....	7
Convert Premultiplied.....	7
Outputs.....	7
Color.....	7
Color Balance.....	8
Inputs.....	8
Factor.....	8

Image.....	8
Properties.....	8
Correction Formula.....	8
Lift/Gamma/Gain.....	8
Lift.....	8
Gamma.....	8
Gain.....	8
Offset/Power/Slope (ASC-CDL).....	8
Offset.....	8
Basis.....	8
Power.....	8
Slope.....	8
Outputs.....	9
Color.....	9
Advanced.....	9
The Offset/Power/Slope Formula.....	9
Color Correction.....	9
Input.....	9
Image.....	9
Mask.....	9
Properties.....	9
Red, Green, Blue.....	9
Correction Tools (Columns).....	9
Saturation.....	9
Contrast.....	10
Gamma.....	10
Gain.....	10
Lift.....	10
Tonal Ranges (Rows).....	10
Master.....	10
Highlights.....	10
Mid tones.....	10
Shadows.....	10
Mid tones Start, Mid tones End.....	10
Outputs.....	10
Color.....	10
Gamma.....	10
Inputs.....	11
Image.....	11
Gamma.....	11
Outputs.....	11
Image.....	11
Exposure.....	11
Inputs.....	11
Image.....	11
Exposure.....	11
Outputs.....	11
Image.....	11
Hue Correct.....	11
Inputs.....	11
Factor.....	11
Image.....	11
Properties.....	12

Navigation elements.....	12
Zoom in and out.....	12
Tools.....	12
Reset View.....	12
Vector Handle.....	12
Auto Handle.....	12
Auto Clamped Handle.....	12
Extend horizontal.....	12
Extend extrapolated.....	12
Reset Curve.....	12
Use Clipping.....	12
Delete Points.....	12
Curve.....	12
X / Y.....	13
Outputs.....	13
Image.....	13
Hue Saturation.....	13
Inputs / Properties.....	13
Image.....	13
Hue.....	13
Saturation.....	13
Value.....	13
Factor.....	13
Color.....	13
Outputs.....	13
Image.....	13
Hue/Saturation Tips.....	13
Invert Color.....	14
Inputs.....	14
Factor.....	14
Color.....	14
Properties.....	14
RGB.....	14
Alpha.....	14
Outputs.....	14
Color.....	14
Posterize.....	15
Inputs.....	15
Image.....	15
Steps.....	15
Outputs.....	15
Image.....	15
Mix.....	15
Inputs.....	15
Factor.....	15
Image 1.....	15
Image 2.....	15
Properties.....	15
Mix.....	15
Clamp.....	16
Outputs.....	16
Image.....	16
RGB Curves.....	16

Inputs.....	16
Factor.....	16
Image.....	16
Black Level.....	16
White level.....	16
Properties.....	16
Tone.....	16
Curve Field.....	16
Channel buttons.....	16
Navigation elements.....	16
Zoom in and out.....	17
Use Clipping.....	17
Tools.....	17
Reset View.....	17
Extend horizontal.....	17
Extend extrapolated.....	17
Reset Curve.....	17
Curve edit field.....	17
Selecting Points.....	17
Adding Points.....	17
Curve point settings.....	17
Vector Handle.....	18
Auto Handle.....	18
Auto Clamped Handle.....	18
Outputs.....	18
Color.....	18
Tonemap.....	18
Inputs.....	18
Image.....	18
Properties.....	18
Type.....	18
Rh Simple.....	18
Key.....	18
Offset.....	18
Gamma.....	18
R/D Photo receptor.....	19
Intensity.....	19
Contrast.....	19
Adaptation.....	19
Color Correction.....	19
Outputs.....	19
Image.....	19
Z Combine.....	19
Inputs.....	19
Image.....	19
Z.....	19
Image.....	19
Z.....	19
Properties.....	19
Use Alpha.....	19
Anti-Alias Z.....	20
Outputs.....	20
Image.....	20

Z.....20

Add menu - Color

Here you find color related nodes.

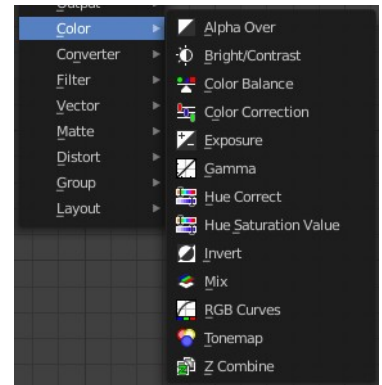

Alpha Over

The Alpha Over node is used to layer images with an alpha channel on top of one another.

Where the foreground image pixels have an alpha greater than 0, the background image will be overlaid.



Inputs

Factor

Controls the amount of foreground image. A factor less than 1 will make the foreground more transparent.

Image

Input for the background image.

Image

Input for the foreground image.

Properties

Convert Premultiplied

Converts foreground image to premultiplied alpha format.

The Alpha Over node is designed to work with premultiplied alpha color format. Use Convert Premul when you know that your image has straight alpha color values, to perform the correct over operation. Result will be still premultiplied alpha.

Premultiply

The Premul slider allows to mix between the using premultiplied or non premultiplied alpha.

When set to 1, the foreground color values will be multiplied by alpha, i.e. premultiplied. This is equivalent to enabling the Convert Premul option. When set to 0, color values does not change.

If Premultiply is not zero, Convert Premul will be ignored.

Note that this is a legacy option.

Outputs

Image

The image output.

Bright/Contrast

Adjust the brightness and contrast.

Inputs

Color

Standard input.

Brightness

An additive-type factor by which to increase the overall brightness of the image. Use a negative number to darken an image.

Contrast

A scaling type factor by which to make brighter pixels brighter, but keeping the darker pixels dark. Higher values make details stand out. Use a negative number to decrease the overall contrast in the image.

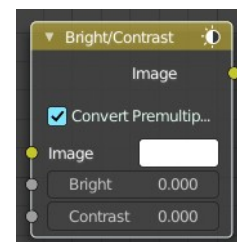

Properties

Convert Premultiplied

Converts foreground image to premultiplied alpha format.

The Alpha Over node is designed to work with premultiplied alpha color format. Use Convert Premul when you know that your image has straight alpha color values, to perform the correct over operation. Result will be still premultiplied alpha.

Outputs

Color

Standard output.

Note. It is possible that this node will put out a value set that has values beyond the normal range, i.e. values greater than one and less than zero. If you will be using the output to mix with other images in the normal range, you should clamp the values using the Map Value node (with the Min and Max enabled), or put through a Color Ramp node (with all normal defaults).

Color Balance

The Color Balance node can adjust the color and values of an image.

Inputs

Factor

Controls the amount of influence the node exerts on the output image.

Image

Standard image input.

Properties

Correction Formula

Two different correction formulas could be selected.

Lift/Gamma/Gain

Lift

Increases the value of dark colors.

Gamma

Will adjust mid tones.

Gain

Adjusts highlights.

Offset/Power/Slope (ASC-CDL)

Offset

Summand. (Adjusts the overall brightness.)

Basis

Additional offset, allows to specify a negative Offset value.

Power

Over-all exponent. (Adjusts the mid tones.)

Slope

Multiplier. (Adjusts the highlights.)

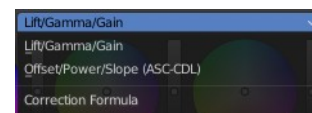
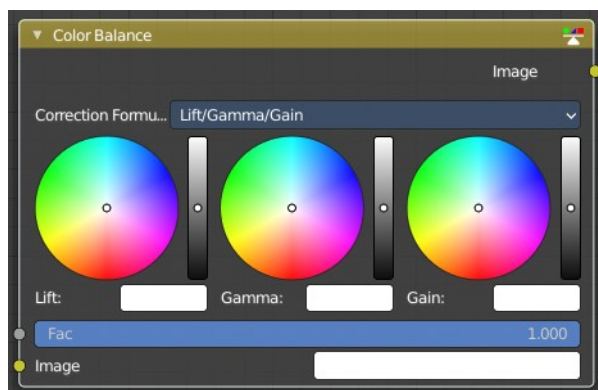

Outputs

Color

The output image.

Advanced

The Offset/Power/Slope Formula

$$\text{out} = (i \times s + o)^p$$

where:

out: The color graded pixel code value.

i: The input pixel code value (0 to 1) (black to white).

s: Slope (any number 0 or greater, nominal value is 1.0).

o: Offset (any number, the nominal value is 0).

p: Power (any number greater than 0, nominal value is 1.0).

Color Correction

With the Color Correction node you can adjust the color of an image. Separated in several tonal ranges (highlights, mid tones and shadows) and only affect the necessary RGB channels.

Input

Image

Image Input.

Mask

Input a mask to cover parts of the image so that they are affected.

Properties

Red, Green, Blue

Specifies which RGB channels will be affected by correction.

Correction Tools (Columns)

Saturation

Adjusts the image's saturation.

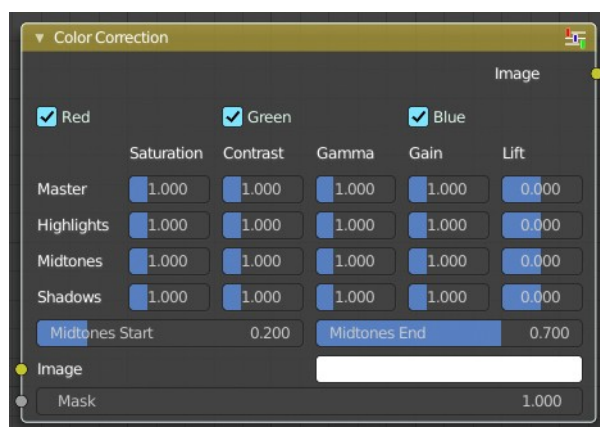

Contrast

Adjust image contrast.

Gamma

Exponential gamma correction, affecting the mid tones of the image. (Works like Power in the Color Balance node.)

Gain

Multiplier, stronger influence on the highlights. (Works like Slope in the Color Balance node.)

Lift

This value (can be negative) will be added (+), linear lightens or darkens the image. (Works like Offset in the Color Balance node.)

Tonal Ranges (Rows)

Master

These sliders affect the entire tonal range.

Highlights

These sliders only affect the highlights.

Mid tones

These sliders only affect the mid tones.

Shadows

Affects the dark tones of an image often affecting the shadows.

Mid tones Start, Mid tones End

Defines the start and the end of mid tones range, i.e. values where the whole tonal range is divided into the highlights, mid tones and shadows (there is also a smooth transition between the ranges of width 0.2 units).

Outputs

Color

The image output.

Gamma

Use this node to apply a gamma correction.

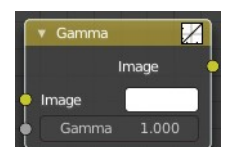

Inputs

Image

Image input.

Gamma

An exponential brightness factor.

Outputs

Image

Image output.

Exposure

The Exposure Node node allows you to make areas of an image brighter or dimmer.

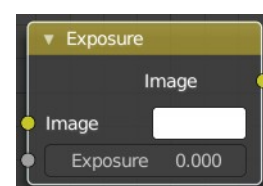

Inputs

Image

Standard image input.

Exposure

The scalar factor to adjust the exposure of the image.

Outputs

Image

Standard image output.

Hue Correct

With the Hue Correct Node you can adjust the Hue, Saturation, and Value of an image with an input curve.

Inputs

Factor

Controls the amount of influence the node exerts on the output image.

Image

Standard image input.

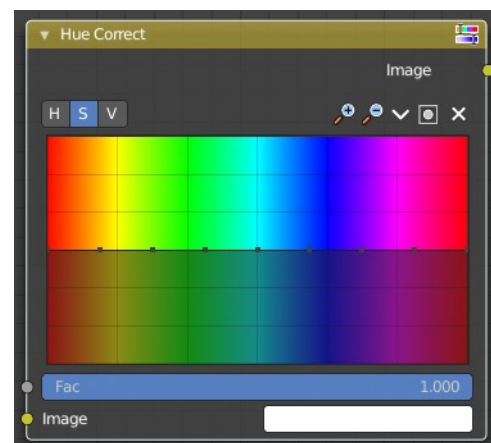

Properties

Level

H (Hue), S (Saturation), V (Value). Choose which curve you want to modify.

Navigation elements

The navigation elements at the top are described from left to right.



Zoom in and out

The two buttons with the magnifying glass at it zooms in and out in the curve window.

Tools

Tools is a menu where you can find some curve related tools.

Reset View

Resets the curve windows zoom.

Vector Handle

Set handle type to Vector.

Auto Handle

Set handle type to Auto.

Auto Clamped Handle

Set handle type to Auto Clamped.

Extend horizontal

Extends the curve before the first curve point and behind the last curve point horizontally.

Extend extrapolated

Extends the curve before the first curve point and behind the last curve point extrapolated.

Reset Curve

Resets the curve to the initial shape.

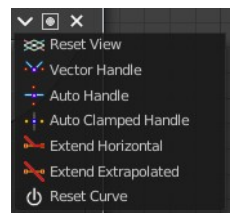

Use Clipping

Clipping options. Set up clipping for the stroke.

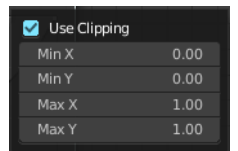

Delete Points

Deletes selected curve points.

Curve

By default, the curve is a straight line, meaning there is no change. The spectrum allows you to raise or lower HSV levels for each range of pixel colors. To change an H, S, or V level, move the curve points up or down. Pixels with hue values each point in the horizontal position of the graph will be changed depending on the shape of the curve.

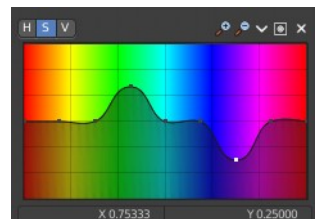

X / Y

The x y position of the currently selected curve point.

Outputs

Image

Image output.

Hue Saturation

The Hue Saturation Node applies a color transformation in the HSV color space. Called “Hue Saturation Value” in shader and texture context.

Inputs / Properties

The inputs also works as properties when nothing is connected.

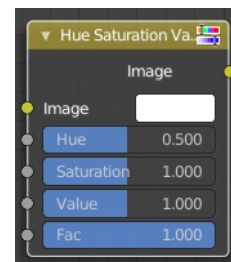

Image

Plug in an image.

Hue

Specifies the hue rotation of the image. 360° are mapped to (0 to 1). The hue shifts of 0 (-180°) and 1 (+180°) have the same result.

Saturation

A saturation of 0 removes hues from the image, resulting in a gray scale image. A shift greater than 1.0 increases saturation.

Value

Value is the overall brightness of the image. De/Increasing values shift an image darker/lighter.

Factor

Controls the amount of influence the node exerts on the output image.

Color

Standard input.

Outputs

Image

Standard output.

Hue/Saturation Tips

Some things to keep in mind that might help you use this node better:

Hues are vice versa

A blue image, with a Hue setting at either end of the spectrum (0 or 1), is output as yellow (recall that white, minus blue, equals yellow). A yellow image, with a Hue setting at 0 or 1, is blue.

Hue and Saturation work together.

So, a Hue of 0.5 keeps the blues the same shade of blue, but Saturation can deepen or lighten the intensity of that color.

Gray & White are neutral hues

A gray image, where the RGB values are equal, has no hue. Therefore, this node can only affect it with Value. This applies to all shades of gray, from black to white; wherever the values are equal.

Changing the effect over time

The Hue and Saturation values can be animated with a Time Node or by animating the property.

Invert Color

The Invert Node inverts the colors in the input image, producing a negative.

Inputs

Factor

Controls the amount of influence the node exerts on the output image.

Color

Standard input.

Properties

RGB

Invert the RGB values.

Alpha

Invert the Alpha values.

Outputs

Color

Standard image output.

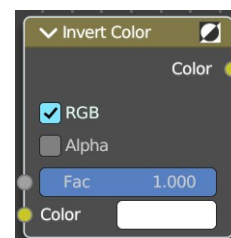

Posterize

The Posterize node reduces the number of colors in the image to a palette. The exact number of output colors is not to set. Just a number of steps to reduce the existing colors.

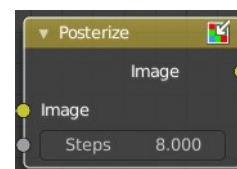

Inputs

Image

The image to reduce the colors at.

Steps

The number of steps to perform a color reduction.

Outputs

Image

Standard image output.

Mix

The Mix Node mixes images by working on the individual and corresponding pixels of the two input images. Called “MixRGB” in the shader and texture context.

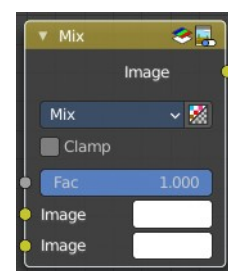

Inputs

Factor

Controls the amount of influence the node exerts on the output image.

Image 1

Usually the background image. The image size and resolution sets the dimensions of the output image.

Image 2

Usually the foreground image.

Properties

Mix

Choose the different blending modes.

Add, Subtract, Multiply, Screen, Divide, Difference, Darken, Lighten, Overlay, Color Dodge, Color Burn, Hue, Saturation, Value, Color, Soft Light, Linear Light.

Clamp

Limit the highest color value to not exceed 1.

Outputs

Image

Image output.

RGB Curves

The RGB Curves Node allows color corrections for each color channel and levels adjustments in the compositing context.

Inputs

Factor

Controls the amount of influence the node exerts on the output image.

Image

Standard image input.

Black Level

Defines the input color that is (linear) mapped to black.

White level

Defines the input color that is (linear) mapped to white.

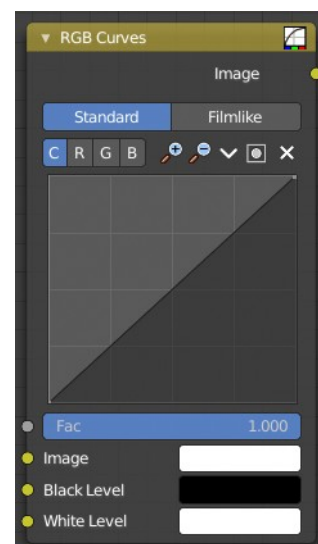

Properties

Tone

What tone mapping to use. Standard or Film like.



Curve Field

Channel buttons

Clicking on one of the channels displays the curve for each.

C (Combined RGB), R (Red), G (Green), B (Blue).



Navigation elements

They are described from left to right.



Zoom in and out

The two buttons with the magnifying glass at it zooms in and out in the curve window.

Use Clipping

Clipping options. Set up clipping for the stroke.



Tools

Tools is a menu where you can find some curve related tools.

Reset View

Resets the curve windows zoom.

Extend horizontal

Extends the curve before the first curve point and behind the last curve point horizontally.

Extend extrapolated

Extends the curve before the first curve point and behind the last curve point extrapolated.

Reset Curve

Resets the curve to the initial shape.



Curve edit field

Create and tweak a Bezier curve that varies the input levels (X axis) to produce an output level (Y axis).

Selecting Points

You can select curve points. This reveals two edit boxes for the x and y coordinate of this point.

Selected points can be moved around. Left click at them, hold the mouse button down and move them to a new location.

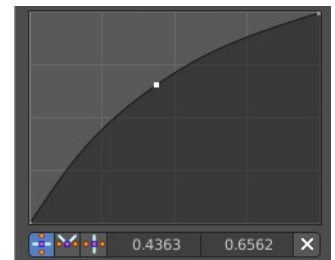

Adding Points

You can add new curve points by simply left clicking at the curve. Move the mouse to position them where you need it.

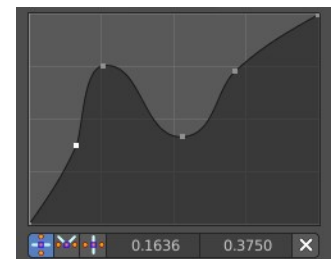

Curve point settings

When you have a point selected then you will reveal further settings at the bottom.



Vector Handle

Set handle type to Vector.

Auto Handle

Set handle type to Auto.

Auto Clamped Handle

Set handle type to Auto Clamped.

Outputs

Color

Standard output.

Tonemap

Tone mapping is a technique used in image processing and computer graphics to map one set of colors to another in order to approximate the appearance of high dynamic range images in a medium that has a more limited dynamic range.

Tone mapping addresses the problem of strong contrast reduction from the scene values (radiance) to the displayable range, while preserving the image details and color appearance. This is important to appreciate the original scene content.

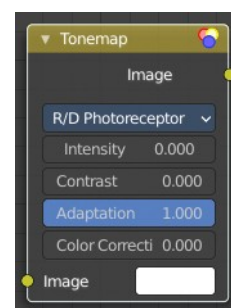

Inputs

Image

Plug in the HDR image.

Properties

Type

There are two methods of tone mapping. Rh Simple and R/D Photo receptor.

Rh Simple

Key

The value the average luminance is mapped to.

Offset

Normally always 1, but can be used as an extra control to alter the brightness curve.

Gamma

If not used, set to 1.



R/D Photo receptor

Intensity

A value smaller than zero darkens image. A value greater than zero makes it brighter.

Contrast

Set to 0 to use estimate from input image.

Adaptation

If 0, global; if 1, based on pixel intensity.

Color Correction

If 0, same for all channels; if 1, each independent.

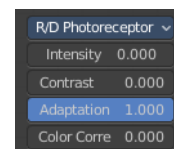

Outputs

Image

The Image output.

Z Combine

The Z Combine node combines two images based on their Z-depth maps. It overlays the images using the provided Z values to detect which parts of one image are in front of the other.

Inputs

Image

The background image.

Z

Z depth of the background image.

Image

The foreground image.

Z

Z depth of the foreground image.

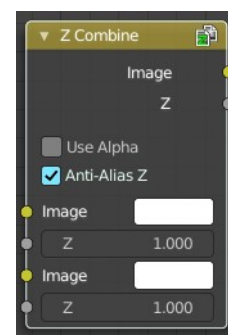

Properties

Use Alpha

The chosen Image pixel alpha channel is also carried over. If a pixel is partially or totally transparent, the result of the Z Combine will also be partially transparent; in which case the background image will show through the foreground (chosen) pixel.

Anti-Alias Z

Applies Anti-Aliasing to avoid artifacts at sharp edges or areas with a high contrast.

Outputs

Image

If both Z values are equal, it will use the foreground image. Whichever Z value is less decides which image pixel is used. See Z-buffer.

Z

The combined Z depth, which allows to thread multiple Z-combines together.



10.1.9 Editors - Compositor Editor - Header - Add Menu - Converter

Table of content

Detailed table of content.....	1
Add menu - Converter.....	5
Alpha Convert.....	5
Convert Colorspace.....	5
ColorRamp.....	6
Combine HSVA.....	8
Combine Color.....	8
Combine XYZ.....	9
Combine YCbCrA.....	9
Combine YUVA.....	10
ID Mask.....	10
Math.....	11
RGB to BW.....	12
Separate HSVA.....	12
Separate Color.....	13
Separate XYZ.....	13
Separate YCbCrA.....	13
Separate YUVA.....	14
Set Alpha.....	15
Switch View.....	15

Detailed table of content

Detailed table of content

Detailed table of content.....	1
Add menu - Converter.....	5
Alpha Convert.....	5
Input.....	5
Image.....	5
Properties.....	5
Mapping Type.....	5
Output.....	5
Image.....	5
Convert Colorspace.....	5
Input.....	6
Image.....	6
Properties.....	6
From.....	6
To.....	6
Output.....	6
Image.....	6
ColorRamp.....	6
Inputs.....	6
Factor.....	6

Properties.....	6
Color Ramp.....	6
Controls.....	6
+.....	6
-.....	7
Tools menu.....	7
Flip Color Ramp.....	7
Distribute Stops from Left.....	7
Distribute Stops Evenly.....	7
Eyedropper (pipette icon) E.....	7
Reset Color Ramp.....	7
Color Mode.....	7
RGB.....	7
HSV/HSL.....	7
Interpolation.....	7
Ease.....	7
Cardinal.....	7
Linear.....	7
B-Spline.....	7
Constant.....	7
Color Ramp.....	7
Active Color Stop elements.....	7
Choose active color stop.....	8
Pos.....	8
Outputs.....	8
Image.....	8
Alpha.....	8
Combine HSVA.....	8
Input.....	8
H, S, V and A.....	8
Output.....	8
Color.....	8
Combine Color.....	8
Input.....	8
Mode.....	8
R, G, B and A.....	8
Output.....	9
Color.....	9
Combine XYZ.....	9
Input.....	9
X Y and Z.....	9
Output.....	9
Color.....	9
Combine YCbCrA.....	9
Input.....	9
Y, Cb, Cr and A.....	9
Properties.....	9
Modes.....	9
Output.....	10
Image.....	10
Combine YUVA.....	10
Input.....	10
Y, U, V and A.....	10

Output.....	10
Image.....	10
ID Mask.....	10
Inputs.....	10
ID value.....	10
Properties.....	10
Index.....	10
Anti-Aliased.....	10
Outputs.....	10
Alpha.....	10
Setup.....	11
Math.....	11
Inputs.....	11
Value.....	11
Value.....	11
Properties.....	11
Operation.....	11
Clamp.....	12
Outputs.....	12
Value.....	12
RGB to BW.....	12
Inputs.....	12
Image.....	12
Outputs.....	12
Value.....	12
Separate HSVA.....	12
Input.....	12
Color.....	12
Output.....	12
H , S, V and A.....	12
Separate Color.....	13
Input.....	13
Mode.....	13
Image.....	13
Output.....	13
R, G, Band A.....	13
Separate XYZ.....	13
Input.....	13
Vector.....	13
Output.....	13
X, Y and Z.....	13
Separate YCbCrA.....	13
Input.....	14
Y, Cb, Cr and A.....	14
Properties.....	14
Modes.....	14
Output.....	14
Image.....	14
Y.....	14
Cb.....	14
Cr.....	14
A.....	14
Separate YUVA.....	14

Input.....	14
Image.....	14
Output.....	14
Y.....	14
U.....	14
V.....	15
A.....	15
Set Alpha.....	15
Inputs.....	15
Image.....	15
Alpha.....	15
Outputs.....	15
Image.....	15
Switch View.....	15
Inputs.....	15
Left.....	15
Right.....	15
Outputs.....	15
Image.....	15

Add menu - Converter

Here you find mainly nodes to convert data to another data.

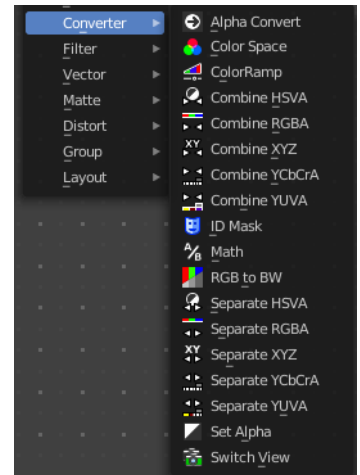

Alpha Convert

This node converts the alpha channel interpretation of an image from pre-multiplied to straight or vice versa. With a straight alpha channel you might run into artifacts at the borders when the pixels in the semi transparent areas.

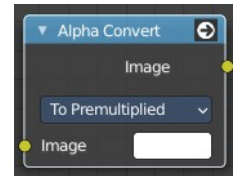

Input

Image

The input image.

Properties

Mapping Type

Convert straight to premultiplied. Or convert premultiplied to straight.

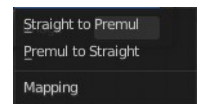

Output

Image

The image output.

Convert Colorspace

Convert between color spaces.

Note that the conversion is skipped when converting between the same color spaces or to or from data spaces.

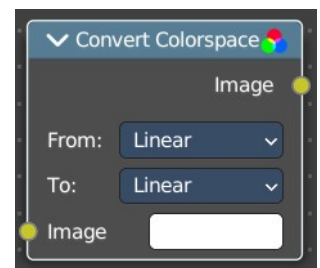

Input

Image

The input image.

Properties

From

The current color space.

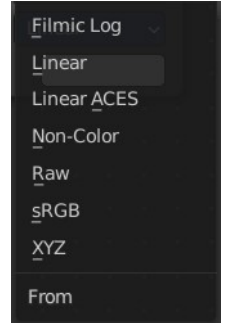

To

The destination color space.

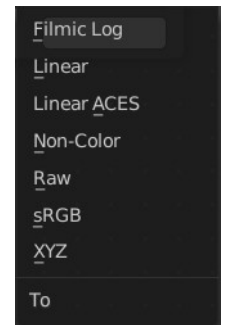

Output

Image

The image output.

ColorRamp

The Color Ramp Node is used for mapping values to colors with the use of a gradient.

Inputs

Factor

The Factor input is used as an index for the color ramp.

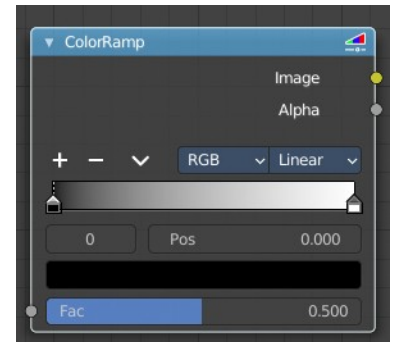

Properties

Color Ramp

Color Ramps enables the user to specify a range of colors based on color stops. The color between the color stops gets interpolated.

Controls

+

Add a stop to your color ramp. The stop will be added after the selected one, in the middle to the next one.

-
Deletes the selected color stop from the list.

Tools menu

Flip Color Ramp

Flips the gradient, inverting the values of the color ramp.

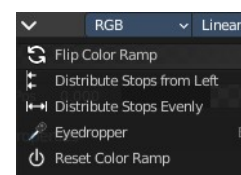

Distribute Stops from Left

Rearrange the stops so that every step has the same space to the right.

Distribute Stops Evenly

Space between all neighboring stops becomes equal.

Eyedropper (pipette icon) E

An Eyedropper to sample a color or gradient from the interface to be used in the color ramp.

Reset Color Ramp

Resets the color ramp to its default state.

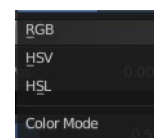

Color Mode

RGB

Blends color by mixing each color channel and combining.

HSV/HSL

Blends colors by first converting to HSV or HSL, mixing, then combining again. This has the advantage of maintaining saturation between different hues, where RGB would de-saturate, this allows for a richer gradient.

Interpolation

Ease

Uses an Ease Interpolation for the color stops.

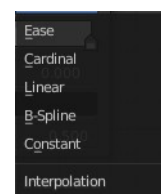

Cardinal

Uses a Cardinal Interpolation for the color stops.

Linear

Uses a Linear Interpolation for the color stops.

B-Spline

Uses a B-Spline Interpolation for the color stops.

Constant

Uses a Constant Interpolation for the color stops.

Color Ramp

The color band. A click at one of the color stops makes it the active one. You can move the color stops by clicking at them and dragging them around.



Active Color Stop elements

Adjust the active color stop.



Choose active color stop

Choose the color stop by index.

Pos

The position of the active color stop. The range goes from 0.000 to 1.000

Outputs

Image

Image output.

Alpha

Alpha channel output.

Combine Color

Combine single RGBA floating point channels into a single image.

Input

Mode

- **RGB** colour processing
- **HSV** colour processing
- **HSL** colour processing
- **YcbCr** converts an YCbCrA image to RGBA color space and unions the channels.
 - Y: Luminance, 0=black, 1=white
 - Cb: Chrominance Blue, 0=Blue, 1=Yellow
 - Cr: Chrominance Red, 0=Red, 1=Yellow
- **YUV** converts an YUVA image to RGBA color space. Note that U and V values range from -0.5 to +0.5.

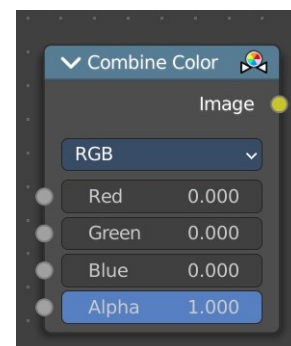

Input – RGB mode

R, G, B and A

The red, green, blue and alpha channels of an image.

Input – HSV mode

H, S and V

The Hue, Saturation and Value channels of an image.

Input – HSL mode

H, S and L

The Hue, Saturation and Luminescence channels of an image.

Input – YCbCRA mode

Y, Cb, Cr and A

Luminance, Chrominance Blue, Chrominance Red and Alpha input.

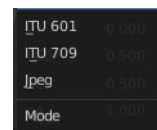

Properties

Modes

ITU 601, ITU 709, Jpeg. These are encoding standards for the YCbCrA color space.

Input – YUVA mode

Y, U, V and A

Luminance, Chrominance U, Chrominance V and Alpha channel.

Combine XYZ

Same as with Combine RGB node. It combines color values. But instead combining rgb values, which are in the range of 0 to 255, it uses values in the range from 0 to 1.



Input

X Y and Z

X, Y and Z values.

Output

Color

Color output.

ID Mask

The ID Mask Node can be used to access an alpha mask per object or per material.

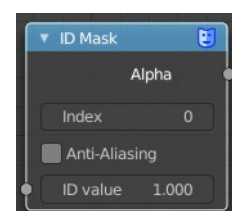

Inputs

ID value

Input for the Object Index or Material Index render pass. Which is an output of the Render Layers node or the Image node with a multi-layer format.

Properties

Index

Selection of the previously specified index.

Anti-Aliased

This post-process function refines the mask. See anti-aliasing.

Outputs

Alpha

The mask is white where the object is and black where it is not. If the object is transparent, the alpha mask represent that with gray values.

Setup

An index can be specify for any object or Cycles material in the scene. The Object Index can be set in the Relations panel in the Object tab in the Properties Editor. And for Cycles in the Settings Panel in the Material tab in the Properties editor. To be accessible after rendering, Object Index or Material Index render pass has to be enabled in the Passes panel in the View Layer properties tab in the Properties editor.

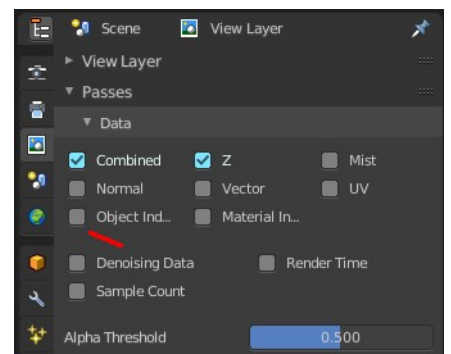
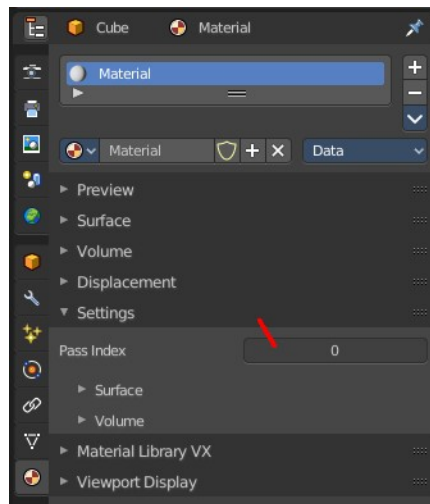
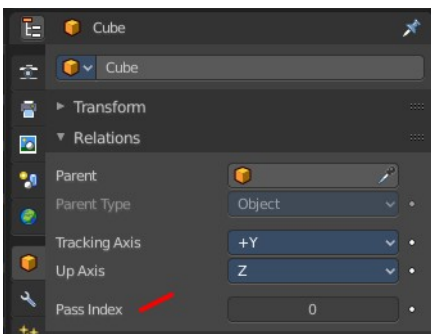

Math

The Math Node performs math operations.

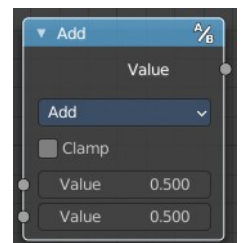

Inputs

Value

First numerical value. The trigonometric functions accept values in radians.

Value

Second numerical value. This value is not used in functions that accept only one parameter like the trigonometric functions, Round and Absolute.

Properties

Operation

Here you can choose what mathematical operation to perform.

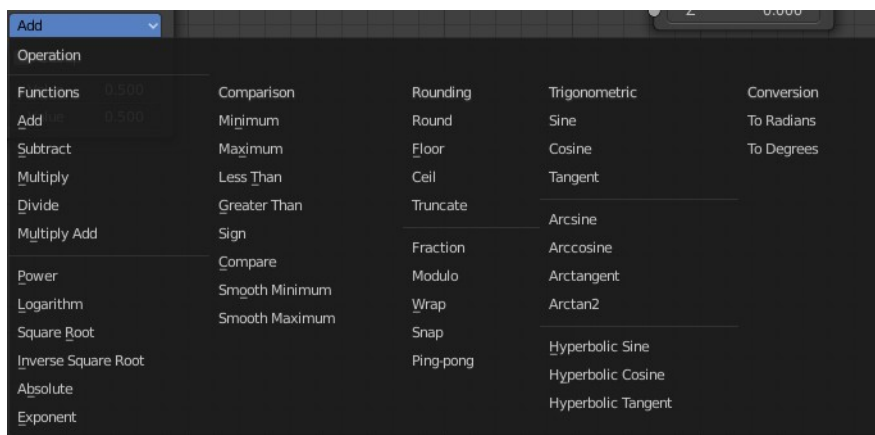

Clamp

Limits the output to the range (0 to 1). See clamp.

Outputs

Value

Numerical value output.

RGB to BW

The RGB to BW Node converts an RGB color image to a gray-scale image based at its luminance.



Inputs

Image

Color image input.

Outputs

Value

Gray-scale value output.

Separate Color

Separates the single RGBA channels from a single image.

Input

Mode

- **RGB** colour processing
- **HSV** colour processing
- **HSL** colour processing
- **YcbCr** converts an YCbCrA image to RGBA color space and unions the channels.
 - Y: Luminance, 0=black, 1=white
 - Cb: Chrominance Blue, 0=Blue, 1=Yellow
 - Cr: Chrominance Red, 0=Red, 1=Yellow
- **YUV** converts an YUVA image to RGBA color space. Note that U and V values range from -0.5 to +0.5.

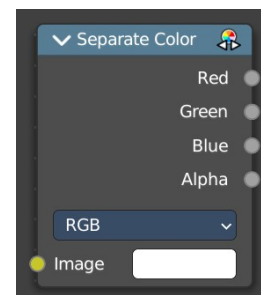

Output – RGB mode

R, G, B and A

The red, green, blue and alpha channels of an image.

Output – HSV mode

H, S and V

The Hue, Saturation and Value channels of an image.

Output – HSL mode

H, S and L

The Hue, Saturation and Luminescence channels of an image.

Output – YCbCRA mode

Y, Cb, Cr and A

Luminance, Chrominance Blue, Chrominance Red and Alpha input.

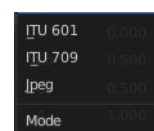

Properties

Modes

ITU 601, ITU 709, Jpeg. These are encoding standards for the YCbCrA color space.

Output – YUVA mode

Y, U, V and A

Luminance, Chrominance U, Chrominance V and Alpha channel.

Separate XYZ

Same as with Separate RGB node. It separates color values. But instead separating rgb values, which are in the range of 0 to 255, it uses a vector with the values in the range from 0 to 1.

Input

Vector

The Input vector.

Output

X, Y and Z

The output vectors for X, Y and Z

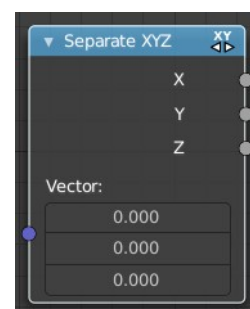

Set Alpha

The Set Alpha Node adds an alpha channel to an image.

Inputs

Image

Standard image input.

Alpha

The amount of Alpha can be set for the whole image by using the input field or per pixel by connecting to the socket.

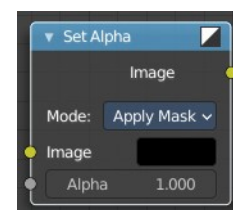

Outputs

Image

The image output.

Switch View

The Switch View node combines the views (left and right) into a single Stereo 3D output. This can be useful if for example, you need to treat the view as separate images by combining each of the views.

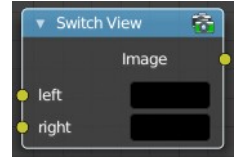

Inputs

Left

Left-eye image input.

Right

Right-eye image input.

Outputs

Image

Stereo 3D image output.



10.2 Editors - Compositor Editor - Tool Shelf

Table of content

Tool Shelf.....	2
Select Tools Group.....	2
Tweak.....	2
Select Box.....	2
Tool Settings.....	2
Mode.....	2
Set a new selection.....	2
Extend existing selection.....	2
Subtract existing selection.....	2
Select Circle.....	2
Tool Settings.....	3
Mode.....	3
Set a new selection.....	3
Extend existing selection.....	3
Subtract existing selection.....	3
Radius.....	3
Select Lasso.....	3
Tool Settings.....	3
Mode.....	3
Set a new selection.....	3
Extend existing selection.....	3
Subtract existing selection.....	3
Annotate Tools group.....	3
Annotate.....	4
Tool Settings.....	4
Color.....	4
Stabilize Stroke.....	4
Radius.....	4
Factor.....	4
Annotate Line.....	4
Tool Settings.....	4
Color.....	4
Style Start.....	4
End.....	5
Annotate Polygon.....	5
Tool Settings.....	5
Color.....	5
Annotate Eraser.....	5
Tool Settings.....	5
Radius.....	5
Links Cut.....	5

Tool Shelf



Select Tools Group

Tools with a triangle down right are a group of tools. Click and hold to reveal the content. Then choose the tool that you need.

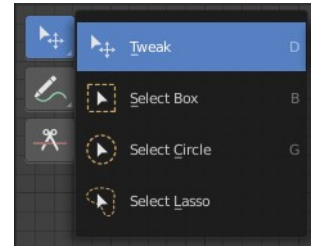

Tweak

Allows you to select or tweak single elements by clicking at it.

Select Box

Draws a box to select several elements at once. Click at the start point, then drag.

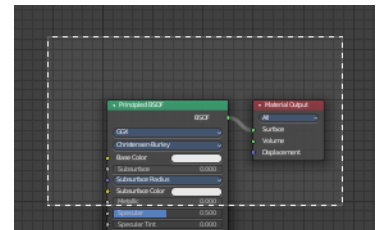

Tool Settings

Mode

The available selection modes. The mode titles are pretty self explaining. So i won't go into detail here.

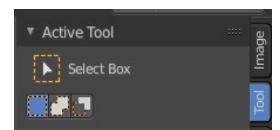

Set a new selection

Extend existing selection

Subtract existing selection

Select Circle

Draws a box to select several elements at once. Click at the start point, then drag.

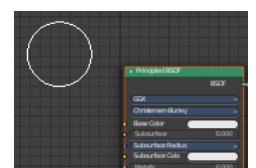

Tool Settings

Mode

The available selection modes. The mode titles are pretty self explaining. So i won't go into detail here.



Set a new selection

Extend existing selection

Subtract existing selection

Radius

The brush radius.

Select Lasso

Draws a box to select several elements at once. Click at the start point, then drag.

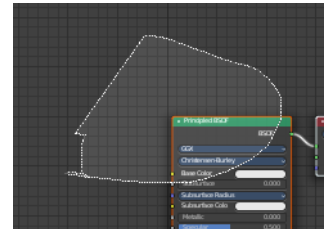

Tool Settings

Mode

The available selection modes. The mode titles are pretty self explaining. So i won't go into detail here.

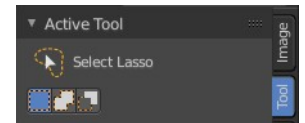

Set a new selection

Extend existing selection

Subtract existing selection

Annotate Tools group

The annotation tool is available in multiple editors. With this tool you can write notes at the screen. The annotate tools is the little brother of the grease pencil objects.

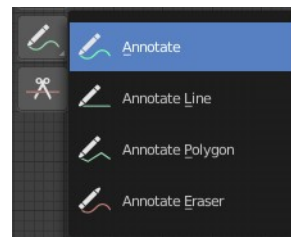

Further settings for annotate can be found in the sidebar.

Here you can also remove an annotation when you don't longer need it. And here you can also adjust the size of the stroke.

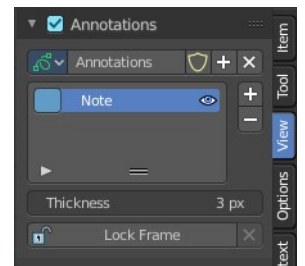

Annotate

Draw free-hand strokes in the main window.

Tool Settings

The tool settings for Annotate.

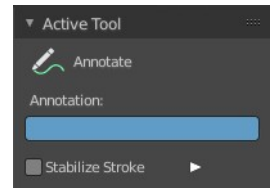

Color

Clicking at the left color field reveals a color picker. Define the color for the annotation stroke.



Stabilize Stroke

Helper to draw smooth and clean lines. Pressing shift inverts the effect.

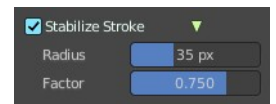

Radius

The radius for the stroke stabilization.

Factor

Stabilizer stroke factor. Higher values gives a smoother stroke.

Annotate Line

Click and drag to create a line.

Tool Settings

The tool settings for the Annotate tool.

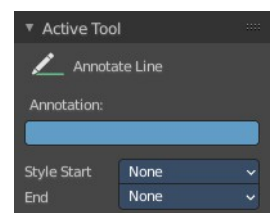

Color

Clicking at the left color field reveals a color picker. Define the color for the annotation stroke.



Style Start

The stroke start style. With an arrow for example you place an arrow at the start of the stroke.

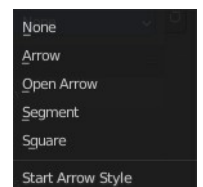

End

The stroke end style. With an arrow for example you place an arrow at the end of the stroke.

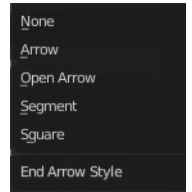

Annotate Polygon

Click multiple times to create multiple connected lines. The current polygon is finished when Esc or RMB is pressed.

Tool Settings

The tool settings for Annotate.

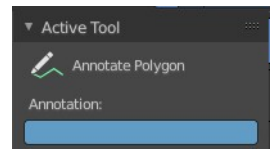

Color

Clicking at the left color field reveals a color picker where you can define the color for the annotation stroke.



Annotate Eraser

Click and drag to remove annotate lines.



Tool Settings

Radius

The radius of the eraser pencil.

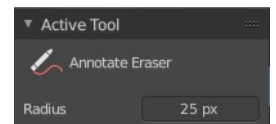

Links Cut

This tools allows you to cut connections.

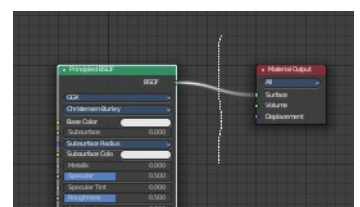



10.3 Editors - Compositor Editor - Sidebar

Table of content

Introduction.....	1
Right Click menus.....	1

Introduction

The Compositor Editor is made of several areas. At the right side you will find the sidebar. Here you will find further options and settings for the Shader Editor nodes and its tools.

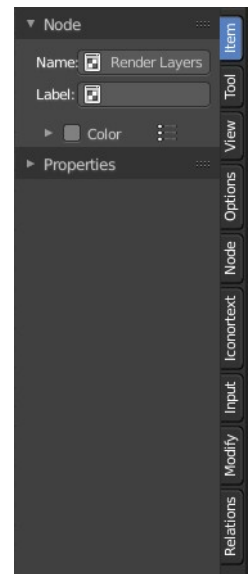

Right Click menus

You will open the usual right click menu when clicking with the right mouse at elements in the sidebar. Its content is in big parts self explaining.

The right click menus are explained in the chapter 6 Editors Introduction.

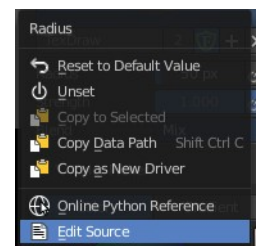



10.3.1 Editors - Compositor Editor - Sidebar - Node Tab

Table of content

Node Tab - Node Panel.....	2
Name.....	2
Label.....	2
Color sub menu.....	2
Color checkbox.....	2
Presets.....	2
Color.....	2
Node color specials.....	2
Copy Color.....	2
NodeTab - Properties Panel.....	3
Node Tab - Properties Panel with Image node.....	3
Image Property.....	3
Image Browser.....	3
New / Open.....	4
Image Edit Box.....	4
Fake User.....	4
Open Image.....	4
Remove.....	4
Source.....	4
Source Type Generated.....	4
X / Y.....	4
Float Buffer.....	4
Generated Type Blank.....	4
Color.....	5
Generated Type UV Grid.....	5
Generated Type Color Grid.....	5
Color Space.....	5
View as Render.....	5
Source Type Movie + Image Sequence.....	5
Path edit box.....	6
Pack.....	6
Path edit box.....	6
Open.....	6
Refresh.....	6
Info string.....	6
Frames.....	6
Match Movie Length.....	6
Start.....	6
Offset.....	6
Cyclic.....	6
Auto Refresh.....	6
Deinterlace.....	6
Color Space.....	7
Alpha.....	7
View as Render.....	7
Source Type Single Image.....	7
Path edit box.....	7

Pack.....	7
Path edit box.....	7
Open.....	7
Refresh.....	7
Info string.....	7
Color Space.....	8
Alpha.....	8
View as Render.....	8
Node Tab - Properties Panel with Movie Clip node.....	8
Color Space.....	8

Node Tab - Node Panel

The node panel allows you to give nodes and node groups a name and a label, and change its color.

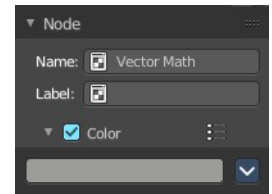

Name

The type of the node.

Label

The label name of the node.



Color sub menu

Color checkbox

The Color checkbox turns custom color on or off.

Presets

Store some color presets and reuse them. They are stored globally, and transfers to other blend files.

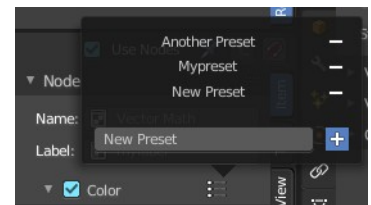

Color

Choose a custom color. A click at the color field will open a color picker.

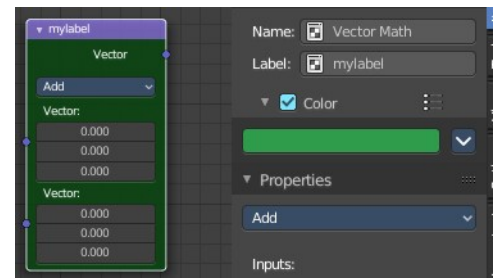

Node color specials

Copy Color

Allows you to copy the color.

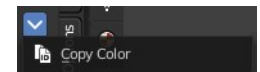

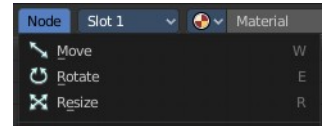

NodeTab - Properties Panel

This panel shows usually the same properties than the properties at the node. These properties are already explained in the Add menu chapters. So we won't repeat them here.

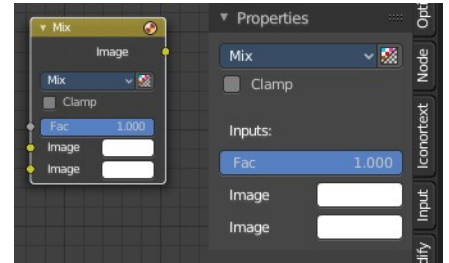

But there are exceptions like the Image node. Here the Properties panel shows much more options than at the node. It shows all the possible image settings. We will explain the extra options here.

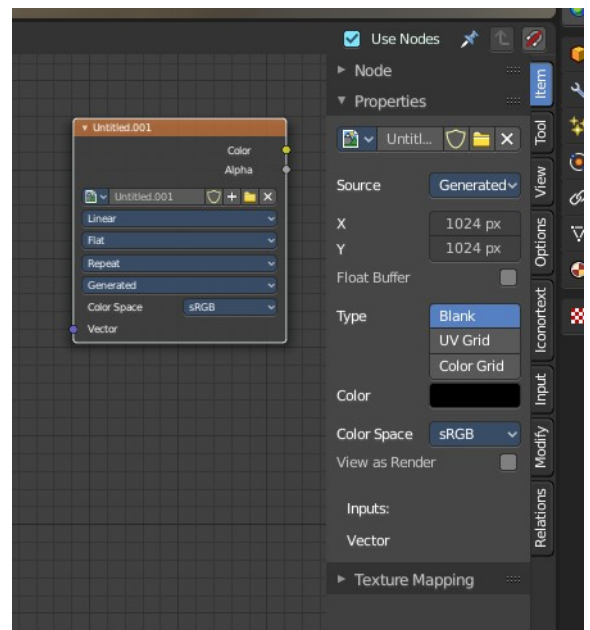

Node Tab - Properties Panel with Image node

Contains image related settings. Size, type, and so on.

Image Property

Load an image and / or switch to other images.

From left to right ...

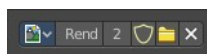
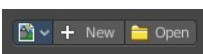
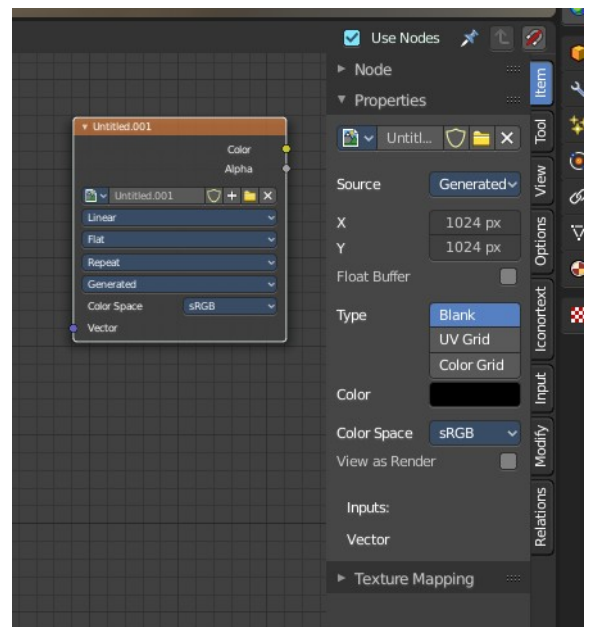

Image Browser

This is a list of the images in the scene. Allows you to switch to



other images.

New / Open

When nothing is loaded then you will see the New / Open buttons to load a new image, or to create a new one.

Image Edit Box

The name of the currently selected image. And you can rename the image here too.

Fake User

With this button you assign a fake user to this selected image.

Data, like images, that is not longer linked to anything else gets removed when you save and reload a scene. Bforartists has the concept of fake users to go around this behavior. An image with a fake user is in fact linked to something. And so it is not lost when you save and reload the scene.

Open Image

Load an image

Remove

Delete the image.

Source

Choose the image type. This type gets usually automatically set. When you create a new image, then this image is generated. When you load an image then the Source switches to Single Image.

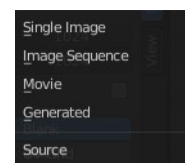

Generated images does not have a path.

Source Type Generated

X / Y

The image width and height.

Float Buffer

Use a floating point buffer. 8 Bit images uses integers. 32 Bit works with floats.

Generated Type Blank

This type displays an image with one blank color

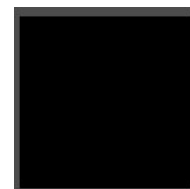

Color

The color of the blank image.

Generated Type UV Grid

This type displays a with a black and white checker texture but colored dots.

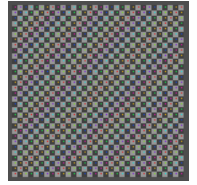

Generated Type Color Grid

This type displays a with a colored checker texture with numbers.



Color Space

Choose the color space type for the image.

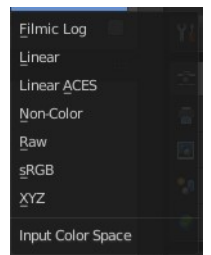

View as Render

Displays the image with the color management settings.

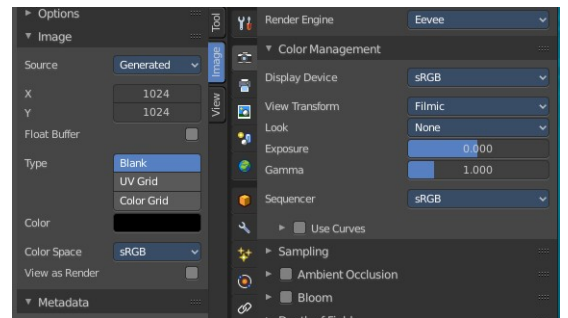

Source Type Movie + Image Sequence

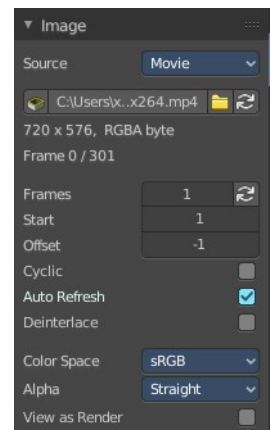
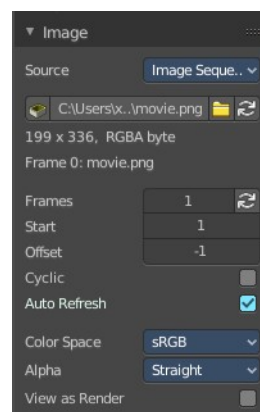

Path edit box

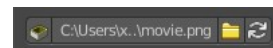

Pack

With this button you can pack the movie or the image sequence into the blend file. It gets packed when you save the blend file the next time.

Path edit box

See and edit the path to your movie or image sequence files.

Open

Open a new movie or image sequence files. A file dialog will appear.

Refresh

Reread the movie or image sequence files.

Info string

Some information about the currently loaded movie. Frames, resolution and color space.

Frames

The number of frames of the movie or image sequence.

Match Movie Length

Set Users Image Length to the one of this video.

Start

The start frame of the movie or image sequence

Offset

Offset the number of the frame to use in the animation. -1 means off.

Cyclic

Cycle the images in the movie.

Auto Refresh

Always refresh image on frame changes.

Deinterlace

Deinterlace the movie file on load.

Color Space

Choose the color space type for the movie or image sequence files.

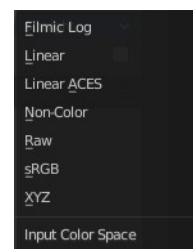

Alpha

Choose the alpha channel mode. Straight or Premultiplied.

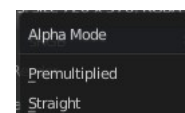

View as Render

Display the image with using the color management settings.

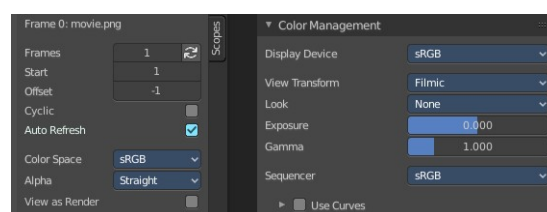

Source Type Single Image

Path edit box

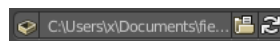

Pack

With this button you can pack the movie or the image sequence into the blend file. It gets packed when you save the blend file the next time.

Path edit box

See and edit the path to your movie or image sequence files.

Open

Open a new movie or image sequence files. A file dialog will appear.

Refresh

Reread the movie or image sequence files.

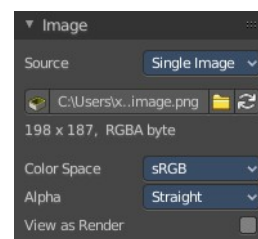

Info string

Some information about the currently loaded image. Resolution and color space.

Color Space

Choose the color space type for the movie or image sequence files.

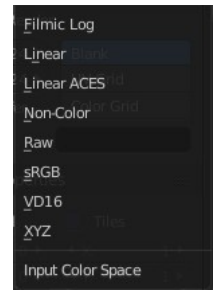

Alpha

Choose the alpha channel mode. Straight or Premultiplied.

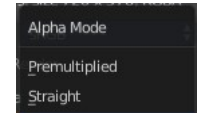

View as Render

Display the image with using the color management settings.

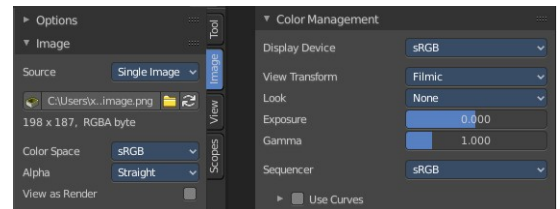

Node Tab - Properties Panel with Movie Clip node

Color Space

Choose the color space for the imported movie.





10.3.2 Editors - Compositor Editor - Sidebar - Tool Tab

Table of content

Tool Tab.....1

Tool Tab

The settings of the currently active tool in the tool shelf.

In the node editor we don't have something special here. The tool related settings are explained in the tool shelf chapter.

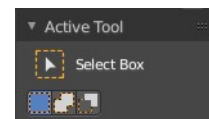



10.3.3 Editors - Compositor Editor - Sidebar - View Tab

Table of content

View Tab - Backdrop Panel.....	1
Backdrop checkbox.....	1
Zoom.....	1
Offset.....	1
View Tab - Annotation Panel.....	1
Annotations prop.....	2
Drop down box.....	2
Edit Box.....	2
Fake User.....	2
Add Annotation.....	2
Delete Annotation.....	2
List of Annotation Strokes.....	2
Thickness.....	3
Frame Locked/Unlocked.....	3
Onion Skin.....	3

View Tab - Backdrop Panel

When you add and connect a Viewer node, then you can display the result as a backdrop in the node editor viewport. Here you can find some further Backdrop settings.

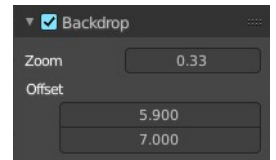

Backdrop checkbox

Turn on or off the display of the backdrop image.

Zoom

The zoom factor of the image. A value of 1 displays the image in original size.

Offset

The position of the image in the viewport.

View Tab - Annotation Panel

View related settings. Which is in the node editor just the Annotations panel where you can manage the Annotation layers and materials.

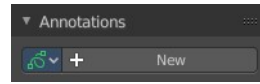

When you don't have drawn an annotation yet then the panel just contains a New button.

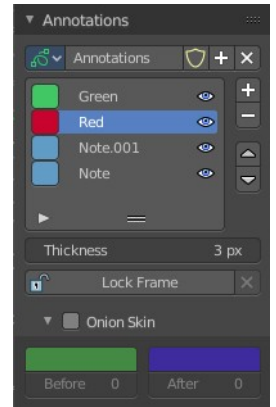

Annotations prop

Add, remove and rename new annotations.

Drop down box

A list of the available annotation layers.

Edit Box

The name of the current annotation. You can rename the annotation to your needs here.

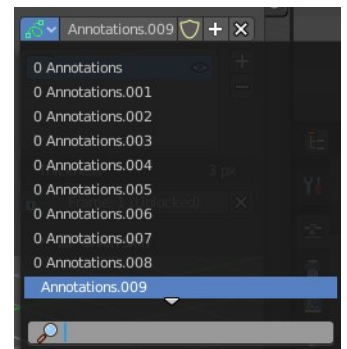

Fake User

Assign a fake user to this annotation. Fake users is an odd concept to keep data in the scene even if it has no user somewhere. The fake user is then a dummy user so that the object is not deleted when saving the scene.

Add Annotation

Add a new annotation.

Delete Annotation

Delete the annotation.

List of Annotation Strokes

Here you see your Annotation layers for the current Annotation. Every layer can have an own color.

At the right side you find buttons to sort them and to add and remove new Annotation layers.

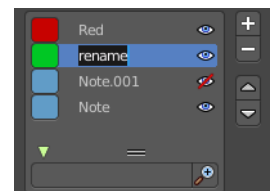

You can change the color by clicking at the color field. A color dialog will pop up. You can rename annotation layers by double clicking at it.

The eye icon allows you to make it invisible And it has a search field.

Thickness

The thickness of the annotation stroke.

Frame Locked/Unlocked

Lock frame displayed by current layer. This toggles whether the active layer is the only one that can be edited.

Onion Skin

Enable Onion Skinning.

Onion Skinning allows to show ghosts of the keyframes before and after the current frame. In this sub panel you can adjust the color of the onion skin frames.

With the numbers below the colors you can define how many frames before or after are displayed that way.

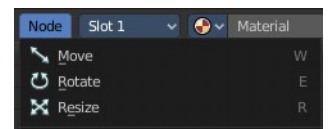



10.3.4 Editors - Compositor Editor - Sidebar - Options Tab

Table of content

Options Tab - Performance panel.....	1
Render.....	1
Edit.....	1
Chunk size.....	1
OpenCL.....	1
Buffer Groups.....	1
Two Pass.....	1
Viewer Border.....	1
Auto Render.....	2

Options Tab - Performance panel

In the Options tab you will find general options. The Performance panel provides you with general settings that improves the performance in the Compositor editor to get faster results.

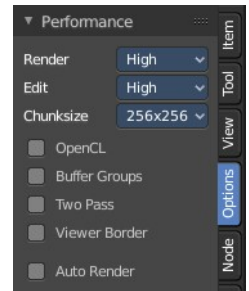

Render

The quality when rendering the image.

Edit

The quality when editing the image.

Chunk size

The maximum size of a tile. Smaller tiles gives better distribution of multiple threads. But produces more overhead.

OpenCL

Use GPU for calculation. The graphics card must support OpenCL

Buffer Groups

Enable buffering of group nodes.

Two Pass

Use two pass execution during editing. First calculate fast nodes. Second pass calculates all nodes then.

Viewer Border

Use boundaries for viewer nodes and composite backdrop.

Auto Render

Re Render and composite changed layers on 3D edits.



10.3.5 Editors - Compositor Editor - Sidebar - Add Tab

Table of content

- Add Tab..... 1
 - Usage..... 1
- Add tab - Display Panel..... 1
 - Icon Buttons..... 1

Add Tab

Here you can find the same nodes than in the Add menu. Panels are more convenient to use. They stay open for example. It's your decision with what system you want to work.

We won't explain the content of the panels again. The single nodes are explained in the add menu chapter.

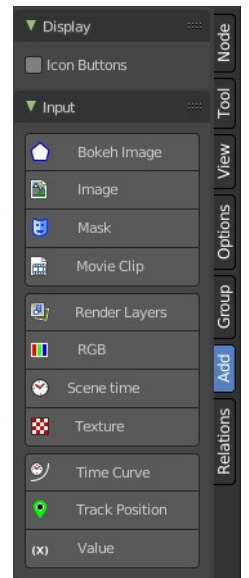
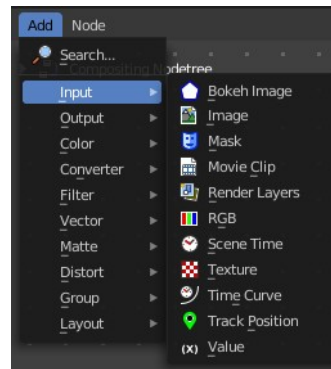

Usage

Click at one of the node buttons, then move the mouse into the viewport. The created node sticks at the mouse. Click again to release it.

Add tab - Display Panel

Icon Buttons

You can display the nodes in the panels either as text buttons or as pure icon buttons.





10.3.6 Editors - Compositor Editor - Sidebar - Relations tab

Table of content

Relations tab - Display Panel.....	1
Icon Buttons.....	1
Relations tab - Group Panel.....	1
Make Group.....	2
Group Insert.....	3
Usage.....	3
Group Input.....	3
Group Output.....	3
Toggle Edit Group.....	3
Ungroup.....	3
Relations tab - Node Group Panel.....	3
Relations tab - Layout Panel.....	3
Frame.....	3
Adding and Removing Nodes.....	4
Resizing Frame.....	4
Label and Color.....	4
Reroute.....	4
Move, Rotate, Scale.....	5

Relations tab - Display Panel

Icon Buttons

You can display the nodes in the panels either as text buttons or as pure icon buttons.

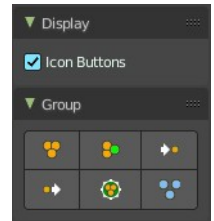

Relations tab - Group Panel

Node groups allows you to group different nodes of the material together to reduce the visual complexity. A node group acts like any other node.

Material node groups should not include Input nodes, like Image nodes, or Output nodes.

If you include a source node in your group, you will end up having the source node appearing twice: once inside the group, and once outside the group in the new material node tree.

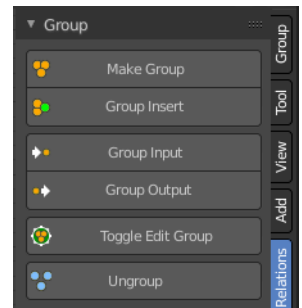

If you include an output node in the group, there will not be an output socket available from the group!

Make Group

Groups the selected nodes together.

Select the nodes that you want to group together. Choose Make Group. You will now see a green background. This indicates that the group is created, and that you are in edit mode for the group now.

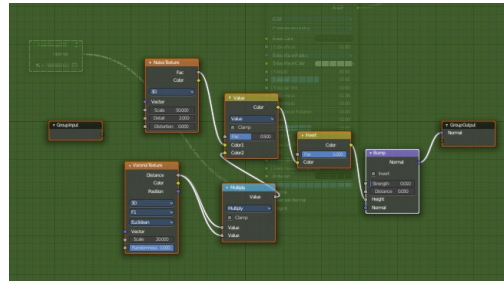
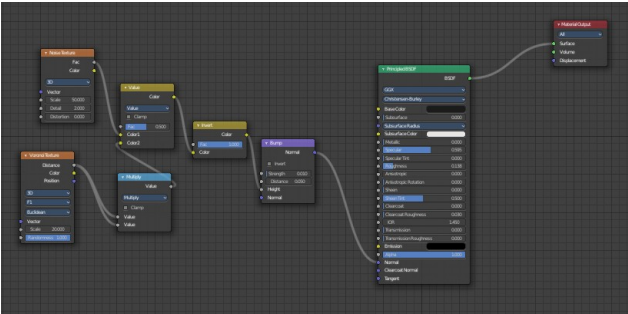

To exit the group edit mode press Tab key, or choose Toggle Edit Group menu item . That way you can also enter the Group Edit mode again.

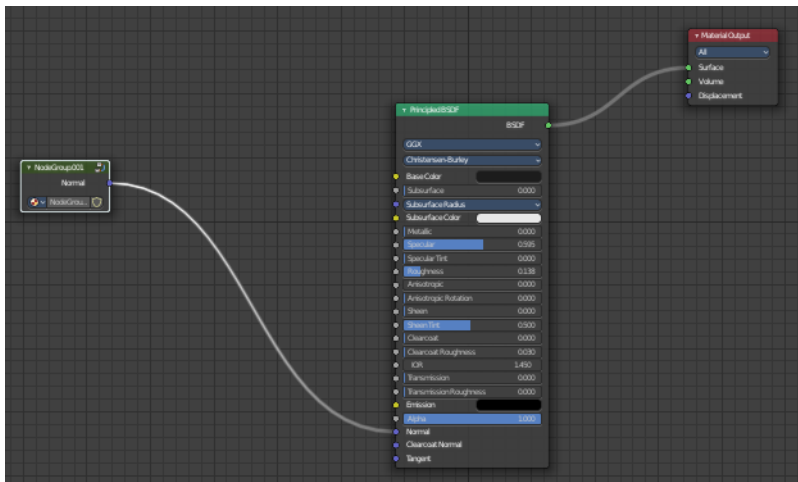

There is a third way to enter the group edit mode. Click at the right upper icon of the group node.

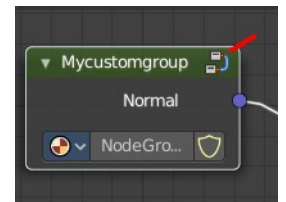

A group can be further collapsed by clicking at the triangle button in the upper left corner.

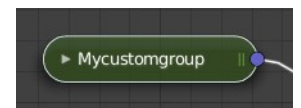

The group can be renamed in the sidebar in the Item tab and in the Properties tab in the Node panel.

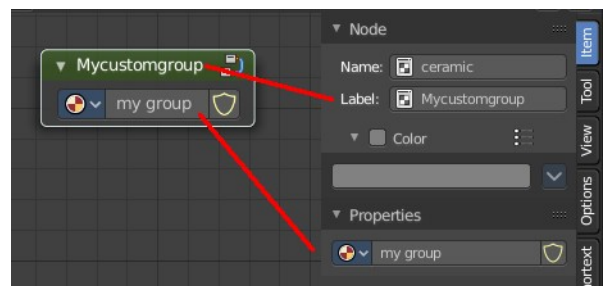

Group Insert

Inserts the selected node into the selected group.

Usage

Select the node.

Hold down shift, and select the group.

Click the Group Insert button. The node will now be part of the group, and you will land in group edit mode.

Press tab to exit the group edit mode.

Group Input

Adds a group input node.

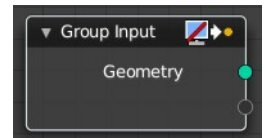

Group Output

Adds a group output node.

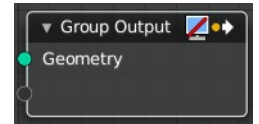

Toggle Edit Group

Enter or exit the edit group mode.

Ungroup

Ungroups an existing group. You need to be outside of the group edit mode.

Relations tab - Node Group Panel

When you create a node group, then this node group is listed here. And can be dragged from there for reuse too.

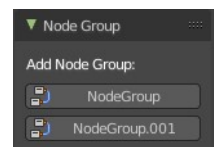

Relations tab - Layout Panel

These nodes help organizing the node layout.

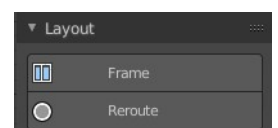

Frame

The Frame node allows you to drop nodes into a frame. This frame can be dragged around as a whole.

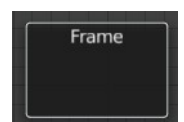

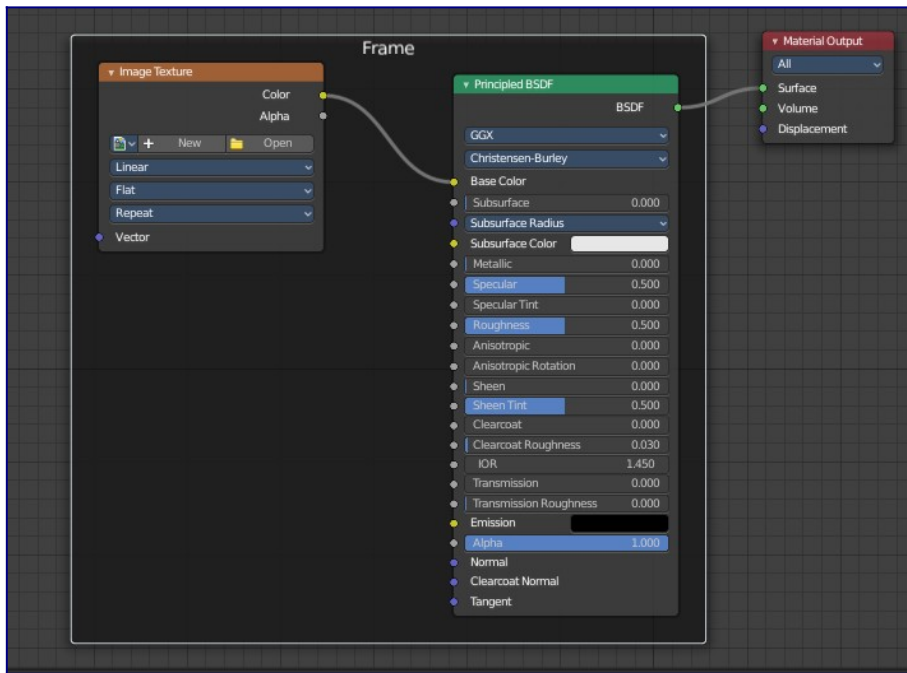

Adding and Removing Nodes

Nodes can be added by simply dropping them onto the frame. Or with the Join in New Frame menu item in the Node menu.

To remove a node from the frame use Remove from Frame.

Resizing Frame

When the Frame node is first placed in the node editor workspace you can resize it by dragging one of the edges.

Once a node is placed in the Frame, the Frame shrinks around the nodes. You cannot resize it anymore with handlers. Just by dragging around the nodes inside of the frame.

This behavior can be changed by disabling the *Shrink* option in the Item tab in the Properties panel. Then you can resize the frame again by dragging the edges.

Label and Color

You can change the name of a frame in the Node panel. And you can give it a custom color by checking the Color checkbox and adjusting the color then.

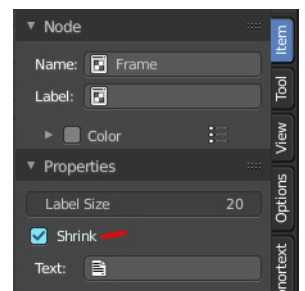
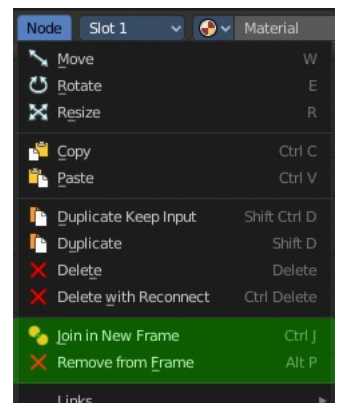

Reroute

Adds a reroute point that can be used to reroute connections. It allows just one input, but allows multiple output connections.

To quickly add a Reroute node into an existing connection, hold Shift and Right Mouse and drag the mouse to

cut through the link. A new reroute node will be added.

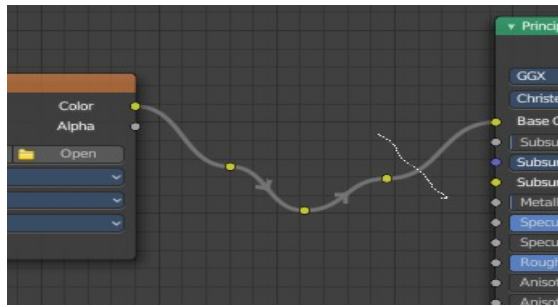
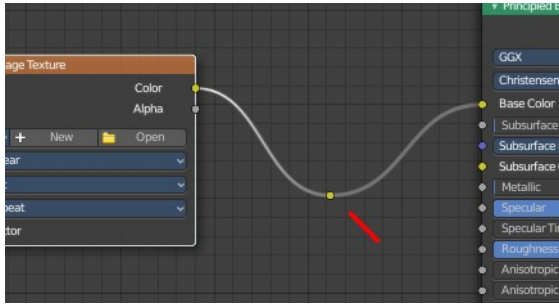

When you exceed a specific angle amount between the reroute nodes, then the node connection becomes a sharp corner, and not longer a Bezier like soft curve.

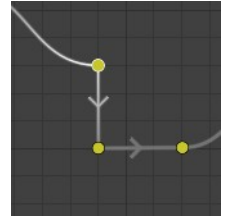

Move, Rotate, Scale

A normal node has a handler. The reroute dot not. You can't simply move it around with the mouse by clicking at the top area. It has none. You have to use the move, rotate and scale commands. They can be found in the View menu.

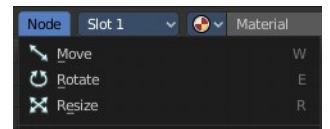



11 Editors - Texture Node Editor

Table of content

Texture Node Editor.....1

Texture Node Editor

The texture node system is in its current form legacy and will be replaced by a new system. Due to this, the manual is not up to date with the latest version of Blender and Bforartists. This editor is currently simply dysfunctional. And will most probably stay dysfunctional for a pretty while.



12 Editors - Geometry Node Editor

Table of content

Geometry Nodes Editor.....	2
Navigating in the Geometry Nodes Editor viewport.....	2
Hotkeys.....	2
Node drag search.....	3
Node context menu.....	3
Add.....	3
Find.....	3
Cut Links.....	4
Mute Links.....	4
Exit Group.....	4
Link to Viewer.....	4
Copy.....	4
Paste.....	4
Duplicate.....	4
Rename.....	4
Delete.....	4
Delete with Reconnect.....	4
Make Links.....	4
Make and Replace Links.....	5
Detach Links.....	5
Make Group.....	5
Insert into Group.....	6
Toggle Edit Group.....	6
Ungroup.....	6
Join new Frame.....	6
Remove from Frame.....	6
Rename.....	7
Select submenu.....	7
Grouped.....	7
Linked From.....	7
Linked To.....	7
Activate same type previous.....	7
Activate same type next.....	7
Show/Hide submenu.....	7
Hide.....	7
Toggle Node Mute.....	7
Toggle Node Preview.....	8
Toggle hidden node sockets.....	8
Toggle Node Options.....	8
Collapse and Hide Unused Sockets.....	8
Toggle Node Options.....	8
Collapse and Hide Unused Sockets.....	8
Quick Favorites menu.....	9

Geometry Nodes Editor

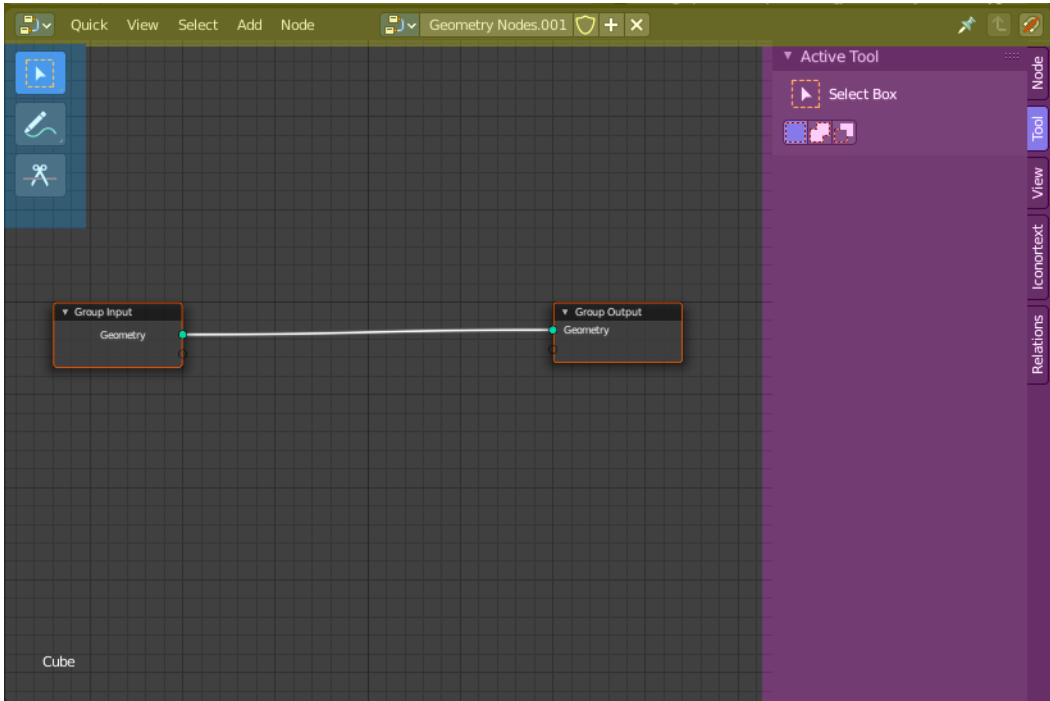

The geometry node editor is an editor where you can modify the geometry of objects by nodes.

When you add a node then a modifier gets added too. Geometry nodes are tied to this modifier.

The editor is divided into several areas has several tool areas.

Yellow – Header

Blue - Tool Shelf

Pink - Sidebar

Note that the shader editor does not have a tool area above the header. All tool settings are in the sidebar in the Tool tab.

The node editor displays a breadcrumb at the upper left when a geometry node tree exists. It is just a visual hint, and has no further functionality.

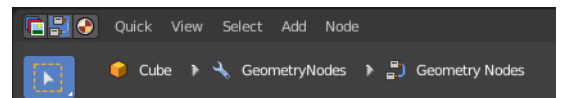
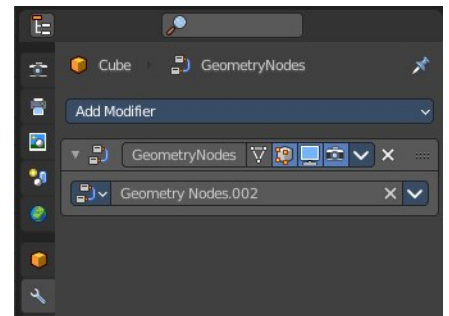

Navigating in the Geometry Nodes Editor viewport

Hotkeys

Pan the view - MMB

Zoom - Mouse Wheel, MMB+CTRL, Numpad + / -

View All - Home

Node drag search

When you grab a node input or output, drag it around, and release it in the empty space, then you will get a search menu with the available nodes that fits to this input or output.

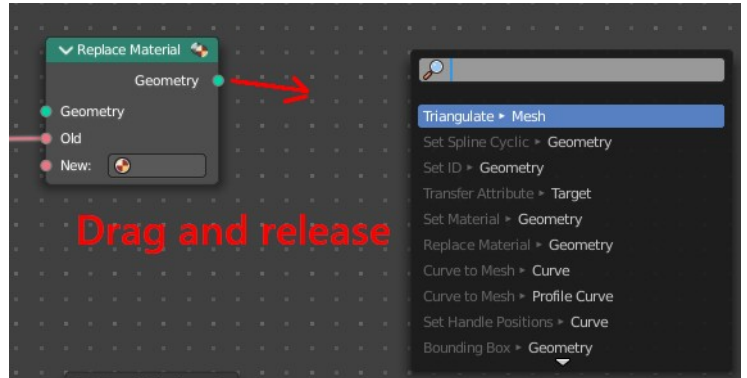

Node context menu

When you double right click into the viewport, then you will open a menu. The UV Context menu. Its content is to 100% double content to already existing menus. And it is despite the name not contextual. It does though show different content under different circumstances.

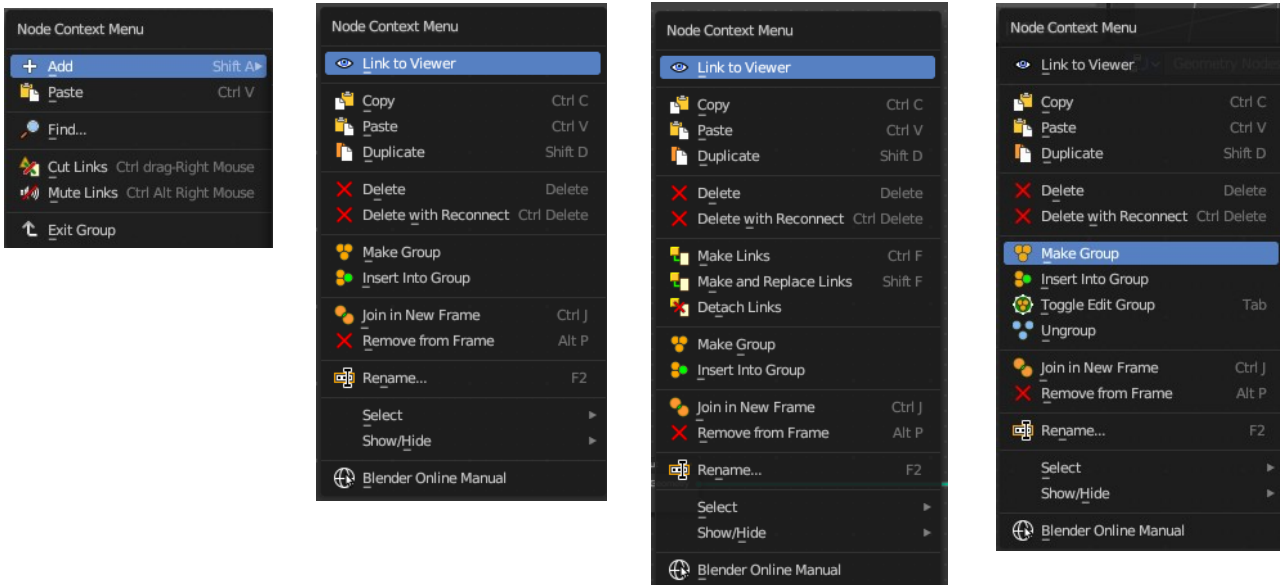

Add

The whole add menu from the header.

Find

Search for nodes, and hilight them. When you are in a node group then it lists the content of the node

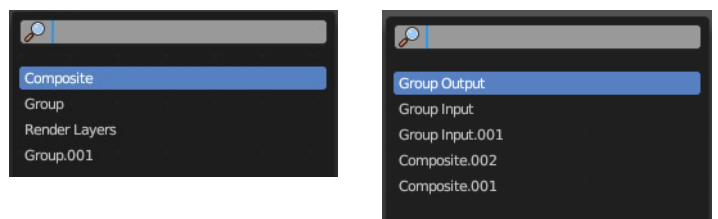

group.

Cut Links

Calls a cut tool with which you can cut links between nodes

Mute Links

Calls a cut tool with which you mute cut links between nodes. To unmute the links use the same tool again.

Exit Group

Same as Edit Group. When you are in a group then you can end editing with this operator.

Link to Viewer

Adds a viewer node to the selected node.

Copy

Copies the selected nodes.

Paste

Pastes the copied nodes.

Duplicate

Duplicates the selected nodes.

Rename

Allows you to rename the current active node. A popup opens up where you can type in another name.

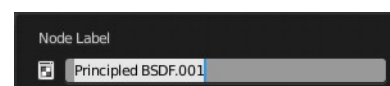

Delete

Deletes the selected nodes. All Connections gets removed.

Delete with Reconnect

Deletes the selected nodes. Existing connections gets bypassed as if the node would not have existed.

Make Links

Shows when you have at least two nodes connected.

Tries to connect nodes where it makes sense. For example, the BSDF output of a Principled shader with the Surface input of the Material Output node.

Make and Replace Links

Shows when you have at least two nodes connected.

Same as Make Links. But it will replace existing links.

Detach Links

Shows when you have at least two nodes connected.

Removes all connections from the selected node, but tries to reconnect the remaining nodes.

Make Group

Groups the selected nodes together.

Select the nodes that you want to group together. Choose Make Group. You will now see a green background. This indicates that the group is created, and that you are in edit mode for the group now.

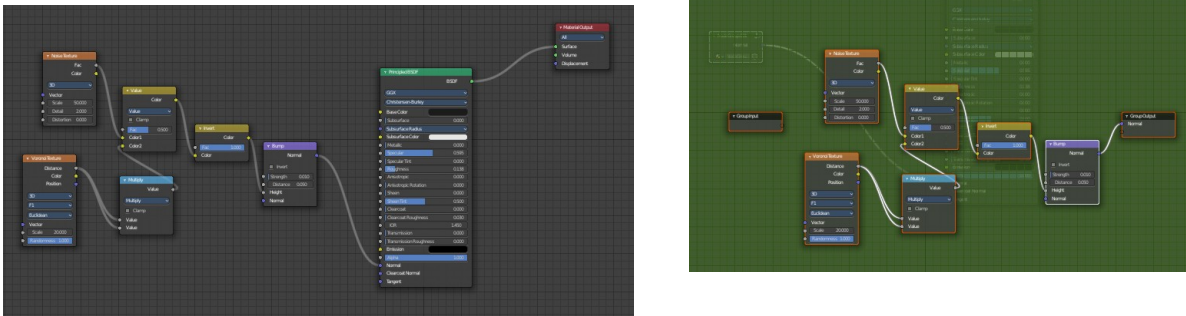

To exit the group edit mode press Tab key, or choose Toggle Edit Group menu item in the sidebar in the Relations tab in the Group panel. That way you can also enter the Group Edit mode again.

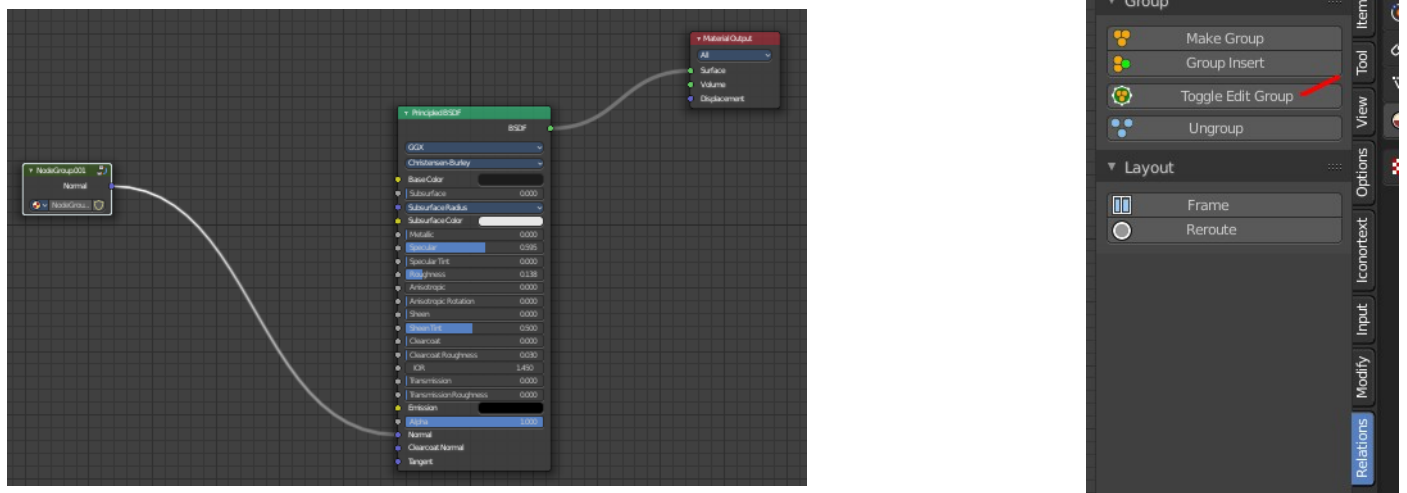

There is a third way to enter the group edit mode. Click at the right upper icon of the group node.

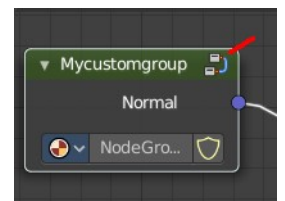

A group can be further collapsed by clicking at the triangle button in the upper left corner.

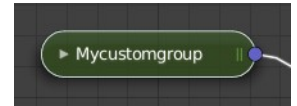

The group can be renamed in the sidebar in the Item tab and in the Properties tab in the Node panel.

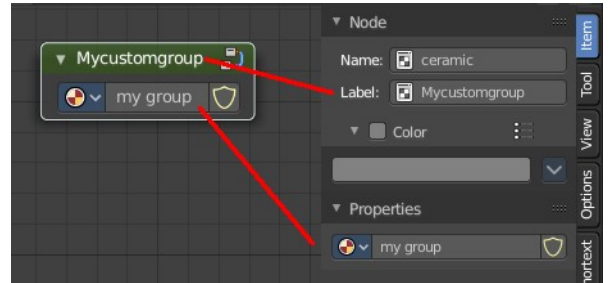

Insert into Group

Allows you to insert a node into a node group.

Select the node, hold down Shift, then select the node group so that both are selected. Then perform the operator.

Toggle Edit Group

Enters a node group for editing. Or when you are in a node group, exits the node group editing.

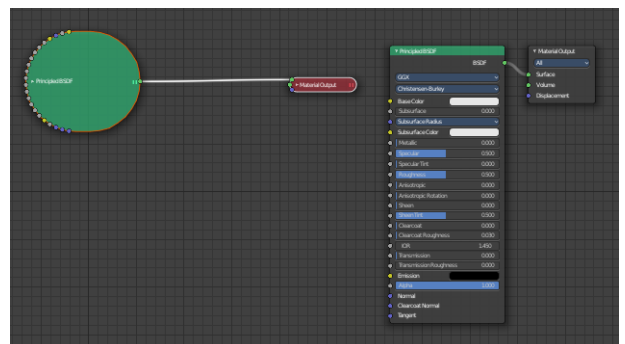

Ungroup

Removes the selected nodes from a group.

Join new Frame

Frame node functionality. Adds the selected node to a frame.

Remove from Frame

Frame node functionality. Removes the selected node from a frame.

Rename

Allows you to rename a node.

Select submenu

Grouped

Select grouped nodes.

Linked From

Select the nodes that are linked from the currently selected nodes. The nodes before in the hierarchy.

Linked To

Select the nodes that are linked to the currently selected nodes. The nodes behind in the hierarchy.

Activate same type previous

Activate same node type before the current selection, step by step.

Activate same type next

Activate same node type after the current selection, step by step.

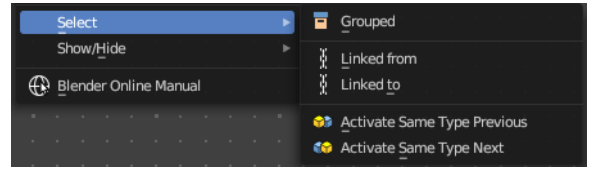

Show/Hide submenu

Here you find hide options to make the display of nodes more compact.

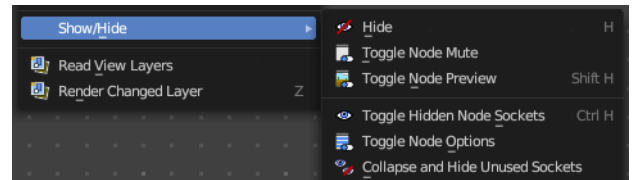

Demonstration happens at an image node.

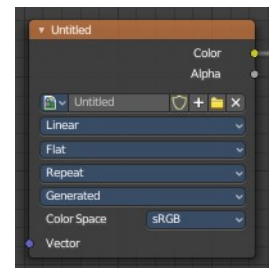

Hide

Hides everything but input and output dots. To view the full node again perform the operator again. It's a toggle. Or click at the triangle left besides the node name.

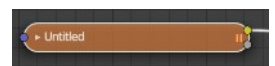

Toggle Node Mute

Deactivates the node.

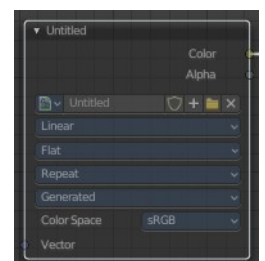

Toggle Node Preview

This is a compositor feature for the preview image. It does not belong here, but shares the same menu. It shows or hides the preview image.

Toggle hidden node sockets

Toggles away the unused node sockets. In this case the vector input node socket and the alpha output node socket will be hidden.

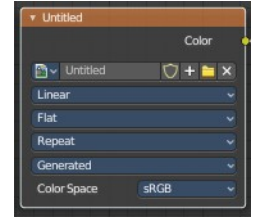

Toggle Node Options

Hides away the properties.

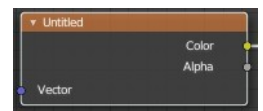

Collapse and Hide Unused Sockets

Like Hide. Hides everything but the node sockets. But it also hides the unused node sockets.

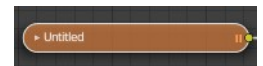

Toggle Node Options

Shows or hides the node options.

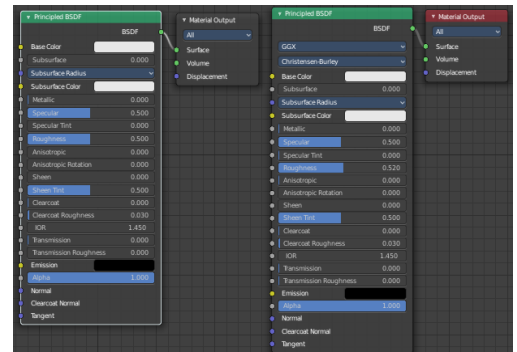

Collapse and Hide Unused Sockets

Shows or hides unused sockets.

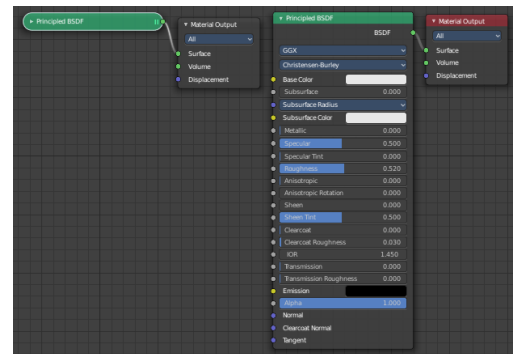

Quick Favorites menu

When you right click at a menu or a button, then a right click menu will open. Tools have usually a Add to Quick Favorites menu entry.

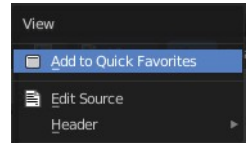

The Quick Favorites Menu is empty by default. With Add to Quick favorites you can add this menu to the Quick menu.

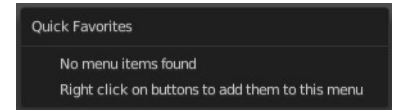

In the 3D view we have a menu called Quick in the header, which shows this content then. In the Image Editor you can just call it with its hotkey. Q. It has no regular menu entry here.



12.1.1 Editors - Geometry Nodes Editor - Header - Tools and Options

Table of content

Introduction.....	1
Header Tabs.....	1
Geometry Nodes Prop.....	1
Data Browser.....	2
Edit box.....	2
Add Fake User.....	2
User.....	2
Remove.....	2
Options.....	2
Pin (pin icon).....	2
Parent Node Tree.....	2
Snap.....	3
Geometry node Overlays.....	3
Show Overlays.....	3
Node Editor Overlays.....	3
Wire Colors.....	3
Context Path.....	3
Annotations.....	3
Timings.....	3
Named Attributes.....	3

Introduction

This chapter here is about the tools, modes and options elements in the header of the geometry nodes editor.

The text menus are covered in a own chapter each. They vary too much, dependent of mode and object type.

Header Tabs

The tabs at the very left allows you to switch between the most important node editor types by one click. Compositor Editor, Geometry Nodes Editor and Shader Editor.

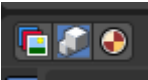

Geometry Nodes Prop

Manage the nodes. If there is no geometry node tree for the current object, then you will see the New button

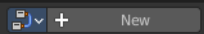

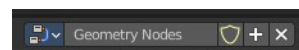

Data Browser

The list of available geometry node trees in the scene.

Edit box

The name of the current active geometry node tree. Here you can also rename the node tree.

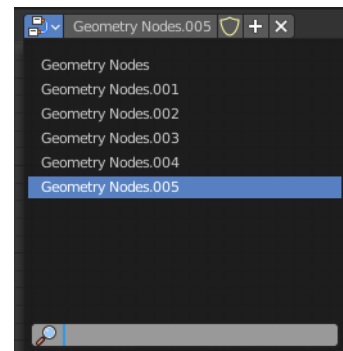

Add Fake User

With this button you assign a fake user to this selected geometry node tree.

Data, like node trees, that is not longer linked to anything else gets removed when you save and reload a scene. Bforartists has the concept of fake users to go around this behavior. An image with a fake user is in fact linked to something. And so it is not lost when you save and reload the scene.

User

The number of users that uses this data. Data with a user number of 0 will be removed with closing Bforartists.

Remove

Removes the geometry node tree. To delete it completely you need to purge it. See Fake user.

Options

At the right side you will see some options.



Pin (pin icon)

The pin button will keep the current node tree selection fixed. When a node tree is pinned, it will remain visible in the shader editor even when another object is selected.

Parent Node Tree

Grouping nodes can simplify a node tree by allowing instancing and hiding parts of the tree. Nodes can be grouped. This button becomes active when you work with such grouped nodes, and you are in a child group. It allows you to switch to the parent group.

Snap

Activates snapping. When the tool is activated, then you will also reveal the snap settings where you can choose different snap methods.

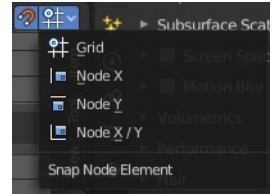

Geometry node Overlays

Show Overlays

Show or hide the overlays.

Node Editor Overlays

Wire Colors

Show the colors at the noodles.

Context Path

Show the breadcrumb up left.

Annotations

Show Annotations.

Timings

Shows a timing box above each node to indicate the evaluation time of it.

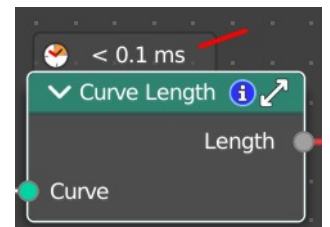
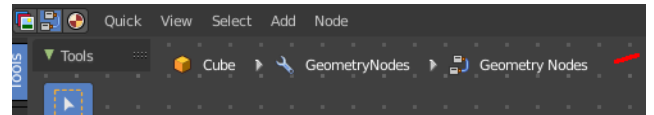
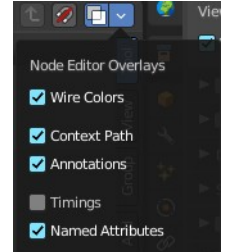

Named Attributes

Adds an overlay that helps users to see where named attributes are used with node groups

This helps to see where named attributes are used.

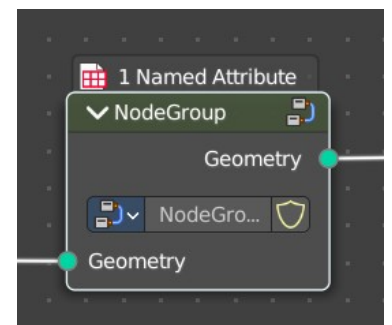

12.1.10 Editors - Geometry Nodes Editor - Header - Add Menu - Output

Table of content

Detailed table of content.....	1
Add menu - Output.....	1
Viewer.....	1

Detailed table of content

Detailed table of content

Detailed table of content.....	1
Add menu - Output.....	1
Viewer.....	1
Inputs.....	1
Geometry.....	1

Add menu - Output

Here you find nodes that outputs data.



Viewer

This node allows you to output the geometry data of a node in the node tree to the spreadsheet editor.

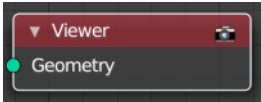

Inputs

Geometry

Standard geometry input.



12.1.11 Editors - Geometry Nodes Editor - Header - Add Menu - Geometry - Read

Table of content

Detailed table of content.....	1
Add menu - Geometry - Read.....	2
ID.....	2
Index.....	2
Named Attribute.....	2
Normal.....	3
Position.....	4
Radius.....	4

Detailed table of content

Detailed table of content

Detailed table of content.....	1
Add menu - Geometry - Read.....	2
ID.....	2
Outputs.....	2
ID.....	2
Index.....	2
Outputs.....	2
Index.....	2
Named Attribute.....	2
Input.....	3
Name.....	3
Input.....	3
Data Type.....	3
Output.....	3
Attribute.....	3
Normal.....	3
Face.....	3
Mesh Vertices.....	3
Edge.....	3
Face Corner.....	3
Curve Control Points.....	3
Warning!.....	3
Outputs.....	4
Normal.....	4
Position.....	4
Outputs.....	4
Position.....	4
Radius.....	4
Outputs.....	4
Radius.....	4

Add menu - Geometry - Read

Here you find nodes to modify the geometry.

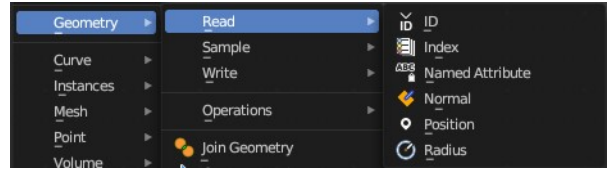

ID

Retrieve the ID of the object.

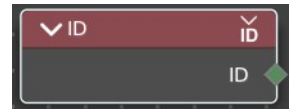

Outputs

ID

The ID of the object.

Index

Retrieves an integer value indicating the position of each element in the list. This list depends on the internal order of the data in the geometry, which is not necessarily visible in the 3D Viewport. However, the index value is visible in the left-most column in the Spreadsheet Editor.

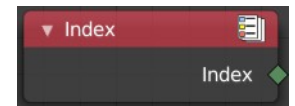

Outputs

Index

Integer value which enumerates each point on the geometry.

Named Attribute

Adds a field input.

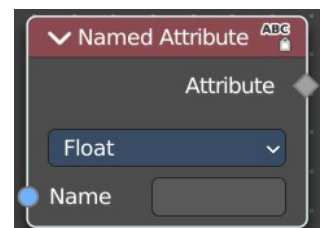

Input

Name

The input name for the field.

Input

Data Type

What data type to use.

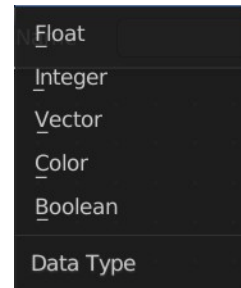

Output

Attribute

The output attribute name.

Normal

Returns a vector for each evaluated point indicating the normal direction. The output can depend on the attribute domain used in the node evaluating the field, but the output is always a normalized unit vector.

The output depends on where you plug in the normal node.

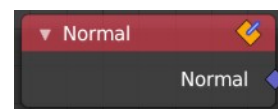

Face

On the face domain, the normal is the “up” direction of the face.

Mesh Vertices

For mesh vertices, the normal is an average of the surrounding face normals. If the vertex does not have any connected faces, the output is simply the normalized position of that vertex.

Edge

The normal output for each edge is the average of the edge’s two vertex normals.

Face Corner

The output for each face corner is the same as the face normal of the corresponding face.

Curve Control Points

The output of this node when used for curve geometry is the evaluated normal of the curve, which depends on the twist method. The normal vector is always perpendicular to the direction of the curve’s path at every point.

Warning!

Please keep in mind that for NURBS and Bézier spline curves the value retrieved from this node is the value at

every control point. Which may not correspond to the visible evaluated points. For NURBS splines the difference may be even more pronounced and the result may not be as expected. A Resample Curve Node can be used to create a poly spline, where there is a control point for every evaluated point.

Outputs

Normal

The normal vector output.

Position

The Position node outputs a vector of each point of the geometry the node is connected to.

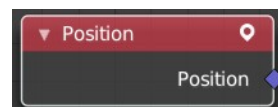

The node can work on geometry domains besides points. In that case, the position data will be automatically interpolated to the new domain. For example, when used as part of the input to the mesh edge split node, the position for each edge will be the average position of the edges two vertices.

For instances, the output is the origin of each instance. However, if the node is for a geometry node that adjusts data inside instances, the position output of this node will be in the local space of each instance.

Outputs

Position

The position vector output.

Radius

Retrieve the radius of the object.

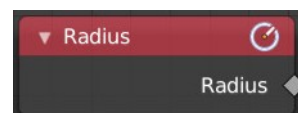

Outputs

Radius

The radius output.



12.1.12 Editors - Geometry Nodes Editor - Header - Add Menu - Geometry - Sample

Table of content

Detailed table of content.....	1
Add menu - Geometry - Sample.....	2
Geometry Proximity.....	2
Index of Nearest.....	3
Raycast.....	4
Sample Index.....	5
Sample Nearest.....	6

Detailed table of content

Detailed table of content

Detailed table of content.....	1
Add menu - Geometry - Sample.....	2
Geometry Proximity.....	2
Inputs.....	2
Target.....	2
Result.....	2
Position.....	2
Properties.....	3
Target Geometry.....	3
Outputs.....	3
Position.....	3
Distance.....	3
Index of Nearest.....	3
Inputs.....	3
Position.....	3
Group ID.....	3
Outputs.....	3
Index.....	3
Has Neighbor.....	3
Raycast.....	4
Inputs.....	4
Target Geometry.....	4
Attribute.....	4
Source Position.....	4
Ray Direction.....	4
Ray Length.....	4
Properties.....	4
Data Type.....	4
Mapping.....	4
Output.....	4
Is Hit.....	4
Hit Position.....	4
Hit Normal.....	5

Hit Distance.....	5
Attribute.....	5
Sample Index.....	5
Inputs.....	5
Geometry.....	5
Value.....	5
Index.....	5
Properties.....	5
Data Type.....	5
Domain.....	5
Clamp.....	6
Output.....	6
Value.....	6
Sample Nearest.....	6
Inputs.....	6
Geometry.....	6
Sample Position.....	6
Properties.....	6
Domain.....	6
Output.....	6
Index.....	6

Add menu - Geometry - Sample

Here you find nodes to modify the geometry.

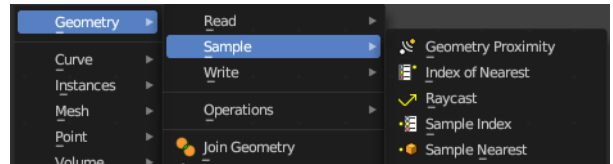

Geometry Proximity

This node finds the closest position on the target for each point in the input geometry.

Inputs

Target

The target object.

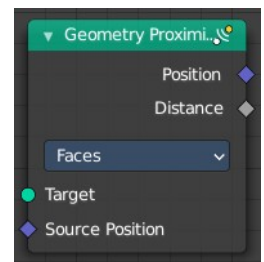

Result

Name of the attribute where the output is stored. If the attribute does not exist yet, it is created.

Position

The position where the computed location is stored.

Properties

Target Geometry

The element of the target geometry to calculate the distance from.

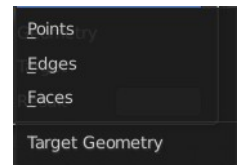

Outputs

Position

Closest location on the surface of the target mesh, or the closest point in the target point cloud in Points mode.

Distance

Distance from the source position to the closest location in the target.

Index of Nearest

Retrieve values from specific geometry elements.

Inputs

Position

The position of the nearest element.

Group ID

The group ID of the nearest element.

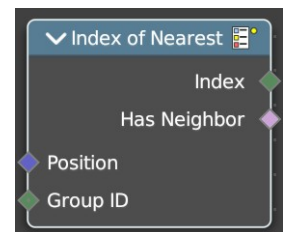

Outputs

Index

The Index of the nearest element.

Has Neighbor

Has this element a neighbor.

Raycast

This node sends a raycast and retrieves data from the hit target.

Inputs

Target Geometry

This is actually the source object that sends the ray.

Attribute

Attribute input.

Source Position

Source position input.

Ray Direction

A vector 3 for the ray direction.

Ray Length

The length of the ray.

Properties

Data Type

What data to calculate on hit.

Mapping

Mapping from the target geometry to hit points. Interpolated or nearest.

Output

Is Hit

Has the raycast hit something?

Hit Position

The hit position if any.

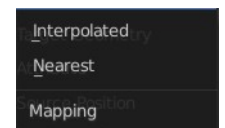
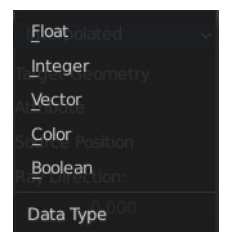
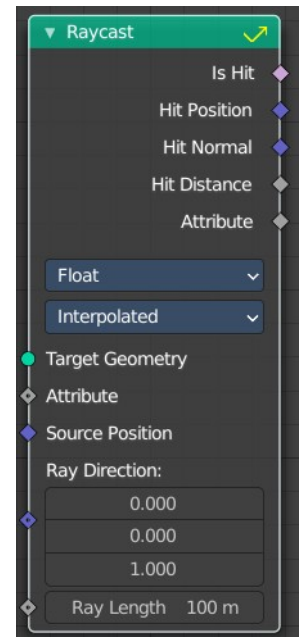

Hit Normal

The normal of the hit point.

Hit Distance

The distance of the hit point.

Attribute

The attribute of the hit object.

Sample Index

Retrieve values from specific geometry elements.

Inputs

Geometry

The source object to take the data from.

Value

The value to retrieve.

Index

The index position of the value.

Properties

Data Type

The type for the source and result data.

Domain

What kind of data to process.

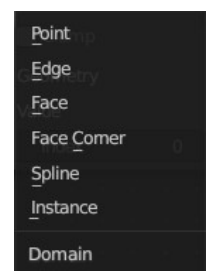
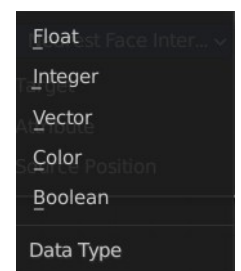
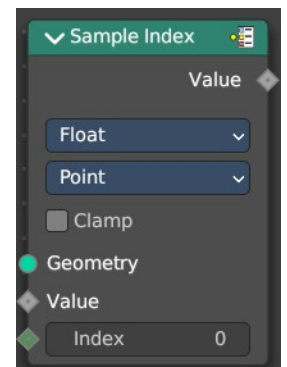

Clamp

Clamp the indices to the size of the attribute domain.

Output

Value

The output value.

Sample Nearest

Retrieves the element of a geometry closest to a position.

Inputs

Geometry

The source object to take the data from.

Sample Position

The position of the source object.

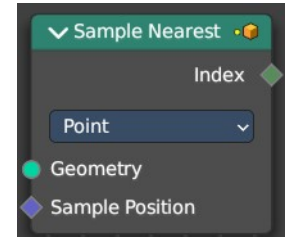

Properties

Domain

What data to process.

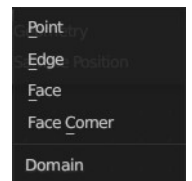

Output

Index

The index output.

12.1.13 Editors - Geometry Nodes Editor - Header - Add Menu - Geometry - Write

Table of content

- Detailed table of content.....1
- Add menu - Geometry - Write.....1
 - Set ID.....1
 - Set Position.....2

Detailed table of content

Detailed table of content

- Detailed table of content.....1
- Add menu - Geometry - Write.....1
 - Set ID.....1
 - Inputs.....2
 - Geometry.....2
 - Selection.....2
 - ID.....2
 - Outputs.....2
 - Geometry.....2
 - Set Position.....2
 - Inputs.....2
 - Geometry.....2
 - Selection.....2
 - Position.....2
 - Offset.....2
 - Outputs.....3
 - Geometry.....3

Add menu - Geometry - Write

Here you find nodes to modify the geometry.

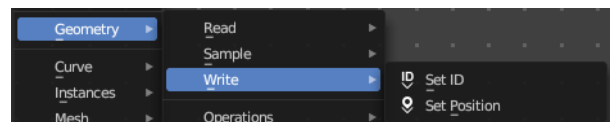

Set ID

Sets the ID of the target geometry.

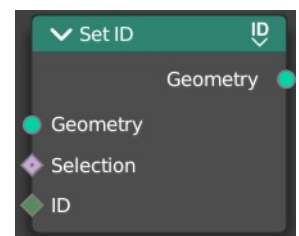

Inputs

Geometry

Geometry input.

Selection

Selection input.

ID

ID Input

Outputs

Geometry

Geometry output.

Set Position

The Set Position node controls the location of each point, the same way as controlling the position attribute. If the input geometry contains instances, this node will affect the location of the origin of each instance.

The input node for this data is the Position Node.

Inputs

Geometry

Geometry input.

Selection

Whether or not to change the position of each point or instance. True values mean the position will be changed, false values mean it will remain the same.

Position

The new position for selected elements. By default, this is the same as if the Position Node was connected, meaning the node will do nothing.

Offset

An optional translation for each point. This is evaluated at the same time as the Position input, meaning that fields evaluated for it will not reflect the changed position.

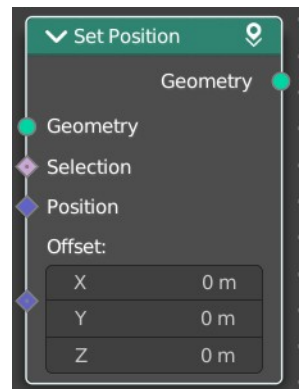

Outputs

Geometry

Geometry outputs.



12.1.13 Editors - Geometry Nodes Editor - Header - Add Menu - Geometry - Operations

Table of content

Detailed table of content.....	1
Add menu - Geometry - Operations.....	3
Bounding Box.....	3
Convex Hull.....	3
Delete Geometry.....	4
Duplicate Elements.....	4
Merge by Distance.....	5
Transform Geometry.....	6
Separate Components.....	7
Separate Geometry.....	7

Detailed table of content

Detailed table of content

Detailed table of content.....	1
Add menu - Geometry - Operations.....	3
Bounding Box.....	3
Inputs.....	3
Geometry.....	3
Output.....	3
Bounding Box.....	3
Min.....	3
Max.....	3
Convex Hull.....	3
Inputs.....	3
Geometry.....	3
Output.....	4
Convex Hull.....	4
Delete Geometry.....	4
Inputs.....	4
Geometry.....	4
Selection.....	4
Properties.....	4
Domain.....	4
Mode.....	4
Output.....	4
Geometry.....	4
Duplicate Elements.....	4
Inputs.....	4
Geometry.....	4
Selection.....	5
Amount.....	5
Properties.....	5
Domain.....	5

Output.....	5
Geometry.....	5
Duplicate Index.....	5
Merge by Distance.....	5
Input.....	5
Geometry.....	5
Selection.....	5
Distance.....	5
Properties.....	6
Mode.....	6
All.....	6
Connected.....	6
Output.....	6
Geometry.....	6
Transform Geometry.....	6
Inputs.....	6
Geometry.....	6
Translation.....	6
Rotation.....	6
Scale.....	6
Output.....	6
Geometry.....	6
Separate Components.....	7
Inputs.....	7
Geometry.....	7
Outputs.....	7
Mesh.....	7
Point Cloud.....	7
Curve.....	7
Volume.....	7
Instance.....	7
Separate Geometry.....	7
Inputs.....	7
Geometry.....	7
Selection.....	7
Properties.....	8
Domain.....	8
Outputs.....	8
Selection.....	8
Inverted.....	8

Add menu - Geometry - Operations

Here you find nodes to modify the geometry.

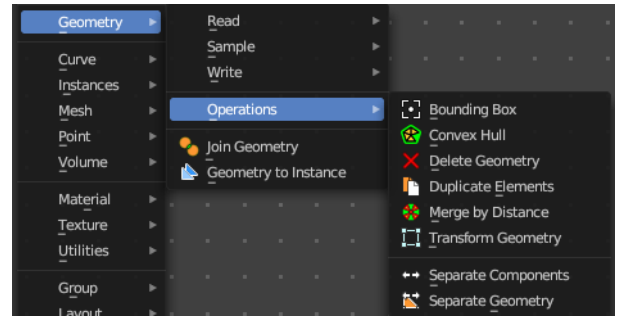

Bounding Box

The Bounding Box geometry node allows you to work with the values of a bounding box.

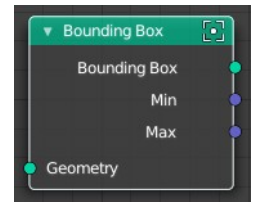

Inputs

Geometry

Standard geometry input.

Output

Bounding Box

Standard output.

Min

The minimum values of the bounding box.

Max

The maximum values of the bounding box.

Convex Hull

The node allows you to work with the values of a convex hull of this object.

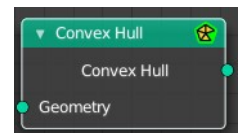

Inputs

Geometry

Standard geometry input.

Output

Convex Hull

Standard output.

Delete Geometry

The node allows you to work with the values of a convex hull of this object.

Inputs

Geometry

Standard geometry input.

Selection

A selection of the geometry

Properties

Domain

What element to delete.

Mode

Delete mode. Names should be self explaining.

Output

Geometry

Standard output.

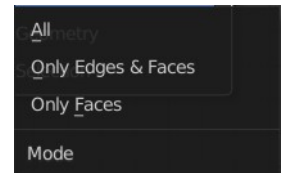
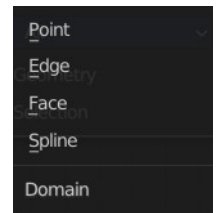
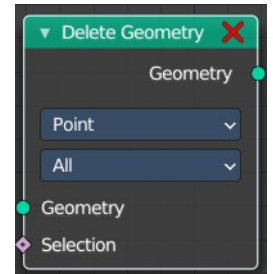

Duplicate Elements

Duplicates a part of a geometry a dynamic number of times.

Inputs

Geometry

Standard geometry input.

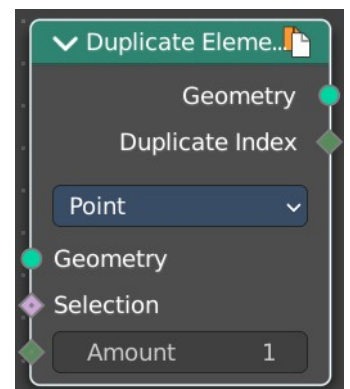

Selection

A selection of the geometry.

Amount

Number of times the geometry should be duplicated.

Properties

Domain

What element to duplicate.

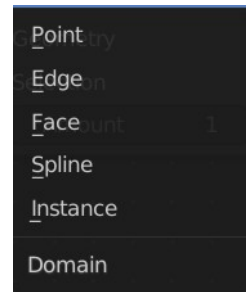

Output

Geometry

Standard output.

Duplicate Index

The index of the duplicated elements.

Merge by Distance

Welds the selected geometry below a given distance into one vertice.

Input

Geometry

The input geometry.

Selection

A selection of the input geometry.

Distance

The merge distance. Everything below this distance will be merged into one vertice.

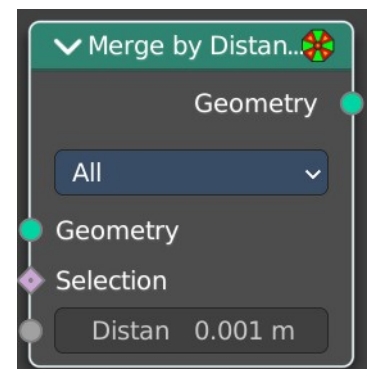

Properties

Mode

All

Merges all vertices in reach.

Connected

Merges just vertices that are connected by edges.

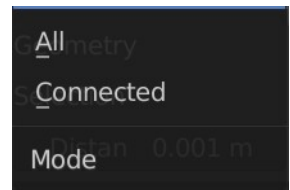

Output

Geometry

The output geometry.

Transform Geometry

Move, rotate or scale the geometry. The transformation is applied to the entire geometry, and not per element. For example, you can not rotate individual point cloud points with this node.

Inputs

Geometry

Standard geometry input.

Translation

Translates the geometry in local space of the modified object.

Rotation

Euler rotation in local space.

Scale

Scale to transform the geometries in local space.

Output

Geometry

Standard geometry output.

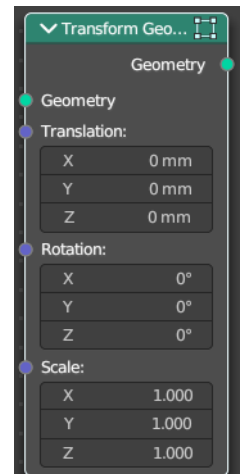

Separate Components

Splits a geometry into its components.

Inputs

Geometry

Geometry input.

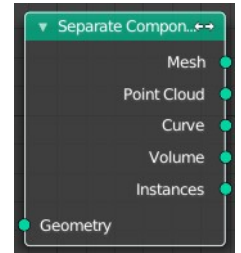

Outputs

Mesh

Mesh component of the input geometry.

Point Cloud

Point cloud component of the input geometry.

Curve

Curve component of the input geometry.

Volume

Volume component of the input geometry.

In case that the input contains multiple volume instances, only the first volume component will be calculated.

Instance

The single instances of the geometry.

Separate Geometry

Separates a selection of a geometry into its own object.

Tip: when you combine it with the Compare Floats node then you get a more precise control of which parts are separated to a given output geometry.

Inputs

Geometry

Geometry input.

Selection

Selection input.

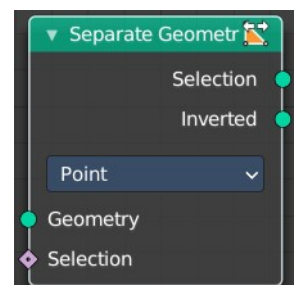

Properties

Domain

What kind of geometry to separate.

Note that when selecting a domain that doesn't modify all components, the unmodified components will appear in both outputs.

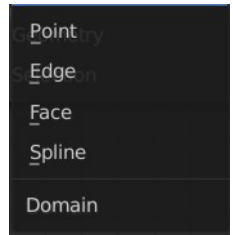

Outputs

Selection

Separated selection.

Inverted

The inverted separated selection.

12.1.15 Editors - Geometry Nodes Editor - Header - Add Menu - Geometry

Table of content

Detailed table of content.....	1
Add menu - Geometry.....	4
Bounding Box.....	4
Convex Hull.....	5
Delete Geometry.....	5
Duplicate Elements.....	6
Merge by Distance.....	6
Geometry to Instance.....	7
Geometry Proximity.....	7
Join Geometry.....	8
Raycast.....	9
Sample Index.....	10
Sample Nearest.....	11
Separate Components.....	11
Separate Geometry.....	12
Transform Geometry.....	13
Set ID.....	13
Set Position.....	14

Detailed table of content

Detailed table of content

Detailed table of content.....	1
Add menu - Geometry.....	4
Bounding Box.....	4
Inputs.....	4
Geometry.....	4
Output.....	4
Bounding Box.....	4
Min.....	4
Max.....	5
Convex Hull.....	5
Inputs.....	5
Geometry.....	5
Output.....	5
Convex Hull.....	5
Delete Geometry.....	5
Inputs.....	5
Geometry.....	5
Selection.....	5
Properties.....	5
Domain.....	5
Mode.....	5
Output.....	5

Geometry.....	5
Duplicate Elements.....	6
Inputs.....	6
Geometry.....	6
Selection.....	6
Amount.....	6
Properties.....	6
Domain.....	6
Output.....	6
Geometry.....	6
Duplicate Index.....	6
Merge by Distance.....	6
Input.....	7
Geometry.....	7
Selection.....	7
Distance.....	7
Properties.....	7
Mode.....	7
All.....	7
Connected.....	7
Output.....	7
Geometry.....	7
Geometry to Instance.....	7
Inputs.....	7
Geometry.....	7
Outputs.....	7
Instances.....	7
Geometry Proximity.....	7
Inputs.....	8
Target.....	8
Result.....	8
Position.....	8
Properties.....	8
Target Geometry.....	8
Outputs.....	8
Position.....	8
Distance.....	8
Join Geometry.....	8
Inputs.....	8
Geometry.....	8
Output.....	8
Geometry.....	8
Raycast.....	9
Inputs.....	9
Target Geometry.....	9
Attribute.....	9
Source Position.....	9
Ray Direction.....	9
Ray Length.....	9
Properties.....	9
Data Type.....	9
Mapping.....	9
Output.....	9

Is Hit.....	9
Hit Position.....	9
Hit Normal.....	10
Hit Distance.....	10
Attribute.....	10
Sample Index.....	10
Inputs.....	10
Geometry.....	10
Value.....	10
Index.....	10
Properties.....	10
Data Type.....	10
Domain.....	10
Clamp.....	10
Output.....	11
Value.....	11
Sample Nearest.....	11
Inputs.....	11
Geometry.....	11
Sample Position.....	11
Properties.....	11
Domain.....	11
Output.....	11
Index.....	11
Separate Components.....	11
Inputs.....	11
Geometry.....	11
Outputs.....	11
Mesh.....	11
Point Cloud.....	12
Curve.....	12
Volume.....	12
Instance.....	12
Separate Geometry.....	12
Inputs.....	12
Geometry.....	12
Selection.....	12
Properties.....	12
Domain.....	12
Outputs.....	12
Selection.....	12
Inverted.....	12
Transform Geometry.....	13
Inputs.....	13
Geometry.....	13
Translation.....	13
Rotation.....	13
Scale.....	13
Output.....	13
Geometry.....	13
Set ID.....	13
Inputs.....	13
Geometry.....	13

Selection.....	13
ID.....	13
Outputs.....	14
Geometry.....	14
Set Position.....	14
Inputs.....	14
Geometry.....	14
Selection.....	14
Position.....	14
Offset.....	14
Outputs.....	14
Geometry.....	14

Add menu - Geometry

Here you find nodes to modify the geometry.

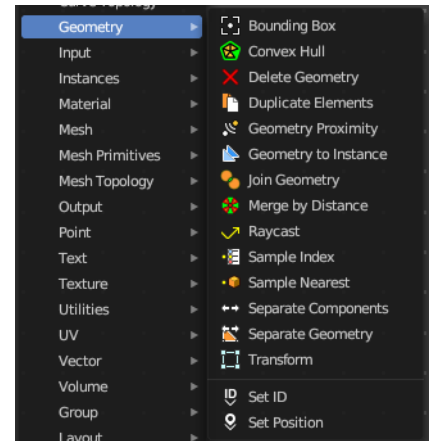

Bounding Box

The Bounding Box geometry node allows you to work with the values of a bounding box.

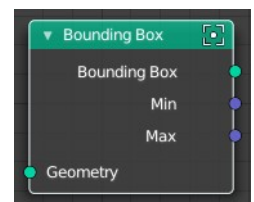

Inputs

Geometry

Standard geometry input.

Output

Bounding Box

Standard output.

Min

The minimum values of the bounding box.

Max

The maximum values of the bounding box.

Convex Hull

The node allows you to work with the values of a convex hull of this object.

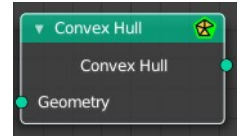

Inputs

Geometry

Standard geometry input.

Output

Convex Hull

Standard output.

Delete Geometry

The node allows you to work with the values of a convex hull of this object.

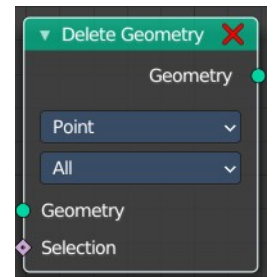

Inputs

Geometry

Standard geometry input.

Selection

A selection of the geometry

Properties

Domain

What element to delete.

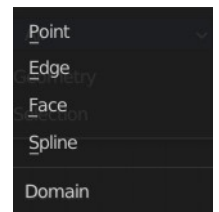

Mode

Delete mode. Names should be self explaining.

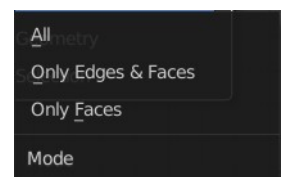

Output

Geometry

Standard output.

Duplicate Elements

Duplicates a part of a geometry a dynamic number of times.

Inputs

Geometry

Standard geometry input.

Selection

A selection of the geometry.

Amount

Number of times the geometry should be duplicated.

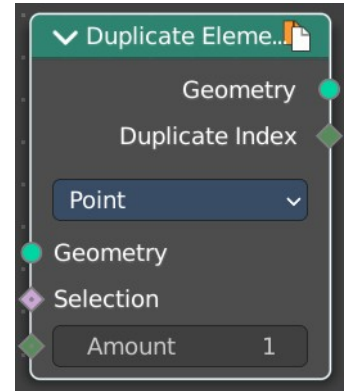

Properties

Domain

What element to duplicate.

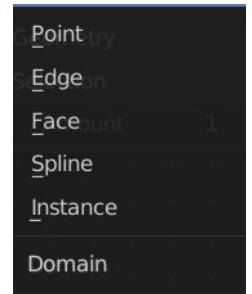

Output

Geometry

Standard output.

Duplicate Index

The index of the duplicated elements.

Merge by Distance

Welds the selected geometry below a given distance into one vertice.

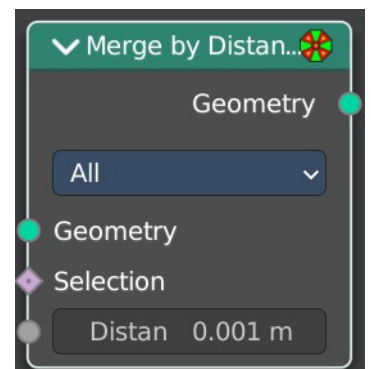

Input

Geometry

The input geometry.

Selection

A selection of the input geometry.

Distance

The merge distance. Everything below this distance will be merged into one vertice.

Properties

Mode

All

Merges all vertices in reach.

Connected

Merges just vertices that are connected by edges.

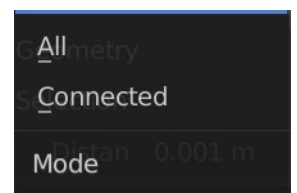

Output

Geometry

The output geometry.

Geometry to Instance

Turns every connected input geometry into an instance. These instances can then for example be used in the Instance on Points node.

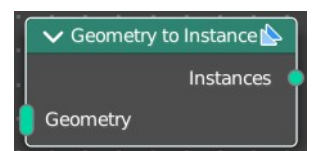

Inputs

Geometry

The input geometry.

Outputs

Instances

The output instances.

Geometry Proximity

This node finds the closest position on the target for each point in the input geometry.

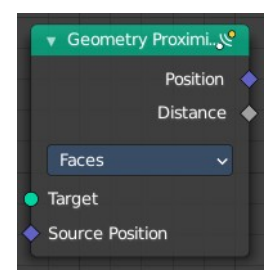

Inputs

Target

The target object.

Result

Name of the attribute where the output is stored. If the attribute does not exist yet, it is created.

Position

The position where the computed location is stored.

Properties

Target Geometry

The element of the target geometry to calculate the distance from.

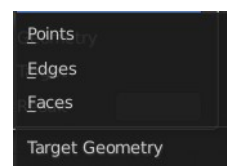

Outputs

Position

Closest location on the surface of the target mesh, or the closest point in the target point cloud in Points mode.

Distance

Distance from the source position to the closest location in the target.

Join Geometry

The Join Geometry enables you to merge separately generated pieces of geometry into a single one. In case that the inputted pieces contain different types of geometry, the output will contain multiple types of geometry.

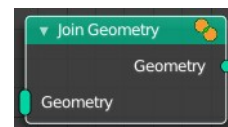

Inputs

Geometry

Standard geometry input.

Output

Geometry

Standard geometry output.

Raycast

This node sends a raycast and retrieves data from the hit target.

Inputs

Target Geometry

This is actually the source object that sends the ray.

Attribute

Attribute input.

Source Position

Source position input.

Ray Direction

A vector 3 for the ray direction.

Ray Length

The length of the ray.

Properties

Data Type

What data to calculate on hit.

Mapping

Mapping from the target geometry to hit points. Interpolated or nearest.

Output

Is Hit

Has the raycast hit something?

Hit Position

The hit position if any.

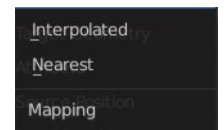
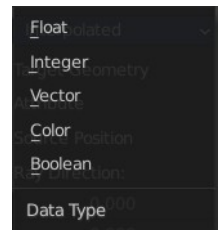
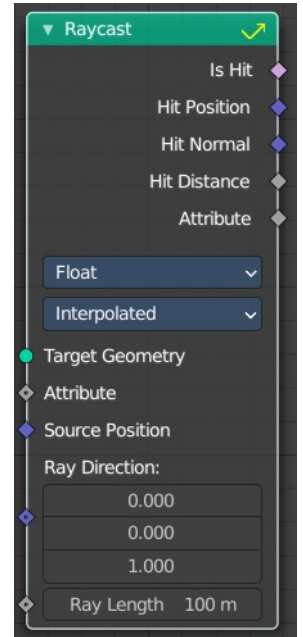

Hit Normal

The normal of the hit point.

Hit Distance

The distance of the hit point.

Attribute

The attribute of the hit object.

Sample Index

Retrieve values from specific geometry elements

Inputs

Geometry

The source object to take the data from.

Value

The value to retrieve.

Index

The index position of the value.

Properties

Data Type

The type for the source and result data.

Domain

What kind of data to process.

Clamp

Clamp the indices to the size of the attribute domain.

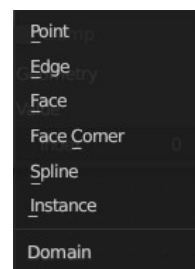
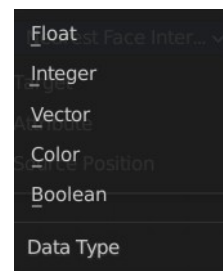
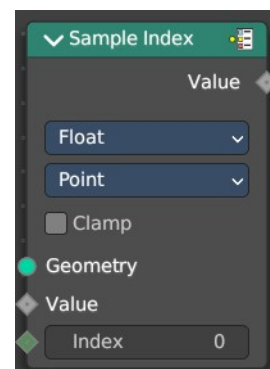

Output

Value

The output value.

Sample Nearest

Retrieves the element of a geometry closest to a position.

Inputs

Geometry

The source object to take the data from.

Sample Position

The position of the source object.

Properties

Domain

What data to process.

Output

Index

The index output.

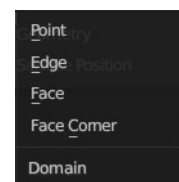
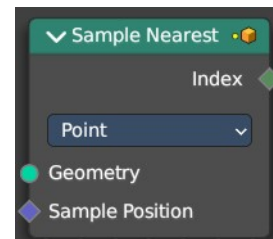

Separate Components

Splits a geometry into its components.

Inputs

Geometry

Geometry input.

Outputs

Mesh

Mesh component of the input geometry.

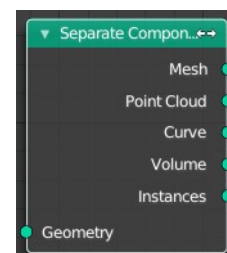

Point Cloud

Point cloud component of the input geometry.

Curve

Curve component of the input geometry.

Volume

Volume component of the input geometry.

In case that the input contains multiple volume instances, only the first volume component will be calculated.

Instance

The single instances of the geometry.

Separate Geometry

Separates a selection of a geometry into its own object.

Tip: when you combine it with the Compare Floats node then you get a more precise control of which parts are separated to a given output geometry.

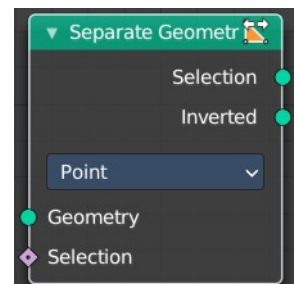

Inputs

Geometry

Geometry input.

Selection

Selection input.

Properties

Domain

What kind of geometry to separate.

Note that when selecting a domain that doesn't modify all components, the unmodified components will appear in both outputs.

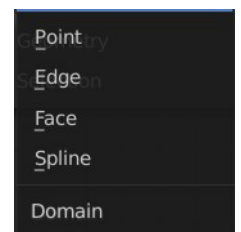

Outputs

Selection

Separated selection.

Inverted

The inverted separated selection.

Transform Geometry

Move, rotate or scale the geometry. The transformation is applied to the entire geometry, and not per element. For example, you can not rotate individual point cloud points with this node.

Inputs

Geometry

Standard geometry input.

Translation

Translates the geometry in local space of the modified object.

Rotation

Euler rotation in local space.

Scale

Scale to transform the geometries in local space.

Output

Geometry

Standard geometry output.

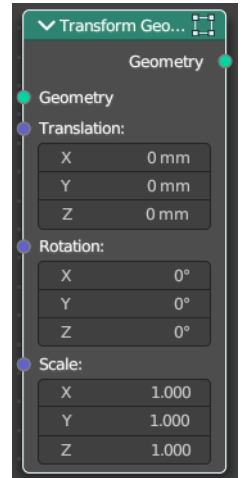

Set ID

Sets the ID of the target geometry.

Inputs

Geometry

Geometry input.

Selection

Selection input.

ID

ID Input

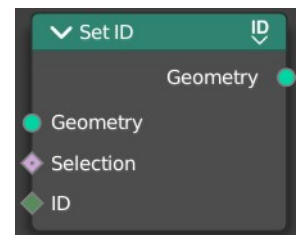

Outputs

Geometry

Geometry output.

Set Position

The Set Position node controls the location of each point, the same way as controlling the position attribute. If the input geometry contains instances, this node will affect the location of the origin of each instance.

The input node for this data is the Position Node.

Inputs

Geometry

Geometry input.

Selection

Whether or not to change the position of each point or instance. True values mean the position will be changed, false values mean it will remain the same.

Position

The new position for selected elements. By default, this is the same as if the Position Node was connected, meaning the node will do nothing.

Offset

An optional translation for each point. This is evaluated at the same time as the Position input, meaning that fields evaluated for it will not reflect the changed position.

Outputs

Geometry

Geometry outputs.

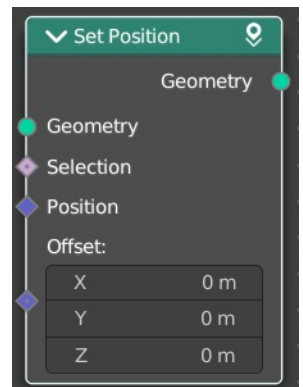

12.1.16 Editors - Geometry Nodes Editor - Header - Add Menu - Curve - Read

Table of content

Detailed table of content.....	1
Add - Curve - Read.....	3
Curve Handle Positions.....	3
Cuve Length.....	3
Curve Tangent.....	4
Curve Tilt.....	4
Endpoint Selection.....	4
Handle Type Selection.....	5
Is Spline Cyclic.....	5
Spline Length.....	5
Spline Parameter.....	6
Spline Resolution.....	6

Detailed table of content

Detailed table of content

Detailed table of content.....	1
Add - Curve - Read.....	3
Curve Handle Positions.....	3
Outputs.....	3
Left.....	3
Right.....	3
Cuve Length.....	3
Inputs.....	3
Curve.....	3
Outputs.....	3
Length.....	3
Curve Tangent.....	4
Outputs.....	4
Factor.....	4
Curve Tilt.....	4
Outputs.....	4
Tilt.....	4
Endpoint Selection.....	4
Input.....	4
Start Size.....	4
End Size.....	4
Outputs.....	5
Selection.....	5
Handle Type Selection.....	5
Properties.....	5
Left / Right.....	5
Handle Type.....	5
Output.....	5

Selection.....	5
Is Spline Cyclic.....	5
Outputs.....	5
Cyclic.....	5
Spline Length.....	5
Outputs.....	5
Length.....	5
Point Count.....	6
Spline Parameter.....	6
Outputs.....	6
Factor.....	6
Length.....	6
Index.....	6
Spline Resolution.....	6
Outputs.....	7
Resolution.....	7

Add - Curve - Read

Here you find curve related nodes.

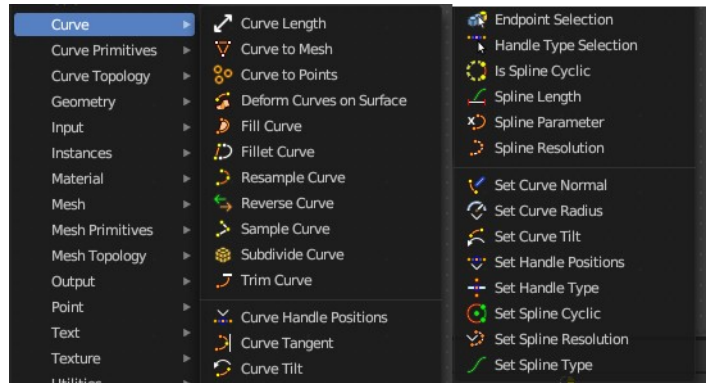

Curve Handle Positions

Get the position of the left or right handle of a curve point.



Outputs

Left

The left handle of the curve point.

Right

The right handle of the curve point.

Curve Length

Retrieves the length of all splines added together.

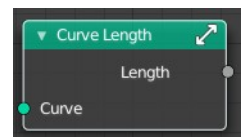

Inputs

Curve

The input curve.

Outputs

Length

The length of the curve.

Curve Tangent

Retrieve the tangent direction of a curve. The output values are normalized vectors.



Note that for NURBS and Bézier spline curves the value retrieved from this node is the value at every control point, which may not correspond to the visible evaluated points. For NURBS splines the difference may be even more pronounced and the result may not be as expected. A Resample Curve Node node can be used to create a poly spline, where there is a control point for every evaluated point.

Outputs

Factor

The vector of the tangent.

Curve Tilt

Outputs the angle used to turn the curve normal around the direction of the curve tangent in its evaluated points.



The output is per control point. For NURBS and Bézier splines, the values will be interpolated to the final evaluated points.

Outputs

Tilt

The tilt angle for the normal in radians.

Endpoint Selection

The Endpoint Selection node allows for the Selection of an arbitrary number of endpoints from each spline in a curve. The start and end inputs are evaluated on the spline domain. The result is outputted as a boolean field on the point domain.

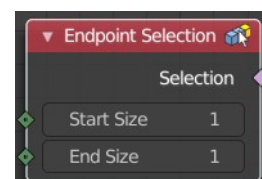

Input

Start Size

The start point of the spline.

End Size

The end point of the spline.

Outputs

Selection

Selection output.

Handle Type Selection

Creates a selection based on the handle types of the control points.

Properties

Left / Right

Whether to check for the type of handles.

Handle Type

What handle type to compare.

Output

Selection

The selection.

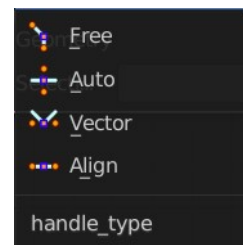
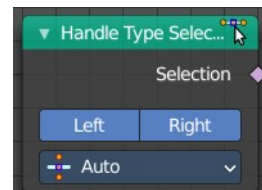

Is Spline Cyclic

Retrieve if the curve is set to cyclic.

Outputs

Cyclic

If the spline is cyclic or not.

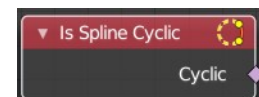

Spline Length

Retrieve the total length of each spline in a curve.

Outputs

Length

The length of each spline in the curve.

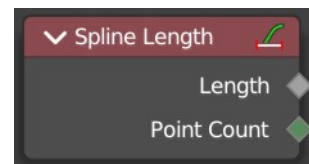

Point Count

Integer Field input of the number of control points on each spline in the spline domain. Or in the point domain, it is the number of points on the spline that contains the given control point.

Spline Parameter

The Curve Parameter node outputs how far along each spline a control point is, with a value between zero and one. The output is different from dividing the index by the total number of control points, because the control points might not be equally spaced along the curve.

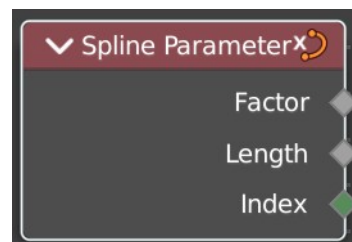

The first value is zero, so the output corresponds to the length at the control point rather than including the length of the following segment.

When used on the spline domain, the node outputs the portion of the total length of the curve (including all splines) has been traversed at the start of each spline. The order of the curve's splines is visible in the Spreadsheet Editor.

Note that for NURBS and Bézier spline curves the value retrieved from this node is the value at every control point, which may not correspond to the visible evaluated points. For NURBS splines the difference may be even more pronounced and the result may not be as expected. A Resample Curve Node node can be used to create a poly spline, where there is a control point for every evaluated point.

Outputs

Factor

The factor of the curve.

Length

The length of the curve.

Index

The index of the curve.

Spline Resolution

Retrieve the curve resolution. Means the number of spline points.

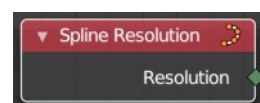

Outputs

Resolution

The spline resolution.



12.1.17 Editors - Geometry Nodes Editor - Header - Add Menu - Curve - Sample

Table of content

Detailed table of content.....	1
Add - Curve - Sample.....	6
Sample Curve.....	6

Detailed table of content

Detailed table of content

Detailed table of content.....	1
Add - Curve - Sample.....	2
Sample Curve.....	2
Input.....	2
Curve.....	2
Value.....	2
Mode Factor.....	2
Factor.....	2
Curve Index.....	2
Mode Factor.....	2
Factor.....	2
Length.....	2
Properties.....	3
Data Type.....	3
Sample Curve Mode.....	3
All Curves.....	3
Output.....	3
Value.....	3
Position.....	3
Tangent.....	3
Normal.....	3

Add - Curve - Sample

Here you find curve related nodes.

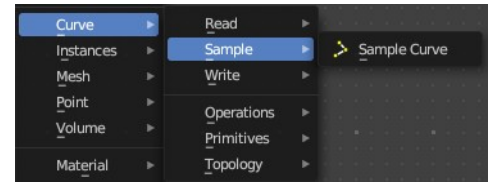

Sample Curve

Calculates a point on a curve at a certain distance from the start of the curve, specified by the length or factor inputs. It also outputs data retrieved from that position on the curve.

The sampled values are linearly interpolated from the values at the evaluated curve points at each side of the sampled point.

In case that the curve contains multiple splines, the sample position is found based on the total accumulated length, including the lengths of all previous splines. The order of the splines is the same order as displayed in the Spreadsheet Editor.

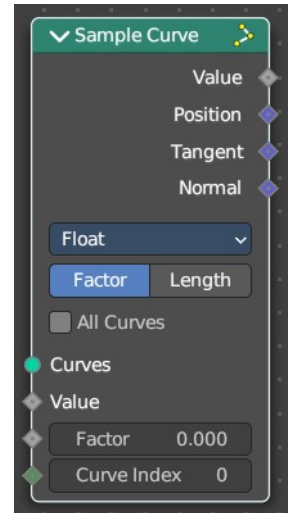

Input

Curve

The input geometry.

Value

Input Value.

Mode Factor

Factor

The resample amount with method Factor.

Curve Index

The curve index.

Mode Factor

Factor

The resample amount with method Factor.

Length

The resample amount with method Length.

Properties

Data Type

What data to calculate.

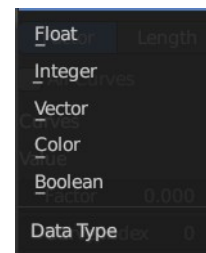

Sample Curve Mode

How to calculate the curve. By a factor, or by its length.

All Curves

Sample lengths based on the length of all curves.

Output

Value

Output Value.

Position

The position at the sample along the spline.

Tangent

The normalized curve tangent at the sample.

Normal

The normalized curve normal at the sample.

12.1.18 Editors - Geometry Nodes Editor - Header - Add Menu - Curve - Write

Table of content

Detailed table of content.....	1
Add - Curve - Write.....	3
Set Curve Normal.....	3
Set Curve Radius.....	3
Set Curve Tilt.....	4
Set Handle Positions.....	4
Set Handle Type.....	5
Set Spline cyclic.....	6
Set Spline Resolution.....	7
Set Spline Type.....	7

Detailed table of content

Detailed table of content

Detailed table of content.....	1
Add - Curve - Write.....	3
Set Curve Normal.....	3
Input.....	3
Curve.....	3
Selection.....	3
Properties.....	3
Mode.....	3
Outputs.....	3
Curve.....	3
Set Curve Radius.....	3
Input.....	3
Geometry.....	3
Selection.....	4
Radius.....	4
Outputs.....	4
Geometry.....	4
Set Curve Tilt.....	4
Input.....	4
Geometry.....	4
Selection.....	4
Tilt.....	4
Outputs.....	4
Curve.....	4
Set Handle Positions.....	4
Input.....	4
Geometry.....	4
Selection.....	5
Position.....	5
Properties.....	5

Mode.....	5
Outputs.....	5
Geometry.....	5
Set Handle Type.....	5
Input.....	5
Curve.....	5
Selection.....	5
Properties.....	5
Mode.....	5
Handle Type.....	5
Free.....	5
Auto.....	6
Vector.....	6
Aligned.....	6
Output.....	6
Curve.....	6
Set Spline cyclic.....	6
Input.....	6
Geometry.....	6
Selection.....	6
Cyclic.....	6
Outputs.....	6
Geometry.....	6
Set Spline Resolution.....	7
Input.....	7
Geometry.....	7
Selection.....	7
Resolution.....	7
Outputs.....	7
Geometry.....	7
Set Spline Type.....	7
Input.....	7
Curve.....	7
Selection.....	7
Properties.....	7
Spline Type.....	7
Output.....	8
Curve.....	8

Add - Curve - Write

Here you find curve related nodes.

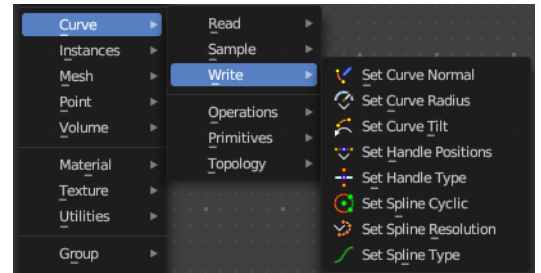

Set Curve Normal

Set the evaluation mode for curve normals.

Input

Curve

The input curve.

Selection

A selection of the input curve.

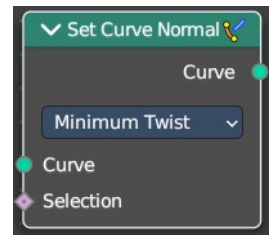

Properties

Mode

The evaluation mode for the curve normals.

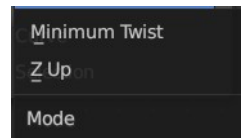

Outputs

Curve

The curve output.

Set Curve Radius

Set the curve radius.

Input

Geometry

The input curve.

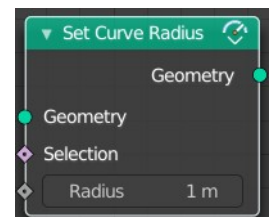

Selection

A selection of the input curve.

Radius

The radius to set.

Outputs

Geometry

Standard geometry output.

Set Curve Tilt

Controls the tilt angle at each curve control point.

Input

Geometry

The input curve.

Selection

Whether or not to change the value on each control point. True values mean the value will be changed, false values mean the value will remain the same.

Tilt

The tilt rotation.

Outputs

Curve

Standard geometry output.

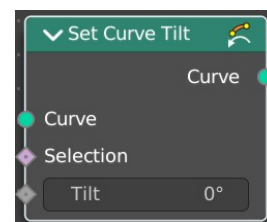

Set Handle Positions

Set the handle positions of bezier curves

Input

Geometry

The input curve.

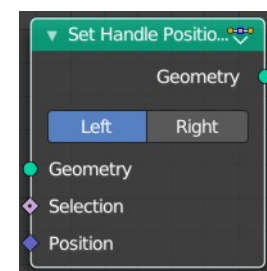

Selection

A selection of the input curve.

Position

The position of the handle.

Properties

Mode

Left or right handles.

Outputs

Geometry

Standard geometry output.

Set Handle Type

Sets a handle type for the curve points of a bezier curve. Handle types determines how the interpolation before and after the curve point happens.

Input

Curve

The input curve.

Selection

A selection of the input curve.

Properties

Mode

Left or right handles.

Handle Type

The different available handle types.

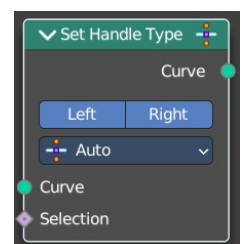

Free

The handles can be adjusted individually.

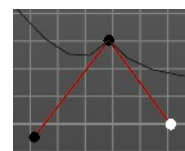
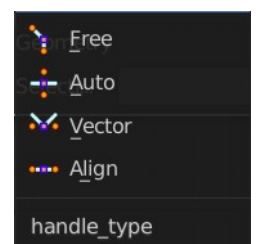

Auto

The left and the right handle will always point to each other. The length of the handles will start in equal size.



Vector

The handles can be adjusted individually.

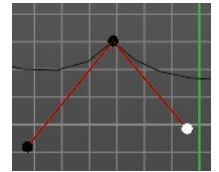

Aligned

The left and the right handle will always point to each other.

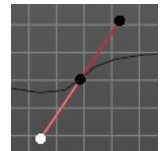

Output

Curve

Standard geometry output.

Set Spline cyclic

Sets the spline cyclic. Means looping.

Input

Geometry

The input curve.

Selection

A selection of the input curve.

Cyclic

Cyclic or not

Outputs

Geometry

Standard geometry output.

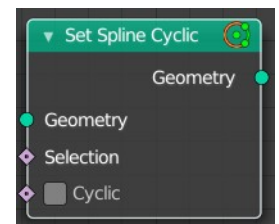

Set Spline Resolution

Sets the resolution of the spline. Means how many evaluated points should be generated on the curve for each control point.

Input

Geometry

The input curve.

Selection

A selection of the input curve.

Resolution

The resolution of the spline.

Outputs

Geometry

Standard geometry output.

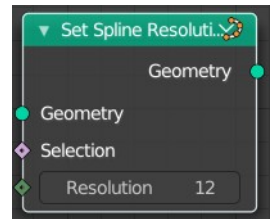

Set Spline Type

Change the curve spline type.

Input

Curve

The input curve.

Selection

A selection of the input curve.

Properties

Spline Type

The spline type to set the curve to.

Note that when converting from a NURBS spline to a Bézier spline, at least six points are needed. When the number of points is not a multiple of three a full conversion is not possible and the spline has to be truncated.

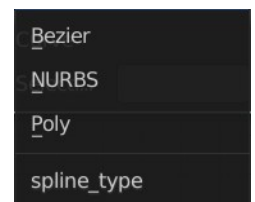
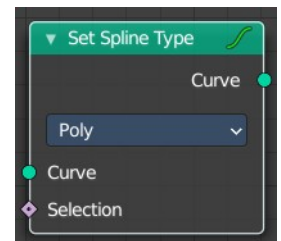

Output

Curve

Standard geometry output.

12.1.19 Editors - Geometry Nodes Editor - Header - Add Menu - Curve - Operations

Table of content

Detailed table of content.....	1
Add - Curve.....	4
Cuve to Mesh.....	4
Cuve to Points.....	4
Deform Curves on Surface.....	6
Fill Curve.....	6
Fillet Curve.....	6
Interpolate Curves.....	7
Resample curve.....	8
Reverse Curve.....	9
Subdivide Curve.....	10
Trim Curve.....	10

Detailed table of content

Detailed table of content

Detailed table of content.....	1
Add - Curve.....	4
Cuve to Mesh.....	4
Inputs.....	4
Curve.....	4
Profile Curve.....	4
Fill Caps.....	4
Outputs.....	4
Mesh.....	4
Cuve to Points.....	4
Inputs.....	5
Curve.....	5
Properties.....	5
Mode.....	5
Evaluated.....	5
Count.....	5
Count Input.....	5
Length.....	5
Length Input.....	5
Outputs.....	5
Point.....	5
Tangent.....	5
Normal.....	5
Rotation.....	5
Deform Curves on Surface.....	6
Inputs.....	6
Curves.....	6
Outputs.....	6

Curves.....	6
Fill Curve.....	6
Inputs.....	6
Curve.....	6
Properties.....	6
Mode.....	6
Triangles or N-gons.....	6
Outputs.....	6
Mesh.....	6
Fillet Curve.....	6
Input.....	7
Curve.....	7
Count.....	7
Radius.....	7
Limit Radius.....	7
Properties.....	7
Mode.....	7
Bezier.....	7
Poly.....	7
Outputs.....	7
Curve.....	7
Interpolate Curves.....	7
Input.....	7
Guide Curves.....	7
Guide Up.....	7
Guide Group ID.....	8
Points.....	8
Points Up.....	8
Point Group ID.....	8
Max Neighbor.....	8
Outputs.....	8
Curves.....	8
Closest Index.....	8
Closest Weight.....	8
Resample curve.....	8
Input.....	8
Curve.....	8
Selection.....	9
Count.....	9
Length.....	9
Properties.....	9
Mode.....	9
Evaluated.....	9
Count.....	9
Length.....	9
Output.....	9
Curve.....	9
Reverse Curve.....	9
Inputs.....	9
Curve.....	9
Selection.....	9
Outputs.....	10
Curve.....	10

Subdivide Curve.....	10
Inputs.....	10
Geometry.....	10
Cuts.....	10
Outputs.....	10
Geometry.....	10
Trim Curve.....	10
Inputs.....	10
Curve.....	10
Selection.....	10
Start.....	11
End.....	11
Properties.....	11
Mode.....	11
Factor.....	11
Length.....	11
Outputs.....	11
Curve.....	11

Add - Curve

Here you find curve related nodes.

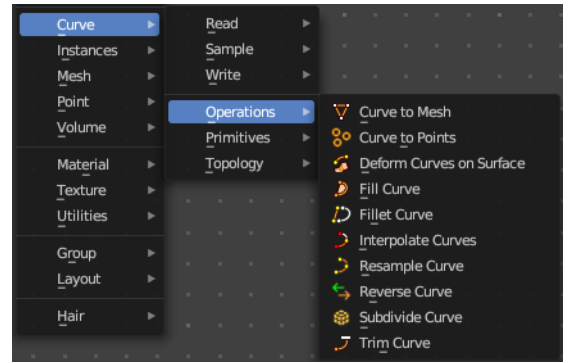

Curve to Mesh

Converts a curve object to a mesh object. Optionally, a profile curve can be provided to give the curve a custom shape.

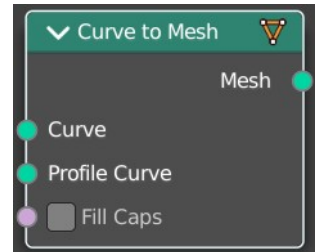

Inputs

Curve

The input curve.

Profile Curve

If a profile curve is provided, it will be extruded along all splines. Otherwise the generated mesh will just be a chain of edges.

Fill Caps

For cyclic profile curve. Fill the ends of the generated mesh for each spline combination with an N-gon.

The resulting mesh is Manifold, the two new faces for each spline are simply connected to existing edges.

Outputs

Mesh

Standard mesh output.

Curve to Points

Converts a curve object to a Point cloud.

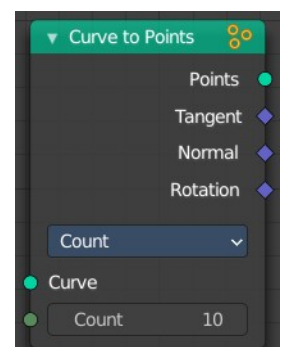

Inputs

Curve

The input curve.

Properties

Mode

How to generate points from the input curve.

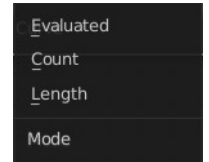

Evaluated

Create points from the evaluation points of the curve. This is based on the resolution attribute for nurbs and bezier splines.

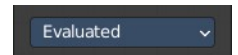

Count

Sample each spline by evenly distributing the specified number of points along the spline.

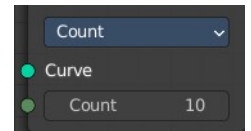

Count Input

The number of points to distribute along the spline.

Length

Sample each spline by splitting the spline into segments by the specified length.

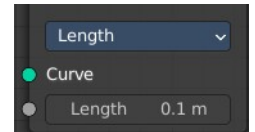

Length Input

The length of the single segments.

Outputs

Point

Generated point cloud.

Tangent

The normalized curve tangent at the sampled position, or the direct evaluated normal in Evaluated mode.

Normal

The normal value from the evaluated curve at each result point. This is the same value from the Normal Node at those positions.

Rotation

The Euler rotation build from the Tangent and Normal outputs.

Deform Curves on Surface

Curves that are attached to a surface can follow the surface at modification.

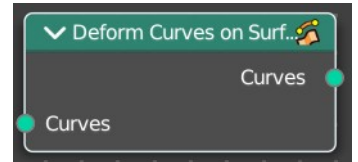

Inputs

Curves

The input curve.

Outputs

Curves

The output curve.

Fill Curve

Fills the curve with mesh geometry. The mesh is only generated flat with a local Z of 0.

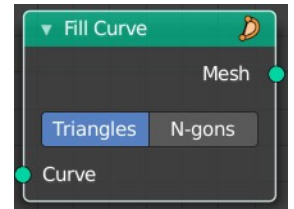

Inputs

Curve

The input curve.

Properties

Mode

Triangles or N-gons

Fill the curve with either triangles, or use N-Gon geometry.

Outputs

Mesh

The output as mesh.

Fillet Curve

The Fillet Curve rounds corners on curve control points, similar to the effect of the Bevel Modifier on a 2D mesh.

A key difference is that the rounded portions created by the Fillet Curve node are always portions of a circle.

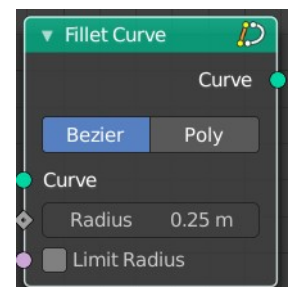

Input

Curve

The input curve.

Count

Polymode. Define the number of vertices that are created.

Radius

The radius of the arc

Limit Radius

Prevent overlapping when the defined radius exceeds the maximum possible radius for a given point.

Properties

Mode

Bezier

Creates a circular arc at vertices by changing handle lengths (applicable only for Bezier splines).

Poly

Creates a circular arc by creating vertices (as many as defined by the Count fields input) along the arc (applicable for all spline types).

Outputs

Curve

Standard geometry input with a curve component.

Interpolate Curves

Generates new curve parts by interpolating between existing curves.

Input

Guide Curves

The base curves to interpolate from.

Guide Up

An optional up vector that is typically a surface normal. Providing this up vector can improve the quality of the interpolation.

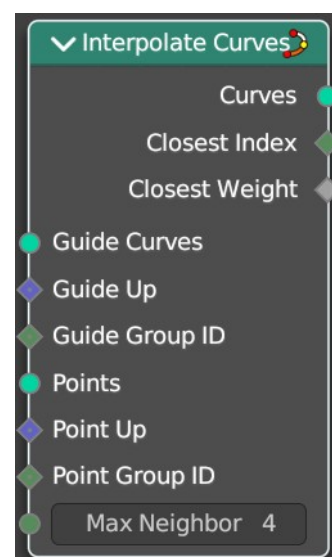

This up direction can be retrieved with a combination of the Sample UV Surface Node using the same geometry that the points were distributed on, and the Normal Node.

Guide Group ID

Splits guides into separate groups. New curves interpolate existing curves from a single group.

Points

The positions of the first root control points of the newly generated interpolated curves.

Points Up

Optional up vector that is typically a surface normal.

Point Group ID

The curve group to interpolate in.

Max Neighbor

Maximum amount of close guide curves that are taken into account for interpolation.

Outputs

Curves

The new curve.

Closest Index

Index of the closest guide curve for each generated curve.

Note that internally this node mixes the data from multiple guide curves, with the maximum number of sources depending on the Max Neighbor input. This output is only the index of the curve with the largest weight.

Closest Weight

Weight of the closest guide curve for each generated curve.

Resample curve

Creates a poly spline for each input spline. In the Count and Length modes, the control points of the new poly splines will have uniform spacing.

Input

Curve

The input geometry.

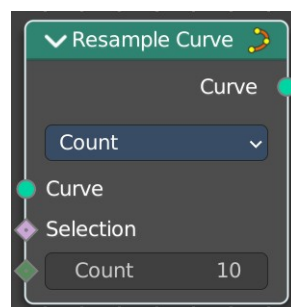

Selection

A selection of the input geometry

Count

The number of control points on the new splines.

Length

The approximate length between the control points of the new splines.

Properties

Mode

The resample mode.

Evaluated

Use the resolution attribute for spline and bezier curves.

Count

Use the count of the curve points.

Length

Use the length of the curve.

Output

Curve

Standard geometry output.

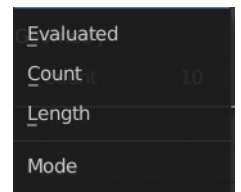

Reverse Curve

Reverses the direction of the spline. The start point becomes the end point and vice versa. The shape of the spline is not modified.

Inputs

Curve

The input curve.

Selection

An optional selection attribute to determine which part of the spline should be reversed.

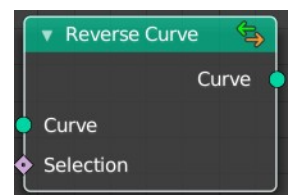

Outputs

Curve

Standard geometry output.

Subdivide Curve

Subdivides the curve. The shape is not changed.

Inputs

Geometry

The input curve.

Cuts

The number of cuts per segment.

Outputs

Geometry

Standard geometry output.

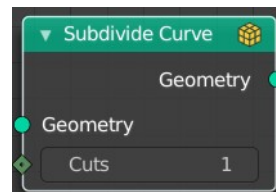

Trim Curve

The Curve Trim node shortens each spline in the curve by removing sections at the start and end of each spline.

Bézier splines will still output as Bézier splines. The first and last control point and its handles will be moved as necessary to preserve the shape. But NURBS splines will be transformed into poly splines in order to be trimmed.

Cyclic splines are currently not supported.

Note that if the Start input is larger than the End, then the resulting spline will have a single point, located at the sample location of the Start value.

Inputs

Curve

The input curve.

Selection

A selection of the curve.

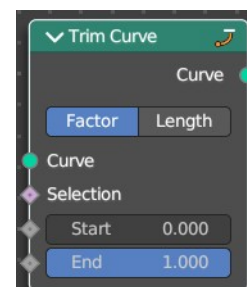

Start

The start point of the spline, as a factor.

End

The end point of the spline, as a factor.

Properties

Mode

How to find endpoint positions for the trimmed spline.

Factor

The endpoint positions of each spline's length is determined by a factor. The input values should be between 0 or 1.

Length

The endpoint positions of each spline is determined by a length from the start of each spline. The input values should be between 0 and the length of the splines.

Outputs

Curve

Standard geometry output.



12.1.2 Editors - Geometry Node Editor - Header - Quick Menu

Table of content

- Quick Menu.....1
- Adding an operator to the Quick menu.....1
- Adding a menu to the Quick menu.....1
- Order.....2
- Removing an operator from the Quick menu.....2
- Context and mode dependent content.....2

Quick Menu

The quick menu, or in long Quick Favorites menu, is a menu that can be customized to your needs. Here you can add operators for quick access.

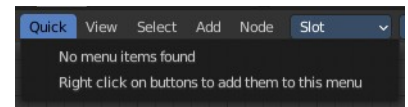

It is located in the header. But it can be called by hotkey Q directly under the mouse. This hotkey works in other editors too.

When the menu is empty, then you will see the message "No Menu Items found". This means that you first have to add some tools to the menu. It is a user configurable menu.

Note that added operators in this menu does not have icons. Just text.

Adding an operator to the Quick menu

Open the panel or the menu where your operator is that you want to add.

Let's add the open command from the File menu. Open the File menu, right click at open, and choose Add to Quick Favorites.

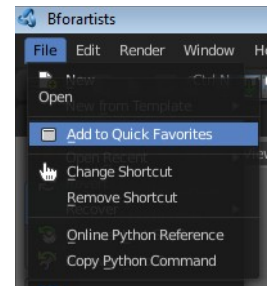

Do the same with Save As. We should now have two new menu items in the Quick menu, which you can use now.

As a rule of thumb, when the right click menu has an Add to Quick Favorites, then you can add it to the quick menu.

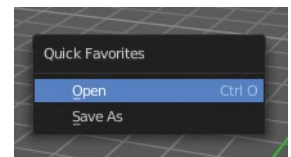

Note that you can also add operators from the tool shelf at the left. And also operators from other editor types. Some other editors have their own quick menu though. The Image Editor for example. These operators gets added in the quick menu of the image editor then. And does not show in the quick menu in the header of the 3D view.

Adding a menu to the Quick menu

It is also possible to add a menu to the Quick menu. For example the whole Add menu. The way is the same. Right click at it, and choose Add to Quick Favorites.

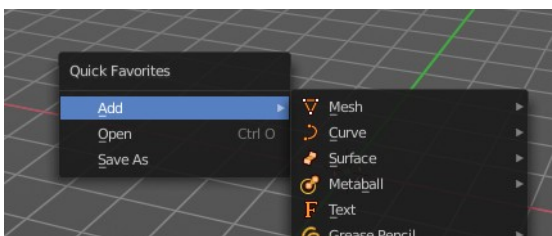
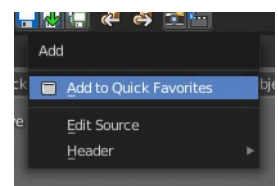

Order

You might notice that the add menu adds at the top of the menu, and not at the bottom as you would expect. First comes menus, then comes operators. And they get added in the order in which you add them.

Besides that, operators and menus gets added in the order that you add them. They cannot be sorted afterwards. So be careful how you add them. You can of course always remove operators and menus, and re-add them at the end of the list.

Removing an operator from the Quick menu

Removing is as simple as adding. Right click at the operators in the Quick menu, and choose Remove from Quick favorites.

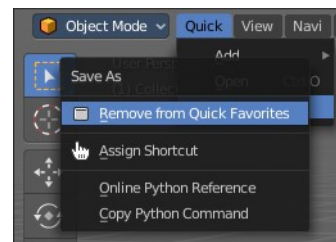

Context and mode dependent content

The quick favorites. menu exists in nearly all editors. But it is just in the 3D view available in the header. So that you know this functionality exists. In the other editors you call it with hotkey Q.

The content of the quick favorites. menu changes, dependent over which editor you are, and in what mode you are. When you add for example an operator from the image editor, then this operator just shows in the quick menu when you call the menu from the image editor. Same goes for the modes. Edit mode tools will just show in edit mode. And so on.



12.1.20 Editors - Geometry Nodes Editor - Header - Add Menu - Curve - Primitives

Table of content

Detailed table of content.....	1
Add menu - Curve Primitives.....	4
Arc.....	4
Bezier Segment.....	5
Curve Circle.....	6
Curve Line.....	7
Curve Spiral.....	8
Quadratic Bezier.....	8
Quadrilateral.....	9
Star.....	10

Detailed table of content

Detailed table of content

Detailed table of content.....	1
Add menu - Curve Primitives.....	4
Arc.....	4
Inputs.....	4
Resolution.....	4
in Radius mode.....	4
Radius.....	4
Start Angle.....	4
Sweep Angle.....	4
In Points Mode.....	4
Start.....	4
Middle.....	4
End.....	4
Offset Angle.....	4
Connect Center.....	5
Invert Arc.....	5
Properties.....	5
Mode.....	5
Outputs.....	5
Curve.....	5
In Points Mode.....	5
Center.....	5
Normal.....	5
Radius.....	5
Bezier Segment.....	5
Inputs.....	5
Resolution.....	5
Start, End.....	5
Start Handle, End Handle.....	6
Properties.....	6

Mode.....	6
Position.....	6
Offset.....	6
Outputs.....	6
Curve.....	6
Curve Circle.....	6
Inputs.....	6
Resolution.....	6
Radius.....	6
Point 1, Point 2, Point 3.....	6
Properties.....	7
Mode.....	7
Points.....	7
Radius.....	7
Outputs.....	7
Curve.....	7
Center.....	7
Curve Line.....	7
Properties.....	7
Points.....	7
Start.....	7
End.....	7
Direction.....	7
Start.....	7
Direction.....	7
Length.....	8
Outputs.....	8
Curve.....	8
Curve Spiral.....	8
Inputs.....	8
Resolution.....	8
Rotations.....	8
Start Radius, End Radius.....	8
Height.....	8
Reverse.....	8
Outputs.....	8
Curve.....	8
Quadratic Bezier.....	8
Inputs.....	9
Resolution.....	9
Start, Middle, End.....	9
Outputs.....	9
Curve.....	9
Quadrilateral.....	9
Input.....	9
Properties.....	9
Mode.....	9
Rectangle.....	9
Width.....	9
Parallelogram.....	9
Height.....	9
Offset.....	10
Trapezoid.....	10

Height.....	10
Bottom Width.....	10
Top Width.....	10
Offset.....	10
Kite.....	10
Bottom Height.....	10
Top Height.....	10
Points.....	10
Star.....	10
Inputs.....	11
Points.....	11
Inner Radius, Outer Radius.....	11
Twist.....	11
Outputs.....	11
Curve.....	11

Add menu - Curve Primitives

Add curve primitives in different shapes.

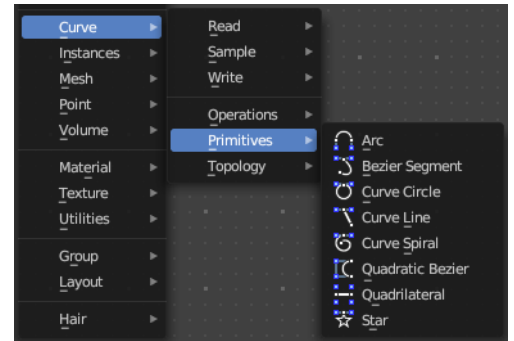

Arc

Adds a bezier curve segment in the shape of an arc

Inputs

Resolution

The number of edges on the curve.

in Radius mode

Radius

Just Radius mode. The radius of the arc.

Start Angle

Just Radius mode. The start angle of the arc.

Sweep Angle

Just Radius mode. The sweep angle of the arc.

In Points Mode

Start

The start point vector of the ark.

Middle

The middle point vector of the ark.

End

The end point vector of the ark.

Offset Angle

The offset angle of the ark.

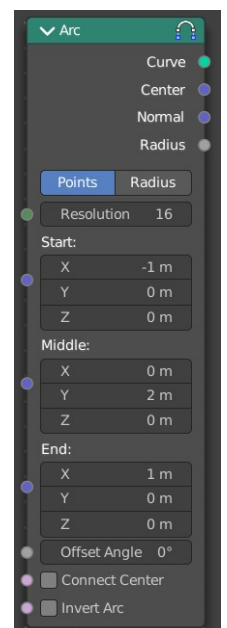
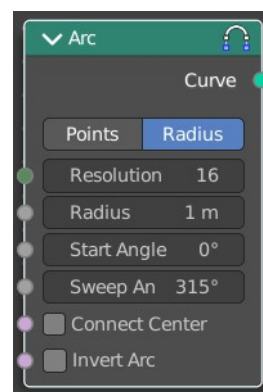

Connect Center

Connect the start and endpoints to the center.

Invert Arc

Inverts the arc.

Properties

Mode

Point or Radius mode.

Radius mode (default): Generates a fixed radius arc on XY plane with controls for Angle, Sweep and Invert.

Points mode: Generates a three point curve arc from Start to End via Middle with an Angle Offset and option to invert the arc. There are also outputs for arc center, radius and normal direction relative to the Z-axis.

Outputs

Curve

Curve output.

In Points Mode

Center

The center vector of the arc.

Normal

The normal of the arc.

Radius

The radius of the arc.

Bezier Segment

Adds a bezier curve segment.

Inputs

Resolution

The number of edges on the curve.

Start, End

Positions of the start and end control point of the curve.



Start Handle, End Handle

Positions of the handles used to define the shape of the curve.

Properties

Mode

Position

The handle inputs are the absolute positions of the handles in 3D space.

Offset

The handle positions are relative to the control point on the curve. The handle inputs give the offset from the control points.

Outputs

Curve

Bezier spline generated from the inputs.

Curve Circle

Adds a curve in circle shape.

Inputs

Resolution

Number of edges on the circle.

Radius

The radius of the circle.

Point 1, Point 2, Point 3

Appears when you change the method to Points. Defines three points on the circle. The order of the points determines the direction (clockwise or counterclockwise) of the circle.

Note that because of the finite resolution, the three points do not necessarily lie on the generated curve.

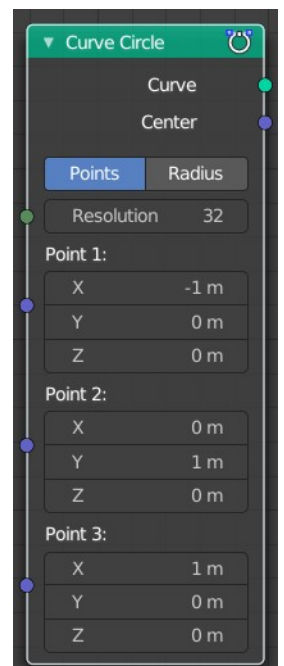
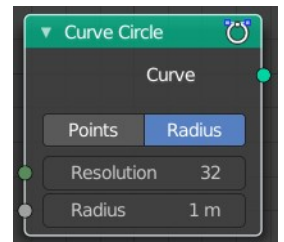

Properties

Mode

Points

The position and radius of the circle is defined by three points. The center of the circle is also given as an output. If the three points lie on one line, no geometry is generated.

Radius

The circle is defined by the radius.

Outputs

Curve

Poly spline generated from the inputs.

Center

Appears when you change the method to Points. The center of the circle defined by the three points.

Curve Line

Adds a curve in the shape of a straight line.

Properties

Points

Calculates the curve by a start and end point.

Start

The start point of the curve.

End

The end point of the curve.

Direction

Calculates the curve by a start point, a direction vector and the length of the curve.

Start

The start point of the curve.

Direction

The direction vector.

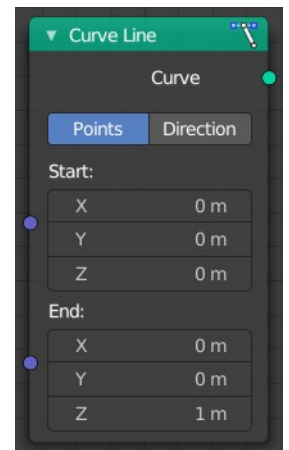

Length

The length of the curve.

Outputs

Curve

The created curve.

Curve Spiral

Adds a curve in spiral shape. By default the spiral twists clockwise.

Inputs

Resolution

Number of edges for each full rotation.

Rotations

Number of times the spiral makes a full rotation.

Start Radius, End Radius

Radius of the start point and end point of the spiral. The radius of the spiral changes linearly between the two values over the whole spiral.

Height

Height of the spiral.

Reverse

Boolean value that changes the direction from clockwise to counterclockwise when turned on.

Outputs

Curve

Poly spline generated from the inputs.

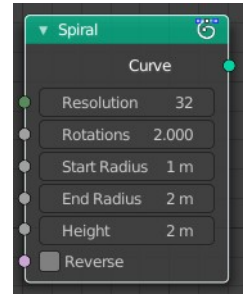

Quadratic Bezier

Adds a curve from the given control points. The generated shape is a parabola.

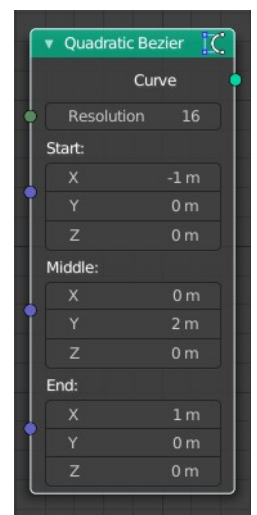

Inputs

Resolution

The number of edges on the curve.

Start, Middle, End

Positions of the three control points. The generated curve passes through the two end points, and is tangent to the lines between the middle point and the two end points.

Outputs

Curve

Poly spline generated from the inputs.

Quadrilateral

Adds a curve in different geometric shapes.

Note that the names does not necessarily fit to the generated geometry.

Input

The input nodes may vary. See Properties.

Properties

Mode

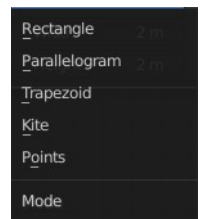
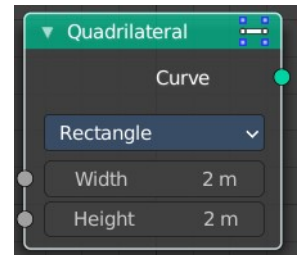

Rectangle

creates a straight line in y direction.

Width

The length of the straight line.

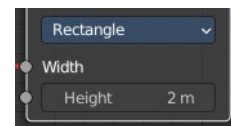

Parallelogram

Creates a straight line that is adjustable in x and y direction.

Height

The height of the line.

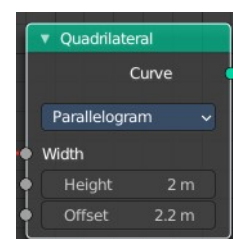

Offset

The width of the line.

Trapezoid

Height

The height of the trapez.

Bottom Width

The width of the bottom line of the trapez.

Top Width

The width of the top line of the trapez.

Offset

The offset of the top line of the trapez.

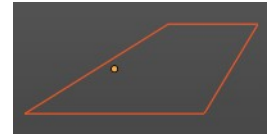
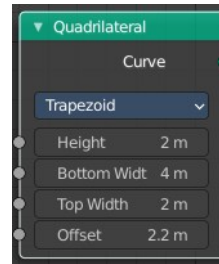

Kite

creates a straight line in y direction. The curve end points are separately adjustable

Bottom Height

The length of the bottom part of the line.

Top Height

The length of the top part of the line.

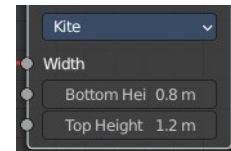

Points

Creates a rectangle. Each point of the rectangle is independantly adjustable in x, y and z position.

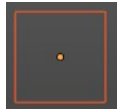
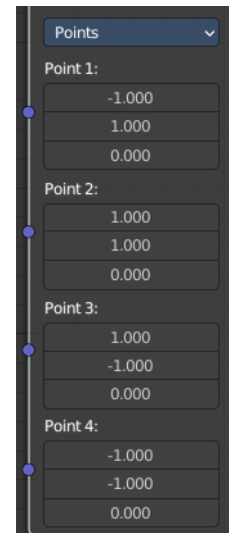

Star

Adds a curve in star shape.

This is done by connecting alternating points of two circles. The points on the inner circle

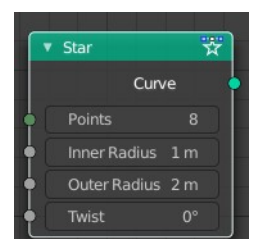

are offset by a rotation so that they lie in between the points on the outer circle. This offset can be changed with the twist input.

Inputs

Points

Number of points on each of the circles.

Inner Radius, Outer Radius

Radii of the two circles. The inner radius can be bigger than the outer radius.

Twist

Angle offset of the inner circle. The twist value rotates the points on the circle corresponding with the inner radius counterclockwise by the given angle.

Outputs

Curve

Poly spline generated from the inputs.



12.1.21 Editors - Geometry Nodes Editor - Header - Add Menu - Curve - Topology

Table of content

Detailed table of content.....	1
Add menu - Curve Topology.....	2
Offset Points in Curve.....	2
Curve of Point.....	2
Points of Curve.....	3

Detailed table of content

Detailed table of content

Detailed table of content.....	1
Add menu - Curve Topology.....	2
Offset Points in Curve.....	2
Inputs.....	2
Point Index.....	2
Offset.....	2
Outputs.....	2
Is Valid Offset.....	2
Point Index.....	2
Curve of Point.....	2
Inputs.....	2
Point Index.....	2
Offset.....	2
Outputs.....	3
Curve Index.....	3
Index in Curve.....	3
Points of Curve.....	3
Inputs.....	3
Curve Index.....	3
Weights.....	3
Sort Index.....	3
Outputs.....	3
Point Index.....	3
Total.....	3

Add menu - Curve Topology

Curve topology related nodes.

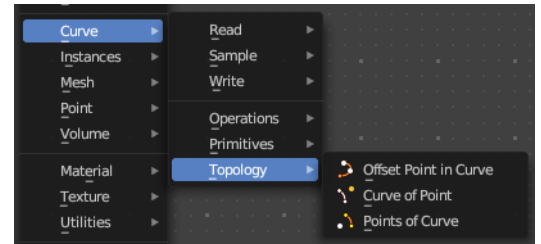

Offset Points in Curve

Offset a control point index in the curve.

Inputs

Point Index

The point index of the curve.

Offset

Offset of the point index.

Outputs

Is Valid Offset

Outputs true if the evaluated controlpoint plus the offset is a valid index.

Point Index

The index of the control point plus the offset.



Curve of Point

Retrieve the curve of which the control point is part of.

Inputs

Point Index

The point index of the curve.

Offset

Offset of the point index.

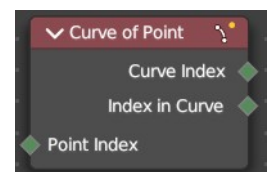

Outputs

Curve Index

The curve of which the control point is part of.

Index in Curve

How far along the curve the control point is.

Points of Curve

Retrieve a point index within a curve.

Inputs

Curve Index

The curve to retrieve the data from

Weights

Values to sort the curve points.

Sort Index

The point to output.

Outputs

Point Index

The output point.

Total

The number of points in the curve.

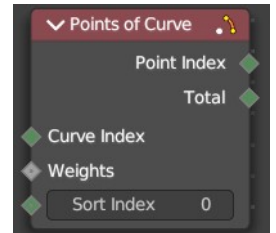

12.1.22 Editors - Geometry Nodes Editor - Header - Add Menu - Instances

Table of content

Detailed table of content.....	1
Add menu - Instances.....	2
Instance on Points.....	3
Instances to Points.....	3
Realize Instances.....	4
Rotate Instances.....	4
Scale Instances.....	5
Translate Instances.....	6
Instance Rotation.....	6
Instance Scale.....	7

Detailed table of content

Detailed table of content

Detailed table of content.....	1
Add menu - Instances.....	2
Instance on Points.....	3
Inputs.....	3
Points.....	3
Selection.....	3
Instance.....	3
Pick Instance.....	3
Instance Index.....	3
Rotation.....	3
Scale.....	3
Output.....	3
Instances.....	3
Instances to Points.....	3
Inputs.....	4
Instances.....	4
Selection.....	4
Position.....	4
Radius.....	4
Output.....	4
Instances.....	4
Realize Instances.....	4
Inputs.....	4
Geometry.....	4
Outputs.....	4
Geometry.....	4
Rotate Instances.....	4
Inputs.....	5
Geometry.....	5
Selection.....	5

Rotation.....	5
Pivot Point.....	5
Local Space.....	5
Output.....	5
Geometry.....	5
Scale Instances.....	5
Inputs.....	5
Geometry.....	5
Selection.....	5
Scale.....	5
Center.....	5
Local Space.....	5
Output.....	6
Geometry.....	6
Translate Instances.....	6
Inputs.....	6
Geometry.....	6
Selection.....	6
Translation.....	6
Local Space.....	6
Output.....	6
Geometry.....	6
Instance Rotation.....	6
Output.....	6
Rotation.....	6
Instance Scale.....	7
Output.....	7
Scale.....	7

Add menu - Instances

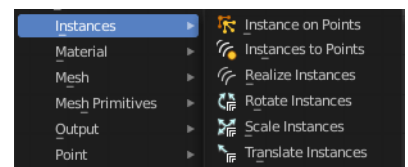

Instance on Points

Instances geometry on points.

Inputs

Points

Standard points input.

Selection

A selection of the point cloud.

Instance

Instance input.

Pick Instance

Select an instance of the point cloud.

Instance Index

The instance of the index

Rotation

The initial rotation.

Scale

The initial scale.

Output

Instances

Instances output.

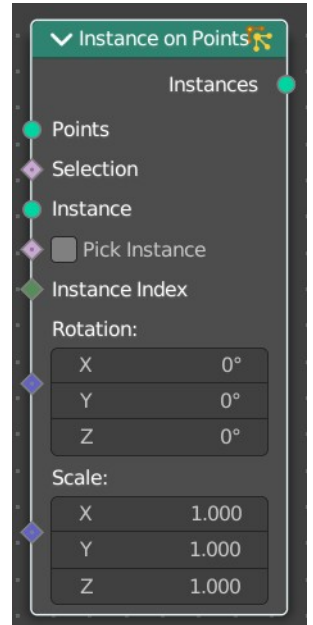

Instances to Points

This node takes a geometry set with instances as input, and outputs points located on the origins of the top level of instances in the

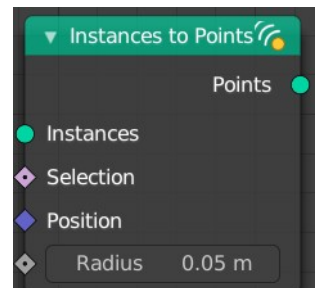

geometry set (not nested instances). It also has position and radius inputs to allow overriding the default, and a selection input to only generate points for some instances.

Inputs

Instances

Instances input.

Selection

A selection of the instance.

Position

The position of the instance.

Radius

The radius of the points.

Output

Instances

Points output.

Realize Instances

Makes the instances in the geometry inmput real. This means each instance becomes its own object.

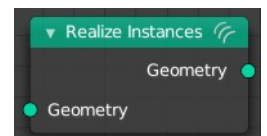

Inputs

Geometry

Geometry Input.

Outputs

Geometry

Geometry outputs.

Rotate Instances

Rotates the instances of a geometry.

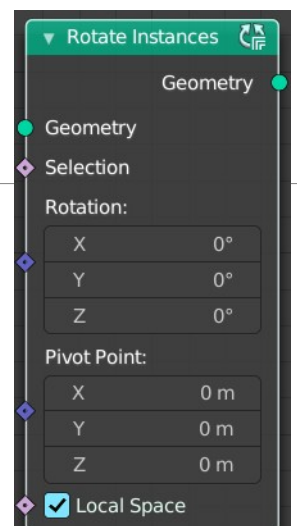

Inputs

Geometry

Standard geometry input.

Selection

A selection of the geometry.

Rotation

The initial rotation.

Pivot Point

The pivot point position to rotate around.

Local Space

Rotate in world space or in Local Space of the object.

Output

Geometry

Standard geometry output.

Scale Instances

Rotates the instances of a geometry.

Inputs

Geometry

Standard geometry input.

Selection

A selection of the geometry.

Scale

The initial scale.

Center

The pivot point position to scale around.

Local Space

Rotate in world space or in Local Space of the object.

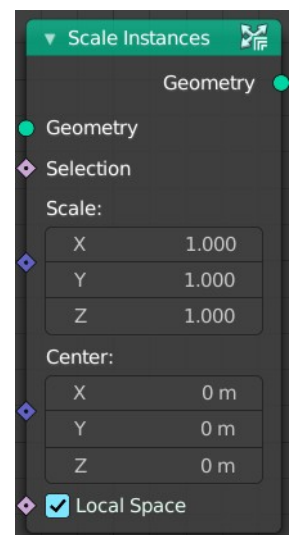

Output

Geometry

Standard geometry output.

Translate Instances

Rotates the instances of a geometry.

Inputs

Geometry

Standard geometry input.

Selection

A selection of the geometry.

Translation

The amount to move.

Local Space

Rotate in world space or in Local Space of the object.

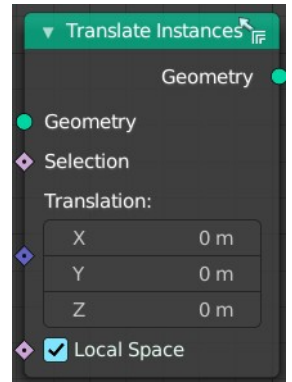

Output

Geometry

Standard geometry output.

Instance Rotation

Retrieves the rotation of the instances.

Output

Rotation

Vector Field output

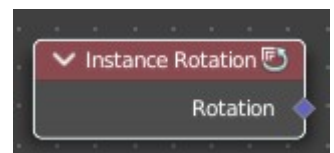

Instance Scale

Retrieves the scale of an instances.

Output

Scale

Vector Field output

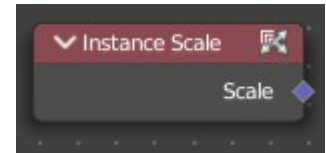

12.1.23 Editors - Geometry Nodes Editor - Header - Add Menu - Mesh - Read

Table of content

Detailed table of content.....	1
Add menu - Mesh - Read.....	3
Edge Angle.....	3
Edge Neighbours.....	3
Edge Vertices.....	3
Edges to Face Group.....	4
Face Area.....	4
Face Neighbours.....	5
Face Group Boundaries.....	5
Is Face Planar.....	5
Is Shade Smooth.....	6
Mesh Island.....	6
Shortest Edge Path.....	6
Vertex Neighbors.....	6

Detailed table of content

Detailed table of content

Detailed table of content.....	1
Add menu - Mesh - Read.....	3
Edge Angle.....	3
Outputs.....	3
Unsigned Angle.....	3
Signed Angle.....	3
Edge Neighbours.....	3
Outputs.....	3
Face Count.....	3
Edge Vertices.....	3
Outputs.....	4
Vertex Index 1.....	4
Vertex Index 2.....	4
Position 1.....	4
Position 2.....	4
Edges to Face Group.....	4
Inputs.....	4
Boundary Edges.....	4
Outputs.....	4
Face Group ID.....	4
Face Area.....	4
Outputs.....	4
Area.....	4
Face Neighbours.....	5
Outputs.....	5
Vertex Count.....	5

Face Count.....	5
Face Group Boundaries.....	5
Inputs.....	5
Face Set.....	5
Outputs.....	5
Boundary Edges.....	5
Face Count.....	5
Is Face Planar.....	5
Inputs.....	5
Threshold.....	5
Outputs.....	5
Planar.....	5
Is Shade Smooth.....	6
Outputs.....	6
Smooth.....	6
Mesh Island.....	6
Outputs.....	6
Index.....	6
Shortest Edge Path.....	6
Input.....	6
End Vertex.....	6
Edge Cost.....	6
Outputs.....	6
Next Vertex Index.....	6
Total Cost.....	6
Vertex Neighbors.....	6
Outputs.....	7
Vertex Count.....	7
Face Count.....	7

Add menu - Mesh - Read

Nodes to modify the mesh geometry.

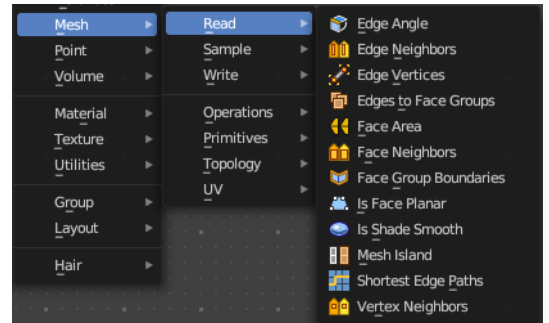

Edge Angle

Calculates the angle in radians between two faces that meet at an edge. Without two faces on the edge, the angle will be 0.



Outputs

Unsigned Angle

The unsigned output angle. The shortest angle will be picked.

Signed Angle

The signed angle between the two faces, where Convex angles are positive and Concave angles are negative. This calculation is slower than the unsigned angle.

Edge Neighbours

Outputs the number of faces connected to each edge.

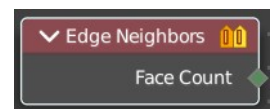

Outputs

Face Count

The number of faces.

Edge Vertices

Outputs the index and position of the two vertices that defines an edge. Index outputs an integer. Position a vector.



Outputs

Vertex Index 1

The index of the first vertice.

Vertex Index 2

The index of the second vertice.

Position 1

The position of the first vertice.

Position 2

The position of the second vertice.

Edges to Face Group

Group Faces into regions, surrounded by the selected boundary edges.



Inputs

Boundary Edges

The input edges.

Outputs

Face Group ID

The output face group.

Face Area

Gives each face area a unique id. Which can be used in a capture attribute for example, to create instances of other geometry to this now unique face areas.

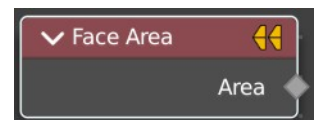

Outputs

Area

The face area output.

Face Neighbours

Outputs the number of vertices or faces connected to each face.

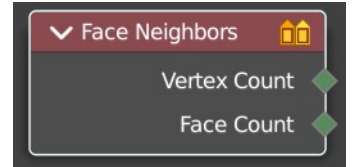

Outputs

Vertex Count

The vertex count for the face neighbors.

Face Count

The face count for the face neighbors.

Face Group Boundaries

Find edges on the boundaries between face sets

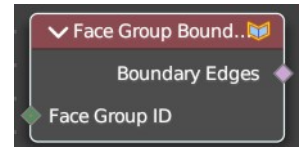

Inputs

Face Set

The input face sets to calculate the boundaries from.

Outputs

Boundary Edges

The edges that lies on the boundaries between the different face sets

Face Count

The face count for the face neighbors.

Is Face Planar

Returns true if all of the points of the evaluated face are on the same plane.

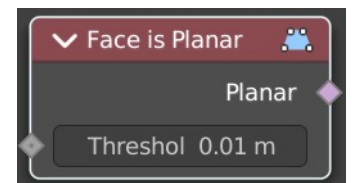

Inputs

Threshold

The threshold to consider the points to be at the same plane.

Outputs

Planar

True if the face is planar.

Is Shade Smooth

Retreives if the geometry is shaded smooth.

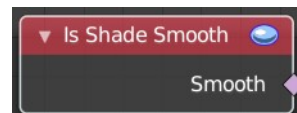

Outputs

Smooth

Smooth output.

Mesh Island

Outputs a separate index for each mesh island. The indices are based on the order of the lowest-numbered vertex in each island.



Outputs

Index

The index output.

Shortest Edge Path

Calculates the shortest path from multiple start points.

Input

End Vertex

The last point of the path.

Edge Cost

The amount of calculation to find the shortest path.

Outputs

Next Vertex Index

The vertices index of the shortest path.

Total Cost

The calculation amount.

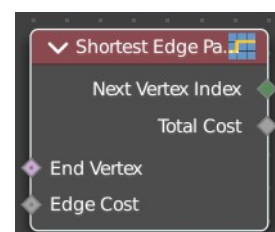

Vertex Neighbors

Outputs the number of vertices or faces connected to each vertex.

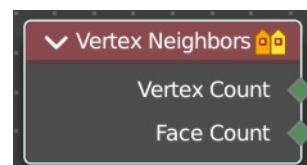

Outputs

Vertex Count

The vertex count for the vertex neighbors.

Face Count

The face count for the vertex neighbors.

12.1.24 Editors - Geometry Nodes Editor - Header - Add Menu - Mesh - Sample

Table of content

Detailed table of content.....	1
Add menu - Mesh - Sample.....	2
Sample Nearest Surface.....	2
Sample UV Surface.....	2

Detailed table of content

Detailed table of content

Detailed table of content.....	1
Add menu - Mesh - Sample.....	2
Sample Nearest Surface.....	2
Inputs.....	2
Mesh.....	2
Value.....	2
Sample Position.....	2
Properties.....	2
Data Type.....	2
Outputs.....	2
Value.....	2
Sample UV Surface.....	2
Inputs.....	2
Mesh.....	2
Value.....	3
Source UV Map.....	3
Sample UV.....	3
Properties.....	3
Data Type.....	3
Outputs.....	3
Value.....	3
Is Valid.....	3

Add menu - Mesh - Sample

Nodes to modify the mesh geometry.

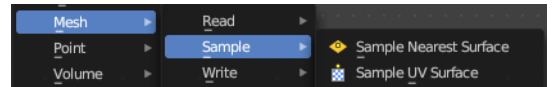

Sample Nearest Surface

Calculate the interpolated value of a mesh attribute on the closest point of its surface.

Inputs

Mesh

Input mesh.

Value

The value to calculate.

Sample Position

The sample position to calculate.

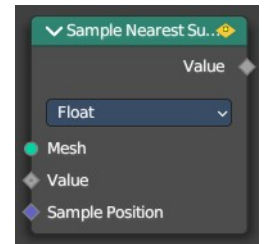

Properties

Data Type

Which data to calculate.

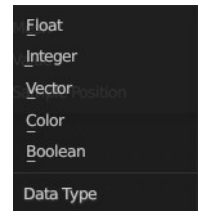

Outputs

Value

The output value.

Sample UV Surface

Calculate the interpolated value of a mesh attribute at a UV coordinate.

Inputs

Mesh

Input mesh.

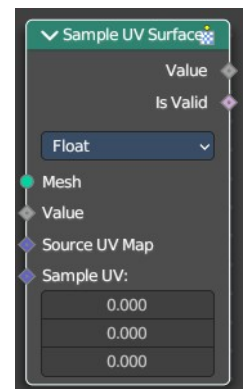

Value

The value to calculate.

Source UV Map

The input UV map.

Sample UV

The sample position to calculate.

Properties

Data Type

Which data to calculate.

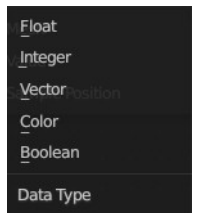

Outputs

Value

The output value.

Is Valid

Whether the node could find a single face to sample at the uv coordinate.

12.1.15 Editors - Geometry Nodes Editor - Header - Add Menu - Mesh

Table of content

Detailed table of content.....	1
Add menu - Mesh.....	6
Dual Mesh.....	6
Edge Paths to Curves.....	6
Edge Path to Selection.....	7
Extrude Mesh.....	7
Flip Faces.....	8
Mesh Boolean.....	9
Mesh to Curve.....	9
Mesh to Points.....	10
Mesh to Volume.....	11
Sample Nearest Surface.....	11
Sample UV Surface.....	12
Split Edges.....	13
Subdivide Mesh.....	13
Subdivision Surface.....	14
Triangulate.....	14
Scale Elements.....	16
Edge Angle.....	16
Edge Neighbours.....	17
Edge Vertices.....	17
Edges to Face Group.....	18
Face Area.....	18
Face Neighbours.....	18
Face Group Boundaries.....	18
Face is Planar.....	19
Mesh Island.....	19
Is Shade Smooth.....	19
Vertex Neighbors.....	20
Shortest Edge Path.....	20
Set Shade Smooth.....	20

Detailed table of content

Detailed table of content

Detailed table of content.....	1
Add menu - Mesh.....	6
Dual Mesh.....	6
Inputs.....	6
Mesh.....	6
Keep Boundaries.....	6
Outputs.....	6
Dual Mesh.....	6
Edge Paths to Curves.....	6

Inputs.....	6
Mesh.....	6
Start Vertices.....	6
Next Vertex Index.....	7
Outputs.....	7
Curves.....	7
Edge Path to Selection.....	7
Inputs.....	7
Start Vertices.....	7
Next Vertex Index.....	7
Outputs.....	7
Selection.....	7
Extrude Mesh.....	7
Inputs.....	7
Mesh.....	7
Selection.....	7
Offset.....	7
Offset Scale.....	7
Individual.....	8
Properties.....	8
Mode.....	8
Outputs.....	8
Mesh.....	8
Top.....	8
Side.....	8
Flip Faces.....	8
Inputs.....	8
Mesh.....	8
Selection.....	8
Outputs.....	8
Dual Mesh.....	8
Mesh Boolean.....	9
Inputs.....	9
Geometry 1, 2.....	9
Self Intersect.....	9
Hole Tolerant.....	9
Properties.....	9
Operation.....	9
Intersect.....	9
Union.....	9
Difference.....	9
Output.....	9
Geometry.....	9
Mesh to Curve.....	9
Inputs.....	9
Mesh.....	9
Selection.....	10
Outputs.....	10
Curve.....	10
Mesh to Points.....	10
Inputs.....	10
Mesh.....	10
Selection.....	10

Position.....	10
Radius.....	10
Properties.....	10
Mode.....	10
Outputs.....	10
Curve.....	10
Mesh to Volume.....	11
Inputs.....	11
Mesh.....	11
Density.....	11
Voxel Amount / Voxel Size.....	11
Exterior Bandwidth.....	11
Interior Bandwidth.....	11
Properties.....	11
Resolution.....	11
Outputs.....	11
Volume.....	11
Sample Nearest Surface.....	11
Inputs.....	11
Mesh.....	11
Value.....	11
Sample Position.....	12
Properties.....	12
Data Type.....	12
Outputs.....	12
Value.....	12
Sample UV Surface.....	12
Inputs.....	12
Mesh.....	12
Value.....	12
Source UV Map.....	12
Sample UV.....	12
Properties.....	12
Data Type.....	12
Outputs.....	13
Value.....	13
Is Valid.....	13
Split Edges.....	13
Inputs.....	13
Mesh.....	13
Selection.....	13
Outputs.....	13
Mesh.....	13
Subdivide Mesh.....	13
Inputs.....	13
Geometry.....	13
Level.....	13
Outputs.....	13
Geometry.....	13
Subdivision Surface.....	14
Inputs.....	14
Geometry.....	14
Level.....	14

Creases.....	14
Properties.....	14
UV Smooth.....	14
Boundary Smooth.....	14
Outputs.....	14
Geometry.....	14
Triangulate.....	14
Inputs.....	15
Geometry.....	15
Minimum Vertices.....	15
Properties.....	15
Quad Method.....	15
Beauty.....	15
Fixed.....	15
Fixed Alternate.....	15
Shortest Diagonal.....	15
Polygon Method.....	15
Beauty.....	15
Clip.....	15
Outputs.....	15
Geometry.....	15
Scale Elements.....	16
Inputs.....	16
Geometry.....	16
Selection.....	16
Scale.....	16
Center.....	16
Axis.....	16
Properties.....	16
Domain.....	16
Scale Mode.....	16
Outputs.....	16
Geometry.....	16
Edge Angle.....	16
Outputs.....	17
Unsigned Angle.....	17
Signed Angle.....	17
Edge Neighbours.....	17
Outputs.....	17
Face Count.....	17
Edge Vertices.....	17
Outputs.....	17
Vertex Index 1.....	17
Vertex Index 2.....	17
Position 1.....	17
Position 2.....	17
Edges to Face Group.....	18
Inputs.....	18
Boundary Edges.....	18
Outputs.....	18
Face Group ID.....	18
Face Area.....	18
Outputs.....	18

Area.....	18
Face Neighbours.....	18
Outputs.....	18
Vertex Count.....	18
Face Count.....	18
Face Group Boundaries.....	18
Inputs.....	19
Face Set.....	19
Outputs.....	19
Boundary Edges.....	19
Face Count.....	19
Face is Planar.....	19
Inputs.....	19
Threshold.....	19
Outputs.....	19
Planar.....	19
Mesh Island.....	19
Outputs.....	19
Index.....	19
Is Shade Smooth.....	19
Outputs.....	20
Smooth.....	20
Vertex Neighbors.....	20
Outputs.....	20
Vertex Count.....	20
Face Count.....	20
Shortest Edge Path.....	20
Input.....	20
End Vertex.....	20
Edge Cost.....	20
Outputs.....	20
Next Vertex Index.....	20
Total Cost.....	20
Set Shade Smooth.....	20
Input.....	21
Geometry.....	21
Selection.....	21
Shade Smooth.....	21
Outputs.....	21
Geometry.....	21

Add menu - Mesh

Nodes to modify the mesh geometry.

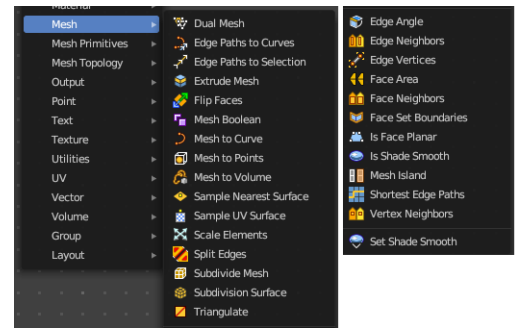

Dual Mesh

The Dual Mesh node calculates the dual of the input mesh. This means that faces get replaced with vertices and vertices with faces.

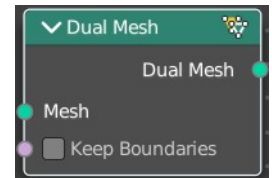

Inputs

Mesh

The input mesh.

Keep Boundaries

Keep the (non-manifold) boundaries of the mesh intact.

Outputs

Dual Mesh

The output mesh.

Edge Paths to Curves

Converts Edge Paths to Curves.

Inputs

Mesh

The input mesh.

Start Vertices

The start vertices of the edge path.

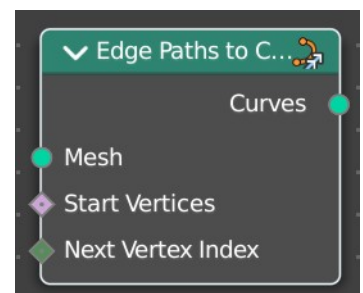

Next Vertex Index

The edge path by index.

Outputs

Curves

The output curve.

Edge Path to Selection

Calculates an edge path, and converts it to a selection

Inputs

Start Vertices

The start vertices of the edge path.

Next Vertex Index

The edge path by index.

Outputs

Selection

The selection

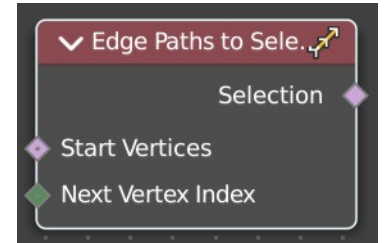

Extrude Mesh

Extrudes out geometry at the selection by a given amount.

Inputs

Mesh

The input mesh.

Selection

A selection of the mesh.

Offset

The offset amount.

Offset Scale

The offset scale. Without an offset this is equal the amount.

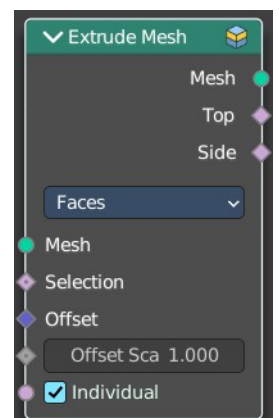

Individual

Just Faces mode. Extrude out individual faces.

Properties

Mode

What kind of elements to extrude out. Vertices, Edges or Faces.

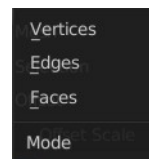

Outputs

Mesh

The output mesh.

Top

The top elements of the extrusion.

Side

The side elements of the extrusion.

Flip Faces

Flips the winding order of the selected faces.

Blender developers decided not to call it Flip Normals. Since "normals are derived data, changing them is only a side effect." However, what the node does is in fact to flip the normals.

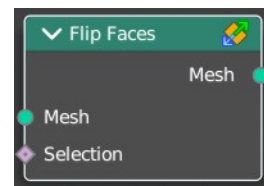

Inputs

Mesh

The input mesh.

Selection

A selection of the input mesh.

Outputs

Dual Mesh

The output mesh.

Mesh Boolean

The Boolean Node allows you to cut, subtract, and join the geometry of two inputs. This node offers the same operations as the Boolean modifier.

Inputs

Geometry 1, 2

Standard geometry input.

Self Intersect

Allow self intersection.

Hole Tolerant

Allow holes.

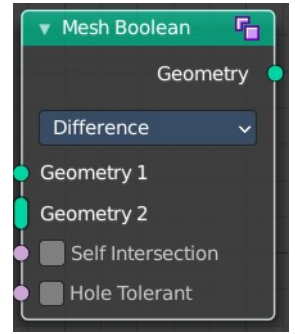

Properties

Operation

The boolean operation.

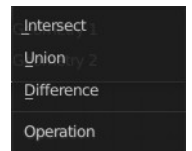

Intersect

Produce a new geometry containing only the volume inside of both geometry 1 and geometry 2.

Union

The two input pieces of geometry are joined, then any interior elements are removed.

Difference

Geometry 2 is subtracted from geometry 1 (everything outside of geometry 2 is kept).

Output

Geometry

Standard geometry output.

Mesh to Curve

Converts a mesh geometry to a curve geometry.

Inputs

Mesh

Input mesh.

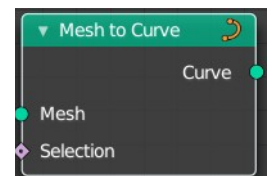

Selection

A selection of the input mesh.

Outputs

Curve

Standard curve output.

Mesh to Points

Converts a mesh geometry to a point geometry.

Inputs

Mesh

Input mesh.

Selection

A selection of the input mesh.

Position

The position of the points.

Radius

The radius of the points

Properties

Mode

What geometry to convert to points.

Outputs

Curve

Standard curve output.

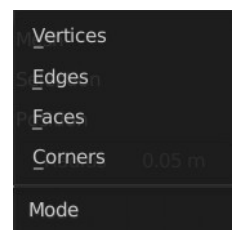
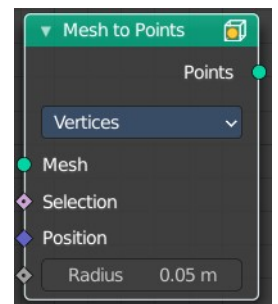

Mesh to Volume

Converts a mesh geometry to a Volume.

Inputs

Mesh

Input mesh.

Density

The density of the volume

Voxel Amount / Voxel Size

The voxel amount / the voxel size

Exterior Bandwidth

How much exterior bandwidth is calculated outside of the mesh. The larger the value the more unnecessary ray calculations happens.

Interior Bandwidth

Where to start the calculation inside of the volume.

Properties

Resolution

How to calculate the volume. Based of the size or based at the amount.

Outputs

Volume

The volume output.

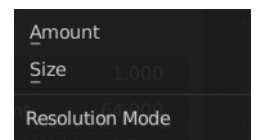
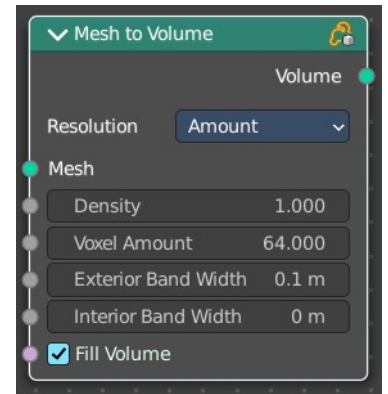

Sample Nearest Surface

Calculate the interpolated value of a mesh attribute on the closest point of its surface.

Inputs

Mesh

Input mesh.

Value

The value to calculate.

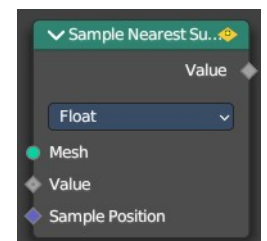

Sample Position

The sample position to calculate.

Properties

Data Type

Which data to calculate.

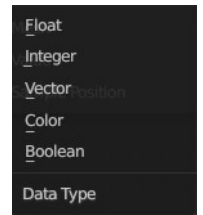

Outputs

Value

The output value.

Sample UV Surface

Calculate the interpolated value of a mesh attribute at a UV coordinate.

Inputs

Mesh

Input mesh.

Value

The value to calculate.

Source UV Map

The input UV map.

Sample UV

The sample position to calculate.

Properties

Data Type

Which data to calculate.

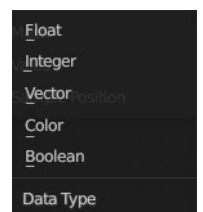
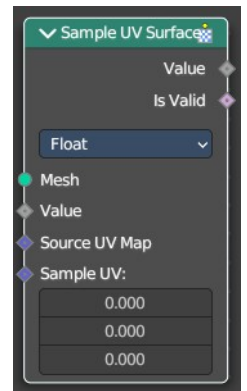

Outputs

Value

The output value.

Is Valid

Whether the node could find a single face to sample at the uv coordinate.

Split Edges

Splits the edges of the geometry.

Note that splitting edges breaks the mesh topology.

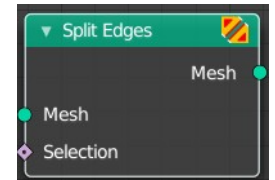

Inputs

Mesh

Input mesh.

Selection

A selection of the input mesh.

Outputs

Mesh

Standard Mesh output.

Subdivide Mesh

Subdivides the geometry by a simple division.

Inputs

Geometry

Standard geometry input.

Level

To which degree the geometry will be deformed.

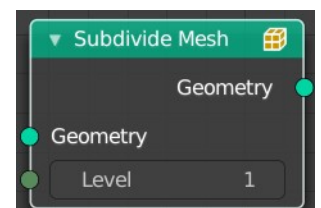

Outputs

Geometry

Standard geometry output.

Subdivision Surface

The Subdivision Surface node subdivides the geometry using Catmull-Clark deformation.

Inputs

Geometry

Standard geometry input.

Level

To which degree the geometry will be deformed.

Creases

Control how smooth edges should be with Weighted Edge Creases.

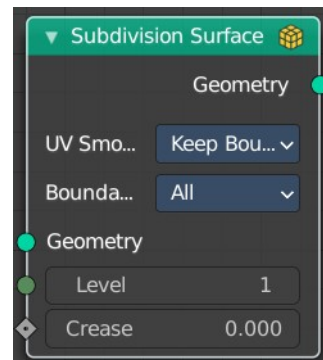

Properties

UV Smooth

The method to deal with smoothing the UV.

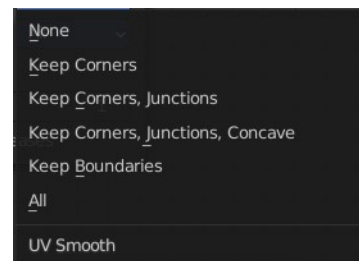

Boundary Smooth

Controls if open boundaries and corners are smooth.

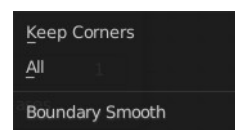

Outputs

Geometry

Standard geometry output.

Triangulate

The Triangulate node triangulates all faces in a mesh.

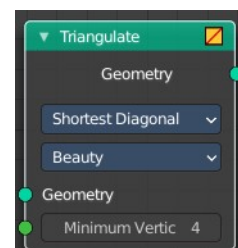

Inputs

Geometry

Standard geometry input.

Minimum Vertices

Minimum number of vertices a face must have to be triangulated. For example, setting this value to 5, will prevent triangulation of Quads and only triangulate N-gons.

Properties

Quad Method

A quad is a polygon with four edges.

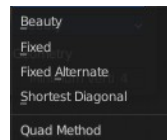

Beauty

Split the quads in nice triangles, slower method.

Fixed

Split the quads on their 1st and 3rd vertices.

Fixed Alternate

Split the quads on their 2nd and 4th vertices.

Shortest Diagonal

Split the quads based on the diagonal distance between their vertices.

Polygon Method

Meant are N-Gons. Faces with more than four edges. Tris, Quads and N-Gons are all Polygons.

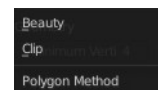

Beauty

Arrange the new triangles nicely, slower method.

Clip

Split the polygons using an ear-clipping algorithm (gives similar results to the tessellation used for the viewport rendering).

Outputs

Geometry

Standard geometry output.

Scale Elements

Allows to scale the selected elements.

Inputs

Geometry

Standard geometry input.

Selection

A selection of the geometry.

Scale

The scale factor

Center

The center of the scaling.

Axis

Scale Mode Single axis only. Scale the selection separately along its single axis.

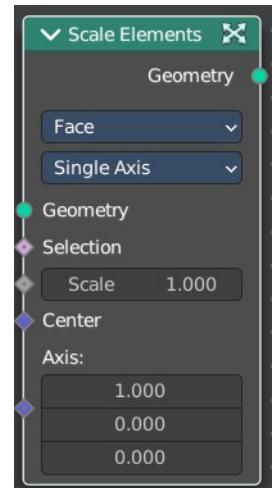
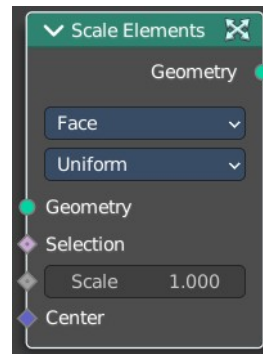

Properties

Domain

What kind of elements to scale.

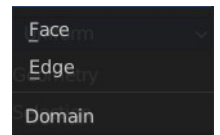

Scale Mode

Uniform scales uniformly in all three world coordinates.

Single Axis scales separately in the single axis.

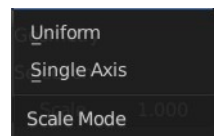

Outputs

Geometry

The output geometry.

Edge Angle

Calculates the angle in radians between two faces that meet at an edge. Without two faces on the edge, the angle will be 0.



Outputs

Unsigned Angle

The unsigned output angle. The shortest angle will be picked.

Signed Angle

The signed angle between the two faces, where Convex angles are positive and Concave angles are negative. This calculation is slower than the unsigned angle.

Edge Neighbours

Outputs the number of faces connected to each edge.

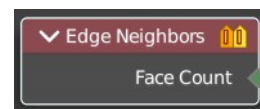

Outputs

Face Count

The number of faces.

Edge Vertices

Outputs the index and position of the two vertices that defines an edge. Index outputs an integer. Position a vector.

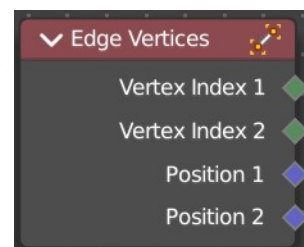

Outputs

Vertex Index 1

The index of the first vertice.

Vertex Index 2

The index of the second vertice.

Position 1

The position of the first vertice.

Position 2

The position of the second vertice.

Edges to Face Group

Group Faces into regions, surrounded by the selected boundary edges.



Inputs

Boundary Edges

The input edges.

Outputs

Face Group ID

The output face group.

Face Area

Gives each face area a unique id. Which can be used in a capture attribute for example, to create instances of other geometry to this now unique face areas.

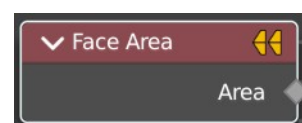

Outputs

Area

The face area output.

Face Neighbours

Outputs the number of vertices or faces connected to each face.

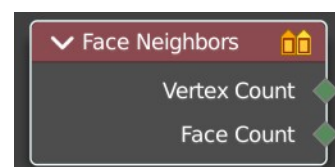

Outputs

Vertex Count

The vertex count for the face neighbors.

Face Count

The face count for the face neighbors.

Face Group Boundaries

Find edges on the boundaries between face sets

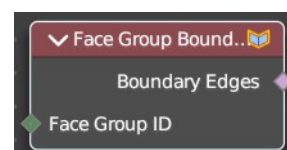

Inputs

Face Set

The input face sets to calculate the boundaries from.

Outputs

Boundary Edges

The edges that lies on the boundaries between the different face sets

Face Count

The face count for the face neighbors.

Face is Planar

Returns true if all of the points of the evaluated face are on the same plane.

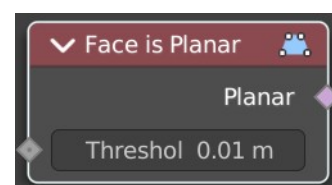

Inputs

Threshold

The threshold to consider the points to be at the same plane.

Outputs

Planar

True if the face is planar.

Mesh Island

Outputs a separate index for each mesh island. The indices are based on the order of the lowest-numbered vertex in each island.



Outputs

Index

The index output.

Is Shade Smooth

Retreives if the geometry is shaded smooth.

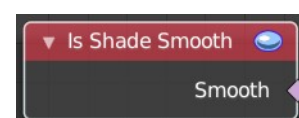

Outputs

Smooth

Smooth output.

Vertex Neighbors

Outputs the number of vertices or faces connected to each vertex.

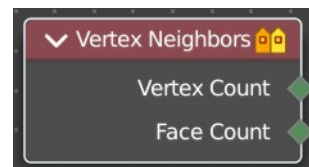

Outputs

Vertex Count

The vertex count for the vertex neighbors.

Face Count

The face count for the vertex neighbors.

Shortest Edge Path

Calculates the shortest path from multiple start points.

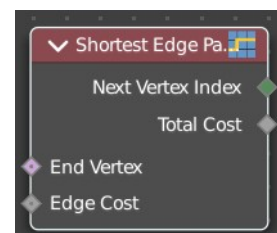

Input

End Vertex

The last point of the path.

Edge Cost

The amount of calculation to find the shortest path.

Outputs

Next Vertex Index

The vertices index of the shortest path.

Total Cost

The calculation amount.

Set Shade Smooth

Retreives if the geometry is shaded smooth.

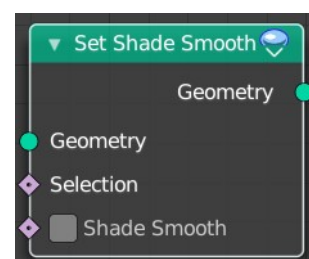

Input

Geometry

Input mesh.

Selection

A selection of the input mesh.

Shade Smooth

Set the shading to smooth.

Outputs

Geometry

Geometry output.

12.1.26 Editors - Geometry Nodes Editor - Header - Add Menu - Mesh

Table of content

Detailed table of content.....	1
Add menu - Mesh - Operations.....	4
Dual Mesh.....	4
Edge Paths to Curves.....	4
Edge Path to Selection.....	5
Extrude Mesh.....	5
Flip Faces.....	6
Mesh Boolean.....	7
Mesh to Curve.....	7
Mesh to Points.....	8
Mesh to Volume.....	9
Scale Elements.....	10
Split Edges.....	10
Subdivide Mesh.....	11
Subdivision Surface.....	11
Triangulate.....	12

Detailed table of content

Detailed table of content

Detailed table of content.....	1
Add menu - Mesh - Operations.....	4
Dual Mesh.....	4
Inputs.....	4
Mesh.....	4
Keep Boundaries.....	4
Outputs.....	4
Dual Mesh.....	4
Edge Paths to Curves.....	4
Inputs.....	4
Mesh.....	4
Start Vertices.....	5
Next Vertex Index.....	5
Outputs.....	5
Curves.....	5
Edge Path to Selection.....	5
Inputs.....	5
Start Vertices.....	5
Next Vertex Index.....	5
Outputs.....	5
Selection.....	5
Extrude Mesh.....	5
Inputs.....	5
Mesh.....	5

Selection.....	5
Offset.....	5
Offset Scale.....	6
Individual.....	6
Properties.....	6
Mode.....	6
Outputs.....	6
Mesh.....	6
Top.....	6
Side.....	6
Flip Faces.....	6
Inputs.....	6
Mesh.....	6
Selection.....	6
Outputs.....	6
Dual Mesh.....	6
Mesh Boolean.....	7
Inputs.....	7
Geometry 1, 2.....	7
Self Intersect.....	7
Hole Tolerant.....	7
Properties.....	7
Operation.....	7
Intersect.....	7
Union.....	7
Difference.....	7
Output.....	7
Geometry.....	7
Mesh to Curve.....	7
Inputs.....	8
Mesh.....	8
Selection.....	8
Outputs.....	8
Curve.....	8
Mesh to Points.....	8
Inputs.....	8
Mesh.....	8
Selection.....	8
Position.....	8
Radius.....	8
Properties.....	8
Mode.....	8
Outputs.....	8
Curve.....	8
Mesh to Volume.....	9
Inputs.....	9
Mesh.....	9
Density.....	9
Voxel Amount / Voxel Size.....	9
Exterior Bandwidth.....	9
Interior Bandwidth.....	9
Properties.....	9
Resolution.....	9

Outputs.....	9
Volume.....	9
Scale Elements.....	10
Inputs.....	10
Geometry.....	10
Selection.....	10
Scale.....	10
Center.....	10
Axis.....	10
Properties.....	10
Domain.....	10
Scale Mode.....	10
Outputs.....	10
Geometry.....	10
Split Edges.....	10
Inputs.....	11
Mesh.....	11
Selection.....	11
Outputs.....	11
Mesh.....	11
Subdivide Mesh.....	11
Inputs.....	11
Geometry.....	11
Level.....	11
Outputs.....	11
Geometry.....	11
Subdivision Surface.....	11
Inputs.....	11
Geometry.....	11
Level.....	11
Creases.....	12
Properties.....	12
UV Smooth.....	12
Boundary Smooth.....	12
Outputs.....	12
Geometry.....	12
Triangulate.....	12
Inputs.....	12
Geometry.....	12
Minimum Vertices.....	12
Properties.....	12
Quad Method.....	12
Beauty.....	12
Fixed.....	13
Fixed Alternate.....	13
Shortest Diagonal.....	13
Polygon Method.....	13
Beauty.....	13
Clip.....	13
Outputs.....	13
Geometry.....	13

Add menu - Mesh - Operations

Nodes to modify the mesh geometry.

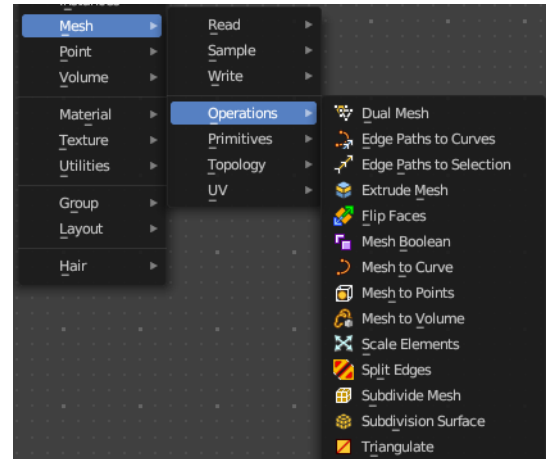

Dual Mesh

The Dual Mesh node calculates the dual of the input mesh. This means that faces get replaced with vertices and vertices with faces.

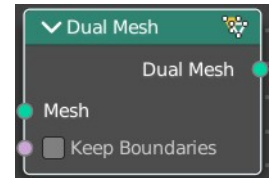

Inputs

Mesh

The input mesh.

Keep Boundaries

Keep the (non-manifold) boundaries of the mesh intact.

Outputs

Dual Mesh

The output mesh.

Edge Paths to Curves

Converts Edge Paths to Curves.

Inputs

Mesh

The input mesh.

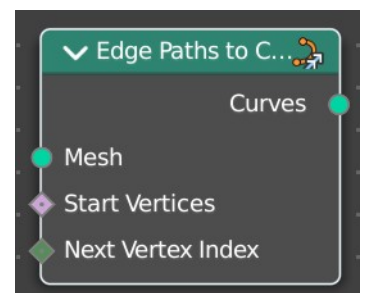

Start Vertices

The start vertices of the edge path.

Next Vertex Index

The edge path by index.

Outputs

Curves

The output curve.

Edge Path to Selection

Calculates an edge path, and converts it to a selection

Inputs

Start Vertices

The start vertices of the edge path.

Next Vertex Index

The edge path by index.

Outputs

Selection

The selection

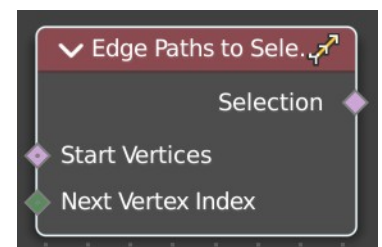

Extrude Mesh

Extrudes out geometry at the selection by a given amount.

Inputs

Mesh

The input mesh.

Selection

A selection of the mesh.

Offset

The offset amount.

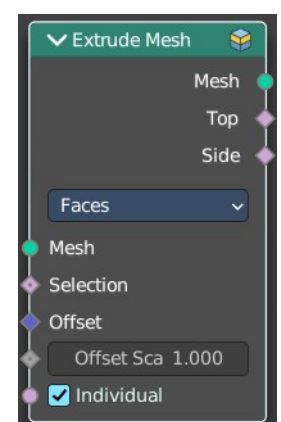

Offset Scale

The offset scale. Without an offset this is equal the amount.

Individual

Just Faces mode. Extrude out individual faces.

Properties

Mode

What kind of elements to extrude out. Vertices, Edges or Faces.

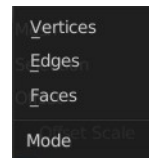

Outputs

Mesh

The output mesh.

Top

The top elements of the extrusion.

Side

The side elements of the extrusion.

Flip Faces

Flips the winding order of the selected faces.

Blender developers decided not to call it Flip Normals. Since "normals are derived data, changing them is only a side effect." However, what the node does is in fact to flip the normals.

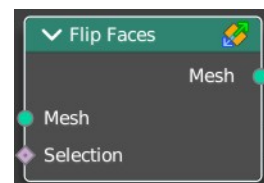

Inputs

Mesh

The input mesh.

Selection

A selection of the input mesh.

Outputs

Dual Mesh

The output mesh.

Mesh Boolean

The Boolean Node allows you to cut, subtract, and join the geometry of two inputs. This node offers the same operations as the Boolean modifier.

Inputs

Geometry 1, 2

Standard geometry input.

Self Intersect

Allow self intersection.

Hole Tolerant

Allow holes.

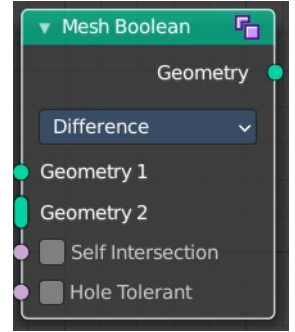

Properties

Operation

The boolean operation.

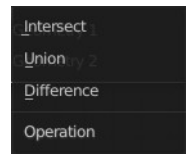

Intersect

Produce a new geometry containing only the volume inside of both geometry 1 and geometry 2.

Union

The two input pieces of geometry are joined, then any interior elements are removed.

Difference

Geometry 2 is subtracted from geometry 1 (everything outside of geometry 2 is kept).

Output

Geometry

Standard geometry output.

Mesh to Curve

Converts a mesh geometry to a curve geometry.

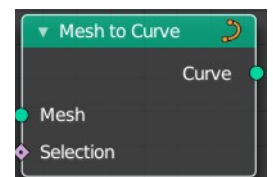

Inputs

Mesh

Input mesh.

Selection

A selection of the input mesh.

Outputs

Curve

Standard curve output.

Mesh to Points

Converts a mesh geometry to a point geometry.

Inputs

Mesh

Input mesh.

Selection

A selection of the input mesh.

Position

The position of the points.

Radius

The radius of the points

Properties

Mode

What geometry to convert to points.

Outputs

Curve

Standard curve output.

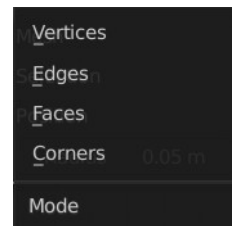
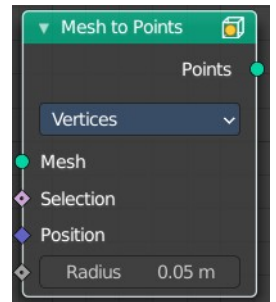

Mesh to Volume

Converts a mesh geometry to a Volume.

Inputs

Mesh

Input mesh.

Density

The density of the volume

Voxel Amount / Voxel Size

The voxel amount / the voxel size

Exterior Bandwidth

How much exterior bandwidth is calculated outside of the mesh. The larger the value the more unnecessary ray calculations happens.

Interior Bandwidth

Where to start the calculation inside of the volume.

Properties

Resolution

How to calculate the volume. Based of the size or based at the amount.

Outputs

Volume

The volume output.

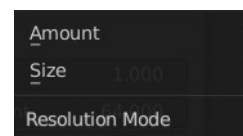
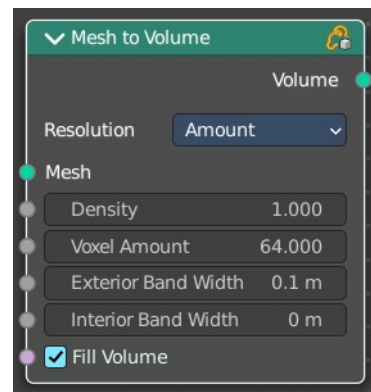

Scale Elements

Allows to scale the selected elements.

Inputs

Geometry

Standard geometry input.

Selection

A selection of the geometry.

Scale

The scale factor

Center

The center of the scaling.

Axis

Scale Mode Single axis only. Scale the selection separately along its single axis.

Properties

Domain

What kind of elements to scale.

Scale Mode

Uniform scales uniformly in all three world coordinates.

Single Axis scales separately in the single axis.

Outputs

Geometry

The output geometry.

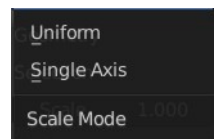
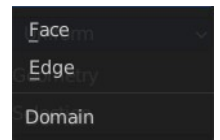
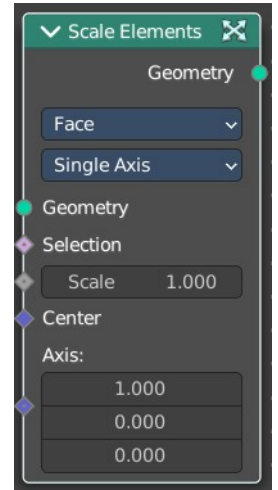
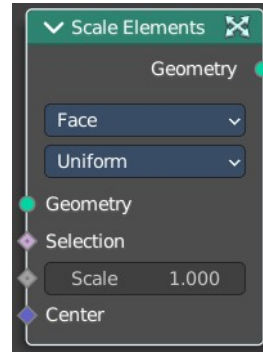

Split Edges

Splits the edges of the geometry.

Note that splitting edges breaks the mesh topology.

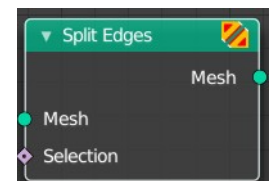

Inputs

Mesh

Input mesh.

Selection

A selection of the input mesh.

Outputs

Mesh

Standard Mesh output.

Subdivide Mesh

Subdivides the geometry by a simple division.

Inputs

Geometry

Standard geometry input.

Level

To which degree the geometry will be deformed.

Outputs

Geometry

Standard geometry output.

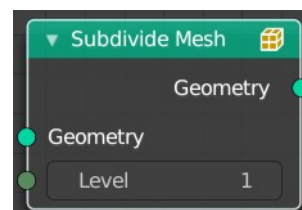

Subdivision Surface

The Subdivision Surface node subdivides the geometry using Catmull-Clark deformation.

Inputs

Geometry

Standard geometry input.

Level

To which degree the geometry will be deformed.

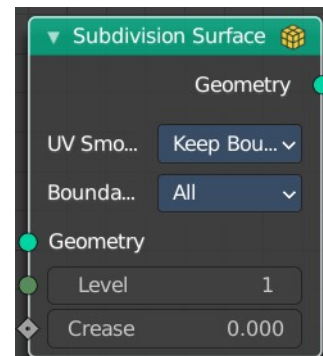

Creases

Control how smooth edges should be with Weighted Edge Creases.

Properties

UV Smooth

The method to deal with smoothing the UV.

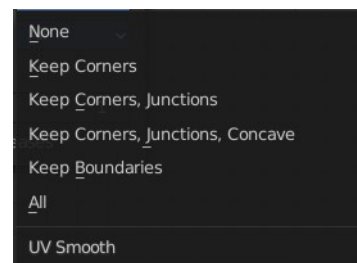

Boundary Smooth

Controls if open boundaries and corners are smooth.

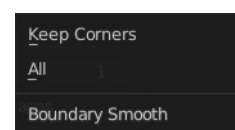

Outputs

Geometry

Standard geometry output.

Triangulate

The Triangulate node triangulates all faces in a mesh.

Inputs

Geometry

Standard geometry input.

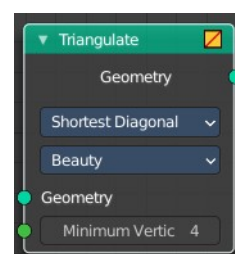

Minimum Vertices

Minimum number of vertices a face must have to be triangulated. For example, setting this value to 5, will prevent triangulation of Quads and only triangulate N-gons.

Properties

Quad Method

A quad is a polygon with four edges.

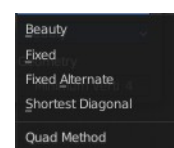

Beauty

Split the quads in nice triangles, slower method.

Fixed

Split the quads on their 1st and 3rd vertices.

Fixed Alternate

Split the quads on their 2nd and 4th vertices.

Shortest Diagonal

Split the quads based on the diagonal distance between their vertices.

Polygon Method

Meant are N-Gons. Faces with more than four edges. Tris, Quads and N-Gons are all Polygons.



Beauty

Arrange the new triangles nicely, slower method.

Clip

Split the polygons using an ear-clipping algorithm (gives similar results to the tessellation used for the viewport rendering).

Outputs

Geometry

Standard geometry output.

12.1.27 Editors - Geometry Nodes Editor - Header - Add Menu - Mesh Primitives

Table of content

Detailed table of content.....	1
Add menu - Mesh Primitives.....	4
Cone.....	4
Cube.....	5
Cylinder.....	5
Grid.....	6
Ico Sphere.....	7
Mesh Circle.....	7
Mesh Line.....	8
UV Sphere.....	9

Detailed table of content

Detailed table of content

Detailed table of content.....	1
Add menu - Mesh Primitives.....	4
Cone.....	4
Input.....	4
Vertices.....	4
Radius Top.....	4
Side Segments.....	4
Fill Segments.....	4
Radius Bottom.....	4
Depth.....	4
Properties.....	4
Fill Type.....	4
None.....	4
N-Gon.....	4
Triangles.....	5
Outputs.....	5
Geometry.....	5
Cube.....	5
Input.....	5
Size.....	5
Vertices.....	5
Output.....	5
Geometry.....	5
Cylinder.....	5
Input.....	5
Vertices.....	5
Side Segments.....	5
Fill Segments.....	5
Radius.....	6
Depth.....	6

Properties.....	6
Fill Type.....	6
None.....	6
N-Gon.....	6
Triangles.....	6
Outputs.....	6
Geometry.....	6
Grid.....	6
Input.....	6
Size.....	6
Vertices X.....	6
Vertices Y.....	6
Outputs.....	7
Geometry.....	7
Ico Sphere.....	7
Input.....	7
Radius.....	7
Subdivisions.....	7
Outputs.....	7
Geometry.....	7
Mesh Circle.....	7
Input.....	7
Vertices.....	7
Radius.....	7
Properties.....	7
Fill Type.....	7
None.....	8
N-Gon.....	8
Triangles.....	8
Outputs.....	8
Geometry.....	8
Mesh Line.....	8
Input.....	8
Count.....	8
Start Location.....	8
Offset.....	8
Properties.....	8
Mode.....	8
Offset.....	8
End Points.....	8
Count Mode.....	8
Count.....	8
End Points.....	9
Outputs.....	9
Geometry.....	9
UV Sphere.....	9
Input.....	9
Segments.....	9
Rings.....	9
Radius.....	9
Outputs.....	9
Geometry.....	9

Add menu - Mesh - Primitives

Nodes to modify the mesh geometry.

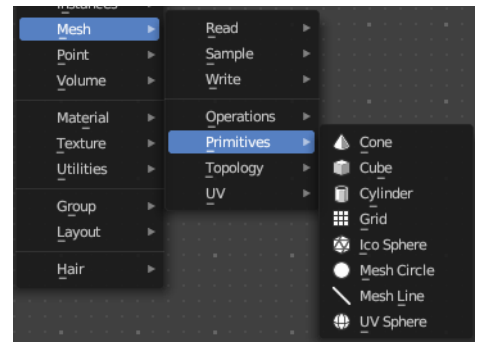

Cone

Cone creates a Cone mesh.

Input

Vertices

Number of vertices.

Radius Top

The initial radius at the top.

Side Segments

Adjust the number of segments at the side.

Fill Segments

Adjust the number of segments at the fill faces.

Radius Bottom

The initial radius at the bottom.

Depth

The initial height.

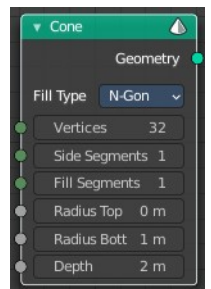

Properties

Fill Type

Defines how the Circle mesh is filled.

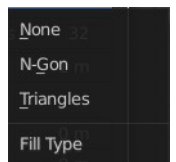

None

pure edge geometry.

N-Gon

The circle face is a N-Gon face.

Triangles

The circle face is triangulated.

Outputs

Geometry

Standard geometry output.

Cube

Cube creates a Cubeoid mesh.

Input

Size

The initial size in X , Y and Z dimensions

Vertices

How much vertices the single edges has. This allows to subdivide the cube.

Output

Geometry

Standard geometry output.

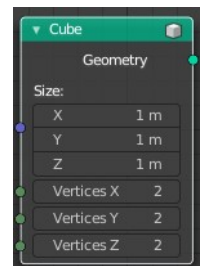

Cylinder

Cylinder creates a Cylinder mesh.

Input

Vertices

Number of vertices.

Side Segments

Adjust the number of segments at the side.

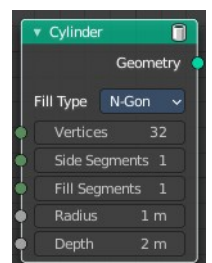

Fill Segments

Adjust the number of segments at the fill faces.

Radius

The initial radius.

Depth

The initial height.

Properties

Fill Type

Defines how the Circle mesh is filled.



None

pure edge geometry.

N-Gon

The circle face is a N-Gon face.

Triangles

The circle face is triangulated.

Outputs

Geometry

Standard geometry output.

Grid

Grid creates a grid mesh.

Input

Size

The initial size.

Vertices X

The initial number of vertices in X direction.

Vertices Y

The initial number of vertices in Y direction.

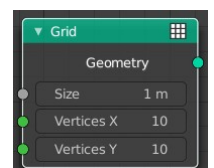

Outputs

Geometry

Standard geometry output.

Ico Sphere

Ico Sphere creates a ico Sphere mesh.

Input

Radius

The initial radius.

Subdivisions

The initial subdivisions.

Outputs

Geometry

Standard geometry output.

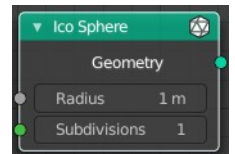

Mesh Circle

Circle creates a Circle mesh.

Input

Vertices

Number of vertices.

Radius

The initial radius.

Properties

Fill Type

Defines how the Circle mesh is filled.

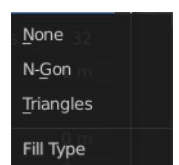
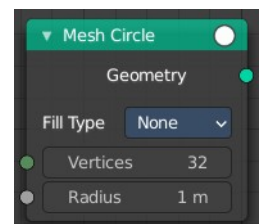

None

pure edge geometry.

N-Gon

The circle face is a N-Gon face.

Triangles

The circle face is triangulated.

Outputs

Geometry

Standard geometry output.

Mesh Line

Line creates a line mesh.

Input

Count

The initial number of segments.

Start Location

The initial location.

Offset

The initial offset.

Properties

Mode

Offset

Specify the offset from one vertice to the next.

End Points

Specify the line start and endpoints.

Count Mode

Count

Specify the number of total vertices.

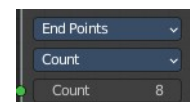
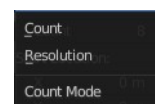
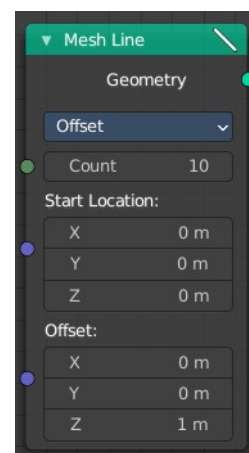

End Points

Specify the distance between the vertices.

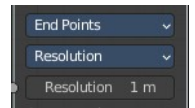

Outputs

Geometry

Standard geometry output.

UV Sphere

UV Sphere creates a uv sphere mesh.

Input

Segments

The initial number of segments.

Rings

The initial number of edgerings.

Radius

The initial radius.

Outputs

Geometry

Standard geometry output.

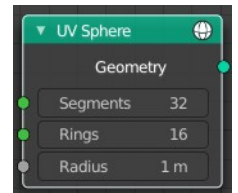

12.1.28 Editors - Geometry Nodes Editor - Header - Add Menu - Mesh Topology

Table of content

Detailed table of content.....	1
Add menu - Mesh - Topology.....	3
Corners of Edge.....	3
Corners of Face.....	3
Corners of Vertex.....	4
Edges of Corner.....	5
Edges of Vertex.....	5
Face of Corner.....	6
Offset Corner in Face.....	6
Vertex of corner.....	6

Detailed table of content

Detailed table of content

Detailed table of content.....	1
Add menu - Mesh - Topology.....	3
Corners of Edge.....	3
Input.....	3
Face Index.....	3
Weights.....	3
Sort Index.....	3
Outputs.....	3
Corner Index.....	3
Total.....	3
Corners of Face.....	3
Input.....	4
Face Index.....	4
Weights.....	4
Sort Index.....	4
Outputs.....	4
Corner Index.....	4
Total.....	4
Corners of Vertex.....	4
Input.....	4
Vertex Index.....	4
Weights.....	4
Sort Index.....	4
Outputs.....	4
Corner Index.....	4
Total.....	4
Edges of Corner.....	5
Input.....	5
Corner Index.....	5
Outputs.....	5

Next Edge Index.....	5
Previous Edge Index.....	5
Edges of Vertex.....	5
Input.....	5
Vertex Index.....	5
Weights.....	5
Sort Index.....	5
Outputs.....	5
Edge Index.....	5
Total.....	5
Face of Corner.....	6
Input.....	6
Corner Index.....	6
Outputs.....	6
Face Index.....	6
Index in Face.....	6
Offset Corner in Face.....	6
Input.....	6
Corner Index.....	6
Offset.....	6
Outputs.....	6
Corner Index.....	6
Vertex of corner.....	6
Input.....	7
Corner Index.....	7
Offset.....	7
Outputs.....	7
Vertex Index.....	7

Add menu - Mesh - Topology

Mesh topology related nodes.

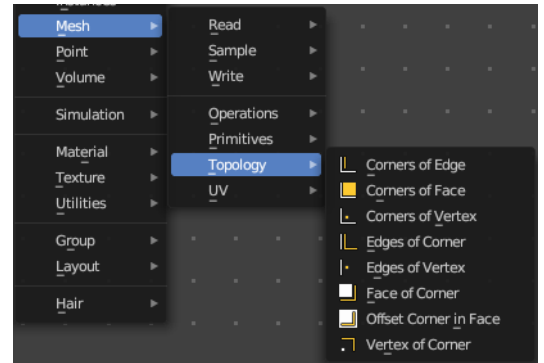

Corners of Edge

Retrieve the corners that makes up a edge.

Input

Face Index

The face to get the data from.

Weights

Values used to sort the corners of the face.

Sort Index

Which of the corners to output.

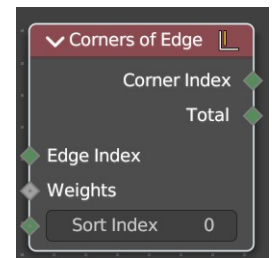

Outputs

Corner Index

The output corner.

Total

The number of corners in the face.

Corners of Face

Retrieve the corners that makes up a face.

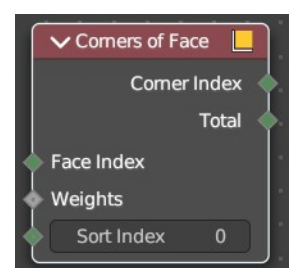

Input

Face Index

The face to get the data from.

Weights

Values used to sort the corners of the face.

Sort Index

Which of the corners to output.

Outputs

Corner Index

The output corner.

Total

The number of corners in the face.

Corners of Vertex

Retrieve face corners connected to vertices.

Input

Vertex Index

The vertice to get the data from.

Weights

Values used to sort the corners attached to the vertice.

Sort Index

Which of the corners to output.

Outputs

Corner Index

The output corner.

Total

The number of corners connected to each vertice.



Edges of Corner

Retrieve the edges of both sides of a corner.

Input

Corner Index

The corner to retrieve the data from.

Outputs

Next Edge Index

The edge behind the corner.

Previous Edge Index

The edge before the corner.



Edges of Vertex

Retrieve the edges connected to each vertex.

Input

Vertex Index

The vertice to get the data from.

Weights

Values used to sort the edges attached to the vertice.

Sort Index

Which of the edges to output.

Outputs

Edge Index

The output edge.

Total

The number of edges connected to each vertice.

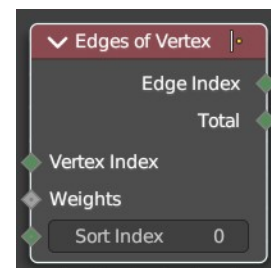

Face of Corner

Retrieve the faces connected to each corner.

Input

Corner Index

The corner to get the data from.

Outputs

Face Index

The output faces.

Index in Face

The index of the corner, starting from the first corner in the face.

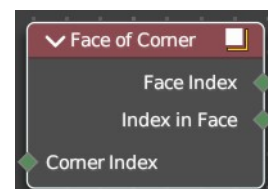

Offset Corner in Face

Retrieve corners within the same face as another

Input

Corner Index

The corner to get the data from.

Offset

The numbers of corners to move around the face before getting the result. It circles around the start of the face if necessary.

Outputs

Corner Index

The index of the offset corner.

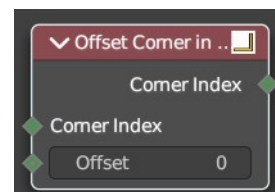

Vertex of corner

Retrieve the vertex each corner is attached to.

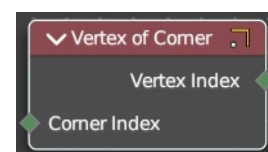

Input

Corner Index

The corner to get the data from.

Offset

The numbers of corners to move around the face before getting the result. It circles around the start of the face if necessary.

Outputs

Vertex Index

The vertex each corner is attached to.



12.1.29 Editors - Geometry Nodes Editor - Header - Add Menu - Mesh - UV

Table of content

Detailed table of content.....	1
Add menu - UV.....	2
Pack UV Islands.....	2
UV Unwrap.....	2

Detailed table of content

Detailed table of content

Detailed table of content.....	1
Add menu - UV.....	2
Pack UV Islands.....	2
Inputs.....	2
UV.....	2
Selection.....	2
Margin.....	2
Rotate.....	2
Outputs.....	2
UV.....	2
UV Unwrap.....	2
Inputs.....	2
Selection.....	2
Seam.....	2
Margin.....	3
Fill Holes.....	3
Outputs.....	3
UV.....	3

Add menu - UV

Here you find nodes to modify the UV mapping.

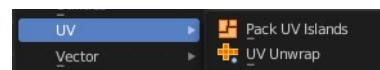

Pack UV Islands

Pack the UV islands to get the most out of the UV mapping.

Inputs

UV

The input UV geometry.

Selection

A selection of the UV geometry.

Margin

How big the gap between the single UV patches should be.

Rotate

Rotate the UV patches while packing or not.

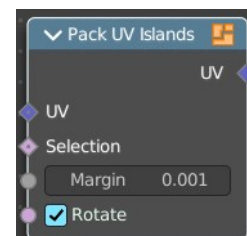

Outputs

UV

The output UV geometry.

UV Unwrap

Unwrap the mesh to give it an UV mapping.

Inputs

Selection

Which faces of the mesh should be unwrapped.

Seam

Mark edges as a seam for unwrapping.

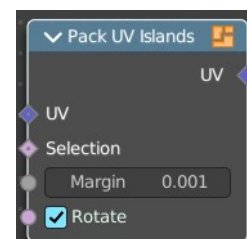

Margin

How big the gap between the single UV patches should be.

Fill Holes

Virtually fill holes before unwrapping the mesh. This preserves symmetry and can avoid overlaps.

Outputs

UV

The output UV geometry.



12.1.3 Editors - Geometry Nodes Editor - Header - View Menu

Table of content

View Menu.....	1
Toolbar.....	1
Sidebar.....	2
Annotations (Legacy).....	2
Draw Annotation.....	2
Draw Line Annotation.....	2
Draw Polyline Annotation.....	2
Erase Annotation.....	2
Add Annotation Layer.....	2
Erase Annotation Active Keyframe.....	2
Zoom In.....	2
Zoom Out.....	2
Zoom Border.....	3
Frame Selected.....	3
Frame All.....	3
Pie menus.....	3
Area.....	3
Horizontal Split.....	3
Vertical Split.....	3
Duplicate Area into New Window.....	3
Toggle Maximize Area.....	3
Toggle Full screen Area.....	4
Close Area.....	4

View Menu

The View menu contains all View related tools.

The content is the same in all sub modes.

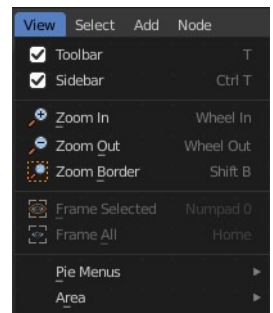

Toolbar

Shows or hides the toolbar at the left.



Sidebar

Shows or hides the sidebar at the right in the viewport.

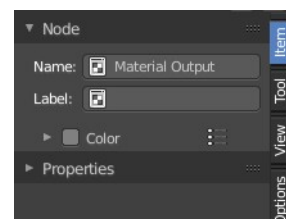

Annotations (Legacy)

This group of operators is useful to take notes without changing tool-shelf operators. These notes can be colored in the View tab of the Property Shelf. Each layer is a single color. You can also animate the notes with keyframes, editable in the dopesheet.

Note: *These are legacy operators, meaning they are equally available in the Toolshelf as a modal operator.*

Draw Annotation

Starts the annotation free hand draw tool in the editor.

Draw Line Annotation

Starts the annotation line draw tool to draw straight lines in the editor.

Draw Polyline Annotation

Starts the annotation Polyline draw tool in the editor which allows to draw multiple connected straight lines in the editor.

Erase Annotation

Starts the annotation erase tool in the editor which erases any strokes in the editor.

Add Annotation Layer

Starts a new annotation layer.

Erase Annotation Active Keyframe

Erases the active keyframe of the annotation.

Zoom In

Zooms into the viewport.

Zoom Out

Zooms out of the viewport.

Zoom Border

Draws a rectangle and zooms then to fit the size of this rectangle.

Zooming in is done with drawing the rectangle with left mouse button. Zooming out is done with drawing the rectangle with middle mouse button.

Frame Selected

Zooms to the selection.

Frame All

View all zooms in or out in the viewport until all objects in the scene are displayed fitting in the viewport.

Pie menus

Lists the available pie menus, and gives you the ability to read the hotkeys and assign own hotkeys.



Area

This menu contains general view functionality. And exists in most other editor types too.

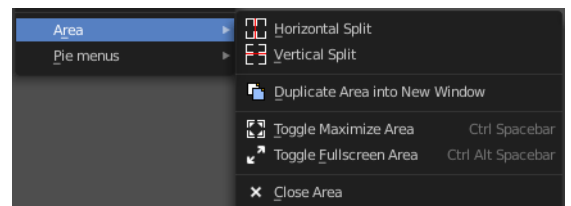

Horizontal Split

Splits the current view horizontally into two independent editor windows.

Vertical Split

Splits the current view vertically into two independent editor windows.

Duplicate Area into New Window

Duplicate Area into New Window makes the selected editor window floating. You can then drag it around at the monitor. It is not connected with the rest of the UI any more.

A separated window cannot be merged into the main window again. You have to close it when not longer needed.

Toggle Maximize Area

Displays the editor maximized with menus.

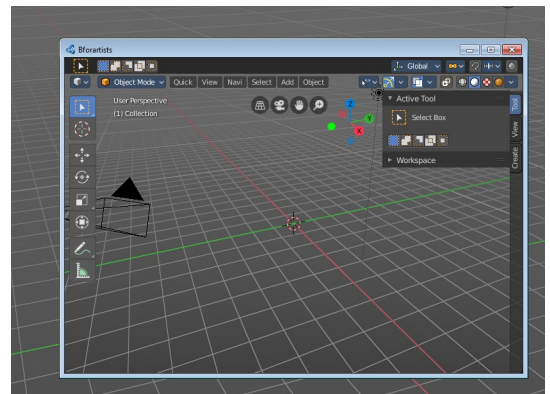

To return from the maximized view press hotkey ctrl + spacebar. Or reuse the menu item in the area menu.

Toggle Full screen Area

Displays the editor maximized without menus.

To return from the full screen view press hotkey ctrl + alt + spacebar.

Close Area

Closes the area window.

12.1.30 Editors - Geometry Nodes Editor - Header - Add Menu - Point

Table of content

Detailed table of content.....	1
Add menu - Point.....	2
Distribute Points In Volume.....	3
Distribute Points on Faces.....	4
Points.....	5
Points to Vertices.....	6
Points to Volume.....	6
Set Point Radius.....	7

Detailed table of content

Detailed table of content

Detailed table of content.....	1
Add menu - Point.....	2
Distribute Points In Volume.....	2
Inputs Random mode.....	3
Volume.....	3
Density.....	3
Seed.....	3
Inputs Grid mode.....	3
Volume.....	3
Spacing.....	3
Threshold.....	3
Properties.....	3
Distribution method.....	3
Random.....	3
Grid.....	3
Output.....	3
Points.....	3
Distribute Points on Faces.....	4
Inputs Random mode.....	4
Mesh.....	4
Selection.....	4
Density.....	4
Seed.....	4
Inputs Poisson Disk mode.....	4
Mesh.....	4
Selection.....	4
Distance Min.....	4
Distance Max.....	4
Density Factor.....	4
Seed.....	5
Properties.....	5
Distribution method.....	5

Random.....	5
Poisson Disk.....	5
Output.....	5
Points.....	5
Normal.....	5
Rotation.....	5
Points.....	5
Inputs.....	5
Count.....	5
Outputs.....	5
Mesh.....	5
Points to Vertices.....	6
Inputs.....	6
Points.....	6
Selection.....	6
Outputs.....	6
Mesh.....	6
Points to Volume.....	6
Inputs.....	6
Geometry.....	6
Density.....	6
Voxel Amount.....	6
Radius.....	6
Properties.....	6
Resolution.....	6
Outputs.....	7
Geometry.....	7
Set Point Radius.....	7
Inputs.....	7
Points.....	7
Selection.....	7
Radius.....	7
Outputs.....	7
Points.....	7

Add menu - Point

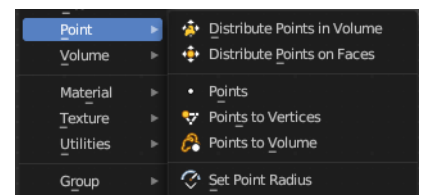

Distribute Points In Volume

Distributes points randomly in a volume.

Point, corner and polygon attributes of the input geometry are transferred to the generated points. That includes vertex weights and UV maps. Additionally, the node has Normal and Rotation outputs.

The node also generates a stable ID, which is then stored in the built-in id attribute. It is used as a stable identifier for each point. When the geometry is deformed or the density changes the values will be consistent for each remaining point. This attribute is used in the Random Value and Instance on Points nodes.

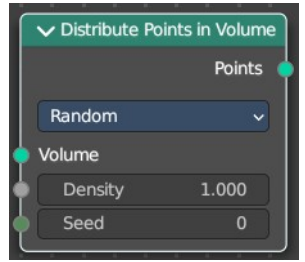

Inputs Random mode

Volume

The volume to import the points to.

Density

Density of the points.

Seed

The random seed for the point distribution.

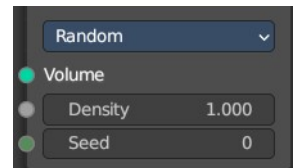

Inputs Grid mode

Volume

The volume to import the points to.

Spacing

The spacing between the grid points.

Threshold

Minimum density of a volume cell to contain a grid point.

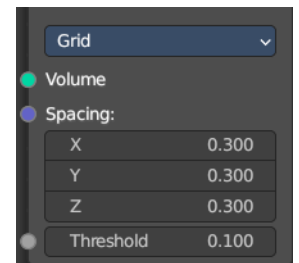

Properties

Distribution method

Random

Distributes the points randomly. This allows overlappings.

Grid

Distributes the points along a grid with given width.

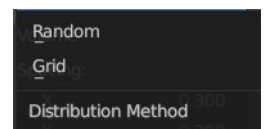

Output

Points

Points output.

Distribute Points on Faces

Distributes points randomly on the faces of a mesh geometry.

Point, corner and polygon attributes of the input geometry are transferred to the generated points. That includes vertex weights and UV maps. Additionally, the node has Normal and Rotation outputs.

The node also generates a stable ID, which is then stored in the built-in id attribute. It is used as a stable identifier for each point. When the mesh is deformed or the density changes the values will be consistent for each remaining point. This attribute is used in the Random Value and Instance on Points nodes.

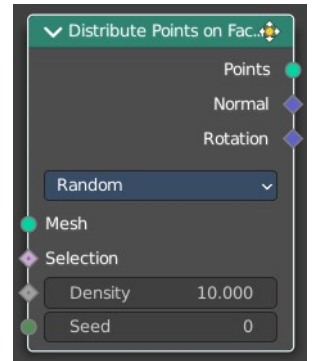

Inputs Random mode

Mesh

Standard geometry input.

Selection

The selection of which face corners should be considered for point distribution.

Density

Density of the points.

Seed

The random seed for the point distribution.

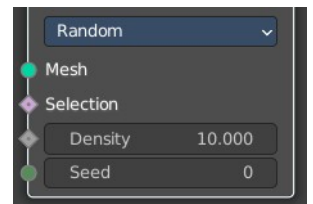

Inputs Poisson Disk mode

Mesh

Standard geometry input.

Selection

The selection of which face corners should be considered for point distribution.

Distance Min

The minimum distance that two points can have.

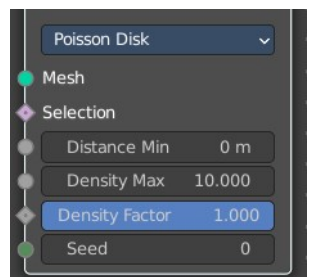

Distance Max

The maximum distance that two points can have.

Density Factor

Density of the points.

Seed

The random seed for the point distribution.

Properties

Distribution method

Random

Distributes the points randomly. This allows overlappings.

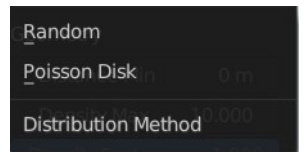

Poisson Disk

Distributes the points randomly, but prevents overlappings by defining a minimum and maximum distance.

Output

Points

Points output.

Normal

Normal output.

Rotation

Euler Rotation output. Please note that the Z axis of the result rotation will be arbitrary. The mesh normal used to create the rotation does not have enough information to set all three rotation axes.

Points

Generates a single point or points with position, count and radius.

Inputs

Count

The count of the generated points as an integer.

Position

The position of the points as a vector. This is a field meaning you can set the position per index or ID of the point.

Radius

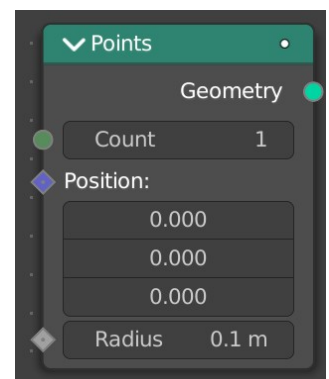

The radius of the points as a float. This is a field meaning you can set the scale per index or ID of the point.

Outputs

Mesh

Standard mesh output.

Points to Vertices

Generates a mesh vertex in the output geometry for each point cloud point in the input geometry.

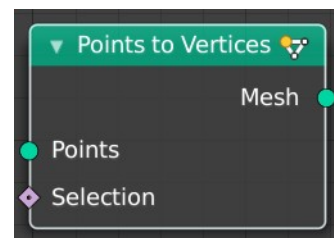

Inputs

Points

Points input.

Selection

Selection input.

Outputs

Mesh

Standard mesh output.

Points to Volume

Creates a fog volume sphere around every point in the input geometry. The new volume grid is then called density.

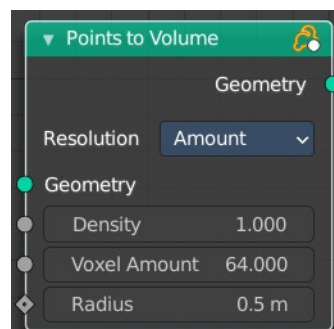

Inputs

Geometry

Points input.

Density

The density of the volume.

Voxel Amount

Voxel amount of the volume.

Radius

The radius of the generated volume around each point.

Properties

Resolution

Base the voxel resolution at the amount or the size of the point cloud.

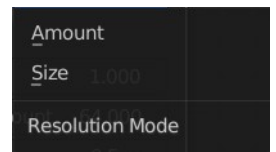

Outputs

Geometry

Standard geometry output.

Set Point Radius

The Set Point Radius node controls the size each selected point cloud point should display with in the viewport.

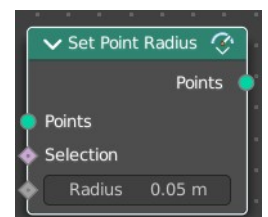

Inputs

Points

Geometry input.

Selection

Selection input.

Radius

The radius of the points.

Outputs

Points

Standard geometry output.



12.1.31 Editors - Geometry Nodes Editor - Header - Add Menu - Volume

Table of content

Detailed table of content.....	1
Add menu - Volume.....	2
Volume Cube.....	2
Volume to Mesh.....	3

Detailed table of content

Detailed table of content

Detailed table of content.....	1
Add menu - Volume.....	2
Volume Cube.....	2
Inputs.....	2
Geometry.....	2
Density.....	2
Background.....	2
Min:.....	2
Volume to Mesh.....	3
Inputs.....	3
Geometry.....	3
Density.....	3
Threshold.....	3
Adaptivity.....	3
Properties.....	3
Resolution.....	3
Output.....	3
Geometry.....	3

Add menu - Volume

Here you find nodes to modify the volume.

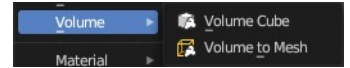

Volume Cube

The Volume Cube node generates a voxel based volume cube primitive that can be used for volume conversion to mesh in conjunction with the Volume to Mesh node.

Inputs

Geometry

Standard geometry input.

Density

Volume density per voxel. Higher values makes it more dense.

Background

Value per voxel outside the cube domain.

Min:

Minimum boundary of the volume cube.

Max:

Maximum boundary of the volume cube.

Resolution X

Number of volume voxules in the X axis.

Resolution Y

Number of volume voxules in the Y axis.

Resolution Z

Number of volume voxules in the Z axis.

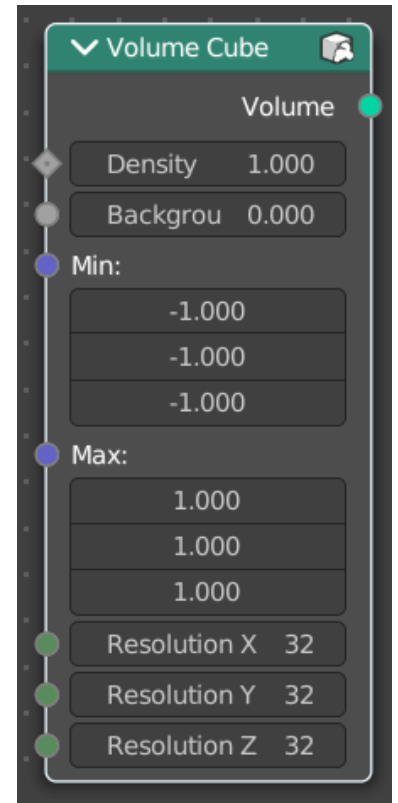

Volume to Mesh

The Volume to Mesh node generates a mesh on the “surface” of a volume. The surface is defined by a threshold value. All voxels with a larger value than the threshold are considered to be outside.

Note that currently this node only works on volumes generated using geometry nodes.

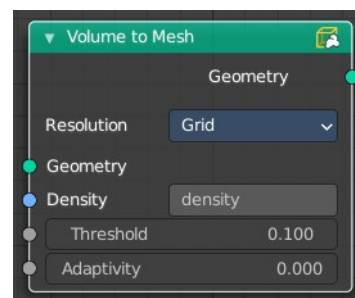

Inputs

Geometry

Standard geometry input.

Density

The density input of the volume object. Either a tag or the information from another node.

Threshold

The voxel amount to use.

Adaptivity

The input radius.

Properties

Resolution

Base the voxel resolution at the gridsize, the amount or the size of the point cloud.



Output

Geometry

Standard geometry output.

12.1.32 Editors - Geometry Nodes Editor - Header - Add Menu - Simulation

Table of content

Detailed table of content.....	1
Add menu - Simulation.....	2
Simulation Zone.....	2
Clock.....	3
Properties.....	3
Baking.....	3
Simulation Zone Input.....	4
Simulation Zone Output.....	5

Detailed table of content

Detailed table of content

Detailed table of content.....	1
Add menu - Simulation.....	2
Simulation Zone.....	2
Clock.....	3
Properties.....	3
Baking.....	3
Caching to Disk.....	3
Calculate to Frame.....	3
Bake.....	4
Delete Cached Bake.....	4
Cache.....	4
Simulation Zone Input.....	4
Inputs.....	4
Geometry.....	4
Output.....	4
Delta Time.....	4
Geometry.....	4
Simulation Zone Output.....	5
Inputs.....	5
Geometry.....	5
Output.....	5
Geometry.....	5

Add menu - Simulation

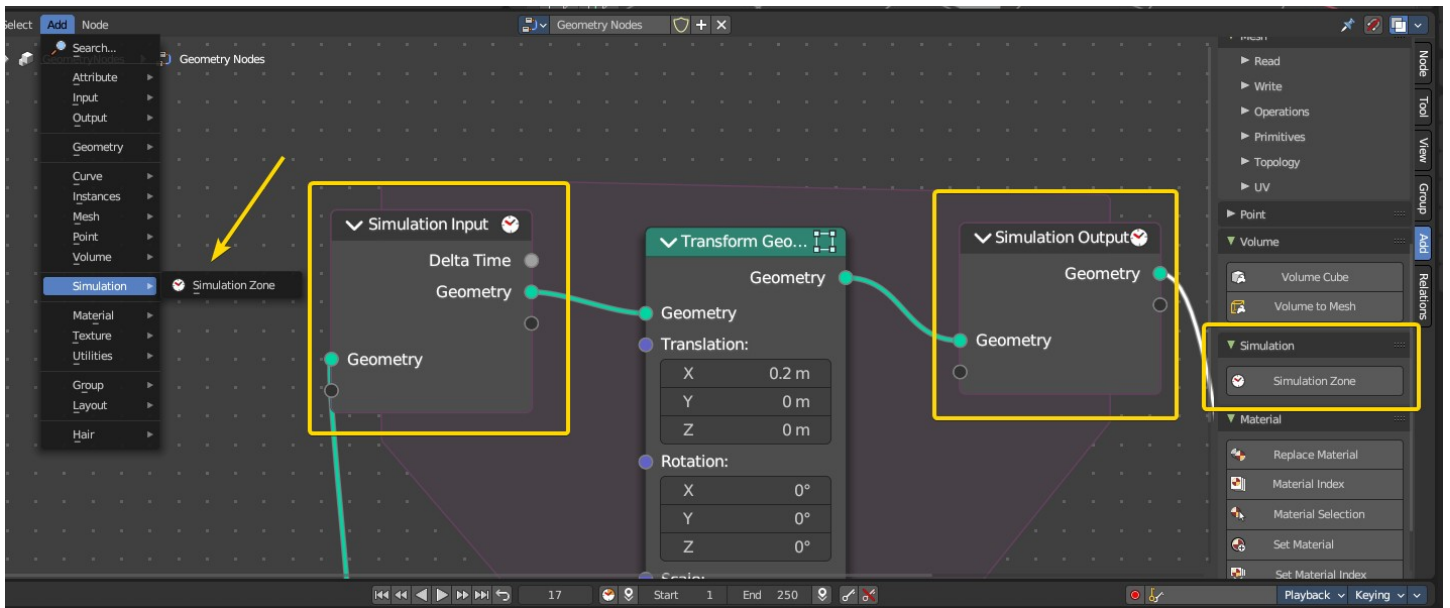

Here you add nodes to use a simulation zone. Simulation zones allow the result of one frame to influence the next one. The most common use is physics simulation, with specific solvers for physical phenomena.

Note: In the example above every frame will transform the geometry by 0.2m in the X axis. With this principle you can set rules that will evaluate per frame.

Simulation Zone

When adding a simulation zone, two nodes are added, defining between them a “Simulation Zone”.

The Geometry inputs that are connected to the Simulation Input node are evaluated once per frame. At the beginning of the simulation, geometry is passed to the next frame and eventually output at the end of the zone in the Simulation Output node.

You can also get other nodes with their data and link them into the simulation region from the outside to re-

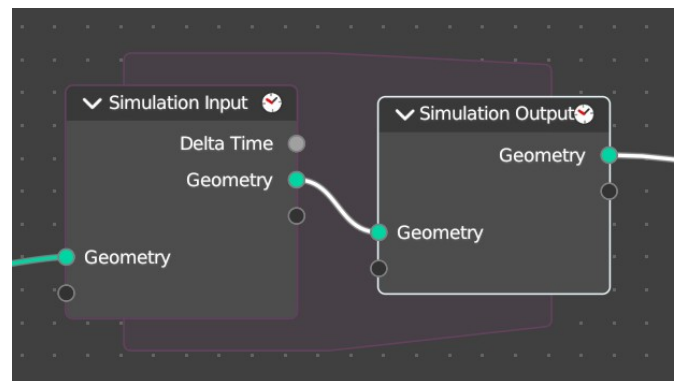

evaluate geometry data per frame.

Note: *It is not possible to set data outside the Simulation Zone, you can only get data from outside the Simulation Zone. The result of the simulation can only be accessed via the Simulation Output node.*

Clock

The simulation is tied to the animation system found in the Animation Editor, with support for sub-steps. The simulation will only be evaluated while the animation frame changes, and each frame is cached during playback.

Properties

In the Node Editor the inputs can be renamed, shuffled and removed in the Group tab of the Node Editor Property shelf to the right.

Note: *When you add a new input or output, both nodes input and output nodes will update their sockets.*

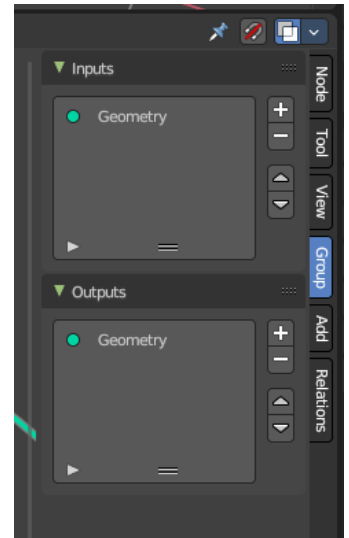

Baking

The simulation is automatically cached during playback. The evaluated cache can be seen as a colored line in the Timeline editor.

Cached frames in the Timeline show up as a coloured bar at the bottom.

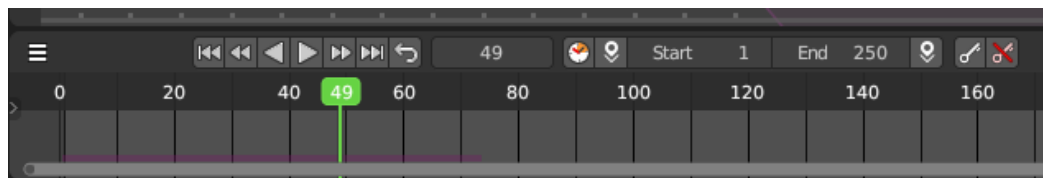

Caching to Disk

To render, the simulation should be cached to disk. To do this, switch to the Properties Editor then go into the Physics tab. Then in the Simulation Nodes panel, you can then Bake or Calculate to Frame

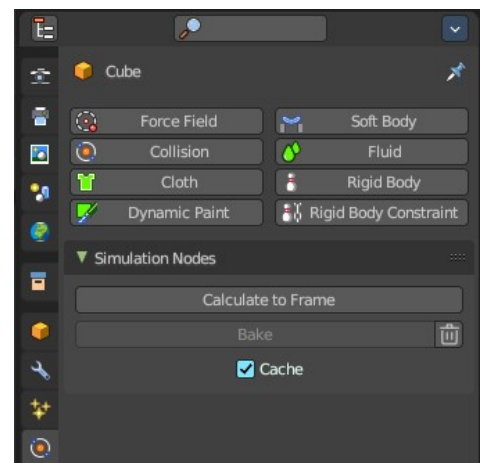

Calculate to Frame

Calculate the simulations in Geometry Nodes modifiers from the start to current frame.

Bake

Bake simulations in all geometry node modifiers to disk. You can define the path where these will bake per Geometry Nodes modifier. If not defined, it will default to the *.blend file location. To bake, you must save the file first.

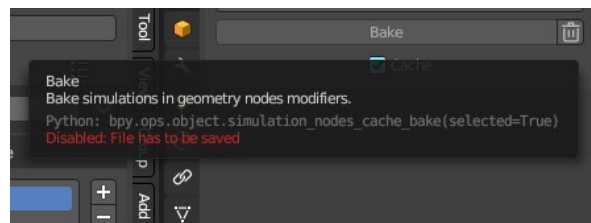

Delete Cached Bake

The trashcan icon will erase the baked collection from disk.

Cache

This checkbox toggles the feature to cache frames on playback. When you turn this off, then the automatic caching on playback will not bake to disk.

Note: *Baking the simulation will bake all the simulations in all modifiers in the scene.*

Simulation Zone Input

This node is the beginning of the Simulation Zone. Custom input and output sockets can be defined in the property shelf to the right in the Group tab.

Inputs

Geometry

Standard geometry input.

Output

Delta Time

Returns a float value with the amount of elapsed time that has passed in a linear way. This is used to ensure that the simulation runs smoothly and consistently based on elapsed time, regardless of the playback frame rate or starting frame.

Geometry

Standard geometry output.

Simulation Zone Output

This node is the end of the Simulation Zone. Custom input and output sockets can be defined in the property shelf to the right in the Group tab.

Inputs

Geometry

Standard geometry input.

Output

Geometry

Standard geometry output.

12.1.33 Editors - Geometry Nodes Editor - Header - Add Menu - Material

Table of content

Detailed table of content.....	1
Add menu - Material.....	2
Replace Material.....	2
Material Index.....	2
Material Selection.....	2
Set Material.....	3
Set Material Index.....	3

Detailed table of content

Detailed table of content

Detailed table of content.....	1
Add menu - Material.....	2
Replace Material.....	2
Inputs.....	2
Geometry.....	2
Old.....	2
New.....	2
Outputs.....	2
Geometry.....	2
Material Index.....	2
Output.....	2
Material Index.....	2
Material Selection.....	2
Inputs.....	3
Material.....	3
Outputs.....	3
Geometry.....	3
Set Material.....	3
Inputs.....	3
Geometry.....	3
Selection.....	3
Material.....	3
Output.....	3
Geometry.....	3
Set Material Index.....	3
Inputs.....	3
Geometry.....	3
Selection.....	3
Material Index.....	4
Output.....	4
Geometry.....	4

Add menu - Material

Nodes to modify the material.

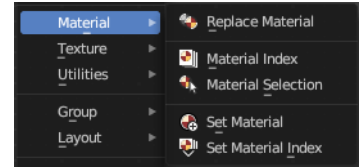

Replace Material

Replace an existing material by a new material.

Inputs

Geometry

The geometry that you want to assign the material to.

Old

The old material.

New

The new material.

Outputs

Geometry

Standard geometry output.

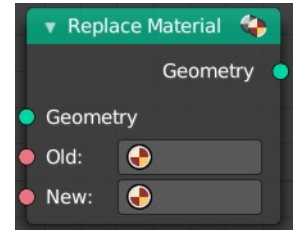

Material Index

Retrieves the material index.

Output

Material Index

The material index.

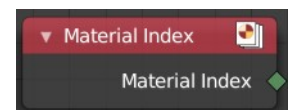

Material Selection

Select geometry by Material.

Since the material index is stored on each face, the output will be implicitly interpolated to

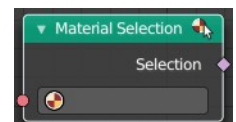

a different element when necessary. For example, every vertex connected to a selected face will be selected.

Inputs

Material

The material.

Outputs

Geometry

Standard geometry output.

Set Material

Assign a material to a mesh or a selection of a mesh.

Inputs

Geometry

The geometry that you want to assign the material to.

Selection

The selection that you want to assign the material to.

Material

The material that you want to assign.

Output

Geometry

Standard geometry output.

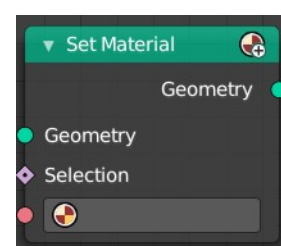

Set Material Index

Assigning a material index to a mesh or a selection of a mesh.

Inputs

Geometry

The geometry that you want to assign the material to.

Selection

The selection that you want to assign the material to.

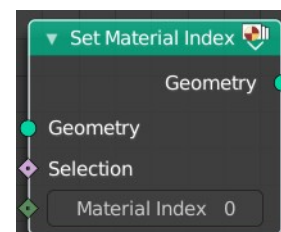

Material Index

The material index that you want to assign.

Output

Geometry

Standard geometry output.

12.1.34 Editors - Geometry Nodes Editor - Header - Add Menu - Texture

Table of content

Detailed table of content.....	1
Add menu - Texture.....	4
Brick Texture.....	4
Checker Texture.....	5
Gradient Texture.....	6
Image Texture.....	7
Magic Texture.....	9
Musgrave Texture.....	10
Noise Texture.....	12
Voronoi Texture.....	13
Wave Texture.....	14
White Noise Texture.....	15

Detailed table of content

Detailed table of content

Detailed table of content.....	1
Add menu - Texture.....	4
Brick Texture.....	4
Inputs.....	4
Color 1, Color 2 and Mortar.....	4
Scale.....	4
Mortar Size.....	4
Mortar Smooth.....	4
Bias.....	5
Brick Width.....	5
Row Height.....	5
Properties.....	5
Offset.....	5
Frequency.....	5
Squash.....	5
Frequency.....	5
Outputs.....	5
Color.....	5
Factor.....	5
Checker Texture.....	5
Inputs.....	5
Vector.....	5
Color 1.....	6
Color 2.....	6
Scale.....	6
Properties.....	6
Gradient Type.....	6
Output.....	6

Color.....	6
Factor.....	6
Gradient Texture.....	6
Inputs.....	6
Vector.....	6
Properties.....	6
Gradient Type.....	6
Output.....	7
Factor.....	7
Color.....	7
Image Texture.....	7
Inputs.....	7
Image.....	7
Image Browser.....	7
New/Open.....	7
Image Edit Box.....	7
Fake User.....	7
New Image.....	7
Open Image.....	8
Remove.....	8
Vector.....	8
Frame.....	8
Properties.....	8
Interpolation.....	8
Linear.....	8
Closest.....	8
Cubic.....	8
Extension.....	8
Repeat.....	8
Extend.....	8
Clip.....	8
Outputs.....	8
Color.....	8
Alpha.....	9
Magic Texture.....	9
Inputs.....	9
Vector.....	9
Scale.....	9
Distortion.....	9
Properties.....	9
Depth.....	9
Outputs.....	9
Color.....	9
Factor.....	9
Musgrave Texture.....	10
Inputs.....	10
Vector.....	10
W.....	10
Scale.....	10
Detail.....	10
Dimension.....	10
Lacunarity.....	11
Offset.....	11

Gain.....	11
Properties.....	11
Dimensions.....	11
1D.....	11
2D.....	11
3D.....	11
4D.....	11
Type.....	11
fBM (fractal Brownian Motion).....	11
Multifractal.....	11
Hybrid Multifractal.....	11
Ridged Multifractal.....	12
Hetero Terrain (Heterogeneous Terrain).....	12
Outputs.....	12
Height.....	12
Noise Texture.....	12
Inputs.....	12
Vector.....	12
Scale.....	12
Detail.....	12
Roughness.....	12
Distortion.....	12
Properties.....	12
Dimensions.....	12
Output.....	12
Factor.....	12
Color.....	13
Voronoi Texture.....	13
Inputs.....	13
Vector.....	13
Scale.....	13
Randomness.....	13
Properties.....	13
Dimensions.....	13
Feature Output.....	13
F1.....	13
F2.....	13
Smooth F1.....	13
Distance to Edge.....	13
N-Sphere Radius.....	14
Distance Metric.....	14
Output.....	14
Factor.....	14
Color.....	14
Wave Texture.....	14
Inputs.....	14
Vector.....	14
Scale.....	14
Distortion.....	14
Detail.....	14
Detail Scale.....	14
Detail Roughness.....	14
Phase Offset.....	15

Properties.....	15
Wave Type.....	15
Bands direction.....	15
Wave Profile.....	15
Saw.....	15
Sine.....	15
Triangle.....	15
Outputs.....	15
Color.....	15
Factor.....	15
White Noise Texture.....	15
Inputs.....	15
Vector.....	15
Properties.....	16
Gradient Type.....	16
Output.....	16
Vector.....	16
Color.....	16

Add menu - Texture

Texture nodes.

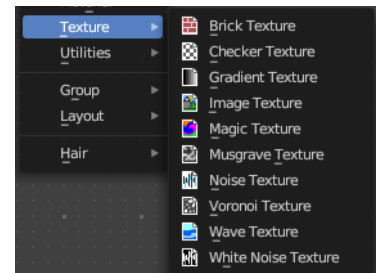

Brick Texture

The Brick Texture node is used to add a procedural brick texture.

Inputs

Color 1, Color 2 and Mortar

Color of the bricks and mortar.

Scale

Overall texture scale.

Mortar Size

The size of the filling between the bricks known as “mortar”; 0 means no mortar.

Mortar Smooth

Blurs/softens the edge between the mortar and the bricks. This can be useful with a texture and displacement textures.

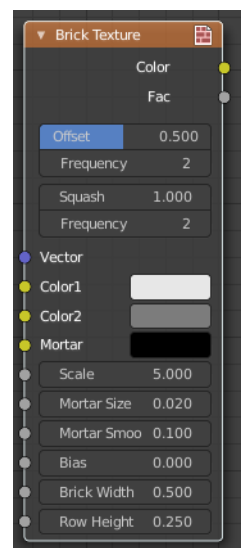

Bias

The color variation between Color 1/2. Values of -1 and 1 only use one of the two colors; values in between mix the colors.

Brick Width

The width of the bricks.

Row Height

The height of the brick rows.

Properties

Offset

Determines the brick offset of the various rows.

Frequency

Determines the offset frequency. A value of 2 gives an even/uneven pattern of rows.

Squash

Amount of brick squashing.

Frequency

Brick squashing frequency.

Outputs

Color

Texture color output.

Factor

Mortar mask (1 = mortar).

Checker Texture

Adds a checker texture.

Inputs

Vector

Vector input.

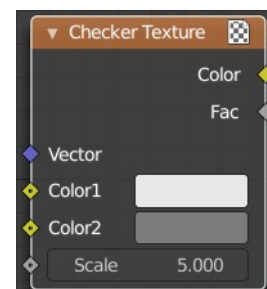

Color 1

The first checker color.

Color 2

The second checker color.

Scale

The scale of the checker texture.

Properties

Gradient Type

What gradient type to use.

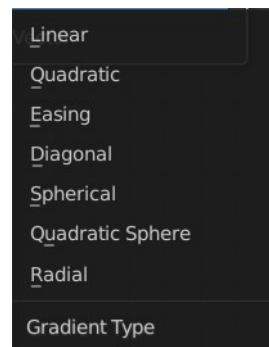

Output

Color

The checker texture output.

Factor

Factor output.

Gradient Texture

Add a gradient texture.

Inputs

Vector

Vector input.

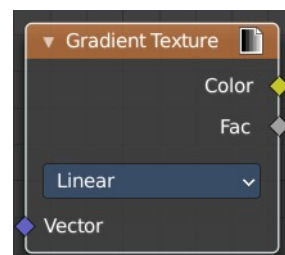

Properties

Gradient Type

What gradient type to use.

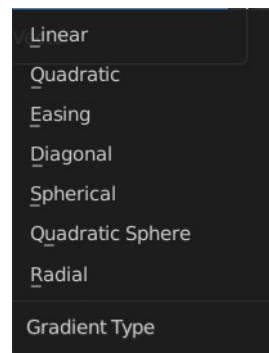

Output

Factor

Factor output.

Color

Color output.

Image Texture

The Image Texture is used to add an image file as a texture.

Inputs

Image

The Image input. Open an image, choose an existing image, or generate a new image.

When you click at Open then a file browser opens up. When you click at New then a popup dialog opens. up where you can create a new image.

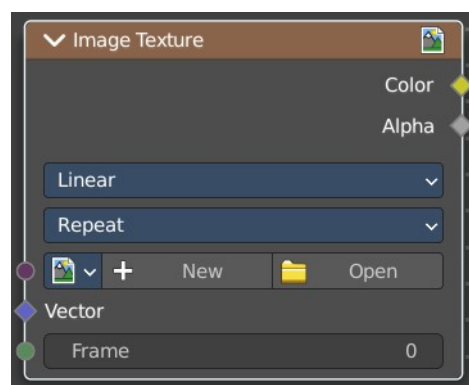
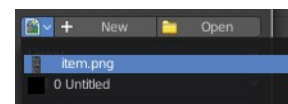

Image Browser

The image browser at the left allows you to pick an already existing texture.



New/Open

Create a new image, or open an image.

Image Edit Box

The name of the image.

Fake User

Keep the texture in the blend file even if it is not used.

New Image

Create a new image.

The settings of this image can be further adjusted in the sidebar of the UV Editor.

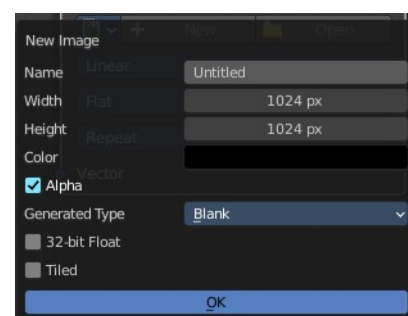

Open Image

Open an image.

Remove

Remove the image. Note that it is still in the blend file as long as it has users, and as long as you haven't purged it. By saving and reloading the blend file for example.

Vector

Texture coordinate for texture look-up. If this socket is left unconnected, UV coordinates from the active UV render layer are used.

Frame

The frame of an image sequence, if available.

Properties

Interpolation

Method to scale images up or down for rendering.

Linear

Regular quality interpolation.

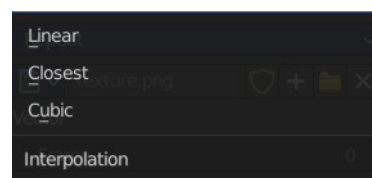

Closest

No interpolation, use only closest pixel for rendering pixel art.

Cubic

Smoother, better quality interpolation. For bump maps this should be used to get best results.

Extension

Extension defines how the image is extrapolated past the original bounds:

Repeat

Will repeat the image horizontally and vertically giving tiled-looking result.

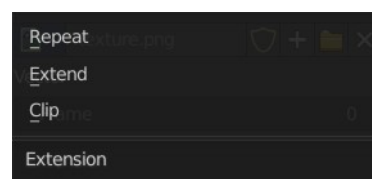

Extend

Will extend the image by repeating pixels on its edges.

Clip

Clip to the original image size and set all the exterior pixels values to transparent black.

Outputs

Color

RGB color from image. If the image has alpha, the color is premultiplied with alpha if the Alpha output is used,

and unpremultiplied or straight if the Alpha output is not used.

Alpha

Alpha channel from image.

Magic Texture

The Magic Texture node is used to add a procedural psychedelic color texture.

Inputs

Vector

Texture coordinate to sample texture at; defaults to Generated texture coordinates if the socket is left unconnected.

Scale

Scale of the texture.

Distortion

Amount of distortion.

Properties

Depth

Number of iterations.

Outputs

Color

Texture color output.

Factor

Texture intensity output.

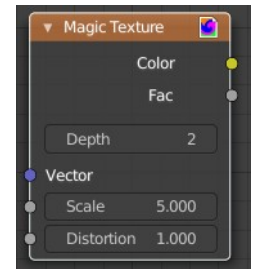

Musgrave Texture

The Musgrave Texture node evaluates a fractal Perlin noise at the input texture coordinates. Compared to the noise texture, the Musgrave Texture allows greater control over how octaves are combined.

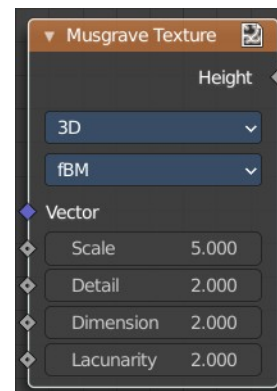

Inputs

The available input types change, dependent of the chosen Type and dimensions.

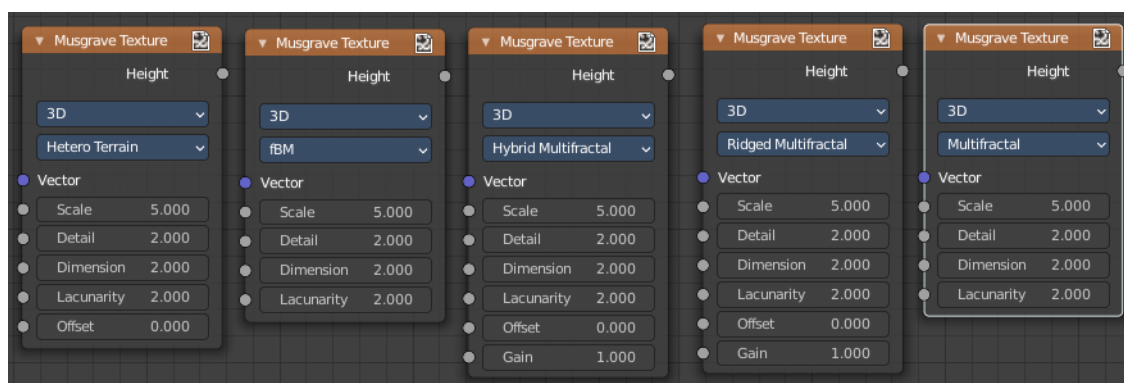

Vector

Texture coordinate to evaluate the noise at. Defaults to Generated texture coordinates if the socket is left unconnected.

W

Texture coordinate to evaluate the noise at. Appears with 4 dimensions.

Scale

Scale of the base noise octave.

Detail

Number of noise octaves. The fractional part of the input is multiplied by the magnitude of the highest octave. Higher number of octaves corresponds to a higher render time.

Dimension

The difference between the magnitude of each two consecutive octaves. Larger values corresponds to smaller magnitudes for higher octaves.

Lacunarity

The difference between the scale of each two consecutive octaves. Larger values corresponds to larger scale for higher octaves.

Offset

An added offset to each octave, determines the level where the highest octave will appear.

Gain

An extra multiplier to tune the magnitude of octaves.

Properties

Dimensions

The dimensions of the space to evaluate the noise in.

1D

Evaluate the noise in 1D space at the input W.

2D

Evaluate the noise in 2D space at the input Vector. The Z component is ignored.

3D

Evaluate the noise in 3D space at the input Vector.

4D

Evaluate the noise in 4D space at the input Vector and the input W as the fourth dimension.

Higher dimensions corresponds to higher render time, so lower dimensions should be used unless higher dimensions are necessary.

Type

Type of the Musgrave texture.

fBM (fractal Brownian Motion)

Produces an unnatural homogeneous and isotropic result. Uses an additive cascade, the values are simply added together.

Multifractal

The result is more uneven (varies with location), more similar to a real terrain. Uses a multiplicative cascade.

Hybrid Multifractal

Creates peaks and valleys with different roughness values, like real mountains rise out of flat plains. Combines the additive cascade with a multiplicative cascade.

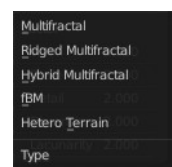
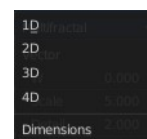

Ridged Multifractal

Creates sharp peaks. Calculates the absolute value of the noise, creating “canyons”, and then flips the surface upside down.

Hetero Terrain (Heterogeneous Terrain)

Similar to Hybrid Multifractal creates a heterogeneous terrain, but with the likeness of river channels.

Outputs

Height

Greyscale texture output.

Noise Texture

Add a noise texture.

Inputs

Vector

Vector input

Scale

The scale of the noise texture.

Detail

The detail of the noise texture.

Roughness

The roughness of the noise texture.

Distortion

The distortion of the noise texture.

Properties

Dimensions

How many dimensions to use for the noise texture.

Output

Factor

Factor output.

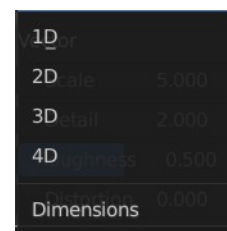
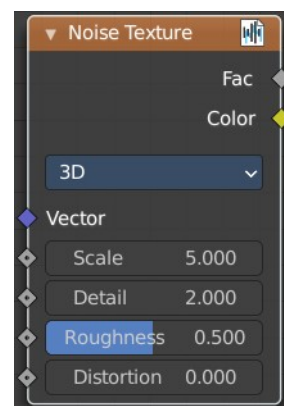

Color

Color output.

Voronoi Texture

Add a voronoi texture.

Inputs

Vector

Vector input

Scale

The scale of the voronoi texture.

Randomness

The detail of the voronoi texture.

Properties

Dimensions

How many dimensions to use for the voronoi texture.

Feature Output

Feature output mode.

F1

Computes the distance to the closest point as well as its position and color.

F2

Computes the distance to the second closest point as well as its position and color.

Smooth F1

Smoothed version of F1. Weighted sum of neighbor voronoi cells.

Distance to Edge

Computes the distance to the edge of the voronoi cell.

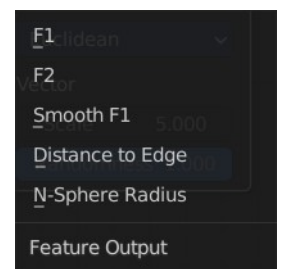
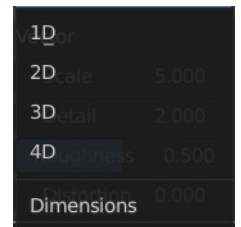
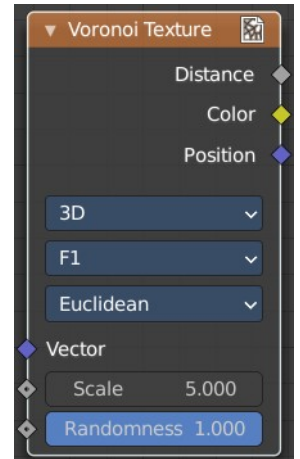

N-Sphere Radius

Computes the radius of the n-sphere inscribed in the voronoi cell.

Distance Metric

Distance calculation mode. The modes are different mathematical methods.

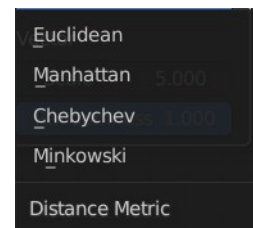

Output

Factor

Factor output.

Color

Color output.

Wave Texture

The Wave Texture node adds procedural bands or rings with noise distortion.

Inputs

Vector

Texture coordinate to sample texture at; defaults to Generated texture coordinates if the socket is left unconnected.

Scale

Overall texture scale.

Distortion

Amount of distortion of the wave (similar to the Marble texture in Blender Internal).

Detail

Amount of distortion noise detail.

Detail Scale

Scale of distortion noise.

Detail Roughness

Adds a roughness noise.

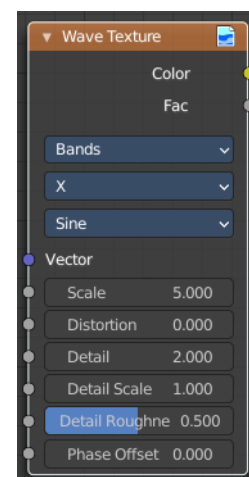

Phase Offset

Set an offset for the phase.

Properties

Wave Type

Bands or Rings shaped waves.

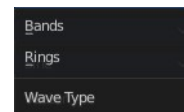

Bands direction

In which direction the bands should point.

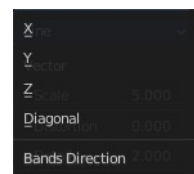

Wave Profile

Controls the shape and look of the wave type.

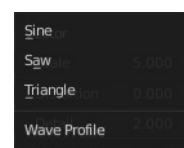

Saw

Uses a saw tooth profile.

Sine

Uses the standard sine profile.

Triangle

Uses a triangle shape.

Outputs

Color

Texture color output.

Factor

Texture intensity output.

White Noise Texture

Add a white noise texture.

Inputs

Vector

Vector input.

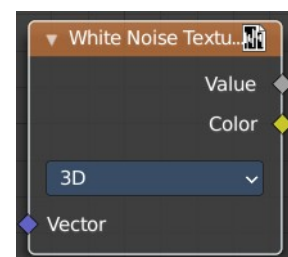

Properties

Gradient Type

What gradient type to use.

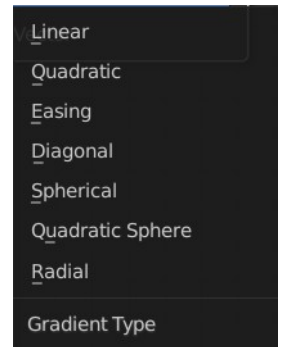

Output

Vector

Factor output.

Color

Color output.

12.1.35 Editors - Geometry Nodes Editor - Header - Add Menu - Utilities - Color

Table of content

Detailed table of content.....	1
Add menu - Utilities - Color.....	3
Color Ramp.....	3
Combine Color.....	5
Mix Color.....	7
RGB Curves.....	9
Separate Color.....	11

Detailed table of content

Detailed table of content

Detailed table of content.....	1
Add menu - Utilities - Color.....	3
Color Ramp.....	3
Inputs.....	3
Factor.....	3
Properties.....	4
Color Ramp.....	4
Controls.....	4
+.....	4
-.....	4
Tools menu.....	4
Flip Color Ramp.....	4
Distribute Stops from Left.....	4
Distribute Stops Evenly.....	4
Eyedropper (pipette icon) E.....	4
Reset Color Ramp.....	4
Color Mode.....	4
RGB.....	4
HSV/HSL.....	4
Interpolation.....	4
Ease.....	4
Cardinal.....	4
Linear.....	4
B-Spline.....	4
Constant.....	5
Color Ramp.....	5
Active Color Stop elements.....	5
Choose active color stop.....	5
Pos.....	5
Outputs.....	5
Image.....	5
Alpha.....	5
Combine Color.....	5

Input.....	5
Mode.....	5
Input – RGB mode.....	5
R, G and B.....	5
Input – HSV mode.....	5
H, S and V.....	5
Input – HSL mode.....	6
H, S and L.....	6
Tools.....	6
Reset View.....	6
Vector Handle.....	6
Auto Handle.....	6
Auto Clamped Handle.....	6
Extend horizontal.....	6
Extend extrapolated.....	6
Reset Curve.....	6
Output.....	6
Color.....	6
Use Clipping.....	6
Delete Points.....	6
Mix Color.....	7
Data Type.....	7
Color.....	7
Inputs.....	7
Factor.....	7
Color 1.....	7
Color 2.....	7
Properties.....	7
Mix.....	7
Clamp Result.....	7
Clamp Factor.....	7
Outputs.....	7
Result.....	7
Vector.....	8
Inputs.....	8
Factor.....	8
A.....	8
B.....	8
Properties.....	8
Factor Mode.....	8
Clamp Factor.....	8
Outputs.....	8
Result.....	8
Float.....	8
Inputs.....	8
Factor.....	8
A.....	8
B.....	8
Properties.....	8
Clamp Factor.....	8
Outputs.....	8
Result.....	8
RGB Curves.....	9

- Input.....9
 - Factor.....9
 - Color.....9
- Properties.....9
 - Curve Field.....9
 - Channel buttons.....9
 - Navigation elements.....9
 - Zoom in and out.....9
 - Use Clipping.....9
 - Tools.....9
 - Reset View.....9
 - Extend horizontal.....9
 - Extend extrapolated.....10
 - Reset Curve.....10
 - Curve edit field.....10
 - Selecting Points.....10
 - Adding Points.....10
 - Curve point settings.....10
 - Vector Handle.....10
 - Auto Handle.....10
 - Auto Clamped Handle.....10
- Output.....10
 - Color.....10
- Separate Color.....11
 - Input.....11
 - Mode.....11
 - Image.....11
 - Output.....11
 - Red, Green, Blue and Alpha.....11

Add menu - Utilities - Color

Here you find mainly nodes to convert color values.

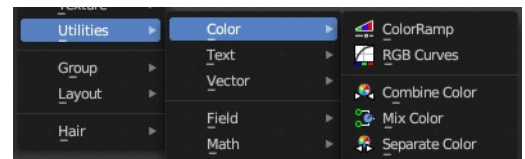

Color Ramp

The Color Ramp Node is used for mapping values to colors with the use of a gradient.

Inputs

Factor

The Factor input is used as an index for the color ramp.

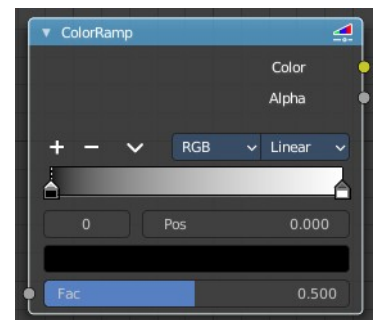

Properties

Color Ramp

Color Ramps enables the user to specify a range of colors based on color stops. The color between the color stops gets interpolated.

Controls

+

Add a stop to your color ramp. The stop will be added after the selected one, in the middle to the next one.

-

Deletes the selected color stop from the list.

Tools menu

Flip Color Ramp

Flips the gradient, inverting the values of the color ramp.

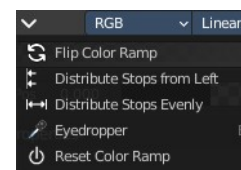

Distribute Stops from Left

Rearrange the stops so that every step has the same space to the right.

Distribute Stops Evenly

Space between all neighboring stops becomes equal.

Eyedropper (pipette icon) E

An Eyedropper to sample a color or gradient from the interface to be used in the color ramp.

Reset Color Ramp

Resets the color ramp to its default state.

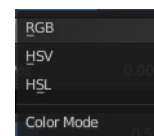

Color Mode

RGB

Blends color by mixing each color channel and combining.

HSV/HSL

Blends colors by first converting to HSV or HSL, mixing, then combining again. This has the advantage of maintaining saturation between different hues, where RGB would de-saturate, this allows for a richer gradient.

Interpolation

Ease

Uses an Ease Interpolation for the color stops.

Cardinal

Uses a Cardinal Interpolation for the color stops.

Linear

Uses a Linear Interpolation for the color stops.

B-Spline

Uses a B-Spline Interpolation for the color stops.

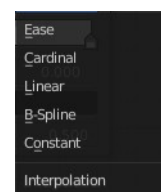

Constant

Uses a Constant Interpolation for the color stops.

Color Ramp

The color band. A click at one of the color stops makes it the active one. You can move the color stops by clicking at them and dragging them around.



Active Color Stop elements

Adjust the active color stop.

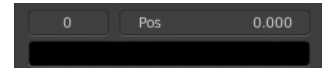

Choose active color stop

Choose the color stop by index.

Pos

The position of the active color stop. The range goes from 0.000 to 1.000

Outputs

Image

Standard image output.

Alpha

Combine Color

Combine the single RGBA channels into a single image.

Input

Mode

- **RGB** colour processing
- **HSV** colour processing
- **HSL** colour processing

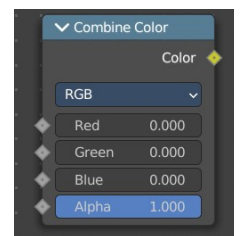

Input – RGB mode

R, G and B

The red, green and blue channels of an image.

Input – HSV mode

H, S and V

The Hue, Saturation and Value channels of an image.

Input – HSL mode

H, S and L

The Hue, Saturation and Luminescence channels of an image.

Tools

Tools is a menu where you can find some curve related tools.

Reset View

Resets the curve windows zoom.

Vector Handle

Set handle type to Vector.

Auto Handle

Set handle type to Auto.

Auto Clamped Handle

Set handle type to Auto Clamped.

Extend horizontal

Extends the curve before the first curve point and behind the last curve point horizontally.

Extend extrapolated

Extends the curve before the first curve point and behind the last curve point extrapolated.

Reset Curve

Resets the curve to the initial shape.

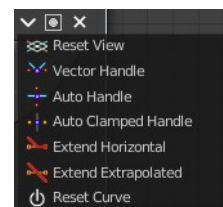

Output

Color

Color output.

Use Clipping

Clipping options. Set up clipping for the stroke.

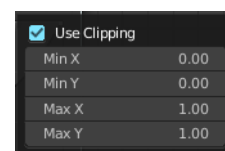

Delete Points

Deletes selected curve points.

Mix Color

The mix Color node is in real the Mix node in Color mode. It is shared across editors.

The Mix node is meant to mix values. This can be colors, or also a vector or a single value.

Note that the Mix Color node does not start in Color mode when you insert it from the sidebar due a technical limitation in the Blender Python api. Here you have to manually switch to the color mode.

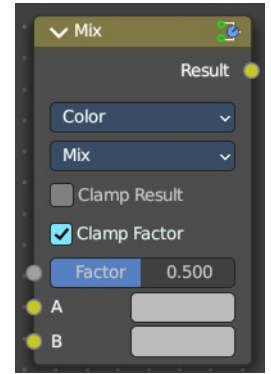

Data Type

The mode in which the node works.

Color

The Mix Node in color mode mixes images by working on the individual and corresponding pixels of the two input images. Called “MixRGB” in the shader and texture context.

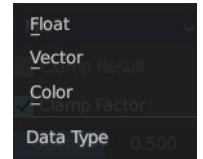

Inputs

Factor

Controls the amount of influence the node exerts on the output image.

Color 1

Usually the background image. The image size and resolution sets the dimensions of the output image.

Color 2

Usually the foreground image.

Properties

Mix

Choose the different blending modes.

Add, Subtract, Multiply, Screen, Divide, Difference, Darken, Lighten, Overlay, Color Dodge, Color Burn, Hue, Saturation, Value, Color, Soft Light, Linear Light.

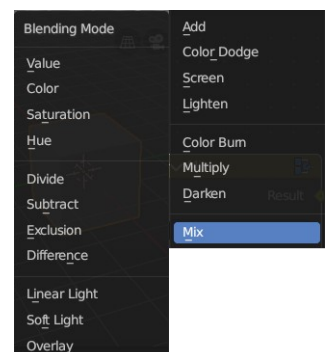

Clamp Result

Clamp the result to 0, 1 range.

Clamp Factor

Clamp the factor to 0, 1 range.

Outputs

Result

Standard output.

Vector

The vector mode allows you to mix vectors.

Inputs

Factor

Controls the amount of influence.

A

The input vector.

B

The output vector.

Properties

Factor Mode

Use a single factor for all values, or a factor per value.

Clamp Factor

Clamp the factor to 0, 1 range.

Outputs

Result

Standard output.

Float

The vector mode allows you to mix vectors.

Inputs

Factor

Controls the amount of influence.

A

The input value.

B

The output value.

Properties

Clamp Factor

Clamp the factor to 0, 1 range.

Outputs

Result

Standard output.

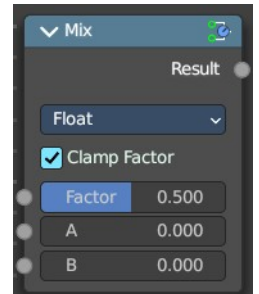
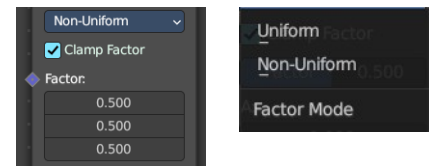
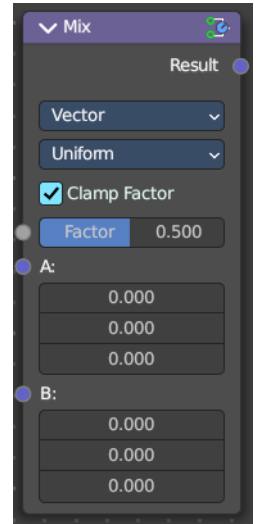

RGB Curves

Adjust the RGB channels by curves.

Input

Factor

The blend factor.

Color

The input color.



Properties

Curve Field

Channel buttons

Clicking on one of the channels displays the curve for each.

C (Combined RGB), R (Red), G (Green), B (Blue).



Navigation elements

They are described from left to right.

Zoom in and out

The two buttons with the magnifying glass at it zooms in and out in the curve window.

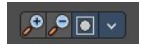

Use Clipping

Clipping options. Set up clipping for the stroke.

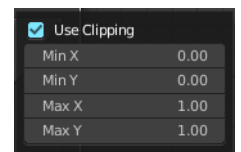

Tools

Tools is a menu where you can find some curve related tools.

Reset View

Resets the curve windows zoom.

Extend horizontal

Extends the curve before the first curve point and behind the last curve point horizontally.

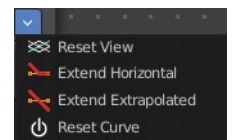

Extend extrapolated

Extends the curve before the first curve point and behind the last curve point extrapolated.

Reset Curve

Resets the curve to the initial shape.

Curve edit field

Create and tweak a Bezier curve that varies the input levels (X axis) to produce an output level (Y axis).

Selecting Points

You can select curve points. This reveals two edit boxes for the x and y coordinate of this point.

Selected points can be moved around. Left click at them, hold the mouse button down and move them to a new location.

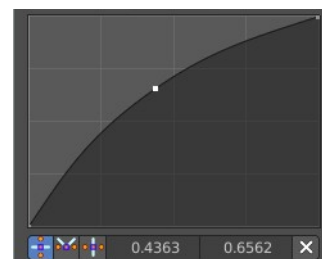

Adding Points

You can add new curve points by simply left clicking at the curve. Move the mouse to position them where you need it.

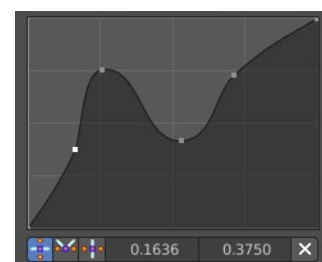

Curve point settings

When you have a point selected then you will reveal further settings at the bottom.

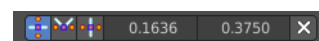

Vector Handle

Set handle type to Vector.

Auto Handle

Set handle type to Auto.

Auto Clamped Handle

Set handle type to Auto Clamped.

Output

Color

The color output.

Separate Color

Combine the single RGBA channels into a single image.

Input

Mode

- **RGB** colour processing
- **HSV** colour processing
- **HSL** colour processing

Image

The image input.

Output

Red, Green, Blue and Alpha

The red, green, blue and alpha channels of an image.



12.1.36 Editors - Geometry Nodes Editor - Header - Add Menu - Utilities - Text

Table of content

Detailed table of content.....	1
Add menu - Utilities - Text.....	2
Join Strings.....	2
Replace Strings.....	3
Slice String.....	3
String length.....	4
String to Curves.....	4
Value to String.....	6
Special Character.....	6

Detailed table of content

Detailed table of content

Detailed table of content.....	1
Add menu - Utilities - Text.....	2
Join Strings.....	2
Inputs.....	3
Delimiter.....	3
Strings.....	3
Output.....	3
String.....	3
Replace Strings.....	3
Inputs.....	3
String.....	3
Find.....	3
Replace.....	3
Output.....	3
String.....	3
Slice String.....	3
Inputs.....	3
String.....	3
Position.....	4
Length.....	4
Outputs.....	4
String.....	4
String length.....	4
Inputs.....	4
String.....	4
Outputs.....	4
Length.....	4
String to Curves.....	4
Inputs.....	4
String.....	4
Size.....	4

- Character Spacing.....4
- Word Spacing.....5
- Line Spacing.....5
- Max Width.....5
- Properties.....5
 - Font property.....5
 - Font browser.....5
 - Font Edit Box.....5
 - Number of Users.....5
 - Fake User.....5
 - Open Font.....5
 - Remove.....5
 - Overflow.....5
 - Align X.....5
 - Align Y.....6
- Output.....6
 - Curve Instances.....6
 - Line.....6
 - Pivot Point.....6
- Value to String.....6
 - Inputs.....6
 - Value.....6
 - Decimals.....6
 - Outputs.....6
 - String.....6
- Special Character.....6
 - Outputs.....6
 - Line Break.....6
 - Tab.....7

Add menu - Utilities - Text

Text object related nodes.

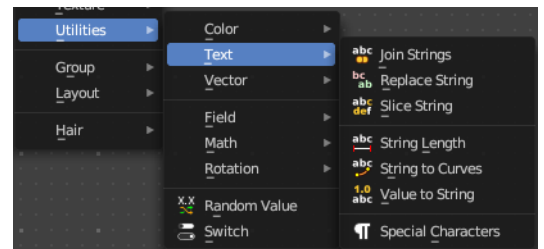

Join Strings

Allows you to join several string into a text string.

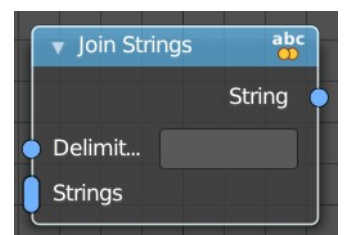

Inputs

Delimiter

Add a delimiter character.

Strings

The strings that you want to join into one text string.

Output

String

The output string.

Replace Strings

Find and replace strings inside of the input string.

Inputs

String

The input string.

Find

The string part that you want to replace.

Replace

The string part that you use to replace the selected string part.

Output

String

The strings that you want to join into one text string.

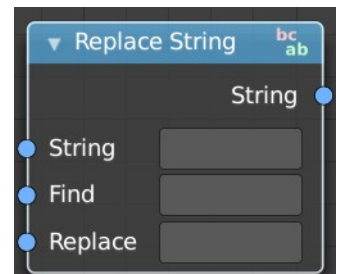

Slice String

Allows you to extract a string from a substring at given position with given length.

Inputs

String

The source string.

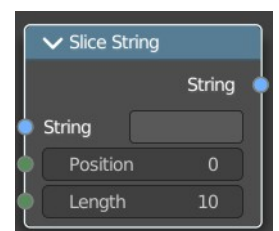

Position

The start position of the sub string.

Length

The length of the substring.

Outputs

String

The output substring.

String length

Gives back the number of characters in this string.

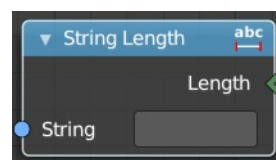

Inputs

String

The string that you want to calculate.

Outputs

Length

How many characters the string has.

String to Curves

Converts the letters of a text into curve objects.

Inputs

String

The text string to convert.

Size

Size of the string.

Character Spacing

The character spacing of the string.

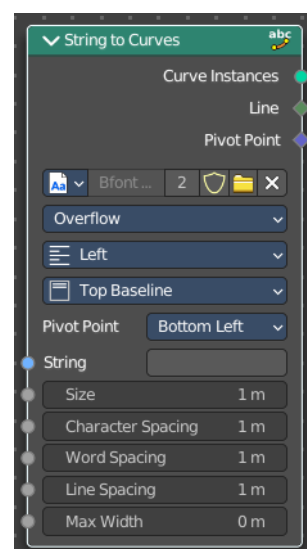

Word Spacing

The word spacing of the string.

Line Spacing

The line spacing of the string.

Max Width

The maximum width of the string.

Properties

Font property

Font browser

A list of the loaded fonts.

Font Edit Box

The active font.

Number of Users

The number of users for this font.

Fake User

Keep this font in the blender file even when it has no users. The default font is special in this regards. It will not vanish when you close the file, even when it has no fake user assigned.

Open Font

Load a system font.

Remove

Removes the active font. The default font is special in this regards. You cannot delete it.

Overflow

The overflow method for the text.

Align X

How to align the text horizontally

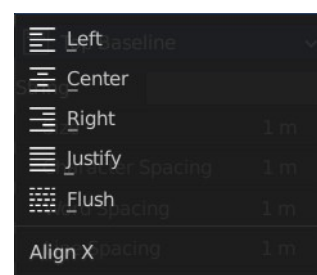
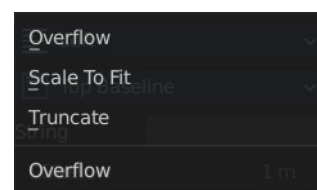
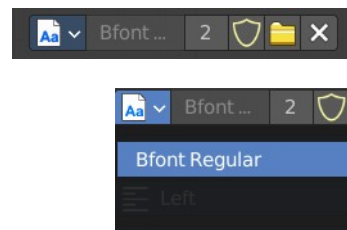

Align Y

How to align the text vertically.

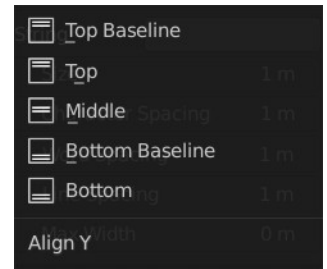

Output

Curve Instances

The curves output.

Line

Outputs the line number of the character.

Pivot Point

Outputs the selected pivot point position per character.

Value to String

Converts a value to a string.

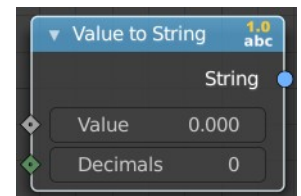

Inputs

Value

The input value.

Decimals

How many decimals the value has.

Outputs

String

The output string.

Special Character

Adds special characters to the text string.

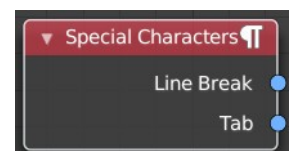

Outputs

Line Break

Adds a Line Break to the text string.

Tab

Adds a tab to the text string.



12.1.37 Editors - Geometry Nodes Editor - Header - Add Menu - Utilities - Vector

Table of content

Detailed table of content.....	1
Add menu - Vector.....	3
Vector Curves.....	3
Vector Math.....	5
Vector Rotate.....	6
Combine XYZ.....	6
Mix Vector.....	7
Separate XYZ.....	8

Detailed table of content

Detailed table of content

Detailed table of content.....	1
Add menu - Vector.....	3
Vector Curves.....	3
Inputs.....	3
Factor.....	3
Vector.....	3
Properties.....	3
Channel.....	3
Channel buttons.....	3
Curve edit field.....	3
Selecting Points.....	3
Adding Points.....	3
Navigation elements.....	4
Zoom in and out.....	4
Tools.....	4
Reset View.....	4
Vector Handle.....	4
Auto Handle.....	4
Auto Clamped Handle.....	4
Extend horizontal.....	4
Extend extrapolated.....	4
Reset Curve.....	4
Use Clipping.....	4
Delete Points.....	4
Outputs.....	4
Vector.....	4
Vector Math.....	5
Inputs.....	5
Vector.....	5
Vector.....	5
Scale.....	5
Properties.....	5

Operation.....	5
Outputs.....	5
Vector.....	5
Value.....	5
Vector Rotate.....	6
Inputs.....	6
Vector.....	6
Center.....	6
Axis.....	6
Angle.....	6
Properties.....	6
Type.....	6
Outputs.....	6
Vector.....	6
Combine XYZ.....	6
Input.....	6
X Y and Z.....	6
Output.....	7
Color.....	7
Mix Vector.....	7
Input.....	7
Factor.....	7
A.....	7
B.....	7
Properties.....	7
Data Type.....	7
Factor Mode.....	8
Output.....	8
Result.....	8
Separate XYZ.....	8
Input.....	8
Vector.....	8
Output.....	8
X, Y and Z.....	8

Add menu - Vector

Vector nodes are for calculating vector operations.

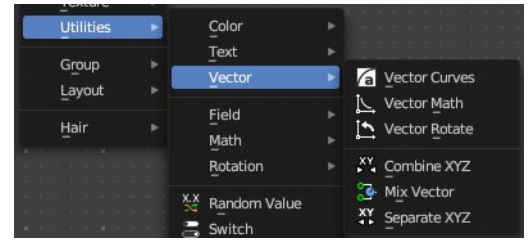

Vector Curves

The Vector Curves node maps an input vector components to a curve.

Inputs

Factor

Standard vector input.

Vector

Standard vector input.

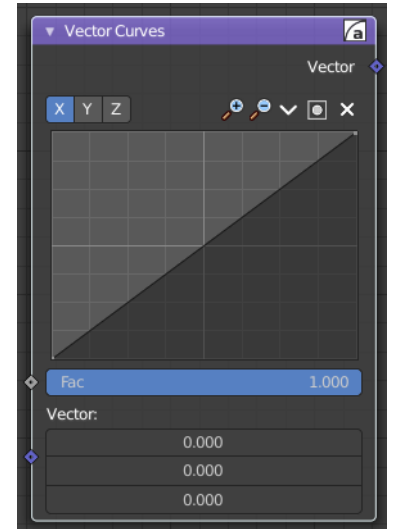

Properties

Channel

Channel buttons

X, Y, Z. Clicking on one of the channels displays the curve for each.



Curve edit field

Create and tweak a Bezier curve that varies the input levels (X axis) to produce an output level (Y axis).

Selecting Points

You can select curve points. This reveals two edit boxes for the x and y coordinate of this point.

Selected points can be moved around. Left click at them, hold the mouse button down and move them to a new location.

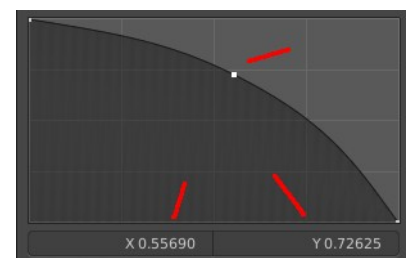

Adding Points

You can add new curve points by simply left clicking at the curve. Move the mouse to position them where you need it.

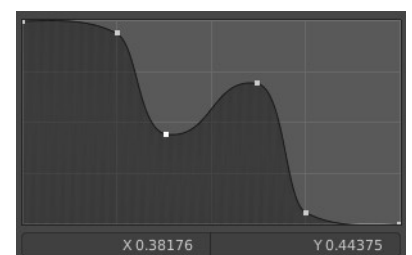

Navigation elements

The navigation elements at the top are described from left to right.



Zoom in and out

The two buttons with the magnifying glass at it zooms in and out in the curve window.

Tools

Tools is a menu where you can find some curve related tools.

Reset View

Resets the curve windows zoom.

Vector Handle

Set handle type to Vector.

Auto Handle

Set handle type to Auto.

Auto Clamped Handle

Set handle type to Auto Clamped.

Extend horizontal

Extends the curve before the first curve point and behind the last curve point horizontally.

Extend extrapolated

Extends the curve before the first curve point and behind the last curve point extrapolated.

Reset Curve

Resets the curve to the initial shape.

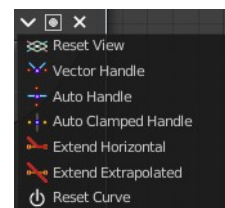

Use Clipping

Clipping options. Set up clipping for the stroke.

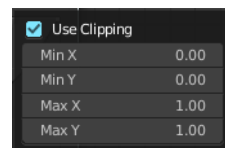

Delete Points

Deletes selected curve points.

Outputs

Vector

Standard vector output.

Vector Math

The Vector Math node performs the selected math operation on the input vectors.

Inputs

The inputs of the node are dynamic. Some inputs are only available in certain operations. For instance, the Scale input is only available in the Scale operator.

Vector

Input vector A.

Vector

Input vector B.

Scale

Input Scale.

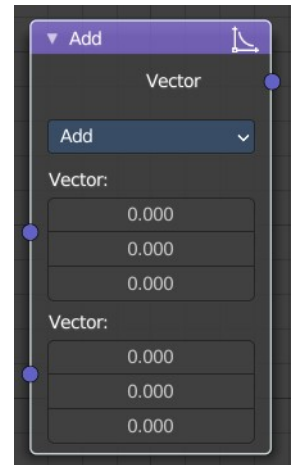

Properties

Operation

The vector math operator to be applied on the input vectors.



Outputs

The output of the node is dynamic. It is either a vector or a scalar depending on the operator. For instance, the Length operator have a scalar output while the Add operator have a vector output.

Vector

Output vector.

Value

Output value.

Vector Rotate

The Vector Rotate node allows rotations by a vector.

Inputs

The inputs of the node are dynamic. Some inputs are only available in certain operations. For instance, the Angle input is just available with the Axis Angle type.

Vector

Input vector.

Center

Input Center

Axis

Input Axis.

Angle

Input Angle

Properties

Type

The rotation type.

Outputs

Vector

The Output vector.

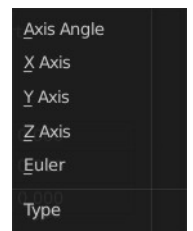
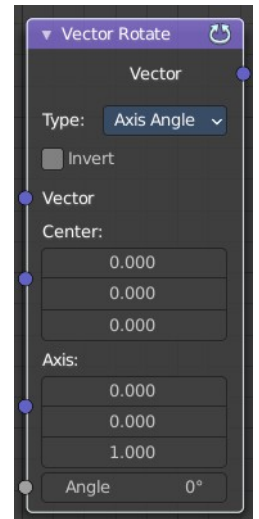

Combine XYZ

The Combine XYZ Node combines a vector from its individual components.

Input

X Y and Z

X, Y and Z values.

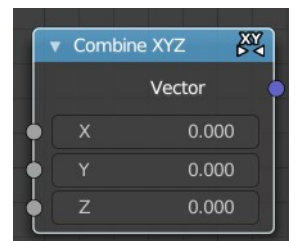

Output

Color

Color output.

Mix Vector

Allows to mix values and vectors in various ways. The node has three different modes. Float, Vector and Color. This here is the node in Vector mode.

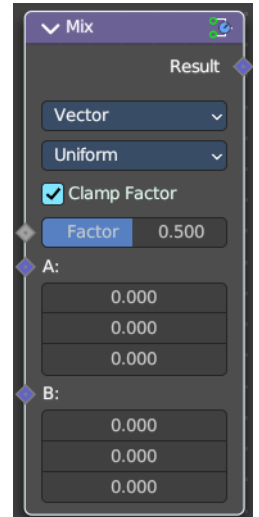

Input

Factor

The mix factor. With mode Uniform it is a single value. With mode Non Uniform it is a vector.

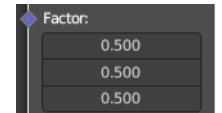
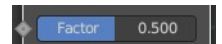

A

Vector A input.

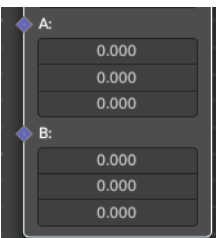

B

Vector B input.

Properties

Data Type

Which mode to use. We cover here the Vector mode.

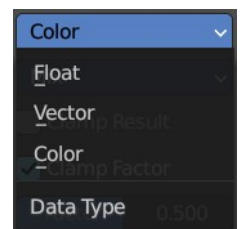

Factor Mode

Use a single value or a vector for the factor.

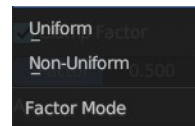

Output

Result

The output value or vector.

Separate XYZ

The Separate XYZ Node splits a vector into its individual components.

Input

Vector

The Input vector.

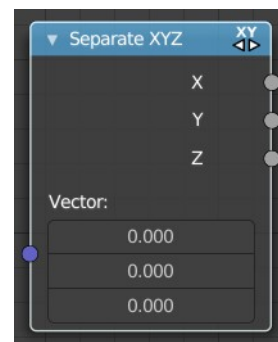

Output

X, Y and Z

The output vectors for X, Y and Z.

12.1.38 Editors - Geometry Nodes Editor - Header - Add Menu - Utilities - Field

Table of content

Detailed table of content.....	1
Add menu - Utilities.....	2
Accumulate Field.....	2
Evaluate at Index.....	3
Evaluate on Domain.....	4

Detailed table of content

Detailed table of content

Detailed table of content.....	1
Add menu - Utilities.....	2
Accumulate Field.....	2
Inputs.....	2
Value.....	2
Group Index.....	2
Properties.....	2
Data Type.....	2
Outputs.....	2
Leading and Trailing.....	2
Total.....	3
Evaluate at Index.....	3
Inputs.....	3
Index.....	3
Value.....	3
Properties.....	3
Data Type.....	3
Domain.....	3
Output.....	3
Value.....	3
Evaluate on Domain.....	4
Inputs.....	4
Value.....	4
Properties.....	4
Data Type.....	4
Domain.....	4
Outputs.....	4
Value.....	4

Add menu - Utilities

Utility nodes are mainly for mathematical operations.

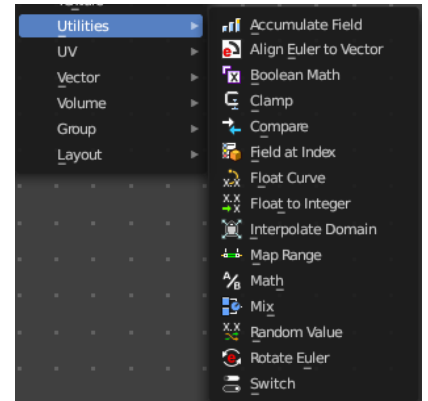

Accumulate Field

Creates a running total of a given Vector, Float, or Int field.

Inputs

Value

The field to be accumulated.

Group Index

The values of this input are used to aggregate the input into separate 'bins', creating multiple accumulations.

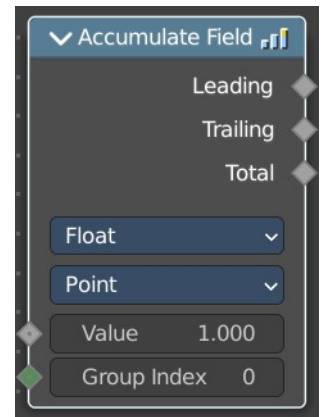

Properties

Data Type

What data type to work with.

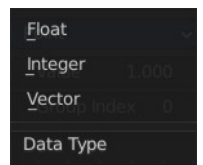

Domain

From which domain to use the data.

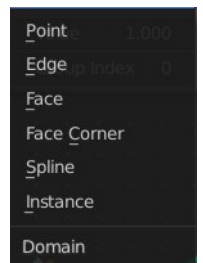

Outputs

Leading and Trailing

Returns the running totals starting at either the first value of each accumulations or 0 if there is no data

Total

Returns the total accumulation at all positions of the field.

Evaluate at Index

This node allows accessing data of other elements in the context geometry. It is similar to the Transfer Attribute node in Index mode. The main difference is that this node does not require a geometry input, because the context is used.

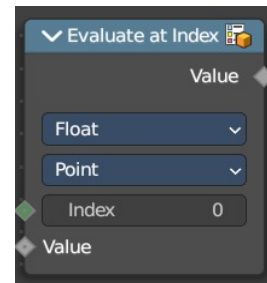

Inputs

Index

Input Index.

Value

Input Value.

Properties

Data Type

What data type to calculate.

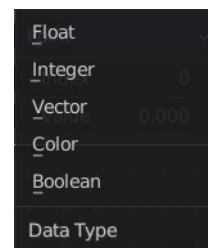

Domain

What geometry to calculate.

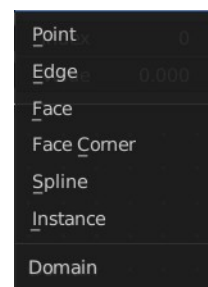

Output

Value

The output value.

Evaluate on Domain

This node evaluates an existing field on a separate domain in a larger field context - an alternative to the Capture Attribute node. This node gets the field type of an existing field from the input socket and interpolates the field type as an array in the output socket.

Inputs

Value

The input value to get the field.

Properties

Data Type

Select the Data Type - which can be float, integer, vector, color and boolean.

Domain

The domain the Field evaluates. This gets and filters the field type. The domain can be point, edge, face, face corner, spline or instance.

Outputs

Value

The output value.

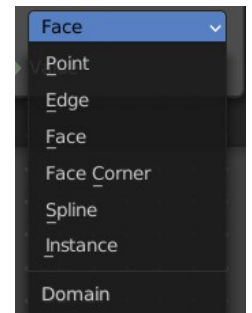
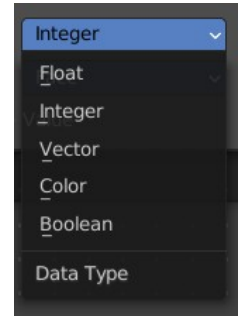
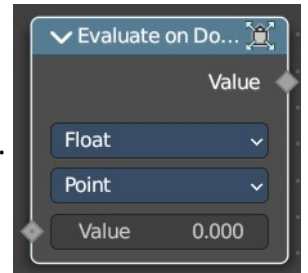

12.1.39 Editors - Geometry Nodes Editor - Header - Add Menu - Utilities - Math

Table of content

Detailed table of content.....	1
Add menu - Utilities - Math.....	5
Boolean Math.....	5
Clamp.....	6
Compare.....	7
Float Curve.....	8
Float to Integer.....	9
Map Range.....	10
Math.....	11
Mix.....	15

Detailed table of content

Detailed table of content

Detailed table of content.....	1
Add menu - Utilities - Math.....	5
Boolean Math.....	5
Inputs.....	5
Boolean.....	5
Properties.....	5
Operation.....	5
And.....	5
Or.....	5
Not.....	5
Not And (NAND).....	5
Nor (NOR).....	5
Equal (XNOR).....	5
Not Equal (XOR).....	6
Imply (IMPLY).....	6
Subtract (NIMPLY).....	6
Output.....	6
Boolean.....	6
Clamp.....	6
Inputs.....	6
Value.....	6
Min.....	6
Max.....	6
Properties.....	6
Clamp Type.....	6
Min Max.....	6
Range.....	6
Outputs.....	6
Result.....	6
Compare.....	7

Inputs.....	7
A, B.....	7
Properties.....	7
Input Type.....	7
Operation.....	7
A is less than B.....	7
A is lesser than or equal B.....	7
A is greater than B.....	7
A is greater than or equal B.....	7
A is equal B.....	7
A is not equal B.....	7
Output.....	7
Result.....	7
Float Curve.....	8
Inputs.....	8
Factor.....	8
Attribute.....	8
Properties.....	8
Curve Field.....	8
Channel buttons.....	8
Navigation elements.....	8
Zoom in and out.....	8
Use Clipping.....	8
Tools.....	8
Reset View.....	8
Extend horizontal.....	8
Extend extrapolated.....	8
Reset Curve.....	9
Curve edit field.....	9
Selecting Points.....	9
Adding Points.....	9
Curve point settings.....	9
Vector Handle.....	9
Auto Handle.....	9
Auto Clamped Handle.....	9
Output.....	9
Value.....	9
Float to Integer.....	9
Inputs.....	10
Float.....	10
Properties.....	10
Rounding Mode.....	10
Outputs.....	10
Integer.....	10
Map Range.....	10
Inputs.....	10
Value.....	10
From Min.....	10
From Max.....	10
To Min.....	10
To Max.....	10
Properties.....	11
Data Type.....	11

Interpolation Type.....	11
Clamp.....	11
Outputs.....	11
Value.....	11
Math.....	11
Inputs.....	11
Value.....	11
Addend.....	11
Base.....	11
Exponent.....	11
Epsilon.....	11
Distance.....	11
Min.....	12
Max.....	12
Increment.....	12
Scale.....	12
Degrees.....	12
Radians.....	12
Properties.....	12
Operation.....	12
Functions.....	12
Add.....	12
Subtract.....	12
Multiply.....	12
Divide.....	12
Multiply Add.....	12
Power.....	12
Logarithm.....	13
Square Root.....	13
Inverse Square Root.....	13
Absolute.....	13
Exponent.....	13
Comparison.....	13
Minimum.....	13
Maximum.....	13
Less Than.....	13
Greater Than.....	13
Sign.....	13
Compare.....	13
Smooth Minimum.....	13
Smooth Maximum.....	13
Rounding.....	13
Round.....	13
Floor.....	13
Ceil.....	14
Truncate.....	14
Fraction.....	14
Modulo.....	14
Wrap.....	14
Snap.....	14
Ping-pong.....	14
Trigonometric.....	14
Sine.....	14

Cosine.....	14
Tangent.....	14
Arcsine.....	14
Arccosine.....	14
Arctangent.....	14
Arctan2.....	14
Hyperbolic Sine.....	14
Hyperbolic Cosine.....	14
Hyperbolic Tangent.....	15
Conversion.....	15
To Radians.....	15
To Degrees.....	15
Clamp.....	15
Outputs.....	15
Value.....	15
Use Clipping.....	15
Delete Points.....	15
Curve window.....	15
X / Y values.....	15
Mix.....	15
Input.....	16
Float.....	16
Factor.....	16
A.....	16
B.....	16
Properties.....	16
Clamp Factor.....	16
Output.....	16
Result.....	16

Add menu - Utilities - Math

Utility nodes are mainly for mathematical operations.

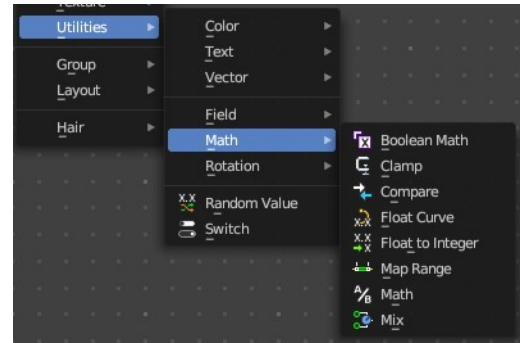

Boolean Math

The Boolean Math node performs a basic logical operation between its inputs.

Inputs

Boolean

Two standard Boolean inputs.

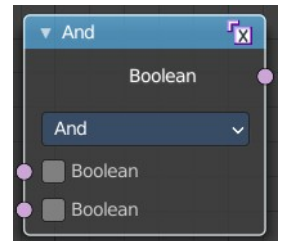

Properties

Operation

And

True if both inputs are true.

Or

True if either or both inputs are true.

Not

True if both inputs are false.

Not And (NAND)

True when at least one input is false.

Nor (NOR)

True when both inputs are false.

Equal (XNOR)

True when both inputs are equal.



Not Equal (XOR)

True when both inputs are different.

Imply (IMPLY)

True unless the first input is true and the second is false.

Subtract (NIMPLY)

True when the first input is true and the second is false.

Output

Boolean

Standard Boolean output.

Clamp

Clamps a value between a minimum and a maximum.

Inputs

Value

The input value to be clamped.

Min

The minimum value.

Max

The maximum value.

Properties

Clamp Type

Min Max

Clamp values using Min and Max values.

Range

Clamp values between Min and Max range.

Outputs

Result

The input value after clamping.

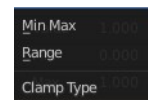
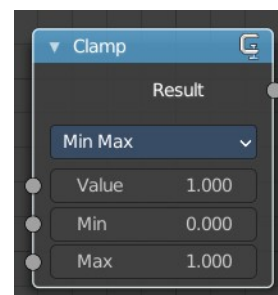

Compare

The Compare node takes two inputs and does a math comparison between them.

Inputs

A, B

Standard float value input.

Properties

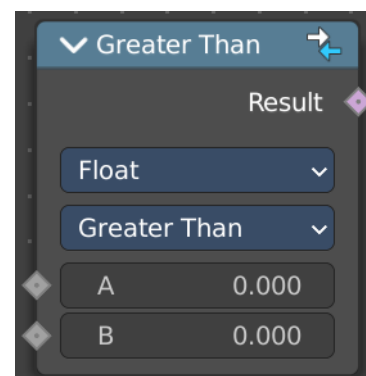

Input Type

What kind of data to compare.

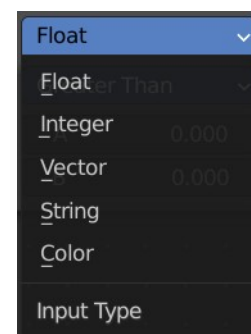

Operation

A is less than B

True if A is smaller than B.

A is lesser than or equal B

True if A is smaller or equal than B.

A is greater than B

True if A is bigger than B.

A is greater than or equal B

True if A is bigger or equal than B.

A is equal B

True if A and B are the same.

A is not equal B

True if A and B are different.

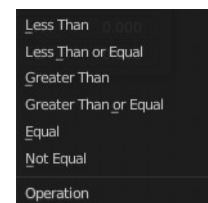

Output

Result

Standard Boolean output.

Float Curve

The Float Curve node maps an input float to a curve and outputs a float value. This curve can then be used for profiles for example.

Inputs

Factor

How strong the input influences the output value.

Attribute

The input value.



Properties

Curve Field

Channel buttons

Clicking on one of the channels displays the curve for each.

C (Combined RGB), R (Red), G (Green), B (Blue).



Navigation elements

They are described from left to right.

Zoom in and out

The two buttons with the magnifying glass at it zooms in and out in the curve window.

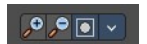

Use Clipping

Clipping options. Set up clipping for the stroke.

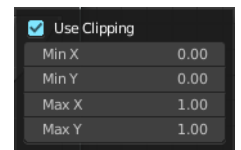

Tools

Tools is a menu where you can find some curve related tools.

Reset View

Resets the curve windows zoom.

Extend horizontal

Extends the curve before the first curve point and behind the last curve point horizontally.

Extend extrapolated

Extends the curve before the first curve point and behind the last curve point extrapolated.



Reset Curve

Resets the curve to the initial shape.

Curve edit field

Create and tweak a Bezier curve that varies the input levels (X axis) to produce an output level (Y axis).

Selecting Points

You can select curve points. This reveals two edit boxes for the x and y coordinate of this point.

Selected points can be moved around. Left click at them, hold the mouse button down and move them to a new location.

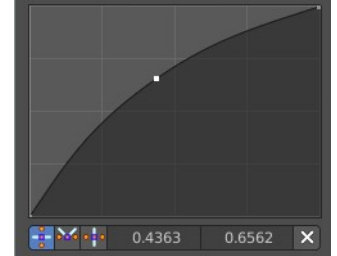

Adding Points

You can add new curve points by simply left clicking at the curve. Move the mouse to position them where you need it.

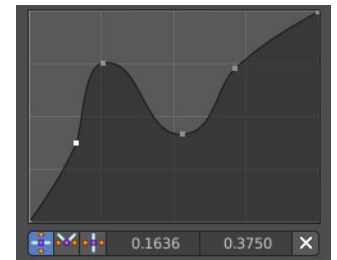

Curve point settings

When you have a point selected then you will reveal further settings at the bottom.



Vector Handle

Set handle type to Vector.

Auto Handle

Set handle type to Auto.

Auto Clamped Handle

Set handle type to Auto Clamped.

Output

Value

The output value.

Float to Integer

Converts a floating point value into an integer value.

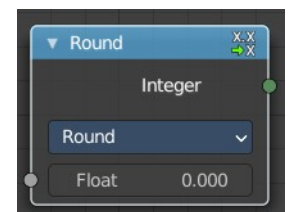

Inputs

Float

The input float value.

Properties

Rounding Mode

How the float value should be converted.

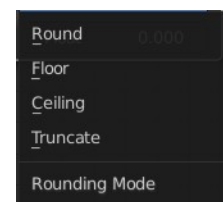

Outputs

Integer

The output integer value.

Map Range

This node converts (maps) an input value range into a destination range. By default, values outside the specified input range will be proportionally mapped as well. This node is similar to Map Value node but provides a more intuitive way to specify the desired output range.

Inputs

Value

Standard value input.

From Min

Start of the input value range.

From Max

End of the input value range.

To Min

Start of the destination range.

To Max

End of the destination range.

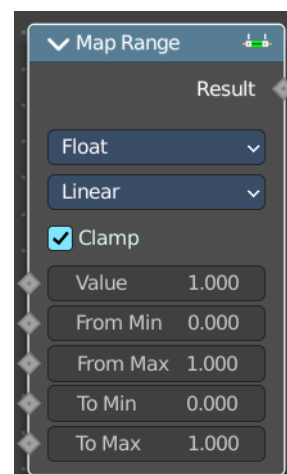

Properties

Data Type

The data type to calculate.

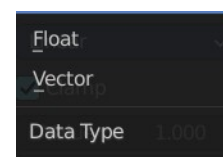

Interpolation Type

how to interpolate the values between min and max.

Clamp

Clamps values to Min/Max of the destination range.

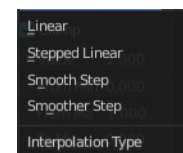

Outputs

Value

Standard value output.

Math

The Math Node performs math operations.

Inputs

The inputs of the node are dynamic. Some inputs are only available with certain operations. For example, the Addend input is only available in the Multiply Add operator.

Value

Input Value. Trigonometric functions read this value as radians.

Addend

Input Addend.

Base

Input Base.

Exponent

Input Exponent.

Epsilon

Input Epsilon.

Distance

Input Distance.

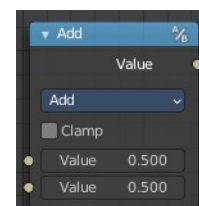

Min

Input Minimum.

Max

Input Maximum.

Increment

Input Increment.

Scale

Input Scale.

Degrees

Input Degrees.

Radians

Input Radians.

Properties

Operation

The mathematical operator to be applied to the input values:

Functions	Comparison	Rounding	Trigonometric	Conversion
Add	Minimum	Round	Sine	To Radians
Subtract	Maximum	Floor	Cosine	To Degrees
Multiply	Less Than	Ceil	Tangent	
Divide	Greater Than	Truncate	Arcsine	
Multiply Add	Sign	Fraction	Arccosine	
Power	Compare	Modulo	Arctangent	
Logarithm	Smooth Minimum	Wrap	Arctan2	
Square Root	Smooth Maximum	Snap	Hyperbolic Sine	
Inverse Square Root		Ping-pong	Hyperbolic Cosine	
Absolute			Hyperbolic Tangent	
Exponent				

Functions

Add

The sum of the two values.

Subtract

The difference between the two values.

Multiply

The product of the two values.

Divide

The division of the first value by the second value.

Multiply Add

The sum of the product of the two values with Addend.

Power

The Base raised to the power of Exponent.

Logarithm

The log of the value with a Base as its base.

Square Root

The square root of the value.

Inverse Square Root

One divided by the square root of the value.

Absolute

The input value is read with without regard to its sign. This turns negative values into positive values.

Exponent

Raises Euler's number to the power of the value.

Comparison

Minimum

Outputs the smallest of the input values.

Maximum

Outputs the largest of two input values.

Less Than

Outputs 1.0 if the first value is smaller than the second value. Otherwise the output is 0.0.

Greater Than

Outputs 1.0 if the first value is larger than the second value. Otherwise the output is 0.0.

Sign

Extracts the sign of the input value. All positive numbers will output 1.0. All negative numbers will output -1.0. And 0.0 will output 0.0.

Compare

Outputs 1.0 if the difference between the two input values is less than or equal to Epsilon.

Smooth Minimum

Smooth Minimum.

Smooth Maximum

Smooth Maximum.

Rounding

Round

Round the input value to the nearest integer.

Floor

Rounds the input value down to the nearest integer.

Ceil

Rounds the input value up to the nearest integer.

Truncate

Outputs the integer part of the value.

Fraction

Fraction.

Modulo

Outputs the remainder once the first value is divided by the second value.

Wrap

Outputs a value between Min and Max based on the absolute difference between the input value and the nearest integer multiple of Max less than the value.

Snap

Round the input value to down to the nearest integer multiple of Increment.

Ping-pong

The output value is moved between 0.0 and the Scale based on the input value.

Trigonometric

Sine

The Sine of the input value.

Cosine

The Cosine of the input value.

Tangent

The Tangent of the input value.

Arcsine

The Arcsine of the input value.

Arccosine

The Arccosine of the input value.

Arctangent

The Arctangent of the input value.

Arctan2

Outputs the Inverse Tangent of the first value divided by the second value measured in radians.

Hyperbolic Sine

The Hyperbolic Sine of the input value.

Hyperbolic Cosine

The Hyperbolic Cosine of the input value.

Hyperbolic Tangent

The Hyperbolic Tangent of the input value.

Conversion

To Radians

Converts the input from degrees to radians.

To Degrees

Converts the input from radians to degrees.

Clamp

Limits the output to the range (0.0 to 1.0). See Clamp.

Outputs

Value

Numerical value output.

Use Clipping

Clipping options. Set up clipping for the stroke.

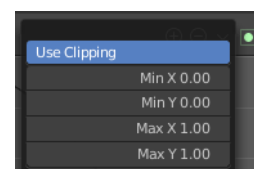

Delete Points

Deletes selected curve point.

Curve window

Tweak and adjust the falloff curve by clicking at a curve point and dragging it around.

Double click adds a new point.

Holding down ctrl activates temporary snapping.

Holding down shift enables slower movement, which allows more accurate setting.

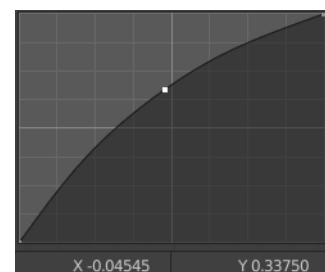

X / Y values

The x and y value of the currently selected point.

Mix

Allows to mix values and vectors in various ways. The node has three different modes. Float, Vector and Color. This node covers the Float mode

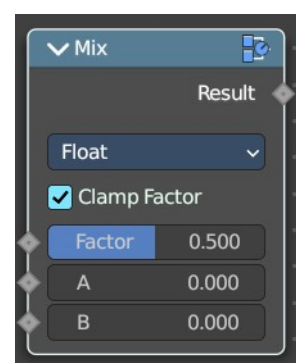

Input

Float

Factor

The mix factor.

A

Float value A input.

B

Float value B input.

Properties

Clamp Factor

Clamp the factor to 0-1 range.

Output

Result

The output value or vector.



12.1.4 Editors - Geometry Nodes Editor - Header - Select Menu

Table of content

Select menu.....	1
Legacy.....	1
Box select.....	1
Circle select.....	1
All.....	2
None.....	2
Inverse.....	2
Linked From.....	2
Linked To.....	2
Grouped.....	2
Grouped Extend.....	2
Activate same type previous.....	2
Activate same type next.....	2
Find Node.....	2

Select menu

Here you will find the select functionality.

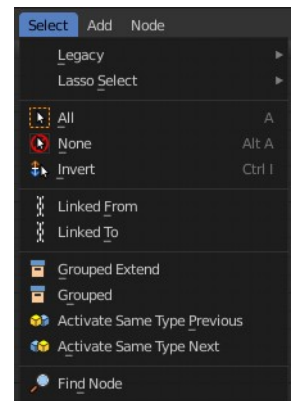

Legacy

The legacy sub menu contains tools that exists in the tool shelf already. It's the old way to do things. Different to the tools in the tool shelf, these tools are usually modal. And performs once. You have to call them again in case you want to repeat the tool.



Box select

Draw a rectangle to select everything inside of the rectangle.

It automatically adds to the current selection. Holding down shift subtracts from the selection.

Circle select

Brush select content. The radius of the brush can be adjusted by holding down left mouse button and using the scroll wheel or the + or - button at the numpad.

It automatically adds to the current selection. Holding down shift subtracts from the selection. To exit the circle select tool click with the right mouse button.

Lasso Select

A sub menu with the available lasso select modes.

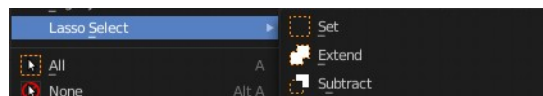

All

Select everything.

None

Select nothing.

Inverse

Invert the current selection.

Linked From

Select the nodes that are linked from the currently selected nodes. The nodes before in the hierarchy.

Linked To

Select the nodes that are linked to the currently selected nodes. The nodes behind in the hierarchy.

Grouped

Select grouped nodes.

Grouped Extend

Select grouped nodes, and extend from the current selection.

Activate same type previous

Activate same node type before the current selection, step by step.

Activate same type next

Activate same node type after the current selection, step by step.

Find Node

This button will open a search dialog where you can search for node types and select them in the current hierarchy.

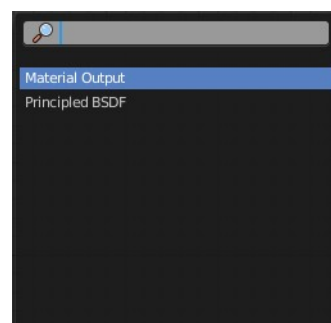

12.1.40 Editors - Geometry Nodes Editor - Header - Add Menu - Utilities - Rotation

Table of content

Detailed table of content.....	1
Add menu - Utilities.....	2
Align Euler to Vector.....	2
Rotate Euler.....	3

Detailed table of content

Detailed table of content

Detailed table of content.....	1
Add menu - Utilities.....	2
Align Euler to Vector.....	2
Inputs.....	2
Rotation.....	2
Factor.....	2
Vector.....	2
Properties.....	2
Align Axis.....	2
Pivot.....	2
Output.....	3
Rotation.....	3
Rotate Euler.....	3
Inputs.....	3
Rotation.....	3
Rotate By.....	3
Properties.....	3
Rotate Type.....	3
Axis Angle.....	3
Euler.....	3
Rotate Space.....	3
Object.....	3
Point.....	3
Outputs.....	3
Rotation.....	3

Add menu - Utilities

Utility nodes are mainly for mathematical operations.

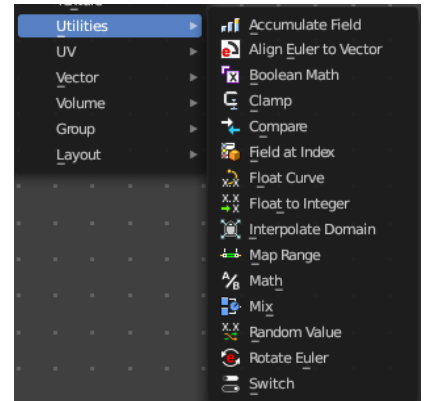

Align Euler to Vector

Aligns a euler value to a vector.

Inputs

Rotation

The input euler rotation vector.

Factor

The factor to align the euler value to the vector.

Vector

The vector to align to.

Properties

Align Axis

To which axis to align the vector.

Pivot

The pivot axis.

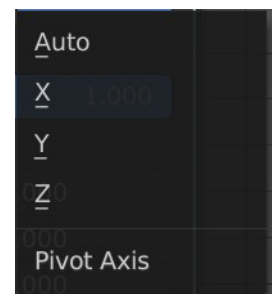
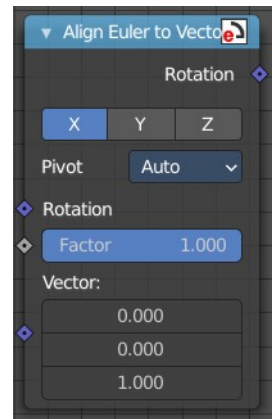

Output

Rotation

The output rotation euler angle.

Rotate Euler

Rotates an euler rotation.

Inputs

Rotation

Use the rotation of an existing geometry.

Rotate By

The input rotation.

Properties

Rotate Type

Axis Angle

Rotate around an axis by an angle.

Euler

Rotate around the x, y and z axis.

Rotate Space

Object

Rotate points in the local space of the object.

Point

Rotate every point in its local space.

Outputs

Rotation

The euler angle output.

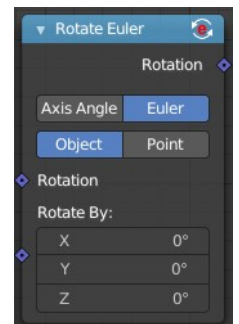

12.1.41 Editors - Geometry Nodes Editor - Header - Add Menu - Utilities

Table of content

Detailed table of content.....	1
Add menu - Utilities.....	3
Random Value.....	3
Repeat Zone.....	4
Switch.....	5

Detailed table of content

Detailed table of content

Detailed table of content.....	1
Add menu - Utilities.....	3
Random Value.....	3
Input.....	3
Min.....	3
Max.....	3
ID.....	3
Seed.....	3
Properties.....	3
Data Type.....	3
Output.....	3
Value.....	3
Repeat Zone.....	4
Repeat Zone Input.....	5
Input.....	5
Geometry.....	5
Iterations.....	5
Output.....	5
Geometry.....	5
Repeat Zone Output.....	5
Input.....	5
Geometry.....	5
Output.....	5
Geometry.....	5
Switch.....	5
Inputs.....	5
Switch.....	5
A.....	5
B.....	6
Properties.....	6
Input Type.....	6
Outputs.....	6
Output.....	6

Add menu - Utilities

Utility nodes are mainly for mathematical operations.

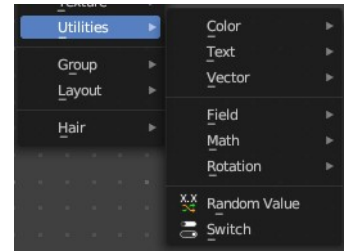

Random Value

Generates a random value.

Input

Min

The minimum value of the range. This input is only available for Float, Integer, and Vector types.

Max

The maximum value of the range. This input is only available for Float, Integer, and Vector types.

ID

An ID to drive the random number generator seed. By default, this input uses the same value as if the ID Node, which is the id attribute of the context geometry if it exists, and otherwise the index.

Seed

The random seed for the random number generation.

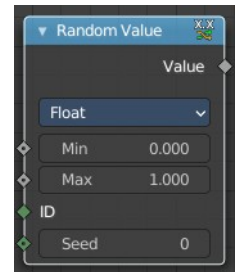

Properties

Data Type

What kind of random value to create. The items should be self explaining.

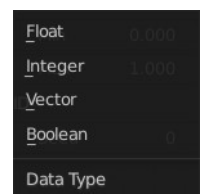

Output

Value

The output value.

Repeat Zone

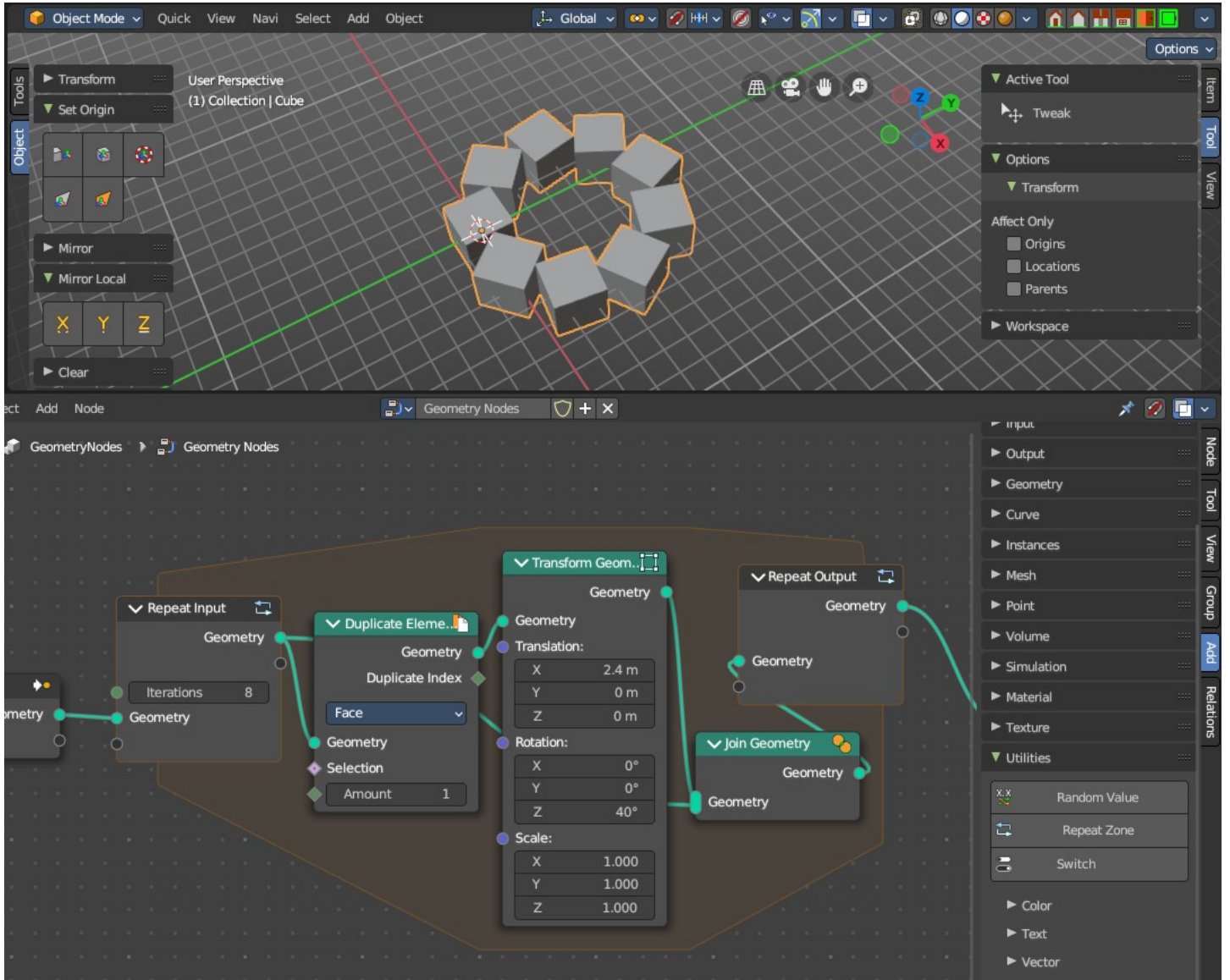

When adding a repeat zone, two nodes are added with a “zone” set between them. The inputs connected to the *Repeat Input* node reads and gets data at the beginning of the loop before starting the looping - then the data is processed within the zone, here you can set any changes to the data to then repeat the execution again at the beginning of the chain for the next iteration of the loop. This chain of operations is repeated the specified number of times in the *Repeat Input* node.

In the example in the image above, we duplicate the cube, transform it with a rotation, then join it together again. We do this 8 times in a loop, creating a circular array.

Note: *It is not possible to set data outside the Repeat Zone, you can only get data from outside the Repeat Zone. Any data connected from the outside of the zone are constant throughout every iteration based on their*

value at the current frame. The result of the looping can only be accessed via the Repeat Output node.

Repeat Zone Input

The beginning of the iteration or loop.

Input

Iterations

Number of repetitions or loops.

Geometry

Standard geometry input.

Output

Geometry

Standard geometry output.

Repeat Zone Output

The result and output of the iteration or loop. You can define custom attributes outputs here from the

Input

Geometry

Standard geometry output.

Output

Geometry

Standard geometry output.

Switch

Switch between two inputs values based on a boolean.

Inputs

Switch

The boolean switch.

A

The input value A. Used when the switch is off.

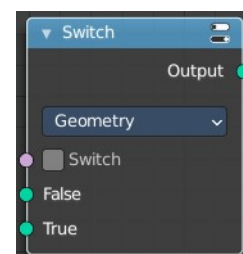

B

The input value B. Used when the switch is on.

Properties

Input Type

What input type the values are, which defines what type to output then.

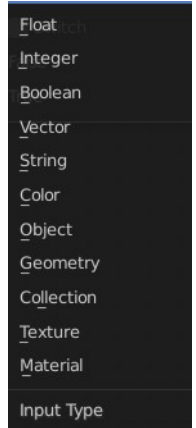

Outputs

Output

Numerical value output.

12.1.42 Editors - Geometry Nodes Editor - Header - Add Menu - Group

Table of content

Add menu - Group.....	1
Make Group.....	1
Insert into Group.....	2
Ungroup.....	3
Toggle Edit Group.....	3
Group Input.....	3
Group Output.....	3
List of Node Groups.....	3

Add menu - Group

Node groups allows you to group different nodes of the material together to reduce the visual complexity. A node group acts like any other node.

Material node groups should not include Input nodes, like Image nodes, or Output nodes.

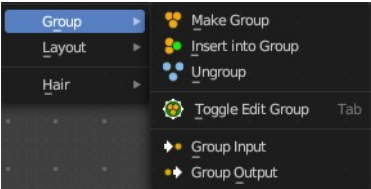

If you include a source node in your group, you will end up having the source node appearing twice: once inside the group, and once outside the group in the new material node tree.

If you include an output node in the group, there will not be an output socket available from the group!

Make Group

Groups the selected nodes together.

Select the nodes that you want to group together. Choose Make Group. You will now see a green background. This indicates that the group is created, and that you are in edit mode for the group now.

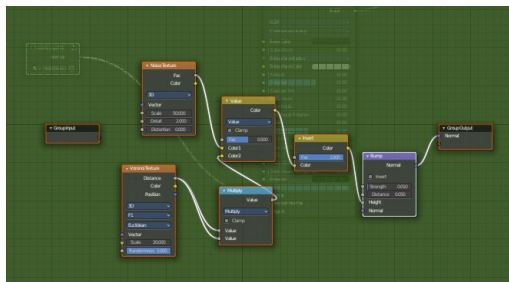
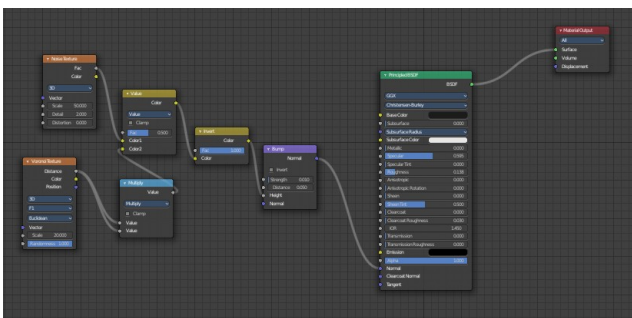

To exit the group edit mode press Tab key, or choose Toggle Edit Group menu item in the sidebar in the Relations tab in the Group panel. That way you can also enter the Group Edit mode again.

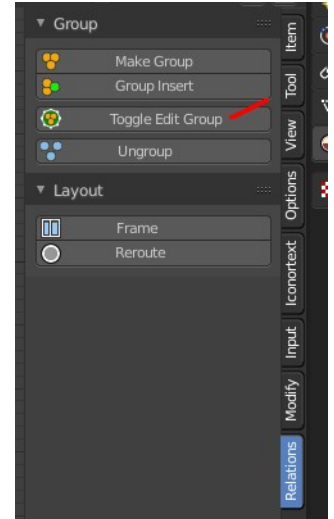
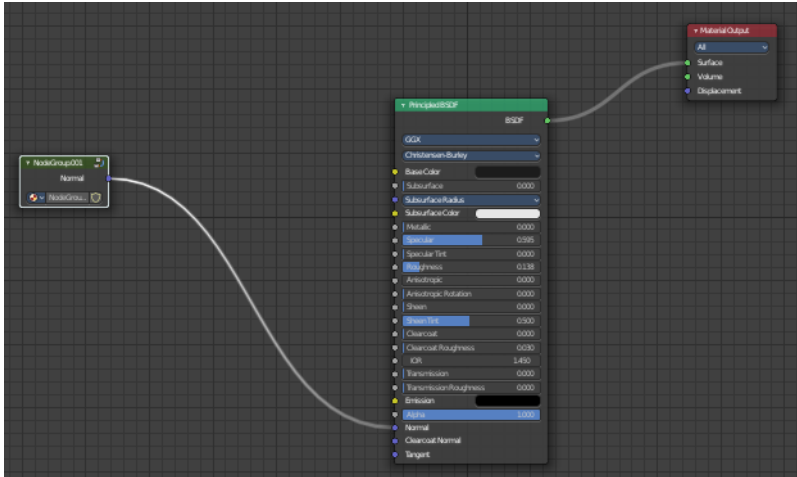

There is a third way to enter the group edit mode. Click at the right upper icon of the group node.

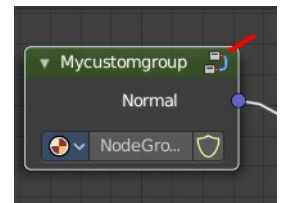

A group can be further collapsed by clicking at the triangle button in the upper left corner.

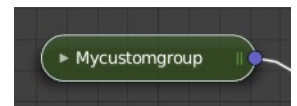

The group can be renamed in the sidebar in the Item tab and in the Properties tab in the Node panel.

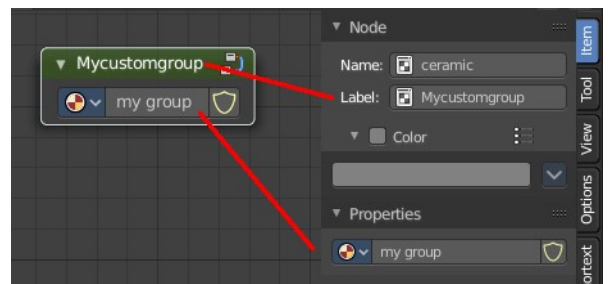

Insert into Group

Allows you to insert a node into a node group.

Select the node, hold down Shift, then select the node group so that both are selected. Then perform the operator.

Ungroup

Ungroups an existing group. You need to be outside of the group edit mode.

Toggle Edit Group

Enters a node group for editing. Or when you are in a node group, exits the node group editing.

Group Input

Adds a Group Input node. This node is usually already part of a new created group.

Group Output

Adds a Group Output node. This node is usually already part of a new created group.

List of Node Groups

Once you have created a node group it will also show up in the group menu. Groups can be inserted to other materials too.

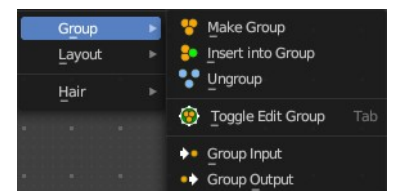

12.1.43 Editors - Geometry Nodes Editor - Header - Add Menu - Layout

Table of content

- Add menu - Layout.....1
- Frame.....1
- Adding and Removing Nodes.....2
- Resizing Frame.....2
- Label and Color.....2
- Reroute.....2
- Move, Rotate, Scale.....3

Add menu - Layout

These nodes helps organizing the node layout.



Frame

The Frame node allows you to drop nodes into a frame. This frame can be dragged around as a whole.

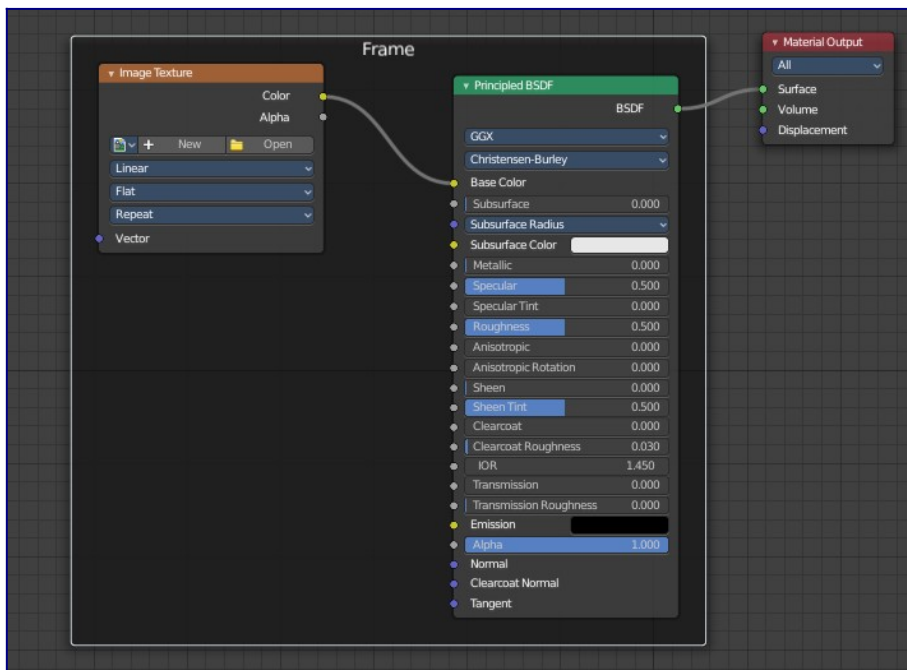
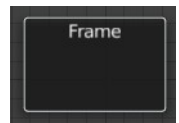

Adding and Removing Nodes

Nodes can be added by simply dropping them onto the frame. Or with the Join in New Frame menu item in the Node menu.

To remove a node from the frame use Remove from Frame.

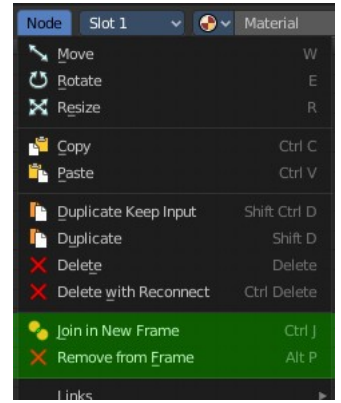

Resizing Frame

When the Frame node is first placed in the node editor workspace you can resize it by dragging one of the edges.

Once a node is placed in the Frame, the Frame shrinks around the nodes. You cannot resize it anymore with handlers. Just by dragging around the nodes inside of the frame.

This behavior can be changed by disabling the *Shrink* option in the Item tab in the Properties panel. Then you can resize the frame again by dragging the edges.

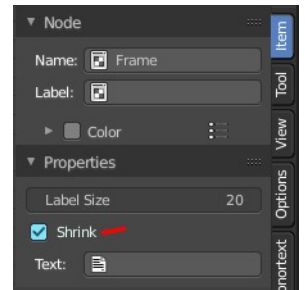

Label and Color

You can change the name of a frame in the Node panel. And you can give it a custom color by checking the Color checkbox and adjusting the color then.

Reroute

Adds a reroute point that can be used to reroute connections. It allows just one input, but allows multiple output connections.

To quickly add a Reroute node into an existing connection, hold Shift and Right Mouse and drag the mouse to cut through the link. A new reroute node will be added.

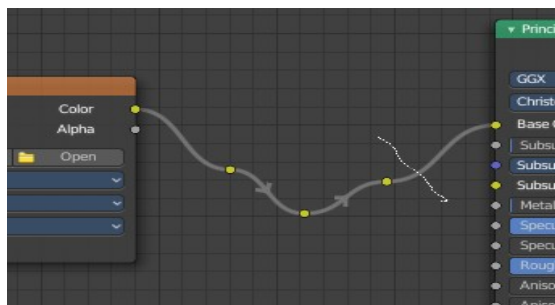
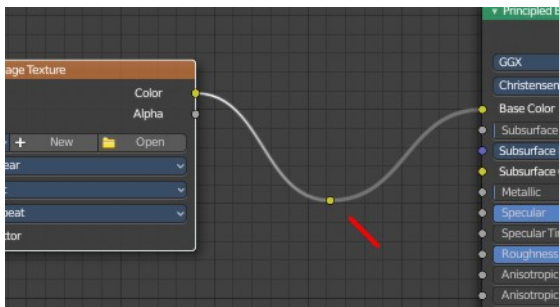

When you exceed a specific angle amount between the reroute nodes, then the node connection becomes a sharp corner, and not longer a Bezier like soft curve.

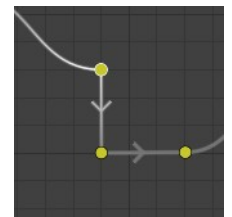

Move, Rotate, Scale

A normal node has a handler. The reroute dot not. You can't simply move it around with the mouse by clicking at the top area. It has none. You have to use the move, rotate and scale commands. They can be found in the View menu.

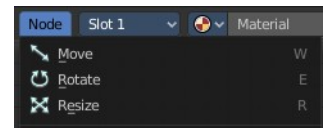

12.1.44 Editors - Geometry Nodes Editor - Header - Add Menu - Hair - Deformation

Table of content

Detailed table of content.....	1
Add menu - Hair - Deformation.....	3
Blend Hair Curves.....	4
Displace Hair Curves.....	5
Frizz Hair Curves.....	6
Hair Curves Noise.....	7
Roll Hair Curves.....	8
Rotate Hair Curves.....	9
Shrinkwrap Hair Curves.....	10
Smooth Hair Curves.....	10
Straighten Hair Curves.....	11
Trim Hair Curves.....	12

Detailed table of content

Table of content

Detailed table of content.....	1
Add menu - Hair - Deformation.....	3
Blend Hair Curves.....	4
Input.....	4
Geometry.....	4
Factor.....	4
Blend Radius.....	4
Blend Neighbours.....	4
Preserve Length.....	4
Output.....	4
Geometry.....	4
Displace Hair Curves.....	5
Input.....	5
Geometry.....	5
Factor.....	5
Shape.....	5
Object.....	5
Displace Vector.....	5
Surface Object.....	5
Surface Geometry.....	5
Surface UV Map.....	5
Surface Normal Displacement.....	5
Output.....	5
Geometry.....	5
Frizz Hair Curves.....	6
Input.....	6
Geometry.....	6
Cumulative Offset.....	6

Factor.....	6
Distance.....	6
Shape.....	6
Seed.....	6
Preserve Length.....	6
Output.....	6
Geometry.....	6
Offset Vector.....	6
Hair Curves Noise.....	7
Input.....	7
Geometry.....	7
Cumulative Offset.....	7
Factor.....	7
Distance.....	7
Shape.....	7
Scale.....	7
Scale along Curve.....	7
Offset per curve.....	7
Seed.....	7
Preserve Length.....	7
Output.....	7
Geometry.....	7
Offset Vector.....	7
Roll Hair Curves.....	8
Input.....	8
Factor.....	8
Subdivision.....	8
Variation Level.....	8
Roll Length.....	8
Roll Radius.....	8
Roll Depth.....	8
Roll Taper.....	8
Retain Overall Shape.....	8
Roll Direction.....	8
Random Orientation.....	8
Seed.....	8
Preserve Length.....	8
Output.....	9
Geometry.....	9
Rotate Hair Curves.....	9
Input.....	9
Geometry.....	9
Factor.....	9
Axis.....	9
Angle.....	9
Random Off.....	9
Lock Ends.....	9
Seed.....	9
Output.....	9
Geometry.....	9
Shrinkwrap Hair Curves.....	10
Input.....	10
Geometry.....	10

- Surface.....10
- Surface Object.....10
- Factor.....10
- Offset Distance.....10
- Above Surface.....10
- Smoothing Steps.....10
- Lock Roots.....10
- Output.....10
 - Geometry.....10
- Smooth Hair Curves.....10
 - Input.....10
 - Geometry.....10
 - Amount.....11
 - Shape.....11
 - Iterations.....11
 - Weight.....11
 - Lock Tip.....11
 - Preserve Length.....11
 - Output.....11
 - Geometry.....11
- Straighten Hair Curves.....11
 - Input.....11
 - Geometry.....11
 - Amount.....11
 - Shape.....11
 - Preserve Length.....11
 - Output.....12
 - Geometry.....12
- Trim Hair Curves.....12
 - Input.....12
 - Geometry.....12
 - Scale Uniform.....12
 - Length Factor.....12
 - Replace Length.....12
 - Length.....12
 - Mask.....12
 - Random Offset.....12
 - Pin at parameter.....12
 - Seed.....12

Add menu - Hair - Deformation

Hair nodes are Node Groups found in the Essentials Library included with Bforartists. They differ from the other nodes in the add menu due to being mid level node groups instead of individual low level nodes.

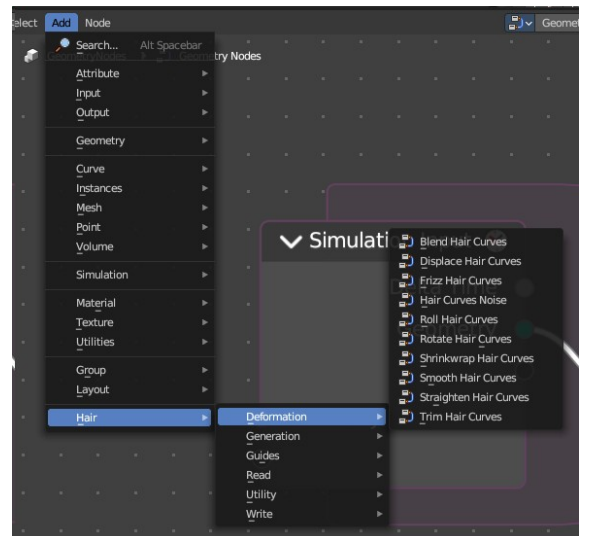

You can enter the node tree by clicking at the icon up right. Tab to leave the node tree. And you can of course also edit the node tree.

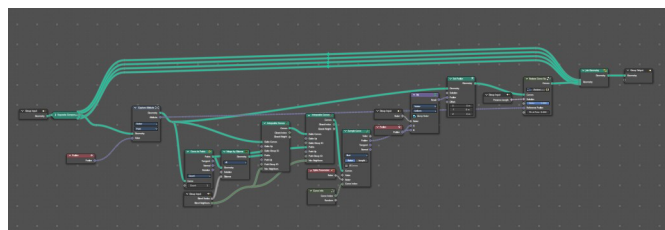
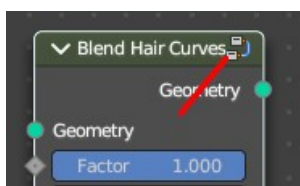

Blend Hair Curves

Blends the shape between multiple hair curves in a certain radius together.

Input

Geometry

The input geometry.

Factor

Factor to blend overall effect.

Blend Radius

Radius to select neighbors for blending.

Blend Neighbours

Amount of neighbors used for blending.

Preserve Length

Preserve the length of each curve during deformation.

Output

Geometry

The output geometry.

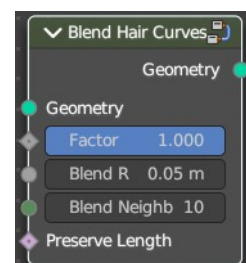

Displace Hair Curves

Displaces hair curves by a vector based on options.

Input

Geometry

The input geometry.

Factor

Factor to blend overall effect.

Shape

Shape of the influence along curves. 0 means constant. 0.5 means linear.

Object

The object to determine the displacement space.

Displace Vector

The vector for the displacement.

Surface Object

Surface object used to sample the normal for displacement.

Surface Geometry

Surface geometry used to sample the normal for displacement.

Surface UV Map

Surface UV Map used to sample the normal for displacement.

Surface Normal Displacement

Amount of displacement along the surface normals.

Output

Geometry

The output geometry.

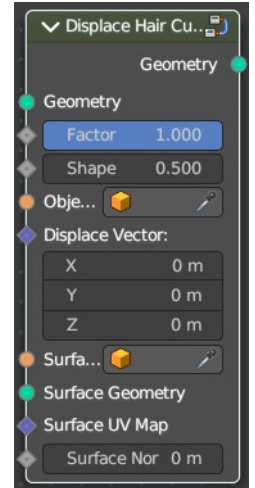

Frizz Hair Curves

Deforms hair curves using a random vector per point to frizz them.

Input

Geometry

The input geometry.

Cumulative Offset

Apply offset cumulatively.

Factor

Factor to blend overall effect.

Distance

Overall distance factor for the deformation.

Shape

Shape of the influence along curves. 0 means constant. 0.5 means linear.

Seed

Random seed for the operation.

Preserve Length

Preserve the length of each curve during deformation.

Output

Geometry

The output geometry.

Offset Vector

The vector by which each point was offset during deformation.

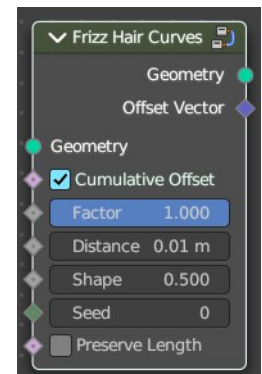

Hair Curves Noise

Deforms hair curves using noise texture.

Input

Geometry

The input geometry.

Cumulative Offset

Apply offset cumulatively.

Factor

Factor to blend overall effect.

Distance

Overall distance factor for the deformation.

Shape

Shape of the influence along curves. 0 means constant. 0.5 means linear.

Scale

Scale of the noise texture by root position.

Scale along Curve

Scale of the noise texture along the curve.

Offset per curve

Seed

Random seed for the operation.

Preserve Length

Preserve the length of each curve during deformation.

Output

Geometry

The output geometry.

Offset Vector

The vector by which each point was offset during deformation.

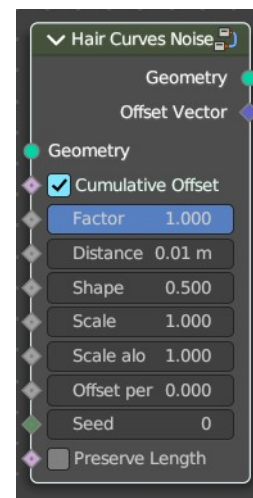

Roll Hair Curves

Rolls up hair curves, starting from their tips.

Input

Factor

Factor to blend overall effect.

Subdivision

Subdivision level applied before deformation.

Variation Level

Level of smoothing on the roll path to include shape variation.

Roll Length

Length of each curve to be rolled

Roll Radius

Radius of the rolls.

Roll Depth

Depth offset of the rolls.

Roll Taper

Taper of the roll.

Retain Overall Shape

Offset the roll along the original curve to retain shape.

Roll Direction

The axis around each curve is rolled.

Random Orientation

Amount of randomization of the direction of the roll.

Seed

Random seed for the operation.

Preserve Length

Preserve the length of each curve during deformation.

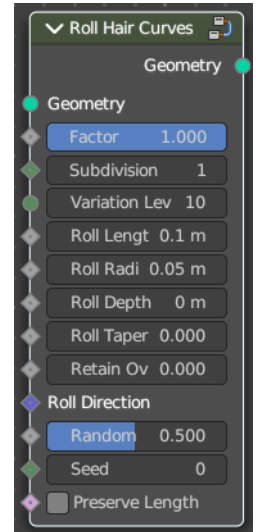

Output

Geometry

The output geometry.

Rotate Hair Curves

Rotates each hair curve around an axis.

Input

Geometry

The input geometry.

Factor

Factor to blend overall effect.

Axis

Rotation Axis. The default is tangent at root.

Angle

Angle of rotation

Random Off

Random offset to the rotation angle per curve.

Lock Ends

Lock rotation to the axis between the curve ends.

Seed

Random seed for the operation.

Output

Geometry

The output geometry.

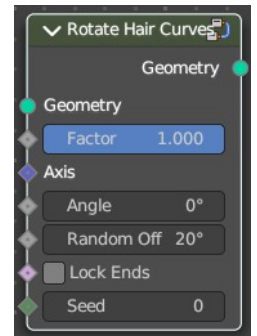

Shrinkwrap Hair Curves

Shrinkwrap hair curves to a mesh surface from below and optionally from above.

Input

Geometry

The input geometry.

Surface

Surface geometry used for shrinkwrap.

Surface Object

A surface object used for shrinkwrap.

Factor

Factor to blend overall effect.

Offset Distance

Distance of the surface to shrinkwrap.

Above Surface

Blend shrinkwrap for points above the surface.

Smoothing Steps

The steps of Smoothing applied after shrinkwrap.

Lock Roots

Lock the position of root points.

Output

Geometry

The output geometry.

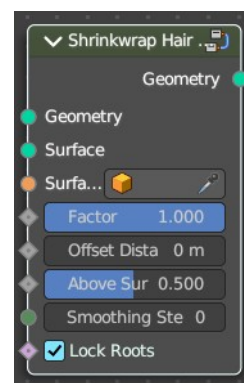

Smooth Hair Curves

Smooths the shape of hair curves.

Input

Geometry

The input geometry.

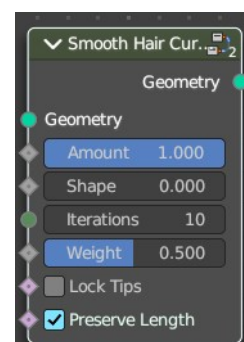

Amount

Amount of smoothing.

Shape

Shape of the influence along curves. 0 means constant. 0.5 means linear.

Iterations

Amount of smoothing steps.

Weight

Smoothing weight.

Lock Tip

Lock the position of tip points.

Preserve Length

Preserve the length of each curve during deformation.

Output

Geometry

The output geometry.

Straighten Hair Curves

Straighten hair curves between root and tip.

Input

Geometry

The input geometry.

Amount

Amount of smoothing.

Shape

Shape of the influence along curves. 0 means constant. 0.5 means linear.

Preserve Length

Preserve the length of each curve during deformation.

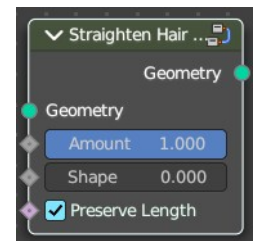

Output

Geometry

The output geometry.

Trim Hair Curves

Trims or scales hair curves to a certain length.

Input

Geometry

The input geometry.

Scale Uniform

Scale each curve uniformly to reach the target length.

Length Factor

Multiply the original length by a factor

Replace Length

Use the length input to fully replace the original length.

Length

Target length for the operation.

Mask

Mask to blend overall effect.

Random Offset

Trim hair curves randomly up to a certain amount.

Pin at parameter

Pin each curve at a certain point for the operation.

Seed

Random seed for the operation.

Output

Geometry

The output geometry.

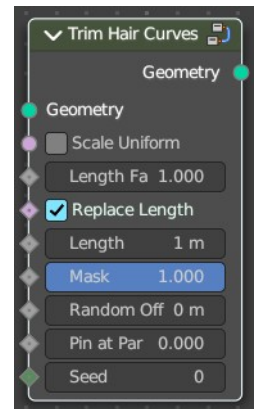

12.1.45 Editors - Geometry Nodes Editor - Header - Add Menu - Hair - Generation

Table of content

Detailed table of content.....	1
Add menu - Hair - Generation.....	2
Duplicate Hair Curves.....	3
Generate Hair Curves.....	4
Interpolate Hair Curves.....	5

Detailed table of content

Table of content

Detailed table of content.....	1
Add menu - Hair - Generation.....	2
Duplicate Hair Curves.....	3
Input.....	3
Geometry.....	3
Amount.....	3
Viewport Amount.....	3
Radius.....	3
Distribution Shape.....	3
Tip Roundness.....	3
Even Thickness.....	3
Seed.....	3
Output.....	3
Geometry.....	3
Guide Index.....	3
Generate Hair Curves.....	4
Input.....	4
Surface.....	4
Surface Object.....	4
Surface UV map.....	4
Surface Rest Position.....	4
Hair Length.....	4
Hair Material.....	4
Control Points.....	4
Poisson Disk Distribution.....	4
Density.....	4
Density Mask.....	4
Mask Texture.....	4
Viewport Amount.....	4
Seed.....	4
Output.....	5
Geometry.....	5
Curves.....	5
Surface Normal.....	5

Interpolate Hair Curves.....	5
Input.....	5
Guide Curves.....	5
Surface Geometry.....	5
Surface Object.....	5
Surface UV map.....	5
Surface Rest Position.....	5
Follow Surface Normal.....	5
Part by Mesh Islands.....	5
Interpolation Guides.....	5
Distance to Guides.....	5
Poisson Disk Distribution.....	6
Density.....	6
Density Mask.....	6
Mask Texture.....	6
Viewport Amount.....	6
Seed.....	6
Output.....	6
Geometry.....	6
Guide Index.....	6
Surface Normal.....	6

Add menu - Hair - Generation

Hair nodes are Node Groups found in the Essentials Library included with Bforartists. They differ from the other nodes in the add menu due to being mid level node groups instead of individual low level nodes.

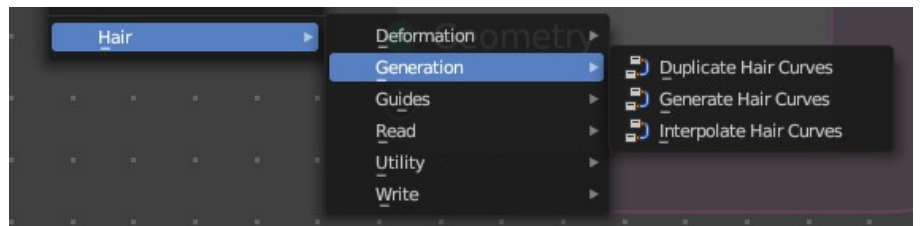

You can enter the node tree by clicking at the icon up right. Tab to leave the node tree. And you can of course also edit the node tree.

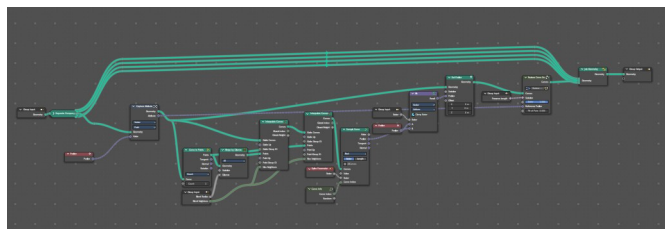
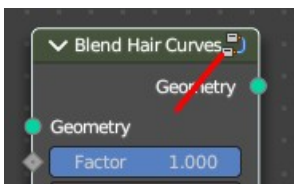

Duplicate Hair Curves

Duplicates hair curves a certain amount of times in the given radius.

Input

Geometry

The input geometry.

Amount

Amount of duplication per curve.

Viewport Amount

How much percent is used in the viewport.

Radius

The radius in which the duplicate curves are offset from the guides.

Distribution Shape

Shape of distribution from center to the edge around the guide.

Tip Roundness

Offset of the curves to round the tip.

Even Thickness

Keep an even thickness of the distribution of duplicates.

Seed

Random seed for the operation.

Output

Geometry

The output geometry.

Guide Index

The guide index map that was used for the operation.

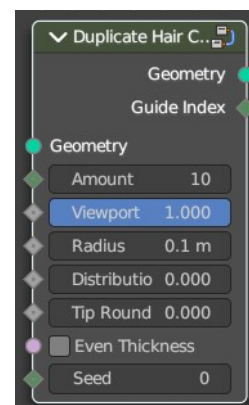

Generate Hair Curves

Generates new hair curves on a surface mesh.

Input

Surface

The surface to generate the hairs on.

Surface Object

A surface object to generate the hairs on.

Surface UV map

Surface UV map used for attachment.

Surface Rest Position

Set the surface mesh into its rest position before attachment.

Hair Length

Length of the generated hair curves.

Hair Material

The material for the hair curves.

Control Points

Amount of control points for the generated hair curves.

Poisson Disk Distribution

Use Poisson Disk distribution to keep a minimum distance between the hair curves.

Density

How dense the generated hair curves are.

Density Mask

Factor for the density of generated hair curves.

Mask Texture

Discard points based on a mask texture after distribution. This mask can be loaded here.

Viewport Amount

How dense the generated hair curves are displayed in the viewport.

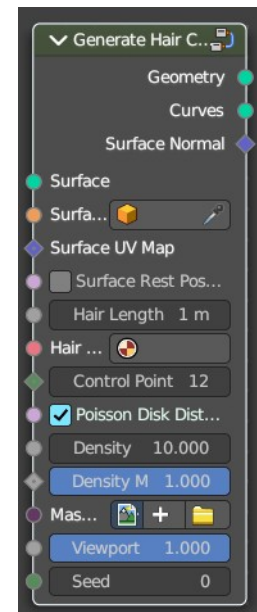

Seed

Random seed for operation.

Output

Geometry

The output geometry.

Curves

The output curves.

Surface Normal

The surface normals.

Interpolate Hair Curves

Interpolates existing guide curves on a surface.

Input

Guide Curves

Input guide curves.

Surface Geometry

The surface geometry to generate the hairs on.

Surface Object

A surface object to generate the hairs on.

Surface UV map

Surface UV map used for attachment.

Surface Rest Position

Set the surface mesh into its rest position before attachment.

Follow Surface Normal

Align the interpolated curves to the surface normal.

Part by Mesh Islands

Use mesh islands of the surface geometry for painting.

Interpolation Guides

Amount of guides to be used for interpolation per curve.

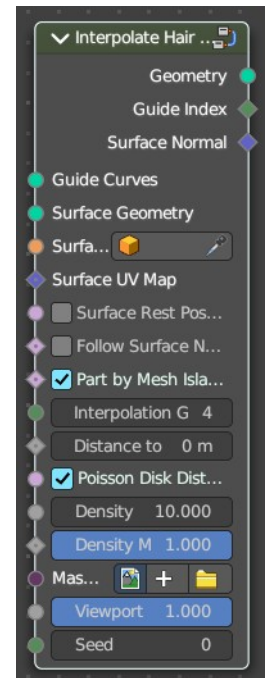

Distance to Guides

Distance around each guide to spawn interpolated curves.

Poisson Disk Distribution

Use Poisson Disk distribution to keep a minimum distance between the hair curves.

Density

How dense the generated hair curves are.

Density Mask

Factor for the density of generated hair curves.

Mask Texture

Discard points based on a mask texture after distribution. This mask can be loaded here.

Viewport Amount

How dense the generated hair curves are displayed in the viewport.

Seed

Random seed for operation.

Output

Geometry

The output geometry.

Guide Index

The output curves.

Surface Normal

The surface normals.

12.1.46 Editors - Geometry Nodes Editor - Header - Add Menu - Hair - Guides

Table of content

Detailed table of content.....	1
Add menu - Hair - Guides.....	3
Braid Hair Curves.....	3
Clump Hair Curves.....	5
Create Guide Index Map.....	6
Curl Hair Curves.....	7

Detailed table of content

Detailed table of content

Detailed table of content.....	1
Add menu - Hair - Guides.....	3
Braid Hair Curves.....	3
Input.....	3
Geometry.....	3
Guide Index.....	3
Guide Distance.....	3
Guide Mask.....	3
Existing Guide Map.....	3
Factor.....	3
Subdivision.....	4
Braid Start.....	4
Radius.....	4
Shape.....	4
Factor Min.....	4
Factor Max.....	4
Frequency.....	4
Thickness.....	4
Thickness Shape.....	4
Shape Assymetry.....	4
Flare Length.....	4
Flare Opening.....	4
Hair Tie Object.....	4
Hair Tie.....	4
Hair Tie Scale.....	5
Output.....	5
Geometry.....	5
Guide Index.....	5
Flare Parameter.....	5
Strand Index.....	5
Clump Hair Curves.....	5
Input.....	5
Geometry.....	5

Guide Index.....	5
Guide Distance.....	5
Guide Mask.....	5
Existing Guide Map.....	5
Factor.....	5
Shape.....	5
Tip Spread.....	6
Clump Offset.....	6
Distance Falloff.....	6
Distance Threshold.....	6
Preserve Length.....	6
Output.....	6
Geometry.....	6
Guide Index.....	6
Create Guide Index Map.....	6
Input.....	6
Geometry.....	6
Guides.....	6
Guide Distance.....	6
Guide Mask.....	6
Group ID.....	6
Output.....	7
Geometry.....	7
Guide Curves.....	7
Guide Index.....	7
Guide Selection.....	7
Curl Hair Curves.....	7
Input.....	7
Geometry.....	7
Guide Index.....	7
Guide Distance.....	7
Guide Mask.....	7
Existing Guide Map.....	7
Factor.....	7
Subdivision.....	7
Curl start.....	8
Radius.....	8
Factor Start.....	8
Factor End.....	8
Frequency.....	8
Random Offset.....	8
Seed.....	8
Output.....	8
Geometry.....	8

Add menu - Hair - Guides

Hair nodes are Node Groups found in the Essentials Library included with Bforartists. They differ from the other nodes in the add menu due to being mid level node groups instead of individual low level nodes.

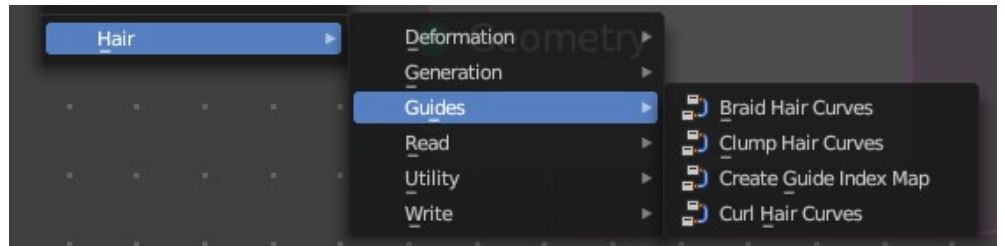

You can enter the node tree by clicking at the icon up right. Tab to leave the node tree. And you can of course also edit the node tree.

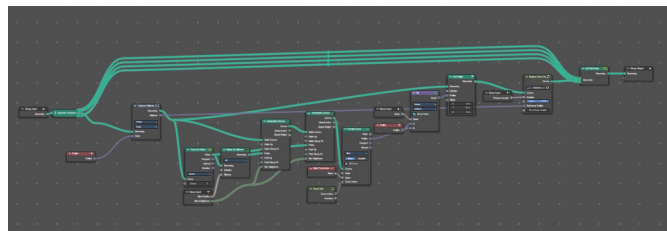
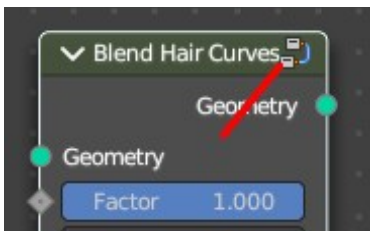

Braid Hair Curves

Deforms existing hair curves into braids.

Input

Geometry

The input geometry.

Guide Index

Index map input. This input has priority.

Guide Distance

Minimum distance between two guides for new guide map.

Guide Mask

Mash for which curve are eligible to be selected as guides.

Existing Guide Map

Use the existing guide map attribute if available

Factor

Factor to blend overall effect.

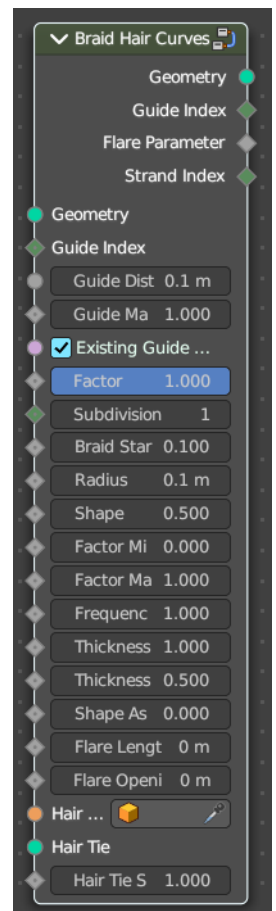

Subdivision

Subdivision level applied before deformation.

Braid Start

Where to start to blend deformation in percent from the root.

Radius

Overall radius of the braids.

Shape

Shape of the braid radius along each curve.

Factor Min

Minimum radius of the braid.

Factor Max

Maximum radius of the braid.

Frequency

Frequency factor of the braids.

Thickness

Thickness of the braids.

Thickness Shape

Shape adjustment of the strand thickness for the braids.

Shape Assymetry

Asymetry of the shape adjustment of the strand thickness.

Flare Length

Length of the flare at the end of the braid.

Flare Opening

Opening radius of the flare at the tip of the braid.

Hair Tie Object

Object used for the hair tie instance.

Hair Tie

Geometry used for the hair tie instance. This has priority.

Hair Tie Scale

Scale of the hair tie instance.

Output

Geometry

The output geometry.

Guide Index

The guide index map that was used for the operation.

Flare Parameter

Parameter between 0 and 1 along the flare.

Strand Index

Index of the strand within a braid that each curve belongs to.

Clump Hair Curves

Clumps together existing hair curves.

Input

Geometry

The input geometry.

Guide Index

Index map input. This input has priority.

Guide Distance

Minimum distance between two guides for new guide map.

Guide Mask

Mash for which curve are eligible to be selected as guides.

Existing Guide Map

Use the existing guide map attribute if available.

Factor

Factor to blend overall effect.

Shape

Shape of the influence along curves. 0 means constant. 0.5 means linear.

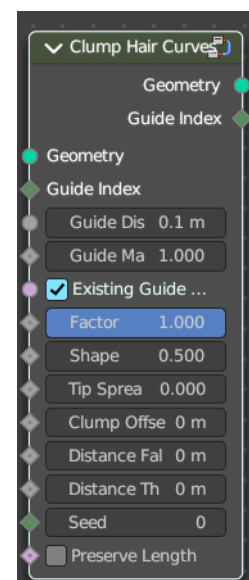

Tip Spread

Distance of random spread at the curve tips

Clump Offset

Offset of clump in a random direction.

Distance Falloff

Falloff distance for the clumping effect. 0 means no falloff.

Distance Threshold

Distance threshold for the clumping effect. 0 means no falloff.

Preserve Length

Preserve the length of each curve during deformation.

Output

Geometry

The output geometry.

Guide Index

The guide index map that was used for the operation.

Create Guide Index Map

Creates an attribute that maps each curve to its nearest guide via index.

Input

Geometry

The input geometry.

Guides

Index map input. This input has priority.

Guide Distance

Minimum distance between two guides for new guide map.

Guide Mask

Mask for which curve are eligible to be selected as guides.

Group ID

The id that is used to group curves together for guide map creation.

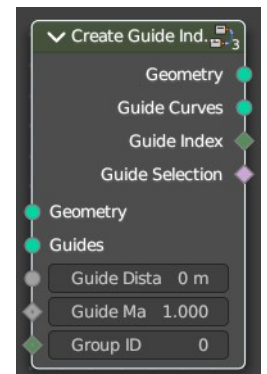

Output

Geometry

The output geometry.

Guide Curves

The output guides

Guide Index

The guide index map that was used for the operation.

Guide Selection

The output guide selection.

Curl Hair Curves

Deform existing hair curves into curls.

Input

Geometry

The input geometry.

Guide Index

Index map input. This input has priority.

Guide Distance

Minimum distance between two guides for new guide map.

Guide Mask

Mash for which curve are eligible to be selected as guides.

Existing Guide Map

Use the existing guide map attribute if available.

Factor

Factor to blend overall effect.

Subdivision

Subdivision level applied before deformation.

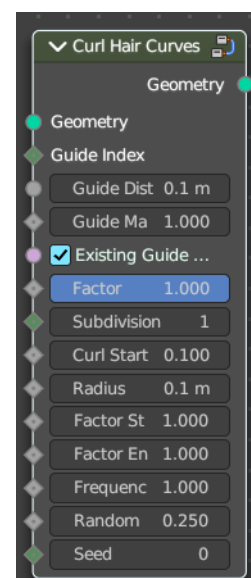

Curl start

Radius

Factor Start

Form where to blend deformation in percent, starting from the root.

Factor End

Factor for the radius at the curl end.

Frequency

Frequency factor of the curls.

Random Offset

Amount of random offset per curve.

Seed

Random seed for the operation.

Output

Geometry

The output geometry.

12.1.47 Editors - Geometry Nodes Editor - Header - Add Menu - Hair - Read

Table of content

Detailed table of content.....	1
Add menu - Hair - Read.....	2
Curve Info.....	2
Curve Root.....	3
Curve Segment.....	3
Curve Tip.....	3
Hair Attachment Info.....	4

Detailed table of content

Table of content

Detailed table of content.....	1
Add menu - Hair - Read.....	2
Curve Info.....	2
Output.....	2
Curve Index.....	2
Curve ID.....	2
Length.....	2
Direction.....	2
Random.....	2
Surface UV.....	2
Curve Root.....	3
Output.....	3
Root Selection.....	3
Root Position.....	3
Root Direction.....	3
Root Index.....	3
Curve Segment.....	3
Output.....	3
Segment Length.....	3
Segment Direction.....	3
Neighbor Index.....	3
Curve Tip.....	3
Output.....	3
Tip Selection.....	3
Tip Position.....	3
Tip Direction.....	4
Tip Index.....	4
Hair Attachment Info.....	4
Input.....	4
Surface Geometry.....	4
Surface UV Map.....	4
Output.....	4

Attachment UV.....4
 Attachment is Valid.....4
 Surface Normal.....4

Add menu - Hair - Read

Hair nodes are Node Groups found in the Essentials Library included with Bforartists. They differ from the other nodes in the add menu due to being mid level node groups instead of individual low level nodes.

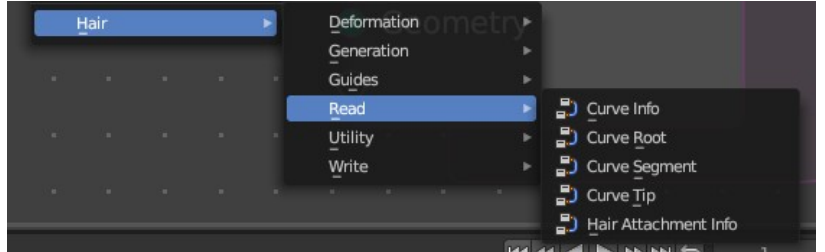

You can enter the node tree by clicking at the icon up right. Tab to leave the node tree. And you can of course also edit the node tree.

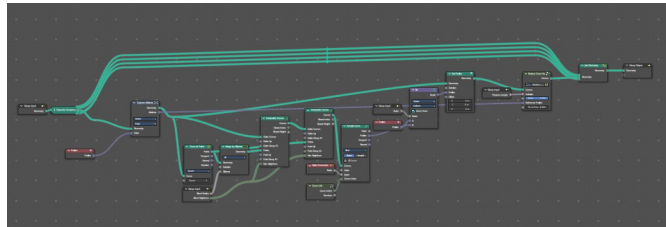
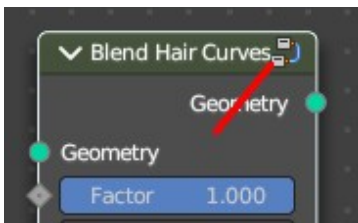

Curve Info

Reads information about each curve.

Output

Curve Index

Index of each curve.

Curve ID

ID of each curve.

Length

Length of each curve.

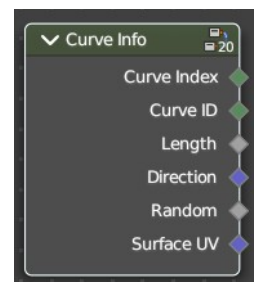

Direction

Direction of each curve.

Random

Random Vector of each curve.

Surface UV

Attachment surface UV coordinate of each curve.

Curve Root

Reads information about the root point of each curve.

Output

Root Selection

Boolean selection of curve root points.

Root Position

The position of a root point of a curve.

Root Direction

Direction of the root segment of a curve.

Root Index

Index of the root point of a curve.

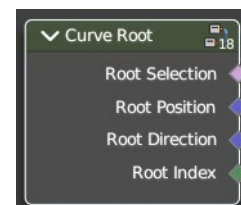

Curve Segment

Reads the information of the curve segment before the current point.

Output

Segment Length

Length of the segment

Segment Direction

Direction of the segment

Neighbor Index

Index of the neighbouring point on segment.

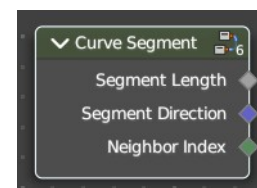

Curve Tip

Reads information about the tip point of each curve.

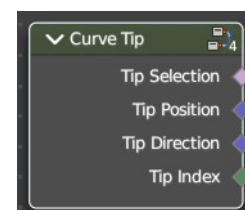

Output

Tip Selection

Boolean selection of the tip points.

Tip Position

Position of the tip point of a curve.

Tip Direction

Direction of the segment of the tip point of a curve.

Tip Index

Index of the tip point of a curve.

Hair Attachment Info

Reads attachment information regarding a surface mesh.

Input

Surface Geometry

Surface geometry of the curve attachment.

Surface UV Map

Surface UV map used for attachment.

Output

Attachment UV

Surface attachment UV coordinate stored on each curve.

Attachment is Valid

Is the attached UV coordinate valid?

Surface Normal

The normal direction of the surface mesh at the attachment point.

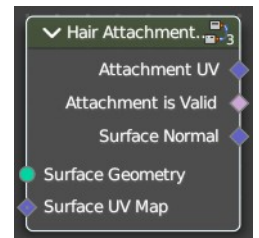

12.1.48 Editors - Geometry Nodes Editor - Header - Add Menu - Hair - Utility

Table of content

Detailed table of content.....	1
Add menu - Hair - Utility.....	2
Attach Hair Curves to Surface.....	2
Redistribute Curve Points.....	3
Restore Curve Segment Length.....	4

Detailed table of content

Detailed table of content

Detailed table of content.....	1
Add menu - Hair - Utility.....	2
Attach Hair Curves to Surface.....	2
Input.....	2
Geometry.....	2
Surface Object.....	2
Surface.....	2
Surface UV Map.....	2
Surface Rest Position.....	2
Sample Attachment UV.....	2
Snap to Surface.....	3
Align to Surface Normal.....	3
Blend along Curve.....	3
Output.....	3
Geometry.....	3
Surface UV Coordinate.....	3
Surface Normal.....	3
Redistribute Curve Points.....	3
Input.....	3
Curves.....	3
Factor.....	3
Feature Awareness.....	3
Output.....	3
Curves.....	3
Restore Curve Segment Length.....	4
Input.....	4
Curves.....	4
Selection.....	4
Factor.....	4
Reference Position.....	4
Pin at Parameter.....	4
Output.....	4
Curves.....	4

Add menu - Hair - Utility

Hair nodes are Node Groups found in the Essentials Library included with Bforartists. They differ from the other nodes in the add menu due to being mid level node groups instead of individual low level nodes.

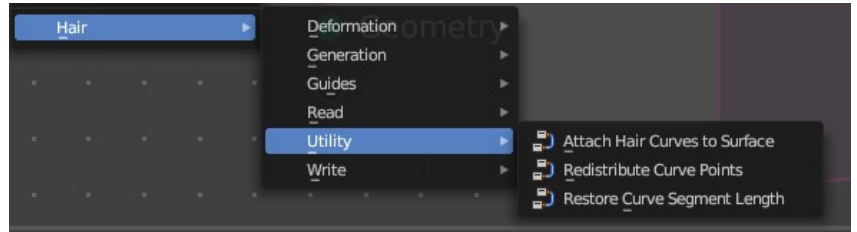

You can enter the node tree by clicking at the icon up right. Tab to leave the node tree. And you can of course also edit the node tree.

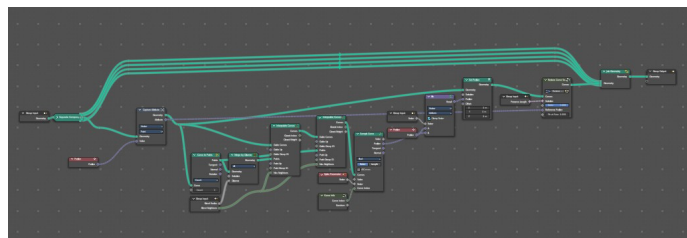
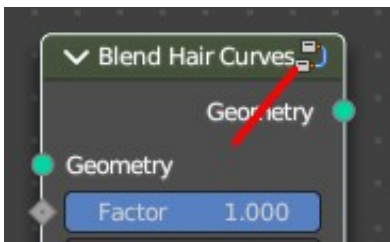

Attach Hair Curves to Surface

Attaches hair curves to a surface mesh.

Input

Geometry

The input geometry.

Surface Object

A surface object to attach to. It needs to have matching transforms.

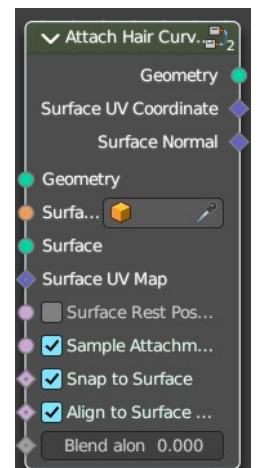

Surface

Surface geometry to attach hair curves to.

Surface UV Map

Surface UV Map used to attach hairs to.

Surface Rest Position

Set the surface into rest position before attachment.

Sample Attachment UV

Sample the surface UV mapp at the attachment point.

Snap to Surface

Snap the root of the curve to the closest surface point.

Align to Surface Normal

Align the curves to surface normals. Needs a guide as reference.

Blend along Curve

Blend deformation along each curve from the root.

Output

Geometry

The output geometry.

Surface UV Coordinate

Surface UV Coordinate at the attachment point.

Surface Normal

Surface Normal at the attachment point.

Redistribute Curve Points

Redistributes existing control points evenly along each curve.

Input

Curves

The input curve.

Factor

Factor to blend overall effect.

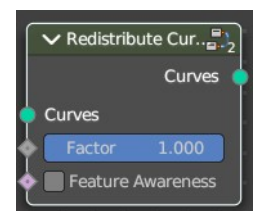

Feature Awareness

Use simple feature awareness to keep feature definition.

Output

Curves

The output curves.

Restore Curve Segment Length

Input

Curves

The input curve.

Selection

A selection of the input curve.

Factor

Factor to blend overall effect.

Reference Position

Reference position before deformation.

Pin at Parameter

Pin each curve at a certain point for the operation.

Output

Curves

The output curves.

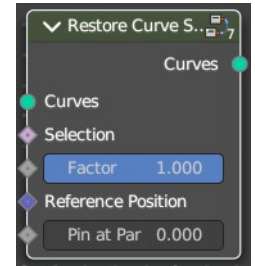

12.1.49 Editors - Geometry Nodes Editor - Header - Add Menu - Hair - Write

Table of content

Detailed table of content.....	1
Add menu - Hair - Utility.....	1
Set Hair Curve Profile.....	2

Detailed table of content

Detailed table of content

Detailed table of content.....	1
Add menu - Hair - Utility.....	1
Set Hair Curve Profile.....	2
Input.....	2
Geometry.....	2
Replace Radius.....	2
Radius.....	2
Shape.....	2
Factor Min.....	2
Factor Max.....	2
Output.....	2
Geometry.....	2

Add menu - Hair - Utility

Hair nodes are Node Groups found in the Essentials Library included with Bforartists. They differ from the other nodes in the add menu due to being mid level node groups instead of individual low level nodes.

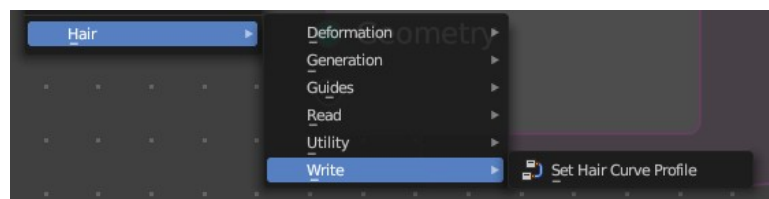

You can enter the node tree by clicking at the icon up right. Tab to leave the node tree. And you can of course also edit the node tree.

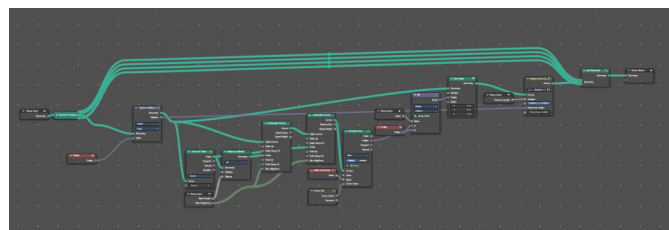
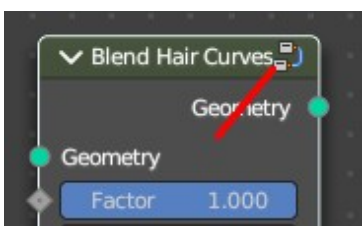

Set Hair Curve Profile

Set the radius attribute of hair curves according to a profile shape.

Input

Geometry

The input geometry.

Replace Radius

Replace the original radius.

Radius

Base radius to be set when replace radius is enabled.

Shape

Shape of the radius along the curve.

Factor Min

Factor of the radius at the minimum.

Factor Max

Factor of the radius at the maximum.

Output

Geometry

The output geometry.

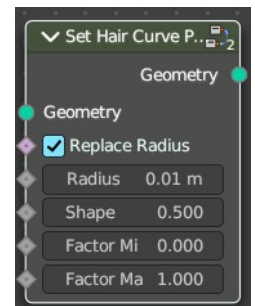



12.1.5 Editors - Geometry Node Editor - Header - Add Menu

Table of content

Add menu.....	1
Add menu – Search.....	1
Add menu – Appending Node-groups.....	2
Add menu – Searching for Node-Groups.....	2

Add menu

Here you will find all the nodes that you need to create your geometry node trees. A click at one of the items will create the node in the workspace at the mouse position right under the menu. It is already selected, and you can drag it around.

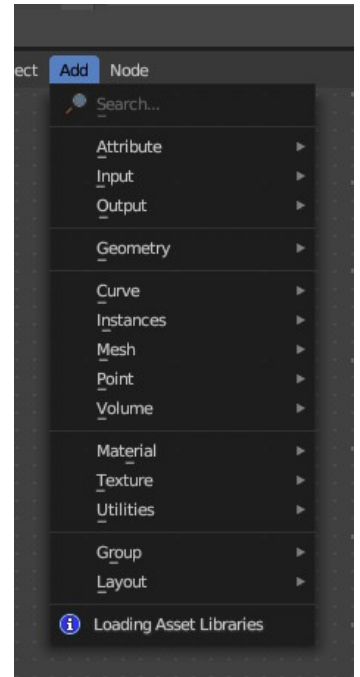

Add menu – Search

This is a search menu where you can search for specific node types in all categories.

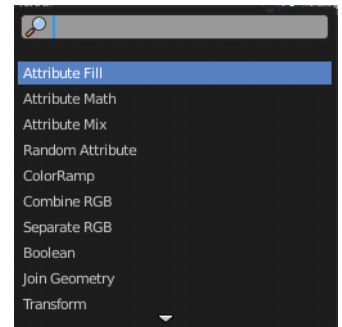

Add menu – Appending Node-groups

The add menu also dynamically loads and adds any and all node-groups listed in collective asset libraries. These are appended as new sub-menus based on the category label.

Loading these assets may take some time on first use.

All Geometry Nodes node-groups registered in the Asset Browser are listed at the end of this menu.

Note: Once a node-group from an asset library has been appended to the scene, they will list as a node-group datablock and can be accessed from the Relations tab in the Node Editor Property Shelf.

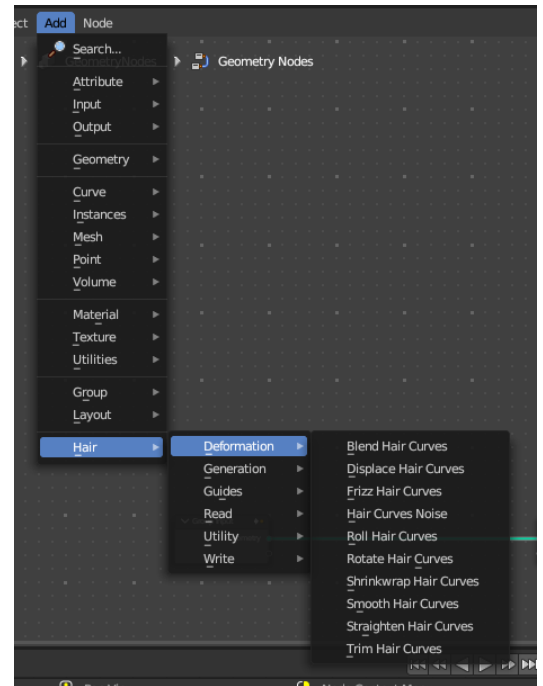

Add menu – Searching for Node-Groups

Alternatively, you can search for node-groups in the asset libraries using the search dialogue. They will also be listed in the search results.

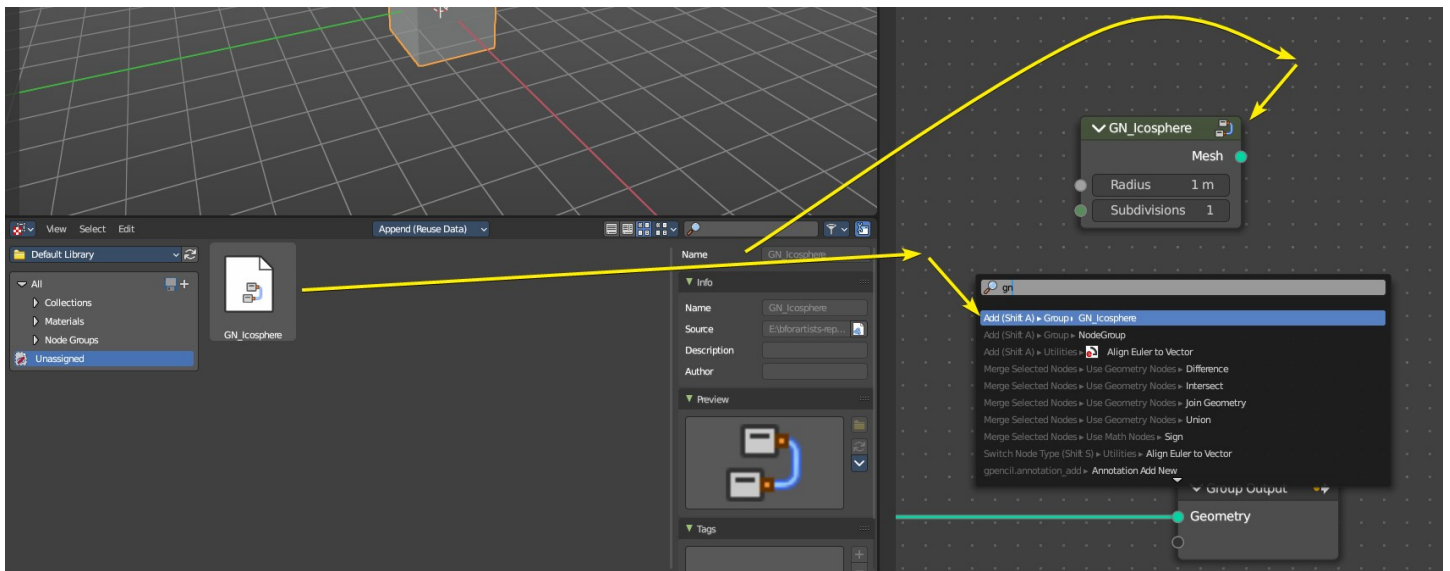



12.1.50 Editors - Geometry Nodes Editor - Header - Node menu

Table of content

Node menu.....	2
Move.....	2
Rotate.....	2
Resize.....	2
Copy.....	2
Paste.....	2
Duplicate Keep Input.....	2
Duplicate.....	2
Delete.....	2
Delete with Reconnect.....	2
Join new Frame.....	3
Remove from Frame.....	3
Frame Make Parent.....	3
Rename.....	3
Links.....	3
Make Links.....	3
Make and Replace Links.....	3
Cut Links.....	3
Detach Links.....	3
Detach Links Move.....	3
Mute Links.....	3
Separate.....	3
Copy.....	4
Move.....	4
Hide / Toggle.....	4
Hide.....	4
Toggle Node Mute.....	4
Toggle Node Preview.....	4
Toggle hidden node sockets.....	4
Toggle Node Options.....	4
Collapse and Hide Unused Sockets.....	4

Node menu

This menu contains further node functionality.

Move

Moves the selected nodes.

Rotate

You can't rotate single nodes, obviously. But when you have more than one selected then you can rotate them around their center point.

Resize

You can't resize single nodes, obviously. But when you have more than one selected then you can scale them around their center point.

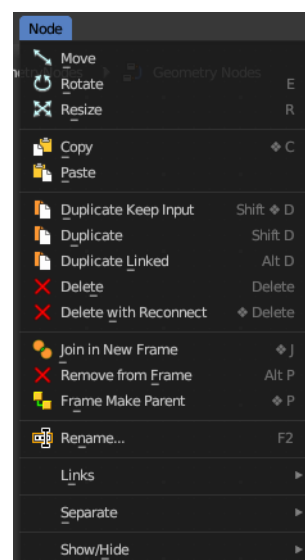

Copy

Copies the selected node(s).

Paste

Pastes the selected node(s).

Duplicate Keep Input

This works at nodes that have a connected input. Duplicating will keep the input connections established in the duplicated node. The output connections will be removed.

Duplicate

Duplicates the selected node(s). All connections will be removed in the duplicated node.

Delete

Deletes the selected node(s).

Delete with Reconnect

Deletes the selected node(s). When this node is in the middle of a connection, then the connections will be reconnected.

Join new Frame

Frame node functionality. Adds the selected node to a frame.

Remove from Frame

Frame node functionality. Removes the selected node from a frame.

Frame Make Parent

Frame node functionality. Adds the selected node to a frame.

Rename

Allows you to rename the selected node. A popup dialog will appear where you can change the name of the node. Press enter to make it real.



Links

Make Links

Tries to connect nodes where it makes sense.

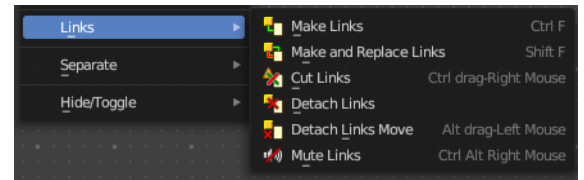

Make and Replace Links

Same as Make Links. But it will replace existing links.

Cut Links

Mouse only tool. Cut links by moving with the mouse over the connection

Detach Links

Removes all connections from the selected node, but tries to reconnect the remaining nodes.

Detach Links Move

Removes all connections from the selected node by dragging.

Mute Links

Allows you to mute links instead of disconnecting it by painting over the link connection. To unmute, use the tool again. Hotkey only tool. Please use the hotkey.

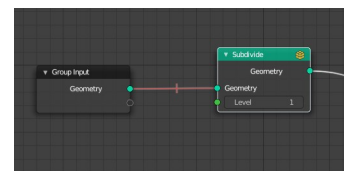

Separate

Node group functionality. You need to be in edit group mode.



Copy

Copies the selected node, and pastes a copy of it outside of the node group. The node group remains unchanged.

Move

Moves the selected to outside of the node group, and removes it from the node group.

Hide / Toggle

Here you find hide options to make the display of nodes more compact.

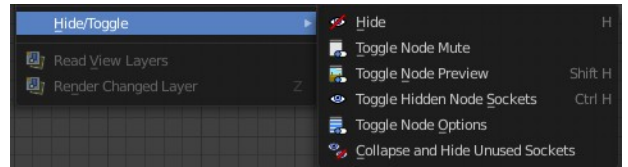

Demonstration happens at an image node.

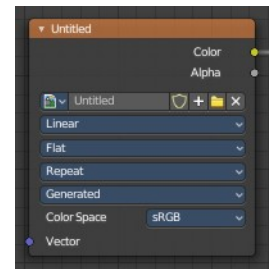

Hide

Hides everything but input and output dots. To view the full node again perform the operator again. It's a toggle. Or click at the triangle left besides the node name.



Toggle Node Mute

Deactivates the node.

Toggle Node Preview

This is a compositor feature for the preview image. It does not belong here, but shares the same menu. It shows or hides the preview image.

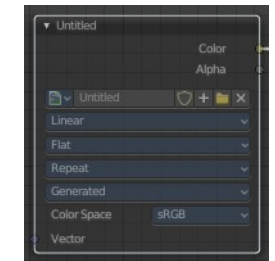

Toggle hidden node sockets

Toggles away the unused node sockets. In this case the vector input node socket and the alpha output node socket will be hidden.

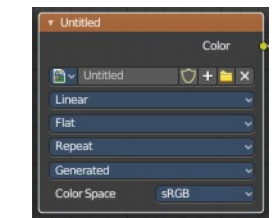

Toggle Node Options

Hides away the properties.

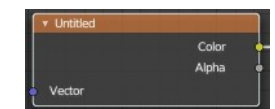

Collapse and Hide Unused Sockets

Like Hide. Hides everything but the node sockets. But it also hides the unused node

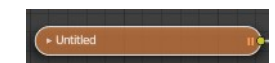

sockets.



12.1.6 Editors - Geometry Node Editor - Header - Add Menu - Attribute

Table of content

- Detailed table of content.....1
- Add menu.....3
 - Attribute Statistics.....3
 - Blur Attribute.....4
 - Capture Attribute.....5
 - Domain Size.....6
 - Remove Named Attribute.....7
 - Store Named Attribute.....7

Detailed table of content

Detailed table of content

- Detailed table of content.....1
- Add menu.....3
 - Attribute Statistics.....3
 - Inputs.....3
 - Geometry.....3
 - Selection.....3
 - Attribute.....3
 - Properties.....3
 - Domain Type.....3
 - Outputs.....3
 - Mean.....3
 - Median.....4
 - Sum.....4
 - Min.....4
 - Max.....4
 - Range.....4
 - Standard Derivation.....4
 - Variance.....4
- Blur Attribute.....4
 - Inputs.....4
 - Value.....4
 - Iterations.....4
 - Properties.....5
 - Outputs.....5
 - Value.....5
- Capture Attribute.....5
 - Inputs.....5
 - Geometry.....5
 - Value.....5
 - Properties.....5
 - Domain Type.....5
 - Outputs.....6

Geometry.....	6
Attribute.....	6
Domain Size.....	6
Input.....	6
Geometry.....	6
Properties.....	6
Component.....	6
Output.....	6
With type mesh.....	6
Point Count.....	6
Edge Count.....	6
Face Count.....	6
Face Corner Count.....	6
With type Point Cloud.....	7
Point Count.....	7
With type Curve.....	7
Point Count.....	7
Spline Count.....	7
With type Instances.....	7
Instances count.....	7
Remove Named Attribute.....	7
Input.....	7
Geometry.....	7
Name.....	7
Outputs.....	7
Geometry.....	7
Store Named Attribute.....	7
Input.....	7
Geometry.....	7
Selection.....	7
Name.....	8
Value.....	8
Properties.....	8
Data Type.....	8
Domain.....	8
Outputs.....	8
Geometry.....	8

Add menu

The Attribute menu contains the attribute nodes. These nodes allows you to work with object attributes.

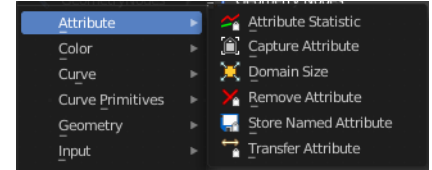

Attribute Statistics

Retrieve statistic values from the input mesh.

Inputs

Geometry

Standard geometry input.

Selection

A selection of the geometry input.

Attribute

Attribute to get the statistics from.

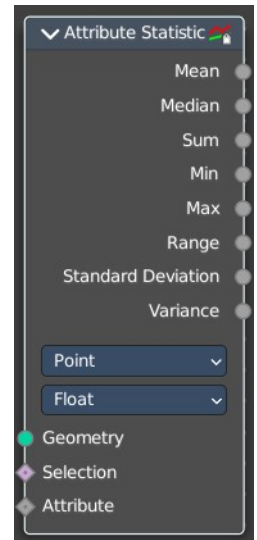

Properties

Domain Type

From which domain to retrieve the data.

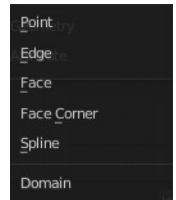

Data Type

What data type to use.

Float will output a single floating point value.

Vector will output a vector 3 with floating point values.

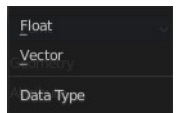

Outputs

Outputs the statistics for the different types.

Mean

The average value of all data.

Median

The median value of all data.

Sum

The sum value of all data.

Min

The min value of all data.

Max

The max value of all data.

Range

The difference between the max and min value.

Standard Derivation

How much values differ from the mean. A low standard deviation indicates that the values are grouped tightly together at the mean. A high standard deviation indicates that the values are spread out over a large range.

Variance

The variance of all data, defined as the square of the standard deviation.

Blur Attribute

The Blur Attribute mixes values of neighbour elements.

Inputs

Value

Name of the attribute that is used as input. It should be a float attribute with values between zero and one.

Iterations

How many times to blur the values for all elements.

Weight

Relative mix weight of neighbouring elements.

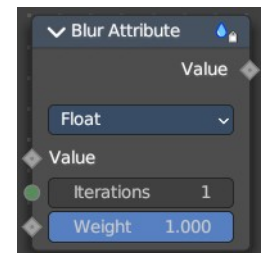

Properties

Data Type

What data type to use.

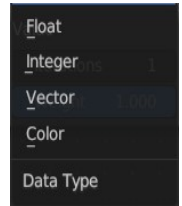

Outputs

Value

The output value.

Capture Attribute

The Capture Attribute node stores the result of a field on a geometry, and outputs the data as a node socket so it can be used by other nodes.

The result is stored on the geometry just like a regular attribute with a name. But instead of referencing it with a name, it is retrieved whenever the socket is connected to the input of a node. Later on when evaluating the node tree, the attribute will be removed automatically if it is no longer used.

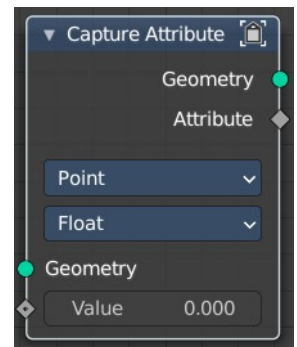

Inputs

Geometry

Standard geometry input.

Value

Name of the attribute that is used as input. It should be a float attribute with values between zero and one.

Properties

Domain Type

In which domain to store the data.

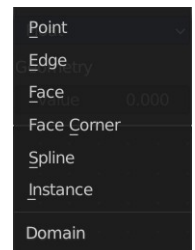

Data Type

What data type to use.

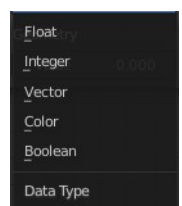

Outputs

Geometry

Standard geometry output.

Attribute

Attribute output.

Domain Size

The Domain Size node has a single geometry input and a selection for the component type. And outputs containing single values for the related domains are shown, based on this chosen component.

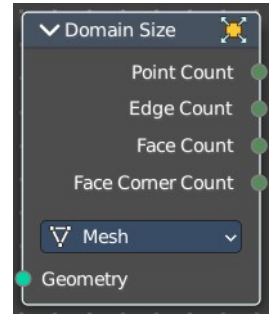

Input

Geometry

Geometry input.

Properties

Component

What component to calculate.

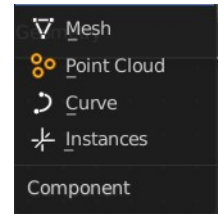

Output

With type mesh

Point Count

The point count of the mesh.

Edge Count

The edge count of the mesh.

Face Count

The face count of the mesh.

Face Corner Count

The face corner count of the mesh.

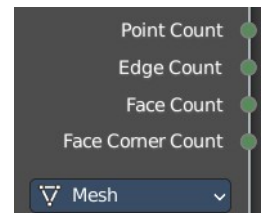

With type Point Cloud

Point Count

The point count of the point cloud.

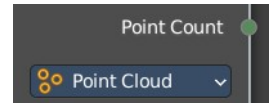

With type Curve

Point Count

The point count of the curve.

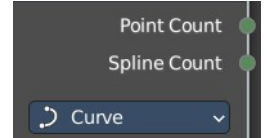

Spline Count

The number of splines in the curve.

With type Instances

Instances count

How many instances the input geometry has.

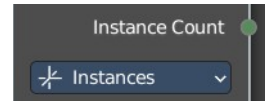

Remove Named Attribute

Input

Geometry

Geometry input.

Name

The attribute name that you want to remove.

Outputs

Geometry

The output geometry.

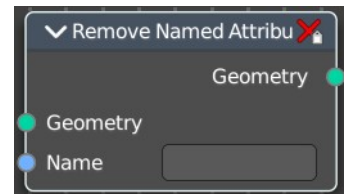

Store Named Attribute

Puts the results of a field in a named attribute.

Input

Geometry

Geometry input.

Selection

Selection input.

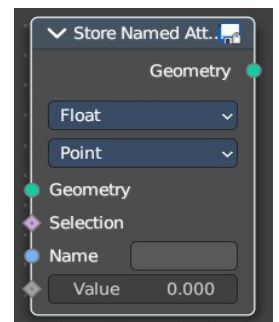

Name

The attribute name that you want to store.

Value

The value that is connected with the stored attribute.

Properties

Data Type

The type for the source and result data.

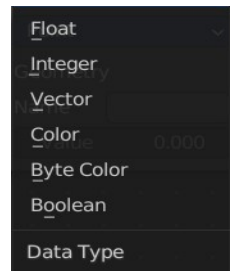

Domain

What element to use.

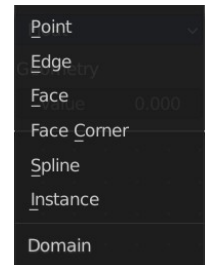

Outputs

Geometry

The output geometry.

12.1.12 Editors - Geometry Nodes Editor - Header - Add Menu - Input - Constant

Table of content

Detailed table of content.....	1
Add menu - Input - Constant.....	2
Boolean.....	2
Color.....	3
Image.....	3
Integer.....	4
Material.....	4
String.....	5
Value.....	5
Vector.....	5

Detailed table of content

Detailed table of content

Detailed table of content.....	1
Add menu - Input - Constant.....	2
Boolean.....	2
Properties.....	2
Value.....	2
Outputs.....	2
Boolean.....	2
Color.....	3
Outputs.....	3
Color.....	3
Image.....	3
Properties.....	3
Image.....	3
New.....	3
Open.....	3
Image prop.....	3
Image browser.....	3
Image name.....	3
Fake user.....	4
New.....	4
Open Image.....	4
Remove.....	4
Frame.....	4
Outputs.....	4
Image.....	4
Integer.....	4
Properties.....	4
Value.....	4
Outputs.....	4
Integer.....	4

Material.....	4
Outputs.....	4
Material.....	4
String.....	5
Properties.....	5
String.....	5
Outputs.....	5
Value.....	5
Value.....	5
Properties.....	5
Value.....	5
Outputs.....	5
Value.....	5
Vector.....	5
X Y Z.....	5
Output.....	5
Vector.....	5

Add menu - Input - Constant

Here you find input nodes.

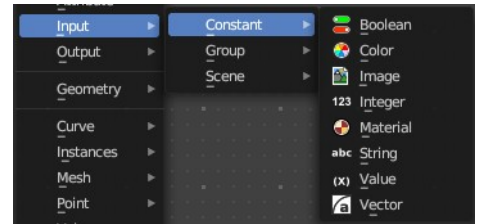

Boolean

Inputs a boolean value.

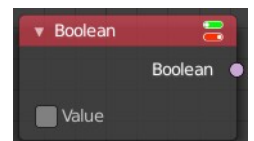

Properties

Value

The input boolean.

Outputs

Boolean

The boolean state.

Color

Define a input color.

This node is a color wheel.

Clicking at the color field at the bottom will reveal the standard Blender color dialog, where you can input numeric values.



Outputs

Color

Standard color output.

Image

Add a input image.

Properties

Image

Load or connect a image.

New

Create a new image.

Opens a new image dialog where you can adjust the color, size and further settings.

Open

Open a existing image.

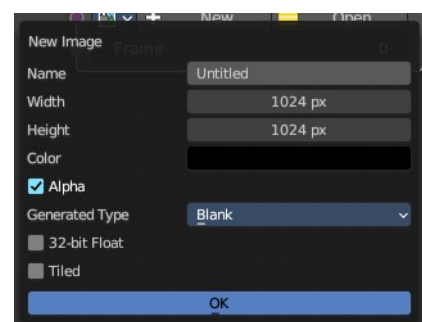
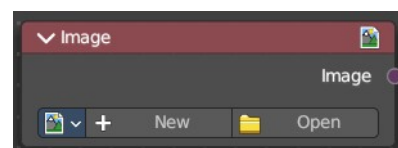

Image prop

Image browser

A list of available images

Image name

The name of the image

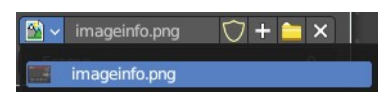

Fake user

Add a fake user to this asset.

New

Create a new image.

Opens a new image dialog where you can adjust the color, size and further settings.

Open Image

Open an existing image.

Remove

Removes the image as the active image.

Frame

For videos. Which frame to use.

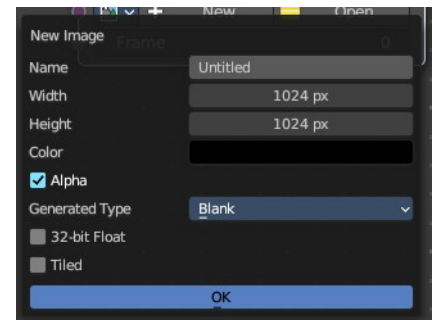

Outputs

Image

The output image.

Integer

Inputs an integer value.

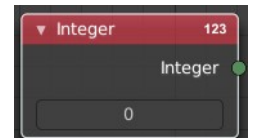

Properties

Value

The input integer.

Outputs

Integer

The integer value.

Material

Retrieve a material.

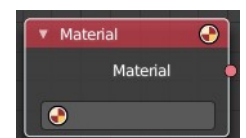

Outputs

Material

The material output.

String

Input a string.

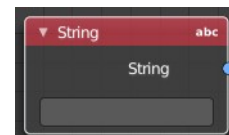

Properties

String

The string that you want to input.

Outputs

Value

The value set in the node properties.

Value

Input numerical values to other nodes in the tree.

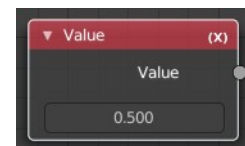

Properties

Value

Single numerical value (floating point).

Outputs

Value

The value set in the node properties.

Vector

Creates a single vector of three values that can be used as an input.

Properties

X Y Z

The values of the vector.



Output

Vector

Standard vector output.

12.1.9 Editors - Geometry Nodes Editor - Header - Add Menu - Input - Scene

Table of content

Detailed table of content.....	1
Add menu - Input - Scene.....	2
Collection Info.....	2
Image Info.....	3
Is Viewport.....	4
Object Info.....	5
Self Object.....	5
Scene time.....	5

Detailed table of content

Detailed table of content

Detailed table of content.....	1
Add menu - Input - Scene.....	2
Collection Info.....	2
Inputs.....	2
Collection.....	2
Properties.....	3
Transform Space.....	3
Original.....	3
Relative.....	3
Outputs.....	3
Geometry.....	3
Image Info.....	3
Input.....	3
Image.....	3
New.....	3
Open.....	3
Image prop.....	3
Image browser.....	3
Image name.....	3
Fake user.....	4
New.....	4
Open Image.....	4
Remove.....	4
Frame.....	4
Outputs.....	4
Width.....	4
Height.....	4
Has Alpha.....	4
Frame Count.....	4
FPS.....	4
Is Viewport.....	4
Outputs.....	4

Is Viewport.....	4
Object Info.....	5
Inputs.....	5
Object.....	5
Outputs.....	5
Location.....	5
Rotation.....	5
Scale.....	5
Geometry.....	5
Self Object.....	5
Scene time.....	5
Outputs.....	5
Seconds.....	5
Frame.....	5

Add menu - Input - Scene

Here you find input nodes.

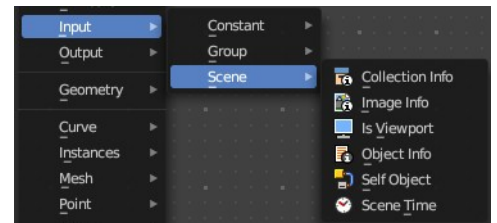

Collection Info

The Collection Info node retrieves information from collections. This can be useful to use an external collection to control parameters in the geometry node tree.

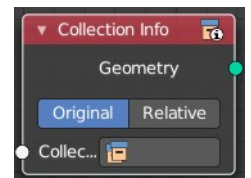

Inputs

Collection

Collection to get the properties from.

Properties

Transform Space

The transformation of the geometry outputs.

Original

Output the geometry relative to the collection offset.

Relative

Bring the input collection geometry into the modified object, maintaining the relative position between the objects in the scene.

Outputs

Geometry

Geometry of the collection in world space with all its modifiers applied.

Image Info

Retrieve infos from an image.

Input

Image

Load or connect a image.

New

Create a new image.

Opens a new image dialog where you can adjust the color, size and further settings.

Open

Open a existing image.

Image prop

Image browser

A list of available images

Image name

The name of the image

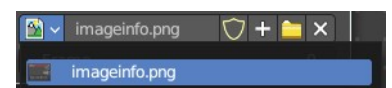
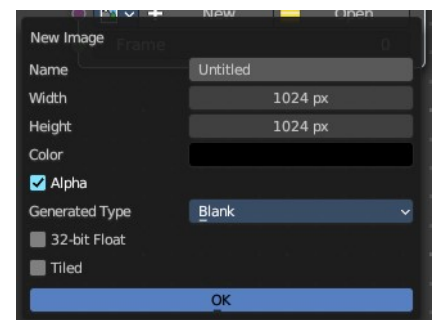
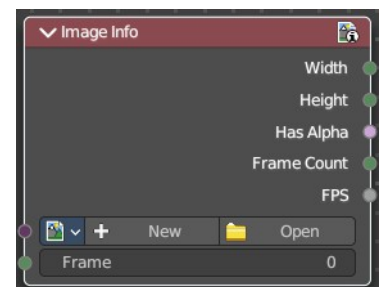

Fake user

Add a fake user to this asset.

New

Create a new image.

Opens a new image dialog where you can adjust the color, size and further settings.

Open Image

Open an existing image.

Remove

Removes the image as the active image.

Frame

For videos. Which frame to use.

Outputs

Width

The width of the image.

Height

The height of the image

Has Alpha

Returns true if the image has an alpha channel

Frame Count

For movies. How many frames.

FPS

For movies, what FPS rate.

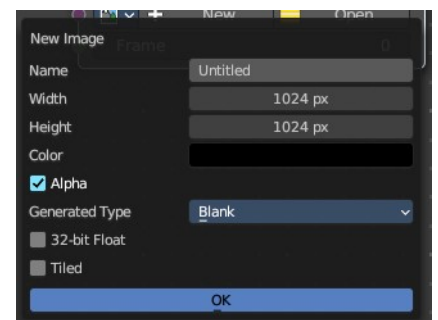

Is Viewport

The Is Viewport node outputs true when geometry nodes is evaluated for the viewport. For the final render the node outputs false.

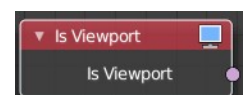

Outputs

Is Viewport

A boolean that indicates if the geometry nodes is evaluated for preview.

Object Info

The Object Info node retrieves information from objects. And outputs it then.

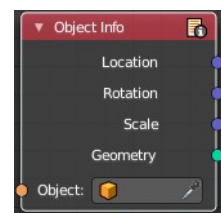

Inputs

Object

Object to get the properties from.

Outputs

Location

Location of the object in world space.

Rotation

Rotation of the object in world space.

Scale

Scale of the object in world space.

Geometry

Geometry of the object in world space with all its modifiers applied.

Self Object

Retrieves the parent object of the geometry nodes.

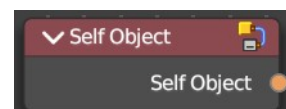

Scene time

Outputs the current scene time in seconds or in frames.

The Frame output is a float value to make subframe rendering for motion blur possible.



Outputs

Seconds

Output in seconds.

Frame

Output in Frames.



12.2 Editors - Geometry Nodes Editor - Tool Shelf

Table of content

Tool Shelf.....	2
Select Tools Group.....	2
Tweak.....	2
Select Box.....	2
Tool Settings.....	2
Mode.....	2
Set a new selection.....	2
Extend existing selection.....	2
Subtract existing selection.....	2
Select Circle.....	2
Tool Settings.....	3
Mode.....	3
Set a new selection.....	3
Extend existing selection.....	3
Subtract existing selection.....	3
Radius.....	3
Select Lasso.....	3
Tool Settings.....	3
Mode.....	3
Set a new selection.....	3
Extend existing selection.....	3
Subtract existing selection.....	3
Annotate Tools group.....	3
Annotate.....	4
Tool Settings.....	4
Color.....	4
Stabilize Stroke.....	4
Radius.....	4
Factor.....	4
Annotate Line.....	4
Tool Settings.....	4
Color.....	4
Style Start.....	4
End.....	5
Annotate Polygon.....	5
Tool Settings.....	5
Color.....	5
Annotate Eraser.....	5
Tool Settings.....	5
Radius.....	5
Links Cut.....	5

Tool Shelf



Select Tools Group

Tools with a triangle down right are a group of tools. Click and hold to reveal the content. Then choose the tool that you need.

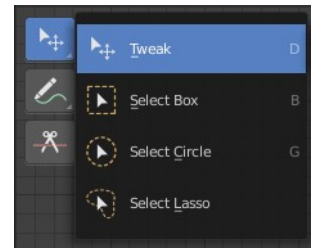

Tweak

Allows you to select or tweak single elements by clicking at it.

Select Box

Draws a box to select several elements at once. Click at the start point, then drag.

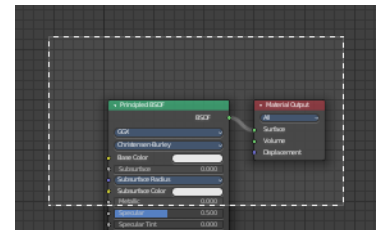

Tool Settings

Mode

The available selection modes. The mode titles are pretty self explaining. So i won't go into detail here.

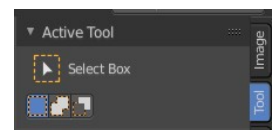

Set a new selection

Extend existing selection

Subtract existing selection

Select Circle

Draws a box to select several elements at once. Click at the start point, then drag.

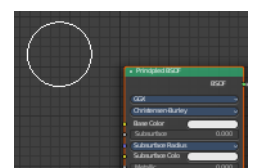

Tool Settings

Mode

The available selection modes. The mode titles are pretty self explaining. So i won't go into detail here.



Set a new selection

Extend existing selection

Subtract existing selection

Radius

The brush radius.

Select Lasso

Draws a box to select several elements at once. Click at the start point, then drag.

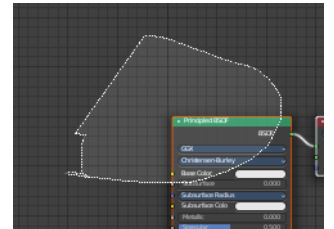

Tool Settings

Mode

The available selection modes. The mode titles are pretty self explaining. So i won't go into detail here.

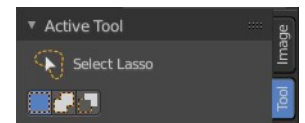

Set a new selection

Extend existing selection

Subtract existing selection

Annotate Tools group

The annotation tool is available in multiple editors. With this tool you can write notes at the screen. The annotate tools is the little brother of the grease pencil objects.

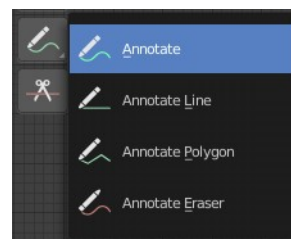

Further settings for annotate can be found in the sidebar.

Here you can also remove an annotation when you don't longer need it. And here you can also adjust the size of the stroke.

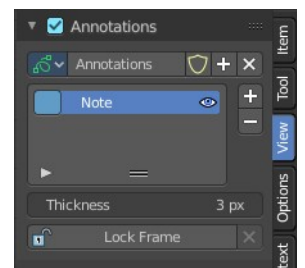

Annotate

Draw free-hand strokes in the main window.

Tool Settings

The tool settings for Annotate.

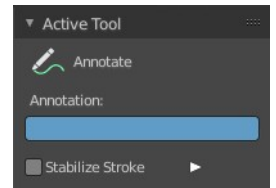

Color

Clicking at the left color field reveals a color picker. Define the color for the annotation stroke.



Stabilize Stroke

Helper to draw smooth and clean lines. Pressing shift inverts the effect.

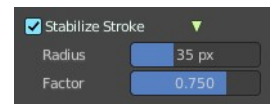

Radius

The radius for the stroke stabilization.

Factor

Stabilizer stroke factor. Higher values gives a smoother stroke.

Annotate Line

Click and drag to create a line.

Tool Settings

The tool settings for the Annotate tool.

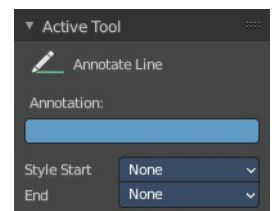

Color

Clicking at the left color field reveals a color picker. Define the color for the annotation stroke.



Style Start

The stroke start style. With an arrow for example you place an arrow at the start of the stroke.

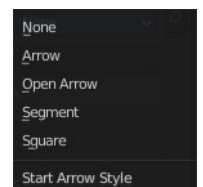

End

The stroke end style. With an arrow for example you place an arrow at the end of the stroke.

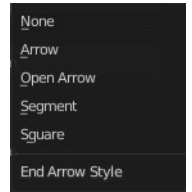

Annotate Polygon

Click multiple times to create multiple connected lines. The current polygon is finished when Esc or RMB is pressed.

Tool Settings

The tool settings for Annotate.

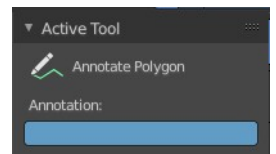

Color

Clicking at the left color field reveals a color picker where you can define the color for the annotation stroke.



Annotate Eraser

Click and drag to remove annotate lines.



Tool Settings

Radius

The radius of the eraser pencil.

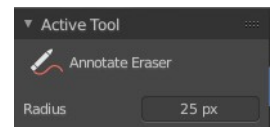

Links Cut

This tools allows you to cut connections.

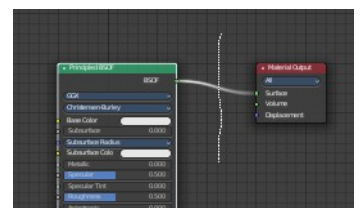



12.3 Editors - Geometry Node Editor - Sidebar

Table of content

Introduction..... 1
Right Click menus..... 1

Introduction

The Geometry Node Editor is made of several areas. At the right side you will find the sidebar. Here you will find further options and settings for the Geometry Node Editor nodes and its tools.

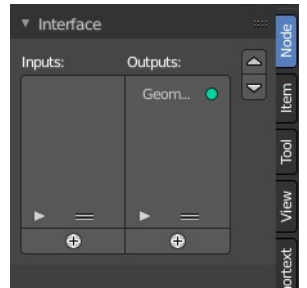

Right Click menus

You will open the usual right click menus when clicking with the right mouse at elements in the sidebar. Its content is in big parts self explaining.

The right click menus are explained in the chapter 6 Editors Introduction.

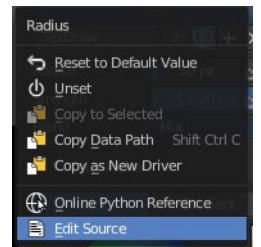



12.3.1 Editors - Geometry Nodes Editor - Sidebar - Node tab

Table of content

- Node panel.....1
- Name.....1
- Label.....1
- Color Subpanel.....1
- Presets.....1
- Node color specials.....1
- Copy Color.....1
- Properties panel.....1

Node panel

Name

The name of the selected node. Read only.

Despite being read only, this text can be edited. But be careful, it will not change the name in the header of the node. And it does not snap back to the original name of the node when you remove the custom text.

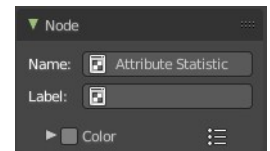

Label

Allows you to define a custom name for the selected node. This text does change the name in the header of the node.

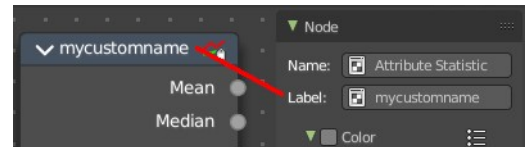

Color Subpanel

Define a custom color for the node. A click at the color field opens a color picker.

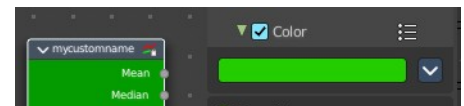

Presets

Add color presets.

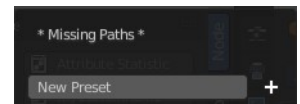

Node color specials

Copy Color

Copies the color. Which doesn't help you since you cannot paste it.

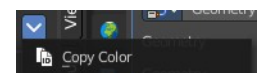

Properties panel

Lists the properties of the node in editable form. And the inputs in

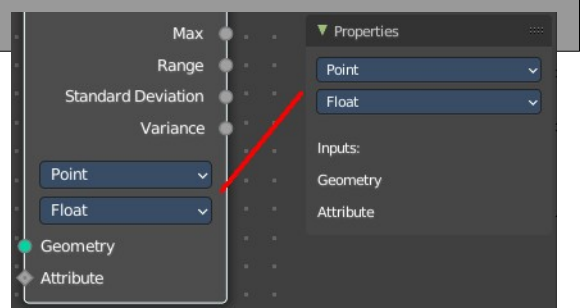

text form.



12.3.2 Editors - Geometry Nodes Editor - Sidebar - Node Tab

Table of content

- Node Tab - Node Panel.....1
- Name.....1
- Label.....1
- Color sub menu.....1
- Color checkbox.....1
- Presets.....1
- Color.....1
- Node color specials.....2
- Copy Color.....2
- Node Tab - Properties Panel.....2

Node Tab - Node Panel

In this panel you can give nodes and node groups a name and a label, and change its color.

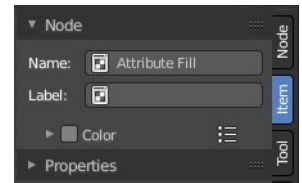

Name

The type of the node.

Label

The label name of the node.

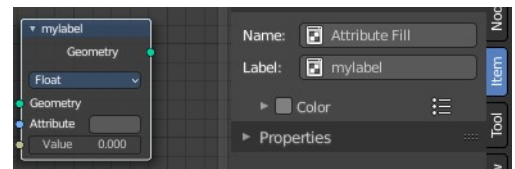

Color sub menu

Color checkbox

The Color checkbox turns custom color on or off.

Presets

Store some color presets and reuse them. They are stored globally, and transfers to other blend files.

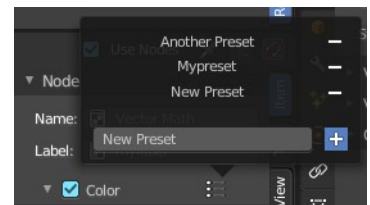

Color

Choose a custom color. A click at the color field will open a color picker.

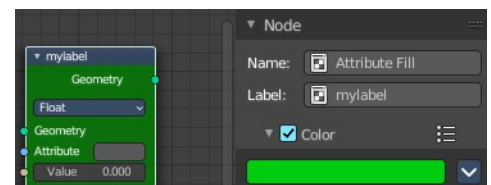

Node color specials

Copy Color

Allows you to copy the color.

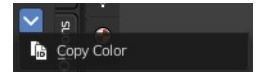

Node Tab - Properties Panel

This panel shows usually the same properties than the properties at the node. These properties are already explained in the Add menu chapters. So we won't repeat them here.

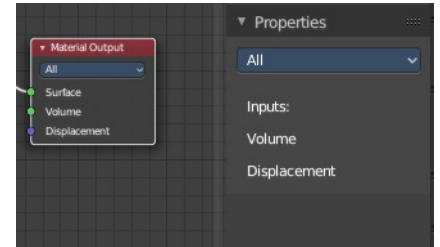



12.3.3 Editors - Geometry Nodes Editor - Sidebar - Tool Tab

Table of content

Tool Tab.....1

Tool Tab

Contains the settings of the currently active tool in the tool shelf.

In the node editor we don't have something special here. The tool related settings are explained in the tool shelf chapter.

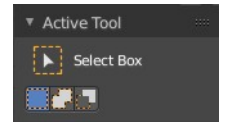



12.3.4 Editors - Geometry Nodes Editor- Sidebar - View Tab

Table of content

View Tab - Annotation Panel.....	1
Annotations prop.....	1
Drop down box.....	1
Edit Box.....	1
Fake User.....	1
Add Annotation.....	2
Delete Annotation.....	2
List of Annotation Strokes.....	2
Thickness.....	2
Frame Locked/Unlocked.....	2
Onion Skin.....	2

View Tab - Annotation Panel

View related settings. Which is in the node editor just the Annotations panel where you can manage the Annotation layers and materials.

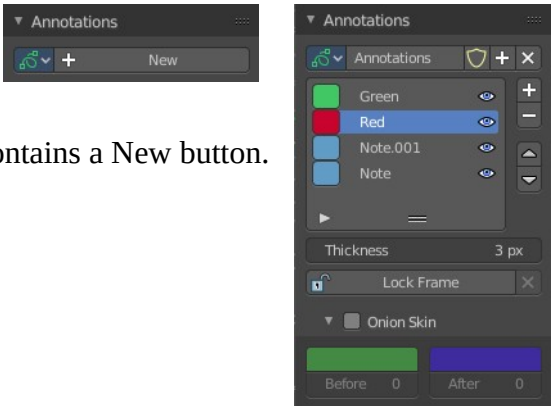

When you don't have drawn an annotation yet then the panel just contains a New button.

Annotations prop

Add, remove and rename new annotations.

Drop down box

A list of the available annotation layers.

Edit Box

The name of the current annotation. You can rename the annotation to your needs here.

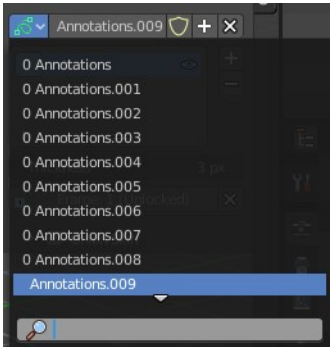

Fake User

Assign a fake user to this annotation. Fake users is an odd concept to keep data in the scene even if it has no user somewhere. The fake user is then a dummy user so that the object is not deleted when saving the scene.

Add Annotation

Add a new annotation.

Delete Annotation

Delete the annotation.

List of Annotation Strokes

Here you see your Annotation layers for the current Annotation. Every layer can have an own color.

At the right side you find buttons to sort them and to add and remove new Annotation layers.

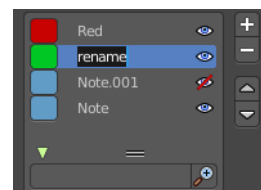

You can change the color by clicking at the color field. A color dialog will pop up. You can rename annotation layers by double clicking at it.

The eye icon allows you to make it invisible And it has a search field.

Thickness

The thickness of the annotation stroke.

Frame Locked/Unlocked

Lock frame displayed by current layer. This toggles whether the active layer is the only one that can be edited.

Onion Skin

Enable Onion Skinning.

Onion Skinning allows to show ghosts of the keyframes before and after the current frame. In this sub panel you can adjust the color of the onion skin frames.



With the numbers below the colors you can define how many frames before or after are displayed that way.



12.3.4 Editors - Geometry Nodes Editor - Sidebar - Group tab

Table of content

Group tab - Input panel.....	2
Inputs.....	2
List.....	2
Drag handler.....	2
Search.....	2
Add / Remove Node Tree Interface Socket.....	2
Sort.....	2
Type.....	2
Subtype.....	3
Name.....	3
Tooltip.....	3
Default Attribute.....	3
Default.....	3
Min.....	3
Max.....	3
Hide Value.....	3
Hide in Modifier.....	3
Group tab - Output panel.....	4
Outputs.....	4
List.....	4
Drag handler.....	4
Search.....	4
Add Node Tree Interface Socket.....	4
Sort.....	4
Type.....	4
Subtype.....	5
Name.....	5
Tooltip.....	5
Attribute Domain.....	5
Default Attribute.....	5
Default.....	5
Min.....	5
Max.....	5
Hide Value.....	5

Group tab - Input panel

Manage the input properties of the Group Input node.

More than one input slot can be useful when you want to modify the geometry in more than one way.

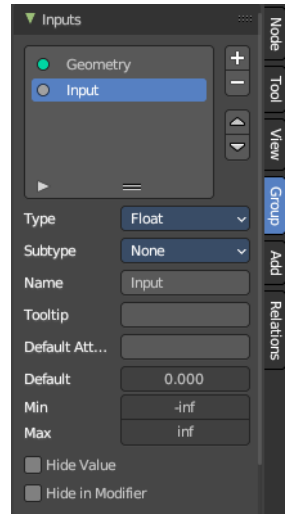

Inputs

List

List of available input or output slots.

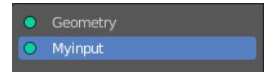

Drag handler

Resize the list.



Search

Opens a search field with its options.

Add / Remove Node Tree Interface Socket

Adds a new input slot to the list. Or removes the selected input slot.



Sort

Move the selected node up or down in the list.



Type

What kind of node output it is.

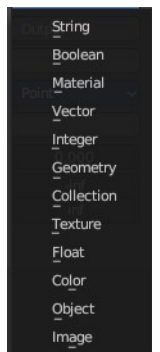

Subtype

Some node types have a subtype dropdown menu. Vector or Float for example. The subtype menu allows you to define the type even more.

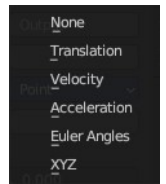

Name

Change the name of the current selected input slot. Type in a new name and hit enter.



Tooltip

Add a tooltip to the output.

Default Attribute

The default attribute name that is used when the node group is used by a geometry nodes modifier.

Default

The default value for the input node.

Min

The minimum value for the input node.

Max

The maximum value for the input node.

Hide Value

Hide the input value even when the socket is not connected.

Hide in Modifier

Don't show the input value in the geometry nodes modifier interface.

Group tab - Output panel

Manage the output properties of the Group Output node.

More than one input slot can be useful when you want to modify the geometry in more than one way.

Outputs

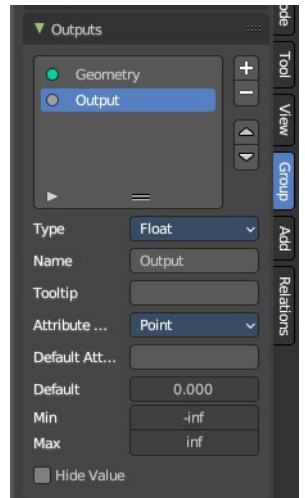

List

List of available input or output slots.

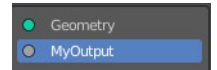

Drag handler

Resize the list.

Search

Opens a search field with its options.



Add Node Tree Interface Socket

Adds a new output slot to the list.



Sort

Move the selected node up or down in the list.



Type

What kind of node output it is.

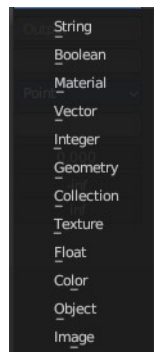

Subtype

Some node types have a subtype dropdown menu. Vector or Float for example. The subtype menu allows you to define the type even more.



Name

Change the name of the current selected input slot. Type in a new name and hit enter.

The X button at the end will remove the selected input slot from the list.



Tooltip

Add a tooltip to the output.

Attribute Domain

Attribute Domain that is used by the geometry nodes modifier to create an attribute output.

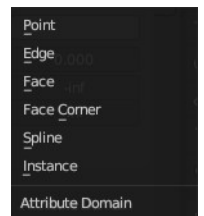

Default Attribute

The default attribute name that is used when the node group is used by a geometry nodes modifier.

Default

The default value for the output node.

Min

The minimum value for the input node.

Max

The maximum value for the output node.

Hide Value

Hide the input value even when the socket is not connected.



12.3.6 Editors - Geometry Nodes Editor - Sidebar - Add

Table of content

Add Tab.....	1
Usage.....	1
Add tab - Display Panel.....	1
Icon Buttons.....	1

Add Tab

Here you can find the same nodes than in the Add menu. Panels are more convenient to use. They stay open for example. It's your decision with what system you want to work.

We won't explain the content of the panels again. The single nodes are explained in the add menu chapter.

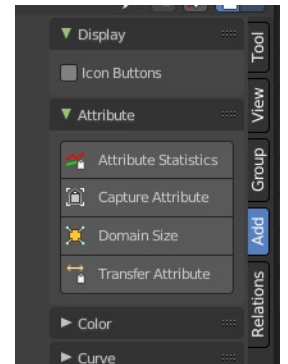
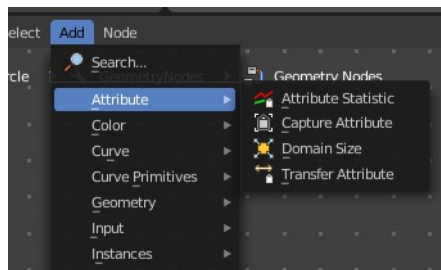

Usage

Click at one of the node buttons, then move the mouse into the viewport. The created node sticks at the mouse. Click again to release it.

Add tab - Display Panel

Icon Buttons

You can display the nodes in the panels either as text buttons or as pure icon buttons.

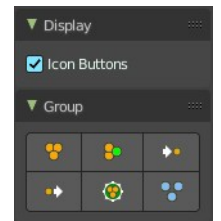

12.3.7 Editors - Geometry Nodes Editor - Sidebar - Relations tab

Table of content

Relations tab - Display Panel.....	1
Icon Buttons.....	1
Relations tab - Group Panel.....	1
Make Group.....	2
Group Insert.....	3
Usage.....	3
Group Input.....	3
Group Output.....	3
Toggle Edit Group.....	3
Ungroup.....	3
Relations tab - Node Group Panel.....	3
Relations tab - Layout Panel.....	3
Frame.....	3
Adding and Removing Nodes.....	4
Resizing Frame.....	4
Label and Color.....	4
Reroute.....	4
Move, Rotate, Scale.....	5

Relations tab - Display Panel

Icon Buttons

You can display the nodes in the panels either as text buttons or as pure icon buttons.

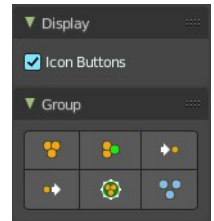

Relations tab - Group Panel

Node groups allows you to group different nodes of the material together to reduce the visual complexity. A node group acts like any other node.

Material node groups should not include Input nodes, like Image nodes, or Output nodes.

If you include a source node in your group, you will end up having the source node appearing twice: once inside the group, and once outside the group in the new material node tree.

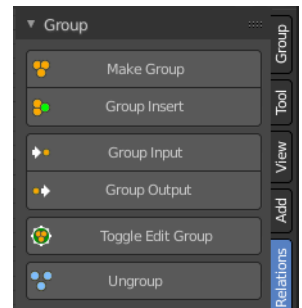

If you include an output node in the group, there will not be an output socket available from the group!

Make Group

Groups the selected nodes together.

Select the nodes that you want to group together. Choose Make Group. You will now see a green background. This indicates that the group is created, and that you are in edit mode for the group now.

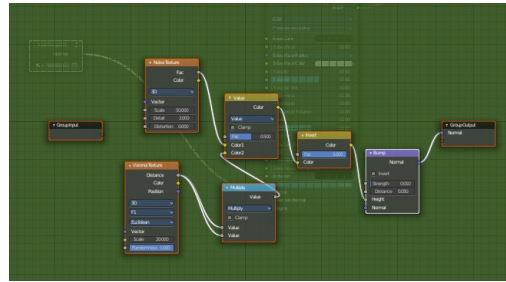
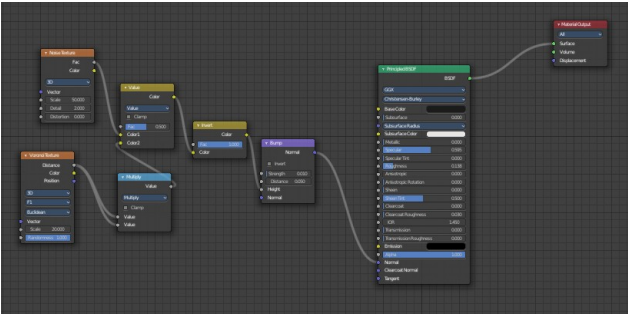

To exit the group edit mode press Tab key, or choose Toggle Edit Group menu item . That way you can also enter the Group Edit mode again.

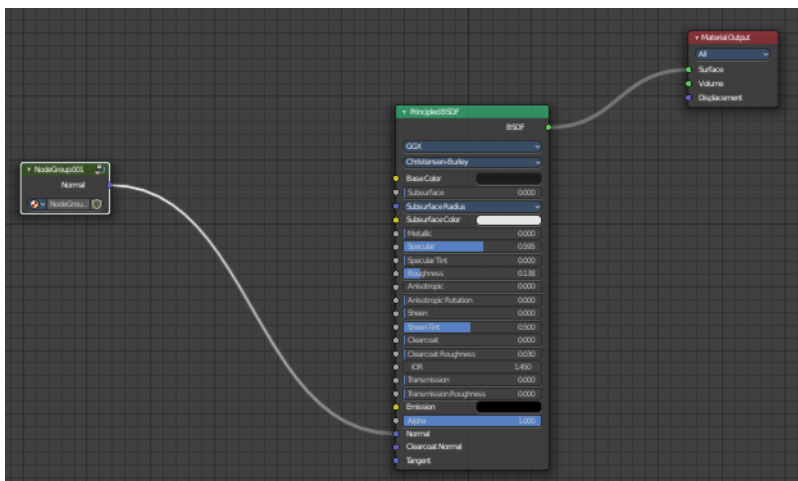

There is a third way to enter the group edit mode. Click at the right upper icon of the group node.

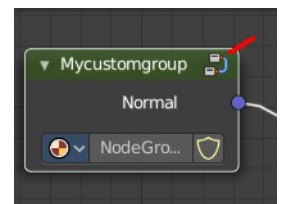

A group can be further collapsed by clicking at the triangle button in the upper left corner.

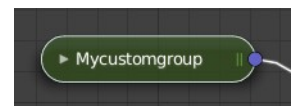

The group can be renamed in the sidebar in the Item tab and in the Properties tab in the Node panel.

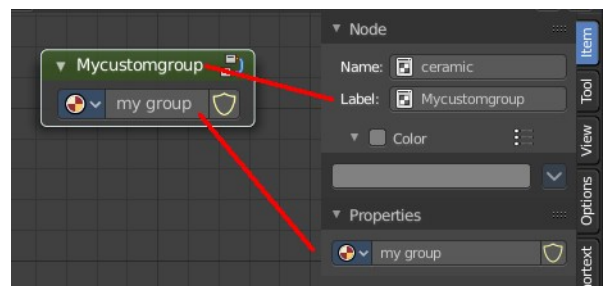

Group Insert

Inserts the selected node into the selected group.

Usage

Select the node.

Hold down shift, and select the group.

Click the Group Insert button. The node will now be part of the group, and you will land in group edit mode.

Press tab to exit the group edit mode.

Group Input

Adds a group input node.

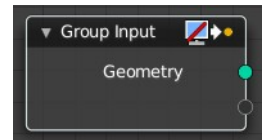

Group Output

Adds a group output node.

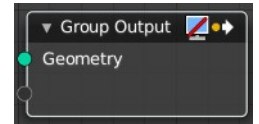

Toggle Edit Group

Enter or exit the edit group mode.

Ungroup

Ungroups an existing group. You need to be outside of the group edit mode.

Relations tab - Node Group Panel

When you create a node group, then this node group is listed here. And can be dragged from there for reuse too.

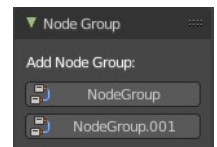

Relations tab - Layout Panel

These nodes help organizing the node layout.

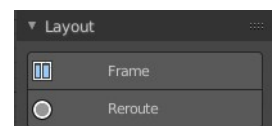

Frame

The Frame node allows you to drop nodes into a frame. This frame can be dragged around as a whole.

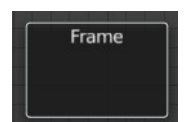

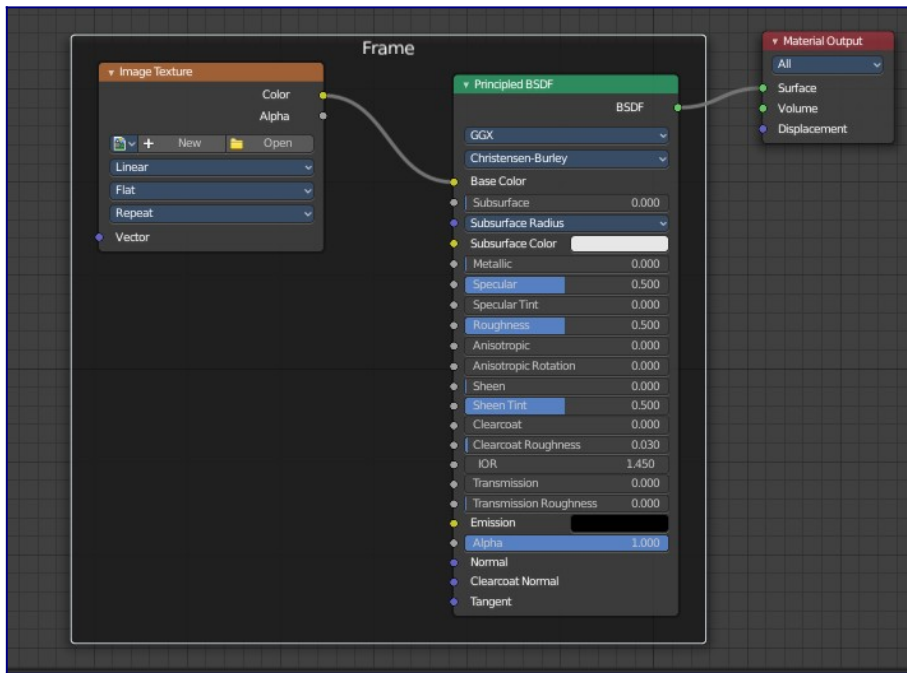

Adding and Removing Nodes

Nodes can be added by simply dropping them onto the frame. Or with the Join in New Frame menu item in the Node menu.

To remove a node from the frame use Remove from Frame.

Resizing Frame

When the Frame node is first placed in the node editor workspace you can resize it by dragging one of the edges.

Once a node is placed in the Frame, the Frame shrinks around the nodes. You cannot resize it anymore with handlers. Just by dragging around the nodes inside of the frame.

This behavior can be changed by disabling the *Shrink* option in the Item tab in the Properties panel. Then you can resize the frame again by dragging the edges.

Label and Color

You can change the name of a frame in the Node panel. And you can give it a custom color by checking the Color checkbox and adjusting the color then.

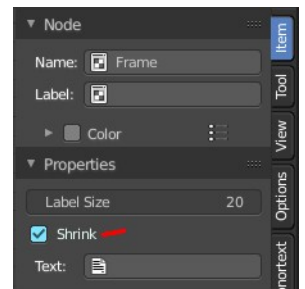
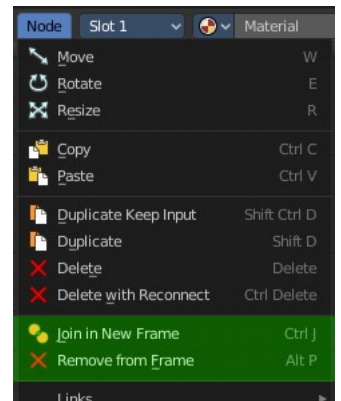

Reroute

Adds a reroute point that can be used to reroute connections. It allows just one input, but allows multiple output connections.

To quickly add a Reroute node into an existing connection, hold Shift and Right Mouse and drag the mouse to

cut through the link. A new reroute node will be added.

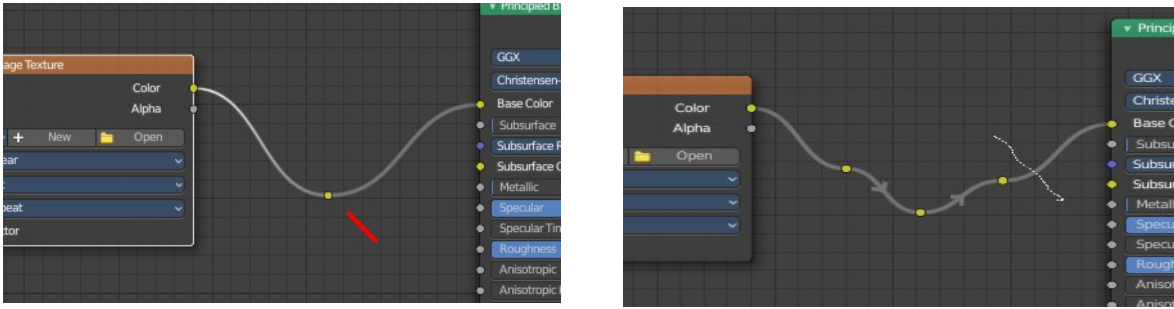

When you exceed a specific angle amount between the reroute nodes, then the node connection becomes a sharp corner, and not longer a Bezier like soft curve.

Move, Rotate, Scale

A normal node has a handler. The reroute dot not. You can't simply move it around with the mouse by clicking at the top area. It has none. You have to use the move, rotate and scale commands. They can be found in the View menu.

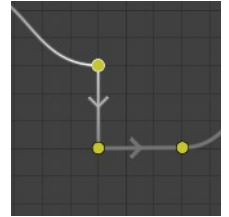
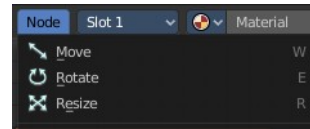



13 Editors - Shader Editor

Table of content

Shader Editor.....	2
Navigating in the Shader Editor viewport.....	2
Hotkeys.....	2
Node context menu.....	3
Add.....	3
Find.....	3
Cut Links.....	3
Mute Links.....	3
Exit Group.....	3
Copy.....	3
Paste.....	3
Duplicate.....	4
Rename.....	4
Delete.....	4
Delete with Reconnect.....	4
Make Links.....	4
Make and Replace Links.....	4
Detach Links.....	4
Make Group.....	4
Insert into Group.....	5
Toggle Edit Group.....	6
Ungroup.....	6
Join new Frame.....	6
Remove from Frame.....	6
Rename.....	6
Select submenu.....	6
Grouped.....	6
Linked From.....	6
Linked To.....	6
Activate same type previous.....	6
Activate same type next.....	6
Show/Hide submenu.....	7
Hide.....	7
Toggle Node Mute.....	7
Toggle hidden node sockets.....	7
Toggle Node Options.....	7
Collapse and Hide Unused Sockets.....	7
Toggle Node Options.....	8
Collapse and Hide Unused Sockets.....	8
Quick Favorites menu.....	8
Slider snapping.....	8

Shader Editor

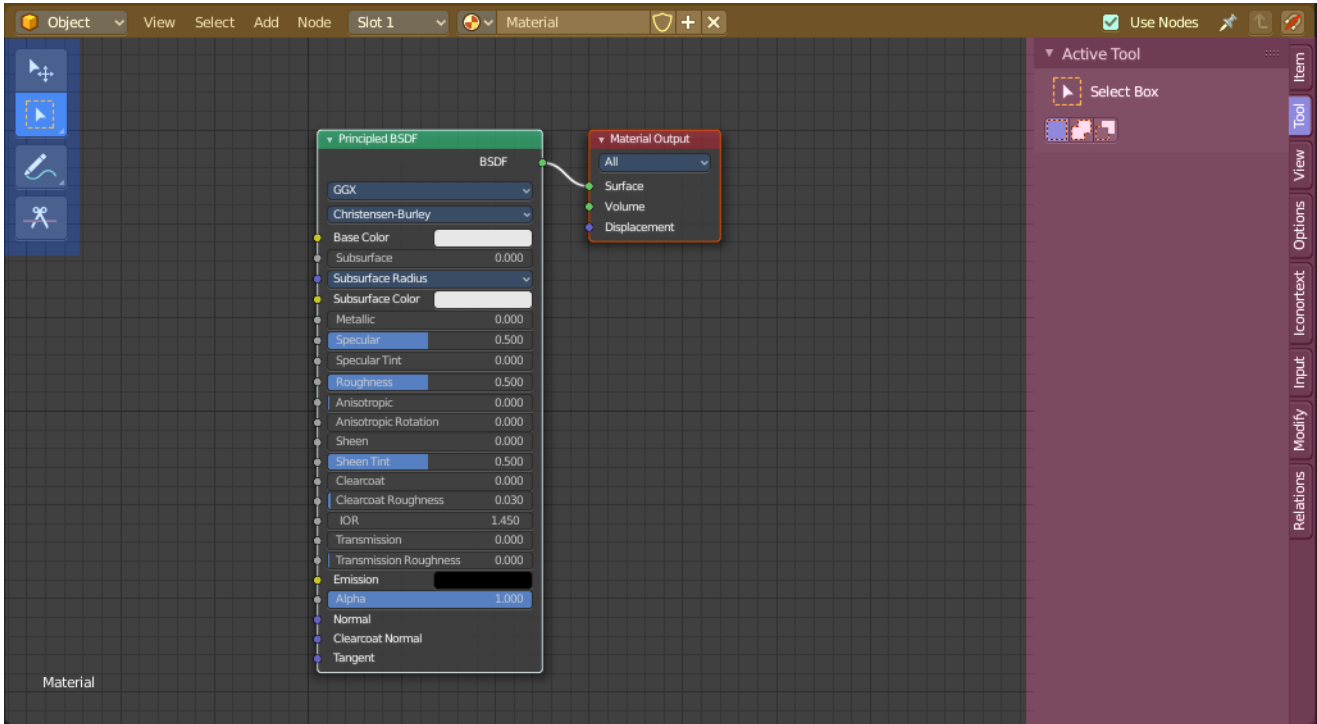

The shader editor is the editor where you can create and edit your materials for your objects in the scene. It is a node editor. The materials are made of nodes. And you connect them to achieve the desired result.

The editor is divided into several areas has several tool areas.

Yellow – Header

Blue - Tool Shelf

Pink - Sidebar

Note that the shader editor does not have a tool area above the header. All tool settings are in the sidebar in the Tool tab.

Navigating in the Shader Editor viewport

Hotkeys

Pan the view - MMB

Zoom - Mouse Wheel, MMB+CTRL, Numpad + / -

View All - Home

Node context menu

When you double right click into the viewport, then you will open a menu. The UV Context menu. Its content is to 100% double content to already existing menus. And it is despite the name not contextual. It does though show different content under different circumstances.

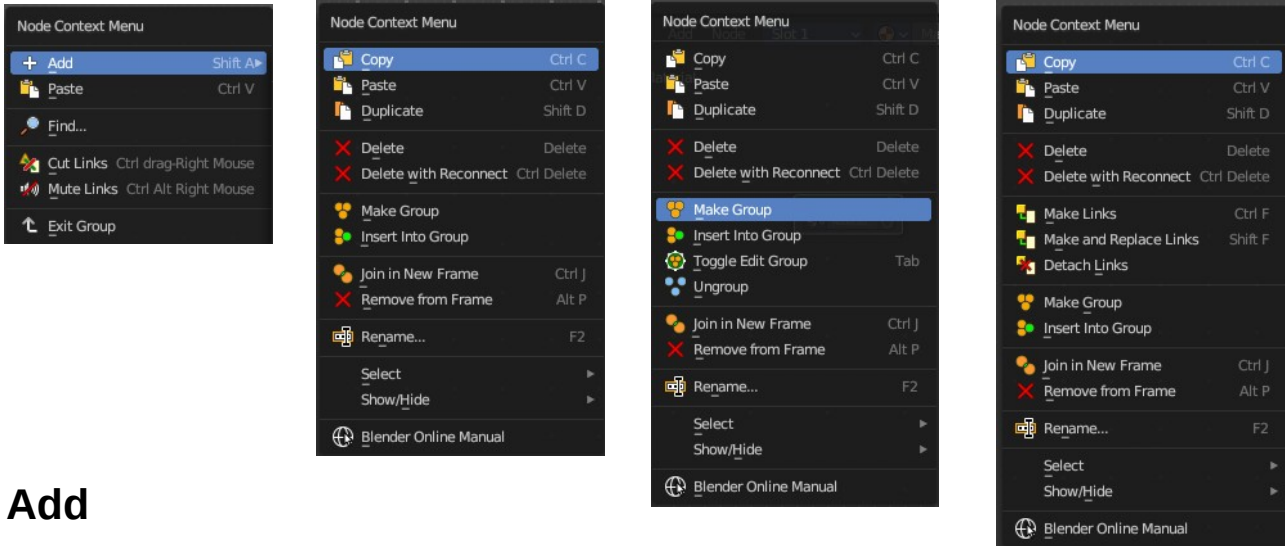

Add

The whole add menu from the header.

Find

Search for nodes, and highlight them. When you are in a node group then it lists the content of the node group.

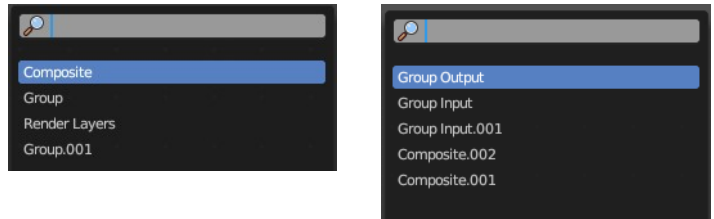

Cut Links

Calls a cut tool with which you can cut links between nodes

Mute Links

Calls a cut tool with which you mute cut links between nodes. To unmute the links use the same tool again.

Exit Group

Same as Edit Group. When you are in a group then you can end editing with this operator.

Copy

Copies the selected nodes.

Paste

Pastes the copied nodes.

Duplicate

Duplicates the selected nodes.

Rename

Allows you to rename the current active node. A popup opens up where you can type in another name.

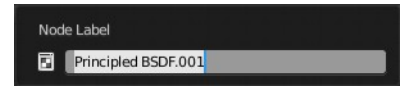

Delete

Deletes the selected nodes. All Connections gets removed.

Delete with Reconnect

Deletes the selected nodes. Existing connections gets bypassed as if the node would not have existed.

Make Links

Shows when you have at least two nodes connected.

Tries to connect nodes where it makes sense. For example, the BSDF output of a Principled shader with the Surface input of the Material Output node.

Make and Replace Links

Shows when you have at least two nodes connected.

Same as Make Links. But it will replace existing links.

Detach Links

Shows when you have at least two nodes connected.

Removes all connections from the selected node, but tries to reconnect the remaining nodes.

Make Group

Groups the selected nodes together.

Select the nodes that you want to group together. Choose Make Group. You will now see a green background. This indicates that the group is created, and that you are in edit mode for the group now.

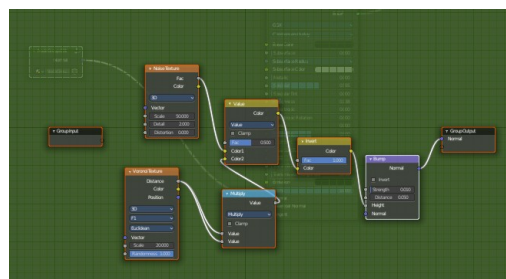
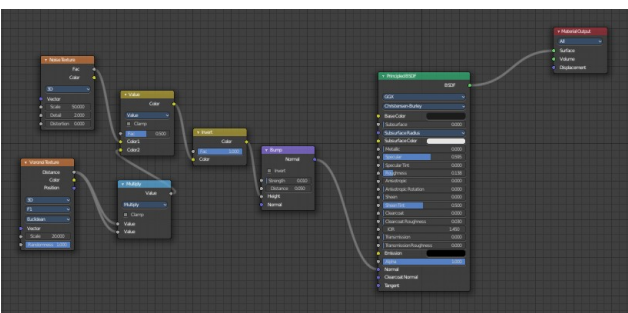

To exit the group edit mode press Tab key, or choose Toggle Edit Group menu item in the sidebar in the Relations tab in the Group panel. That way you can also enter the Group Edit mode again.

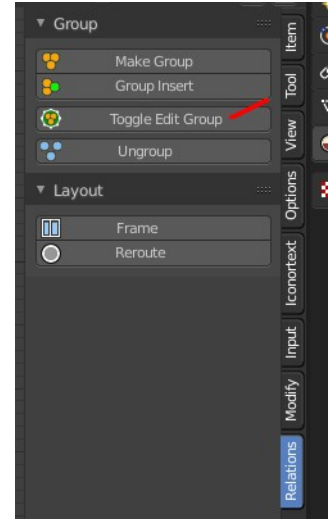
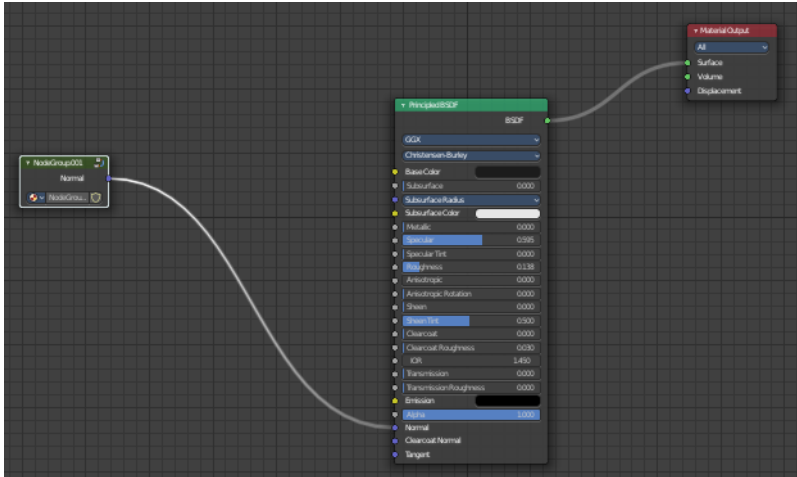

There is a third way to enter the group edit mode. Click at the right upper icon of the group node.

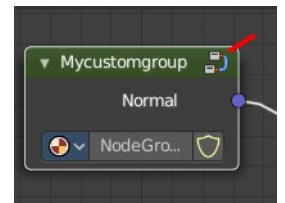

A group can be further collapsed by clicking at the triangle button in the upper left corner.

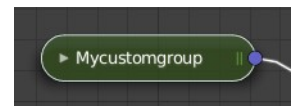

The group can be renamed in the sidebar in the Item tab and in the Properties tab in the Node panel.

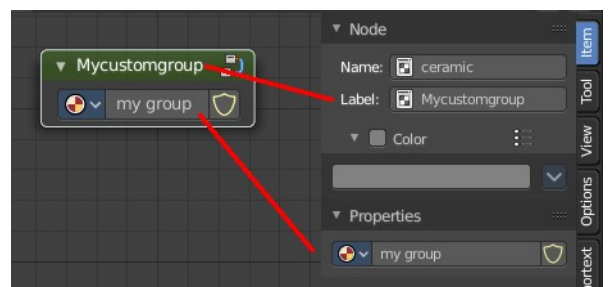

Insert into Group

Allows you to insert a node into a node group.

Select the node, hold down Shift, then select the node group so that both are selected. Then perform the

operator.

Toggle Edit Group

Enters a node group for editing. Or when you are in a node group, exits the node group editing.

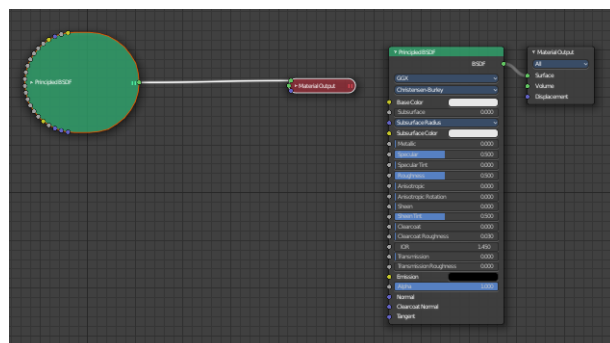

Ungroup

Removes the selected nodes from a group.

Join new Frame

Frame node functionality. Adds the selected node to a frame.

Remove from Frame

Frame node functionality. Removes the selected node from a frame.

Rename

Allows you to rename a node.

Select submenu

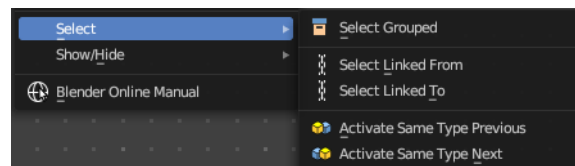

Grouped

Select grouped nodes.

Linked From

Select the nodes that are linked from the currently selected nodes. The nodes before in the hierarchy.

Linked To

Select the nodes that are linked to the currently selected nodes. The nodes behind in the hierarchy.

Activate same type previous

Activate same node type before the current selection, step by step.

Activate same type next

Activate same node type after the current selection, step by step.

Show/Hide submenu

Here you find hide options to make the display of nodes more compact.

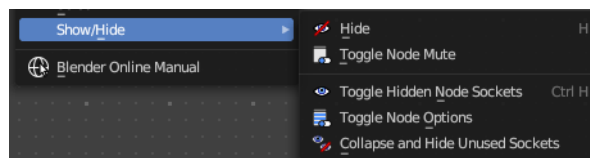

Demonstration happens at an image node.

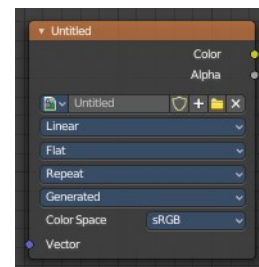

Hide

Hides everything but input and output dots. To view the full node again perform the operator again. It's a toggle. Or click at the triangle left besides the node name.

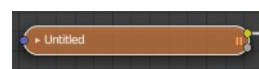

Toggle Node Mute

Deactivates the node.

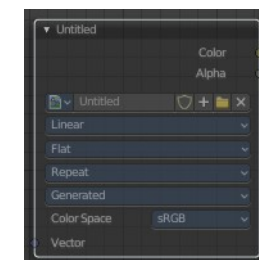

Toggle hidden node sockets

Toggles away the unused node sockets. In this case the vector input node socket and the alpha output node socket will be hidden.

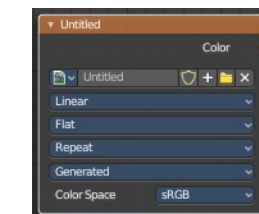

Toggle Node Options

Hides away the properties.

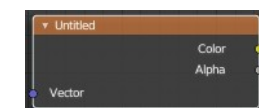

Collapse and Hide Unused Sockets

Like Hide. Hides everything but the node sockets. But it also hides the unused node sockets.



Toggle Node Options

Shows or hides the node options.

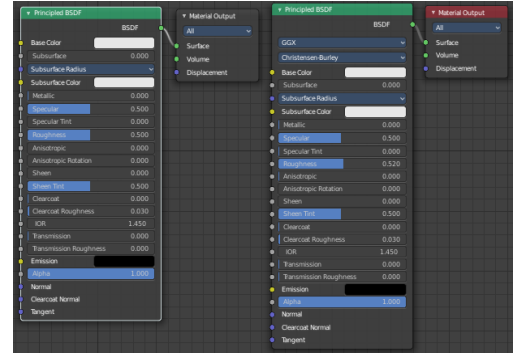

Collapse and Hide Unused Sockets

Shows or hides unused sockets.

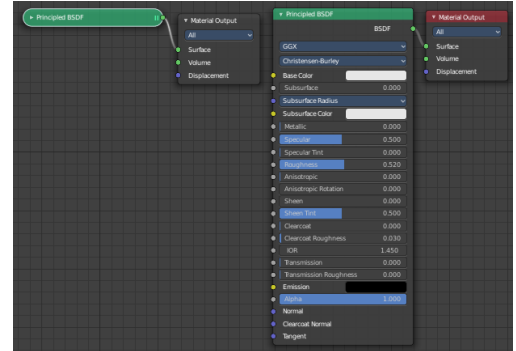

Quick Favorites menu

When you right click at a menu or a button, then a right click menu will open. Tools have usually a Add to Quick Favorites menu entry.

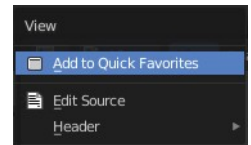

The Quick Favorites Menu is empty by default. With Add to Quick favorites you can add this menu to the Quick menu.

In the 3D view we have a menu called Quick in the header, which shows this content then. In the Image Editor you can just call it with its hotkey. Q. It has no regular menu entry here.

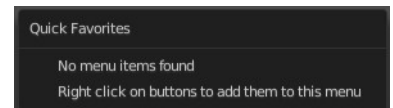

Slider snapping

Snapping also works at sliders. Hover with the mouse over the slider, start to slide, and holding down **ctrl** will snap the sliders in incremental steps.



When it's a default value between 0 and 1 then it usually snaps in 0.1 steps. When it's a default value over 1 then it usually snaps in steps of 10.



13.1 Editors - Shader Editor - Header

Table of content

Shader Editor - Header.....	1
Header Tabs.....	1
Header right click menus.....	1
Editor type Menu.....	2
Sub Modes.....	2
Object.....	2
World.....	2
Line Style.....	2

Shader Editor - Header

The Header contains various menus, navigation elements, settings and tools for the viewport. This content differs, dependent of the sub mode. And the content of the menus may differ too, dependent of the chosen renderer.

The header is divided into two areas. Left mode and menus. Right settings.

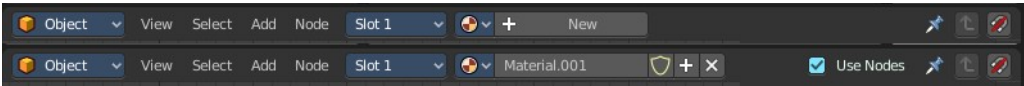

Header Tabs

The tabs at the very left allows you to switch between the most important node editor types by one click. Compositor Editor, Geometry Nodes Editor and Shader Editor.



Header right click menus

The general right click menu functionality is explained in chapter 6 Editors introduction.

Editor type Menu

Bforartists is made of several editor types. Headers can display a menu where you can switch to other editor types.

This menu is hidden by default. It is meant to edit the layouts, and should not be necessary for regular work. You can reveal it in the header right click menu.

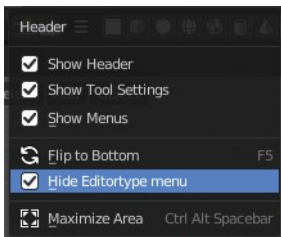
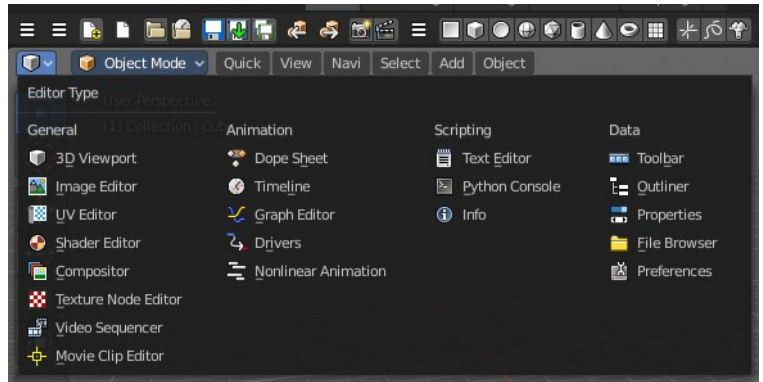

Sub Modes

The Shader Editor has three shader type sub modes. Every sub mode has some different set of shaders for its own purpose.

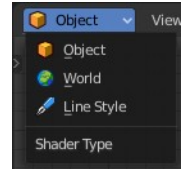

Object

The Object mode is for the scene objects. It shows materials and shader for the scene objects.

World

In the World mode you can change the shaders and materials for the world settings. It shows the world shaders and materials.

Line Style

The Line Style mode allows you to set up materials for the Freestyle renderer. Freestyle rendering must be active for this. It shows the Freestyle materials and shaders.



13.1.1 Editors - Shader Editor - Header - Tools and Options

Table of content

Introduction.....	2
Shader Type Drop-down Box.....	2
Object.....	2
World.....	2
Line Style.....	2
Object Context menu.....	2
Slot.....	2
List of materials.....	3
Add Material Slot.....	3
Remove Material Slot.....	3
Copy and Paste menu.....	3
Copy Material.....	3
Copy Material to Selected.....	3
Paste Material.....	3
Remove unused Slots.....	3
Move Material Up / Down.....	3
Assign.....	3
Select.....	3
Deselect.....	4
Search Field.....	4
Material Prop.....	4
Material Browser.....	4
New.....	4
Material edit box.....	4
Number of Users.....	4
Fake User.....	4
Clear Asset.....	5
New.....	5
Remove.....	5
Right Click menus.....	5
Options.....	5
Use Nodes.....	5
Pin (pin icon).....	5
Parent Node Tree.....	5
Snap.....	6

Introduction

The header in the Shader editor contains various menus and tools. This chapter here is about the tools, modes and options elements in the header.

The text menus are covered in a own chapter each. They vary too much, dependent of mode and object type.

Shader Type Drop-down Box

The Mode drop-down box allows you to switch between the different shader type modes. An object has a different set of available shaders than the world or a line style shading.

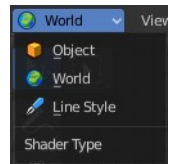

Object

In this mode you work with the scene objects and its materials.

World

In this mode you work with the world settings. HDRI's for example.

Line Style

In this mode you work with Freestyle renderer materials.

Object Context menu

When you right click at the dropdown box then you will reveal the Object context menu.

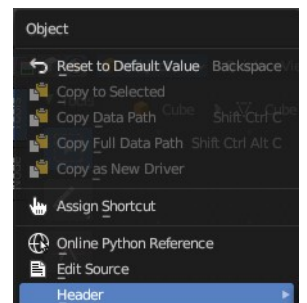

Slot

This element just exists in Object mode.

The Slot menu displays the assigned material(s) at the current active mesh. It can be used to select the active material on the active object. And to select or assign materials to different mesh parts of the same object.

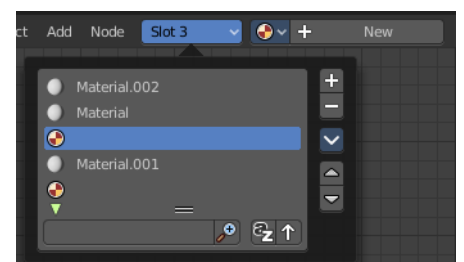

When you add a material by clicking at the new button in the material prop, or by choosing another material from the materials browser, then it is usually also added or changed in the slot system in the current position.

List of materials

The list of materials in the slot list.

Add Material Slot

Adds a new material slot. When you do this manually then this slot will be empty.

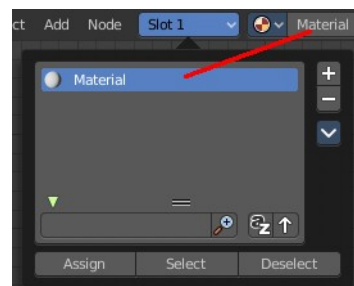

Remove Material Slot

Remove the selected material slot. The removed material will not longer be part of the currently active mesh.

Copy and Paste menu

Copy and paste materials. But just at the current active mesh. Means in Edit Mode.

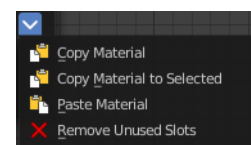

Copy Material

Copies the currently selected material

Copy Material to Selected

Copies the currently selected material, and pastes it to the selection

Paste Material

Pastes the material.

Remove unused Slots

Clean up unused slots.

Move Material Up / Down

Moves the selected material up or down in the list.

Assign

This button appears when you are in Edit mode in the 3D view. Assign the selected material to the selected geometry.

Select

This button appears when you are in Edit mode in the 3D view. Select the geometry where this material is assigned to.

Deselect

This button appears when you are in Edit mode in the 3D view. Deselects the geometry where this material is assigned to.

Search Field

When you click at the little triangle button below the list then you can reveal a search element. The buttons should be self explaining. So we won't go into detail here.



Material Prop

Create a new material, and see a list of the available materials in the scene.



Material Browser

The list of available materials in the scene.

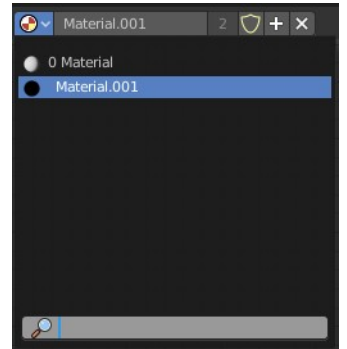

New

Creates a new material.

Material edit box

The name of the current active material. Here you can also rename the material.

Note that the name and available materials differs, dependent in which mode you are. In Object mode you will see the object materials. In World mode the world materials. And in Line Style mode the materials for Freestyle rendering.



Number of Users

Number of users that this material has. See Fake user.

Fake User

With this button you assign a fake user to this selected image.

Data, like images, that is not longer linked to anything else gets removed when you save and reload a scene. Bforartists has the concept of fake users to go around this behavior. An image with a fake user is in fact linked to something. And so it is not lost when you save and reload the scene.

Clear Asset

When you have marked the material as asset, then the fake user button is replaced by a Clear Asset button. It allows you to clear the asset.

New

Creates a new material.

Remove

Removes the material. To delete it completely you need to purge it. See Fake user.

Right Click menus

When you right click at the material property then you will reveal context menus with different content, dependant of where you click. Most of the content is explained in chapter 6, the general right click menu functionality. The rest should be self explaining.

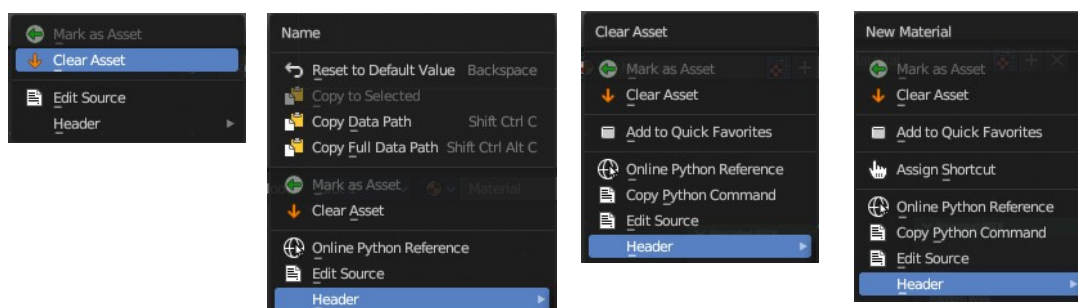

Options

At the right side you will see some options.



Use Nodes

The Use Nodes setting is mostly a legacy setting and should always be checked for materials.

Pin (pin icon)

The pin button will keep the current material selection fixed. When a material is pinned, it will remain visible in the shader editor even when another object or material is selected elsewhere.

Parent Node Tree

Grouping nodes can simplify a node tree by allowing instancing and hiding parts of the tree. Both material and composite nodes can be grouped. This button becomes active when you work with such grouped nodes, and you are in a child group. it allows you to switch to the parent group.

Snap

Activates snapping. When the tool is activated, then you will also reveal the snap settings where you can choose different snap methods.

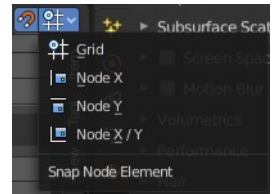



13.1.10 Editors - Shader Editor - Header - Add Menu - Color

Table of content

Detailed table of content.....	1
Add menu - Color.....	4
Bright/Contrast.....	4
Outputs.....	4
Gamma.....	4
Hue Saturation Value.....	5
Invert Color.....	6
Light Falloff.....	6
Mix Color.....	7
RGB Curves.....	9

Detailed table of content

Detailed table of content

Detailed table of content.....	1
Add menu - Color.....	4
Bright/Contrast.....	4
Inputs.....	4
Color.....	4
Brightness.....	4
Contrast.....	4
Outputs.....	4
Color.....	4
Gamma.....	4
Inputs.....	4
Color.....	4
Gamma.....	5
Outputs.....	5
Color.....	5
Hue Saturation Value.....	5
Inputs / Properties.....	5
Hue.....	5
Saturation.....	5
Value.....	5
Factor.....	5
Color.....	5
Outputs.....	5
Color.....	5
Invert Color.....	6
Inputs.....	6
Factor.....	6
Color.....	6
Outputs.....	6
Color.....	6
Light Falloff.....	6

Inputs.....	7
Strength.....	7
Smooth.....	7
Outputs.....	7
Quadratic.....	7
Linear.....	7
Constant.....	7
Mix Color.....	7
Data Type.....	7
Color.....	7
Inputs.....	7
Factor.....	7
Color 1.....	8
Color 2.....	8
Properties.....	8
Mix.....	8
Clamp Result.....	8
Clamp Factor.....	8
Outputs.....	8
Result.....	8
Vector.....	8
Inputs.....	8
Factor.....	8
A.....	8
B.....	8
Properties.....	8
Factor Mode.....	8
Clamp Factor.....	8
Outputs.....	8
Result.....	8
Float.....	9
Inputs.....	9
Factor.....	9
A.....	9
B.....	9
Properties.....	9
Clamp Factor.....	9
Outputs.....	9
Result.....	9
RGB Curves.....	9
Inputs.....	9
Factor.....	9
Color.....	9
Properties.....	9
Curve Field.....	9
Channel buttons.....	9
Navigation elements.....	10
Zoom in and out.....	10
Use Clipping.....	10
Tools.....	10
Reset View.....	10
Extend horizontal.....	10
Extend extrapolated.....	10

Reset Curve.....	10
Curve edit field.....	10
Selecting Points.....	10
Adding Points.....	10
Curve point settings.....	11
Vector Handle.....	11
Auto Handle.....	11
Auto Clamped Handle.....	11
Outputs.....	11
Color.....	11

Add menu - Color

This sub menu contains color related nodes.

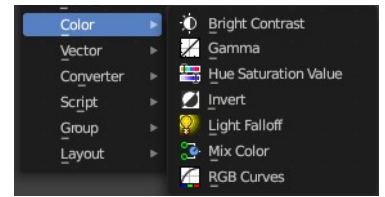

Bright/Contrast

Inputs

Color

Standard input.

Brightness

An additive-type factor by which to increase the overall brightness of the image. Use a negative number to darken an image.

Contrast

A scaling type factor by which to make brighter pixels brighter, but keeping the darker pixels dark. Higher values make details stand out. Use a negative number to decrease the overall contrast in the image.



Outputs

Color

Standard output.

Note. It is possible that this node will put out a value set that has values beyond the normal range, i.e. values greater than one and less than zero. If you will be using the output to mix with other images in the normal range, you should clamp the values using the Map Value node (with the Min and Max enabled), or put through a Color Ramp node (with all normal defaults).

Gamma

Use this node to apply a gamma correction.

Inputs

Color

Standard image input.

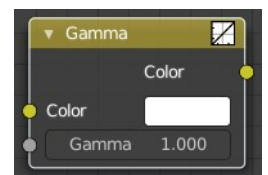

Gamma

An exponential brightness factor.

Outputs

Color

Standard output.

Hue Saturation Value

The Hue Saturation Node applies a color transformation in the HSV color space. Called “Hue Saturation Value” in shader and texture context.

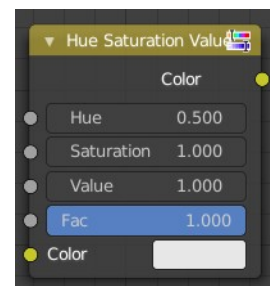

Inputs / Properties

The inputs also works as properties when nothing is connected.

Hue

Specifies the hue rotation of the image. 360° are mapped to (0 to 1). The hue shifts of 0 (-180°) and 1 (+180°) have the same result.

Saturation

A saturation of 0 removes hues from the image, resulting in a greyscale image. A shift greater than 1.0 increases saturation.

Value

Value is the overall brightness of the image. De/Increasing values shift an image darker/lighter.

Factor

Controls the amount of influence the node exerts on the output image.

Color

Standard input.

Outputs

Color

Standard output.

Hue/Saturation Tips

Some things to keep in mind that might help you use this node better:

Hues are vice versa

A blue image, with a Hue setting at either end of the spectrum (0 or 1), is output as yellow (recall that white,

minus blue, equals yellow). A yellow image, with a Hue setting at 0 or 1, is blue.

Hue and Saturation work together.

So, a Hue of 0.5 keeps the blues the same shade of blue, but Saturation can deepen or lighten the intensity of that color.

Gray & White are neutral hues

A gray image, where the RGB values are equal, has no hue. Therefore, this node can only affect it with Value. This applies to all shades of gray, from black to white; wherever the values are equal.

Changing the effect over time

The Hue and Saturation values can be animated with a Time Node or by animating the property.

Invert Color

The Invert Node inverts the colors in the input image, producing a negative.

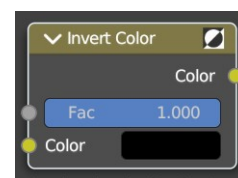

Inputs

Factor

Controls the amount of influence the node exerts on the output image.

Color

Standard input.

Outputs

Color

Standard image output.

Light Falloff

Cycles Only

The Light Falloff node allows you to manipulate how light intensity decreases over distance. In reality light will always fall off quadratically; however, it can be useful to manipulate as a non-physically-based lighting trick. Note that using Linear or Constant falloff may cause more light to be introduced with every global illumination bounce, making the resulting image extremely bright if many bounces are used.

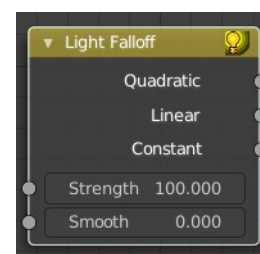

Inputs

Strength

Light strength before applying falloff modification.

Smooth

Smooth intensity of light near light sources. This can avoid harsh highlights, and reduce global illumination noise. 0.0 corresponds to no smoothing; higher values smooth more. The maximum light strength will be strength/smooth.

Outputs

Quadratic

Quadratic light falloff; this will leave strength unmodified if smooth is 0.0 and corresponds to reality.

Linear

Linear light falloff, giving a slower decrease in intensity over distance.

Constant

Constant light falloff, where the distance to the light has no influence on its intensity.

Mix Color

The mix Color node is in real the Mix node in Color mode. It is shared across editors.

The Mix node is meant to mix values. This can be colors, or also a vector or a single value.

Note that the Mix Color node does not start in Color mode when you insert it from the sidebar due a technical limitation in the Blender Python api. Here you have to manually switch to the color mode.

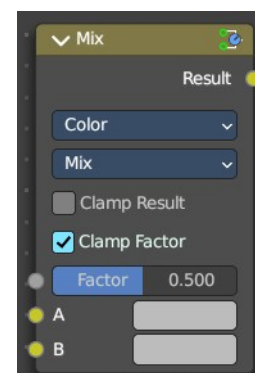

Data Type

The mode in which the node works.

Color

The Mix Node in color mode mixes images by working on the individual and corresponding pixels of the two input images. Called “MixRGB” in the shader and texture context.

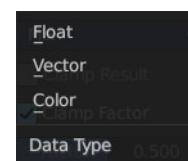

Inputs

Factor

Controls the amount of influence the node exerts on the output image.

Color 1

Usually the background image. The image size and resolution sets the dimensions of the output image.

Color 2

Usually the foreground image.

Properties

Mix

Choose the different blending modes.

Add, Subtract, Multiply, Screen, Divide, Difference, Darken, Lighten, Overlay, Color Dodge, Color Burn, Hue, Saturation, Value, Color, Soft Light, Linear Light.

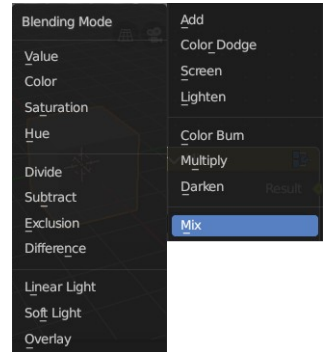

Clamp Result

Clamp the result to 0, 1 range.

Clamp Factor

Clamp the factor to 0, 1 range.

Outputs

Result

Standard output.

Vector

The vector mode allows you to mix vectors.

Inputs

Factor

Controls the amount of influence.

A

The input vector.

B

The output vector.

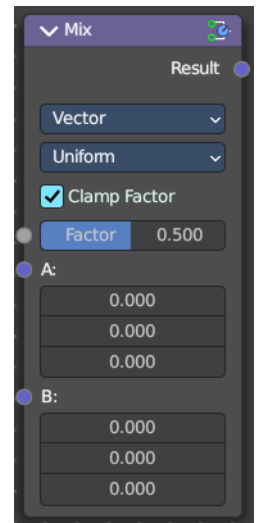

Properties

Factor Mode

Use a single factor for all values, or a factor per value.

Clamp Factor

Clamp the factor to 0, 1 range.

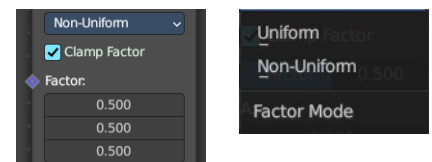

Outputs

Result

Standard output.

Float

The vector mode allows you to mix vectors.

Inputs

Factor

Controls the amount of influence.

A

The input value.

B

The output value.

Properties

Clamp Factor

Clamp the factor to 0, 1 range.

Outputs

Result

Standard output.

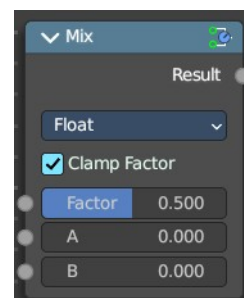

RGB Curves

The RGB Curves Node allows color corrections for each color channel and levels adjustments in the compositing context.

Inputs

Factor

Controls the amount of influence the node exerts on the output image.

Color

Standard image input.

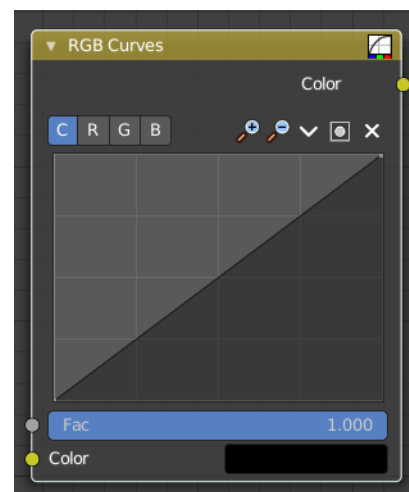

Properties

Curve Field

Channel buttons

Clicking on one of the channels displays the curve for each.

C (Combined RGB), R (Red), G (Green), B (Blue).



Navigation elements

They are described from left to right.



Zoom in and out

The two buttons with the magnifying glass at it zooms in and out in the curve window.

Use Clipping

Clipping options. Set up clipping for the stroke.



Tools

Tools is a menu where you can find some curve related tools.

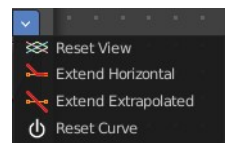

Reset View

Resets the curve windows zoom.

Extend horizontal

Extends the curve before the first curve point and behind the last curve point horizontally.

Extend extrapolated

Extends the curve before the first curve point and behind the last curve point extrapolated.

Reset Curve

Resets the curve to the initial shape.

Curve edit field

Create and tweak a Bezier curve that varies the input levels (X axis) to produce an output level (Y axis).

Selecting Points

You can select curve points. This reveals two edit boxes for the x and y coordinate of this point.

Selected points can be moved around. Left click at them, hold the mouse button down and move them to a new location.

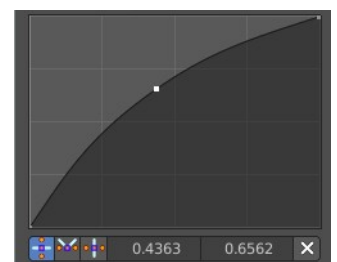

Adding Points

You can add new curve points by simply left clicking at the curve. Move the mouse to position them where you need it.

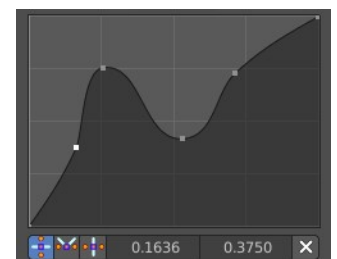

Curve point settings

When you have a point selected then you will reveal further settings at the bottom.



Vector Handle

Set handle type to Vector.

Auto Handle

Set handle type to Auto.

Auto Clamped Handle

Set handle type to Auto Clamped.

Outputs

Color

Standard output.



13.1.11 Editors - Shader Editor - Header - Add Menu - Vector

Table of content

Detailed table of content.....	1
Add menu - Vector.....	3
Bump.....	3
Displacement.....	4
Mapping.....	5
Normal.....	6
Normal Map.....	7
Vector Curves.....	8
Vector Displacement.....	10
Vector Rotate.....	11
Vector Transform.....	11

Detailed table of content

Detailed table of content

Detailed table of content.....	1
Add menu - Vector.....	3
Bump.....	3
Inputs.....	3
Strength.....	3
Distance.....	3
Height.....	4
Normal.....	4
Properties.....	4
Invert.....	4
Outputs.....	4
Normal.....	4
Displacement.....	4
Inputs.....	4
Height.....	4
Mid level.....	4
Scale.....	4
Normal.....	4
Properties.....	5
Space.....	5
Outputs.....	5
Displacement.....	5
Mapping.....	5
Inputs.....	5
Vector.....	5
Location.....	5
Rotation.....	5
Scale.....	5
Properties.....	5
Vector type.....	5

Point.....	5
Texture.....	6
Vector.....	6
Normal.....	6
Outputs.....	6
Vector.....	6
Normal.....	6
Inputs.....	6
Normal.....	6
Properties.....	7
Normal Direction.....	7
Outputs.....	7
Normal.....	7
Dot.....	7
Normal Map.....	7
Inputs.....	7
Strength.....	7
Color.....	7
Properties.....	7
Space.....	7
UV Map.....	8
Outputs.....	8
Normal.....	8
Vector Curves.....	8
Inputs.....	8
Factor.....	8
Vector.....	8
Channel buttons.....	8
Curve edit field.....	8
Selecting Points.....	8
Adding Points.....	8
Navigation elements.....	9
Zoom in and out.....	9
Tools.....	9
Reset View.....	9
Vector Handle.....	9
Auto Handle.....	9
Auto Clamped Handle.....	9
Extend horizontal.....	9
Extend extrapolated.....	9
Reset Curve.....	9
Use Clipping.....	9
Delete Points.....	9
Outputs.....	9
Vector.....	9
Vector Displacement.....	10
Inputs.....	10
Vector.....	10
Mid level.....	10
Scale.....	10
Properties.....	10
Space.....	10
Outputs.....	10

Displacement.....	10
Vector Rotate.....	11
Inputs.....	11
Vector.....	11
Center.....	11
Axis.....	11
Angle.....	11
Properties.....	11
Type.....	11
Invert.....	11
Outputs.....	11
Vector.....	11
Vector Transform.....	11
Inputs.....	11
Vector Input.....	11
Properties.....	12
Type.....	12
Convert From.....	12
Convert To.....	12
Outputs.....	12
Vector Output.....	12

Add menu - Vector

This menu contains nodes that deals with vector data.

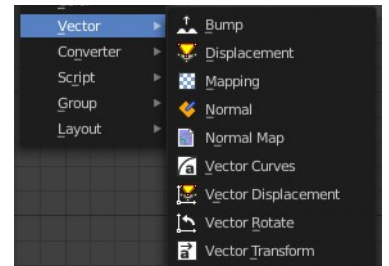

Bump

The Bump node generates a perturbed normal from a height texture, for bump mapping. The height value will be sampled at the shading point and two nearby points on the surface to determine the local direction of the normal.

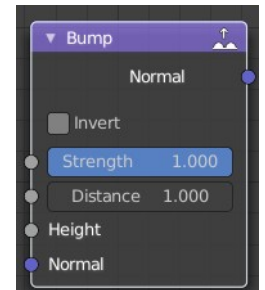

Inputs

Strength

Strength of the bump mapping effect, interpolating between no bump mapping and full bump mapping.

Distance

Multiplier for the height value to control the overall distance for bump mapping.

Height

Scalar value giving the height offset from the surface at the shading point; this is where you plug in textures.

Normal

Standard normal input.

Properties

Invert

Invert the bump mapping, to displace into the surface instead of out.

Outputs

Normal

Standard normal output.

Displacement

The Displacement node is used to displace the surface along all the surface normal, to add more detail to the geometry. Both procedural textures and baked displacement maps may be used.

For best results the mesh must be subdivided finely to bring out the detail in the displacement texture.

It is also possible to use the displacement as bump mapping only by changing the material settings, so that no high resolution mesh is needed.

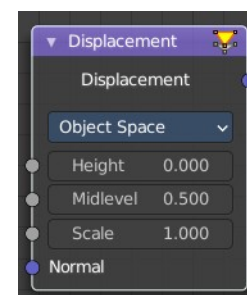

Inputs

Height

Distance to displace the surface along the normal. This is where a texture node can be connected.

Mid level

Neutral displacement value that causes no displacement. With the default 0.5, any lower values will cause the surfaces to be pushed inwards, and any higher values will push them outwards.

Scale

Increase or decrease the amount of displacement.

Normal

Standard normal input.

Properties

Space

Object Space means the displacement scales along with the object. When using World Space the object scale is ignored.

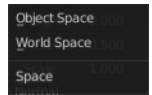

Outputs

Displacement

Displacement offset to be connected into the Material Output.

Mapping

The Mapping node transforms the input vector by applying translation, rotation, and scaling.

Inputs

The inputs of the node are dynamic. In particular, the Location input is only available in the Texture and Point vector types.

Vector

The vector to be transformed.

Location

The amount of translation along each axis.

Rotation

The amount of rotation along each axis. XYZ order.

Scale

The amount of scaling along each axis.

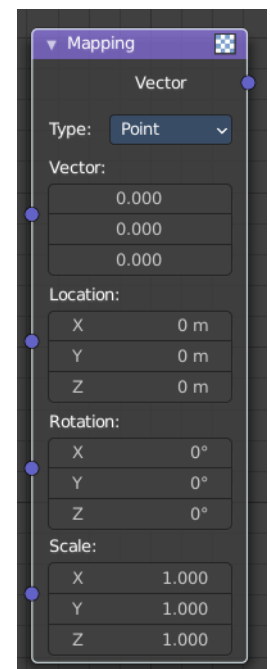

Properties

Vector type

The node applies the transformation differently depending on the semantic type of the input vector.



Point

For this vector type, the node performs a straightforward transformation.

Transforming a texture coordinates is analogous to transforming a UV map. For instance, translating the texture coordinates along the positive X axis would result in the evaluated texture to move in the negative X axis, much

like if one translated a UV map. Similarly, scaling the texture coordinates up would result in the evaluated texture to scale down. So transforming the texture coordinates would appear to have the opposite effect on the evaluated texture.

The order of transformation is: Scale → Rotate → Translate, which means:

Translation moves the input along the local rotation axis.

Rotation rotates the input around the origin of the space.

Scaling scales the input along the global axis.

Texture

For this vector type, the node performs an inverse transformation.

Inverse transforming a texture coordinates would, as opposed to the Point type, transform the evaluated texture itself. For instance, translating the texture coordinates along the positive X axis would result in the evaluated texture to move in the positive X axis, as one would expect. Similarly, scaling the texture coordinates up would result in the evaluated texture to scale up, as one would expect.

The order of transformation is: Translate → Rotate → Scale, which means:

Translation moves the input along the global axis.

Rotation rotates the input around the translation vector.

Scaling scales the input along the local rotation axis.

Vector

For this vector type, a Point transformation is performed, but with zero translation.

Normal

For this vector type, the node performs the inverse transpose of the transformation and normalize the result. Such transformation ensures correct normals after non-uniform scaling. So this type should be used when transforming normals.

Outputs

Vector

The input vector after transformation.

Normal

The Normal node generates a normal vector and a dot product.

Inputs

Normal

Normal vector input.

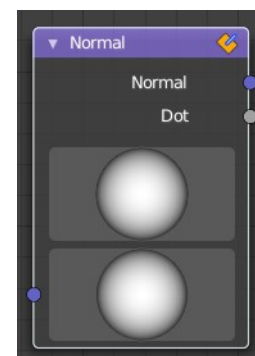

Properties

Normal Direction

To manually set a fixed normal direction vector. LMB click and drag on the sphere to set the direction of the normal. Holding Ctrl while dragging snaps to 45 degree rotation increments.

Outputs

Normal

Normal vector output.

Dot

Dot product output. The dot product is a scalar value.

If two normals are pointing in the same direction the dot product is 1.

If they are perpendicular the dot product is zero (0).

If they are anti parallel (facing directly away from each other) the dot product is -1.

Normal Map

The Normal Map node generates a perturbed normal from an RGB normal map image. This is usually chained with an Image Texture node in the color input, to specify the normal map image. For tangent space normal maps, the UV coordinates for the image must match, and the image texture should be set to Non-Color mode to give correct results.

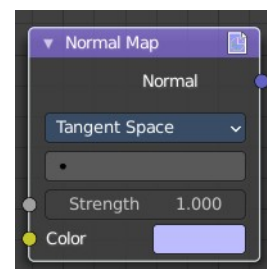

Inputs

Strength

Strength of the normal mapping effect.

Color

RGB color that encodes the normal in the specified space.

Properties

Space

The input RGB color can be in one of three spaces: Tangent, Object and World space. Tangent space normal maps are the most common, as they support object transformation and mesh deformations. Object space normal maps keep sticking to the surface under object transformations, while World normal maps do not.

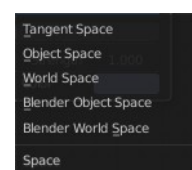

UV Map

Name of the UV map to derive normal mapping tangents from. When chained with an Image Texture node, this UV map should be the same as the UV map used to map the texture.

Outputs

Normal

Normal that can be used as an input to BSDF nodes.

Vector Curves

The Vector Curves node maps an input vector components to a curve.

Inputs

In the shader context the node also has an additional Factor property.

Factor

Controls the amount of influence the node exerts on the output vector.

Vector

Standard vector input.

Properties

Channel

Channel buttons

X, Y, Z. Clicking on one of the channels displays the curve for each.

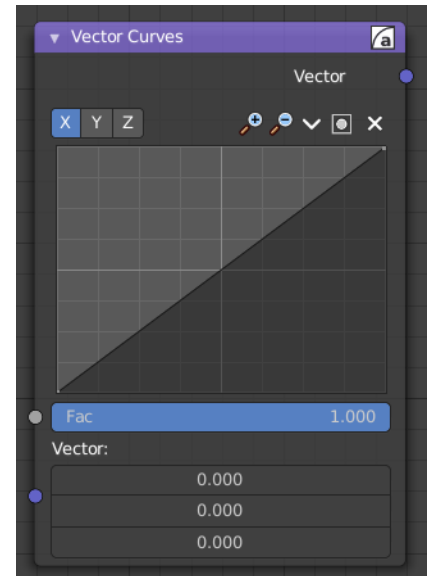

Curve edit field

Create and tweak a Bezier curve that varies the input levels (X axis) to produce an output level (Y axis).

Selecting Points

You can select curve points. This reveals two edit boxes for the x and y coordinate of this point.

Selected points can be moved around. Left click at them, hold the mouse button down and move them to a new location.

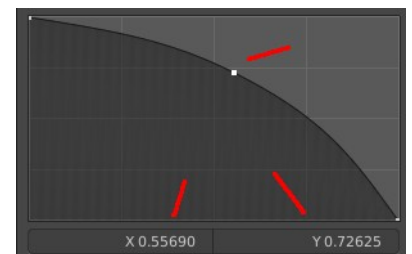

Adding Points

You can add new curve points by simply left clicking at the curve. Move the mouse to position them where you need it.

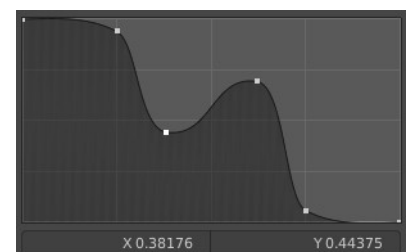

Navigation elements

The navigation elements at the top are described from left to right.



Zoom in and out

The two buttons with the magnifying glass at it zooms in and out in the curve window.

Tools

Tools is a menu where you can find some curve related tools.

Reset View

Resets the curve windows zoom.

Vector Handle

Set handle type to Vector.

Auto Handle

Set handle type to Auto.

Auto Clamped Handle

Set handle type to Auto Clamped.

Extend horizontal

Extends the curve before the first curve point and behind the last curve point horizontally.

Extend extrapolated

Extends the curve before the first curve point and behind the last curve point extrapolated.

Reset Curve

Resets the curve to the initial shape.

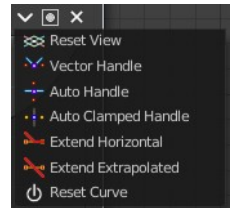

Use Clipping

Clipping options. Set up clipping for the stroke.

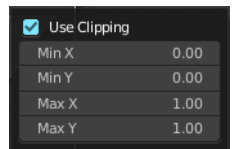

Delete Points

Deletes selected curve points.

Outputs

Vector

Standard vector output.

Vector Displacement

The Vector Displacement node is used to displace the surface along arbitrary directions, unlike the regular Displacement node which only displaces along the surface normal.

It is typically used to apply vector displacement maps created by other sculpting software. Vector displacement maps can fully represent the high resolution detail to be applied on a smooth base mesh, unlike regular displacement maps.

For best results the mesh must be subdivided finely to bring out the detail in the displacement texture.

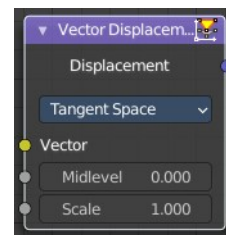

Inputs

Vector

Vector specifying the displacement along three axes. This is where a texture node can be connected.

Typically a baked vector displacement image texture is used. For Object Space, RGB colors in the image are interpreted as an XYZ offset in object space. For Tangent Space, R is an offset along the tangent, G along the normal and B along the bi tangent.

Mid level

Neutral displacement value that causes no displacement. With the default 0.0, any lower values will cause the surfaces to be pushed inwards, and any higher values will push them outwards.

Scale

Increase or decrease the amount of displacement.

Properties

Space

Object Space maps work for static meshes, and will render slightly faster with less memory usage. Tangent Space maps can be used for meshes that will be deformed, like animated characters, so the displacement follows the deformation.

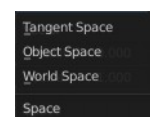

Outputs

Displacement

Displacement offset to be connected into the Material Output.

Vector Rotate

This node provides the ability to rotate a vector around a center point using either Axis Angle, Single Axis or Euler methods.

Inputs

Vector

The input vector.

Center

The center for the rotation.

Axis

The axis angles.

Angle

The rotation angle.

Properties

Type

The rotation type.

Invert

Invert the angle

Outputs

Vector

The output vector

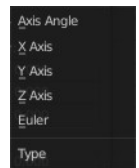
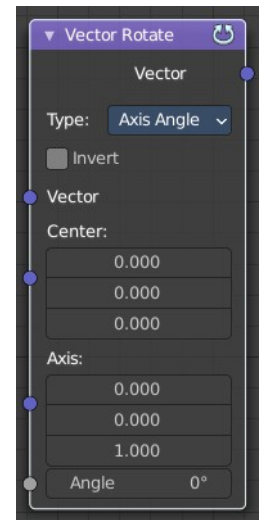

Vector Transform

The Vector Transform node allows converting a vector, point, or normal between world and camera and object coordinate space.

Inputs

Vector Input

Standard vector input.

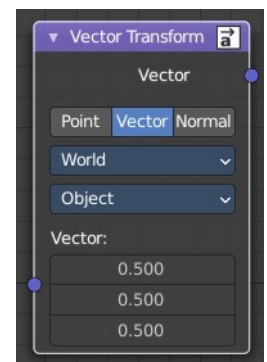

Properties

Type

Specifies the input/output type.

Vector, Point, Normal.

Convert From

Coordinate Space to convert from World, Object or Camera.

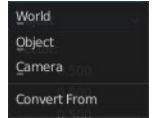

Convert To

Coordinate Space to convert to World, Object or Camera.

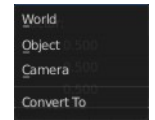

Outputs

Vector Output

The transformed output vector.



13.1.12 Editors - Shader Editor - Header - Add Menu - Converter

Table of content

Detailed table of content.....	1
Add menu - Converter.....	5
Blackbody.....	5
Clamp.....	5
Color Ramp.....	6
Combine Color.....	8
Combine XYZ.....	8
Float Curve.....	9
Map Range.....	10
Math.....	11
Mix.....	12
RGB to BW.....	14
Separate Color.....	14
Separate XYZ.....	15
Shader To RGB.....	15
Vector Math.....	16
Wavelength.....	17

Detailed table of content

Detailed table of content

Detailed table of content.....	1
Add menu - Converter.....	5
Blackbody.....	5
Inputs.....	5
Temperature.....	5
Outputs.....	5
Color.....	5
Clamp.....	5
Inputs.....	5
Value.....	5
Min.....	5
Max.....	6
Properties.....	6
Clamp Type.....	6
Min Max.....	6
Range.....	6
Outputs.....	6
Result.....	6
Color Ramp.....	6
Inputs.....	6
Factor.....	6
Properties.....	6
Color Ramp.....	6
Controls.....	6

+.....	6
-.....	6
Tools menu.....	6
Flip Color Ramp.....	6
Distribute Stops from Left.....	7
Distribute Stops Evenly.....	7
Eyedropper (pipette icon) E.....	7
Reset Color Ramp.....	7
Color Mode.....	7
RGB.....	7
HSV/HSL.....	7
Interpolation.....	7
Ease.....	7
Cardinal.....	7
Linear.....	7
B-Spline.....	7
Constant.....	7
Color Ramp.....	7
Active Color Stop elements.....	7
Choose active color stop.....	7
Pos.....	7
Outputs.....	8
Image.....	8
Alpha.....	8
Combine Color.....	8
Input.....	8
Mode.....	8
R, G and B.....	8
Input – RGB mode.....	8
R, G and B.....	8
Input – HSV mode.....	8
H , S and V.....	8
Input – HSL mode.....	8
H , S and L.....	8
Combine XYZ.....	8
Input.....	9
X Y and Z.....	9
Output.....	9
Color.....	9
Float Curve.....	9
Inputs.....	9
Factor.....	9
Attribute.....	9
Properties.....	9
Curve Widget.....	9
Navigation elements.....	9
Zoom in and out.....	9
Tools.....	9
Reset View.....	9
Vector Handle.....	9
Auto Handle.....	9
Auto Clamped Handle.....	10
Extend Horizontal.....	10

Extend Extrapolation.....	10
Reset Curve.....	10
Map Range.....	10
Inputs.....	10
Value.....	10
From Min.....	10
From Max.....	10
To Min.....	10
To Max.....	10
Properties.....	10
Interpolation Type.....	10
Linear.....	10
Stepped Linear.....	10
Smooth Step.....	10
Smoother Step.....	11
Clamp.....	11
Outputs.....	11
Result.....	11
Math.....	11
Inputs.....	11
Value.....	11
Value.....	11
Properties.....	11
Operation.....	11
Clamp.....	11
Outputs.....	12
Value.....	12
Mix.....	12
Input.....	12
Float.....	12
Factor.....	12
A.....	12
B.....	12
Vector.....	12
Factor mode Uniform.....	12
Factor.....	12
A.....	12
B.....	12
Factor mode Non Uniform.....	12
Factor.....	12
A.....	12
B.....	13
Color.....	13
Factor.....	13
A.....	13
B.....	13
Properties.....	13
Data Type.....	13
Float mode.....	13
Clamp Factor.....	13
Vector mode.....	13
Factor mode.....	13
Clamp Factor.....	13

Color mode.....	13
Blending mode.....	13
Clamp Result.....	14
Clamp Factor.....	14
Output.....	14
Result.....	14
RGB to BW.....	14
Inputs.....	14
Image.....	14
Outputs.....	14
Value.....	14
Separate Color.....	14
Input.....	14
Mode.....	14
R, G and B.....	14
Image.....	14
Output – RGB mode.....	15
R, G and B.....	15
Output – HSV mode.....	15
H , S and V.....	15
Output – HSL mode.....	15
H , S and L.....	15
Separate XYZ.....	15
Input.....	15
Vector.....	15
Output.....	15
X, Y and Z.....	15
Shader To RGB.....	15
Inputs.....	16
Shader.....	16
Outputs.....	16
Color.....	16
Alpha.....	16
Vector Math.....	16
Inputs.....	16
Vector.....	16
Vector.....	16
Scale.....	16
Properties.....	17
Operation.....	17
Outputs.....	17
Vector.....	17
Value.....	17
Wavelength.....	17
Inputs.....	17
Wavelength.....	17
Outputs.....	17
Color.....	17

Add menu - Converter

Here you find mainly nodes to convert data to another data.

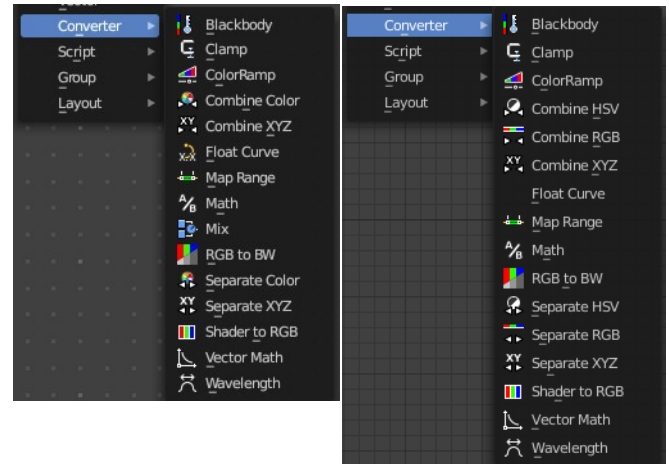

Blackbody

The Blackbody node converts a blackbody temperature to RGB value. This can be useful for materials that emit light at natural occurring frequencies.

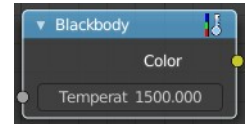

Inputs

Temperature

The temperature in Kelvin.

Outputs

Color

RGB color output.

Clamp

The Clamp node clamps a value between a minimum and a maximum.

Inputs

Value

The input value to be clamped.

Min

The minimum value.

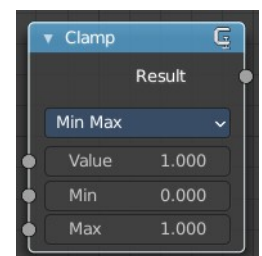

Max

The maximum value.

Properties

Clamp Type

Min Max

Clamp values using Min and Max values.

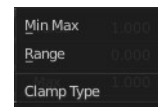

Range

Clamp values between Min and Max range.

Outputs

Result

The input value after clamping.

Color Ramp

The Color Ramp Node is used for mapping values to colors with the use of a gradient.

Inputs

Factor

The Factor input is used as an index for the color ramp.

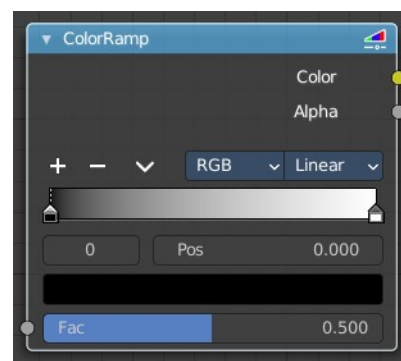

Properties

Color Ramp

Color Ramps enables the user to specify a range of colors based on color stops. The color between the color stops gets interpolated.

Controls

+

Add a stop to your color ramp. The stop will be added after the selected one, in the middle to the next one.

-

Deletes the selected color stop from the list.

Tools menu

Flip Color Ramp

Flips the gradient, inverting the values of the color ramp.

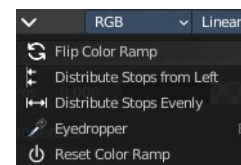

Distribute Stops from Left

Rearrange the stops so that every step has the same space to the right.

Distribute Stops Evenly

Space between all neighboring stops becomes equal.

Eyedropper (pipette icon) E

An Eyedropper to sample a color or gradient from the interface to be used in the color ramp.

Reset Color Ramp

Resets the color ramp to its default state.

Color Mode

RGB

Blends color by mixing each color channel and combining.

HSV/HSL

Blends colors by first converting to HSV or HSL, mixing, then combining again. This has the advantage of maintaining saturation between different hues, where RGB would de-saturate, this allows for a richer gradient.

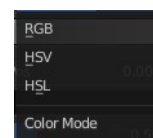

Interpolation

Ease

Uses an Ease Interpolation for the color stops.

Cardinal

Uses a Cardinal Interpolation for the color stops.

Linear

Uses a Linear Interpolation for the color stops.

B-Spline

Uses a B-Spline Interpolation for the color stops.

Constant

Uses a Constant Interpolation for the color stops.

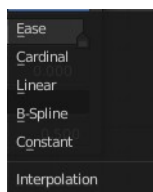

Color Ramp

The color band. A click at one of the color stops makes it the active one. You can move the color stops by clicking at them and dragging them around.



Active Color Stop elements

Adjust the active color stop.

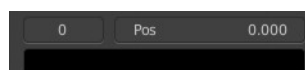

Choose active color stop

Choose the color stop by index.

Pos

The position of the active color stop. The range goes from 0.000 to 1.000

Outputs

Image

Standard image output.

Alpha

Combine Color

Combine the single RGB channels into a single image.

Input

Mode

- **RGB** colour processing
- **HSV** colour processing
- **HSL** colour processing

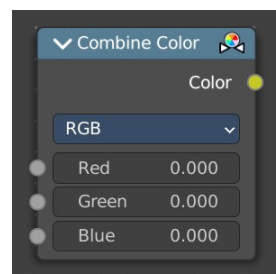

R, G and B

The red, green and blue channels of an image.

Input – RGB mode

R, G and B

The red, green and blue channels of an image.

Input – HSV mode

H, S and V

The Hue, Saturation and Value channels of an image.

Input – HSL mode

H, S and L

The Hue, Saturation and Luminescence channels of an image.

Combine XYZ

Same as with Combine RGB node. It combines color values. But instead combining rgb values, which are in the range of 0 to 255, it uses values in the range from 0 to 1.

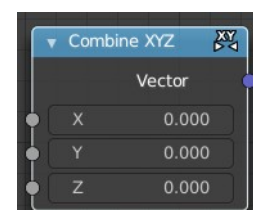

Input

X Y and Z

X, Y and Z values.

Output

Color

Color output.

Float Curve

Generates a curve. This curve can then be used for profiles for example.

Inputs

Factor

The input factor.

Attribute

The input value.

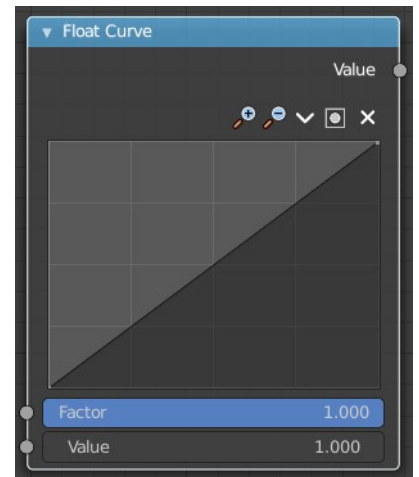

Properties

Curve Widget

Navigation elements

The navigation elements at the top are described from left to right.



Zoom in and out

The two buttons with the magnifying glass at it zooms in and out in the curve window.

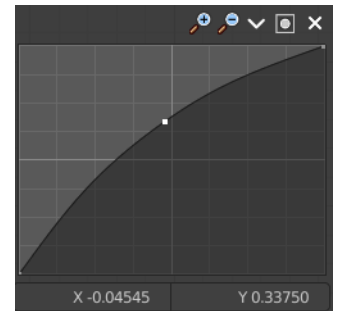

Tools

Tools is a menu where you can find some curve related tools.

Reset View

Resets the curve windows zoom.

Vector Handle

Set handle type to Vector.

Auto Handle

Set handle type to Auto.

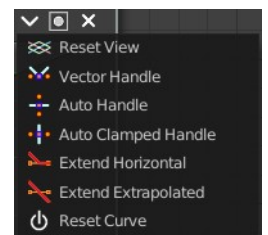

Auto Clamped Handle

Set handle type to Auto Clamped.

Extend Horizontal

Extends the curve before the last point and after the last point horizontally.

Extend Extrapolation

Extends the curve before the last point and after the last point extrapolated.

Reset Curve

Resets the curve to the initial shape.

Map Range

The Map Range node remaps a value from a range to a target range.

Inputs

Value

The input value to be remapped.

From Min

The lower bound of the range to remap from.

From Max

The higher bound of the range to remap from.

To Min

The lower bound of the target range.

To Max

The higher bound of the target range.

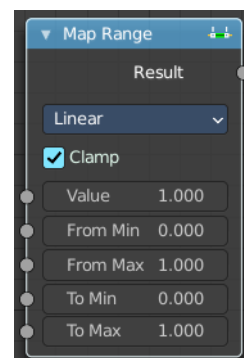

Properties

Interpolation Type

Linear

Linear interpolation between From Min and From Max values.

Stepped Linear

Stepped linear interpolation between From Min and From Max values.

Smooth Step

Smooth Hermite edge interpolation between From Min and From Max values.

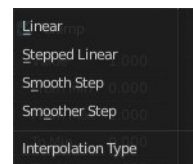

Smoother Step

Smoother Hermite edge interpolation between From Min and From Max values.

Clamp

If enabled, the output is clamped to the target range.

Outputs

Result

The input value after remapping.

Math

The Math Node performs math operations.

Inputs

Value

First numerical value. The trigonometric functions accept values in radians.

Value

Second numerical value. This value is not used in functions that accept only one parameter like the trigonometric functions, Round and Absolute.

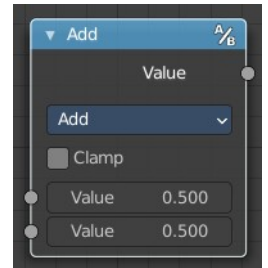

Properties

Operation

Here you can choose what mathematical operation to perform.

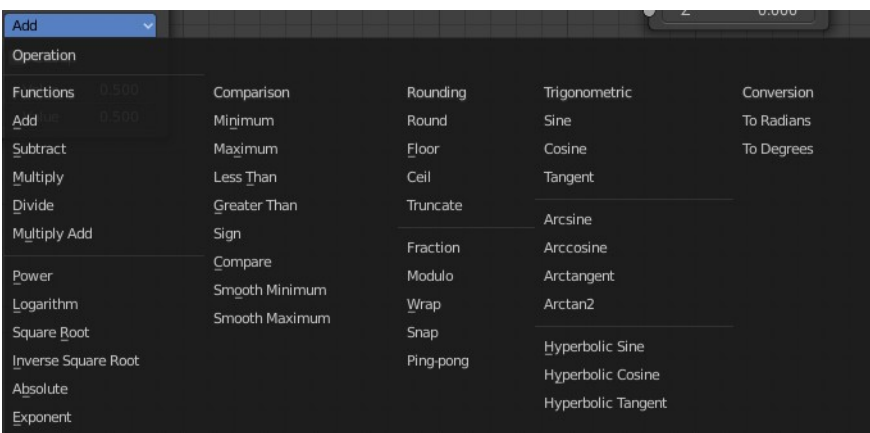

Clamp

Limits the output to the range (0 to 1). See clamp.

Outputs

Value

Numerical value output.

Mix

Allows to mix values and vectors in various ways. The node has three different modes. Float, Vector and Color



Input

Float

Factor

The mix factor.

A

Float value A input.

B

Float value B input.

Vector

Factor mode Uniform

Factor

The mix factor.

A

Vector A input.

B

Vector B input.

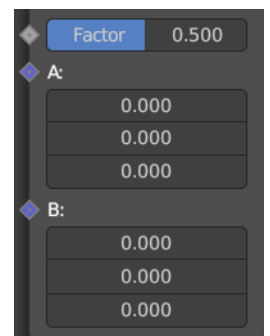
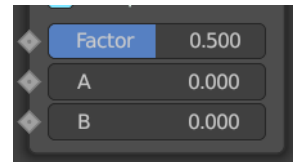

Factor mode Non Uniform

Factor

The vector mix factor.

A

Vector A input.

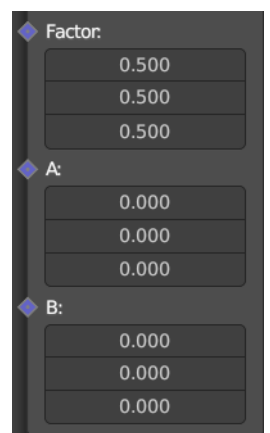

B

Vector B input.

Color

Factor

The mix factor.

A

Color A input.

B

Color B input.

Properties

Data Type

Which mode to use.

Float mode

Clamp Factor

Clamp the factor to 0-1 range.

Vector mode

Factor mode

Uniform or non uniform factor.

Clamp Factor

Clamp the factor to 0-1 range.

Color mode

Blending mode

What blending mode to use for the color.

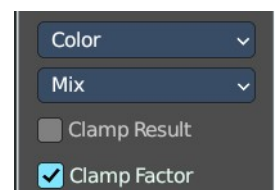
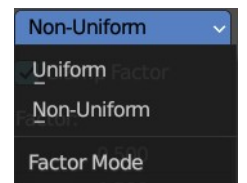
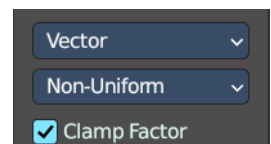
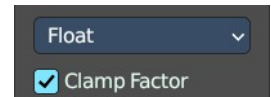
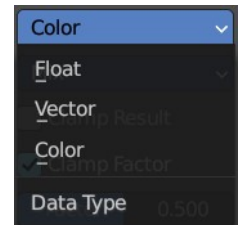

Clamp Result

Clamp the result to 0-1 range.

Clamp Factor

Clamp the input factor to 0-1 range.

Output

Result

The output value or vector.

RGB to BW

The RGB to BW Node converts an RGB color image to a gray-scale image based at its luminance.

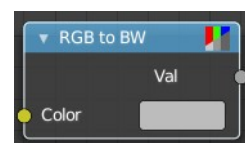

Inputs

Image

Color image input.

Outputs

Value

Gray-scale value output.

Separate Color

Separates the single RGB channels from a single image.

Input

Mode

- **RGB** colour processing
- **HSV** colour processing
- **HSL** colour processing

R, G and B

Image

The image input.

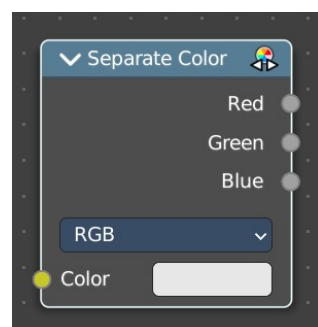

Output – RGB mode

R, G and B

The red, green and blue channels of an image.

Output – HSV mode

H, S and V

The Hue, Saturation and Value channels of an image.

Output – HSL mode

H, S and L

The Hue, Saturation and Luminescence channels of an image.

Separate XYZ

Same as with Separate RGB node. It separates color values. But instead separating rgb values, which are in the range of 0 to 255, it uses a vector with the values in the range from 0 to 1.

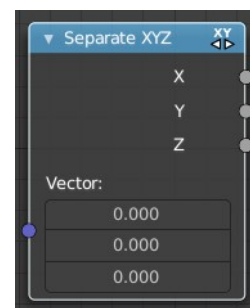

Input

Vector

The Input vector.

Output

X, Y and Z

The output vectors for X, Y and Z

Shader To RGB

Eevee Only

Converts a shader input to rgba values.

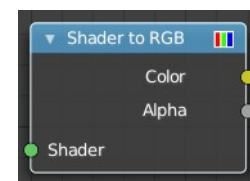

The Shader to RGB node is typically used for non-photo realistic rendering, to apply additional effects on the output of BSDFs. For example, a color ramp on the output of a diffuse BSDF can be used to create a flexible toon shader.

Using this conversion breaks the PBR pipeline and thus makes the result unpredictable when used in combination with effects such as ambient occlusion, contact shadows, soft shadows and screen space refraction.

Some effects require multiple samples to converge, and applying arbitrary changes to noisy input may not

convert to a smooth result.

Warning! If a Shader to RGB node is used, any upstream BSDF will be invisible to the following effects:
Screen Space Reflection, Subsurface Scattering

Inputs

Shader

Any shader such as a BSDF or Emission node can be linked here.

Outputs

Color

Surface color computed from BSDFs and lighting.

Alpha

Alpha transparency from any Transparent BSDFs in the input.

Vector Math

The Vector Math node performs the selected math operation on the input vectors.

Inputs

The inputs of the node are dynamic. Some inputs are only available in certain operations. For instance, the Scale input is only available in the Scale operator.

Vector

Input vector A.

Vector

Input vector B.

Scale

Input Scale.

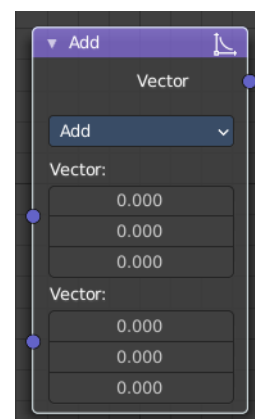

Properties

Operation

The vector math operator to be applied on the input vectors.



Outputs

The output of the node is dynamic. It is either a vector or a scalar depending on the operator. For instance, the Length operator have a scalar output while the Add operator have a vector output.

Vector

Output vector.

Value

Output value.

Wavelength

Cycles Only

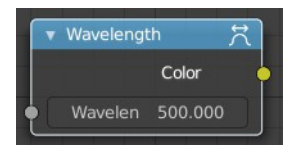

The Wavelength node converts a wavelength value to an RGB value. This can be used to achieve a specific color on the light spectrum.

Inputs

Wavelength

The color wavelength from 380 to 780 nanometers.

Outputs

Color

RGB color output.



13.1.13 Editors - Shader Editor - Header - Add Menu - Script

Table of content

Add menu - Script..... 1
 Script..... 1
 Properties..... 1
 Internal / External..... 1
 OSL..... 1

Add menu - Script

The Script menu contains actually just one menu item. A script node.



Script

In this node you can load OSL shaders.

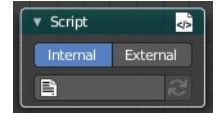

Properties

Internal / External

Use an internal OSL script from the script editor. Or use an external OSL script.

With internal you will see a drop down list with the opened scripts in the text editor.

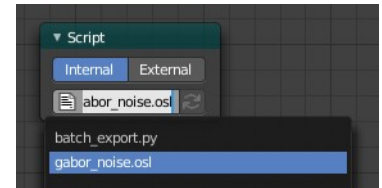

With external the dialog below turns into a string box with a file browser button with which you can load your script then.

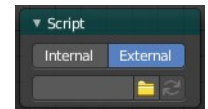

This node has no inputs and no outputs. The input is the script. And OSL scripts outputs directly.

OSL

OSL was designed for node-based shading, and each OSL shader corresponds to one node in a node setup. To add an OSL shader, add a script node and link it to a text or an external file. Input and output sockets will be created from the shader parameters on clicking the update button in the Node or the Text editor.

OSL shaders can be linked to the node in a few different ways. With the Internal mode, a text data-block is used to store the OSL shader, and the OSO byte code is stored in the node itself. This is useful for distributing a blend-file with everything packed into it.

The External mode can be used to specify a .osl file from a drive, and this will then be automatically compiled into a .oso file in the same directory. It is also possible to specify a path to a .oso file, which will then be used directly, with compilation done manually by the user. The third option is to specify just the module name, which will be looked up in the shader search path.

The shader search path is located in the same place as the scripts or configuration path, under:

Linux

`$HOME/.config/blender/2.79/shaders/`

MS-Windows

`C:\Users\%user\AppData\Roaming\Blender Foundation\Blender\2.79\shaders\`

macOS

`/Users/$USER/Library/Application Support/Blender/2.79/shaders/`

Tip. For use in production, we suggest to use a node group to wrap shader script nodes, and link that into other blend-files. This makes it easier to make changes to the node afterwards as sockets are added or removed, without having to update the script nodes in all files.



13.1.14 Editors - Shader Editor - Header - Add Menu - Group

Table of content

- Add menu - Group.....1
- Make Group.....1
- Insert into Group.....2
- Ungroup.....2
- Toggle Edit Group.....3
- Group Input.....3
- Group Output.....3
- List of Node Groups.....3

Add menu - Group

Node groups allows you to group different nodes of the material together to reduce the visual complexity. A node group acts like any other node.

Material node groups should not include Input nodes, like Image nodes, or Output nodes.

If you include a source node in your group, you will end up having the source node appearing twice: once inside the group, and once outside the group in the new material node tree.

If you include an output node in the group, there will not be an output socket available from the group!

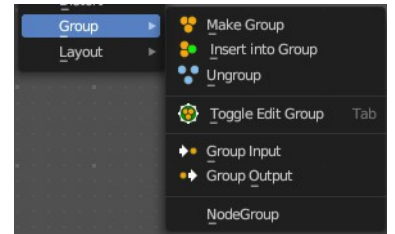

Make Group

Groups the selected nodes together.

Select the nodes that you want to group together. Choose Make Group. You will now see a green background. This indicates that the group is created, and that you are in edit mode for the group now.

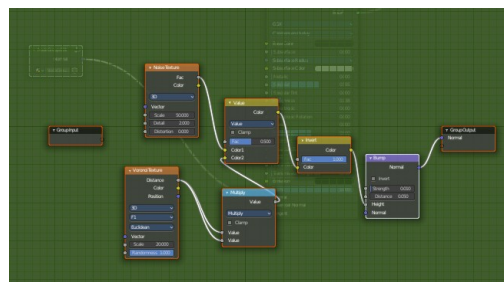
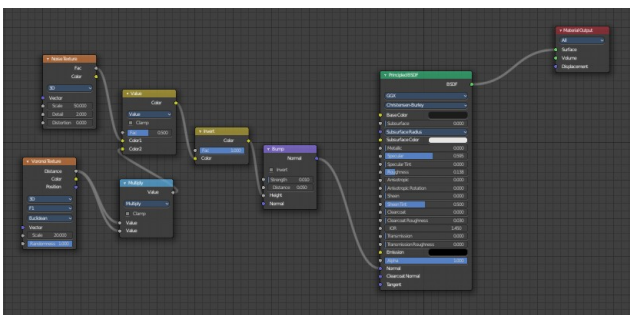

To exit the group edit mode press Tab key, or choose Toggle Edit Group menu item in the sidebar in the Relations tab in the Group panel. That way you can also enter the Group Edit mode again.

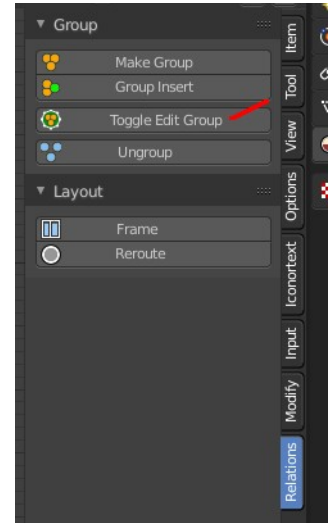
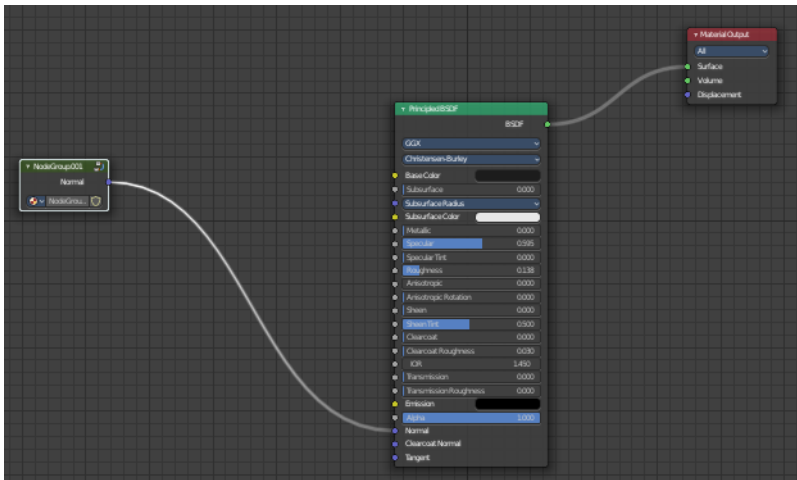

There is a third way to enter the group edit mode. Click at the right upper icon of the group node.

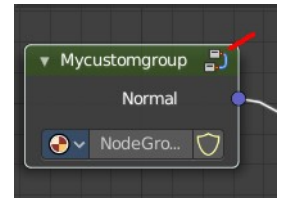

A group can be further collapsed by clicking at the triangle button in the upper left corner.

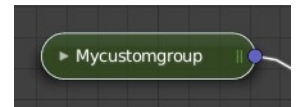

The group can be renamed in the sidebar in the Item tab and in the Properties tab in the Node panel.

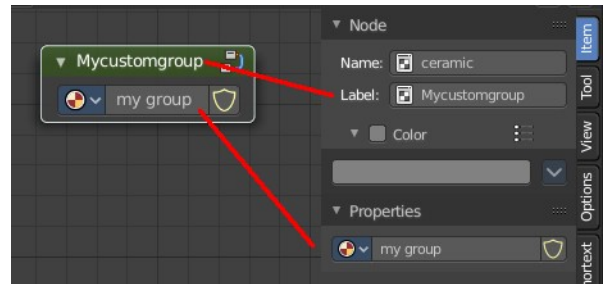

Insert into Group

Allows you to insert a node into a node group.

Select the node, hold down Shift, then select the node group so that both are selected. Then perform the operator.

Ungroup

Ungroups an existing group. You need to be outside of the group edit mode.

Toggle Edit Group

Enters a node group for editing. Or when you are in a node group, exits the node group editing.

Group Input

Adds a Group Input node. This node is usually already part of a new created group.

Group Output

Adds a Group Output node. This node is usually already part of a new created group.

List of Node Groups

Once you have created a node group it will also show up in the group menu. Groups can be inserted to other materials too.

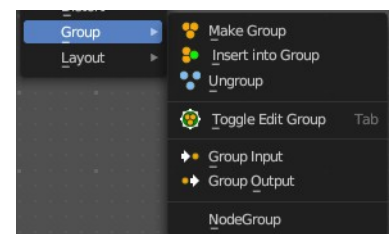



13.1.15 Editors - Shader Editor - Header - Add Menu - Layout

Table of content

- Add menu - Layout.....1
- Frame.....1
 - Adding and Removing Nodes.....1
 - Resizing Frame.....2
 - Label and Color.....2
- Reroute.....2
 - Move, Rotate, Scale.....2

Add menu - Layout

These nodes helps organizing the node layout.



Frame

The Frame node allows you to drop nodes into a frame. This frame can be dragged around as a whole.

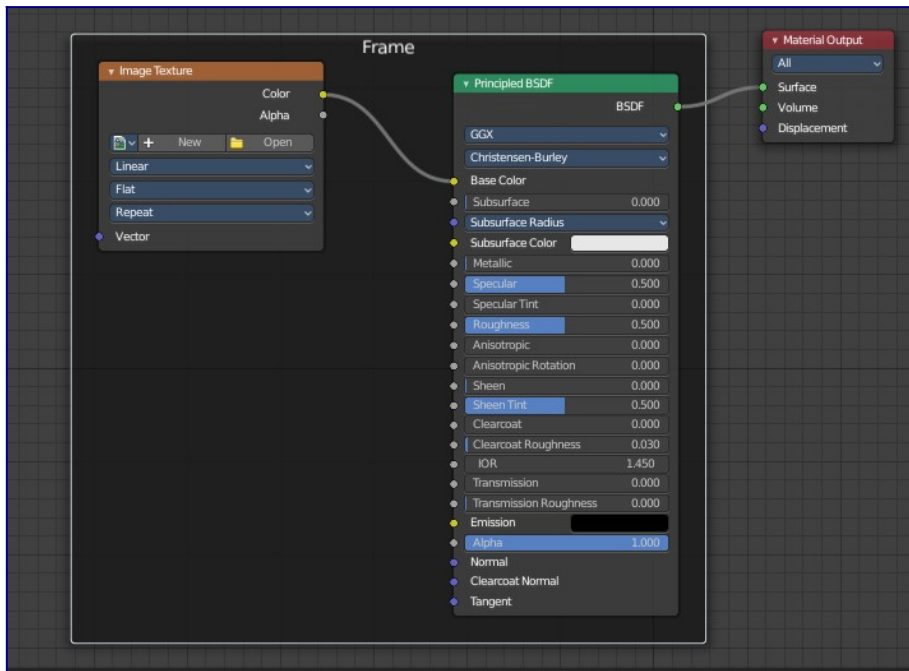
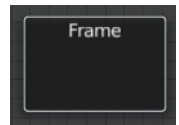

Adding and Removing Nodes

Nodes can be added by simply dropping them onto the frame. Or with the Join in New Frame menu item in the Node menu.

To remove a node from the frame use Remove from Frame.

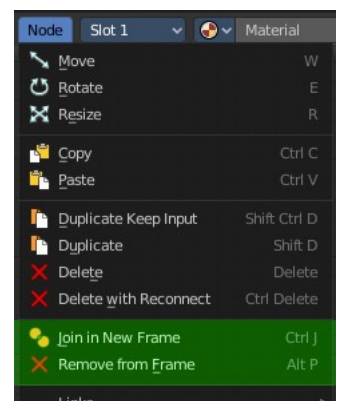

Resizing Frame

When the Frame node is first placed in the node editor workspace you can resize it by dragging one of the edges.

Once a node is placed in the Frame, the Frame shrinks around the nodes. You cannot resize it anymore with handlers. Just by dragging around the nodes inside of the frame.

This behavior can be changed by disabling the *Shrink* option in the Item tab in the Properties panel. Then you can resize the frame again by dragging the edges.

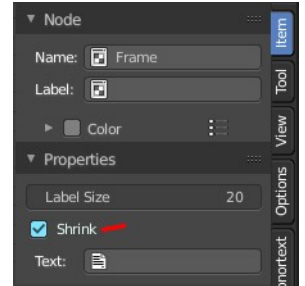

Label and Color

You can change the name of a frame in the Node panel. And you can give it a custom color by checking the Color checkbox and adjusting the color then.

Reroute

Adds a reroute point that can be used to reroute connections. It allows just one input, but allows multiple output connections.

To quickly add a Reroute node into an existing connection, hold Shift and Right Mouse and drag the mouse to cut through the link. A new reroute node will be added.

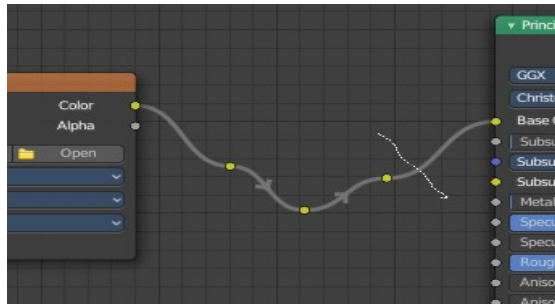
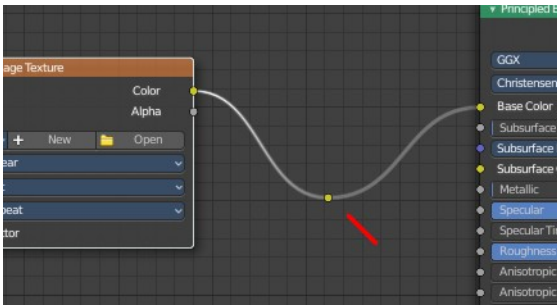

When you exceed a specific angle amount between the reroute nodes, then the node connection becomes a sharp corner, and not longer a Bezier like soft curve.

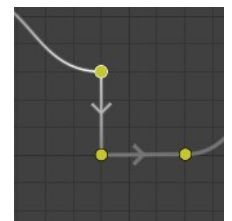

Move, Rotate, Scale

A normal node has a handler. The reroute dot not. You can't simply move it around with the mouse by clicking at the top area. It has none. You have to use the move, rotate and scale commands. They can be found in the View menu.

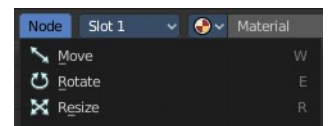



13.1.16 Editors - Shader Editor - Header - Node menu

Table of content

Node menu.....	1
Move.....	1
Rotate.....	1
Resize.....	1
Copy.....	2
Paste.....	2
Duplicate Keep Input.....	2
Duplicate.....	2
Delete.....	2
Delete with Reconnect.....	2
Join new Frame.....	2
Remove from Frame.....	2
Frame Make Parent.....	2
Links.....	3
Make Links.....	3
Make and Replace Links.....	3
Detach Links.....	3
Detach Links Move.....	3
Separate.....	3
Copy.....	3
Move.....	3
Hide / Toggle.....	3
Hide.....	3
Toggle Node Mute.....	4
Toggle Node Preview.....	4
Toggle hidden node sockets.....	4
Toggle Node Options.....	4
Collapse and Hide Unused Sockets.....	4

Node menu

This menu contains further node functionality.

Move

Moves the selected nodes.

Rotate

You can't rotate single nodes, obviously. But when you have more than one selected then you can rotate them around their center point.

Resize

You can't resize single nodes, obviously. But when you have more than one selected

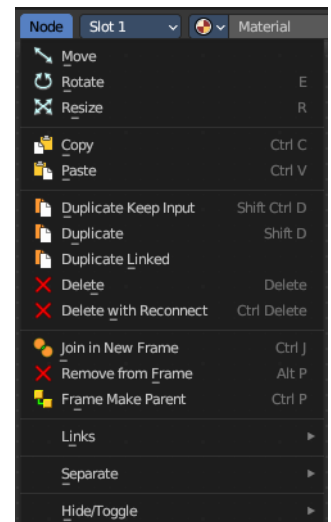

then you can scale them around their center point.

Copy

Copies the selected node(s).

Paste

Pastes the selected node(s).

Duplicate Keep Input

This works at nodes that have a connected input. Duplicating will keep the input connections established in the duplicated node. The output connections will be removed.

Duplicate

Duplicates the selected node(s). All connections will be removed in the duplicated node.

Delete

Deletes the selected node(s).

Delete with Reconnect

Deletes the selected node(s). When this node is in the middle of a connection, then the connections will be reconnected.

Join new Frame

Frame node functionality. Adds the selected node to a frame.

Remove from Frame

Frame node functionality. Removes the selected node from a frame.

Frame Make Parent

Frame node functionality. Adds the selected node to a frame.

Links

Make Links

Tries to connect nodes where it makes sense. For example, the BSDF output of a Principled shader with the Surface input of the Material Output node.

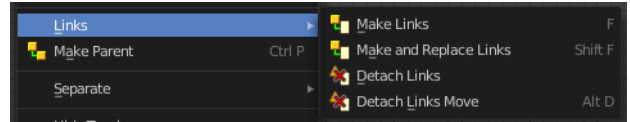

Make and Replace Links

Same as Make Links. But it will replace existing links.

Detach Links

Removes all connections from the selected node, but tries to reconnect the remaining nodes.

Detach Links Move

Removes all connections from the selected node by dragging.

Separate

Node group functionality. You need to be in edit group mode.



Copy

Copies the selected node, and pastes a copy of it outside of the node group. The node group remains unchanged.

Move

Moves the selected to outside of the node group, and removes it from the node group.

Hide / Toggle

Here you find hide options to make the display of nodes more compact.

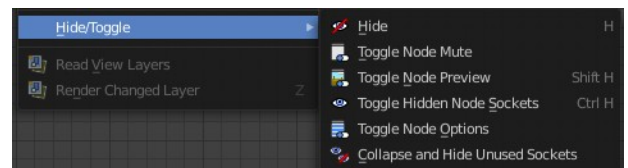

Demonstration happens at an image node.

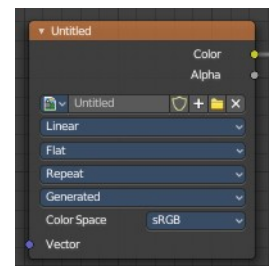

Hide

Hides everything but input and output dots. To view the full node again perform the operator again. It's a toggle. Or click at the triangle left besides the node name.

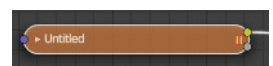

Toggle Node Mute

Deactivates the node.

Toggle Node Preview

This is a compositor feature for the preview image. It does not belong here, but shares the same menu. It shows or hides the preview image.

Toggle hidden node sockets

Toggles away the unused node sockets. In this case the vector input node socket and the alpha output node socket will be hidden.

Toggle Node Options

Hides away the properties.

Collapse and Hide Unused Sockets

Like Hide. Hides everything but the node sockets. But it also hides the unused node sockets.

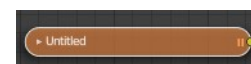
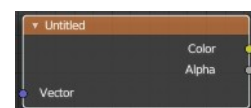
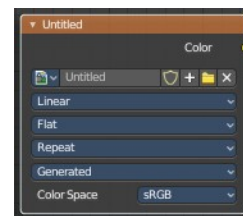
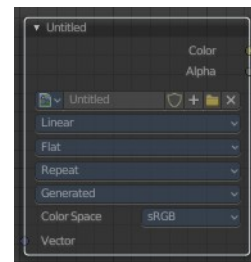



13.1.2 Editors - Shader Editor - Header - Quick Menu

Table of content

- Quick Menu.....1
- Adding an operator to the Quick menu.....1
- Adding a menu to the Quick menu.....1
- Order.....2
- Removing an operator from the Quick menu.....2
- Context and mode dependent content.....2

Quick Menu

The quick menu, or in long Quick Favorites menu, is a menu that can be customized to your needs. Here you can add operators for quick access.

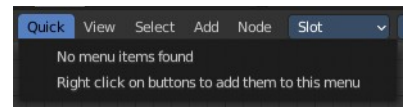

It is located in the header. But it can be called by hotkey Q directly under the mouse. This hotkey works in other editors too.

When the menu is empty, then you will see the message "No Menu Items found". This means that you first have to add some tools to the menu. It is a user configurable menu.

Note that added operators in this menu does not have icons. Just text.

Adding an operator to the Quick menu

Open the panel or the menu where your operator is that you want to add.

Let's add the open command from the File menu. Open the File menu, right click at open, and choose Add to Quick Favorites.

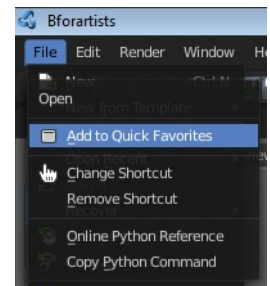

Do the same with Save As. We should now have two new menu items in the Quick menu, which you can use now.

As a rule of thumb, when the right click menu has an Add to Quick Favorites, then you can add it to the quick menu.

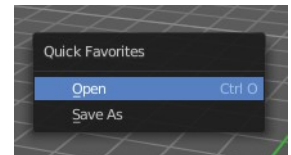

Note that you can also add operators from the tool shelf at the left. And also operators from other editor types. Some other editors have their own quick menu though. The Image Editor for example. These operators gets added in the quick menu of the image editor then. And does not show in the quick menu in the header of the 3D view.

Adding a menu to the Quick menu

It is also possible to add a menu to the Quick menu. For example the whole Add menu. The way is the same. Right click at it, and choose Add to Quick Favorites.

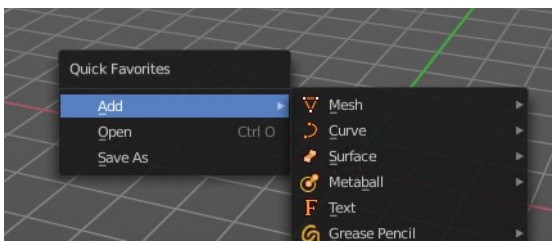
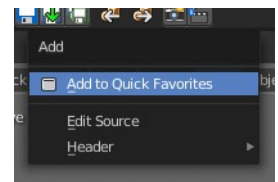

Order

You might notice that the add menu adds at the top of the menu, and not at the bottom as you would expect. First comes menus, then comes operators. And they get added in the order in which you add them.

Besides that, operators and menus gets added in the order that you add them. They cannot be sorted afterwards. So be careful how you add them. You can of course always remove operators and menus, and re-add them at the end of the list.

Removing an operator from the Quick menu

Removing is as simple as adding. Right click at the operators in the Quick menu, and choose Remove from Quick favorites.

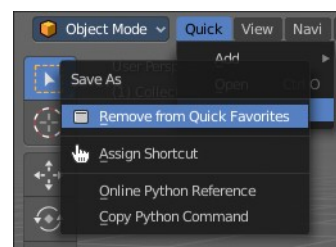

Context and mode dependent content

The quick favorites. menu exists in nearly all editors. But it is just in the 3D view available in the header. So that you know this functionality exists. In the other editors you call it with hotkey Q.

The content of the quick favorites. menu changes, dependent over which editor you are, and in what mode you are. When you add for example an operator from the image editor, then this operator just shows in the quick menu when you call the menu from the image editor. Same goes for the modes. Edit mode tools will just show in edit mode. And so on.



13.1.3 Editors - Shader Editor - Header - View Menu

Table of content

View Menu.....	1
Toolbar.....	1
Sidebar.....	1
Zoom In.....	2
Zoom Out.....	2
Zoom Border.....	2
Frame Selected.....	2
Frame All.....	2
Pie menus.....	2
Area.....	2
Horizontal Split.....	2
Vertical Split.....	2
Duplicate Area into New Window.....	2
Toggle Maximize Area.....	3
Toggle Full screen Area.....	3
Close Area.....	3

View Menu

The View menu contains all View related tools.

The content is the same in all sub modes.

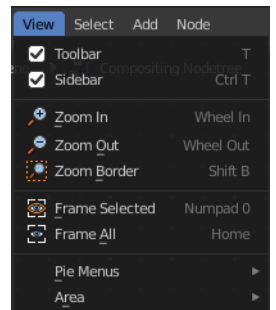

Toolbar

Shows or hides the toolbar at the left.



Sidebar

Shows or hides the sidebar at the right in the viewport.

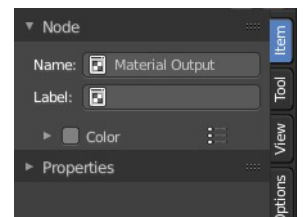

Zoom In

Zooms into the viewport.

Zoom Out

Zooms out of the viewport.

Zoom Border

Draws a rectangle and zooms then to fit the size of this rectangle.

Zooming in is done with drawing the rectangle with left mouse button. Zooming out is done with drawing the rectangle with middle mouse button.

Frame Selected

Zooms to the selection.

Frame All

View all zooms in or out in the viewport until all objects in the scene are displayed fitting in the viewport.

Pie menus

Lists the available pie menus, and gives you the ability to read the hotkeys and assign own hotkeys.



Area

This menu contains general view functionality. And exists in most other editor types too.

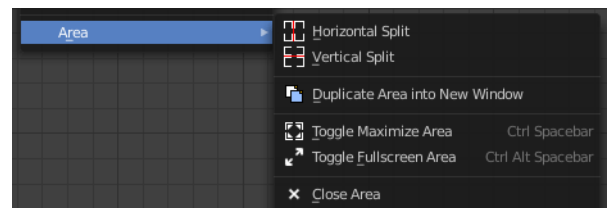

Horizontal Split

Splits the current view horizontally into two independent editor windows.

Vertical Split

Splits the current view vertically into two independent editor windows.

Duplicate Area into New Window

Duplicate Area into New Window makes the selected editor window floating. You can then drag it around at the monitor. It is not connected with the rest of the UI anymore.

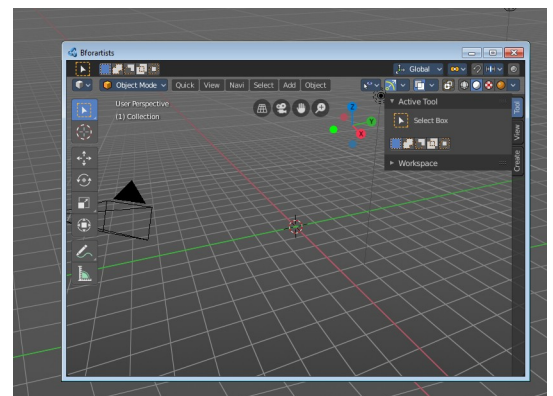

A separated window cannot be merged into the main window again. You have to close it when not longer needed.

Toggle Maximize Area

Displays the editor maximized with menus.

To return from the maximized view press hotkey ctrl + spacebar. Or reuse the menu item in the area menu.

Toggle Full screen Area

Displays the editor maximized without menus.

To return from the full screen view press hotkey ctrl + alt + spacebar.

Close Area

Closes the editor.



13.1.4 Editors - Shader Editor - Header - Select Menu

Table of content

Select menu.....	1
Legacy.....	1
Box select.....	1
Circle select.....	1
Lasso Select.....	2
All.....	2
None.....	2
Inverse.....	2
Linked From.....	2
Linked To.....	2
Grouped.....	2
Grouped Extend.....	2
Activate same type previous.....	2
Activate same type next.....	2
Find Node.....	3

Select menu

Here you will find the select functionality.

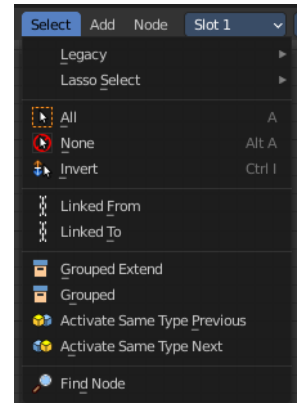

Legacy

The legacy sub menu contains tools that exists in the tool shelf already. It's the old way to do things. Different to the tools in the tool shelf, these tools are usually modal. And performs once. You have to call them again in case you want to repeat the tool.



Box select

Draw a rectangle to select everything inside of the rectangle.

It automatically adds to the current selection. Holding down shift subtracts from the selection.

Circle select

Brush select content. The radius of the brush can be adjusted by holding down left mouse button and using the

scroll wheel or the + or - button at the numpad.

It automatically adds to the current selection. Holding down shift subtracts from the selection. To exit the circle select tool click with the right mouse button.

Lasso Select

A sub menu with the available lasso select modes.

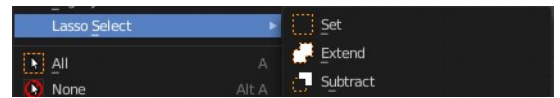

All

Select everything.

None

Select nothing.

Inverse

Invert the current selection.

Linked From

Select the nodes that are linked from the currently selected nodes. The nodes before in the hierarchy.

Linked To

Select the nodes that are linked to the currently selected nodes. The nodes behind in the hierarchy.

Grouped

Select grouped nodes.

Grouped Extend

Select grouped nodes, and extend from the current selection.

Activate same type previous

Activate same node type before the current selection, step by step.

Activate same type next

Activate same node type after the current selection, step by step.

Find Node

This button will open a search dialog where you can search for node types and select them in the current hierarchy.

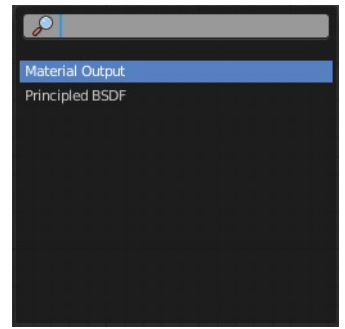



13.1.5 Editors - Shader Editor - Header - Add Menu

Table of content

Add menu.....	1
Add menu - Search.....	1

Add menu

Here you will find all the nodes that you need to create your materials. A click at one of the items will create the node in the workspace at the mouse position right under the menu. It is already selected, and you can drag it around.



Note that the content of the sub menus differs, dependent in which sub mode you are. Objects have different nodes than World or Line Style.

And it differs dependent of which renderer you use. Some nodes just works with specific renderers. They will be marked as such.

Note that you need to have a material selected to activate this content.

Note also that some shaders are real resource hogs, and can slow down rendering times significantly.

Add menu - Search

This is a search menu where you can search for specific node types in all categories.

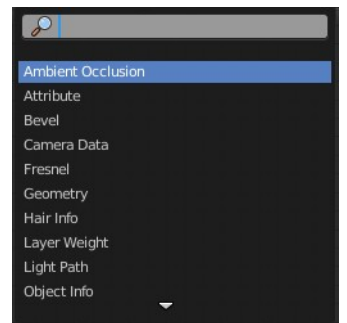



13.1.6 Editors - Shader Editor - Header - Add Menu - Input

Table of content

Detailed table of content.....	1
Add menu - Input.....	5
Ambient Occlusion.....	5
Attribute.....	6
Bevel.....	7
Camera Data.....	7
Fresnel.....	8
Color Attribute.....	8
Geometry.....	9
Curves Info.....	10
Layer Weight.....	10
Light Path.....	11
Object Info.....	12
Particle Info.....	12
Point Info.....	13
RGB.....	14
Tangent.....	14
Texture Coordinate.....	14
UV Along Stroke.....	15
UV Map.....	16
Value.....	16
Volume Info.....	16
Wireframe.....	17

Detailed table of content

Detailed table of content

Detailed table of content.....	1
Add menu - Input.....	5
Ambient Occlusion.....	5
Inputs.....	5
Color.....	5
Distance Cycles Only.....	5
Normal.....	5
Properties.....	5
Samples Cycles Only.....	5
Inside Cycles Only.....	5
Only Local Cycles Only.....	5
Outputs.....	6
Color.....	6
AO.....	6
Attribute.....	6
Properties.....	6
Name.....	6

Outputs.....	6
Color.....	6
Vector.....	6
Factor.....	6
Bevel.....	7
Inputs.....	7
Radius.....	7
Normal.....	7
Properties.....	7
Samples.....	7
Outputs.....	7
Normal.....	7
Camera Data.....	7
Inputs.....	7
Properties.....	7
Outputs.....	7
View Vector.....	7
View Z Depth.....	8
View Distance.....	8
Fresnel.....	8
Inputs.....	8
IOR.....	8
Normal.....	8
Outputs.....	8
Factor.....	8
Color Attribute.....	8
Properties.....	8
Vertex Color.....	8
Outputs.....	8
Color.....	8
Alpha.....	9
Geometry.....	9
Outputs.....	9
Position.....	9
Normal.....	9
Tangent.....	9
True Normal.....	9
Incoming.....	9
Parametric.....	9
Backfacing.....	9
Pointiness Cycles Only.....	9
Random Per Island Cycles Only.....	9
Curves Info.....	10
Outputs.....	10
Is Strand.....	10
Intercept.....	10
Length.....	10
Thickness.....	10
Tangent Normal.....	10
Random.....	10
Layer Weight.....	10
Inputs.....	10
Blend.....	10

Normal.....	10
Outputs.....	10
Fresnel.....	10
Facing.....	11
Light Path.....	11
Outputs.....	11
Is Camera Ray.....	11
Is Shadow Ray.....	11
Is Diffuse Ray.....	11
Is Glossy Ray.....	11
Is Singular Ray Cycles Only.....	11
Is Reflection Ray Cycles Only.....	11
Is Transmission Ray Cycles Only.....	11
Ray Length Cycles Only.....	11
Ray Depth.....	11
Diffuse Depth Cycles Only.....	11
Glossy Depth Cycles Only.....	12
Transparent Depth Cycles Only.....	12
Transmission Depth Cycles Only.....	12
Object Info.....	12
Outputs.....	12
Location.....	12
Color.....	12
Alpha.....	12
Object Index.....	12
Material Index.....	12
Random.....	12
Particle Info.....	12
Outputs.....	13
Index.....	13
Random.....	13
Age.....	13
Lifetime.....	13
Location.....	13
Size.....	13
Velocity.....	13
Angular Velocity.....	13
Point Info.....	13
Outputs.....	13
Position.....	13
Radius.....	13
Random.....	13
RGB.....	14
Properties.....	14
Outputs.....	14
Color / RGBA.....	14
Tangent.....	14
Properties.....	14
Direction Type.....	14
Outputs.....	14
Tangent.....	14
Texture Coordinate.....	14
Properties.....	14

Object.....	14
From Instancer.....	14
Output.....	15
Generated.....	15
Normal.....	15
UV.....	15
Object.....	15
Camera.....	15
Window.....	15
Reflection.....	15
UV Along Stroke.....	15
Properties.....	15
Use Tips.....	15
Outputs.....	16
UV.....	16
UV Map.....	16
Properties.....	16
From Instancer Cycles Only.....	16
UV Map edit box.....	16
Outputs.....	16
UV.....	16
Value.....	16
Properties.....	16
Default Value.....	16
Outputs.....	16
Value.....	16
Volume Info.....	16
Outputs.....	17
Color.....	17
Density.....	17
Flame.....	17
Temperature.....	17
Wireframe.....	17
Inputs.....	17
Size.....	17
Properties.....	17
Pixel Size.....	17
Outputs.....	17
Factor.....	17

Add menu - Input

The Input menu contains Input node types.

The content is the same for all three sub modes. Note that you need to tick Use Nodes to activate the menu items when you are in Line Style sub mode.

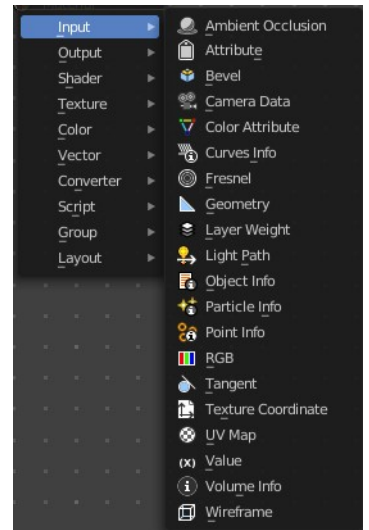

Ambient Occlusion

Ambient Occlusion is a technique to self shadow the geometry of objects. Corners are usually darker than flat areas.

Hint, you should either use Ambient Occlusion or Global Illumination, since GI includes AO techniques.



Inputs

Color

Tint for AO output color.

Distance Cycles Only

Distance up to which other objects are considered to occlude the shading point.

Normal

Normal used for ambient occlusion. If nothing is connected the default shading normal is used.

Properties

Samples Cycles Only

Number of samples to use for ray traced ambient occlusion sampling. Keep as low as possible for an optimal performance.

Inside Cycles Only

Detect convex rather than concave shapes, by computing occlusion inside mesh.

Only Local Cycles Only

Only detect occlusion from the object itself, and not others.

Outputs

Color

Ambient occlusion with color tint.

AO

Ambient occlusion factor without color tint.

Attribute

The Attribute node allows you to retrieve attributes attached to an object or mesh.

Properties

Name

Name of the attribute that you want to use.

Most attributes are easily available. Some not. Examples of not so obvious ones:

Vertex Color Layers can be retrieved this by their names.

Density gives a scalar defining the density of any smoke inside the Fluid Domain.

Color gives the color of the smoke inside the Fluid Domain. The color and vector outputs are the same. The Factor output is an average of the channels.

Temperature gives a scalar defining the temperature of the volume. Values in the range 0 - 1 map to 0 - 1000 kelvin. This may be used to render physically-based fire with the Blackbody or Principled Volume shaders. All three outputs are the same.

Flame gives a scalar defining the density of any fire inside the Fluid Domain. All three outputs are the same.

Ocean Foam gives a scalar defining where foam might appear when using an Ocean Modifier. This depends on the name you give this property.

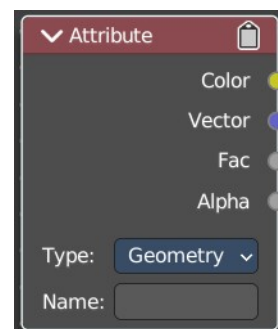

Outputs

Color

RGB color interpolated from the attribute.

Vector

XYZ vector interpolated from the attribute.

Factor

Scalar value interpolated from the attribute.

Bevel

Cycles Only

The Bevel shader node can be used for rendering rounded corners to capture specular highlights. The geometry is not modified. The modification happens at shader level.

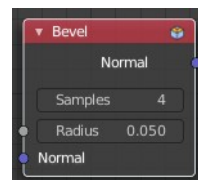

Inputs

Radius

Width of the bevel effect on edges.

Normal

Normal to apply bevel on top of, to be combined with a Bump node for example.

Properties

Samples

Number of samples to take for each shader evaluation. More samples give more accurate results, but are also slower to render. The default value of 4 works well for most cases, with any noise resolved by using more AA samples.

Outputs

Normal

Standard normal output.

Camera Data

With the Camera Data node you can get information about the position of the object relative to the camera. This could be used for example to change the shading of objects further away from the camera, or make custom fog effects.

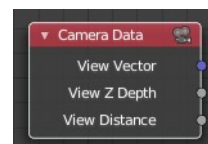

Inputs

This node has no inputs.

Properties

This node has no properties.

Outputs

View Vector

A camera space vector from the camera to the shading point.

View Z Depth

The distance each pixel is away from the camera.

View Distance

Distance from the camera to the shading point.

Fresnel

The Fresnel effect says that the more a face goes towards 180 degrees, the more it is reflecting. With 180 degrees every object in real life is 100% reflective, no matter how the material is.

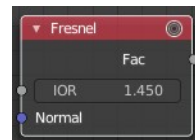

Inputs

IOR

Index of refraction (IOR) of the material being entered.

Normal

Input meant for plugging in bump or normal maps which will affect the output.

Outputs

Factor

Fresnel weight, indicating the probability with which light will reflect off the layer rather than passing through.

Color Attribute

Provides vertex colors as well as their alpha value.

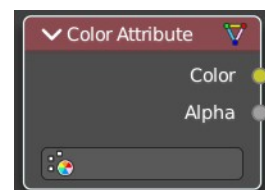

Properties

Vertex Color

The target vertex color. The listed vertex colors are those of the mesh of the active object.

If the active object has no mesh, a warning will be displayed. If the property is marked in red, it means the vertex color is not available in the mesh of the active object, but it may be available in other meshes of objects that share this material.

Outputs

Color

The vertex color.

Alpha

The alpha value.

Geometry

The Geometry node gives geometric information about the current shading point. All vector coordinates are in World Space. For volume shaders, only the position and incoming vector are available.

Outputs

Position

Position of the shading point.

Normal

Shading normal at the surface (includes smooth normals and bump mapping).

Tangent

Tangent at the surface.

True Normal

Geometry or flat normal of the surface.

Incoming

Vector pointing towards the point the shading point is being viewed from.

Parametric

Parametric coordinates of the shading point on the surface. To area lights it outputs its UV coordinates in planar mapping and in spherical coordinates to point lights.

Backfacing

1.0 if the face is being viewed from the back side, 0.0 for the front side.

Pointiness Cycles Only

An approximation of the curvature of the mesh per vertex. Lighter values indicate convex angles, darker values indicate concave angles. It allows you to do effects like dirt maps and wear-off effects.

Random Per Island Cycles Only

A random value for each connected component (island) of the mesh. It is useful to add variations to meshes composed of separated units like tree leaves, wood planks, or curves of multiple splines.

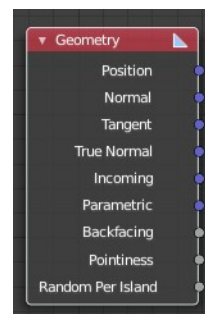

Curves Info

The Hair Info node gives access to Hair information.

Outputs

Is Strand

Returns 1 when the shader is acting on a strand, otherwise 0.

Intercept

The point along the strand where the ray hits the strand (1 at the tip and 0 at the root).

Length

Returns the length of the hair curve.

Thickness

The thickness of the strand at the point where the ray hits the strand.

Tangent Normal

Tangent normal of the strand.

Random

A random per-hair value in the range from 0 to 1. It can for example be used in combination with a color ramp, to randomize the hair color.

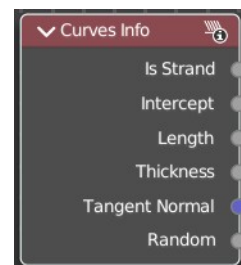

Layer Weight

The Layer Weight node outputs a weight typically used for layering shaders with the Mix Shader node.

Inputs

Blend

Bias the output towards all 0 or all 1. Useful for uneven mixing of shaders.

Normal

Input meant for plugging in bump or normal maps which will affect the output.

Outputs

Fresnel

Dielectric Fresnel weight, useful for example for layering diffuse and glossy shaders to create a plastic material. This is like the Fresnel node, except that the input of this node is in the often more convenient 0.0 to 1.0 range.



Facing

Weight that blends from the first to the second shader as the surface goes from facing the viewer to viewing it at a grazing angle.

Light Path

The Light Path node is used to find out for which kind of incoming ray the shader is being executed. This is useful for non-physically-based tricks.

Outputs

Is Camera Ray

1.0 if shading is executed for a camera ray, 0.0 otherwise.

Is Shadow Ray

1.0 if shading is executed for a shadow ray, 0.0 otherwise.

Is Diffuse Ray

1.0 if shading is executed for a diffuse ray, 0.0 otherwise.

Is Glossy Ray

1.0 if shading is executed for a glossy ray, 0.0 otherwise.

Is Singular Ray Cycles Only

1.0 if shading is executed for a singular ray, 0.0 otherwise.

Is Reflection Ray Cycles Only

1.0 if shading is executed for a reflection ray, 0.0 otherwise.

Is Transmission Ray Cycles Only

1.0 if shading is executed for a transmission ray, 0.0 otherwise.

Ray Length Cycles Only

Distance traveled by the light ray from the last bounce or camera.

Ray Depth

Number of times the ray been reflected or transmitted on interaction with a surface.

Note. Passing through a transparent shader does not count as a normal “bounce”.

Diffuse Depth Cycles Only

Number of times the ray has gone through diffuse reflection or transmission.

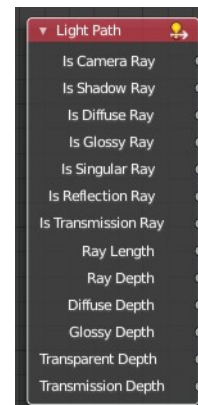

Glossy Depth Cycles Only

Number of times the ray has gone through glossy reflection or transmission.

Transparent Depth Cycles Only

Returns the number of transparent surfaces passed through.

Transmission Depth Cycles Only

Replace a Transmission light path after X bounces with another shader, e.g. a Diffuse one. This can be used to avoid black surfaces, due to low amount of max bounces.

Object Info

The Object Info node gives information about the object instance.

Note that this node only works for material shading nodes; it does nothing for light and world shading nodes.

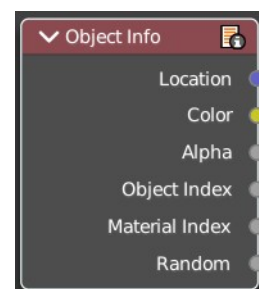

Outputs

Location

Location of the object in world space.

Color

Object color, same as Color in the Properties Editor > Object > Viewport Display.

Alpha

Alpha color for the Object Color, if existing.

Object Index

Object pass index, same as Pass Index in the Properties Editor > Object > Relations.

Material Index

Material pass index, same as Pass Index in the Properties Editor > Material > Settings.

Random

Random number unique to a single object instance.

Particle Info

Cycles Only

This node gives access to the data of the particle that spawned the object instance.

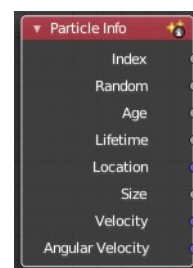

Note that this node currently only supports parent particles. Info from child particles is not available.

Outputs

Index

Index number of the particle (from 0 to number of particles).

Random

A random per-particle value in the range from 0 to 1. It can for example be used in combination with a color ramp, to randomize the particle color.

Age

Age of the particle in frames.

Lifetime

Total lifespan of the particle in frames.

Location

Location of the particle.

Size

Size of the particle.

Velocity

Velocity of the particle.

Angular Velocity

Angular velocity of the particle.

Point Info

Retrieve info from a point cloud. Just cycles. Eevee is not yet supported.

Outputs

Position

The position of the point cloud.

Radius

The radius of the point cloud.

Random

A random point in the point cloud.

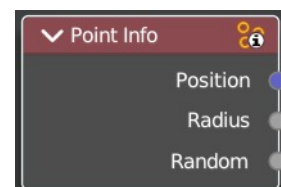

RGB

Set a color.

Properties

The RGB node uses the color picker widget.



Outputs

Color / RGBA

A single RGBA color value.

Tangent

The Tangent node generates a tangent direction for the Anisotropic BSDF.

Properties

Direction Type

The tangent direction can be derived from a cylindrical projection around the X, Y, or Z axis (radial), or from a manually created UV Map for full control.

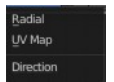
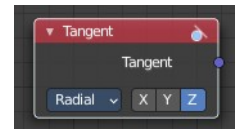

Outputs

Tangent

The tangent direction vector.

Texture Coordinate

Define some texture coordinate types. The types are pretty self explaining.

Properties

Object

Specific object to use for object space coordinates. This only affects the Object output.

From Instancer

Cycles Only!

If the object is generated by instancing from vertices or faces, use texture coordinates from instancer. This only affects the Generated and UV outputs.



Output

Generated

Uses automatically generated texture coordinates, calculated from the bounding box.

Normal

Uses the normals for the texture coordinates.

UV

Uses the UV mapping for the texture coordinates.

Object

Uses the Object for the texture coordinates.

Camera

Uses the position coordinate in camera space for texture coordinates.

Window

Uses the location of shading point on the screen.

Reflection

Uses the direction of the reflection vector as texture coordinates.

UV Along Stroke

Line Style Mode Only

The UV Along Stroke input node maps textures along the stroke length, making it possible to mimic pencil, paintbrush, and other art medium marks.

The pattern type can be set up in the properties editor in the Freestyle Line Style panel in the View Layer Properties tab. Don't forget to turn on Line Style in the Render Properties first. Or the Freestyle panels will not show.

Note! These UV maps become available only during the Freestyle rendering process. This means that the UV Along Stroke node cannot be replaced by the conventional UV Map input node. Since it takes an existing UV map already defined as part of mesh data.

Properties

Use Tips

Allows to use lower quarters of a texture image for the head and tail tips of a stroke, while the upper half for the stroke body.

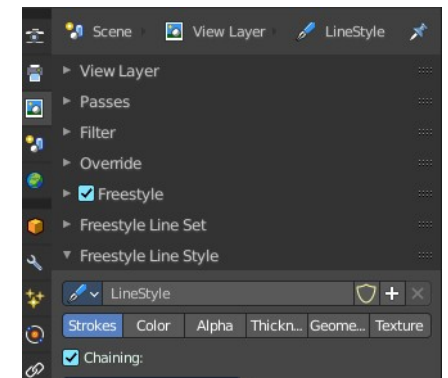
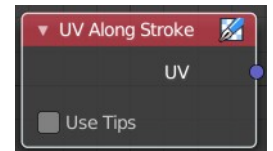

Outputs

UV

UV maps defined along strokes.

UV Map

The UV Map node is used to retrieve specific UV maps. This node can retrieve any UV map that belongs to the object with this material.

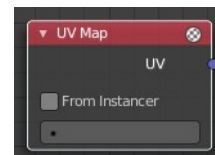

Properties

From Instancer Cycles Only

See the From Instancer option of the Texture Coordinate Node.

UV Map edit box

UV map to use.

Outputs

UV

UV mapping coordinates from the specified UV map.

Value

The Value Node is a simple node to input numerical values to other nodes in the tree.

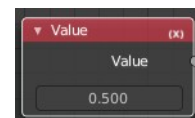

Properties

Default Value

Type in a single numerical value (floating point).

Outputs

Value

The value set in the options.

Volume Info

The Volume Info node provides information about Smoke Domains.



Outputs

Color

Smoke color.

Density

Smoke density.

Flame

Fire density.

Temperature

Temperature of the fire. Values in the range [0, 1] linearly maps to temperatures in the range [0, 1000] in Kelvin.

Wireframe

The Wireframe node is used to retrieve and render the wireframe of the object. This happens as the edges of the object appears to Cycles.

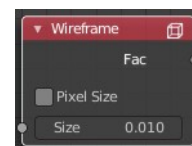

Meshes are triangulated before being processed by Cycles. So the topology will always appear triangulated when viewed with the Wire frame node.

Inputs

Size

The input value used for unconnected socket.

Properties

Pixel Size

When enabled, the size of edge lines is set in screen space.

Outputs

Factor

Black-and-white mask showing white lines representing edges according to the object's topology.



13.1.7 Editors - Shader Editor - Header - Add Menu - Output

Table of content

Detailed table of content.....	1
Add menu - Output.....	3
Material Output.....	3
Light Output.....	4
AOV Output.....	4
World Output.....	5
Line Style Output.....	5

Detailed table of content

Detailed table of content

Detailed table of content.....	1
Add menu - Output.....	3
Material Output.....	3
Inputs.....	3
Surface.....	3
Volume.....	3
Displacement.....	3
Properties.....	4
Target.....	4
Light Output.....	4
Inputs.....	4
Surface.....	4
Properties.....	4
Target.....	4
AOV Output.....	4
Inputs.....	4
Color.....	4
Value.....	4
Properties.....	5
Name.....	5
World Output.....	5
Inputs.....	5
Surface.....	5
Volume.....	5
Note.....	5
Line Style Output.....	5
Inputs.....	5
Color.....	5
Color factor.....	5
Alpha.....	5
Alpha Factor.....	5
Properties.....	6
Blending Mode.....	6

Clamp.....6

Add menu - Output

The output section contains the different output nodes. The content is different for the sub modes Object, World and Line Style. And also for the different renderers

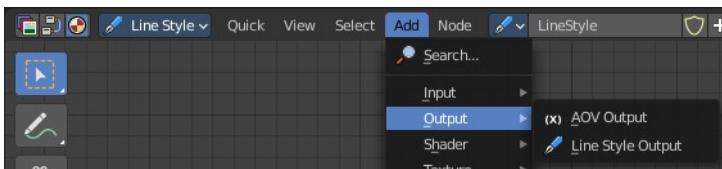
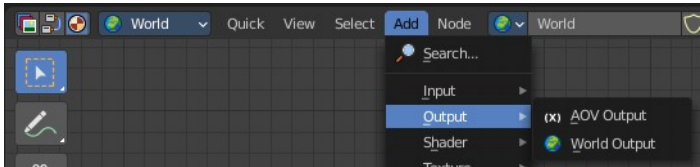
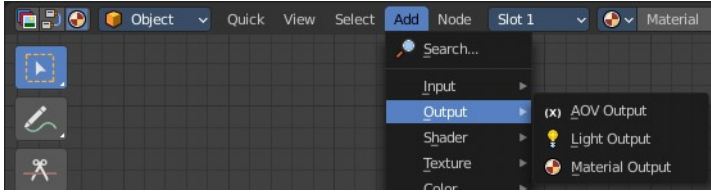

Material Output

The Material Output node is used to output surface material information to a surface object. It is what goes to the render engine then.

Inputs

Surface

Shading for the surface of the object.

Volume

Shading for the volume inside the object.

The types of volume shaders are:

Emission shader.

Volume Absorption shader.

Volume Scatter shader.

Displacement

Used to create bump mapping or actual subdivided displacement.

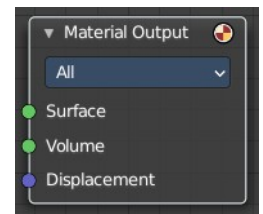

Properties

Target

Choose which renderer the output should go to.

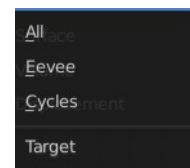

Light Output

Cycles Only

Outputs light information to a light object.

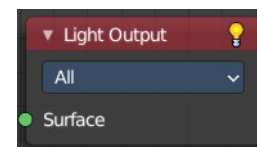

Inputs

Surface

The shading for the surface of the light object.

Properties

Target

What render engine to use. By default shaders are shared between Cycles and Eevee. By using multiple output nodes specialized shader setups can be created for each.

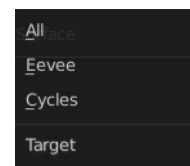

AOV Output

Shader AOVs (Arbitrary Output Variables) provide custom render passes for arbitrary shader node components. As an artist this can be a good way to debug or tweak very fine details of a scene in post processing. To use shader AOVs create the pass in the Shader AOV panel then reference that pass with the AOV Output shading node. Shader AOVs can be added or removed in the Shader AOV panel.

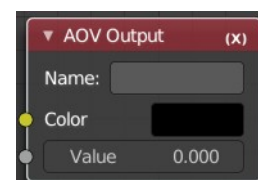

Tip! The AOV Output node can be used in Material and World shader nodes.

Inputs

Color

Output a color variable; as the name suggest can be used for a color but also a normal value.

Value

Output a single numerical value.

Properties

Name

The name of the render pass to assign the input value to. This property is the same Name that is specified in the Shader AOV panel.

World Output

Shader type World. The World Output node is used to output light and color information to the scene's World.

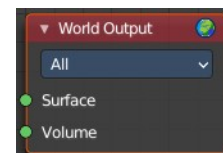

Inputs

Surface

The appearance of the environment, usually preceded by a Background shader.

Volume

Used to add volumetric effects to the world. See the shaders Volume Absorption and Volume Scatter for more information.

Note

It is not possible to have an HDR and volumetric due to the fact that HDR's are assumed to be an infinite distance from the camera.

Line Style Output

Shader Type Line Style

Inputs

Color

The input color.

Color factor

The factor for the color.

Alpha

Alpha channel information.

Alpha Factor

The factor for the alpha channel.

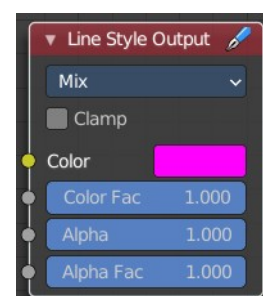

Properties

Blending Mode

Choose the Blending mode.

Clamp

Clamp the result to the range between 0 and 1.



13.1.8 Editors - Shader Editor - Header - Add Menu - Shader

Table of content

Detailed table of content.....	1
Add menu - Shader.....	8
Add Shader.....	8
Anisotropic BSDF.....	9
Background.....	10
Diffuse BSDF.....	10
Emission.....	11
Glass BSDF.....	11
Glossy BSDF.....	12
Hair BSDF.....	13
Holdout.....	14
Mix Shader.....	14
Inputs.....	14
Outputs.....	15
Principled BSDF.....	15
Principled Hair BSDF.....	18
Principled Volume.....	25
Refraction BSDF.....	26
Specular BSDF.....	27
Subsurface Scattering.....	29
Toon BSDF.....	30
Translucent BSDF.....	31
Transparent BSDF.....	31
Sheen BSDF.....	32
Volume Absorption.....	33
Volume Scatter.....	33

Detailed table of content

Detailed table of content

Detailed table of content.....	1
Add menu - Shader.....	8
Add Shader.....	8
Inputs.....	8
Shaders.....	8
Outputs.....	9
Shader.....	9
Anisotropic BSDF.....	9
Inputs.....	9
Color.....	9
Roughness.....	9
Anisotropy.....	9
Rotation.....	9
Normal.....	9

Tangent.....	9
Properties.....	9
Distribution.....	9
Outputs.....	10
BSDF.....	10
Background.....	10
Inputs.....	10
Color.....	10
Strength.....	10
Outputs.....	10
Background.....	10
Diffuse BSDF.....	10
Inputs.....	10
Color.....	10
Roughness Cycles Only.....	10
Normal.....	10
Outputs.....	10
BSDF.....	10
Emission.....	11
Inputs.....	11
Color.....	11
Strength.....	11
Outputs.....	11
Emission.....	11
Glass BSDF.....	11
Inputs.....	11
Color.....	11
Roughness.....	11
IOR.....	11
Normal.....	11
Properties.....	11
Distribution.....	11
Sharp.....	11
GGX.....	11
Multiple-scattering GGX.....	12
Beckmann.....	12
Ashikhmin-Shirley.....	12
Outputs.....	12
BSDF.....	12
Glossy BSDF.....	12
Inputs.....	12
Color.....	12
Roughness.....	12
Normal.....	12
Properties.....	12
Distribution.....	12
Sharp.....	12
Beckmann.....	12
GGX.....	13
Ashikhmin-Shirley.....	13
Multiple-scattering GGX.....	13
Outputs.....	13
BSDF.....	13

Hair BSDF.....	13
Inputs.....	13
Color.....	13
Offset.....	13
Roughness U/V.....	13
Tangent.....	13
Properties.....	13
Component.....	13
Reflection.....	14
Transmission.....	14
Outputs.....	14
BSDF.....	14
Holdout.....	14
Outputs.....	14
Holdout.....	14
Mix Shader.....	14
Inputs.....	14
Shader.....	14
Factor.....	14
Outputs.....	15
Shader.....	15
Principled BSDF.....	15
Inputs.....	15
Base Color.....	15
Subsurface.....	15
Subsurface Radius.....	15
Subsurface Color.....	15
Metallic.....	15
Specular.....	16
Specular Tint.....	16
Roughness.....	16
Anisotropic.....	16
Anisotropic Rotation.....	16
Sheen.....	16
Sheen Tint.....	16
Clear coat.....	17
Clear coat Roughness.....	17
IOR.....	17
Transmission.....	17
Transmission Roughness.....	17
Emission.....	17
Emission Strength.....	17
Alpha.....	17
Normal.....	17
Clear coat Normal.....	17
Tangent.....	17
Properties.....	17
GGX.....	17
Multiple-scattering GGX.....	17
Subsurface Method.....	18
Christensen-Burley.....	18
Random Walk.....	18
Outputs.....	18

BSDF.....	18
Principled Hair BSDF.....	18
Properties.....	18
Scattering Mode.....	18
Chiang Model versus Huang Model.....	18
Color Parametrization.....	18
Inputs.....	19
Huang - Absorption coefficient.....	19
Absorption Coefficient.....	19
Aspect Ratio.....	19
Roughness.....	19
IOR.....	19
Offset.....	19
Random Roughness.....	19
Random.....	19
Reflection.....	19
Transmission.....	19
Secondary Reflection.....	19
Huang - Melanin concentration.....	20
Melanin.....	20
Melanin Redness.....	20
Tint.....	20
IOR.....	20
Offset.....	20
Random Color.....	21
Random Roughness.....	21
Reflection.....	21
Transmission.....	21
Secondary Reflection.....	21
Huang - Direct Coloring.....	21
Aspect Ratio.....	21
Roughness.....	21
IOR.....	21
Offset.....	21
Random Roughness.....	22
Reflection.....	22
Transmission.....	22
Secondary Reflection.....	22
Chiang - Absorption coefficient.....	22
Absorption Coefficient.....	22
Roughness.....	22
Radial Roughness.....	22
Coat.....	22
IOR.....	22
Offset.....	23
Random Roughness.....	23
Random.....	23
Chiang - Melanin concentration.....	23
Melanin.....	23
Melanin Redness.....	23
Tint.....	23
Roughness.....	24
Radial Roughness.....	24

Coat.....	24
IOR.....	24
Offset.....	24
Random Color.....	24
Random Roughness.....	24
Chiang - Direct Coloring.....	24
Color.....	24
Roughness.....	25
Radial Roughness.....	25
Coat.....	25
IOR.....	25
Offset.....	25
Random Roughness.....	25
Outputs.....	25
BSDF.....	25
Principled Volume.....	25
Inputs.....	25
Color.....	25
Color Attribute.....	25
Density.....	26
Density Attribute.....	26
Anisotropy.....	26
Absorption Color.....	26
Emission Strength.....	26
Emission Color.....	26
Blackbody Intensity.....	26
Blackbody Tint.....	26
Temperature.....	26
Temperature Attribute.....	26
Outputs.....	26
Volume.....	26
Refraction BSDF.....	26
Inputs.....	27
Color.....	27
Roughness.....	27
Normal.....	27
Properties.....	27
Distribution.....	27
Outputs.....	27
BSDF.....	27
Specular BSDF.....	27
Inputs.....	27
Base Color.....	27
Specular Color.....	27
Roughness.....	28
Emissive Color.....	28
Transparency.....	28
Normal.....	28
Clear coat.....	28
Clear coat Roughness.....	28
Clear coat Normal.....	28
Ambient Occlusion.....	28
Outputs.....	28

BSDF.....	28
Subsurface Scattering.....	29
Inputs.....	29
Color.....	29
Scale.....	29
Radius.....	29
Sharpness.....	29
Normal.....	29
Texture Blur.....	29
Properties.....	29
Falloff Method.....	29
Christensen-Burley.....	30
Random Walk.....	30
Cubic.....	30
Gaussian.....	30
Outputs.....	30
BSSRDF.....	30
Toon BSDF.....	30
Inputs.....	30
Color.....	30
Size.....	30
Smooth.....	30
Normal.....	31
Properties.....	31
Component.....	31
Diffuse.....	31
Glossy.....	31
Outputs.....	31
BSDF.....	31
Translucent BSDF.....	31
Inputs.....	31
Color.....	31
Normal.....	31
Outputs.....	31
BSDF output.....	31
Transparent BSDF.....	31
Inputs.....	32
Color.....	32
Outputs.....	32
BSDF.....	32
Sheen BSDF.....	32
Inputs.....	32
Color.....	32
Sigma.....	32
Normal.....	32
Properties.....	32
Distribution.....	32
Outputs.....	32
BSDF.....	32
Volume Absorption.....	33
Inputs.....	33
Color.....	33
Density.....	33

Outputs.....	33
Volume.....	33
Volume Scatter.....	33
Inputs.....	33
Color.....	33
Density.....	33
Anisotropy.....	33
Output.....	33
Volume.....	33

Add menu - Shader

The shader section contains the different shader nodes. The content is different for the sub modes Object, World and Line Style. And it is dependant of the chosen render engine.

Left Eevee, right Cycles:

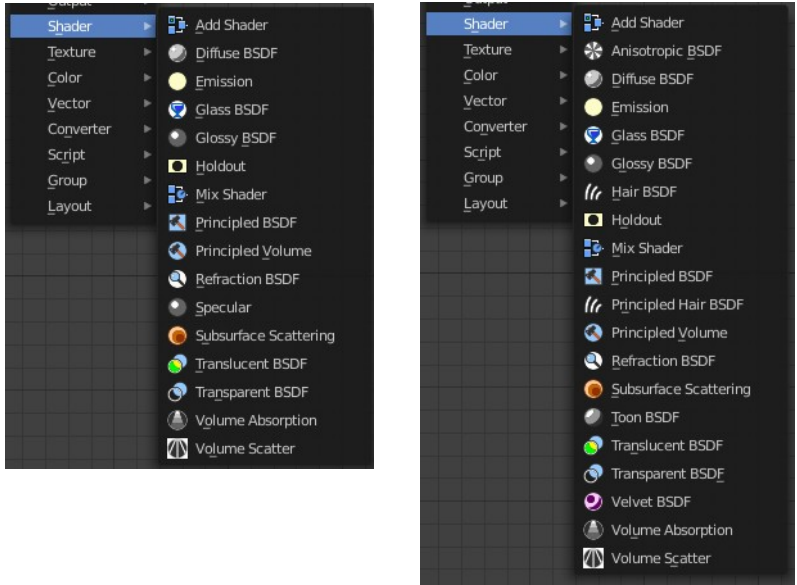

World / Line Art :

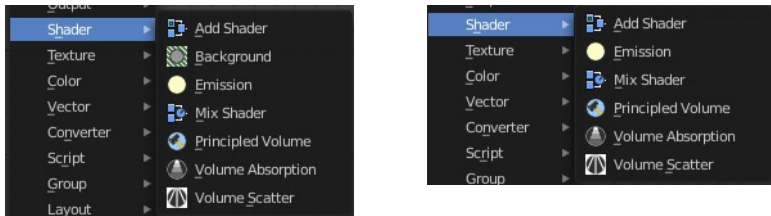

Add Shader

The Add node is used to add two Shaders together.

Inputs

Shaders

Standard shader inputs.

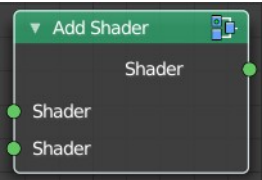

Outputs

Shader

Standard shader output.

Anisotropic BSDF

Cycles Only

Adds a glossy reflection. The U and V direction roughness can be controlled separately. The tangents used for shading are derived from the active UV map. If no UV map is available, they are automatically generated using a sphere mapping based on the mesh bounding box.

Inputs

Color

Color of the surface, or physically speaking, the probability that light is reflected for each wavelength.

Roughness

Sharpness of the reflection; perfectly sharp at 0.0 and smoother with higher values.

Anisotropy

Amount of anisotropy in the reflection; 0.0 gives a round highlight. Higher values give elongated highlights orthogonal to the tangent direction; negative values give highlights shaped along the tangent direction.

Rotation

Rotation of the anisotropic tangent direction. Value 0.0 equals 0° rotation, 0.25 equals 90° and 1.0 equals 360° = 0°. This can be used to texture the tangent direction.

Normal

Normal used for shading; if nothing is connected the default shading normal is used.

Tangent

Tangent used for shading; if nothing is connected the default shading tangent is used.

Properties

Distribution

The available Microfacet distribution methods. Beckmann, GGX and Ashikhmin-Shirley can use the Roughness input for blurry reflections.

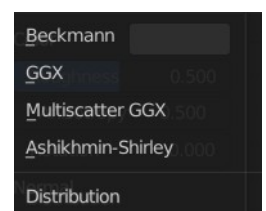
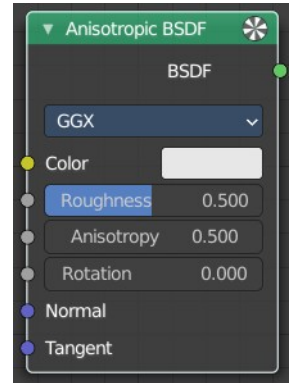

Outputs

BSDF

Standard shader output.

Background

Shader Type World

The Background shader node is used to add background light emission.

Inputs

Color

Color of the emitted light.

Strength

Strength of the emitted light.

Outputs

Background

Standard shader output.

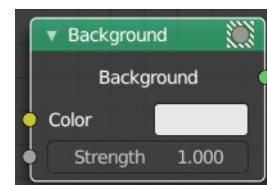

Diffuse BSDF

Shader Type Object

The Diffuse BSDF node is used to add Lambertian and Oren-Nayar diffuse reflection.

Inputs

Color

Color of the surface, or physically speaking, the probability that light is reflected or transmitted for each wavelength.

Roughness Cycles Only

Surface roughness; 0.0 gives standard Lambertian reflection, higher values activate the Oren-Nayar BSDF.

Normal

Normal used for shading; if nothing is connected the default shading normal is used.

Outputs

BSDF

Standard shader output.

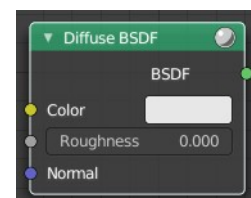

Emission

The Emission node emits light.

Inputs

Color

Color of the emitted light.

Strength

Strength of the emitted light. For point and area lights, the unit is Watts. For materials, a value of 1.0 will ensure that the object in the image has the exact same color as the Color input, i.e. make it 'shadeless'.

Outputs

Emission

The Emission shader output can both be plugged into the Surface Input as well as the Volume Input of the Material Output node.

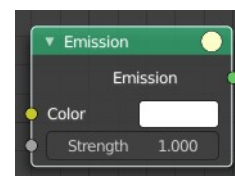

Glass BSDF

A glass shader.

Inputs

Color

Color of the surface, or physically speaking, the probability that light is transmitted for each wavelength.

Roughness

Influences sharpness of the refraction; perfectly sharp at 0.0 and smoother with higher values.

IOR

Index of refraction (IOR) defining how much the ray changes direction. At 1.0 rays pass straight through like transparent; higher values give more refraction.

Normal

Normal used for shading.

Properties

Distribution

The micro facet distribution method to use.

Sharp

Results in perfectly sharp reflections like a mirror. The Roughness value is not used.

GGX

GGX micro facet distribution.

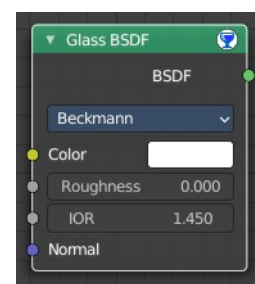

Multiple-scattering GGX

Cycles Only

Takes multiple bounce (scattering) events between micro facets into account. This gives a more energy conserving results, which would otherwise be visible as excessive darkening.

Beckmann

Cycles Only

Beckmann micro facet distribution.

Ashikhmin-Shirley

Cycles Only

Ashikhmin-Shirley micro facet distribution.

Outputs

BSDF

Standard shader output.

Glossy BSDF

Object sub mode only

The Glossy BSDF node is used to add reflection with micro facet distribution, used for materials such as metal or mirrors.

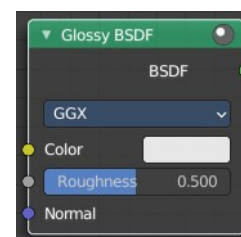

Inputs

Color

Color of the surface, or physically speaking, the probability that light is reflected for each wavelength.

Roughness

Input for the surface roughness resulting in sharp to blurry reflections.

Normal

Normal used for shading.

Properties

Distribution

Micro facet distribution to use.

Sharp

Results in perfectly sharp reflections like a mirror. The Roughness value is not used.

Beckmann

Cycles Only

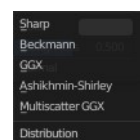

Beckmann micro facet distribution.

GGX

GGX micro facet distribution.

Ashikhmin-Shirley

Cycles Only

Ashikhmin-Shirley micro facet distribution.

Multiple-scattering GGX

Cycles Only

Takes multiple bounce (scattering) events between micro facets into account. This gives a more energy conserving results, which would otherwise be visible as excessive darkening.

Outputs

BSDF

Standard shader output.

Hair BSDF

Cycles Only

The Hair BSDF node is used to add shading for Hair.

Inputs

Color

Color of the hair.

Offset

Controls the way the light is rotated (angular shift) for the reflection/transmission.

Roughness U/V

Controls the roughness in the direction light is skewed, and perpendicular to it.

Tangent

Input tangent.

Properties

Component

There are two components that can be used to control the look of the hair. Usually you are going to want each of these and use a Mix Node.

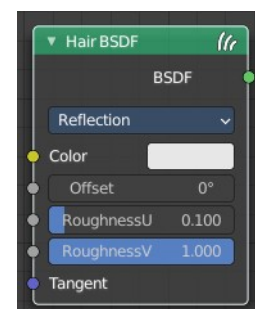

Reflection

The light that bounces off the surface of the hair.

Transmission

The light that passes through the hair and comes out the other side.

Outputs

BSDF

Standard shader output.

Holdout

The Holdout shader node is used to create a “hole” in the image with zero alpha transparency, which is useful for compositing (see alpha channel).

Note that the holdout shader can only create alpha when Transparent is enabled. This can be found in the render settings. Properties > Render > Film > Transparent is enabled. If it is disabled, the holdout shader will be black.

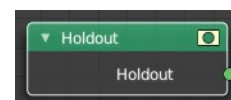

Outputs

Holdout

Standard shader output.

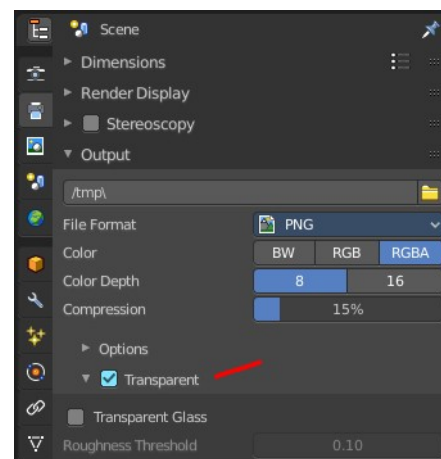

Mix Shader

The Mix node is used to mix two shaders together. Mixing can be used for material layering, where the Factor input may, for example, be connected to a Blend Weight node.



Inputs

Shader

Shaders to mix, such that incoming rays hit either with the specified probability in the Factor socket.

Factor

Blend weight to use for mixing two shaders; at zero it uses the first shader entirely and at one the second shader.

Outputs

Shader

Standard shader output.

Principled BSDF

The Principled BSDF that combines multiple shader layers into a single easy to use node. It is based on the Disney principled model also known as the “PBR” shader, making it compatible with other software such as Pixar’s Renderman® and Unreal Engine®. Image textures painted or baked from software like Substance Painter® may be directly linked to the corresponding parameters in this shader.

This “Uber” shader includes multiple layers to create a wide variety of materials. The base layer is a user controlled mix between diffuse, metal, subsurface scattering and transmission. On top of that there is a specular layer, sheen layer and clear coat layer.

Note! The emphasis on compatibility with other software means that it interprets certain input parameters differently from older Blender nodes.

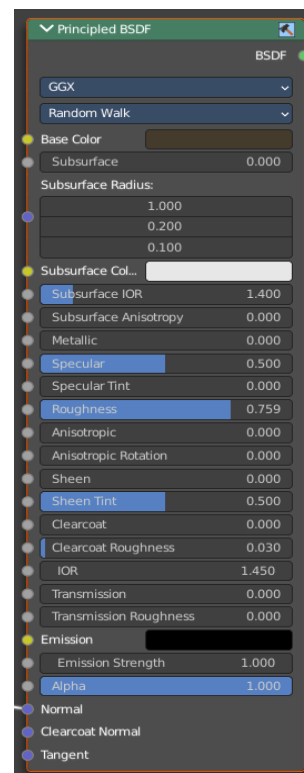

Inputs

Base Color

Diffuse or metal surface color.

Subsurface

Mix between diffuse and subsurface scattering. Rather than being a simple mix between Diffuse and Subsurface Scattering, it acts as a multiplier for the Subsurface Radius.

Subsurface Radius

Average distance that light scatters below the surface. Higher radius gives a softer appearance, as light bleeds into shadows and through the object. The scattering distance is specified separately for the RGB channels, to render materials such as skin where red light scatters deeper. The X, Y and Z values are mapped to the R, G and B values, respectively.

Subsurface Color

Subsurface scattering base color.

Metallic

Blends between a non-metallic and metallic material model. A value of 1.0 gives a fully specular reflection tinted with the base color, without diffuse reflection or transmission. At 0.0 the material consists of a diffuse or

transmissive base layer, with a specular reflection layer on top.

Specular

Amount of dielectric specular reflection. Specifies facing (along normal) reflectivity in the most common 0 - 8% range.

Hint. To compute this value for a realistic material with a known index of refraction, you may use this special case of the Fresnel formula: $\text{specular} = ((\text{ior}-1)/(\text{ior}+1))^2/0.08$

For example:

water: ior = 1.33, specular = 0.25

glass: ior = 1.5, specular = 0.5

diamond: ior = 2.417, specular = 2.15

Since materials with reflectivity above 8% do exist, the field allows values above 1.

Specular Tint

Tints the facing specular reflection using the base color, while glancing reflection remains white.

Normal dielectrics have colorless reflection, so this parameter is not technically physically correct and is provided for faking the appearance of materials with complex surface structure.

Roughness

Specifies micro facet roughness of the surface for diffuse and specular reflection.

Hint. When converting from the older Glossy BSDF node, use the square root of the original value.

Anisotropic

Cycles Only

Amount of anisotropy for specular reflection. Higher values give elongated highlights along the tangent direction; negative values give highlights shaped perpendicular to the tangent direction.

Anisotropic Rotation

Cycles Only

Rotates the direction of anisotropy, with 1.0 going full circle.

Hint. Compared to the Anisotropic BSDF node, the direction of highlight elongation is rotated by 90°. Add 0.25 to the value to correct.

Sheen

Amount of soft velvet like reflection near edges, for simulating materials such as cloth.

Sheen Tint

Mix between white and using base color for sheen reflection.

Clear coat

Extra white specular layer on top of others. This is useful for materials like car paint and the like.

Clear coat Roughness

Roughness of clear coat specular.

IOR

Index of refraction for transmission.

Transmission

Mix between fully opaque surface at zero and fully glass like transmission at one.

Transmission Roughness

Cycles Only

With GGX distribution controls roughness used for transmitted light.

Emission

Light emission from the surface, like the Emission shader.

Emission Strength

The strength of the light emission.

Alpha

Controls the transparency of the surface, with 1.0 fully opaque. Usually linked to the Alpha output of an Image Texture node.

Normal

Controls the normals of the base layers.

Clear coat Normal

Controls the normals of the Clear coat layer.

Tangent

Controls the tangent for the Anisotropic layer.

Properties

Distribution

Micro facet distribution to use.

GGX

A method that is faster than Multiple-scattering GGX but is less physically accurate. Selecting it enables the Transmission Roughness input.

Multiple-scattering GGX

Takes multiple bounce (scattering) events between micro facets into account. This gives a more energy conserving results, which would otherwise be visible as excessive darkening.



Subsurface Method

Rendering method to simulate subsurface scattering.

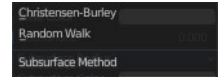

Christensen-Burley

Is an approximation to physically-based volume scattering. Gives less blurry results than Cubic and Gaussian functions.

Random Walk

Provides the most accurate results for thin and curved objects. This comes at the cost of increased render time or noise for more dense media like skin, but also better geometry detail preservation. Random Walk uses true volumetric scattering inside the mesh, which means that it works best for closed meshes. Overlapping faces and holes in the mesh can cause problems.

Outputs

BSDF

Standard shader output.

Principled Hair BSDF

Cycles Only

The Principled Hair BSDF is a physically-based, easy-to-use shader for rendering hair and fur.

Properties

Scattering Mode

Chiang Model versus Huang Model

There are two scattering models available. Chiang and Huang. Chiang is the older model, with a less accurate result. Huang the newer model. The available options differs from model to model.

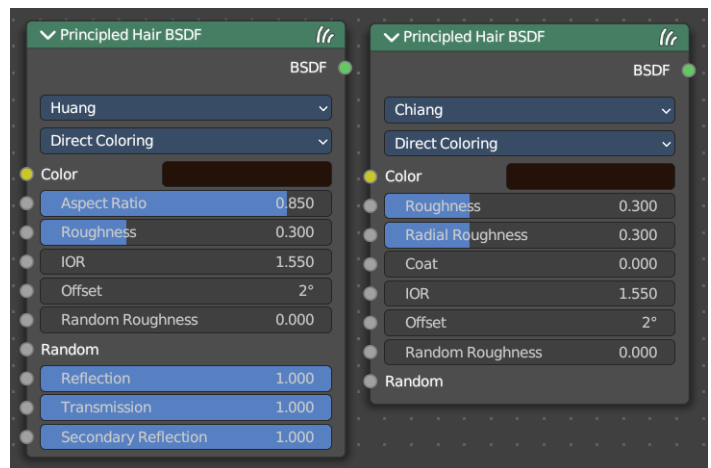
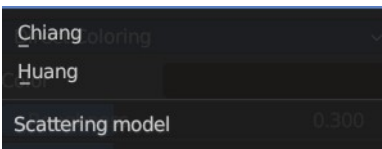

Color Parametrization

The shader provides three different ways, or parametrizations, to color the hair strands. Direct coloring, Melanin concentration and Absorption coefficient. They have some different settings and inputs.

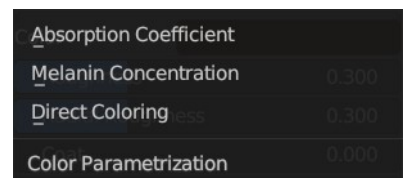

Inputs

Huang - Absorption coefficient

Specifies the attenuation coefficient s_a , as applied by the Beer-Lambert law. This mode is intended mainly for technical users who want to use coefficients from the literature without any sort of conversion.

Absorption Coefficient

Specifies the light absorption per unit length as the light passes through the value. A higher value leads to a darker color. The absorption coefficient is a vector $\vec{3}$.

Aspect Ratio

For elliptical hair cross-section the aspect ratio is the ratio of the minor axis to the major axis. The major axis is aligned with the curve normal.

Recommended values are 0.8 to 1 for asian hair, 0.654 to 0.9 for caucasian hair and 0.5 to 0.65 for african hair. Set it to 1 for a circular cross section.

Roughness

The hair roughness. A lower value leads to a metallic look.

IOR

Refraction coefficient. The default value of 1.550 is the refraction coefficient of melanin.

Offset

The tilt angle of the cuticle scales. That'st the outermost part of the hair. They are always tilted towards the hair root. Human hair has a value between 2 and 4.

Random Roughness

Adds a random roughness to each strand.

Random

Add a random input value.

Reflection

Optional factor for modulating the first light bounce off the hair surface. The color of this component is always white. Keep it 1.0 for physical correctness.

Transmission

Optional factor for modulating the transmission component. The color of this component is always white. Keep it 1.0 for physical correctness.

Secondary Reflection

Optional factor for modulating the component which is transmitted into the hair, reflected off the backside of

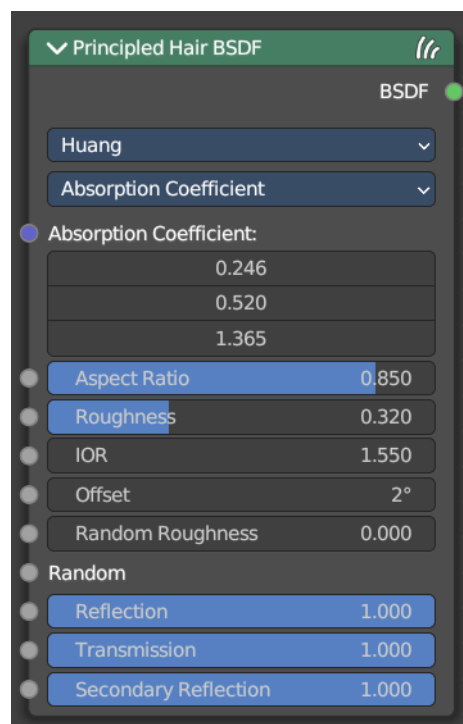

the hair and then transmitted out of the hair. This component is oriented approximately around the incoming direction, and picks up the color of the pigment inside the hair. Keep this 1.0 for physical correctness.

Huang - Melanin concentration

This mode defines the color as the quantity and ratio of the pigments which are commonly found in hair and fur, eumelanin (prevalent in brown-black hair) and pheomelanin (red hair). The quantity is specified in the Melanin input, and the ratio between them in Melanin Redness. Increasing concentrations darken the hair (the following are with Melanin Redness 1):

White (Melanin 0), Blonde (Melanin 0.25), Reddish (Melanin 0.5), Brown (Melanin 0.75), Black (Melanin 1)

Additionally, the Tint inputs allows to dye the hair with the desired color.

Melanin

Absolute quantity of pigment. Range [0,1] equivalent to [0%,100%].

Hint. This is a linear mapping to the underlying exponential function: $\text{melanin_qty} = -\ln(\max(1.0 - \text{Melanin}, 0.0001))$

Melanin Redness

Ratio of pheomelanin to eumelanin. Range [0,1] equivalent to [0%,100%].

Hint. The ratio formula is: $\text{eumelanin} = \text{Melanin} * (1.0 - \text{MelaninRedness})$, $\text{pheomelanin} = \text{Melanin} * \text{MelaninRedness}$.

The resulting quantities are converted (after randomization, if specified) to absorption concentration via the following formula (section 6.1 of [EFHLA11], adjusted for the range [0,1]): $\text{sa} = \text{eumelanin} * (0.5060.8411.653 + \text{pheomelanin} * (0.3430.7331.924))$

Tint

Color used for dyeing the hair after applying the melanin pigment. It is not subject to randomization. It can be disabled by setting the color to white.

Hint. This is converted via the Color mapping above and added to the absorption coefficient of the melanin concentration.

IOR

Refraction coefficient. The default value of 1.550 is the refraction coefficient of melanin.

Offset

The tilt angle of the cuticle scales. That'st the outermost part of the hair. They are always tilted towards the hair root. Human hair has a value between 2 and 4.

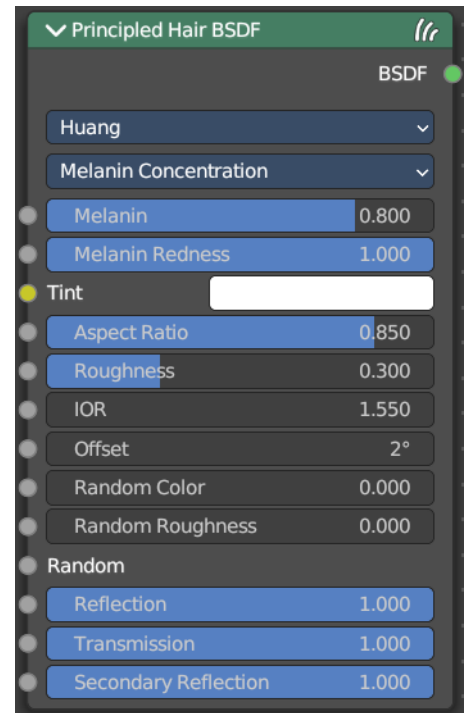

Random Color

For each strand, vary the melanin concentration by RandomFactor. Range [0,1] equivalent to [0%,100%] of the initial melanin concentration.

Hint. The melanin concentration is multiplied by randomFactor, where $\text{randomFactor} = 1.0 + 2.0 * (\text{Random} - 0.5) * \text{RandomColor}$.

Random Roughness

Adds a random roughness to each strand.

Reflection

Optional factor for modulating the first light bounce off the hair surface. The color of this component is always white. Keep it 1.0 for physical correctness.

Transmission

Optional factor for modulating the transmission component. The color of this component is always white. Keep it 1.0 for physical correctness.

Secondary Reflection

Optional factor for modulating the component which is transmitted into the hair, reflected off the backside of the hair and then transmitted out of the hair. This component is oriented approximately around the incoming direction, and picks up the color of the pigment inside the hair. Keep this 1.0 for physical correctness.

Huang - Direct Coloring

Choose the desired RGB color and the shader will approximate the necessary absorption coefficient (below).

Aspect Ratio

For elliptical hair cross-section the aspect ratio is the ratio of the minor axis to the major axis. The major axis is aligned with the curve normal.

Recommended values are 0.8 to 1 for asian hair, 0.654 to 0.9 for caucasian hair and 0.5 to 0.65 for african hair. Set it to 1 for a circular cross section.

Roughness

The hair roughness. A lower value leads to a metallic look.

IOR

Refraction coefficient. The default value of 1.550 is the refraction coefficient of melanin.

Offset

The tilt angle of the cuticle scales. That'st the outermost part of the hair. They are always tilted towards the hair root. Human hair has a value between 2 and 4.

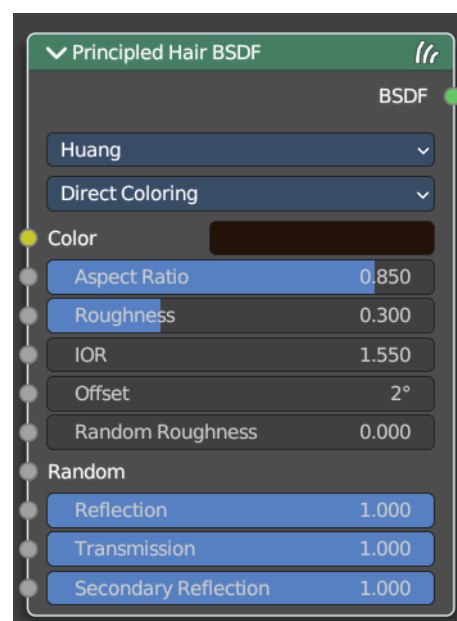

Random Roughness

Adds a random roughness to each strand.

Reflection

Optional factor for modulating the first light bounce off the hair surface. The color of this component is always white. Keep it 1.0 for physical correctness.

Transmission

Optional factor for modulating the transmission component. The color of this component is always white. Keep it 1.0 for physical correctness.

Secondary Reflection

Optional factor for modulating the component which is transmitted into the hair, reflected off the backside of the hair and then transmitted out of the hair. This component is oriented approximately around the incoming direction, and picks up the color of the pigment inside the hair. Keep this 1.0 for physical correctness.

Chiang - Absorption coefficient

Specifies the attenuation coefficient s_a , as applied by the Beer-Lambert law. This mode is intended mainly for technical users who want to use coefficients from the literature without any sort of conversion.

Absorption Coefficient

Specifies the light absorption per unit length as the light passes through the value. A higher value leads to a darker color. The absorption coefficient is a vector 3.

Roughness

The hair roughness. A lower value leads to a metallic look.

Radial Roughness

Specify how much the glints are smoothed in the direction of the hair tangent. Too low values will concentrate the glint; while setting it too high will spread the light across the width of the strand.

Hint. Mathematically, this parameter is mapped to the logistic distribution's scale factor s (section 4.1 of [CBTB16]).

Coat

Simulate a shiny coat by reducing the roughness to the given factor only for the first light bounce (diffuse). Range [0, 1] is equivalent to a reduction of [0%, 100%] of the original roughness."

IOR

Refraction coefficient. The default value of 1.550 is the refraction coefficient of melanin.

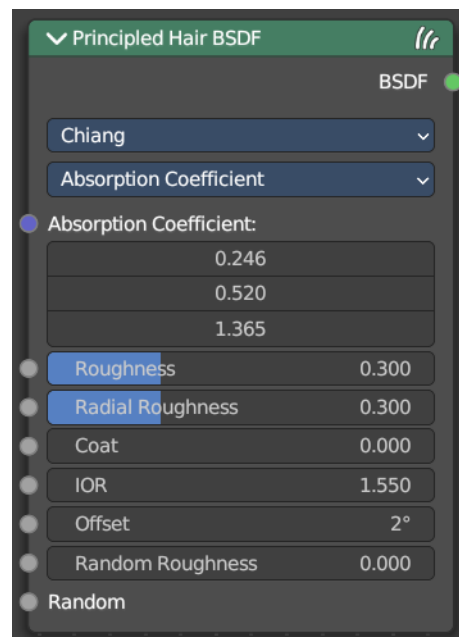

Offset

The tilt angle of the cuticle scales. That'st the outermost part of the hair. They are always tilted towards the hair root. Human hair has a value between 2 and 4.

Random Roughness

Adds a random roughness to each strand.

Random

Add a random value.

Chiang - Melanin concentration

This mode defines the color as the quantity and ratio of the pigments which are commonly found in hair and fur, eumelanin (prevalent in brown-black hair) and pheomelanin (red hair). The quantity is specified in the Melanin input, and the ratio between them in Melanin Redness. Increasing concentrations darken the hair (the following are with Melanin Redness 1):

White (Melanin 0), Blonde (Melanin 0.25), Reddish (Melanin 0.5), Brown (Melanin 0.75), Black (Melanin 1)

Additionally, the Tint inputs allows to dye the hair with the desired color.

Melanin

Absolute quantity of pigment. Range [0,1] equivalent to [0%,100%].

Hint. This is a linear mapping to the underlying exponential function:
 $melanin_qty = -\ln(\max(1.0 - Melanin, 0.0001))$

Melanin Redness

Ratio of pheomelanin to eumelanin. Range [0,1] equivalent to [0%,100%].

Hint. The ratio formula is: $eumelanin = Melanin * (1.0 - MelaninRedness)$,
 $pheomelanin = Melanin * MelaninRedness$.

The resulting quantities are converted (after randomization, if specified) to absorption concentration via the following formula (section 6.1 of [EFHLA11], adjusted for the range [0,1]):
 $sa = eumelanin * 0.50608411653 + pheomelanin * 0.34307331924$

Tint

Color used for dyeing the hair after applying the melanin pigment. It is not subject to randomization. It can be disabled by setting the color to white.

Hint. This is converted via the Color mapping above and added to the absorption coefficient of the melanin concentration.

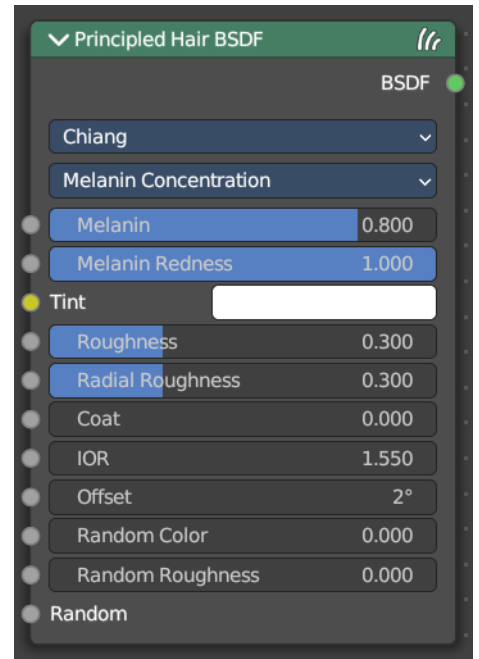

Roughness

The hair roughness. A lower value leads to a metallic look.

Radial Roughness

Specify how much the glints are smoothed in the direction of the hair tangent. Too low values will concentrate the glint; while setting it too high will spread the light across the width of the strand.

Hint. Mathematically, this parameter is mapped to the logistic distribution's scale factor s (section 4.1 of [CBTB16]).

Coat

Simulate a shiny coat by reducing the roughness to the given factor only for the first light bounce (diffuse). Range [0, 1] is equivalent to a reduction of [0%, 100%] of the original roughness.")

IOR

Refraction coefficient. The default value of 1.550 is the refraction coefficient of melanin.

Offset

The tilt angle of the cuticle scales. That's the outermost part of the hair. They are always tilted towards the hair root. Human hair has a value between 2 and 4.

Random Color

For each strand, vary the melanin concentration by RandomFactor. Range [0,1] equivalent to [0%,100%] of the initial melanin concentration.

Hint. The melanin concentration is multiplied by randomFactor, where $\text{randomFactor} = 1.0 + 2.0 * (\text{Random} - 0.5) * \text{RandomColor}$.

Random Roughness

Adds a random roughness to each strand.

Chiang - Direct Coloring

Choose the desired RGB color and the shader will approximate the necessary absorption coefficient (below).

Color

The RGB color of the strand. Only used in Direct coloring.

Hint. The chosen color is converted to an absorption coefficient with the following formula (section 4.2 of [CBTB16]):

$$s_a = \ln(\text{Color}) (5.969 - 0.215\beta_N + 2.532\beta_N^2 - 10.73\beta_N^3 + 5.574\beta_N^4 + 0.245\beta_N^5)$$

where β_N is the radial roughness of the hair after applying randomization (if specified).

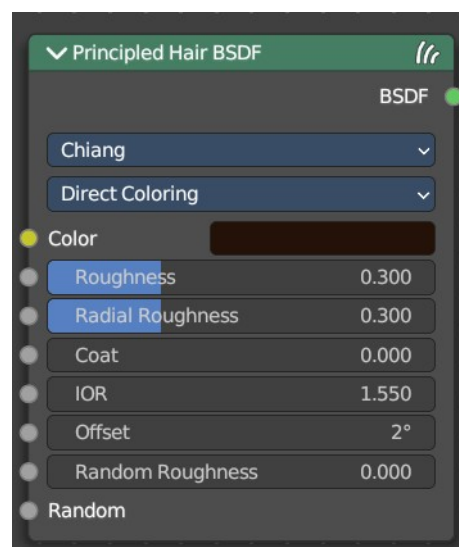

Roughness

The hair roughness. A lower value leads to a metallic look.

Radial Roughness

Add an extra radial roughness.

Coat

Simulate a shiny coat of fur, by reducing the Roughness to the given factor only for the first light bounce (diffuse). Range [0,1] equivalent to a reduction of [0%,100%] of the original Roughness.

IOR

Index of refraction (IOR) defining how much the ray changes direction. At 1.0 rays pass straight through like in a transparent material; higher values give more refraction. Default value is 1.55.

Offset

Tilts the glint of the hair by increasing the angle of the scales of the hair's cuticle with respect to the hair shaft. Human hair usually has low values.

Random Roughness

For each strand, vary both Roughness values by RandomFactor. Range [0,1] equivalent to [0%,100%] of the initial roughness values.

Hint. The applied formula is the same one as for Random Color.

Outputs

BSDF

Standard shader output.

Principled Volume

The Principled Volume shader combines all volume shading components into a single easy to use node. Volumes like smoke and fire can be rendered with a single shader node, which includes scattering, absorption and blackbody emission.

Inputs

Color

Volume scattering color.

Color Attribute

Volume grid for coloring the volume. Use “color” for smoke simulations.

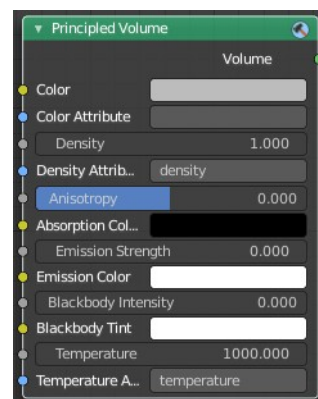

Density

Density of the volume.

Density Attribute

Volume grid to define the density, typically “density”.

Anisotropy

Backward or forward scattering direction.

Absorption Color

Volume shadow color tint.

Emission Strength

Amount of light to emit.

Emission Color

Emission color tint.

Blackbody Intensity

Blackbody emission for fire. Set to 1 for physically accurate intensity.

Blackbody Tint

Color tint for blackbody emission.

Temperature

Temperature in kelvin for blackbody emission, higher values emit more.

Temperature Attribute

Volume grid to define the temperature, typically “temperature”.

Outputs

Volume

Standard shader output.

Refraction BSDF

The Refraction BSDF is used to add glossy refraction with sharp or micro facet distribution, used for materials that transmit light. For best results this node should be considered as a building block and not be used on its own, but rather mixed with a glossy node using a Fresnel factor. Otherwise it will give quite dark results at the edges for glossy

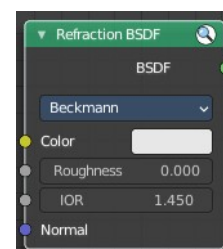

refraction.

Inputs

Color

Color of the surface, or physically speaking, the probability that light is refracted for each wavelength.

Roughness

Influences sharpness of the refraction; perfectly sharp at 0.0 and smoother with higher values.

Normal

Normal used for shading; if nothing is connected the default shading normal is used.

Properties

Distribution

Micro facet distribution to use. Sharp results in perfectly sharp refraction, while Beckmann and GGX can use the Roughness input for blurry refraction.

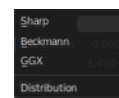

Outputs

BSDF

Standard shader output.

Specular BSDF

Eevee Only

The Specular BSDF combines multiple shader layers into a single easy to use node.

It is similar to the Principled BSDF node but uses the specular workflow instead of the metallic. It has far fewer parameters and supports less features. Both might be merged into one node in the future.

The specular workflow functions by specifying the facing (along normal) reflection color. The result may not be physically plausible because there is no energy conservation.

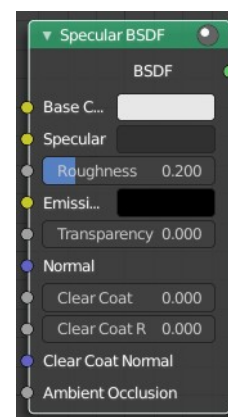

Inputs

Base Color

Diffuse surface color. For conductor materials (metals) it should be black.

Specular Color

Amount of specular reflection. Specifies facing (along normal) reflectivity. Conductor materials (metals) can

have colored specular reflection.

Hint. To compute this value for a realistic material with a known index of refraction, you may use this special case of the Fresnel formula: $\text{specular} = ((\text{ior} - 1) / (\text{ior} + 1))^2$

For example:

water: ior = 1.33, specular = 0.25

glass: ior = 1.5, specular = 0.5

diamond: ior = 2.417, specular = 2.15

Roughness

Specifies micro facet roughness of the surface for diffuse and specular reflection.

Hint. When converting from the older Glossy BSDF node, use the square root of the original value.

Emissive Color

Color of the emitted light. This light is added to the BSDF result.

Transparency

Transparency factor. This is the inverse of the alpha channel (1 - alpha) you find in an image. Use an Invert node to convert alpha to transparency. This will only have an effect if the material uses a blend mode other than opaque.

Normal

Controls the normals of the base layers.

Clear coat

Extra white specular layer on top of others. This is useful for materials like car paint and the like.

Clear coat Roughness

Roughness of clear coat specular.

Clear coat Normal

Controls the normals of the Clear coat layer.

Ambient Occlusion

Amount of occlusion to apply to indirect lighting. Usually a bake ambient occlusion map. The final occlusion factor is the minimum of this input and the runtime ambient occlusion effect.

Outputs

BSDF

Standard shader output.

Subsurface Scattering

The Subsurface Scattering node is used to add simple subsurface multiple scattering, for materials such as skin, wax, marble, milk and others. For these materials, rather than light being reflect directly off the surface, it will penetrate the surface and bounce around internally before getting absorbed or leaving the surface at a nearby point.

How far the color scatters on average can be configured per RGB color channel. For example, for skin, red colors scatter further, which gives distinctive red-colored shadows, and a soft appearance.

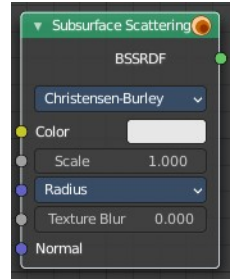

Inputs

Color

Color of the surface, or physically speaking, the probability that light is reflected for each wavelength.

Scale

Global scale factor for the scattering radius.

Radius

Average distance that light scatters below the surface. Higher radius gives a softer appearance, as light bleeds into shadows and through the object. The scattering distance is specified separately for the RGB channels, to render materials such as skin where red light scatters deeper. The X, Y and Z values are mapped to the R, G and B values, respectively.

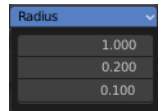

Sharpness

Used only with Cubic falloff. Values increasing from 0 to 1 prevents softening of sharp edges and reduces unwanted darkening.

Normal

Normal used for shading; if nothing is connected the default shading normal is used.

Texture Blur

How much of the texture will be blurred along with the lighting, mixing the texture at the incoming and outgoing points on the surface. Note that the right choice depends on the texture. Consider for example a texture created from a photograph of skin, in this case the colors will already be pre-blurred and texture blur could be set to 0. Even for hand-painted textures, no blurring or minimal blurring might be appropriate, as a texture artist would likely paint in softening already. One would usually not even know what an unblurred skin texture looks like; we always see it blurred. For a procedural texture on the other hand this option would likely have a higher value.

Properties

Falloff Method

Rendering method to simulate subsurface scattering.

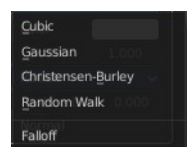

Christensen-Burley

Is an approximation to physically-based volume scattering. Gives less blurry results than Cubic and Gaussian functions.

Random Walk

Cycles Only

Provides the most accurate results for thin and curved objects. This comes at the cost of increased render time or noise for more dense media like skin, but also better geometry detail preservation. Random Walk uses true volumetric scattering inside the mesh, which means that it works best for closed meshes. Overlapping faces and holes in the mesh can cause problems.

Cubic

Is a sharp falloff useful for many simple materials. The function is $(\text{radius}-x)^3$.

Gaussian

Gives a smoother falloff following a normal distribution, which is particularly useful for more advanced materials that use measured data that was fitted to one or more such Gaussian functions. The function is $e^{-8x^2/\text{radius}^2}$, such that the radius roughly matches the maximum falloff distance. To match a given measured variance v , set $\text{radius}=\sqrt{16 \times v}$.

Outputs

BSSRDF

BSSRDF shader output.

Toon BSDF

Cycles Only

The Toon BSDF is used to create Diffuse and Glossy materials with cartoon light effects.

Inputs

Color

Color of the surface, or physically speaking, the probability that light is reflected for each wavelength.

Size

Parameter between 0.0 and 1.0 that gives an angle of reflection between 0° and 90° .

Smooth

This value specifies an angle over which a smooth transition from full to no reflection happens.

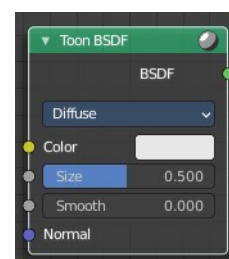

Normal

Normal used for shading; if nothing is connected the default shading normal is used.

Properties

Component

Diffuse

Use shading based on the Diffuse BSDF.

Glossy

Use shading based on the Glossy BSDF for specular reflection.

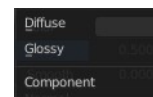

Outputs

BSDF

Standard shader output.

Translucent BSDF

The Translucent BSDF is used to add Lambertian diffuse transmission.

Inputs

Color

Color of the surface, or physically speaking, the probability that light is transmitted for each wavelength.

Normal

Normal used for shading; if nothing is connected the default shading normal is used.

Outputs

BSDF output

Standard shader output.

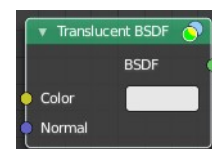

Transparent BSDF

The Transparent BSDF is used to add transparency without refraction, passing straight through the surface, as if there were no geometry there. Useful with alpha maps, for example. This shader affects light paths somewhat differently than other BSDFs. Note that only pure white transparent shaders are completely transparent.

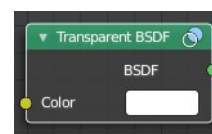

Inputs

Color

Color of the surface, or physically speaking, the probability for each wavelength that light is blocked or passes straight through the surface.

Outputs

BSDF

Standard shader output.

Sheen BSDF

Cycles Only

The Sheen BSDF is used to add reflection to materials such as cloth. It is meant to be used together with other shaders (such as a Diffuse Shader) and is not particularly useful on its own.

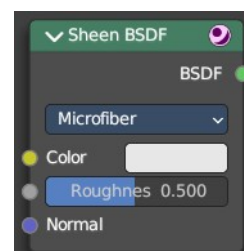

Inputs

Color

Color of the surface, or physically speaking, the probability that light is reflected for each wavelength.

Sigma

Variance of the normal distribution, controlling the sharpness of the peak. It can be thought of as a kind of roughness.

Normal

Normal used for shading; if nothing is connected the default shading normal is used.

Properties

Distribution

The distribution algorithm. Akishikmin is the legacy model. Microfiber the modern approach.

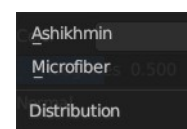

Outputs

BSDF

Standard shader output.

Volume Absorption

The Volume Absorption node allows light to be absorbed as it passes through the volume. Typical usage for this node would be water and colored glass.

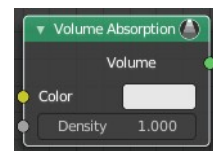

Inputs

Color

Color of the volume.

Density

The density of the absorption effect.

Outputs

Volume

The Volume Shader.

Volume Scatter

The Volume Scatter node allows light to be scattered as it passes through the volume. Typical usage would be to add fog to a scene. It can also be used with the Volume Absorption node to create smoke.

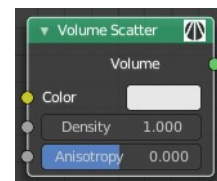

Inputs

Color

Color of the volume.

Density

The density of the scatter effect.

Anisotropy

Controls the look of the scatter effect depending on the direction of the light passing through it.

Output

Volume

The Volume Shader output must be plugged into the Volume Input of the Material or World Output node.



13.1.9 Editors - Shader Editor - Header - Add Menu - Texture

Table of content

Detailed Table of content.....	1
Add menu - Texture.....	7
Brick Texture.....	7
Checker Texture.....	8
Environment Texture.....	9
Gradient Texture.....	10
IES Texture.....	11
Image Texture.....	12
Magic Texture.....	14
Musgrave Texture.....	15
Noise Texture.....	17
Point Density.....	19
Sky Texture.....	21
Voronoi Texture.....	22
Wave Texture.....	24
White Noise Texture.....	25

Detailed Table of content

Detailed table of content

Detailed Table of content.....	1
Add menu - Texture.....	7
Brick Texture.....	7
Inputs.....	7
Color 1, Color 2 and Mortar.....	7
Scale.....	7
Mortar Size.....	7
Mortar Smooth.....	7
Bias.....	7
Brick Width.....	7
Row Height.....	7
Properties.....	8
Offset.....	8
Frequency.....	8
Squash.....	8
Frequency.....	8
Outputs.....	8
Color.....	8
Factor.....	8
Checker Texture.....	8
Inputs.....	8
Vector.....	8
Color1, Color 2.....	8
Scale.....	8
Outputs.....	9

Color.....	9
Factor.....	9
Environment Texture.....	9
Inputs.....	9
Vector.....	9
Properties.....	9
Image.....	9
Color Space.....	9
Texture Interpolation.....	9
Linear.....	9
Closest.....	9
Cubic.....	9
Smart.....	9
Projection Method.....	10
Equirectangular.....	10
Mirror Ball.....	10
Outputs.....	10
Color.....	10
Gradient Texture.....	10
Inputs.....	10
Vector.....	10
Properties.....	10
Gradient Type.....	10
Linear.....	10
Quadratic.....	10
Easing.....	10
Diagonal.....	10
Spherical.....	10
Quadratic Sphere.....	11
Radial.....	11
Outputs.....	11
Color.....	11
Factor.....	11
IES Texture.....	11
Inputs.....	11
Vector.....	11
Strength.....	11
Properties.....	11
Mode.....	11
Internal.....	11
External.....	11
Outputs.....	11
Factor.....	11
Image Texture.....	12
Inputs.....	12
Vector.....	12
Properties.....	12
Image.....	12
Interpolation.....	12
Linear.....	12
Cubic.....	13
Closest.....	13
Smart.....	13

Projection.....	13
Flat.....	13
Box.....	13
Blend.....	13
Sphere.....	13
Tube.....	13
Extension.....	13
Repeat.....	13
Extend.....	13
Clip.....	14
Source.....	14
Color Space.....	14
Alpha.....	14
Outputs.....	14
Color.....	14
Alpha.....	14
Magic Texture.....	14
Inputs.....	14
Vector.....	14
Scale.....	15
Distortion.....	15
Properties.....	15
Depth.....	15
Outputs.....	15
Color.....	15
Factor.....	15
Musgrave Texture.....	15
Inputs.....	15
Vector.....	16
W.....	16
Scale.....	16
Detail.....	16
Dimension.....	16
Lacunarity.....	16
Offset.....	16
Gain.....	16
Properties.....	16
Dimensions.....	16
1D.....	16
2D.....	16
3D.....	16
4D.....	16
Type.....	17
fBM (fractal Brownian Motion).....	17
Multifractal.....	17
Hybrid Multifractal.....	17
Ridged Multifractal.....	17
Hetero Terrain (Heterogeneous Terrain).....	17
Outputs.....	17
Factor.....	17
Noise Texture.....	17
Inputs.....	17
Vector.....	17

Scale.....	17
Detail.....	18
Roughness.....	18
Lacunarity.....	18
Distortion.....	18
Properties.....	18
Dimensions.....	18
1D.....	18
2D.....	18
3D.....	18
4D.....	18
Normalize.....	18
Outputs.....	18
Factor.....	18
Color.....	18
Point Density.....	19
Inputs.....	19
Vector.....	19
Properties.....	19
Point Data.....	19
Particle System.....	19
Object Vertices.....	19
Object.....	19
Particle System.....	19
Space.....	19
World Space.....	19
Object Space.....	19
Radius.....	19
Interpolation.....	19
Closest.....	20
Linear.....	20
Cubic.....	20
Resolution.....	20
Color Source.....	20
Particle Color Sources.....	20
Particle Age.....	20
Particle Speed.....	20
Particle Velocity.....	20
Vertex Color Sources.....	20
Vertex Color.....	20
Vertex Weight.....	20
Vertex Normals.....	20
Outputs.....	20
Color.....	20
Density.....	21
Sky Texture.....	21
Inputs.....	21
Vector.....	21
Properties.....	21
Sky Type.....	21
Sun Direction.....	21
Turbidity.....	21
Ground Albedo.....	21

Outputs.....	21
Color.....	21
Voronoi Texture.....	22
Inputs.....	22
Vector.....	22
W.....	22
Scale.....	22
Randomness.....	22
Properties.....	22
Dimensions.....	22
1D.....	22
2D.....	22
3D.....	22
4D.....	22
Feature.....	22
F1.....	23
Smooth F1.....	23
Distance To Edge.....	23
N-Sphere Radius.....	23
Distance Metric.....	23
Euclidean.....	23
Manhattan.....	23
Chebychev.....	23
Minkowski.....	23
Outputs.....	23
Distance.....	23
Color.....	23
Position.....	23
W.....	23
Radius.....	24
Wave Texture.....	24
Inputs.....	24
Vector.....	24
Scale.....	24
Distortion.....	24
Detail.....	24
Detail Scale.....	24
Detail Roughness.....	24
Phase Offset.....	24
Properties.....	24
Wave Type.....	24
Bands direction.....	25
Wave Profile.....	25
Saw.....	25
Sine.....	25
Triangle.....	25
Outputs.....	25
Color.....	25
Factor.....	25
White Noise Texture.....	25
Inputs.....	25
Vector.....	25
W.....	25

Properties.....	26
Dimensions.....	26
1D.....	26
2D.....	26
3D.....	26
4D.....	26
Outputs.....	26
Value.....	26

Add menu - Texture

Here are the texture nodes. They allow you to add different texture types to the scene. The content is the same for the sub modes and the different renderers. However, a environment texture just makes sense for the world sub mode.

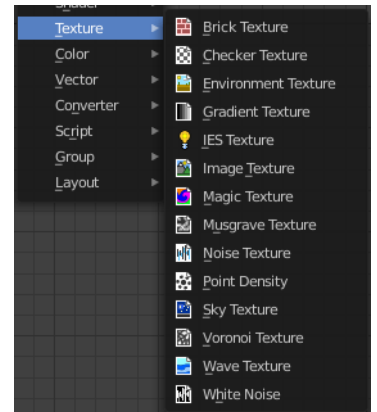

Brick Texture

The Brick Texture node is used to add a procedural brick texture.

Inputs

Color 1, Color 2 and Mortar

Color of the bricks and mortar.

Scale

Overall texture scale.

Mortar Size

The size of the filling between the bricks known as “mortar”; 0 means no mortar.

Mortar Smooth

Blurs/softens the edge between the mortar and the bricks. This can be useful with a texture and displacement textures.

Bias

The color variation between Color 1/2. Values of -1 and 1 only use one of the two colors; values in between mix the colors.

Brick Width

The width of the bricks.

Row Height

The height of the brick rows.

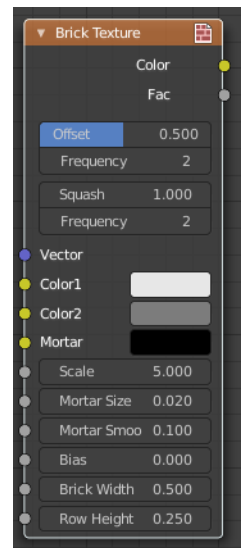

Properties

Offset

Determines the brick offset of the various rows.

Frequency

Determines the offset frequency. A value of 2 gives an even/uneven pattern of rows.

Squash

Amount of brick squashing.

Frequency

Brick squashing frequency.

Outputs

Color

Texture color output.

Factor

Mortar mask (1 = mortar).

Checker Texture

The Checker Texture node adds a procedural checkerboard texture.

Inputs

Vector

Texture coordinate to sample texture at; defaults to Generated texture coordinates if the socket is left unconnected.

Color1, Color 2

Color of the checkers.

Scale

Overall texture scale. The scale is a factor of the bounding box of the face divided by the scale. For example, a scale of 15 will result in 15 alternate patterns over the overall UV bounding box. Different patterns could be achieved using other nodes to give different input patterns to this socket. For example, using the Math Node.

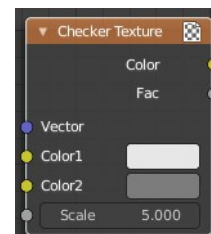

Outputs

Color

Texture color output.

Factor

Checker 1 mask (1 = Checker 1).

Environment Texture

Load an environment texture to light your scene.

Inputs

Vector

Texture coordinate for texture look-up. If this socket is left unconnected, the image is mapped as environment with the Z axis as up.

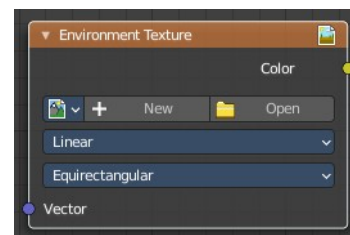

Properties

Image

Image data-block used as the image source. Additional settings can be found in Sidebar > Item > Properties: These include options to control the alpha channel along with addition options for the color space. These addition options are documented with the rest of Common Image Settings.

Color Space

Type of data that the image contains, either Color or Non-Color Data. For most color textures the default of Color should be used, but in case of e.g. a bump or alpha map, the pixel values should be interpreted as Non-Color Data, to avoid doing any unwanted color space conversions.

Texture Interpolation

Interpolation method used for the environment texture.

Linear

Regular quality interpolation.

Closest

No interpolation, use closest pixel.

Cubic

Smoother, better quality interpolation.

Smart

Bicubic when magnifying, otherwise Bilinear is used. This is only available for OSL.

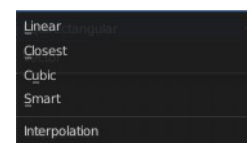

Projection Method

Allows you to use different types of environmental maps.

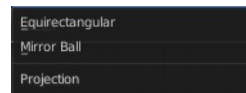

Equirectangular

Projection from an Equirectangular photo.

Mirror Ball

Projection from an orthographic photo or mirror ball.

Outputs

Color

RGB color from the image.

Gradient Texture

The Gradient Texture node generates interpolated color and intensity values based on the input vector.

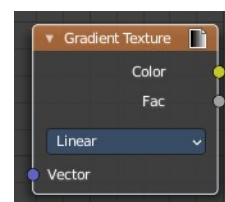

Inputs

Vector

Texture coordinate to sample texture at; defaults to Generated texture coordinates if the socket is left unconnected.

Properties

Gradient Type

Controls the type of gradient generated.

Linear

Directly returns the input X coordinate.

Quadratic

Interpolates the input X coordinate quadratically.

Easing

Uses a combination of quadratic and linear interpolation to return a smooth gradient from the input X coordinate.

Diagonal

Averages the input X and Y coordinates.

Spherical

Creates an inverse gradient using the length of the input vector; the maximum value is at (0, 0, 0).

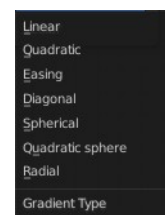

Quadratic Sphere

The same as Spherical, except interpolated quadratically.

Radial

Returns a value based on the angle of the input around the Z axis.

Outputs

Color

Texture color output.

Factor

Texture intensity output.

IES Texture

The IES Texture is used to match real world lights based on IES files. IES files store the directional intensity distribution of light sources.

Inputs

Vector

Texture coordinate for lookup in the light distribution. Defaults to the normal.

Strength

Light strength multiplier.

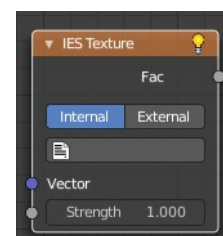

Properties

Mode

Internal

Use IES profile from a file embedded in a text data-block in the blend-file, for easy distribution.

External

Load IES profile from a file on the drive.

Outputs

Factor

Light intensity, typically plugged into the Strength input of an Emission node.

Image Texture

The Image Texture is used to add an image file as a texture.

Inputs

Vector

Texture coordinate for texture look-up. If this socket is left unconnected, UV coordinates from the active UV render layer are used.

Properties

Image

Open an image, choose an existing image, or generate a new image.

When you click at Open then a file browser opens up. When you click at New then a popup dialog opens. up where you can create a new image.

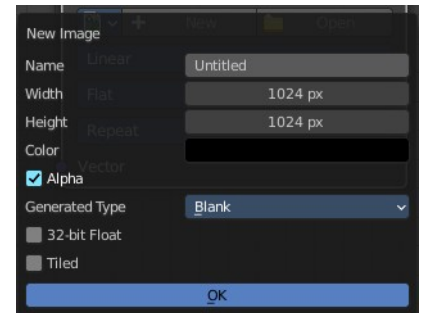
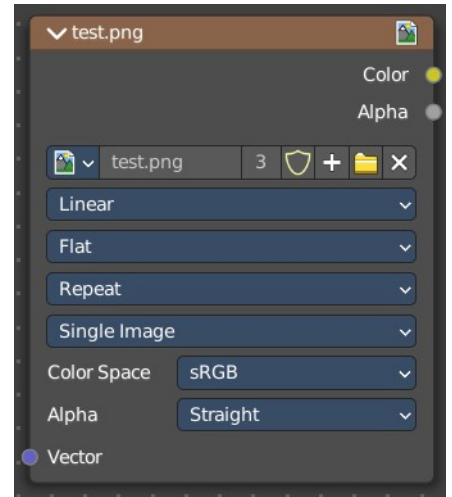

The image browser at the left allows you to pick an already existing texture from the scene.

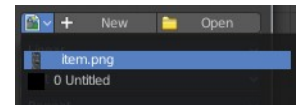

More image settings can be found in the Sidebar in the Items tab. Usually you find in the Item tab the very same settings like in the selected node. But the Image texture node is an exception. It shows here the usual image related settings too. This will be explained in the sidebar chapter.

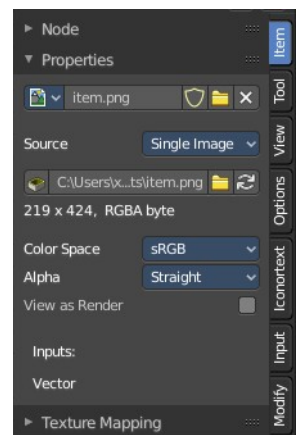

Interpolation

Method to scale images up or down for rendering.

Linear

Regular quality interpolation.

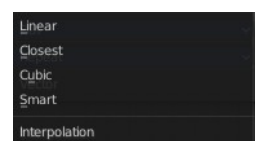

Cubic

Smoother, better quality interpolation. For bump maps this should be used to get best results.

Closest

No interpolation, use only closest pixel for rendering pixel art.

Smart

Cycles Only

Only for Open Shading Language. Use cubic interpolation when scaling up and linear when scaling down, for a better performance and sharpness.

Projection

Projection to use for mapping the textures.

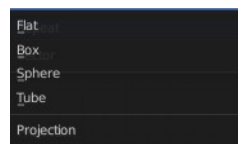

Flat

Uses the XY coordinates for mapping.

Box

Maps the image to the six sides of a virtual box, based on the normal, using XY, YZ and XYZ coordinates depending on the side.

Blend

For Box mapping, the amount to blend between sides of the box, to get rid of sharp transitions between the different sides. Blending is useful to map a procedural-like image texture pattern seamlessly on a model. 0.0 gives no blending; higher values give a smoother transition.

Sphere

Sphere mapping is the best type for mapping a sphere, and it is perfect for making planets and similar objects. It is often very useful for creating organic objects.

Tube

Maps the texture around an object like a label on a bottle. The texture is therefore more stretched on the cylinder. This mapping is of course very good for making the label on a bottle, or assigning stickers to rounded objects. However, this is not a cylindrical mapping so the ends of the cylinder are undefined.

Extension

Extension defines how the image is extrapolated past the original bounds:

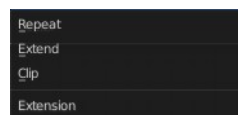

Repeat

Will repeat the image horizontally and vertically giving tiled-looking result.

Extend

Will extend the image by repeating pixels on its edges.

Clip

Clip to the original image size and set all the exterior pixels values to transparent black.

Source

What kind of image it is. The terms should be self explaining.

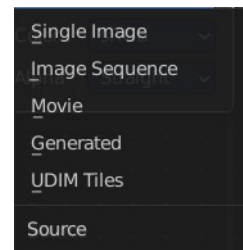

Color Space

What color space is used for the image.

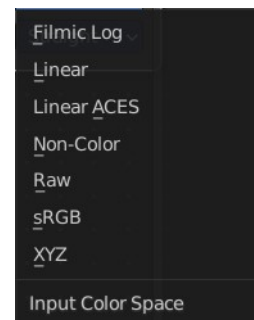

Alpha

What alpha mode is used for the image.

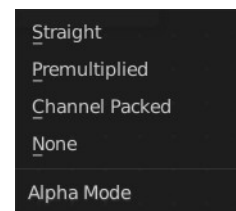

Outputs

Color

RGB color from image. If the image has alpha, the color is premultiplied with alpha if the Alpha output is used, and unpremultiplied or straight if the Alpha output is not used.

Alpha

Alpha channel from image.

Magic Texture

The Magic Texture node is used to add a procedural psychedelic color texture.

Inputs

Vector

Texture coordinate to sample texture at; defaults to Generated texture coordinates if the

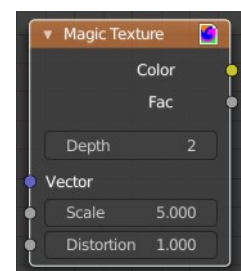

socket is left unconnected.

Scale

Scale of the texture.

Distortion

Amount of distortion.

Properties

Depth

Number of iterations.

Outputs

Color

Texture color output.

Factor

Texture intensity output.

Musgrave Texture

The Musgrave Texture node evaluates a fractal Perlin noise at the input texture coordinates. Compared to the noise texture, the Musgrave Texture allows greater control over how octaves are combined.

Inputs

The available input types change, dependent of the chosen Type and dimensions.

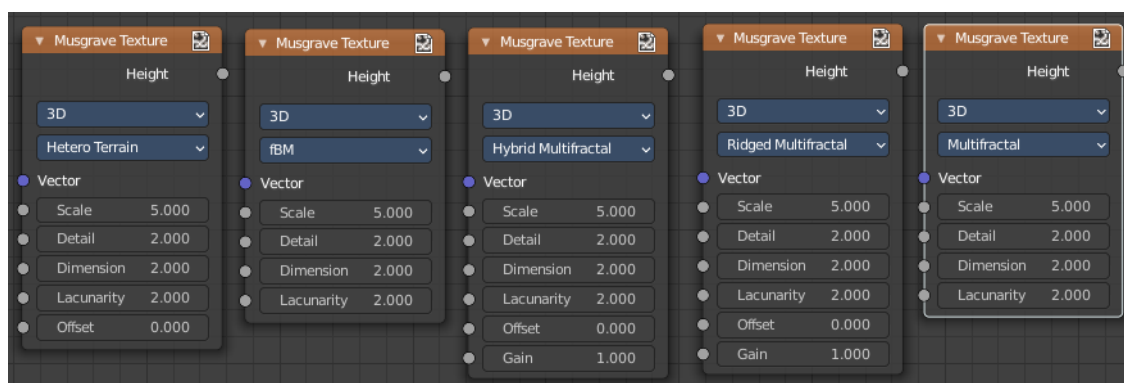

Vector

Texture coordinate to evaluate the noise at. Defaults to Generated texture coordinates if the socket is left unconnected.

W

Texture coordinate to evaluate the noise at. Appears with 4 dimensions.

Scale

Scale of the base noise octave.

Detail

Number of noise octaves. The fractional part of the input is multiplied by the magnitude of the highest octave. Higher number of octaves corresponds to a higher render time.

Dimension

The difference between the magnitude of each two consecutive octaves. Larger values corresponds to smaller magnitudes for higher octaves.

Lacunarity

The difference between the scale of each two consecutive octaves. Larger values corresponds to larger scale for higher octaves.

Offset

An added offset to each octave, determines the level where the highest octave will appear.

Gain

An extra multiplier to tune the magnitude of octaves.

Properties

Dimensions

The dimensions of the space to evaluate the noise in.

1D

Evaluate the noise in 1D space at the input W.

2D

Evaluate the noise in 2D space at the input Vector. The Z component is ignored.

3D

Evaluate the noise in 3D space at the input Vector.

4D

Evaluate the noise in 4D space at the input Vector and the input W as the fourth dimension.



Higher dimensions corresponds to higher render time, so lower dimensions should be used unless higher dimensions are necessary.

Type

Type of the Musgrave texture.

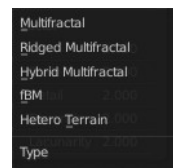

fBM (fractal Brownian Motion)

Produces an unnatural homogeneous and isotropic result. Uses an additive cascade, the values are simply added together.

Multifractal

The result is more uneven (varies with location), more similar to a real terrain. Uses a multiplicative cascade.

Hybrid Multifractal

Creates peaks and valleys with different roughness values, like real mountains rise out of flat plains. Combines the additive cascade with a multiplicative cascade.

Ridged Multifractal

Creates sharp peaks. Calculates the absolute value of the noise, creating “canyons”, and then flips the surface upside down.

Hetero Terrain (Heterogeneous Terrain)

Similar to Hybrid Multifractal creates a heterogeneous terrain, but with the likeness of river channels.

Outputs

Factor

Texture value.

Noise Texture

The Noise Texture node evaluates a fractal Perlin noise at the input texture coordinates.

Inputs

The inputs are dynamic, they become available if needed depending on the node properties.

Vector

Texture coordinate to evaluate the noise at; defaults to Generated texture coordinates if the socket is left unconnected.

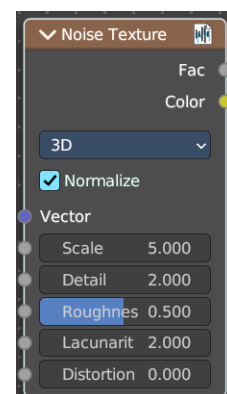

Scale

Scale of the base noise octave.

Detail

Number of noise octaves. The fractional part of the input is multiplied by the magnitude of the highest octave. Higher number of octaves corresponds to a higher render time.

Roughness

Adds a roughness noise.

Lacunarity

The scale of a perlin noise octave relative to the perlin noise octave from the previous octave.

Distortion

Amount of distortion.

Properties

Dimensions

The dimensions of the space to evaluate the noise in.

1D

Evaluate the noise in 1D space at the input W.

2D

Evaluate the noise in 2D space at the input Vector. The Z component is ignored.

3D

Evaluate the noise in 3D space at the input Vector.

4D

Evaluate the noise in 4D space at the input Vector and the input W as the fourth dimension.

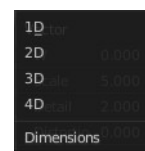

Normalize

Normalize the output to the 0 - 1 range.

Outputs

Factor

Value of fractal noise.

Color

Color with different fractal noise in each component.

Point Density

The Point Density node is used to add volumetric points for each particle or vertex of another object.

Inputs

Vector

Texture coordinate to sample texture at; defaults to global position (Position output of Geometry node) if the socket is left unconnected.

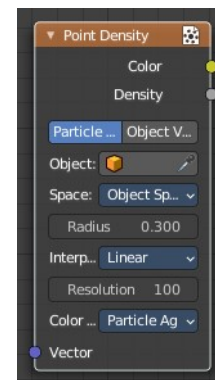

Properties

Point Data

Where to get points from.

Particle System

Use each particle position from the specified particle system.

Object Vertices

Use each vertex position from the specified object.

Object

Which object's vertices or particle system will be used.

Particle System

Particle positions from this system will be used.

Space

The coordinate system for mapping points.

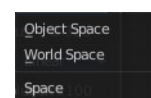

World Space

Map each point exactly where the source particle/vertex is.

Object Space

Fit the points from the source particles/vertices inside the bounding box of the object with the point density texture.

Radius

Size of the points.

Interpolation

Texel filtering type.



Closest

No interpolation, use nearest texel. Produces blocky looking points.

Linear

Interpolate linearly between texels, producing soft, round points.

Cubic

Use cubic falloff, producing very soft points. Useful when points are very densely packed.

Resolution

The dimensions of the texture holding the point data.

Color Source

Which attribute of the particle system or mesh is used to color the output. Switch to Object vertices to show the Vertex color sources.

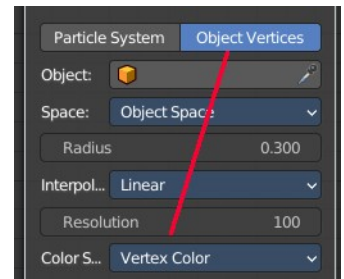

Particle Color Sources

Particle Age

Lifetime mapped as (0.0 - 1.0) intensity.

Particle Speed

Particle speed (absolute magnitude of velocity) mapped as (0.0 - 1.0) intensity.

Particle Velocity

XYZ velocity mapped to RGB colors.

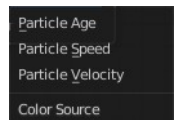

Vertex Color Sources

Vertex Color

Use a vertex color layer for coloring the point density texture.

Note. Vertex colors are defined per face corner. A single vertex can have as many different colors as faces it is part of. The actual color of the point density texture is averaged from all vertex corners.

Vertex Weight

Use weights from a vertex group as intensity values.

Vertex Normals

Use object-space vertex normals as RGB values.

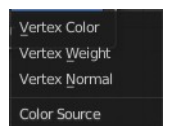

Outputs

Color

Texture color output.

Density

Density of volume.

Sky Texture

The Sky Texture node adds a procedural Sky texture.

Inputs

Vector

Texture coordinate to sample texture at; defaults to Generated texture coordinates if the socket is left unconnected.

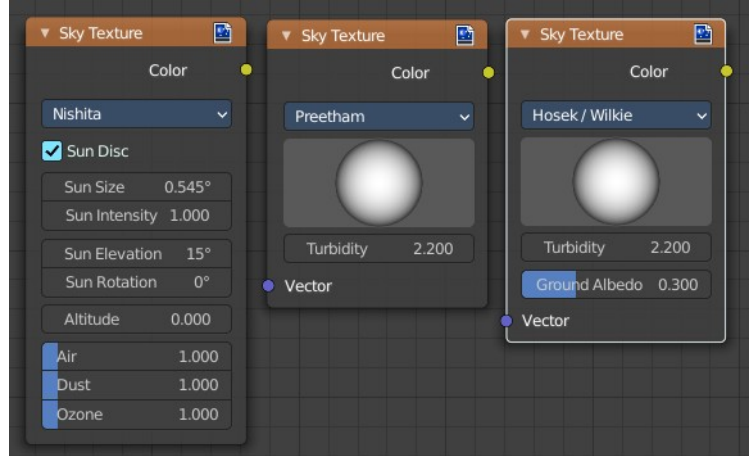

Properties

Sky Type

Sky model to use. You have the choice between three methods. Nishita, Preetham and Hosek/Wilkie

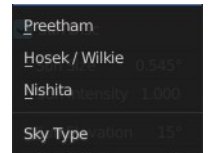

Sun Direction

Sun direction vector. Click at the image and drag to change the sun direction.



Turbidity

Atmospheric turbidity. Some reference values:

- 2: Arctic like
- 3: clear sky
- 6: warm/moist day
- 10: hazy day

Ground Albedo

Amount of light reflected from the planet surface back into the atmosphere. (RGB(0, 0, 0) is black, RGB(1, 1, 1) is white.)

Outputs

Color

Texture color output.

Voronoi Texture

The Voronoi Texture node evaluates a Worley Noise at the input texture coordinates.

Inputs

The inputs are dynamic, they become available if needed depending on the node properties.

Vector

Texture coordinate to evaluate the noise at; defaults to Generated texture coordinates if the socket is left unconnected.

W

Texture coordinate to evaluate the noise at.

Scale

Scale of the noise.

Randomness

The randomness of the noise.

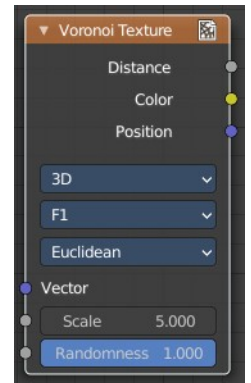

Properties

Dimensions

The dimensions of the space to evaluate the noise in.

1D

Evaluate the noise in 1D space at the input W.

2D

Evaluate the noise in 2D space at the input Vector. The Z component is ignored.

3D

Evaluate the noise in 3D space at the input Vector.

4D

Evaluate the noise in 4D space at the input Vector and the input W as the fourth dimension.



Feature

The Voronoi feature that the node will compute and return.

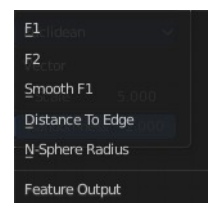

F1

Compute and return the distance to the closest feature point as well as its position and color.

Smooth F1

Compute and return a smooth version of F1.

Distance To Edge

Compute and return the distance to the edges of the Voronoi cells.

N-Sphere Radius

Compute and return the radius of the n-sphere inscribed in the Voronoi cells. In other words, it is half the distance between the closest feature point and the feature point closest to it.

Distance Metric

The distance metric used to compute the texture.

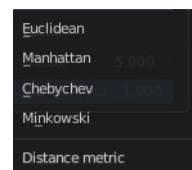

Euclidean

Use the Euclidean distance metric.

Manhattan

Use the Manhattan distance metric.

Chebychev

Use the Chebychev distance metric.

Minkowski

Use the Minkowski distance metric. The Minkowski distance is a generalization of the aforementioned metrics with an Exponent as a parameter. Minkowski with an exponent of one is equivalent to the Manhattan distance metric. Minkowski with an exponent of two is equivalent to the Euclidean distance metric. Minkowski with an infinite exponent is equivalent to the Chebychev distance metric.

Outputs

Distance

The Distance.

Color

Cell color. The color is arbitrary.

Position

Position of feature point.

W

Position of feature point.

Radius

N-Sphere radius.

Note. In some configurations of the node, especially for low values of Randomness, rendering artifacts may occur. This happens due to the same reasons described in the Notes section in the White Noise Texture page and can be fixed in a similar manner as described there.

Wave Texture

The Wave Texture node adds procedural bands or rings with noise distortion.

Inputs

Vector

Texture coordinate to sample texture at; defaults to Generated texture coordinates if the socket is left unconnected.

Scale

Overall texture scale.

Distortion

Amount of distortion of the wave (similar to the Marble texture in Blender Internal).

Detail

Amount of distortion noise detail.

Detail Scale

Scale of distortion noise.

Detail Roughness

Adds a roughness noise.

Phase Offset

Set an offset for the phase.

Properties

Wave Type

Bands or Rings shaped waves.

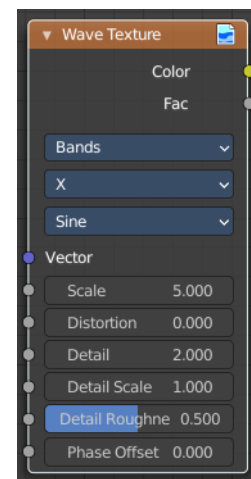

Bands direction

In which direction the bands should point.

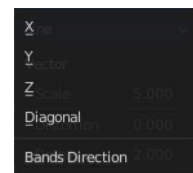

Wave Profile

Controls the shape and look of the wave type.

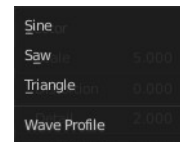

Saw

Uses a saw tooth profile.

Sine

Uses the standard sine profile.

Triangle

Uses a triangle shape.

Outputs

Color

Texture color output.

Factor

Texture intensity output.

White Noise Texture

This node adds noise.

Inputs

The inputs are dynamic, they become available if needed depending on the node properties.

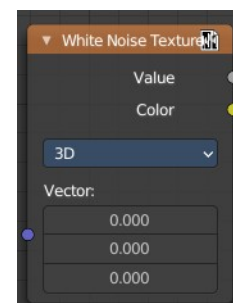

Vector

Vector used as seed in 2D, 3D, and 4D dimensions.

W

Value used as seed in 1D and 4D dimensions.

Properties

Dimensions

The dimensions of the space to evaluate the noise in.

1D

The *W* input is used as seed.

2D

The *X* and *Y* components of the *Vector* input are used as seed.

3D

The *Vector* input is used as seed.

4D

Both the *Vector* input and the *W* input are used as seed.

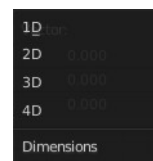

Outputs

Value

Output random value.

Note! The slightest difference in seed values would result in completely different outputs. Consequently, bad precision may have significant impact on the output. Usually, we can mitigate this issue by:

Eliminating the problematic seed value. If the problematic seed value is constant, it should be eliminated by choosing a lower dimension or multiplying it by zero.

Adding an arbitrary value to the seed. The issue might only happen at certain boundaries, like unit boundaries, so simply adding an arbitrary value might solve the issue.

Taking the absolute value of the seed. In computing, zero may be positive or negative, so taking the absolute values unifies the zero into a single value.



13.2 Editors - Shader Editor - Tool Shelf

Table of content

Tool Shelf.....	2
Select Tools Group.....	2
Tweak.....	2
Select Box.....	2
Tool Settings.....	2
Mode.....	2
Set a new selection.....	2
Extend existing selection.....	2
Subtract existing selection.....	2
Select Circle.....	2
Tool Settings.....	3
Mode.....	3
Set a new selection.....	3
Extend existing selection.....	3
Subtract existing selection.....	3
Radius.....	3
Select Lasso.....	3
Tool Settings.....	3
Mode.....	3
Set a new selection.....	3
Extend existing selection.....	3
Subtract existing selection.....	3
Annotate Tools group.....	3
Annotate.....	4
Tool Settings.....	4
Color.....	4
Stabilize Stroke.....	4
Radius.....	4
Factor.....	4
Annotate Line.....	4
Tool Settings.....	4
Color.....	4
Style Start.....	4
End.....	5
Annotate Polygon.....	5
Tool Settings.....	5
Color.....	5
Annotate Eraser.....	5
Tool Settings.....	5
Radius.....	5
Links Cut.....	5

Tool Shelf



Select Tools Group

Tools with a triangle down right are a group of tools. Click and hold to reveal the content. Then choose the tool that you need.

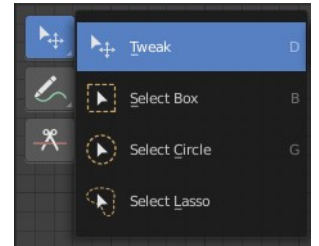

Tweak

Allows you to select or tweak single elements by clicking at it.

Select Box

Draws a box to select several elements at once. Click at the start point, then drag.

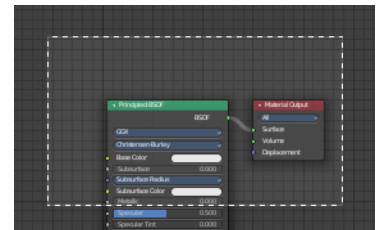

Tool Settings

Mode

The available selection modes. The mode titles are pretty self explaining. So i won't go into detail here.

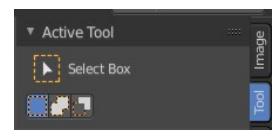

Set a new selection

Extend existing selection

Subtract existing selection

Select Circle

Draws a box to select several elements at once. Click at the start point, then drag.

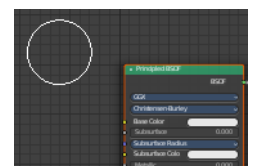

Tool Settings

Mode

The available selection modes. The mode titles are pretty self explaining. So i won't go into detail here.

Set a new selection

Extend existing selection

Subtract existing selection

Radius

The brush radius.



Select Lasso

Draws a box to select several elements at once. Click at the start point, then drag.

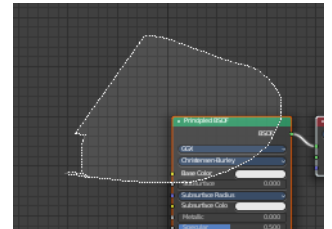

Tool Settings

Mode

The available selection modes. The mode titles are pretty self explaining. So i won't go into detail here.

Set a new selection

Extend existing selection

Subtract existing selection

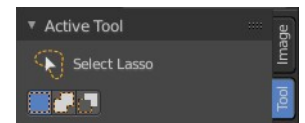

Annotate Tools group

The annotation tool is available in multiple editors. With this tool you can write notes at the screen. The annotate tools is the little brother of the grease pencil objects.

Further settings for annotate can be found in the sidebar.

Here you can also remove an annotation when you don't longer need it. And here you can also adjust the size of the stroke.

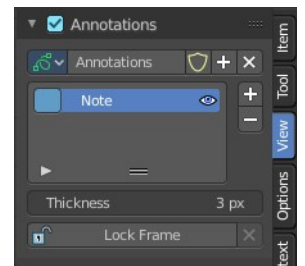
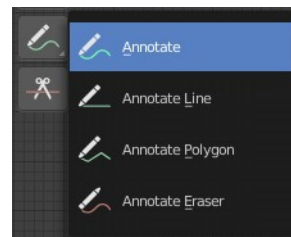

Annotate

Draw free-hand strokes in the main window.

Tool Settings

The tool settings for Annotate.

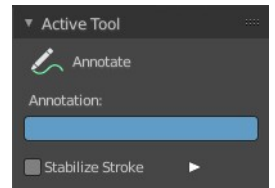

Color

Clicking at the left color field reveals a color picker. Define the color for the annotation stroke.



Stabilize Stroke

Helper to draw smooth and clean lines. Pressing shift inverts the effect.

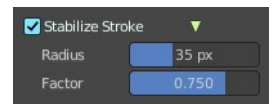

Radius

The radius for the stroke stabilization.

Factor

Stabilizer stroke factor. Higher values gives a smoother stroke.

Annotate Line

Click and drag to create a line.

Tool Settings

The tool settings for the Annotate tool.

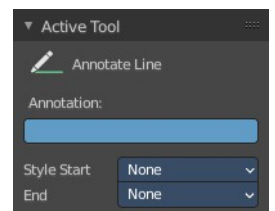

Color

Clicking at the left color field reveals a color picker. Define the color for the annotation stroke.



Style Start

The stroke start style. With an arrow for example you place an arrow at the start of the stroke.

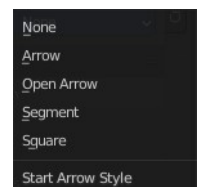

End

The stroke end style. With an arrow for example you place an arrow at the end of the stroke.

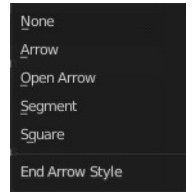

Annotate Polygon

Click multiple times to create multiple connected lines. The current polygon is finished when Esc or RMB is pressed.

Tool Settings

The tool settings for Annotate.

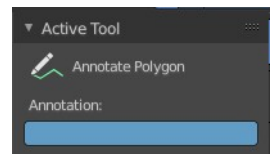

Color

Clicking at the left color field reveals a color picker where you can define the color for the annotation stroke.



Annotate Eraser

Click and drag to remove annotate lines.



Tool Settings

Radius

The radius of the eraser pencil.

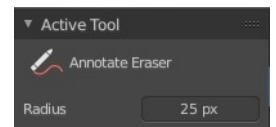

Links Cut

This tools allows you to cut connections.

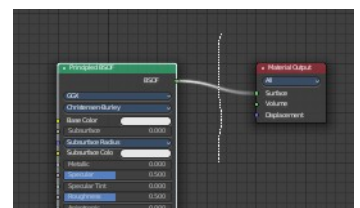



13.3 Editors - Shader Editor - Sidebar

Table of content

Introduction..... 1
Right Click menus..... 1

Introduction

The Shader Editor is made of several areas. At the right side you will find the sidebar. Here you will find further options and settings for the Shader Editor nodes and its tools.

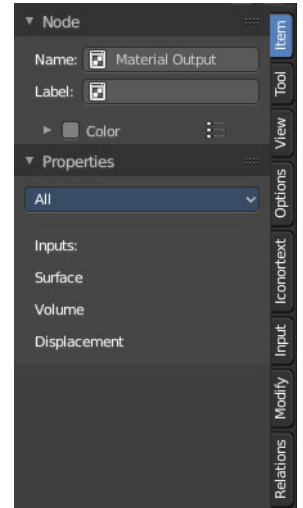

Right Click menus

You will open the usual right click menus when clicking with the right mouse at elements in the sidebar. Its content is in big parts self explaining.

The right click menus are explained in the chapter 6 Editors Introduction.

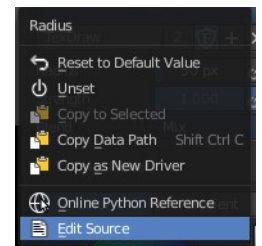



13.3.1 Editors - Shader Editor - Sidebar - Item Tab

Table of content

Item Tab - Node Panel.....	2
Name.....	2
Label.....	2
Color sub menu.....	2
Color checkbox.....	2
Presets.....	2
Color.....	2
Node color specials.....	2
Copy Color.....	2
Item Tab - Properties Panel.....	3
Item Tab - Properties Panel with Image node.....	3
Image Property.....	3
Image Browser.....	3
New / Open.....	4
Image Edit Box.....	4
Fake User.....	4
Open Image.....	4
Remove.....	4
Source.....	4
Source Type Generated.....	4
X / Y.....	4
Float Buffer.....	4
Generated Type Blank.....	4
Color.....	4
Generated Type UV Grid.....	5
Generated Type Color Grid.....	5
Color Space.....	5
View as Render.....	5
Source Type Movie + Image Sequence.....	5
Path edit box.....	5
Pack.....	5
Path edit box.....	6
Open.....	6
Refresh.....	6
Info string.....	6
Frames.....	6
Match Movie Length.....	6
Start.....	6
Offset.....	6
Cyclic.....	6
Auto Refresh.....	6
Deinterlace.....	6
Color Space.....	6
Alpha.....	7
View as Render.....	7
Source Type Single Image.....	7
Path edit box.....	7

Pack.....	7
Path edit box.....	7
Open.....	7
Refresh.....	7
Info string.....	7
Color Space.....	7
Alpha.....	8
View as Render.....	8
Source Type Udim.....	8

Item Tab - Node Panel

In this panel you can give nodes and node groups a name and a label, and change its color.

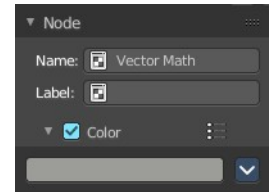

Name

The type of the node.

Label

The label name of the node.



Color sub menu

Color checkbox

The Color checkbox turns custom color on or off.

Presets

Store some color presets and reuse them. They are stored globally, and transfers to other blend files.

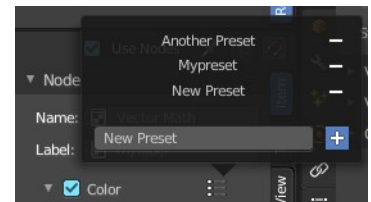

Color

Choose a custom color. A click at the color field will open a color picker.

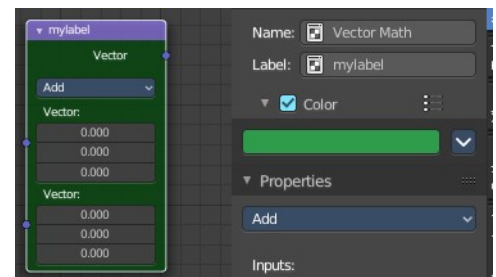

Node color specials

Copy Color

Allows you to copy the color.

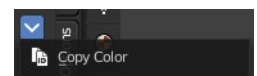

Item Tab - Properties Panel

This panel shows usually the same properties than the properties at the node. These properties are already explained in the Add menu chapters. So we won't repeat them here.

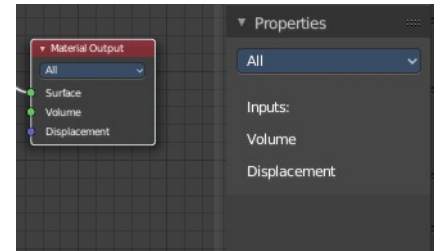

But there are exceptions like the Image node. Here the Properties panel shows much more options than at the node. It shows all the possible image settings. We will explain the extra options here.

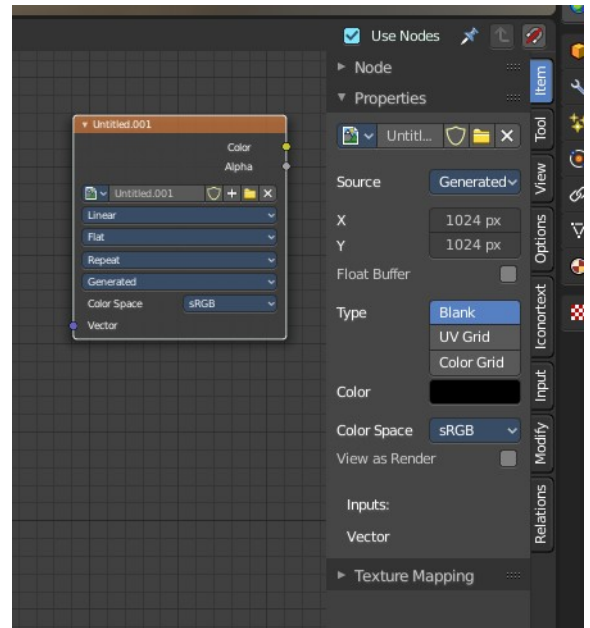

Item Tab - Properties Panel with Image node

This tab contains image related settings. Size, type, and so on.

Image Property

Load an image and / or switch to other images.

From left to right ...

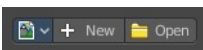
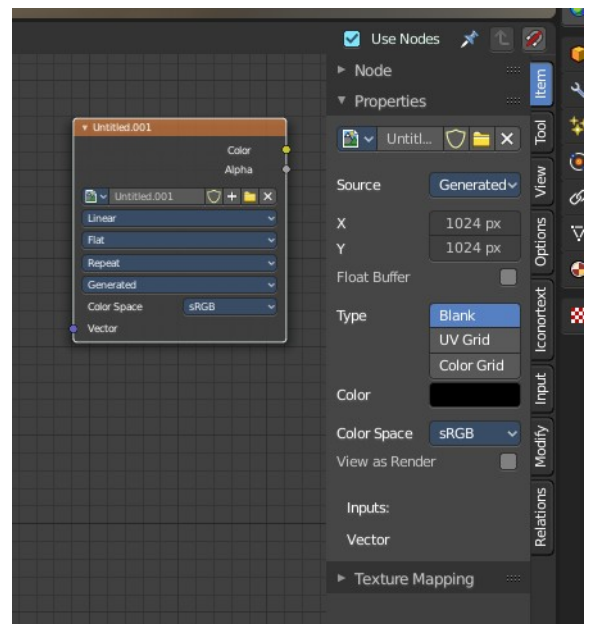

Image Browser

This is a list of the images in the scene. This list allows you to switch to other images.



New / Open

When nothing is loaded then you will see the New / Open buttons to load a new image, or to create a new one.

Image Edit Box

Read the name of the currently selected image. And you can rename the image here too.

Fake User

With this button you assign a fake user to this selected image.

Data, like images, that is not longer linked to anything else gets removed when you save and reload a scene. Bforartists has the concept of fake users to go around this behavior. An image with a fake user is in fact linked to something. And so it is not lost when you save and reload the scene.

Open Image

Load an image

Remove

Delete the image.

Source

Choose the image type. This type gets usually automatically set. When you create a new image, then this image is generated. When you load an image then the Source switches to Single Image.

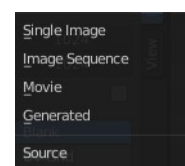

Generated images does not have a path.

Source Type Generated

X / Y

The image width and height.

Float Buffer

Use a floating point buffer. 8 Bit images uses integers. 32 Bit works with floats.

Generated Type Blank

This type displays an image with one blank color

Color

The color of the blank image.

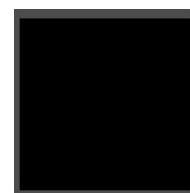

Generated Type UV Grid

This type displays a with a black and white checker texture but colored dots.

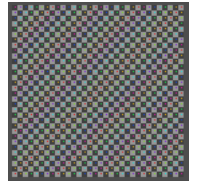

Generated Type Color Grid

This type displays a with a colored checker texture with numbers.



Color Space

Choose the color space type for the image.

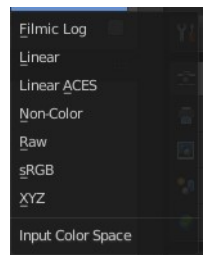

View as Render

Displays the image with the color management settings.

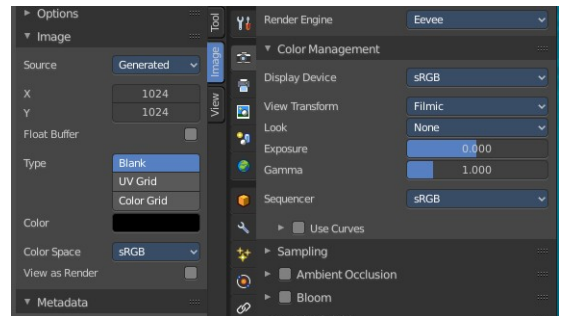

Source Type Movie + Image Sequence

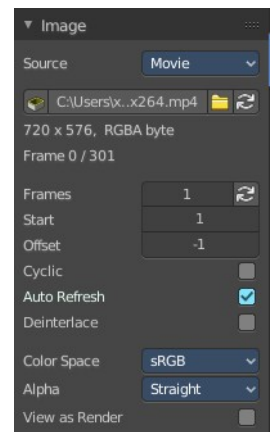

Path edit box

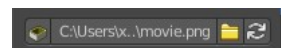

Pack

With this button you can pack the movie or the image sequence into the blend file. It gets packed when you

save the blend file the next time.

Path edit box

See and edit the path to your movie or image sequence files.

Open

Open a new movie or image sequence files. A file dialog will appear.

Refresh

Reread the movie or image sequence files.

Info string

Some information about the currently loaded movie. Frames, resolution and color space.

Frames

The number of frames of the movie or image sequence.

Match Movie Length

Set Users Image Length to the one of this video.

Start

The start frame of the movie or image sequence

Offset

Offset the number of the frame to use in the animation. -1 means off.

Cyclic

Cycle the images in the movie.

Auto Refresh

Always refresh image on frame changes.

Deinterlace

Deinterlace the movie file on load.

Color Space

Choose the color space type for the movie or image sequence files.

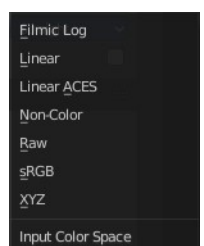

Alpha

Choose the alpha channel mode. Straight or Premultiplied.

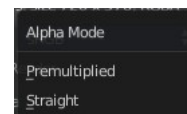

View as Render

Display the image with using the color management settings.

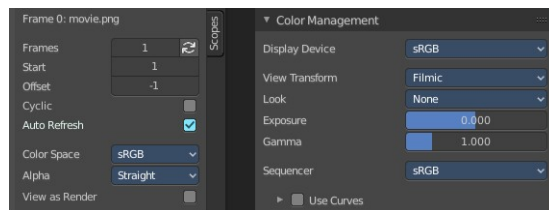

Source Type Single Image

Path edit box

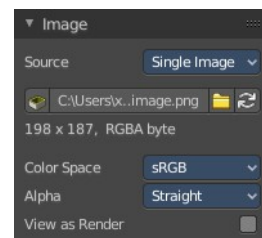
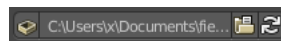

Pack

With this button you can pack the movie or the image sequence into the blend file. It gets packed when you save the blend file the next time.

Path edit box

See and edit the path to your movie or image sequence files.

Open

Open a new movie or image sequence files. A file dialog will appear.

Refresh

Reread the movie or image sequence files.

Info string

Some information about the currently loaded image. Resolution and color space.

Color Space

Choose the color space type for the movie or image sequence files.

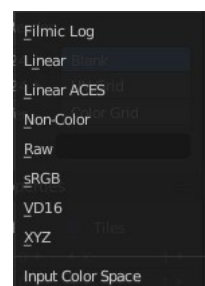

Alpha

Choose the alpha channel mode. Straight or Premultiplied.

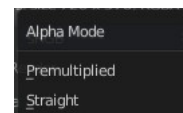

View as Render

Display the image with using the color management settings.

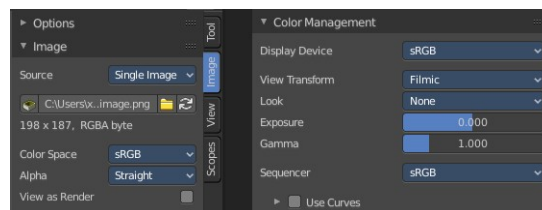

Source Type Udim

UDIM is an enhancement to the UV mapping and texturing workflow. And does not belong here. But in the UV Editor. It is just in the list because it shares the same menus with the UV Editor.





13.3.2 Editors - Shader Editor - Sidebar - Tool Tab

Table of content

Tool Tab.....1

Tool Tab

Contains the settings of the currently active tool in the tool shelf.

In the node editor we don't have something special here. The tool related settings are explained in the tool shelf chapter.

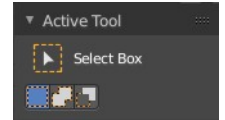



13.3.3 Editors - Shader Editor - Sidebar - View Tab

Table of content

View Tab - Annotation Panel.....	1
Annotations prop.....	1
Drop down box.....	1
Edit Box.....	1
Fake User.....	1
Add Annotation.....	2
Delete Annotation.....	2
List of Annotation Strokes.....	2
Thickness.....	2
Frame Locked/Unlocked.....	2
Onion Skin.....	2

View Tab - Annotation Panel

Contains view related settings. Which is in the node editor just the Annotations panel where you can manage the Annotation layers and materials.

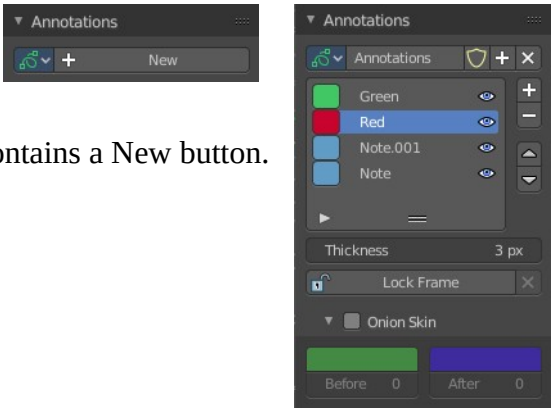

When you don't have drawn an annotation yet then the panel just contains a New button.

Annotations prop

Add, remove and rename new annotations.

Drop down box

A list of the available annotation layers.

Edit Box

The name of the current annotation. You can rename the annotation to your needs here.

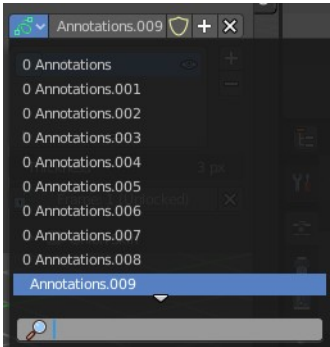

Fake User

Assign a fake user to this annotation. Fake users is an odd concept to keep data in the scene even if it has no user somewhere. The fake user is then a dummy user so that the object is not deleted when saving the scene.

Add Annotation

Add a new annotation.

Delete Annotation

Delete the annotation.

List of Annotation Strokes

Here you see your Annotation layers for the current Annotation. Every layer can have an own color.

At the right side you find buttons to sort them and to add and remove new Annotation layers.

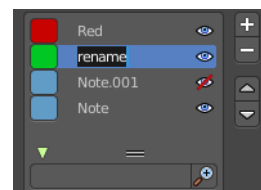

You can change the color by clicking at the color field. A color dialog will pop up. You can rename annotation layers by double clicking at it.

The eye icon allows you to make it invisible And it has a search field.

Thickness

The thickness of the annotation stroke.

Frame Locked/Unlocked

Lock frame displayed by current layer. This toggles whether the active layer is the only one that can be edited.

Onion Skin

Enable Onion Skinning.

Onion Skinning allows to show ghosts of the keyframes before and after the current frame. In this sub panel you can adjust the color of the onion skin frames.

With the numbers below the colors you can define how many frames before or after are displayed that way.

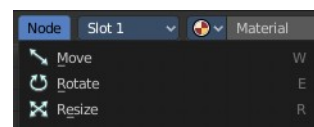



13.3.4 Editors - Shader Editor - Sidebar - Options Tab

Table of content

Options Tab - Settings panel.....	3
Settings panel with Eevee.....	3
Backface Culling.....	3
Blend Mode.....	3
Opaque.....	3
Alpha Clip.....	3
Alpha Hashed.....	3
Alpha Blend.....	3
Shadow Mode.....	3
None.....	4
Opaque.....	4
Alpha Clip.....	4
Alpha Hashed.....	4
Screen Space Refraction.....	4
Subsurface Translucency.....	4
Settings panel with Cycles.....	4
Pass Index.....	4
Surface sub panel.....	4
Multiple Importance.....	4
Transparent Shadows.....	4
Displacement.....	4
Volume Sub panel.....	4
Sampling.....	4
Interpolation.....	5
Homogeneous.....	5
Options Tab - Light panel.....	5
With Eevee.....	5
Type.....	5
Animate Property.....	5
Point light.....	5
Color.....	5
Animate Property.....	5
Power.....	5
Animate Property.....	5
Specular.....	5
Animate Property.....	5
Radius.....	5
Animate Property.....	6
Sun light.....	6
Color.....	6
Animate Property.....	6
Strength.....	6
Animate Property.....	6
Specular.....	6
Animate Property.....	6
Angle.....	6
Animate Property.....	6

Spot light.....	6
Color.....	6
Animate Property.....	6
Power.....	6
Animate Property.....	6
Specular.....	7
Animate Property.....	7
Radius.....	7
Animate Property.....	7
Area light.....	7
Color.....	7
Animate Property.....	7
Power.....	7
Animate Property.....	7
Specular.....	7
Animate Property.....	7
Shape.....	7
Animate Property.....	7
With Workbench.....	8
Type.....	8
With Cycles.....	8
Type.....	8
Point light.....	8
Color.....	8
Power.....	8
Size.....	8
Max Bounces.....	8
Cast Shadow.....	8
Multiple Importance.....	8
Sun light.....	9
Color.....	9
Strength.....	9
Angle.....	9
Max Bounces.....	9
Cast Shadow.....	9
Multiple Importance.....	9
Spot light.....	9
Color.....	9
Power.....	9
Size.....	9
Max Bounces.....	9
Cast Shadow.....	9
Multiple Importance.....	9
Area light.....	10
Color.....	10
Power.....	10
Shape.....	10
Max Bounces.....	10
Cast Shadow.....	10
Multiple Importance.....	10
Portal.....	10
Options Tab - Viewport Display panel.....	10
Color.....	10

Animate Property.....	10
Metallic.....	10
Animate Property.....	11
Roughness.....	11
Animate Property.....	11

Options Tab - Settings panel

In the Options tab you will find general shading options for the current material for the render engines Eevee and Cycles. The Workbench renderer does not have any extra shading options.

The options tab moves around, dependent of what render engine you have chosen. With cycles the tab is at the end of the list.

The Settings panel appears with a mesh object selected.

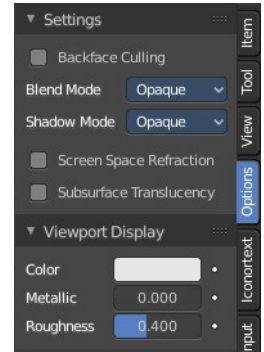

Settings panel with Eevee

Backface Culling

Hide the back sides of the geometry when rendering.

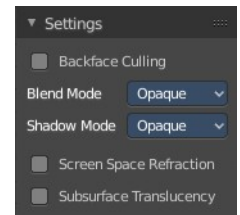

Blend Mode

The blend mode for transparent faces.

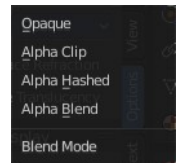

Opaque

Render the surface without transparency.

Alpha Clip

Use the alpha threshold to clip the visibility.

Alpha Hashed

Use noise to dither the binary visibility

Alpha Blend

Render polygon transparent, depending of the alpha channel of the texture.

Shadow Mode

The shadow mapping method.

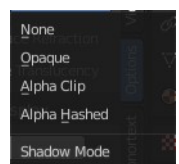

None

The material will cast no shadow.

Opaque

The material will cast shadow without transparency.

Alpha Clip

Use the alpha threshold to clip the visibility.

Alpha Hashed

Use noise to dither the binary visibility and use filtering to reduce the noise.

Screen Space Refraction

Use ray-traced screen space refraction's.

Subsurface Translucency

Add translucency effect to subsurface.

Settings panel with Cycles

Pass Index

Index number for the material render index pass

Surface sub panel

Multiple Importance

Use multiple Importance sampling for this material.

Transparent Shadows

Use transparent shadows for this material if it contains a Transparent BSDF

Displacement

Adjust the displacement method. Bump mapping is an old image based shader technique to fake displacement. Displacement deforms the geometry.

Volume Sub panel

Sampling

The volume sampling method.

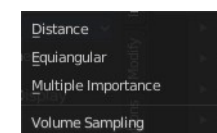
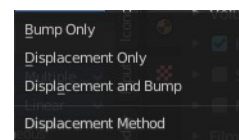
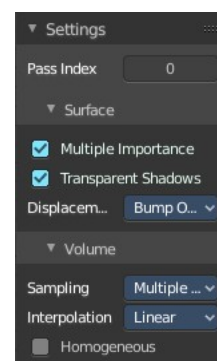

Interpolation

The volume interpolation method. Linear or cubic



Homogeneous

Use the same density for volume rendering.

Options Tab - Light panel

The Light panel appears with a light object selected.

With Eevee

Type

The light type. The light settings changes, dependent of what light type you have chosen.

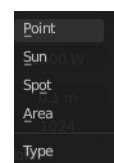
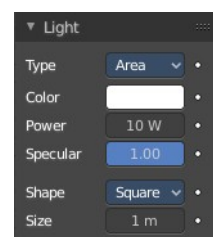

Animate Property

This property can be animated.

Point light

Color

The light color.

Animate Property

This property can be animated.

Power

The strength of the light in Watt.

Animate Property

This property can be animated.

Specular

Adjust the specular reflection multiplier.

Animate Property

This property can be animated.

Radius

The size of the point light.

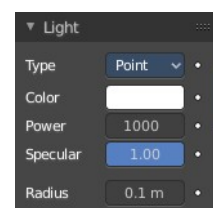

Animate Property

This property can be animated.

Sun light

Color

The light color.

Animate Property

This property can be animated.

Strength

The strength of the light. This value is not in Watt.

Animate Property

This property can be animated.

Specular

Adjust the specular reflection multiplier.

Animate Property

This property can be animated.

Angle

The angular diameter for the sun as seen from the earth.

Animate Property

This property can be animated.

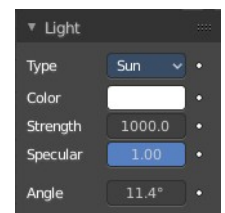

Spot light

Color

The light color.

Animate Property

This property can be animated.

Power

The strength of the light in Watt.

Animate Property

This property can be animated.

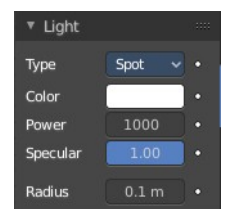

Specular

Adjust the specular reflection multiplier.

Animate Property

This property can be animated.

Radius

The size of the point light.

Animate Property

This property can be animated.

Area light

Color

The light color.

Animate Property

This property can be animated.

Power

The strength of the light in Watt.

Animate Property

This property can be animated.

Specular

Adjust the specular reflection multiplier.

Animate Property

This property can be animated.

Shape

The shape of the light emitting area of the light.

Size X / Y

The size of the light emitting area of the light.

Animate Property

This property can be animated.

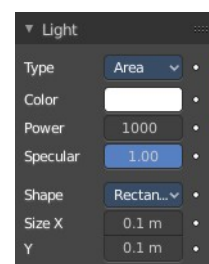

With Workbench

Type

The light type. The light settings changes, dependent of what light type you have chosen.

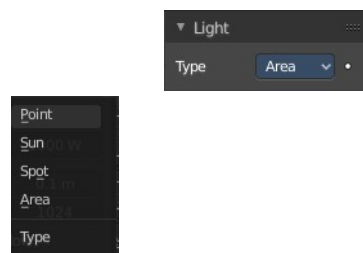

With Cycles

Type

The light type. The light settings changes, dependent of what light type you have chosen.

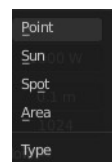
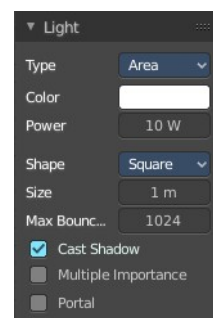

Point light

Color

The light color.

Power

The strength of the light in Watt.

Size

The size of the point light

Max Bounces

The maximum numbers of the bounces that this light will contribute to the render.

Cast Shadow

The light casts a shadow.

Multiple Importance

Use Multiple Importance sampling for this light.

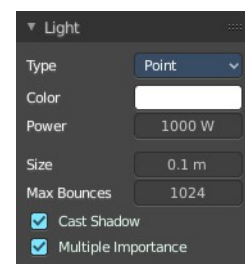

Sun light

Color

The light color.

Strength

The strength of the light. This value is not in Watt.

Angle

The angular diameter for the sun as seen from the earth

Max Bounces

The maximum numbers of the bounces that this light will contribute to the render.

Cast Shadow

The light casts a shadow.

Multiple Importance

Use Multiple Importance sampling for this light.

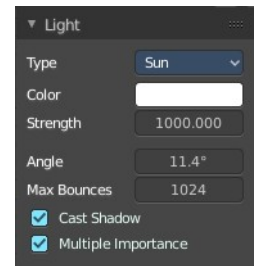

Spot light

Color

The light color.

Power

The strength of the light in Watt.

Size

The size of the point light

Max Bounces

The maximum numbers of the bounces that this light will contribute to the render.

Cast Shadow

The light casts a shadow.

Multiple Importance

Use Multiple Importance sampling for this light.

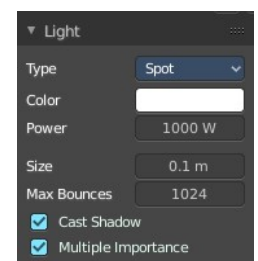

Area light

Color

The light color.

Power

The strength of the light in Watt.

Shape

The shape of the light emitting area of the light.

Size X / Y

The size of the light emitting area of the light.

Max Bounces

The maximum numbers of the bounces that this light will contribute to the render.

Cast Shadow

The light casts a shadow.

Multiple Importance

Use Multiple Importance sampling for this light.

Portal

Use this light to guide sampling of the background. This will make the light invisible.

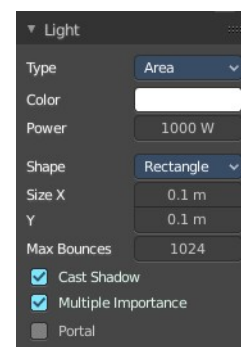

Options Tab - Viewport Display panel

Adjust how the mesh object is displayed in the viewport when the viewport shading in the 3D view is in solid mode.

The content is the same for all three render engines.

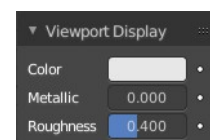

Color

The color.

Animate Property

This property can be animated.

Metallic

Metallic look.

Animate Property

This property can be animated.

Roughness

The roughness.

Animate Property

This property can be animated.



13.3.5 Editors - Shader Editor - Sidebar - Add Tab

Table of content

- Add Tab..... 1
 - Usage..... 1
- Add tab - Display Panel..... 1
 - Icon Buttons..... 1
 - Common..... 2

Add Tab

Here you can find the same nodes than in the Add menu. Panels are more convenient to use. They stay open for example. It's your decision with what system you want to work.

We won't explain the content of the panels again. The single nodes are explained in the add menu chapter.

Usage

Click at one of the node buttons, then move the mouse into the viewport. The created node sticks at the mouse. Click again to release it.

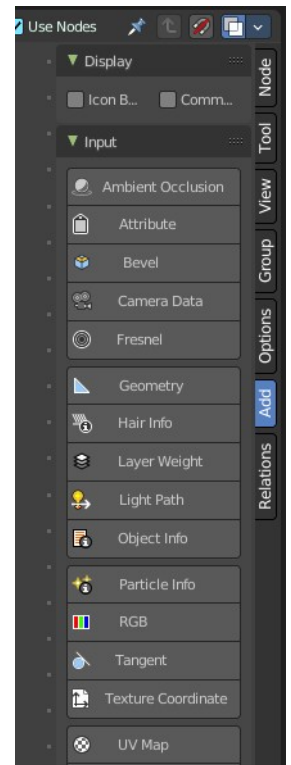
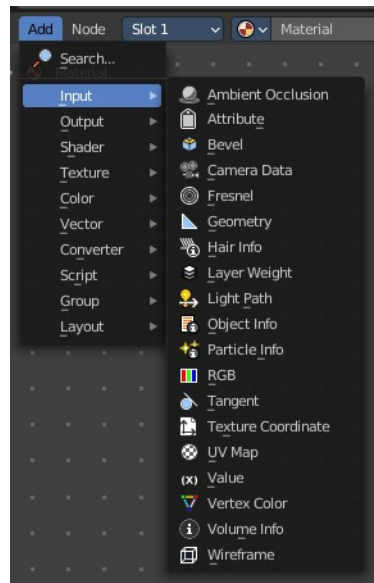

Add tab - Display Panel

Icon Buttons

You can display the nodes in the panels either as text buttons or as pure icon buttons.



Common

This checkbox allows you to display just the most common nodes for quicker search and find.

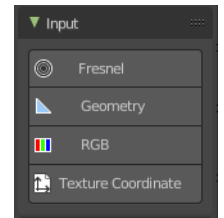



13.3.6 Editors - Shader Editor - Sidebar - Relations tab

Table of content

Relations tab - Display Panel.....	1
Icon Buttons.....	1
Relations tab - Group Panel.....	1
Make Group.....	2
Group Insert.....	3
Usage.....	3
Group Input.....	3
Group Output.....	3
Toggle Edit Group.....	3
Ungroup.....	3
Relations tab - Node Group Panel.....	3
Relations tab - Layout Panel.....	3
Frame.....	3
Adding and Removing Nodes.....	4
Resizing Frame.....	4
Label and Color.....	4
Reroute.....	4
Move, Rotate, Scale.....	5

Relations tab - Display Panel

Icon Buttons

You can display the nodes in the panels either as text buttons or as pure icon buttons.

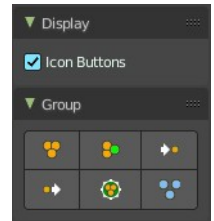

Relations tab - Group Panel

Node groups allows you to group different nodes of the material together to reduce the visual complexity. A node group acts like any other node.

Material node groups should not include Input nodes, like Image nodes, or Output nodes.

If you include a source node in your group, you will end up having the source node appearing twice: once inside the group, and once outside the group in the new material node tree.

If you include an output node in the group, there will not be an output socket available from the group!

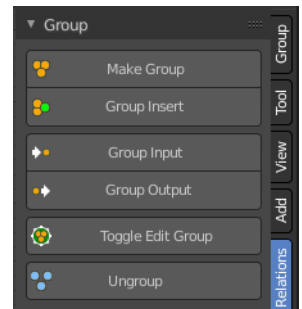

Make Group

Groups the selected nodes together.

Select the nodes that you want to group together. Choose Make Group. You will now see a green background. This indicates that the group is created, and that you are in edit mode for the group now.

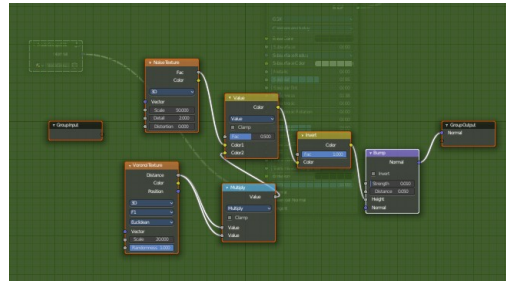
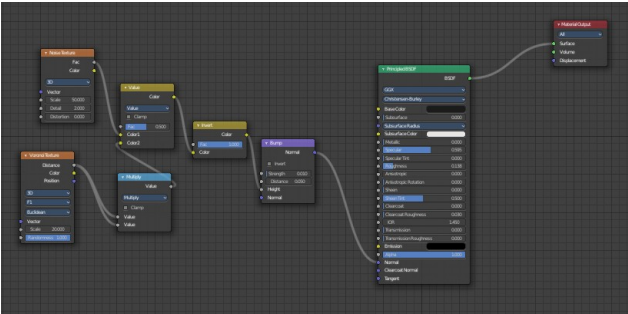

To exit the group edit mode press Tab key, or choose Toggle Edit Group menu item . That way you can also enter the Group Edit mode again.

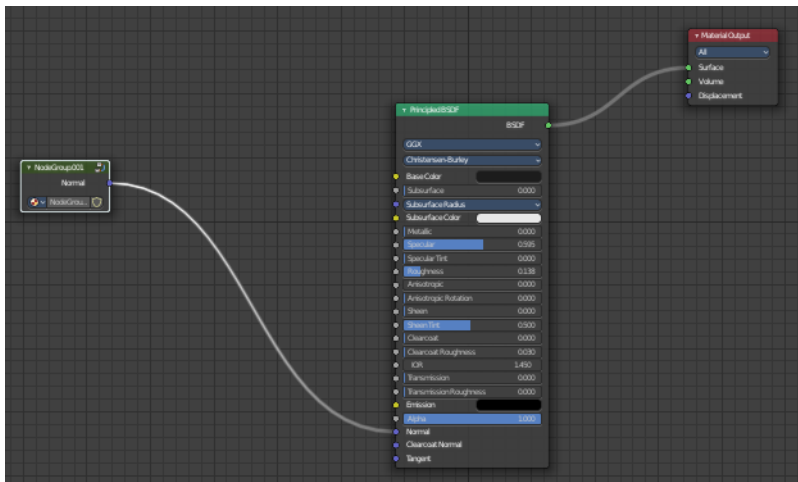

There is a third way to enter the group edit mode. Click at the right upper icon of the group node.

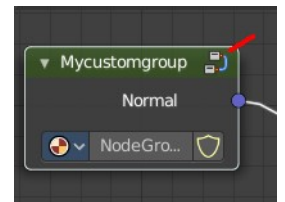

A group can be further collapsed by clicking at the triangle button in the upper left corner.

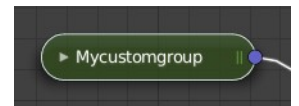

The group can be renamed in the sidebar in the Item tab and in the Properties tab in the Node panel.

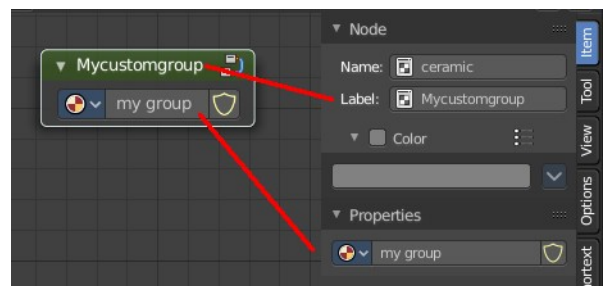

Group Insert

Inserts the selected node into the selected group.

Usage

Select the node.

Hold down shift, and select the group.

Click the Group Insert button. The node will now be part of the group, and you will land in group edit mode.

Press tab to exit the group edit mode.

Group Input

Adds a group input node.

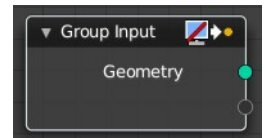

Group Output

Adds a group output node.

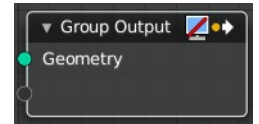

Toggle Edit Group

Enter or exit the edit group mode.

Ungroup

Ungroups an existing group. You need to be outside of the group edit mode.

Relations tab - Node Group Panel

When you create a node group, then this node group is listed here. And can be dragged from there for reuse too.

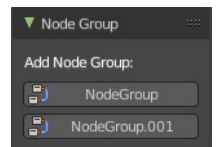

Relations tab - Layout Panel

These nodes helps organizing the node layout.

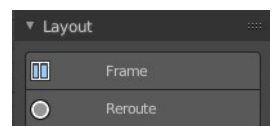

Frame

The Frame node allows you to drop nodes into a frame. This frame can be dragged around as a whole.

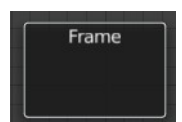

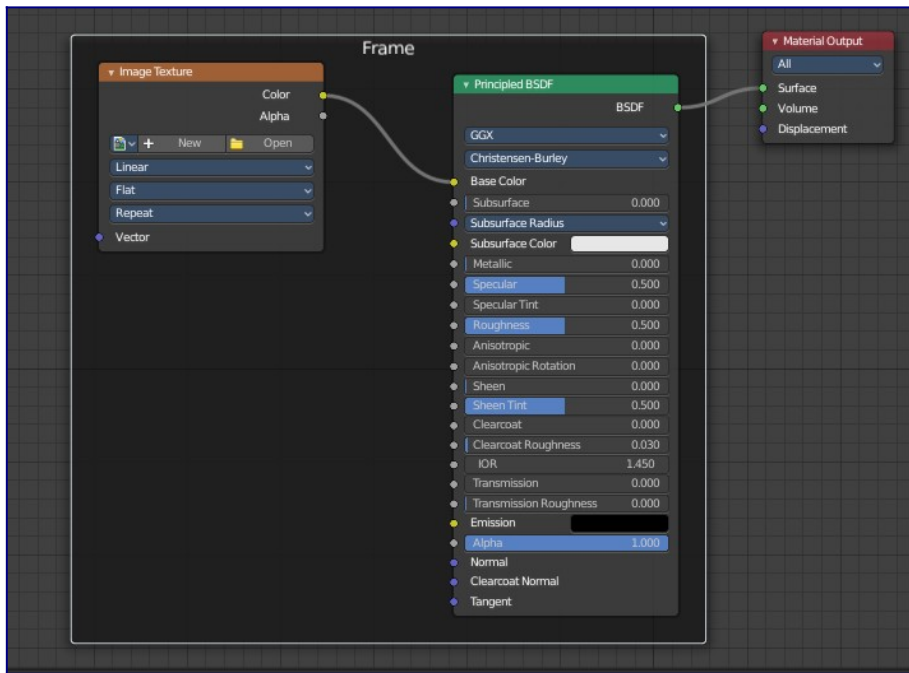

Adding and Removing Nodes

Nodes can be added by simply dropping them onto the frame. Or with the Join in New Frame menu item in the Node menu.

To remove a node from the frame use Remove from Frame.

Resizing Frame

When the Frame node is first placed in the node editor workspace you can resize it by dragging one of the edges.

Once a node is placed in the Frame, the Frame shrinks around the nodes. You cannot resize it anymore with handlers. Just by dragging around the nodes inside of the frame.

This behavior can be changed by disabling the *Shrink* option in the Item tab in the Properties panel. Then you can resize the frame again by dragging the edges.

Label and Color

You can change the name of a frame in the Node panel. And you can give it a custom color by checking the Color checkbox and adjusting the color then.

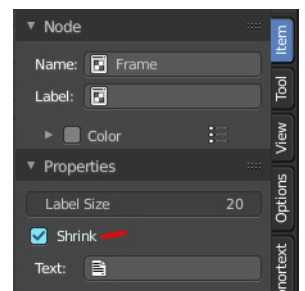
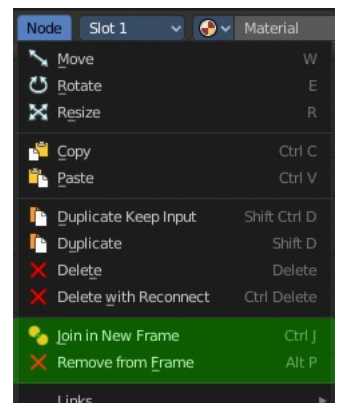

Reroute

Adds a reroute point that can be used to reroute connections. It allows just one input, but allows multiple output connections.

To quickly add a Reroute node into an existing connection, hold Shift and Right Mouse and drag the mouse to

cut through the link. A new reroute node will be added.

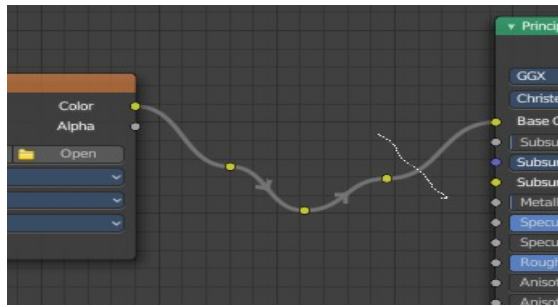
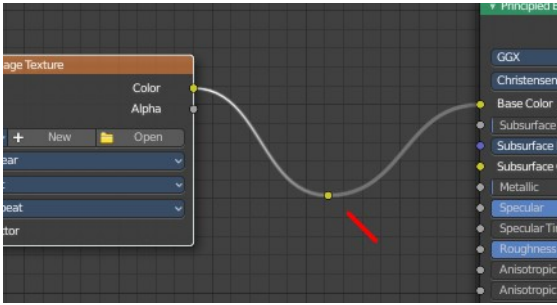

When you exceed a specific angle amount between the reroute nodes, then the node connection becomes a sharp corner, and not longer a Bezier like soft curve.

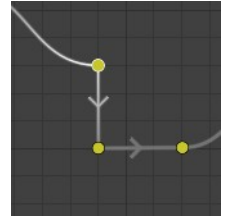

Move, Rotate, Scale

A normal node has a handler. The reroute dot not. You can't simply move it around with the mouse by clicking at the top area. It has none. You have to use the move, rotate and scale commands. They can be found in the View menu.

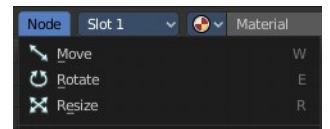



14 Editors - Video Sequence Editor

Table of content

Video Sequence Editor.....	3
Type of Sequencer View.....	3
Drag n Drop.....	4
Last operator Add Movie / Image etc. Strip.....	4
Relative Path.....	4
Start Frame.....	4
End Frame.....	4
Channel.....	4
Replace Selection.....	4
Sound.....	4
Use Movie Frame rate.....	4
Navigating in the viewport.....	4
Hotkeys.....	4
Strips.....	5
Strip Types.....	5
Move Strips.....	5
Resizing strips.....	5
Last operator Sequence Slide.....	5
Offset X.....	5
Y.....	5
Preview - Sequencer Preview context menu.....	6
Sequencer - Sequencer context menu.....	6
Split.....	6
Last operator Split Strips.....	6
Frame.....	6
Channel.....	6
Type.....	6
Use Cursor Position.....	6
Side.....	7
Copy.....	7
Paste.....	7
Duplicate Strips.....	7
Rename.....	7
Delete.....	7
Slip Strip Contents.....	7
Last Operator Trim Strips.....	7
Offset.....	7
Snap Strips to the current frame.....	7
Last Operator Snap Strips to the current frame.....	7
Frame.....	7
Set Preview Range to Strips.....	7
Remove Gaps.....	8
Last operator Remove Gaps.....	8
All Gaps.....	8
Insert Gaps.....	8
Last operator Insert Gaps.....	8
Frames.....	8

Cross fade Sounds.....	8
Add Strip Modifier.....	8
Fade.....	8
Last operator.....	8
Fade Duration.....	8
Fade Type.....	8
Clear Fade.....	9
Movie Strip.....	9
Set Render Size.....	9
Deinterlace Movies.....	9
Effect Strip.....	9
Change Effect Input.....	9
Change Effect Type.....	9
Reassign Inputs.....	9
Swap Inputs.....	9
Make Meta Strip.....	10
UnMeta Strip.....	10
Toggle Meta.....	10
Set Color Tag.....	10
Lock/Mute.....	10
Lock Strips.....	10
Unlock Strips.....	10
Mute Strips.....	10
Last operator Mute Strips.....	10
Unselected.....	10
Unmute Strips.....	10
Last operator Unmute Strips.....	11
Unselected.....	11
Mute unselected strips.....	11
Last operator Mute Strips.....	11
Unselected.....	11
Unmute deselected Strips.....	11
Last operator Unmute Strips.....	11
Unselected.....	11
Quick Favorites menu.....	11
Slider snapping.....	11
Hotkey only functionality.....	11
Context Set - O.....	12

Video Sequence Editor

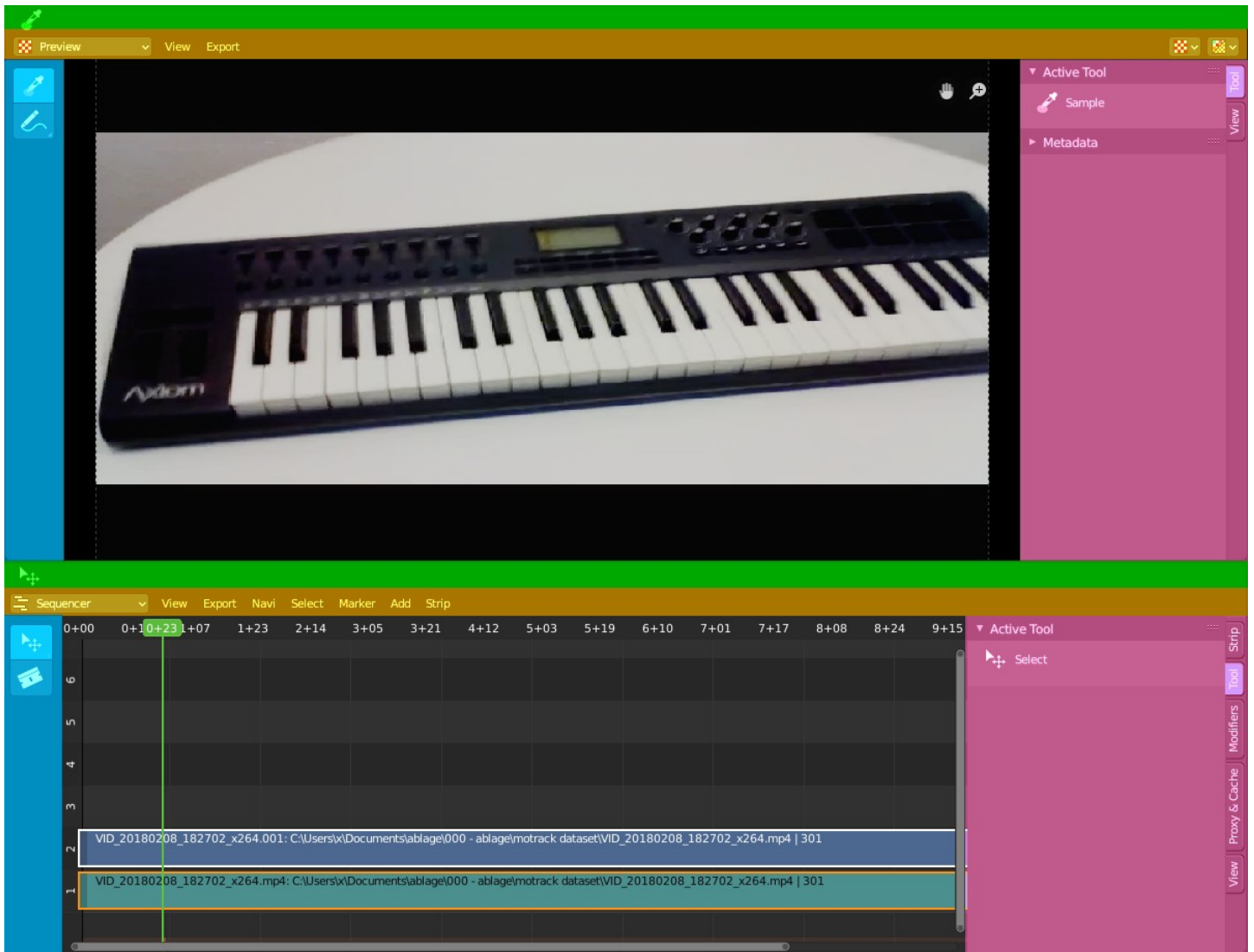

The Video Sequence Editor is a complete video editing system. It allows you to cut videos and add effects and audio.

Type of Sequencer View

The Video Sequence Editor is two editors in one. The Preview sequencer view is a preview window. Here plays the video. The Sequencer sequencer view is the view that contains the the video and audio strips. The third method is both editor view types in one editor.

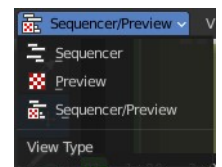

Both editor view types are divided into several areas.

Green - Tool area. Note that, different from the 3D view, the tool area cannot be hidden away.

Yellow – Header

Blue - Tool Shelf

Pink - Sidebar

Drag n Drop

You can drag n drop several elements like movie and audio clips into the Sequencer timeline. In this case you get the import options from the file browser displayed in the adjust last operator panel. The settings are pretty similar.

Last operator Add Movie / Image etc. Strip

When you drop a strip then you will get a last operator panel down left.

Relative Path

Select the file relative to the blend file.

Start Frame

The start frame of the strip.

End Frame

The end frame of the strip

Channel

The channel to place this strip into.

Replace Selection

Replace the current selection.

Sound

Load the audio of the movie.

Use Movie Frame rate

Use the frame rate from the movie to keep sound and video in sync.

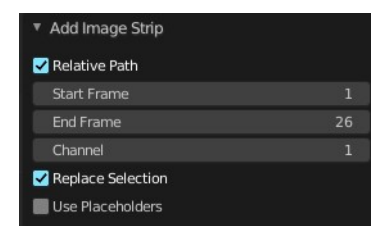
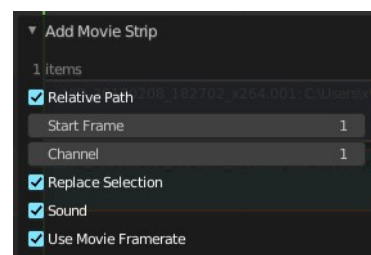

Navigating in the viewport

Hotkeys

Pan the view - MMB

Zoom - Mouse Wheel, MMB+CTRL, Numpad + / -

View All - Home

Deselect - left click into the off.

Select - left click

Add to selection - Shift + left click

Strips

An element in the sequencer timeline is called strip. Strips are represented as bars.

Every strip displays the name of the strip up left.

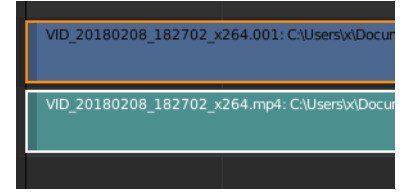

Strip Types

Videos can also contain audio. When you import a video with audio, then you will have two strips in the timeline. A video strip that contains the image material. And an audio strip that contains the sound.

But the sequencer does not only display video and audio strips. There are several more strip types available. You can in the Add menu load image sequences, single images, masks, and even whole scenes.

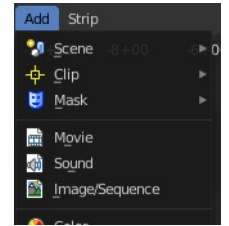

Move Strips

To move strips in the sequencer timeline select the strip and drag it. Upwards will put it into another channel. Sideways will move it in the timeline.

Resizing strips

A strip has a drag handler at the left and a drag handler at the right. This handler allows you to resize the strip.

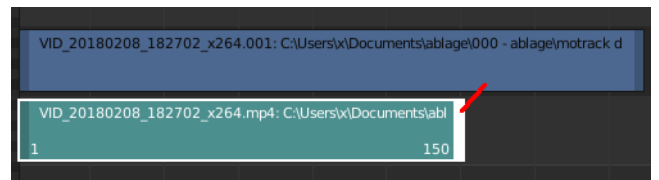

When the handlers are active you will see the frame numbers at the start and/or end of the clip. You can't move the strip as a whole while one of the handlers is active. Click in the off to deactivate the handlers. Then you can move the whole clip again.

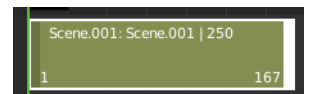

Last operator Sequence Slide

This adjust last operator shows for both, move strips and resize strips.

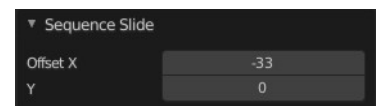

Offset X

The modified frame position, relative to the start position of the strip.

Y

The modified channel position, relative to the start position of the strip.

Preview - Sequencer Preview context menu

When you right click into the preview window then you will call a menu.

Allows you to rename the active sequence strip.

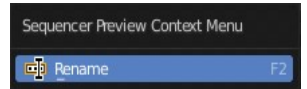

Sequencer - Sequencer context menu

When you double right click into the Sequencer view, then you will open a menu. The Sequencer Context menu. Its content is to 100% double content to already existing menu entries. And it is despite the name not contextual.

The menu content differs, dependant of which sort of strip is selected

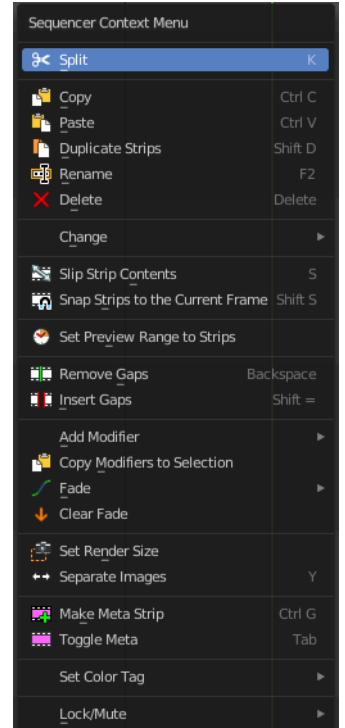
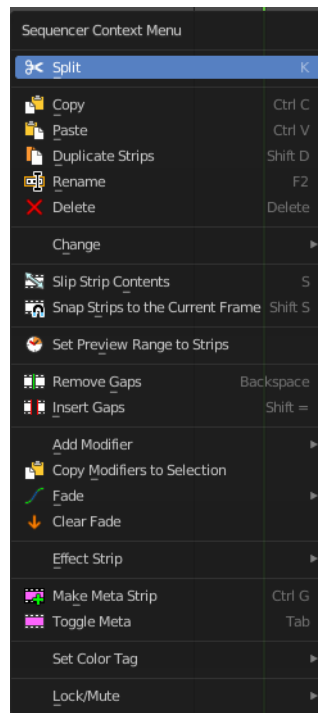

Split

Splits the selected strips at the chosen mouse position.

Last operator Split Strips

Frame

The frame at which the split happens.

Channel

The channel

Type

Split type. Soft or hard.

Use Cursor Position

Split the strip at the cursor position instead of the current frame.

This feature is pretty useless since you adjust this setting afterwards, after you have already cut at the current frame. There is no cursor position available anymore.

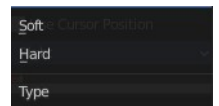
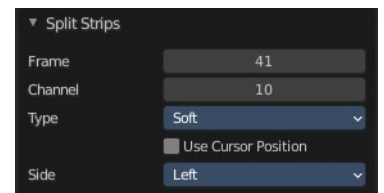

Side

The side that remains selected after splitting.

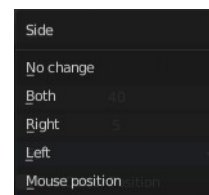

Copy

Copies the selected strips.

Paste

Pastes the copied strips. The strip will be pasted to the next free channel.

Duplicate Strips

Duplicates the selected strips. The duplicate will stick to the mouse. Move the duplicate with the mouse, then click to release. In case of overlapping strips the duplicate will snap behind the strip under the mouse.

Rename

Allows you to rename the current active strip. A popup opens up where you can type in another name.

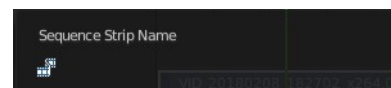

Delete

Deletes the selected nodes. All Connections gets removed.

Slip Strip Contents

The Slip tool allows you to change the position of the contents of a strip without moving the strip itself.

Last Operator Trim Strips

Offset

The offset of the content to the strip.



Snap Strips to the current frame

Snaps the selected strips to the current frame.

Last Operator Snap Strips to the current frame

Frame

The frame to snap to.

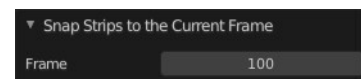

Set Preview Range to Strips

Sets the preview range to the selected strips. The playback will then happen in this range.

Remove Gaps

Snaps the selected strip to the end of the strip before the selected one.

Last operator Remove Gaps

All Gaps

Snaps all strips to the ends of the previous strips to close all gaps.

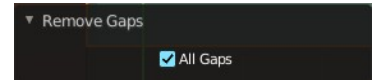

Insert Gaps

Insert a gap of frames before the selected strip.

Last operator Insert Gaps

Frames

The number of frames to insert.



Cross fade Sounds

Audio Strips only. And you need to have two strips selected. Cross fade two selected audio strips.

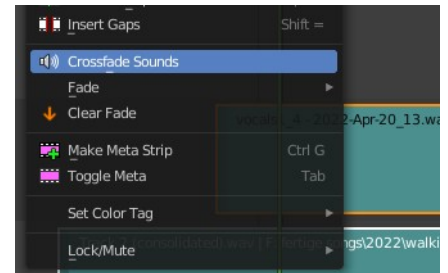

Add Strip Modifier

All strip types but Sound. Adds a strip modifier. Strip modifiers are explained in the sidebar chapters.

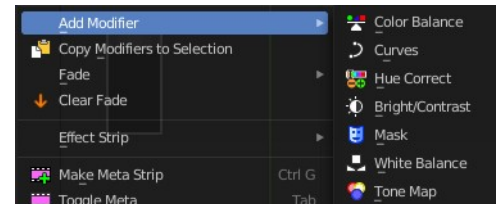

Fade

Fade effects for strips. The names should be self explaining.

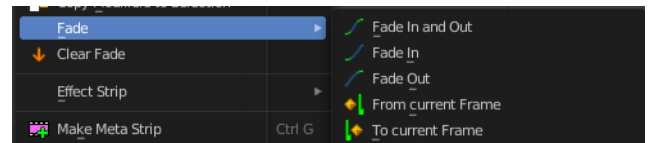

Last operator

Fade Duration

The duration of the fade.

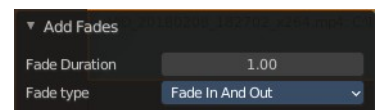

Fade Type

The fade type to choose.

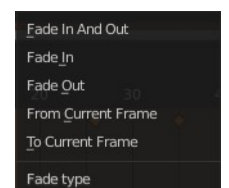

Clear Fade

Clears the fade effects at the selected strips.

Movie Strip



Set Render Size

Sets the render resolution and aspect to match the strip's resolution.

Deinterlace Movies

Converts interlaced video into progressive video.

Effect Strip

Strip type Effects.

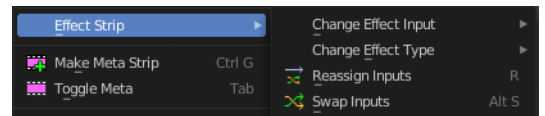

Change Effect Input

Changes the effect input of two selected effect strips.

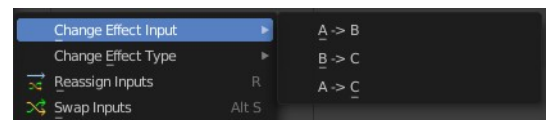

Unfortunately not to find out how this works.

Change Effect Type

Sets the effect type to a new chosen type.

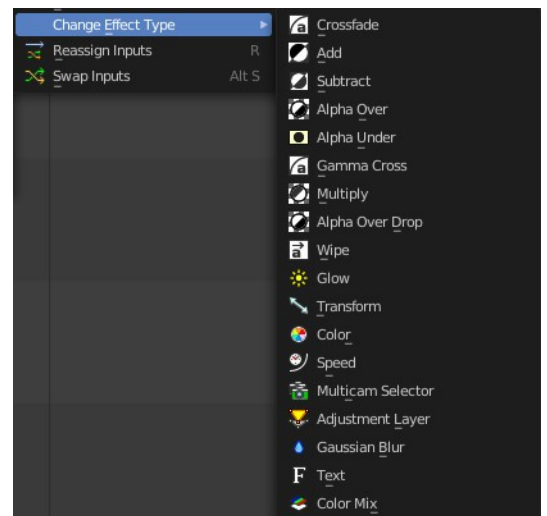

Reassign Inputs

Reassigns the input of the strips.

Unfortunately not to find out how this works.

Swap Inputs

Swaps the inputs of the selected strips.

Unfortunately not to find out how this works.

Make Meta Strip

Creates a meta strip out of the selected strips. A Meta Strip is a strip which contain multiple strips treated as if it was one strip. It allows you to reduce the vertical space used in the Sequencer. You can edit it the same way as any other strips.

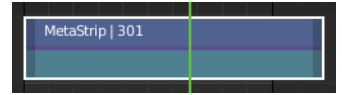

Note! The default blend mode for a Meta strip is Replace. There are many cases where this alters the results of the animation so be sure to check the results and adjust the blend mode if necessary.

UnMeta Strip

Separating (ungrouping) the Meta strip restores the strips to their relative positions and channels.

Toggle Meta

Toggles between the meta and unmeta state. You need to have a meta strip in the sequencer timeline already.

Set Color Tag

Changes the header or the body color of the selected strip. This depends of the strip type.



Lock/Mute

Lock Strips

Locks the strip from editing. They can't be moved or edited anymore.

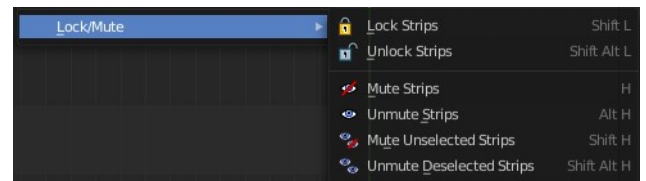

Locked strips appears hatched.

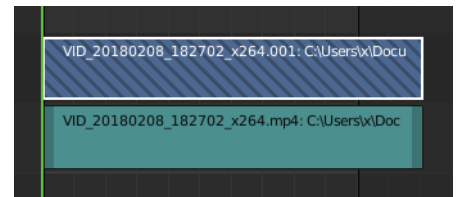

Unlock Strips

Unlock locked strips.

Mute Strips

Mutes the selected strips. They do not play anymore, and they appear greyed out.

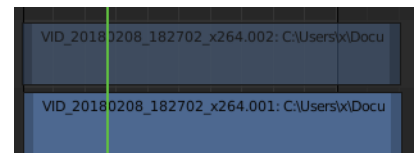

Last operator Mute Strips

Unselected

Mute unselected strips.

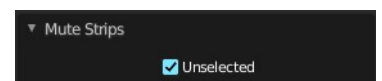

Unmute Strips

Unmutes selected muted strip.

Last operator Unmute Strips

Unselected

Unmute unselected strips.

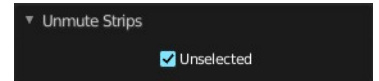

Mute unselected strips

Mute the unselected strips.

Last operator Mute Strips

Unselected

Mute unselected strips.

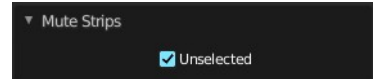

Unmute deselected Strips

Unmute all deselected strips.

Last operator Unmute Strips

Unselected

Unmute unselected strips.

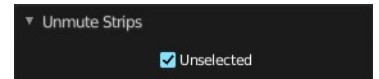

Quick Favorites menu

When you right click at a menu or a button, then a right click menu will open. Tools have usually a Add to Quick Favorites menu entry.

The Quick Favorites Menu is empty by default. With Add to Quick favorites you can add this menu to the Quick menu.

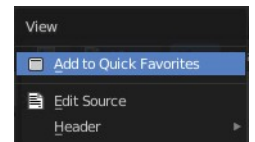
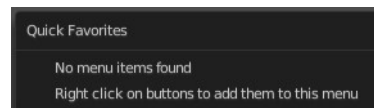

In the 3D view we have a menu called Quick in the header, which shows this content then. In the Image Editor you can just call it with its hotkey. Q. It has no regular menu entry here.

Slider snapping

Snapping also works at sliders. Hover with the mouse over the slider, start to slide, and holding down **Ctrl** will snap the sliders in incremental steps.



When it's a default value between 0 and 1 then it usually snaps in 0.1 steps. When it's a default value over 1 then it usually snaps in steps of 10.

Hotkey only functionality

Important! These hotkeys works with the default Bforartists key map And they do not list the N dof hotkeys. N dof is a 3d connexion mouse device that is also used for tablets.

Most of the tools can be found in the graphical UI. But there are still some tools that are hotkey only. Some have a UI brother with equal functionality. For example, Pick shortest path is the hotkey sister of Select shortest path. Some are hotkey only since they cannot be integrated in the graphical UI. Like calling the File menu under the mouse. Or mouse position dependent functionality like selecting an edge loop.

The navigation hotkeys and the context menus are excluded here since they are already covered.

Context Set - O

Preview view. Context Set for overlay frame. Calls a box select tool.

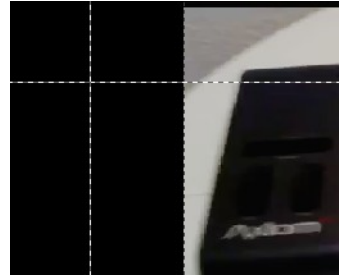



14.1 Editors - Video Sequence Editor - Header

Table of content

- Video Sequence Editor - Header.....1
- Header right click menus.....1
- Editortype Menu.....1

Video Sequence Editor - Header

The Header contains some menus and settings.

The header is divided into two areas. Left Type of sequencer view plus menus. Right settings.



Header right click menus

The general right click menu functionality is explained in chapter 6 Editors introduction.

Editortype Menu

Bforartists is made of several editor types. Headers can display a menu where you can switch to other editor types.

This menu is hidden by default. It is meant to edit the layouts, and should not be necessary for regular work. You can reveal it in the header right click menu.

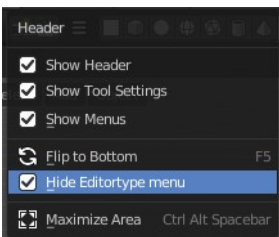
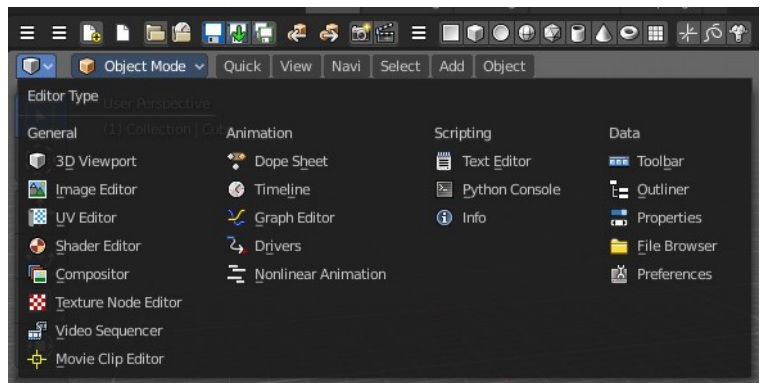



14.1.1 Editors - Video Sequence Editor - Header - Tools and Options

Table of content

Detailed table of content.....	1
Header tools and options - Preview view.....	3
Pivot Point.....	3
Display Mode.....	3
Display Channels.....	3
Show Gizmo.....	4
Show Overlay.....	4
Options.....	4
Show Metadata.....	4
Zoom to Fit.....	4
Header tools and options - Sequencer View.....	5
Overlap Mode.....	5
Snap.....	5
Show Overlay.....	6
Options.....	6
Preview as Backdrop.....	6
Show Seconds.....	7
Sync visible range.....	7
Cache.....	7
Show Markers.....	7
Lock Markers.....	7
Sync Markers.....	7
Limit View to Content.....	8
Header tools and options - Sequencer & Preview view.....	8

Detailed table of content

Detailed table of content

Detailed table of content.....	1
Header tools and options - Preview view.....	3
Pivot Point.....	3
Display Mode.....	3
Image Preview.....	3
Luma Waveform.....	3
Chroma Vectorscope.....	3
Histogram.....	3
Display Channels.....	3
Color and Alpha.....	3
Color.....	4
Show Gizmo.....	4
Viewport Gizmos.....	4
Show Overlay.....	4
Preview Overlays.....	4
Image Outline.....	4

2D Cursor.....	4
Frame Overlay.....	4
Safe Areas.....	4
Metadata.....	4
Annotations.....	4
Options.....	4
Show Metadata.....	4
Zoom to Fit.....	4
Header tools and options - Sequencer View.....	5
Overlap Mode.....	5
Expand.....	5
Overwrite.....	5
Shuffle.....	5
Snap.....	5
Snapping Settings.....	5
Snap to.....	5
Current Frame.....	5
Hold Offset.....	5
Ignore.....	5
Muted Strips.....	5
Sound Strips.....	5
Snap Current Frames to Strips.....	5
Show Overlay.....	6
Name.....	6
Source.....	6
Duration.....	6
Color Tags.....	6
Offset.....	6
F-Curves.....	6
Thumbnails.....	6
Grid.....	6
Waveform Display.....	6
Options.....	6
Preview as Backdrop.....	6
Preview during translation.....	7
Show Seconds.....	7
Sync visible range.....	7
Cache.....	7
Show Cache.....	7
Final Images.....	7
Raw Images.....	7
Pre Process Images.....	7
Composite Images.....	7
Show Markers.....	7
Lock Markers.....	7
Sync Markers.....	7
Limit View to Content.....	8
Header tools and options - Sequencer & Preview view.....	8

Header tools and options - Preview view



Pivot Point

The Pivot Point is the center of your object or your selection. The names should be self explaining.

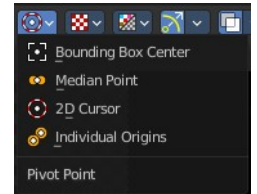

Display Mode

How to display the preview video.

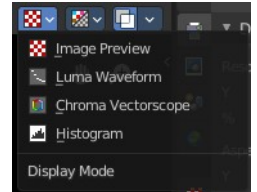

Image Preview

Displays the image material.



Luma Waveform

Displays the luma waveform of the image.

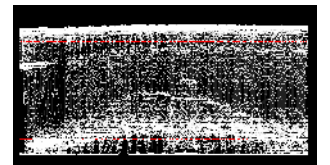

Chroma Vectorscope

Displays the chroma vectorscope of the image.

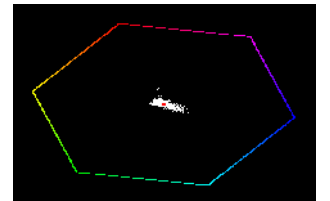

Histogram

Displays a histogram of the image.

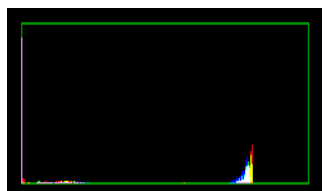

Display Channels

What channels of the video to display.

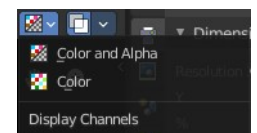

Color and Alpha

Display the color channels and alpha channel.

Color

Display just the color channels.

Show Gizmo

Show or hide the viewport gizmos.

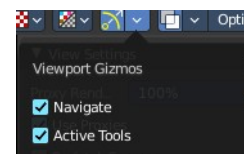

Viewport Gizmos

What kind of gizmos to show.

Show Overlay

Turn on or off all overlays.

Preview Overlays

Image Outline

Outline the selected image element.

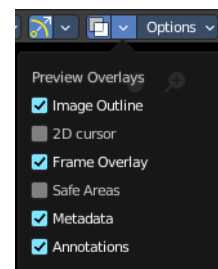

2D Cursor

Show the 2d cursor.



Frame Overlay

Show the frame overlays.

Safe Areas

Show the safe area overlays.

Metadata

Show the Metadata overlay.

Annotations

Show the annotations.

Options

Show Metadata

Show metadata of first visible strip in the viewport.

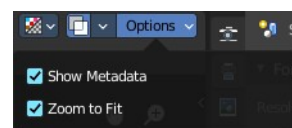

Zoom to Fit

Automatically zoom preview image to fully fit into the preview window. Note that zooming in or out turns off the feature then.

Header tools and options - Sequencer View



Overlap Mode

How to resolve overlap after transformation.

Expand

Move strips until there is no overlap anymore.

Overwrite

Trim or split strips to resolve overlap.

Shuffle

Move transformed strip to nearest free space to resolve overlap.

Snap

Snap to strip edges or current frame.

Snapping Settings

Snap to

Current Frame

Snap to the current frame

Hold Offset

Snap to strip Hold offsets.

Ignore

Muted Strips

Ignores muted strips.

Sound Strips

Ignores sound strips.

Snap Current Frames to Strips

Sets the current frame to the start or end point of the selected clip.

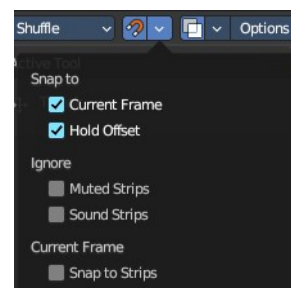
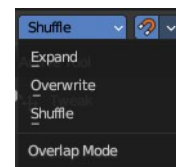

Show Overlay

Turn on or off all overlays.

Name

Show the name of the clip.

Source

Show the source of the clip.

Duration

Display the duration of the clip.

Color Tags

Display the strip color tags in the sequencer.

Offset

What offset frame to use, relative to the current frame position.

F-Curves

Display the strip opacity/Volume curve.

Thumbnails

Draw thumbnails as strip overlay. This works for movie and image strips. To draw thumbnails, this overlay has to be enabled and strips must be tall enough.

Grid

Show the grid lines.

Waveform Display

How wave forms are drawn.

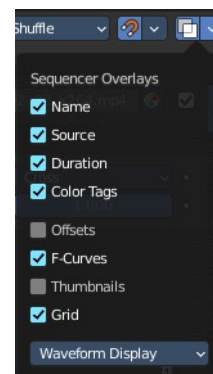

Options

Preview as Backdrop

Display the result as a backdrop under the strips.

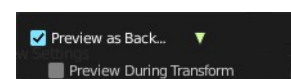
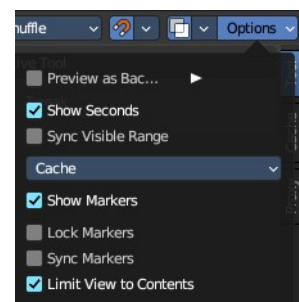

When you turn on Preview as Backdrop, then you will activate the View Settings, Frame Overlay and Scene Strip Display panels from the Preview mode. Please have a look there for the descriptions.

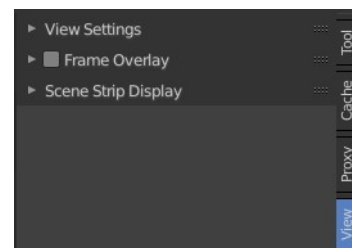

Preview during translation

Show a preview of the transformed frames.

Show Seconds

Show the timing in the timeline area in seconds instead of frames.

Sync visible range

Synchronize the visible timeline range with other visible time based editors.

Cache

Cache settings.

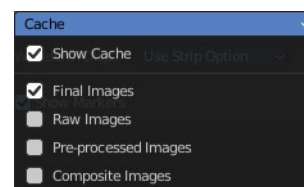

Show Cache

Visualize cached images in the timeline.

Final Images

Show the final images.

Raw Images

Show the raw images.

Pre Process Images

Show the pre process images.

Composite Images

Show the composite images.

Show Markers

Display the markers menu and the markers at the bottom in the timeline.

Lock Markers

Prevent marker editing.

Sync Markers

Transform markers with the strips.

Limit View to Content

Limit timeline height to maximum used channel slots.

Header tools and options - Sequencer & Preview view

The tools in the Sequencer & Preview view mode are usually the same than in the single modes. Both showing at the same time. With one exception in the options panel. Preview as backdrop is not showing in this mode.

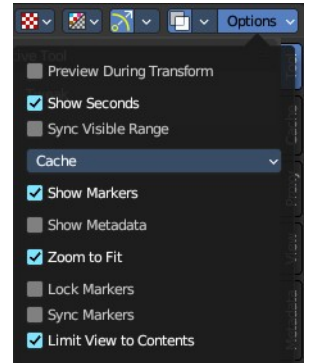

14.1.10 Editors - Video Sequence Editor - Header - Image Menu

Table of content

Image menu.....	1
Clear.....	1
Position.....	1
Scale.....	1
Rotation.....	1
All Transforms.....	1
Apply.....	1
Scale to Fit.....	1
Scale to Fill.....	1
Stretch to Fill.....	2

Image menu

The Image menu contains strip related functionality. The images of the strips can be transformed in the preview window.

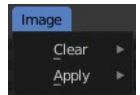

Clear

Position

Resets the position of the image.

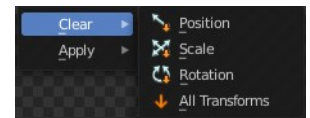

Scale

Resets the scale of the image.

Rotation

Resets the rotation of the image.

All Transforms

Resets all transformations of the image.

Apply

Apply does NOT apply, it scales the images in various ways.

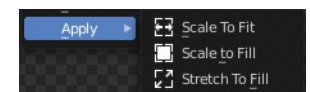

Scale to Fit

Scales the image to fit in the preview window in at least one direction.

Scale to Fill

Scales the image so that the whole preview window is covered.

Stretch to Fill

Stretches the image so that the whole preview window is covered.

14.1.2 Editors - Video Sequence Editor - Header - Quick Menu

Table of content

- Quick Menu.....1
- Adding an operator to the Quick menu.....1
- Adding a menu to the Quick menu.....1
- Order.....2
- Removing an operator from the Quick menu.....2
- Context and mode dependent content.....2

Quick Menu

The quick menu, or in long Quick Favorites menu, is a menu that can be customized to your needs. Here you can add operators for quick access.

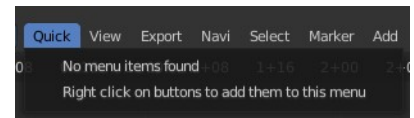

It is located in the header. But it can be called by hotkey Q directly under the mouse. This hotkey works in other editors too.

When the menu is empty, then you will see the message "No Menu Items found". This means that you first have to add some tools to the menu. It is a user configurable menu.

Note that added operators in this menu does not have icons. Just text.

Adding an operator to the Quick menu

Open the panel or the menu where your operator is that you want to add.

Let's add the open command from the File menu. Open the File menu, right click at open, and choose Add to Quick Favorites.

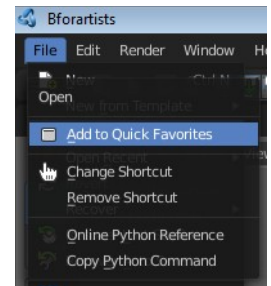

Do the same with Save As. We should now have two new menu items in the Quick menu, which you can use now.

As a rule of thumb, when the right click menu has an Add to Quick Favorites, then you can add it to the quick menu.

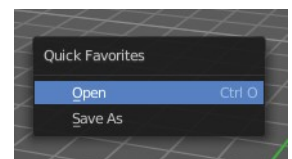

Note that you can also add operators from the tool shelf at the left. And also operators from other editor types. Some other editors have their own quick menu though. The Image Editor for example. These operators gets added in the quick menu of the image editor then. And does not show in the quick menu in the header of the 3D view.

Adding a menu to the Quick menu

It is also possible to add a menu to the Quick menu. For example the whole Add menu. The way is the same. Right click at it, and choose Add to Quick Favorites.

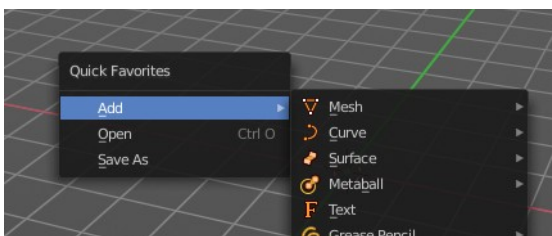
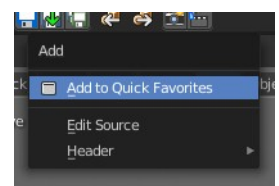

Order

You might notice that the add menu adds at the top of the menu, and not at the bottom as you would expect. First comes menus, then comes operators. And they get added in the order in which you add them.

Besides that, operators and menus gets added in the order that you add them. They cannot be sorted afterwards. So be careful how you add them. You can of course always remove operators and menus, and re-add them at the end of the list.

Removing an operator from the Quick menu

Removing is as simple as adding. Right click at the operators in the Quick menu, and choose Remove from Quick favorites.

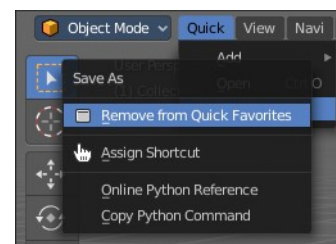

Context and mode dependent content

The quick favorites. menu exists in nearly all editors. But it is just in the 3D view available in the header. So that you know this functionality exists. In the other editors you call it with hotkey Q.

The content of the quick favorites. menu changes, dependent over which editor you are, and in what mode you are. When you add for example an operator from the image editor, then this operator just shows in the quick menu when you call the menu from the image editor. Same goes for the modes. Edit mode tools will just show in edit mode. And so on.



14.1.3 Editors - Video Sequence Editor - Header - View Menu

Table of content

Type of Sequencer View.....	2
View Menu in Preview window.....	2
Toolbar.....	3
Sidebar.....	3
Tool Settings.....	3
Tool shelf tabs.....	3
Annotations.....	3
Draw Annotation.....	3
Draw Line Annotation.....	3
Draw Polyline Annotation.....	3
Erase Annotation.....	3
Add Annotation Layer.....	3
Erase Annotation Active Keyframe.....	3
Zoom In.....	4
Zoom Out.....	4
Fit Preview in Window.....	4
Frame Selected.....	4
Zoom Border.....	4
Fractional Zoom.....	4
Proxy.....	4
Setup.....	4
Rebuild.....	4
Scene Render Size.....	4
Refresh All.....	5
Sequence render Image.....	5
Sequence render Animation.....	5
Toggle Sequencer/Preview.....	5
Pie Menu.....	5
Area.....	5
Toggle Quad view.....	5
Horizontal Split.....	5
Vertical Split.....	6
Duplicate Area into New Window.....	6
Toggle Maximize Area.....	6
Toggle Full screen Area.....	6
Close Area.....	6
View Menu in Sequencer window.....	6
Toolbar.....	7
Sidebar.....	7
Tool Settings.....	7
Adjust Last Operation.....	7
Channels.....	7
Tool Shelf Tabs.....	7
Zoom In.....	7
Zoom Out.....	7
Zoom Border.....	7
Frame all.....	7

Go to current frame.....	8
Frame selected.....	8
Refresh all.....	8
Sequence render Image.....	8
Sequence render Animation.....	8
Toggle Sequencer/Preview.....	8
Pie Menu.....	8
Area.....	8
Toggle Quad view.....	8
Horizontal Split.....	9
Vertical Split.....	9
Duplicate Area into New Window.....	9
Toggle Maximize Area.....	9
Toggle Full screen Area.....	9
Close Area.....	9

Type of Sequencer View

The Video Sequence Editor is two editors in one. The Preview sequencer view is a preview window. Here plays the video. The Sequencer sequencer view is the view that contains the video and audio strips.

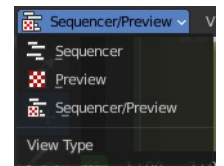

The view menu for Sequencer/Preview contains the same menu items than in the other two views. So we won't explicitly list it here again.

View Menu in Preview window

The View menu contains all View related tools.

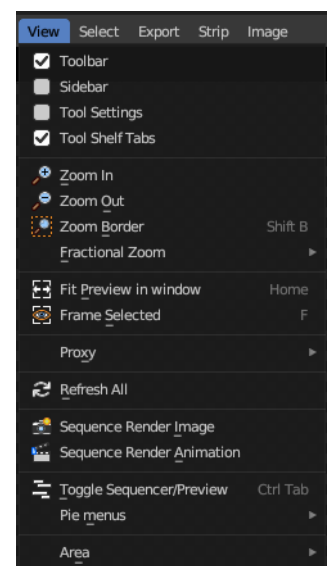

Toolbar

Shows or hides the toolbar at the left.

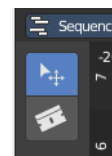

Sidebar

Shows or hides the sidebar at the right in the viewport.

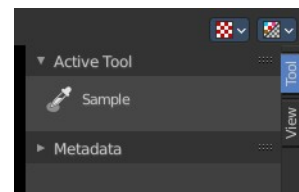

Tool Settings

Show or hide the tool settings at the top.

Tool shelf tabs

Show or hide the tool shelf tabs in the tool shelf.

Annotations (Legacy)

This group of operators is useful to take notes without changing tool-shelf operators. These notes can be colored in the View tab of the Property Shelf. Each layer is a single color. You can also animate the notes with keyframes, editable in the dopesheet.

Note: *These are legacy operators, meaning they are equally available in the Toolshelf as a modal operator.*

Draw Annotation

Starts the annotation free hand draw tool in the editor.

Draw Line Annotation

Starts the annotation line draw tool to draw straight lines in the editor.

Draw Polyline Annotation

Starts the annotation Polyline draw tool in the editor which allows to draw multiple connected straight lines in the editor.

Erase Annotation

Starts the annotation erase tool in the editor which erases any strokes in the editor.

Add Annotation Layer

Starts a new annotation layer.

Erase Annotation Active Keyframe

Erases the active keyframe of the annotation.

Zoom In

Zooms in.

Zoom Out

Zooms out.

Fit Preview in Window

Zooms in or out until the video displays fitting in the viewport.

Frame Selected

Centers the selection and zooms to fit.

Zoom Border

Draw a rectangle around the target area to zoom in or out.

Left mouse button zooms in. Middle mouse button zooms out.

Fractional Zoom

A set of predefined zoom factors.

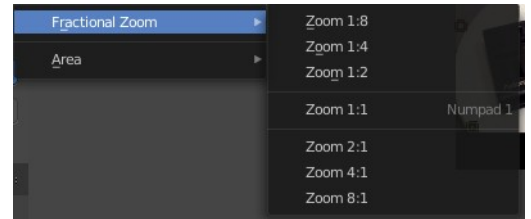

Proxy

Proxy works just with movie or image strips. What it does is to create a smaller set of preview images. This speeds up the calculation while you are at editing the video. The final result uses the final images again then.

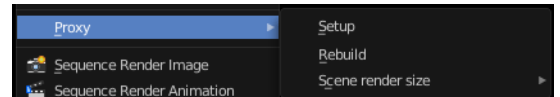

Setup

Calls a panel where you can choose the resolution of the proxy images. Clicking OK starts the creation process.

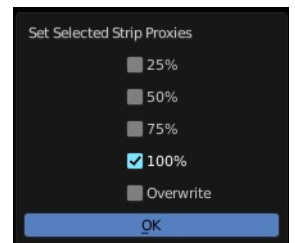

Rebuild

Recreates the proxy images

Scene Render Size

What render size the display should choose.

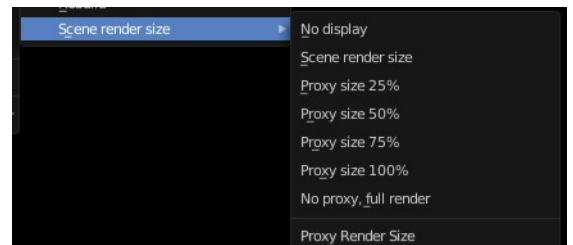

Refresh All

Refresh the sequence editor.

Sequence render Image

Renders an image of the current frame.

Sequence render Animation

Renders the animation in the preview range.

Toggle Sequencer/Preview

Toggles the type of sequencer view between Sequencer or Preview.

Pie Menu

The available pie menus for the sequencer in View mode.



Area

This menu contains general view functionality. And exists in most other editor types too.

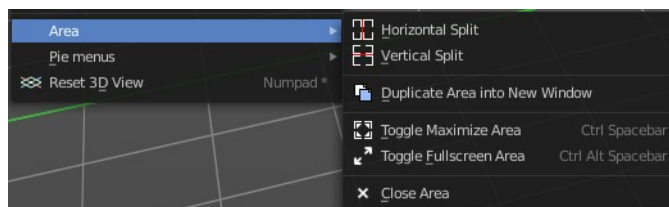

Toggle Quad view

Displays the 3D View divided into four split screen parts. Note that the orthographic views cannot be switched in this mode. They remain orthographic, you cannot rotate them.

To return to single view reuse the menu item in the View menu.

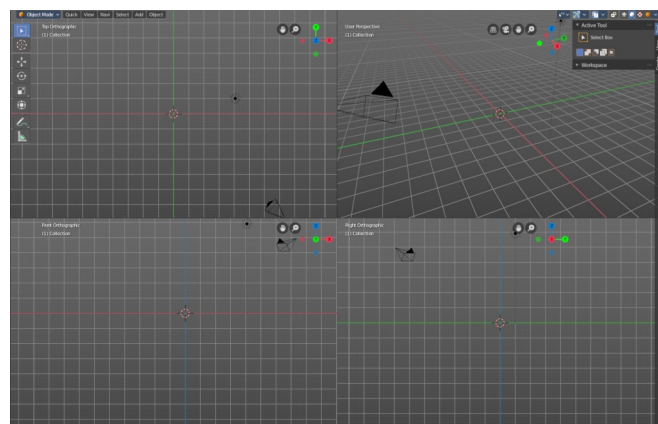

Horizontal Split

Splits the current view horizontally into two independent editor windows.

Vertical Split

Splits the current view vertically into two independent editor windows.

Duplicate Area into New Window

Duplicate Area into New Window makes the selected editor window floating. You can then drag it around at the monitor. It is not connected with the rest of the UI anymore.

A separated window cannot be merged into the main window again. You have to close it when not longer needed.

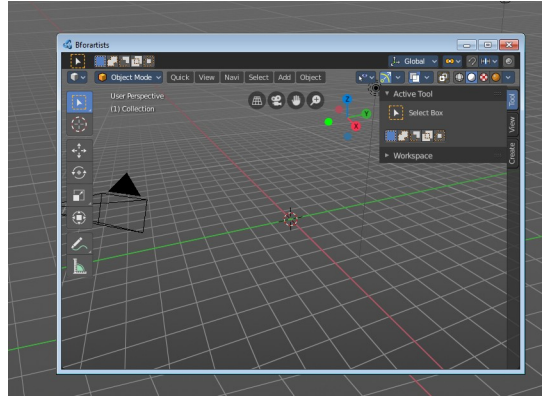

Toggle Maximize Area

Displays the editor maximized with menus.

To return from the maximized view press hotkey ctrl + space bar. Or reuse the menu item in the area menu.

Toggle Full screen Area

Displays the editor maximized without menus.

To return from the full screen view press hotkey ctrl + alt + space bar.

Close Area

Closes the area window.

View Menu in Sequencer window

The View menu contains all View related tools.

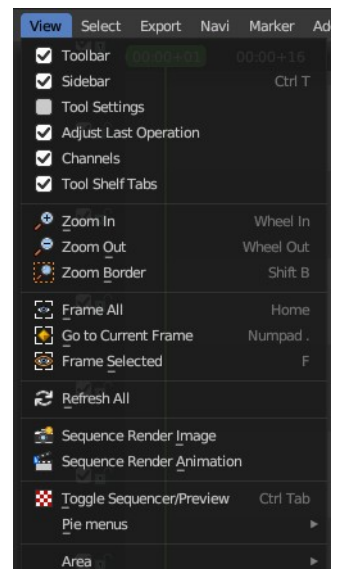

Toolbar

Shows or hides the toolbar at the left.

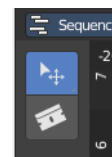

Sidebar

Shows or hides the sidebar at the right in the viewport.

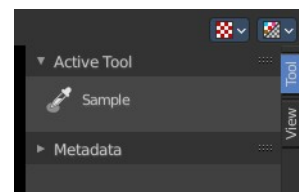

Tool Settings

Show or hide the tool settings at the top.

Adjust Last Operation

Displays the Adjust last operation panel down left.

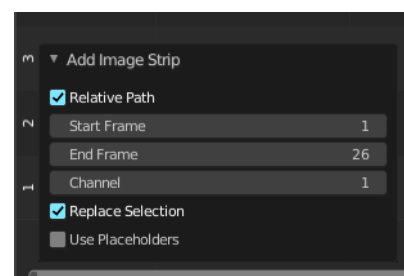

Channels

Display the channels in front of the timeline

Tool Shelf Tabs

Show or hide the tool shelf tabs in the tool shelf.

Zoom In

Zooms in.

Zoom Out

Zooms out.

Zoom Border

Zooms to the selection.

Frame all

Zooms in or out to display all elements fitting into the view.

Go to current frame

Centers the view at the current frame.

Frame selected

Zooms in or out to display the currently selected element fitting into the view.

Refresh all

Refreshes the sequence editor.

Sequence render Image

Renders an image of the current frame.

Sequence render Animation

Renders the animation in the preview range.

Toggle Sequencer/Preview

Toggles the type of sequencer view between Sequencer or Preview.

Pie Menu

The available pie menus for the sequencer in Sequencer mode.



Area

This menu contains general view functionality. And exists in most other editor types too.

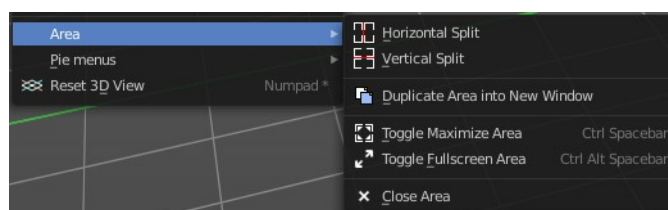

Toggle Quad view

Displays the 3D View divided into four split screen parts. Note that the orthographic views cannot be switched in this mode. They remain orthographic, you cannot rotate them.

To return to single view reuse the menu item in the View menu.

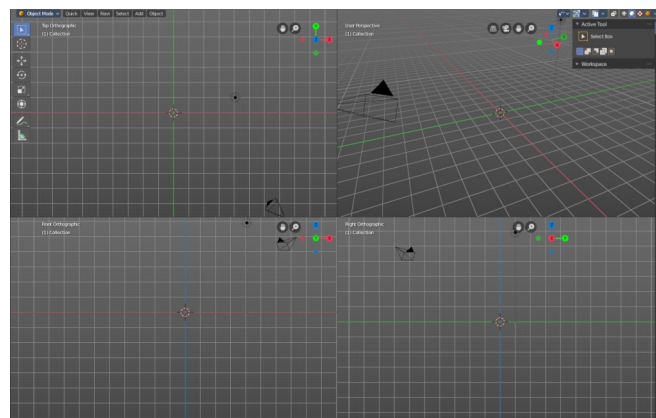

Horizontal Split

Splits the current view horizontally into two independent editor windows.

Vertical Split

Splits the current view vertically into two independent editor windows.

Duplicate Area into New Window

Duplicate Area into New Window makes the selected editor window floating. You can then drag it around at the monitor. It is not connected with the rest of the UI anymore.

A separated window cannot be merged into the main window again. You have to close it when not longer needed.

Toggle Maximize Area

Displays the editor maximized with menus.

To return from the maximized view press hotkey ctrl + space bar. Or reuse the menu item in the area menu.

Toggle Full screen Area

Displays the editor maximized without menus.

To return from the full screen view press hotkey ctrl + alt + space bar.

Close Area

Closes the area window.

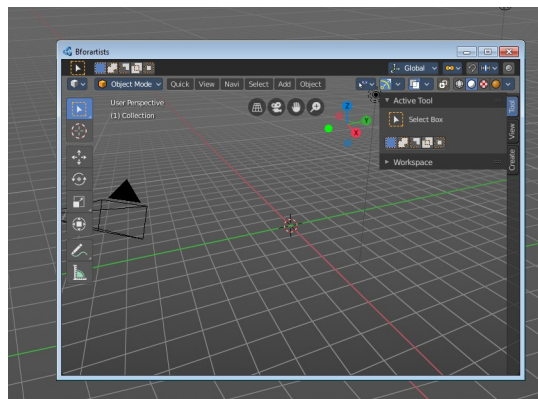

14.1.4 Editors - Video Sequence Editor - Header - Export Menu

Table of content

Export menu.....	1
Export Subtitles.....	1

Export menu

This menu exists in both view types. It currently has just one entry.

Export Subtitles

Exports the subtitles of a video in stl format. You need to have a subtitle text strip in the video.

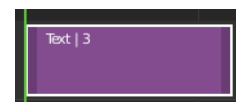
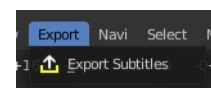



14.1.5 Editors - Video Sequence Editor - Header - Navi Menu

Table of content

Navi menu.....	1
Play Animation.....	1
Jump to Previous Strip.....	1
Jump to Next Strip.....	1
Jump to Previous Strip(Center).....	1
Jump to Next Strip(Center).....	1
Range.....	1
Set Preview Range.....	2
Set Preview Range to Strips.....	2
Clear Preview Range.....	2
Set Start Frame.....	2
Set End Frame.....	2
Set Frame Range to Strips.....	2

Navi menu

This menu exists in Sequencer view type.

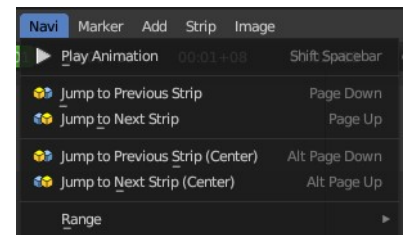

Play Animation

Plays the movie.

Jump to Previous Strip

Jumps to the start of the previous strip.

Jump to Next Strip

Jumps to the start of the next strip.

Jump to Previous Strip(Center)

Jumps to the center of the previous strip.

Jump to Next Strip(Center)

Jumps to the center of the next strip.

Range

Play range related functionality. Most of it can also be adjusted in the play elements in the timeline editor.

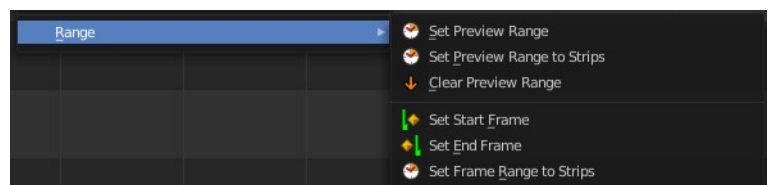

Set Preview Range

Calls a border select tool that allows you to set the range of the preview.

Set Preview Range to Strips

Sets the width of the preview range to the length of the strips.

Clear Preview Range

Removes the preview range.

Set Start Frame

Sets the current frame as the start frame for playback.

Set End Frame

Sets the current frame as the end frame for playback.

Set Frame Range to Strips

Sets the start and end frame to the start and end frames of the strips in the sequencer.

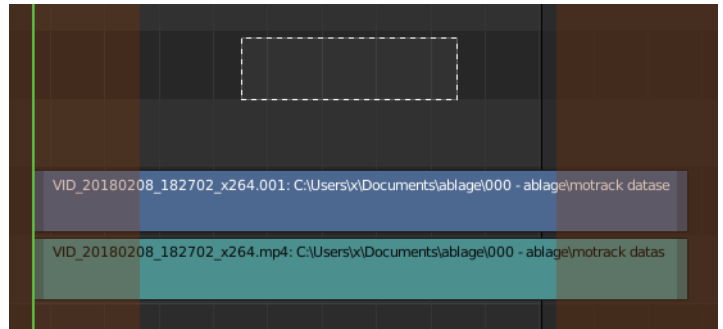

14.1.6 Editors - Video Sequence Editor - Header - Select Menu

Table of content

Select menu in Sequencer window.....	1
All.....	2
None.....	2
Inverse.....	2
Box Select.....	2
Box Select (Include Handles).....	2
Side of Frame.....	2
Left.....	2
Right.....	2
Handle.....	2
Both.....	2
Left.....	2
Right.....	2
Both Neighbours.....	3
Left Neighbours.....	3
Right Neighbours.....	3
Last operator Select Handles.....	3
Side.....	3
Channel.....	3
Left.....	3
Right.....	3
Both sides.....	3
Linked.....	3
All.....	3
Less.....	3
More.....	3
Grouped.....	3
Last operator Select Grouped.....	4
Type.....	4
Extend.....	4
Same Channel.....	4
Select menu in Preview window.....	4
All.....	4
None.....	4
Inverse.....	4
Box Select.....	4
Grouped.....	4
Last operator Select Grouped.....	4
Type.....	4
Extend.....	5
Same Channel.....	5

Select menu in Sequencer window

All

Select everything.

None

Select nothing.

Inverse

Invert the current selection.

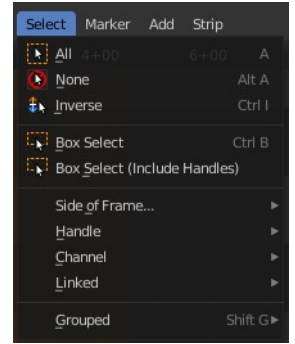

Box Select

Draw a rectangle to box select strips.

It adds to selection by default. To subtract from selection hold down Shift key.

Box Select (Include Handles)

Draw a rectangle to box select the handles of the strips. A strip has a resize handle at the start and the end of the strip.

It adds to selection by default. To subtract from selection hold down Shift key.



Side of Frame

Left

Select the strips left from the current frame.

Right

Select the strips right from the current frame.

Handle

Both

Select all handles of the selected strips.

Left

Select the left handles of the selected strips.

Right

Select the right handles of the selected strips.

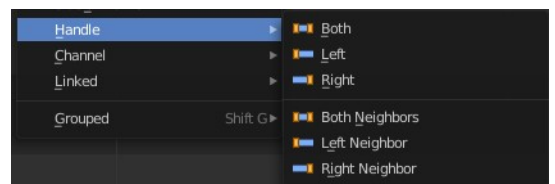

Both Neighbours

Select all handles of the selected strips. Plus the handles from the neighbour strips that touches this strip.

Left Neighbours

Select the left handles of the selected strips. Plus the handle from the neighbour strips that touches the left handle of the strip.

Right Neighbours

Select the right handles of the selected strips. Plus the handle from the neighbour strips that touches the right handle of the strip.

Last operator Select Handles

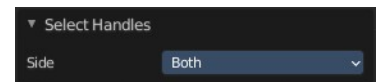

Side

Which side to select.

Channel

Left

Select the strips left from the current frame that are in the same channel.

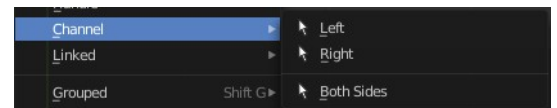

Right

Select the strips right from the current frame that are in the same channel.

Both sides

Select all strips in the channel of the currently selected strip.

Linked

All

Select all strips that are adjacent to the current selected strip.

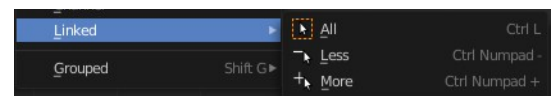

Less

Decrease the selection of strips that are adjacent to the current selected strip.

More

Increase the selection of strips that are adjacent to the current selected strip.

Grouped

Select all strips that are equal to the current selected strip by the chosen method. The menu items should be self explaining.

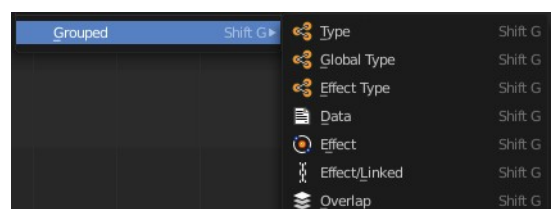

Last operator Select Grouped

Type

The selection method.

Extend

Extend the selection

Same Channel

Select just strips that are in the same channel.

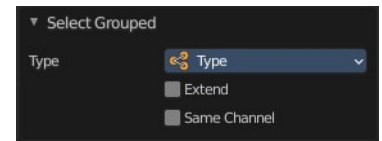

Select menu in Preview window

All

Select everything.

None

Select nothing.

Inverse

Invert the current selection.

Box Select

Draw a rectangle to box select strips.

It adds to selection by default. To subtract from selection hold down Shift key.

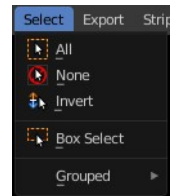

Grouped

Select all strips that are equal to the current selected strip by the chosen method. The menu items should be self explaining.

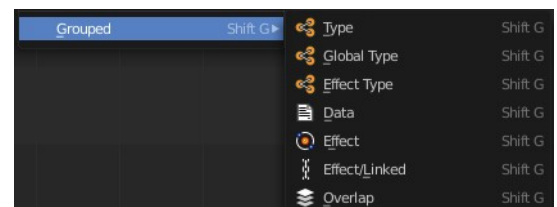

Last operator Select Grouped

Type

The selection method.

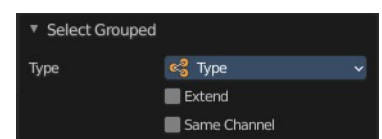

Extend

Extend the selection

Same Channel

Select just strips that are in the same channel.

14.1.7 Editors - Video Sequence Editor - Header - Marker Menu

Table of content

Dopesheet Editor - Marker Menu.....	1
Add Marker.....	1
Duplicate Marker.....	1
Duplicate Marker to Scene.....	1
Delete Marker.....	2
Bind Camera to Markers.....	2
Rename Marker.....	2
Grab/Move Marker.....	2
Jump to Next Marker.....	2
Jump to Previous Marker.....	2

Dopesheet Editor - Marker Menu

Markers are visual landmarks. They can mark a start of a specific animation sequence, the end of a camera movement, and so on.

When you add one then a marker area appears at the bottom of the timeline.

Markers can be pulled around by clicking at them and dragging them left or right. The active marker is yellow.

By holding down shift you can select more than one marker.

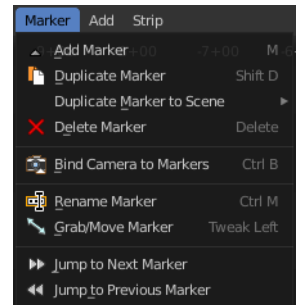

Add Marker

Adds a marker at the current frame position.

Duplicate Marker

Duplicates the selected marker(s). The duplicate(s) sticks at the mouse until you click to give it the target destination.

Duplicate Marker to Scene

Duplicate markers to other scenes. A blend file can contain more than one scene. See Scene Properties in the Properties editor.

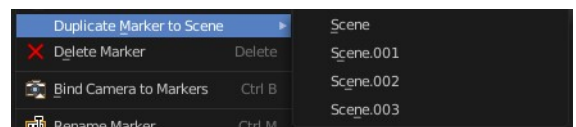

Delete Marker

Deletes the selected marker(s).

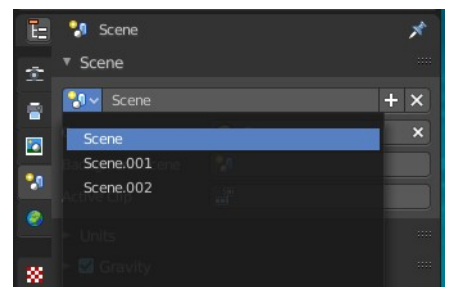

Bind Camera to Markers

This feature is of interest when you work with scene strips. Bind camera to markers turns an object into a camera object. This can be any object in the scene. Not just camera objects.

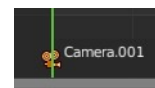

When the current frame position does not have a marker yet, then it creates a marker at the current frame position.

By binding different objects or cameras at different marker locations you can switch cameras automatically.

The marker with a bind camera attached will show a camera icon.

Rename Marker

A menu will open up where you can rename the active marker.

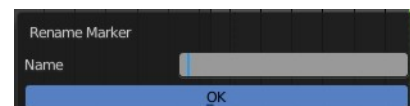

Grab/Move Marker

Hotkey only functionality! This menu item exists to show the hotkey to move the marker.

Jump to Next Marker

Sets the frame position to the next marker.

Jump to Previous Marker

Sets the frame position to the previous marker.



14.1.8 Editors - Video Sequence Editor - Header - Add Menu

Table of content

Detailed table of content.....	1
Add menu.....	3
Scene Strips.....	3
Clip Strips.....	3
Mask Strips.....	3
Movie Strips.....	4
Sound.....	4
Image/Sequence.....	5
Color.....	5
Text Strip.....	6
Adjustment Layer.....	7
Effect strip.....	7
Transition.....	10
Fade.....	10
Clear Fade.....	11

Detailed table of content

Detailed table of content

Detailed table of content.....	1
Add menu.....	3
Scene Strips.....	3
Clip Strips.....	3
Mask Strips.....	3
Movie Strips.....	4
Import settings.....	4
Relative Path.....	4
Start Frame.....	4
Channel.....	4
Replace Selection.....	4
Sound.....	4
Use Movie Frame rate.....	4
Sound.....	4
Import settings.....	4
Relative Path.....	4
Start Frame.....	4
Channel.....	4
Replace Selection.....	5
Cache.....	5
Mono.....	5
Image/Sequence.....	5
Import settings.....	5
Relative Path.....	5
Start Frame.....	5
End Frame.....	5

Replace Selection.....	5
Use Placeholders.....	5
Color.....	5
Last Operator Add Effect Strip.....	6
Type.....	6
Start Frame.....	6
End Frame.....	6
Channel.....	6
Replace Selection.....	6
Color.....	6
Text Strip.....	6
Last Operator Add Effect Strip.....	6
Type.....	6
Start Frame.....	6
End Frame.....	6
Channel.....	6
Replace Selection.....	6
Adjustment Layer.....	7
Last Operator Add Effect Strip.....	7
Type.....	7
Start Frame.....	7
End Frame.....	7
Channel.....	7
Replace Selection.....	7
Effect strip.....	7
Add.....	7
Subtract Effect.....	8
Multiply.....	8
Over Drop.....	8
Alpha Over.....	8
Alpha Under.....	8
Color Mix.....	8
Multicam Selector.....	9
Workflow.....	9
Transform.....	9
Speed Control.....	9
Glow.....	9
Gaussian Blur.....	10
Last Operator Add Effect Strip.....	10
Type.....	10
Channel.....	10
Replace Selection.....	10
Transition.....	10
Sound Crossfade.....	10
Cross.....	10
Gamma Cross.....	10
Wipe.....	10
Fade.....	10
Clear Fade.....	11

Add menu

The sequencer does not only display video and audio strips. There are several strip types available. You can in the Add menu load image sequences, single images, masks, and even whole scenes.

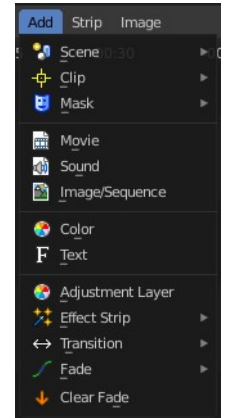

Different strip types have different colors. You can customize them further in the sidebar in the strip tab.

Note that some strip types can also be loaded by drag n drop. When you load the strips by the file selector then you will see some import options there. These import settings are mentioned here.

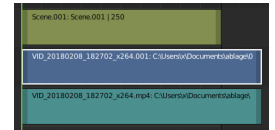

Scene Strips

Scene strips are a way to insert the render output of another scene into your sequence. Instead of rendering out a video, then inserting the video file, you can insert the scene directly.

The strip length will be determined based on the animation settings in that scene.

Note! You can't use the same scene than the one where you have the Video Sequence Editor open. You need to have a second scene with the content. Scenes can be managed in the Scene tab in the Properties Editor.

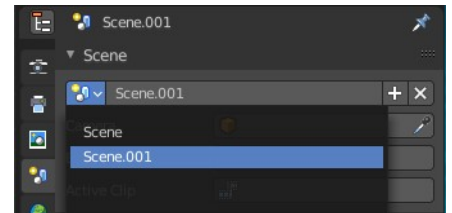

Scenes must exist in the current file. Available scenes appears in the Scene menu.

You can also create a strip directly from this Add Scene Strips operator using the New Scene entry.

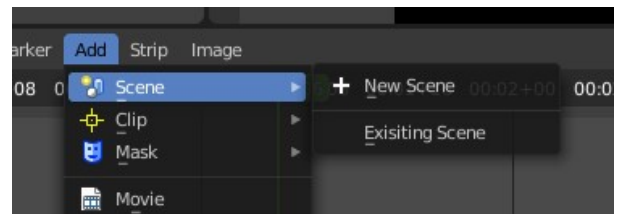

Clip Strips

Clips comes from the Movie Clip Editor. The Movie Clip Editor is part of the motion tracking workspace, and primarily used for motion tracking.

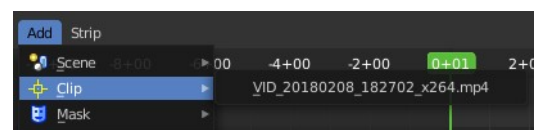

Clips must exist in the current file. Available clips appears in the Clip menu.

Mask Strips

The Mask strip generates a mask image from the selected mask data-block generated in the Movie Clip Editor. This works similar to the Mask Node but without the options available for finer control. The mask image is always generated at the render resolution, scaling along with different proxy levels.



Masks must exist in the current file. Available masks appears in the Mask menu.

Movie Strips

Import a video.

Import settings

Relative Path

Use a relative path to the blend file.

Start Frame

Start frame of the strip.

Channel

In which channel to insert.

Replace Selection

Replace selected strips at import.

Sound

Import sound. A video is usually made of an image part and an audio part.

Use Movie Frame rate

Use the frame rate of the video to keep video and audio in sync.

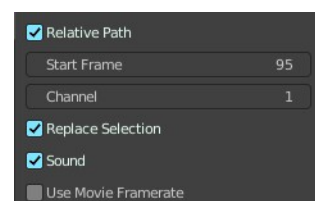

Sound

Import an audio file.

Import settings

Relative Path

Use a relative path to the blend file.

Start Frame

Start frame of the strip.

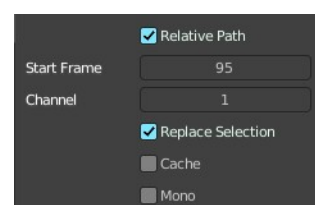

Channel

In which channel to insert.

Replace Selection

Replace selected strips at import.

Cache

Cache the sound in memory.

Mono

Import the audio file as mono.

Image/Sequence

Adds a single image or a sequence of images.

When you add a single image then a strip with the length of one second gets created.

When you want to import an image sequence you have to select all the images of the sequence.

Import settings

Relative Path

Use a relative path to the blend file.

Start Frame

Start frame of the strip.

End Frame

End frame of the strip.

Replace Selection

Replace selected strips at import.

Use Placeholders

Use placeholder images in an image sequence with missing images.

Image sequences can use placeholder files. This works by enabling Use placeholders checkbox when adding an image strip. The option detects the frame range of opened images using Blender's frame naming scheme (filename + frame number + .. .extension) and makes an image sequence with all files in between even if they are missing. This allows you to render an image sequence with a few frames missing and still the image strip will have the correct range to account for the missing frames displayed as black. When the missing frames are rendered or placed in the same folder, you can refresh the Sequencer and get the missing frames in the strip. The option is also available when using the Change Data/File operator and allows you to add more images to the range.

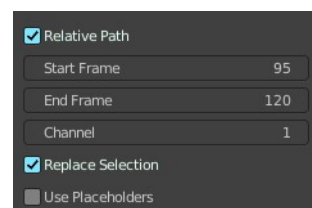

Color

Adds a strip with a plain color. Color is one of many effect strips.

Last Operator Add Effect Strip

Type

Effect strip type.

Start Frame

Start frame of the strip.

End Frame

End frame of the strip.

Channel

In which channel to insert.

Replace Selection

Replace selected strips.

Color

The color of the color effect strip.

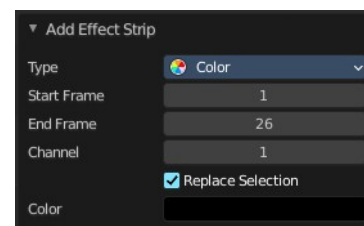

Text Strip

A Text strip allows you to display text in the Sequence.

Last Operator Add Effect Strip

Type

Effect strip type.

Start Frame

Start frame of the strip.

End Frame

End frame of the strip.

Channel

In which channel to insert.

Replace Selection

Replace selected strips.

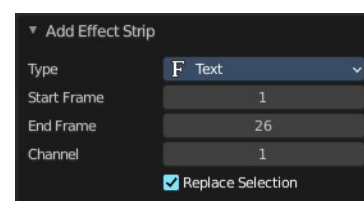

Adjustment Layer

The Adjustment Layer strip works like a regular input file strip except for the fact, that it considers all strips below it as its input.

Real-world use cases, you want to add some last finishing color correction on top of parts of your final sequence, timeline without messing with meta strips around. Just add an adjustment layer on top and activate the color balance.

Or you can stack a primary color correction and several secondary color corrections on top of each other (probably using the new mask input for area selection).

Last Operator Add Effect Strip

Type

Effect strip type.

Start Frame

Start frame of the strip.

End Frame

End frame of the strip.

Channel

In which channel to insert.

Replace Selection

Replace selected strips.

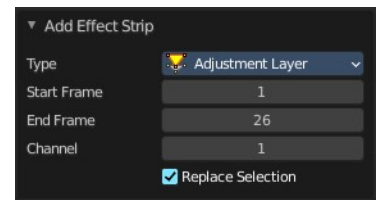

Effect strip

Effect strips that adds effects to the image part of the strips.

The color related strips that are greyed out here requires to have two strips selected. The one controls the other strip then.

The last operator panel is mostly similar for all types.

Add

The Add Effect adds the colors of two strips together. Use this effect with a base image strip, and a modifier strip. The modifier strip can be either a solid color or a black-and-white mask, or another image.

You can use this effect to increase the brightness of an image, or if you use a BW mask, selectively increase the brightness of certain areas of the image. The Mix node, in Add mode, does exactly the same thing as the Add SFX strip here, and is controlled the same way by feeding the Factor input.

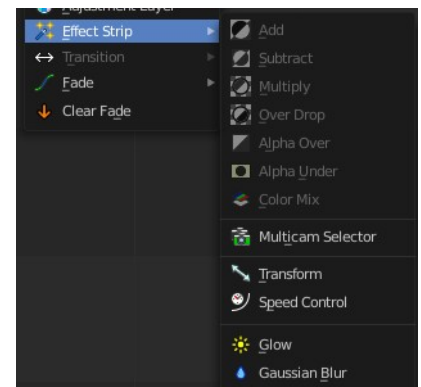

Subtract Effect

This effect takes away one strip's color from the second.

Make a negative of an image using this effect, or switch the order of the strips and just darken the strip. Subtracting a hue of blue from a white image will make it yellow, since red and green make yellow.

Multiply

The Multiply effect multiplies two colors. Blender uses values between (0.0 to 1.0) for the colors. This operation does not have to be normalized, the multiplication of two terms between (0.0 to 1.0) always gives a result between (0.0 to 1.0).

With the “traditional” representation of three bytes, like RGB(124, 255, 56), the multiplications give far too high results, like RGB(7316, 46410, 1848), that have to be normalized (brought back) by dividing them by 256 to fit in the range of (0 to 255)...

Multiply can be used with a Mask. Or with Uniform Colors.

Multiplying a color with a “normal” image allows you to soften some hues of this one (and so – symmetrically – to enhance the others).

For example, if you have a brown pixel RGB(0.50, 0.29, 0.05), and you multiply it with a cyan filter (uniform color RGB(0.0, 1.0, 1.0)), you will get a color RGB(0.0, 0.29, 0.5). Visually, the result is to zero the reds and bring up (by “symmetry” – the real values remain unchanged!) the blues and greens. Physically, it is the same effect as shining a cyan light onto a chocolate bar. Emotionally, vegetation becomes more lush, water becomes more Caribbean and inviting, skies become friendlier.

Note! This effect reduces the global luminosity of the picture (the result will always be smaller than the smallest operand). If one of the images is all white, the result is the other picture; if one of the images is all black, the result is all black!

Over Drop

Alpha channel effect. With Over Drop the first strip selected is the foreground. But as with Alpha Over, the Opacity controls the transparency of this foreground.

Warning! By clicking the Premultiply Alpha button in the Sidebar of the foreground strip, the alpha values of the two strips are not multiplied or added together.

Alpha Over

Alpha channel effect. With Alpha Over the first strip selected is the background, and the second one goes over the first one selected. The Opacity controls the transparency of the foreground.

Alpha Under

Alpha channel effect. With Alpha Under the first strip selected is the foreground, and the second one, the background. The Opacity controls the transparency of the background.

Color Mix

The Color Mix effect strip mixes two strips by working on the individual and corresponding pixels of the two

input strips. This effect can do the exact same operation as the Add, Subtract, or Multiply effect strips but also other color blending modes.

Multicam Selector

The Multicam Selector strip is used for multi-camera editing. Multi-camera editing is when a scene is recorded using multiple cameras from different angles and then edited together afterwards. This process can be rather easy in the VSE if you properly setup every to improve your workflow.

Workflow

Add your video strips.

Sync all your cameras by either using Audio Wave forms or by the movement of objects.

Tip! To make syncing strips easier you can group cameras, their audio, and their effects together using Meta Strips.

Add a viewer region for every input channel and to improve the performance use proxies.

Add a Multicam Selector strip above all the channel tracks.

After completing these steps you should get something similar to the image below:

Select the Multicam strip.

When you select the Multicam strip, the keys 1 to 9 are mapped to the cut buttons. So, select the Multicam strip and start playback and press the keys for the correct input while watching the individual cameras.

You will now have a small Multicam Selector strip for every cut.

Transform

Moves, rotates or scales the images within a strip.

Speed Control

Speed Control time-warps the strip, making it play faster or slower than it normally would. A Global Speed less than 1.0 makes the strip play slower; greater than 1.0 makes it play faster.

Playing faster means that some frames are skipped, and the strip will run out of frames before the end frame. When the strip runs out of frames to display, it will just keep repeating the last one; action will appear to freeze. To avoid this, position the next strip under the original at a point where you want the motion to continue.

Glow

This effect makes parts of an image glow brighter.

To “animate” the glow effect, mix it with the base image using the Gamma Cross effect, crossing from the base image to the glowing one.

Gaussian Blur

Blurs the input strip in a defined direction.

Last Operator Add Effect Strip

Type

Effect strip type.

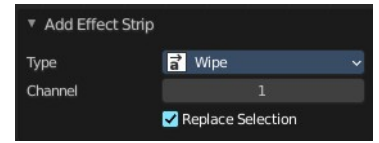

Channel

In which channel to insert.

Replace Selection

Replace selected strips.

Transition

Adds transitions between two selected strips.

These strips are effect strips. And will have similar adjust last operation panels therefore.

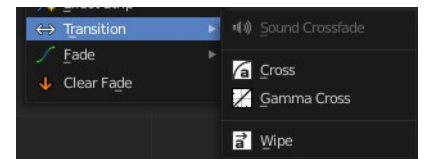

Sound Crossfade

Adds a cross fade between two selected audio strips.

Cross

The Cross transition adds a cross fade transition. Strips can be overlapping or have a gap between them, But when strips contain a gap the last and first frame of each strip is extend which can cause a pause if any of the strips are a sequence.

Gamma Cross

Similar to the Cross transition. It adds a cross fade transition. But uses color correction while transitioning between the two strips. This results in a smoother transition.

Wipe

Adds a transition from one strip to the next strip. The duration of the wipe is the intersection of the two source strips and cannot be adjusted. To adjust the start and end of the wipe you must adjust the temporal bounds of the source strips in a way that alters their intersection.

Fade

Adds a fade effect to the selected strip(s). The menu items should be self explaining.

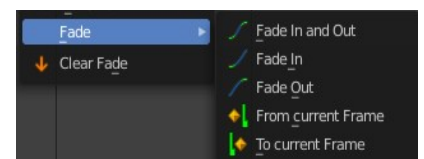

Clear Fade

Removes all fade effects from the selected strips.



14.1.9 Editors - Video Sequence Editor - Header - Strip Menu

Table of content

Strip menu in Sequencer window.....	3
Transform.....	3
Move.....	3
Last operator Sequence Slide.....	3
Offset X.....	3
Y.....	3
Move/Extend from Frame.....	3
Last operator Transform.....	3
Values X, Y, Z, W.....	3
Axis.....	3
Orientation.....	4
Proportional editing.....	4
Slip strip content.....	4
Snap Strips to the current frame.....	4
Clear Strip Offset.....	4
Swap Strip Left.....	4
Swap Strip Right.....	4
Remove Gaps.....	4
Last operator Remove Gaps.....	4
All Gaps.....	4
Insert Gaps.....	4
Last operator Remove Gaps.....	4
Frames.....	4
Split.....	5
Last operator Split Strips.....	5
Frame.....	5
Channel.....	5
Type.....	5
Use Cursor Position.....	5
Side.....	5
Hold Split.....	5
Last operator Split Strips.....	5
Frame.....	5
Channel.....	5
Type.....	5
Use Cursor Position.....	5
Side.....	6
Copy.....	6
Paste.....	6
Duplicate Strips.....	6
Last operator Duplicate Strips.....	6
Offset X.....	6
Y.....	6
Delete.....	6
Delete Strip & Data.....	6
Change.....	6
Change Scene.....	7

Change Effect Input.....	7
Change Effect Type.....	7
Path/Files.....	7
Add Strip Modifier.....	7
Copy modifiers to selection.....	7
Movie Strip.....	8
Set Render Size.....	8
Deinterlace Movies.....	8
Effect Strip.....	8
Reassign Inputs.....	8
Swap Inputs.....	8
Set Render Size.....	8
Separate Images.....	8
Last Operator Separate Images.....	8
Make Meta Strip.....	8
UnMeta Strip.....	9
Toggle Meta.....	9
Set Color Tag.....	9
Lock/Mute.....	9
Lock Strips.....	9
Unlock Strips.....	9
Mute Strips.....	9
Last operator Mute Strips.....	9
Unselected.....	9
Unmute Strips.....	9
Last operator Unmute Strips.....	10
Unselected.....	10
Mute unselected strips.....	10
Last operator Mute Strips.....	10
Unselected.....	10
Unmute deselected Strips.....	10
Last operator Unmute Strips.....	10
Unselected.....	10
Inputs.....	10
Reload Strips.....	10
Reload Strips and Adjust Length.....	10
Change Paths/Files.....	10
Swap Data.....	10
Strip menu in Preview window.....	10
Transform.....	11
Move.....	11
Rotate.....	11
Scale.....	11
Delete.....	11
Delete Strip & Data.....	11
Update Scene Frame Range.....	11
Change submenu.....	11

Strip menu in Sequencer window

The strip menu contains strip related functionality. The content differs, dependant of the selected strip.

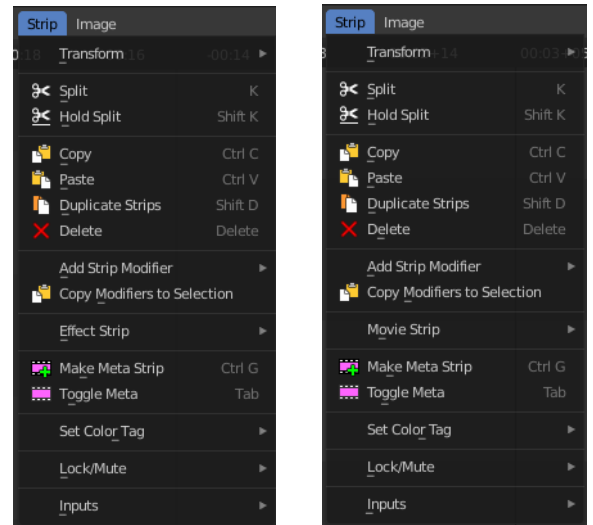

Transform

Move

Moves the selected strip(s).

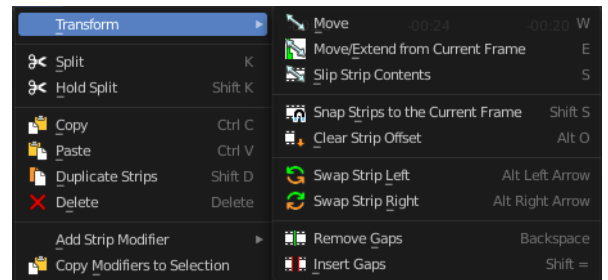

Last operator Sequence Slide

Offset X

The horizontal frame offset from the starting position.

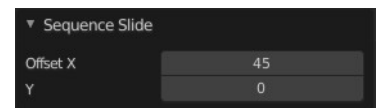

Y

The vertical offset from the starting channel.

Move/Extend from Frame

Extends the selected strips relative to the frame indicator and the mouse position. All selected strip handles to the mouse side of the current frame indicator will transform together.

Last operator Transform

Values X, Y, Z, W

The transform values, relative to the starting point.

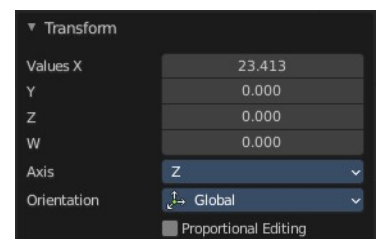

Axis

The transform axis orientation. This axis value box has no meaning here.

Orientation

Choose the type of orientation for the transform action.

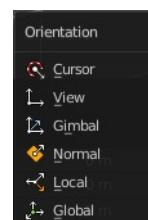

Proportional editing

The tool has no proportional editing. The checkbox cannot be activated.

Slip strip content

Change the position of the contents of a strip without moving the strip itself.

Snap Strips to the current frame

Snaps the selected strips to the current frame.

Clear Strip Offset

Clear strip offset from the start and end frames.

Swap Strip Left

Swap the active strip with the strip to the left.

Swap Strip Right

Swap the active strip with the strip to the right.

Remove Gaps

Removes gaps at the frame indicator position in the current channel. Strips after the indicator will move to the left to close the gap.

Last operator Remove Gaps

All Gaps

Remove all gaps between all clips at the right side.

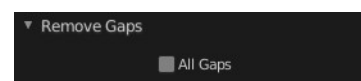

Insert Gaps

Inserts a gap at the frame indicator position. Strips after the indicator will move to the right by the amount of gap frames.

Last operator Remove Gaps

Frames

The size of the gap in frames.



Split

Split the selected strip into two parts at the current frame.

Last operator Split Strips

Frame

The frame at which the cut happens.

Channel

The channel of the strip.

Type

How to cut. Soft or hard.

Use Cursor Position

Split at the position of the cursor instead of the current frame. Note! This setting makes no sense. You can't adjust the cursor position afterwards.

Side

The side that remains selected after the split.

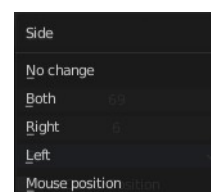
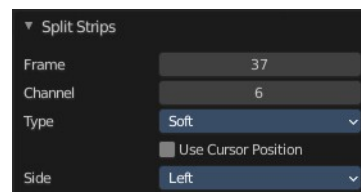

Hold Split

Like Split, it splits a strip in two strips. But you will not be able to drag the endpoints to show the frames past the split of each resulting strip. You can adjust the Hold Offset number fields in the Strip Info panel.

Last operator Split Strips

Frame

The frame at which the cut happens.

Channel

The channel of the strip.

Type

How to cut. Soft or hard.

Use Cursor Position

Split at the position of the cursor instead of the current frame. Note! This setting makes no sense. You can't

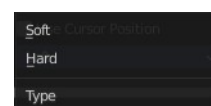
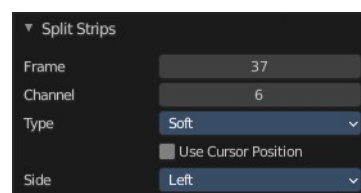

adjust the cursor position afterwards.

Side

The side that remains selected after the split.

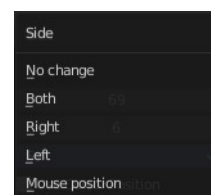

Copy

Copies the selected strip(s).

Paste

Pastes copied strip(s).

Duplicate Strips

Duplicates the selected strip(s).

Last operator Duplicate Strips

Offset X

The horizontal frame offset from the starting position.

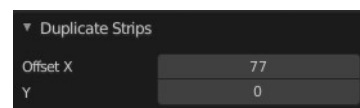

Y

The vertical offset from the starting channel.

Delete

Deletes the selected strip(s).

Delete Strip & Data

Deletes the selected scene strip types and associated scene data.

This will then convert the associated scene to an orphan data block which will be permanently removed upon save and re-load of the *.blend file.

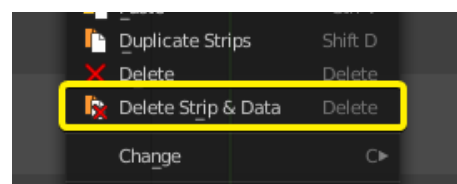

Change

This menu changes existing strip contents.

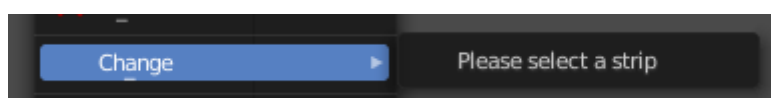

If no strip is selected, it will advise you to select a strip. If a strip cannot be changed, it will advise you to selected a changeable strip which are scene, effect and data strips.

Change Scene

Changes a scene strip with another scene. Only shows when a scene strip is selected.



Change Effect Input

Changes a selected existing effect strip input order. Only shows when an effect strip is selected.

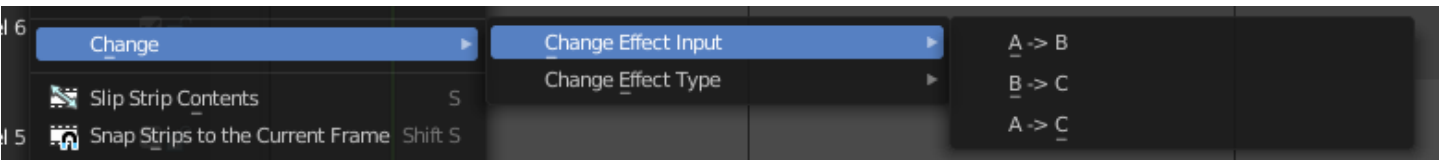

Change Effect Type

Changes a selected existing effect strip effect type. Only shows when an effect strip is selected.

Path/Files

Changes a selected existing strip path/file. Only shows when a data strip is selected. Audio, Movie and Image/Sequence strip are data strips.



Add Strip Modifier

All strip types but Sound. Adds a strip modifier. Strip modifiers are explained in the sidebar chapters.

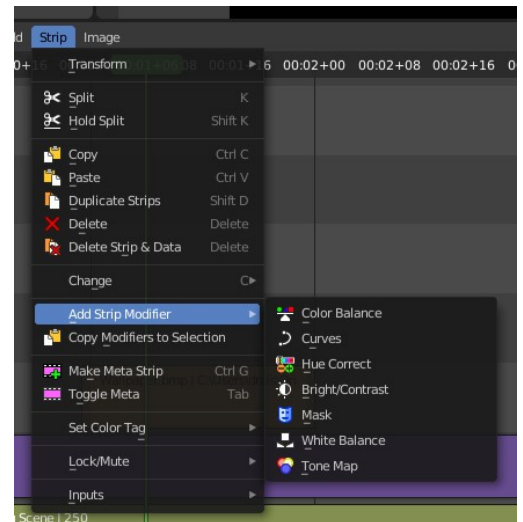

Copy modifiers to selection

Copies the modifiers from the source strip to the target strip by given method. It opens a popup where you can choose the method.

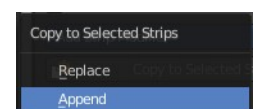

First select the source strip. Hold down shift, select the second strip. Perform the tool.

Movie Strip

Strip type Movie.



Set Render Size

Set the render size and aspect from the active strip. Attention, there is no feedback if the operation was successful. It simply sets it.

Deinterlace Movies

Deinterlaces the selected movie strips.

Effect Strip

Strip type Effects.

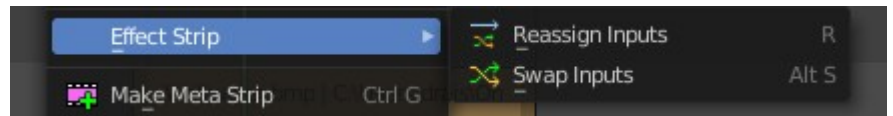

Reassign Inputs

Reassigns the input of the strips.

Unfortunately not to find out how this works.

Swap Inputs

Swaps the inputs of the selected strips.

Unfortunately not to find out how this works.

Set Render Size

Strip type Image. Set the render size and aspect from the active image strip. Attention, there is no feedback if the operation was successful. It simply sets it.



Separate Images

Strip type Image. Create a strip for every image in the image sequence strip.

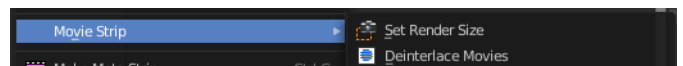

Last Operator Separate Images

The length of each frame of the new created strips.

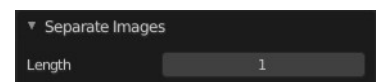

Make Meta Strip

Creates a meta strip out of the selected strips. A Meta Strip is a strip which contain multiple strips treated as if it was one strip. It allows you to reduce the vertical

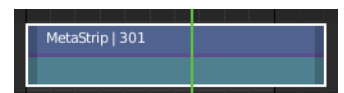

space used in the Sequencer. You can edit it the same way as any other strips.

Note! The default blend mode for a Meta strip is Replace. There are many cases where this alters the results of the animation so be sure to check the results and adjust the blend mode if necessary.

UnMeta Strip

Separating (ungrouping) the Meta strip restores the strips to their relative positions and channels.

Toggle Meta

Toggles between the meta and unmeta state. You need to have a meta strip in the sequencer timeline already.

Set Color Tag

Set the display color of the strips.



Lock/Mute

Lock Strips

Locks the strip from editing. They can't be moved or edited anymore.

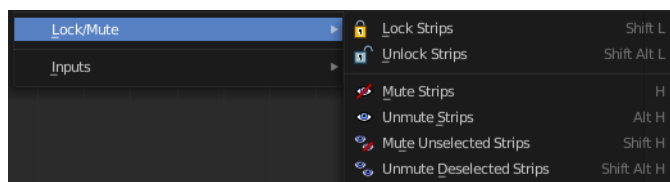

Locked strips appears hatched.

Unlock Strips

Unlock locked strips.

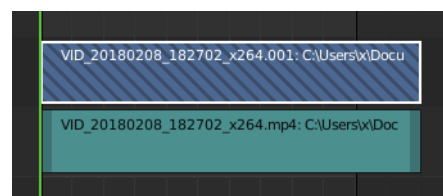

Mute Strips

Mutes the selected strips. They do not play anymore, and they appear greyed out.

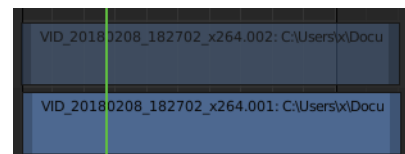

Last operator Mute Strips

Unselected

Mute unselected strips.

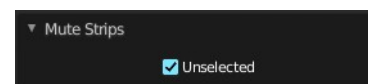

Unmute Strips

Unmutes selected muted strip.

Last operator Unmute Strips

Unselected

Unmute unselected strips.

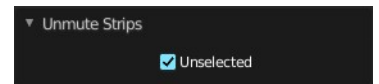

Mute unselected strips

Mute the unselected strips.

Last operator Mute Strips

Unselected

Mute unselected strips.



Unmute deselected Strips

Unmute all deselected strips.

Last operator Unmute Strips

Unselected

Unmute unselected strips.

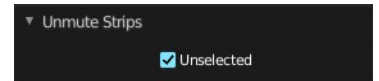

Inputs

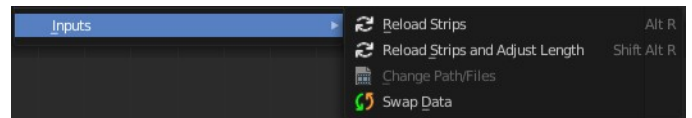

Reload Strips

Reloads the strips in the sequencer.

Reload Strips and Adjust Length

Reloads the strips in the sequencer.

Change Paths/Files

Undocumented Operator. Opens a file selector.

Swap Data

Swaps the data between two selected strips. The strips must be compatible.

Strip menu in Preview window

The strip menu contains strip related functionality.

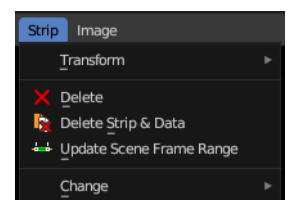

Transform

Move

Move the selected item.

Rotate

Rotate the selected item.

Scale

Scale the selected item.

Delete

Delete the selected item.

Delete Strip & Data

Deletes the selected item and all of its data.

Update Scene Frame Range

Shows with a scene strip. Update the frame range of the scene strip.

Change submenu

Allows you to change things like the source scene. Or the effect of a effect strip.

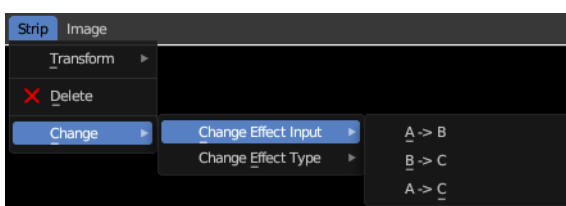
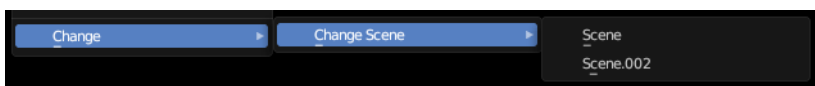
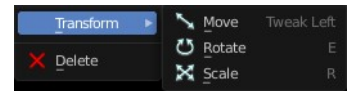



14.2 Editors - Video Sequence Editor - Tool Shelf

Table of content

- Detailed table of content.....1
- Tool shelf in Preview view.....3
 - Select Tools Group.....3
 - Move.....4
 - Rotate.....5
 - Scale.....6
 - Transform.....7
 - Sample.....9
 - Annotate Tools group.....9
- Tool shelf in Sequencer view.....11
 - Tool shelf area.....11
 - Channel header.....13

Detailed table of content

Detailed table of content

- Detailed table of content.....1
- Tool shelf in Preview view.....3
 - Select Tools Group.....3
 - Select.....3
 - Select Box.....3
 - Tool Settings.....4
 - Mode.....4
 - Set a new selection.....4
 - Extend existing selection.....4
 - Subtract existing selection.....4
- Move.....4
 - Snapping.....4
 - Precision movement.....4
 - Header Values.....4
 - Numerical Input.....4
 - Limit Axis.....4
 - Tool Settings.....5
 - Drag.....5
 - Active Tool.....5
 - Tweak.....5
 - Select Box.....5
 - Select mode.....5
- Rotate.....5
 - Snapping.....5
 - Precision movement.....5
 - Header Values.....5
 - Numerical Input.....6
 - Tool Settings.....6

Drag.....	6
Active Tool.....	6
Tweak.....	6
Select Box.....	6
Select mode.....	6
Scale.....	6
Snapping.....	6
Precision movement.....	6
Header Values.....	6
Numerical Input.....	7
Limit Axis.....	7
Tool Settings.....	7
Drag.....	7
Active Tool.....	7
Tweak.....	7
Select Box.....	7
Select mode.....	7
Transform.....	7
Snapping.....	8
Precision movement.....	8
Header Values.....	8
Numerical Input.....	8
Limit Axis.....	8
Tool Settings.....	8
Drag.....	8
Active Tool.....	8
Tweak.....	8
Select Box.....	8
Select mode.....	9
Sample.....	9
Annotate Tools group.....	9
Annotate.....	9
Tool Settings.....	9
Color.....	9
Stabilize Stroke.....	10
Radius.....	10
Factor.....	10
Annotate Line.....	10
Tool Settings.....	10
Color.....	10
Style Start.....	10
End.....	10
Annotate Polygon.....	10
Tool Settings.....	10
Color.....	11
Annotate Eraser.....	11
Tool Settings.....	11
Radius.....	11
Tool shelf in Sequencer view.....	11
Tool shelf area.....	11
Select.....	11
Blade.....	11
Active Tool settings.....	11

Last operator Split Strips.....	11
Frame.....	11
Channel.....	11
Type.....	11
Use Cursor Position.....	12
Side.....	12
Retime.....	12
Adding Marker.....	12
Remove Retime Marker.....	12
Last Operator Add Retiming Handle.....	12
Timeline Frame.....	12
Channel header.....	13

Tool shelf in Preview view

The strip menu contains strip related functionality.



Select Tools Group

Tools with a triangle down right are a group of tools. Click and hold to reveal the content. Then choose the tool that you need.

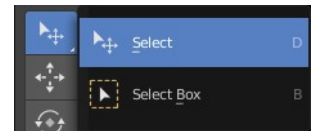

Select

Allows you to select single elements by clicking at it.

Select Box

Draws a box to select several elements at once. Click at the start point, then drag.

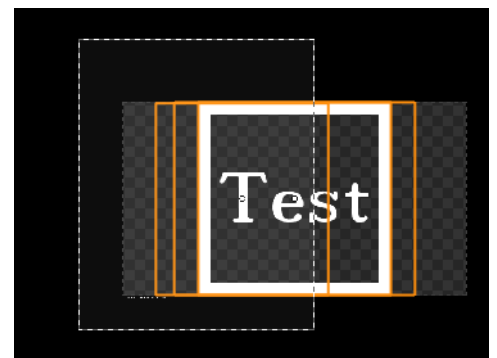

Tool Settings

Mode

The available selection modes. The mode titles are pretty self explaining. So i won't go into detail here.

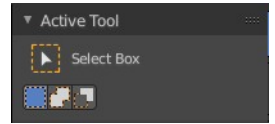

Set a new selection

Extend existing selection

Subtract existing selection

Move

Activates the move tool. Activating the move tool also reveals a move widget at the object. This widget allows you to move the object around, by using the corresponding axis.

Clicking and dragging at one of the axis moves the object along this axis. By clicking into the white square in the middle you can move the object freely.

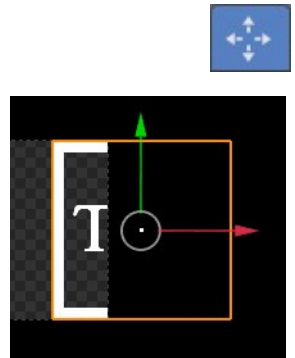

Snapping

Holding down Ctrl activates temporary global snapping.

Precision movement

When you hold down shift, then you will have a much slower but also much preciser movement.

Header Values

When you move your object then you will see some values in the header, which defines the current position of the object.

D: 0.1529 m (0.1529 m) along global Z

The value m stands for the default metric system. Meters. You can change the units in the Properties editor in the Scene properties in the Units panel. When you choose kilometers here then you will see a km instead m.

The value D stands for the distance of the current selected axis. This can also be two axis. Then you have two d values. The value in the brackets is then the direct distance to the starting point.

D: 0.7057 m D: -0.2678 m (0.7548 m) global

These values are always relative to the starting point. You always start with zero, regardless of the real world position.

Numerical Input

When you move the object, and hold down the mouse and type in a value, like 20, then the movement will be performed by the value that you have typed in. In this case by 20 units in direction of the selected axis.

Limit Axis

When you have accidentally grabbed the middle of the widget, and want to move

D: 0.1529 m (0.1529 m) along global Z

along a specific axis, then press X or Y to limit to this axis. The widget orientation remains at global orientation.

Tool Settings

Drag

What to do when you click in the off.

Active Tool

Use the transform tool.

Tweak

Deselect the current element and/or select another element.

Select Box

Deselect the current element and/or box select another element.

Select mode

The select mode for the select methods.

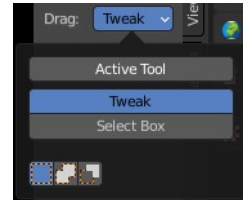
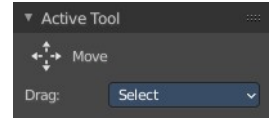

Rotate

Activating the rotate tool reveals a rotate widget at the object. This widget allows you to rotate the object.



Snapping

Snapping while rotation is by default on. It snaps in 5 degree steps.

Holding down Ctrl deactivates temporary global snapping.



Precision movement

When you hold down shift, then you will have a much slower but also much preciser movement.

Header Values

When you move your object then you will see some values in the header, which defines the current position of the object.

A dark grey rectangular box containing the text 'D: 0.1529 m (0.1529 m) along global Z'.

The value m stands for the default metric system. Meters. You can change the units in the Properties editor in the Scene properties in the Units panel. When you choose kilometers here then you will see a km instead m.

The value D stands for the distance of the current selected axis. This can also be two axis. Then you have two d values. The value in the brackets is then the

A dark grey rectangular box containing the text 'D: 0.7057 m D: -0.2678 m (0.7548 m) global'.

direct distance to the starting point.

These values are always relative to the starting point. You always start with zero, regardless of the real world position.

Numerical Input

When you rotate the object, and hold down the mouse and type in a value, like 20, then the rotation will be performed by the value that you have typed in. In this case by 20 degrees clockwise.

Tool Settings

Drag

What to do when you click in the off.

Active Tool

Use the transform tool.

Tweak

Deselect the current element and/or select another element.

Select Box

Deselect the current element and/or box select another element.

Select mode

The select mode for the select methods.

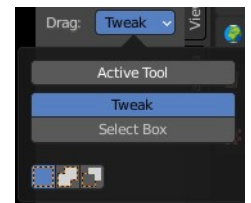
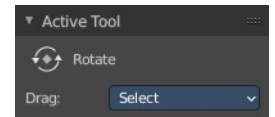

Scale

Activates the Scale tool. Activating the scale tool also reveals a traditional scale widget at the object. This widget allows you to scale the object, by using the corresponding axis. When you click at the outer white circle and drag, then you can scale the object uniformly.

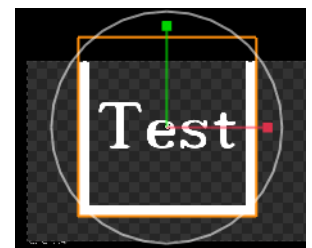

Snapping

Snapping while rotation is by default on. It snaps in 0.1 unit steps.

Holding down Ctrl deactivates temporary global snapping.

Precision movement

When you hold down shift, then you will have a much slower but also much preciser transformation.

Header Values

When you move your object then you will see some values in the header, which

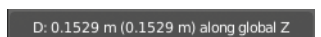

defines the current position of the object.

The value m stands for the default metric system. Meters. You can change the units in the Properties editor in the Scene properties in the Units panel. When you choose kilometers here then you will see a km instead m.

The value D stands for the distance of the current selected axis. This can also be two axis. Then you have two d values. The value in the brackets is then the direct distance to the starting point.

D: 0.7057 m D: -0.2678 m (0.7548 m) global

These values are always relative to the starting point. You always start with zero, regardless of the real world position.

Numerical Input

When you rotate the object, and hold down the mouse and type in a value, like 20, then the rotation will be performed by the value that you have typed in. In this case by 20 degrees clockwise.

Limit Axis

When you have accidentally grabbed the middle of the widget, and want to move along a specific axis, then press X or Y to limit to this axis. The widget orientation remains at global orientation.

D: 0.1529 m (0.1529 m) along global Z

Tool Settings

Drag

What to do when you click in the off.

Active Tool

Use the transform tool.

Tweak

Deselect the current element and/or select another element.

Select Box

Deselect the current element and/or box select another element.

Select mode

The select mode for the select methods.

Transform

Activates the Transform tool. The transform tool allows you to move, rotate and scale the object. You can also select more than one object and move it. To rotate or to scale more than one object simultaneously is currently not possible.

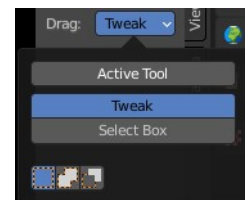
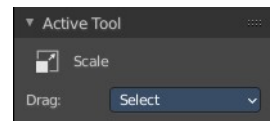

Snapping

Snapping while rotation is by default on. It snaps in 0.1 unit steps.

Holding down Ctrl deactivates temporary global snapping.

Precision movement

When you hold down shift, then you will have a much slower but also much preciser transformation.

Header Values

When you move your object then you will see some values in the header, which defines the current position of the object.

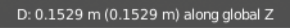

The value m stands for the default metric system. Meters. You can change the units in the Properties editor in the Scene properties in the Units panel. When you choose kilometers here then you will see a km instead m.

The value D stands for the distance of the current selected axis. This can also be two axis. Then you have two d values. The value in the brackets is then the direct distance to the starting point.



These values are always relative to the starting point. You always start with zero, regardless of the real world position.

Numerical Input

When you rotate the object, and hold down the mouse and type in a value, like 20, then the rotation will be performed by the value that you have typed in. In this case by 20 degrees clockwise.

Limit Axis

When you have accidentally grabbed the middle of the widget, and want to move along a specific axis, then press X or Y to limit to this axis. The widget orientation remains at global orientation.



Tool Settings

Drag

What to do when you click in the off.

Active Tool

Use the transform tool.

Tweak

Deselect the current element and/or select another element.

Select Box

Deselect the current element and/or box select another element.

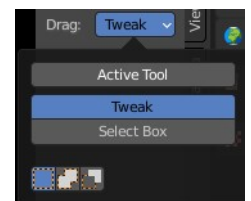
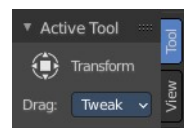

Select mode

The select mode for the select methods.

Sample

Samples colors under the mouse position when you left click at the position. The result is displayed at the bottom of the view.

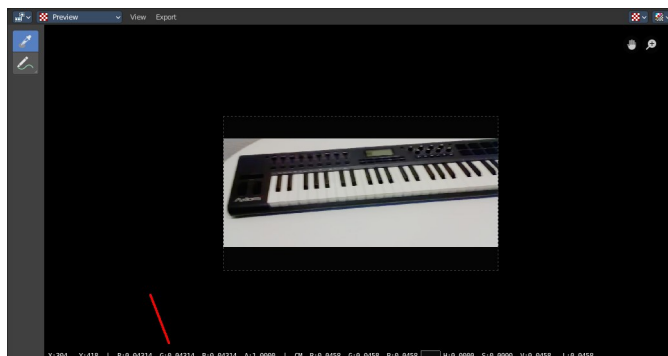

Annotate Tools group

The annotation tool is available in multiple editors. With this tool you can write notes at the screen. The annotate tools is the little brother of the grease pencil objects.

Further settings for annotate can be found in the sidebar. Here you can also remove an annotation when you don't longer need it. And here you can also adjust the size of the stroke.

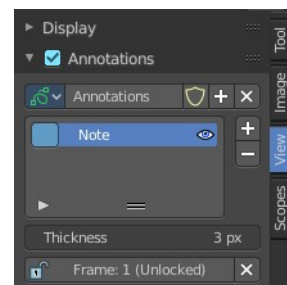
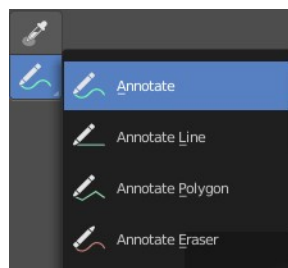

Annotate

Draw free-hand strokes in the main window.

Tool Settings

The tool settings for Annotate.

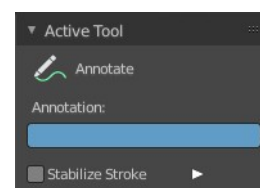

Color

Clicking at the color field reveals a color picker. Define the color for the annotation stroke.



Stabilize Stroke

Helper to draw smooth and clean lines. Pressing shift inverts the effect.

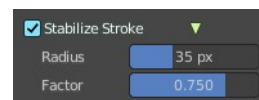

Radius

The radius for the stroke stabilization.

Factor

Stabilizer stroke factor. Higher values gives a smoother stroke.

Annotate Line

Click and drag to create a line.

Tool Settings

The tool settings for the Annotate tool.

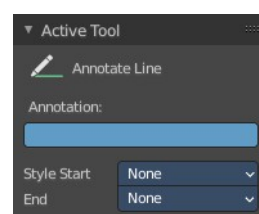

Color

Clicking at the color field reveals a color picker. Define the color for the annotation stroke.



Style Start

The stroke start style. With an arrow for example you place an arrow at the start of the stroke.

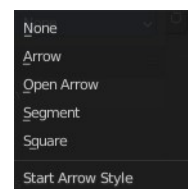

End

The stroke end style. With an arrow for example you place an arrow at the end of the stroke.

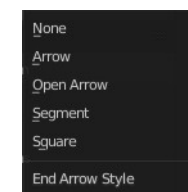

Annotate Polygon

Click multiple times to create multiple connected lines. The current polygon is finished when Esc or RMB is pressed.

Tool Settings

The tool settings for Annotate.

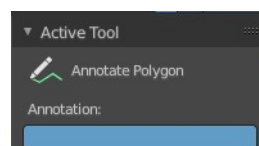

Color

Clicking at the color field reveals a color picker where you can define the color for the annotation stroke.



Annotate Eraser

Click and drag to remove annotate lines.



Tool Settings

Radius

The radius of the eraser pencil.

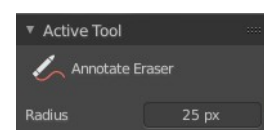

Tool shelf in Sequencer view

Tool shelf area

Select

Select strips. This default mode allows you to select strips and move them around.

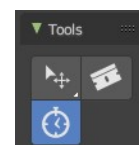

Blade

Cut the selected strips at mouse position.

Active Tool settings

Create a soft split or a hard split.

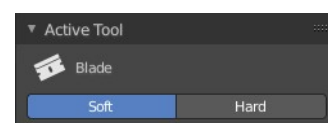

Last operator Split Strips

Frame

The frame at which the cut happens.

Channel

The channel of the strip.

Type

How to cut. Soft or hard.

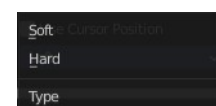
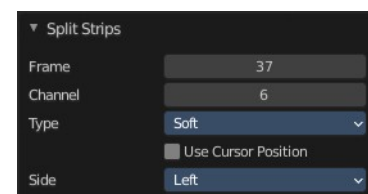

Use Cursor Position

Split at the position of the cursor instead of the current frame. Note! This setting makes no sense. You can't adjust the cursor position afterwards.

Side

The side that remains selected after the split.

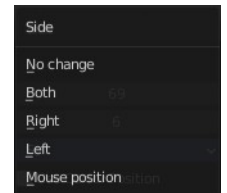

Retime

The retime tool lets you trim the playback speed of your clip by dragging around retime markers. The markers gets added at the clip. And just shows when the retime tool is activated.

Adding Marker

When you activate the Retime tool then you will notice a plus sign besides the playhead cursor. Clicking at it will add a retime marker. Which is a handle that can be moved around. And by draggin around the handler you will stretch or compress the clip towards the handler position.

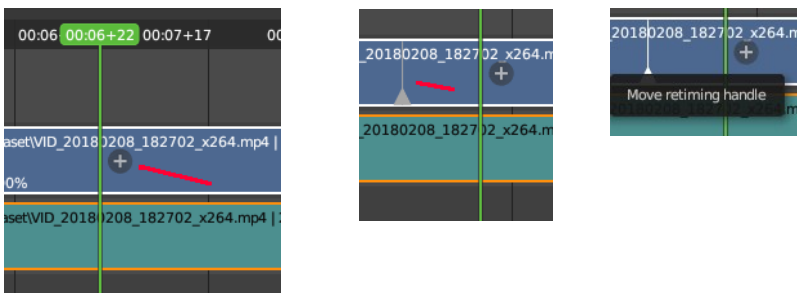

The retiming happens from marker to marker per section. The new playspeed of the marker section can be seen at the clip then.

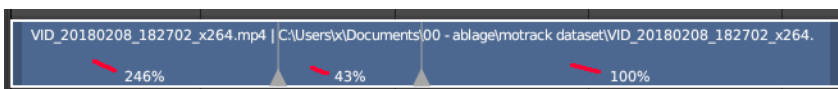

Remove Retime Marker

Markers can be removed by moving the mouse over the triangle area of the handler and a left click.

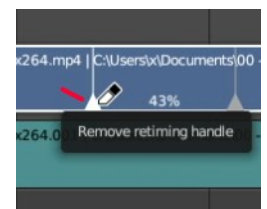

Last Operator Add Retiming Handle

Timeline Frame

The position at which the handler is added.

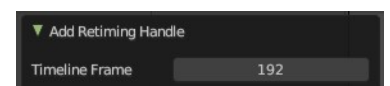

Channel header

The channel headers allows you to activate and to lock the current channel. The channel names can be renamed by double clicking at it.

This header can be hidden away by dragging at the border. To reveal it, click at the little triangle button up left.

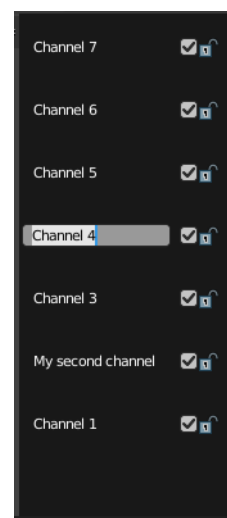
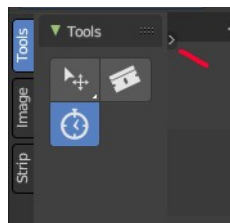



14.3 Editors - Video Sequence Editor - Sidebar

Table of content

Introduction.....1
Right Click menus.....1

Introduction

The Video Sequence Editor is made of several areas. And it is made of two editor types. Preview and Sequence.

At the right side you will find the sidebar with further options and settings for the VSE and its tools.

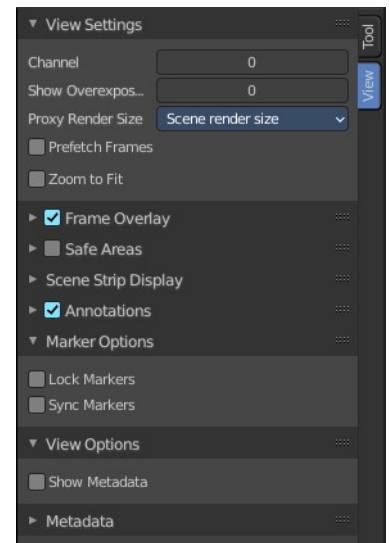

Right Click menus

You will open the usual right click menus when clicking with the right mouse at elements in the sidebar. Its content is in big parts self explaining.

The right click menus are explained in the chapter 6 Editors Introduction.

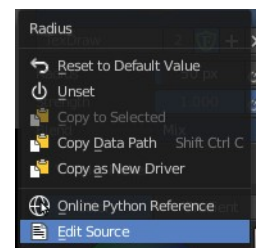

14.3.1 Editors - Video Sequence Editor - Sidebar - Preview - Tool tab

Table of content

Tool Tab.....	1
Active Tool panel.....	1
Metadata panel.....	1

Tool Tab

In the tool tab you will find the tool related settings for the tools in the tool shelf.

Active Tool panel

Displays the settings for the tools in the tool shelf. These settings are explained in the tool shelf chapters.

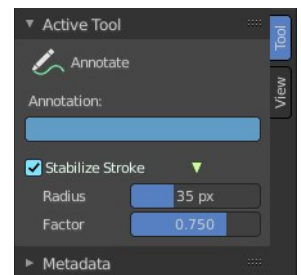

Metadata panel

Displays existing metadata of the strip content.



14.3.2 Editors - Video Sequence Editor - Sidebar - Preview - View tab

Table of content

View Settings Tab.....	1
View Settings Panel.....	2
Proxy Render Size.....	2
Use Proxies.....	2
Prefetch Frames.....	2
Channel.....	2
Show Overexposed.....	2
Frame Overlay Panel.....	2
Set Overlay Region.....	2
Frame offset.....	3
Overlay Type.....	3
Overlay Lock.....	3
Save Areas panel.....	3
Title Safe Margins X/Y.....	3
Action Safe Margins X/Y.....	3
Center-Cut Safe Areas.....	3
Center Title Safe Margins X/Y.....	3
Scene Strip Display panel.....	4
Shading.....	4
Override scene settings.....	4
Annotations panel.....	4
Annotations prop.....	4
Drop down box.....	4
Edit Box.....	4
Fake User.....	4
Add Annotation.....	4
Delete Annotation.....	4
List of Annotation Strokes.....	5
Thickness.....	5
Frame Locked/Unlocked.....	5
Onion Skin panel.....	5
Metadata panel.....	5

View Settings Tab

In the View Settings tab you will find the display related settings.

Note that not all content is available in all submodes. The Preview submode shows other content than the Sequencer submode.

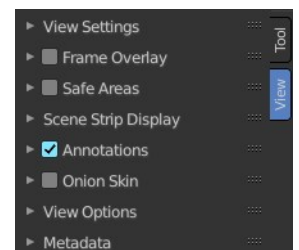

View Settings Panel

Proxy Render Size

Size to display proxies at in the preview region. Using a smaller preview size will increase speed.

Proxies is a simplified data set to speed up workflow.

Use Proxies

Use proxy images instead of the real material to speed up workflow.

Prefetch Frames

Render frames ahead of current frame in the background for faster playback.

Channel

Which channel number to show in the image preview. The value 0 is the result of all strips combined.

Show Overexposed

Shows overexposed (bright white) areas using a zebra pattern. The threshold can be adjust with the slider.

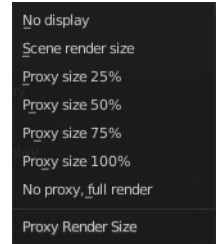
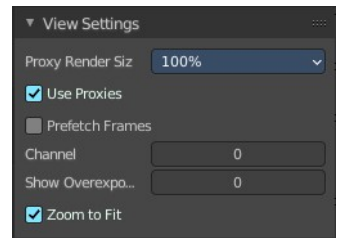

Frame Overlay Panel

Display an overlay on top of the sequencer with a frame offset of the content.

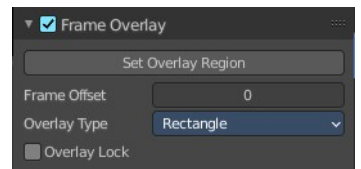

When the feature is active then you will see a green dashed line in the sequencer timeline.

Set Overlay Region

Box select a portion of the viewport to display the overlay content.



Frame offset

What offset frame to use, relative to the current frame position.

Overlay Type

The overlay draw type.

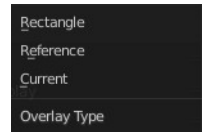

Overlay Lock

Locks the overlay frame to the current frame. It will not go ahead when you play the video.

Save Areas panel

Modern LCD or plasma monitors usually doesn't have over scan areas anymore. But especially older TV screens still may have varying amounts of over scan. And cuts quite a bit content away at the border. And so not all content is shown at all monitors. Safe areas is the area that is always visible at all hardware.

Safe areas are guides to ensure that the most important parts of the content can be seen across all screens. The lines are unfortunately a bit hard to see when you are in camera view. They mark the safe areas.

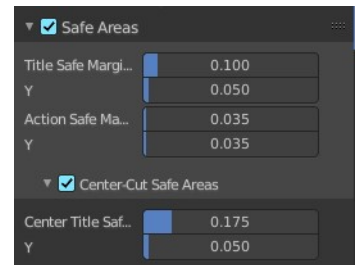
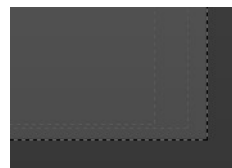

Safe areas can be set from the Camera and Sequencer views.

Tip! Each country sets a legal standard for broadcasting. These include also specific values for safe areas. Bforartists defaults for safe areas follow the EBU (European Union) standard. Make sure you are using the correct values when working for broadcast to avoid any trouble.

Title Safe Margins X/Y

Also known as Graphics Safe. Information (graphics or text) inside this area can be seen by the majority of viewers.

Action Safe Margins X/Y

An extra “margin” for the screen, which can be used to keep elements from piling up against the edges.

Center-Cut Safe Areas

Center-cuts are a second set of safe areas to ensure content is seen correctly on screens with a different aspect ratio. Old TV sets receiving 16:9 or 21:9 video will cut off the sides. Position content inside the center-cut areas to make sure the most important elements of your composition can still be visible in these screens.

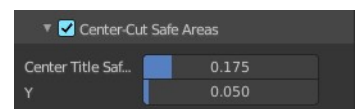

Center Title Safe Margins X/Y

Information (graphics or text) inside this area can be seen by the majority of viewers.

Scene Strip Display panel

Settings for the strip type Scene Strip.

Shading

How to display the scene content in the preview window.

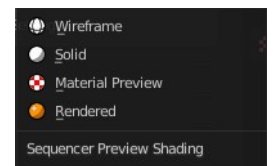
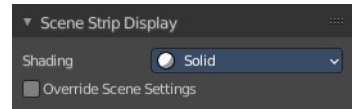

Override scene settings

Use the workbench render settings from the sequencer scene instead of the settings instead of each individual scene used in the strip.

Annotations panel

Manage the Annotation layers and materials.

When you don't have drawn an annotation yet then the panel just contains a New button.

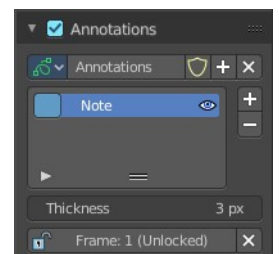
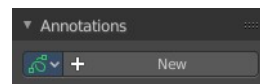

Annotations prop

Add, remove and rename new annotations.

Drop down box

A list of the available annotation layers.

Edit Box

The name of the current annotation. You can rename the annotation to your needs here.

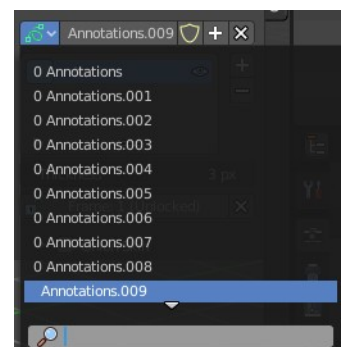

Fake User

Assign a fake user to this annotation. Fake users is an odd concept to keep data in the scene even if it has no user somewhere. The fake user is then a dummy user so that the object is not deleted when saving the scene.

Add Annotation

Add a new annotation.

Delete Annotation

Delete the annotation.

List of Annotation Strokes

Here you see your Annotation layers for the current Annotation. Every layer can have an own color.

At the right side you find buttons to sort them and to add and remove new Annotation layers.

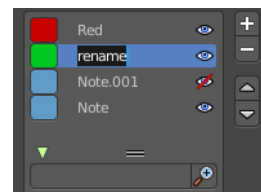

You can change the color by clicking at the color field. A color dialog will pop up. You can rename annotation layers by double clicking at it.

The eye icon allows you to make it invisible And it has a search field.

Thickness

The thickness of the annotation stroke.

Frame Locked/Unlocked

Lock frame displayed by current layer. This toggles whether the active layer is the only one that can be edited.

Onion Skin panel

Enable Onion Skinning.

Onion Skinning allows to show ghosts of the keyframes before and after the current frame. In this sub panel you can adjust the color of the onion skin frames. With the numbers below the colors you can define how many frames before or after are displayed that way.



Metadata panel

Display existing meta data of the selected strip(s).



14.3.3 Editors - Video Sequence Editor - Sidebar - Sequencer - Strip tab

Table of content

Detailed table of content.....	2
Strip Tab.....	5
Strip tab header.....	5
Compositing Panel.....	6
Transform Panel.....	6
Filter.....	6
Position X.....	6
Y.....	6
Rotation.....	6
Mirror.....	6
Video Panel.....	6
Color Panel.....	7
Saturation.....	7
Multiply.....	7
Convert to Float.....	7
Sound Panel.....	7
Volume.....	7
Pitch.....	7
Pan.....	7
Mono.....	7
Display Waveform.....	7
Time Panel.....	8
Lock.....	8
Channel.....	8
Start.....	8
Duration.....	8
End.....	8
Scene Panel.....	8
Scene Property.....	8
Input.....	9
Mask Panel.....	10
Mask Property.....	10
Effect Strip Panel.....	10
Effect strip type Color Mix.....	10
Effect strip type Text.....	11
Effect strip type Gaussian Blur.....	13
Effect strip type Multicam.....	13
Effect strip type Speed Control.....	13
Effect strip type Color.....	14
Effect strip type Transform.....	14
Effect strip type Glow.....	15
Effect strip type Wipe.....	15
Effect strip type Alpha over Drop.....	16
Effect strip type Multiply.....	16
Effect strip type Gamma Cross.....	17

Effect strip type Alpha Under.....	17
Effect strip type Alpha Over.....	17
Effect strip type Subtract.....	18
Effect strip type Add.....	18
Effect strip type Crossfade.....	18
Custom Properties Panel.....	19
Add.....	19
Edit.....	19
Remove.....	19

Detailed table of content

Detailed table of content

Detailed table of content.....	2
Strip Tab.....	5
Strip tab header.....	5
Compositing Panel.....	6
Blend.....	6
Opacity.....	6
Transform Panel.....	6
Filter.....	6
Position X.....	6
Y.....	6
Rotation.....	6
Mirror.....	6
Video Panel.....	6
Strobe.....	6
Reverse Frames.....	7
Color Panel.....	7
Saturation.....	7
Multiply.....	7
Convert to Float.....	7
Sound Panel.....	7
Volume.....	7
Pitch.....	7
Pan.....	7
Mono.....	7
Display Waveform.....	7
Time Panel.....	8
Lock.....	8
Channel.....	8
Start.....	8
Duration.....	8
End.....	8
Current Frame.....	8
Scene Panel.....	8
Scene Property.....	8
Scene Browser.....	8
Scene edit box.....	8
Add.....	9
New.....	9

Copy Settings.....	9
Linked Copy.....	9
Full Copy.....	9
Remove.....	9
Input.....	9
Input Type Camera.....	9
Volume.....	9
Camera.....	9
Show Grease Pencil.....	9
Transparent.....	9
Input type Sequencer.....	9
Volume.....	9
Mask Panel.....	10
Mask Property.....	10
Mask Browser.....	10
Mask edit box.....	10
Fake User.....	10
Remove.....	10
Effect Strip Panel.....	10
Effect strip type Color Mix.....	10
Input 1.....	10
Input 2.....	10
Swap Strips.....	11
Blend Mode.....	11
Blend Factor.....	11
Effect strip type Text.....	11
Text.....	11
Wrap Width.....	11
Style sub panel.....	11
Font property.....	11
Font browser.....	11
Open.....	11
Font Edit Box.....	11
Fake User.....	11
Open Font.....	11
Remove.....	12
Bold.....	12
Italic.....	12
Size.....	12
Color.....	12
Shadow.....	12
Shadow color.....	12
Box.....	12
Box Color.....	12
Box Margin.....	12
Layout sub panel.....	12
Location X/Y.....	12
Anchor X/Y.....	12
Effect strip type Gaussian Blur.....	13
Input 1.....	13
Size X.....	13
Y.....	13
Effect strip type Multicam.....	13

Source Channel.....	13
Cut to.....	13
Effect strip type Speed Control.....	13
Input.....	13
Speed Control.....	13
Stretch.....	13
Multiply.....	13
Multiply factor.....	13
Frame Number.....	13
Frame number.....	13
Length.....	14
Interpolation.....	14
Effect strip type Color.....	14
Color Picker.....	14
Effect strip type Transform.....	14
Input 1.....	14
Interpolation.....	14
Translation Unit.....	14
Position X.....	14
Y.....	14
Uniform scale.....	14
Scale X.....	14
Y.....	14
Rotation.....	15
Effect strip type Glow.....	15
Input 1.....	15
Threshold.....	15
Clamp.....	15
Boost Factor.....	15
Blur Distance.....	15
Quality.....	15
Only Boost.....	15
Effect strip type Wipe.....	15
Input 1.....	15
Input 2.....	15
Swap Inputs.....	15
Transition type.....	15
Direction.....	16
Blur width.....	16
Angle.....	16
Default Fade.....	16
Effect strip type Alpha over Drop.....	16
Input 1.....	16
Input 2.....	16
Swap Inputs.....	16
Default Fade.....	16
Effect strip type Multiply.....	16
Input 1.....	16
Input 2.....	16
Swap Inputs.....	16
Effect strip type Gamma Cross.....	17
Input 1.....	17
Input 2.....	17

Swap Inputs.....	17
Default Fade.....	17
Effect strip type Alpha Under.....	17
Input 1.....	17
Input 2.....	17
Swap Inputs.....	17
Default Fade.....	17
Effect strip type Alpha Over.....	17
Input 1.....	17
Input 2.....	17
Swap Inputs.....	17
Default Fade.....	18
Effect strip type Subtract.....	18
Input 1.....	18
Input 2.....	18
Swap Inputs.....	18
Effect strip type Add.....	18
Input 1.....	18
Input 2.....	18
Swap Inputs.....	18
Effect strip type Crossfade.....	18
Input 1.....	18
Input 2.....	18
Swap Inputs.....	18
Default Fade.....	18
Custom Properties Panel.....	19
Add.....	19
Edit.....	19
Remove.....	19

Strip Tab

The strip tab contains all the strip type related settings. For the different strip types see the Add menu.

Some panels have the same content for all strip types. Some not. Some strip types have their own panels.

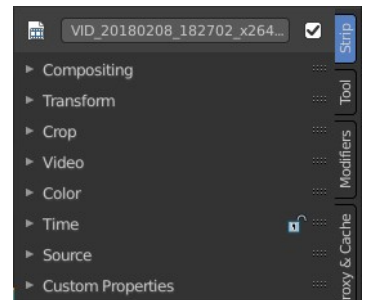

Strip tab header

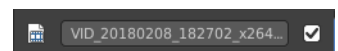

In the strip tab header you will see an icon for the current strip type. The name of the strip. And a checkbox to set this strip active.

The strip can be renamed by double clicking left into the edit box.

Compositing Panel

Blend

The blend method to control how the strip combines with other strips.

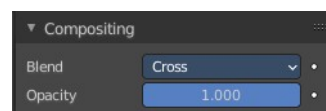

Opacity

How much the strip color affects other strips.

Transform Panel

Filter

Filter type to use for transformations.

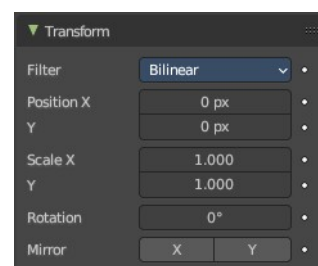

Position X

The X offset.

Y

The Y offset.

Rotation

The rotation around the image center.

Mirror

Flip on the X and/or Y axis.

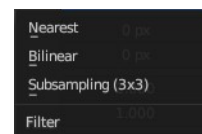

Video Panel

Strobe

Don't display every frame, but just every nth frame.

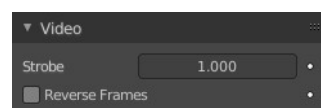

Reverse Frames

Reverse the frame order.

Color Panel

Saturation

The intensity of the input color.

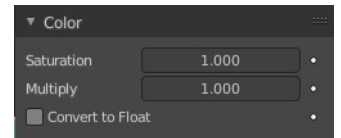

Multiply

Multiply colors by this factor.

Convert to Float

Convert input to float data.

Sound Panel

This panel shows with an audio clip selected.

Volume

The volume of the audio clip.



Pitch

The pitch of the audio clip.

Pan

When mono, the pan of the audio clip.

Mono

Set the audio clip to mono.

Display Waveform

Display the waveform in the clip.

Time Panel

Time related settings.

Lock

Lock strip so that it cannot be transformed.

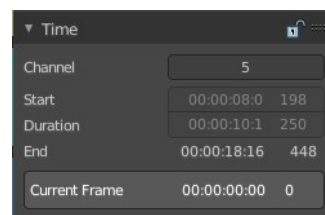

Channel

The channel of the strip.

Start

The start frame of the strip.

Duration

The duration of the strip.

End

The end frame of the strip.

Current Frame

Info box that displays the position of the frame cursor.

Scene Panel

This panel just shows with strip type scene.

Scene Property

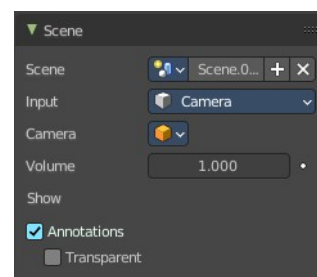

Scene Browser

A scene browser that contains the available scenes in the file.

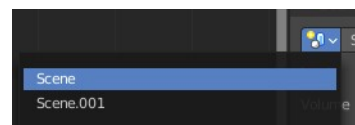

Scene edit box

The name of the scene. It can be renamed by double clicking into the edit box.

Add

Add a new scene. This button calls a menu where you can choose with what method you want to create the new scene.

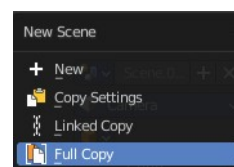

New

Adds a new empty scene.

Copy Settings

Adds a new empty scene. And copies the settings from the current scene.

Linked Copy

Link in the collections from the current scene. (Shadow Copy)

Full Copy

Make a full copy of the current scene.

Remove

Remove the scene as the active one. Note that the scene is still available in the scene browser.

Input

Type of input to use. The camera of the scene. Or a file from the sequencer in this scene.

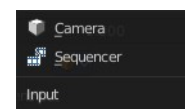

Input Type Camera

Volume

The audio volume.

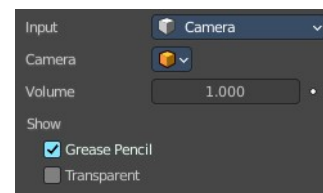

Camera

Which camera of the scene to use.

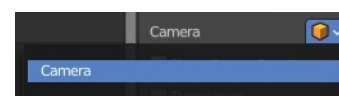

Show Grease Pencil

Show grease pencil strokes in OpenGL previews.

Transparent

Use a transparent background.

Input type Sequencer

Volume

The audio volume.



Mask Panel

This panel just shows with strip type Mask.

Mask Property

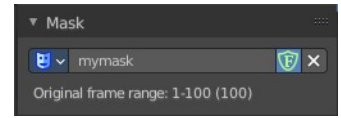

Mask Browser

A mask browser that contains the available masks in the file.

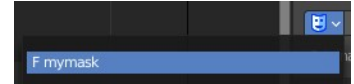

Mask edit box

The name of the scene. It can be renamed by double clicking into the edit box.

Fake User

Assign a fake user to this mask. Fake users is a odd concept to keep data in the scene even if it has no user somewhere. The fake user is then a dummy user so that the object is not deleted when saving the scene.

Remove

Remove the scene as the active one. Note that the scene is still available in the scene browser.

Effect Strip Panel

Settings for the single effect strip types.

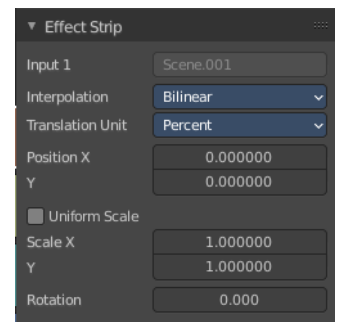
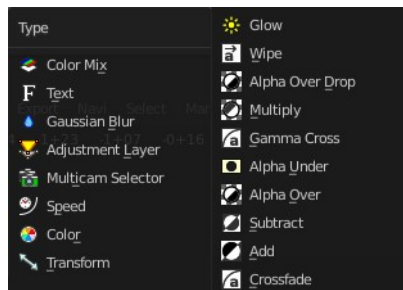

Effect strip type Color Mix

Input 1

The first strip.

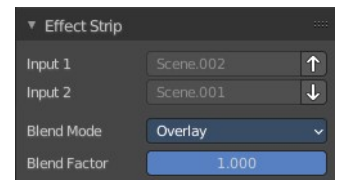

Input 2

The second strip.

Swap Strips

Swap the strips.

Blend Mode

The color blend mode to use.

Blend Factor

The blend factor. 1.000 means 100%.

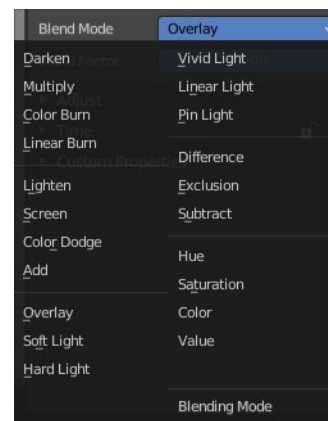

Effect strip type Text

Text

The text to displayed.

Wrap Width

World wrap width as factor. Zero disables the wrap.

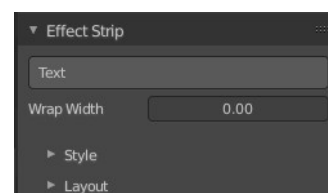

Style sub panel

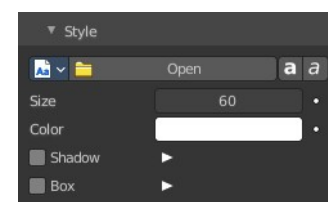

Font property

When no font is loaded then the internal font is used.

Font browser

The list of loaded fonts. This list is empty by default.

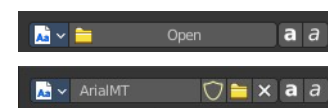

Open

Load a font.

Font Edit Box

Display the current active font. You can rename the font by double clicking in the edit box.

Fake User

Assign a fake user to this font. Fake users is an odd concept to keep data in the scene even if it has no user somewhere. The fake user is then a dummy user so that the object is not deleted when saving the scene.

Open Font

Load a font.



Remove

Remove the selected font as the active one. Note that the font is still in the list then.

Bold

Display the font bold.

Italic

Display the font italic.

Size

Size of the text.

Color

The text color.

Shadow

Creates a shadow of the specified color under the text.

Shadow color

The color of the shadow. Clicking at the color field opens a color dialog.

Box

Display colored box behind text.

Box Color

The color of the box.

Box Margin

The margin of the box. Based at the image width.

Layout sub panel

Location X/Y

Positions the text on the X, Y axis.

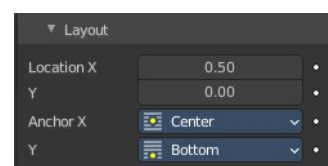

Anchor X/Y

Horizontal (X) or vertical (Y) anchor point of the text relative to the location.

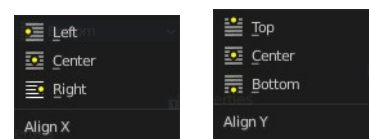

Effect strip type Gaussian Blur

Input 1

The strip to blur. This strip cannot be changed. You need to apply the effect with the correct strip selected.

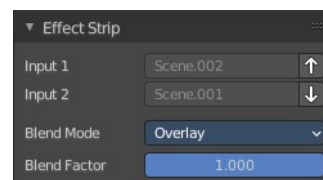

Size X

The size of the blur along X axis.

Y

The size of the blur along Y axis.

Effect strip type Multicam

Source Channel

The channel which the Multicam Selector gets its input from.

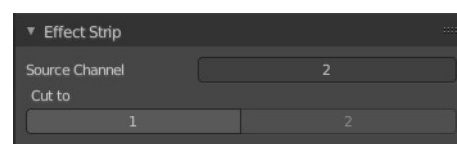

Cut to

Cuts the Multicam strip at the current frame and changes the Source Channel automatically to the selected channels.

Effect strip type Speed Control

Input

The video where the speed control is applied to. This is read only.

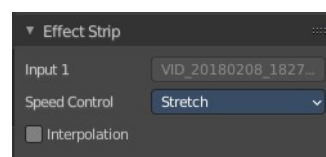

Speed Control



Stretch

Adjust input playback so that the input duration fits the strip length

Multiply

Multiply with the speed factor.

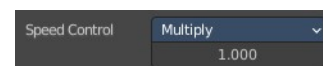

Multiply factor

The speed factor.

Frame Number

Frame Number of the Input strip.

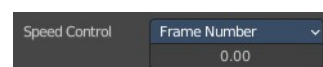

Frame number

The frame number.

Length

Interpolation

Do crossfade blending between current and previous frame.

Effect strip type Color

Color Picker

Adjust the color of the color strip.

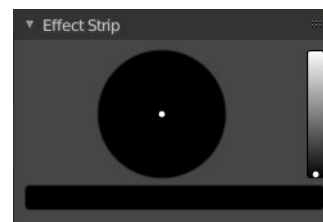

Effect strip type Transform

Input 1

The strip to transform. This strip cannot be changed. You need to apply the effect with the correct strip selected.

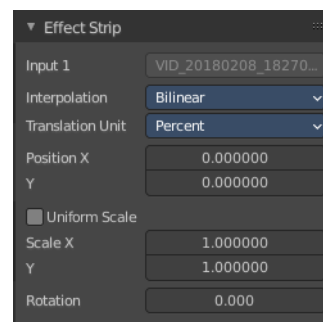

Interpolation

The interpolation type for the transform.

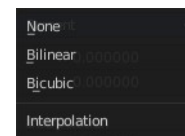

Translation Unit

The measure unit to use for the transform.

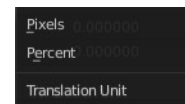

Position X

Amount to move the input in the X axis.

Y

Amount to move the input in the Y axis.

Uniform scale

Scale uniformly, preserve the aspect ratio.

Scale X

Amount to scale the input in the X axis.

Y

Amount to scale the input in the Y axis.

Rotation

Degrees to rotate the input.

Effect strip type Glow

Input 1

The strip to use. This strip cannot be changed. You need to apply the effect with the correct strip selected.

Threshold

Minimum intensity to trigger a glow.

Clamp

The brightness limit of intensity.

Boost Factor

Brightness multiplier.

Blur Distance

The radius of the glow effect.

Quality

The accuracy of the blur effect.

Only Boost

Show the glow buffer only.

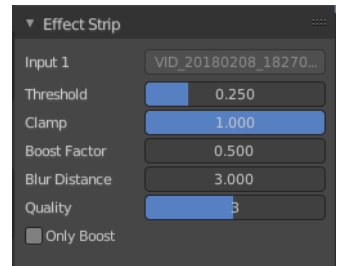

Effect strip type Wipe

Input 1

The first strip.

Input 2

The second strip.

Swap Inputs

Swap the two strips.

Transition type

The wipe effect type.

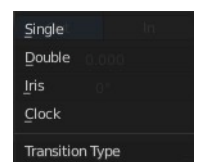
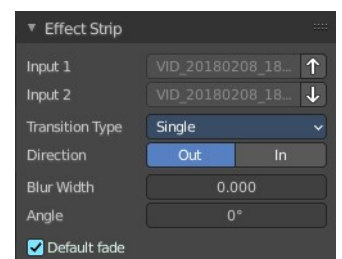

Direction

The direction of the wipe.

Blur width

The width of the blur edge, relative to the image size.

Angle

The edge angle.

Default Fade

Use the builtin default effect time, which is as long as the fade clip. Or adjust the effect time.



Effect strip type Alpha over Drop

Input 1

The first strip.

Input 2

The second strip.

Swap Inputs

Swap the two strips.

Default Fade

Use the builtin default effect time, which is as long as the fade clip. Or adjust the effect time.

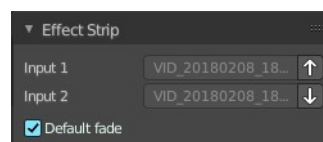

Effect strip type Multiply

Input 1

The first strip.

Input 2

The second strip.

Swap Inputs

Swap the two strips.

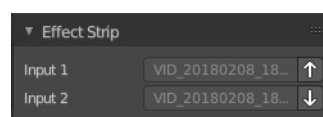

Effect strip type Gamma Cross

Input 1

The first strip.

Input 2

The second strip.

Swap Inputs

Swap the two strips.

Default Fade

Use the builtin default effect time, which is as long as the fade clip. Or adjust the effect time.

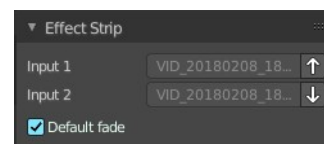

Effect strip type Alpha Under

Input 1

The first strip.

Input 2

The second strip.

Swap Inputs

Swap the two strips.

Default Fade

Use the builtin default effect time, which is as long as the fade clip. Or adjust the effect time.

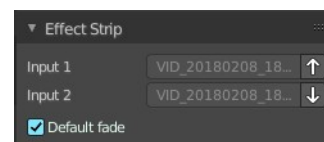

Effect strip type Alpha Over

Input 1

The first strip.

Input 2

The second strip.

Swap Inputs

Swap the two strips.

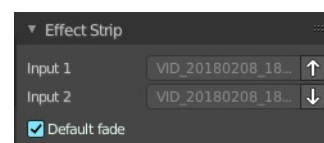

Default Fade

Use the builtin default effect time, which is as long as the fade clip. Or adjust the effect time.



Effect strip type Subtract

Input 1

The first strip.

Input 2

The second strip.

Swap Inputs

Swap the two strips.

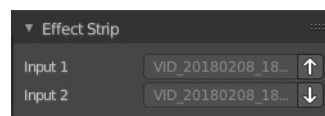

Effect strip type Add

Input 1

The first strip.

Input 2

The second strip.

Swap Inputs

Swap the two strips.

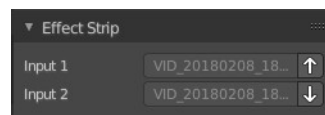

Effect strip type Crossfade

Input 1

The first strip.

Input 2

The second strip.

Swap Inputs

Swap the two strips.

Default Fade

Use the builtin default effect time, which is as long as the fade clip. Or adjust the effect time.



Custom Properties Panel

Here you can define custom properties that can be used for scripting.

Here you might also find custom properties from addons or scripts.

Add

Adds a new property.

Edit

Opens a panel where you can adjust the settings for the custom property.

Remove

Removes the property.

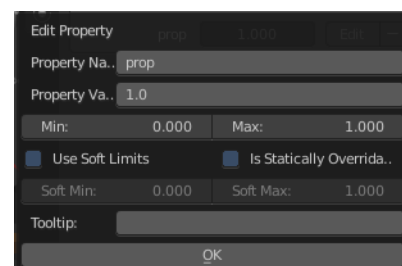
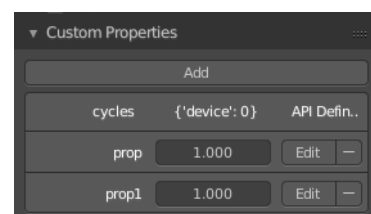

14.3.4 Editors - Video Sequence Editor - Sidebar - Sequencer - Tool tab

Table of content

Tool Tab.....	1
Tool Tab and Top Bar.....	1

Tool Tab

In the tool tab you will find the tool related settings for the tools in the tool shelf. These settings are explained for the single tools in the tool shelf chapter.

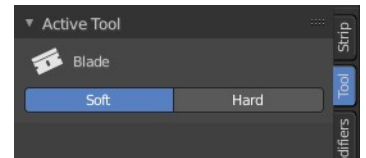

Tool Tab and Top Bar

The content in the Tool Tab is besides one panel the same than in the Topbar.

Different from the 3D view, he top bar cannot be hidden.

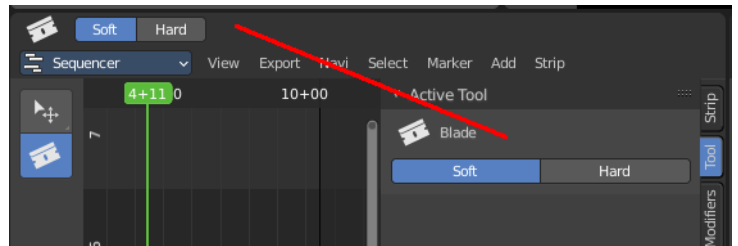

14.3.5 Editors - Video Sequence Editor - Sidebar - Sequencer - Modifier tab

Table of content

Modifier Tab.....	3
General functionality.....	3
Add.....	3
Header elements.....	3
Collapse panel.....	3
Modifier Icon.....	3
Modifier Name.....	3
Mute.....	3
Move Strip Modifier.....	3
Remove Strip Modifier.....	3
Modifiers Panel.....	4
Use Linear Modifiers.....	4
Add Strip Modifiers.....	4
Copy to selected Strips.....	4
Workflow.....	4
Replace.....	4
Append.....	4
Color Balance Modifier.....	4
Mask Input Type.....	4
Mask Input Type type Strip.....	5
Mask.....	5
Mask Input Type type Mask.....	5
Mask.....	5
Mask Time.....	5
Relative.....	5
Absolute.....	5
Multiply Colors.....	5
Lift.....	5
Gamma.....	5
Gain.....	5
Curves Modifier.....	5
Mask Input Type.....	5
Mask.....	5
Tone.....	6
C R G B.....	6
Selecting Points.....	6
Adding Points.....	6
Navigation elements.....	6
Zoom in and out.....	6
Tools.....	6
Reset View.....	6
Vector Handle.....	6
Auto Handle.....	6
Auto Clamped Handle.....	6

Extend horizontal.....	7
Extend vertical.....	7
Reset Curve.....	7
Use Clipping.....	7
Delete Points.....	7
Hue Correct Modifier.....	7
Mask Input Type.....	7
Mask.....	7
H S V.....	7
Selecting Points.....	7
Adding Points.....	8
Navigation elements.....	8
Zoom in and out.....	8
Tools.....	8
Reset View.....	8
Vector Handle.....	8
Auto Handle.....	8
Auto Clamped Handle.....	8
Extend horizontal.....	8
Extend vertical.....	8
Reset Curve.....	8
Use Clipping.....	9
Delete Points.....	9
Bright / Contrast modifier.....	9
Mask Input Type.....	9
Mask.....	9
Bright.....	9
Contrast.....	9
Mask modifier.....	9
Mask Input Type.....	9
Mask.....	9
White Balance modifier.....	9
Mask Input Type.....	10
Mask.....	10
White Value.....	10
Tone map modifier.....	10
Mask Input Type.....	10
Mask.....	10
Tone map Type.....	10
Intensity.....	10
Contrast.....	10
Adaption.....	10
Color Correction.....	10

Modifier Tab

In the Modifier tab you will find strip modifiers to manipulate image content. Modifiers is a non destructive way to manipulate the data.

Note that these modifiers cannot be applied.

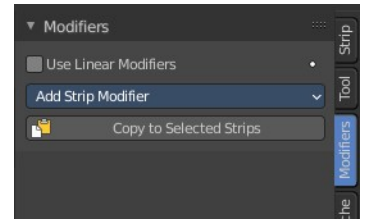

General functionality

Add

To add a modifier to an object, simply open the drop down menu, and choose the type of modifier that you want to add.

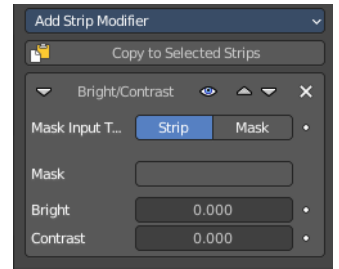
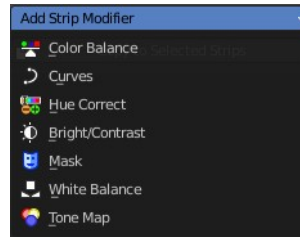

This will add the modifier to the list of modifiers. Also called the modifier stack.

Header elements

Elements are explained from left to right.

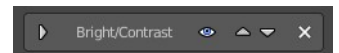

Collapse panel

The whole modifier panel can be collapsed. Click at the arrow button up left in the header.

Modifier Icon

This icon shows the type of the modifier. And has no further functionality.

Modifier Name

The name of the modifier. You can rename modifiers by clicking into the edit field and change the text.

Mute

Don't use this modifier.

Move Strip Modifier

Move the modifier upwards or downwards in the list.

Remove Strip Modifier

Removes the modifier from the list.

Modifiers Panel

Use Linear Modifiers

Calculate modifiers in linear space instead of sequencer space.

Add Strip Modifiers

The list of available modifiers. Clicking will insert it into the modifier stack.

Copy to selected Strips

Copies the modifiers from one strip to another strip.

Workflow

Select the strip without modifier. Hold down shift, select the strip with the modifiers. Click the copy to selected button, choose the method in the popup. And the modifier should now be at the first strip.

Replace

Replace the modifiers in the modifier stack of the target strip.

Append

Append the modifiers to the modifier stack of the target strip.

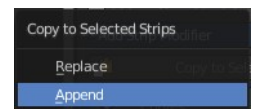
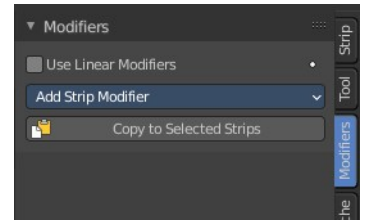

Color Balance Modifier

Color balance adjustments, through Lift, Gamma, and Gain.

Mask Input Type

Type of input data used for mask.



Mask Input Type type Strip

Mask

The strip used as mask input for the modifier.

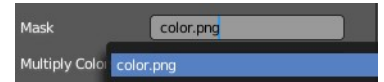

Mask Input Type type Mask

Mask

The mask used as mask input for the modifier.



Mask Time

Time to use for the mask animation.

Relative

Mask animation is offset to start of strip.

Absolute

Mask animation is in sync with scene frame.

Multiply Colors

Multiply the intensity of each pixel by this factor.

Lift

Color picker for the lift color. The panel content should be self explaining.

Gamma

Color picker for the Gamma color. The panel content should be self explaining.

Gain

Color picker for the Gain color. The panel content should be self explaining.

Curves Modifier

Color and RGB curves.

Mask Input Type

Type of input data used for mask.

Mask

The strip used as mask input for the modifier.

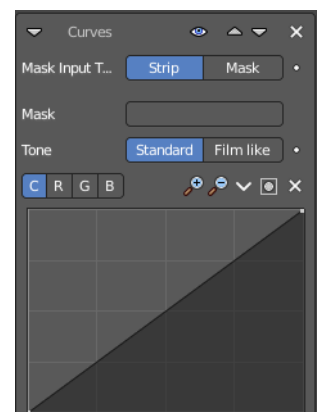
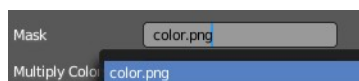

Tone

Tone mapping of the curve. Standard or film like.

C R G B

What color channels to affect. C stands for color, for all channels.

Selecting Points

You can select curve points. This reveals two edit boxes for the x and y coordinate of this point.

Selected points can be moved around. Left click at them, hold the mouse button down and move them to a new location.

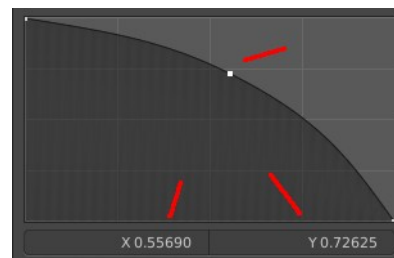

Adding Points

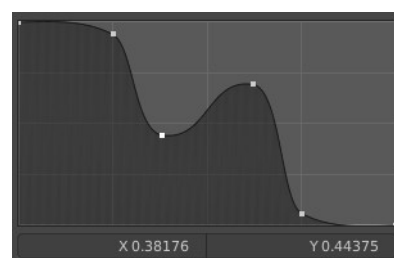

Navigation elements

The navigation elements at the top are described from left to right.

Zoom in and out

The two buttons with the magnifying glass at it zooms in and out in the curve window.



Tools

Tools is a menu where you can find some curve related tools.

Reset View

Resets the curve windows zoom.

Vector Handle

Set handle type to Vector.

Auto Handle

Set handle type to Auto.

Auto Clamped Handle

Set handle type to Auto Clamped.

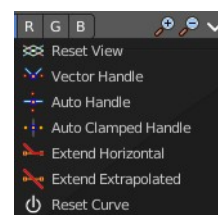

Extend horizontal

Extends the curve horizontal before the first curve point and after the last curve point.

Extend vertical

Extends the curve vertical before the first curve point and after the last curve point.

Reset Curve

Resets the curve to the initial shape.

Use Clipping

Clipping options. Set up clipping for the stroke. The blue button at the top turns clipping on or off.

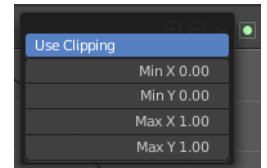

Delete Points

Deletes the selected curve point.

Hue Correct Modifier

HSV multi points curves.

Mask Input Type

Type of input data used for mask.

Mask

The strip used as mask input for the modifier.

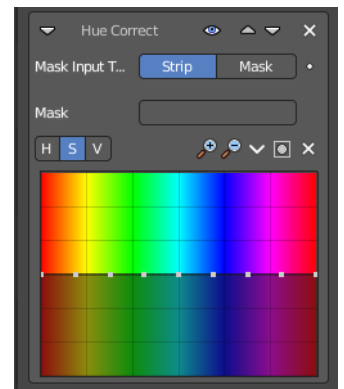
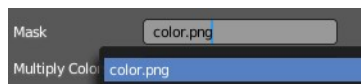

H S V

What color channels to affect. Hue, saturation, value.

Selecting Points

You can select curve points. This reveals two edit boxes for the x and y coordinate of this point.

Selected points can be moved around. Left click at them, hold the mouse

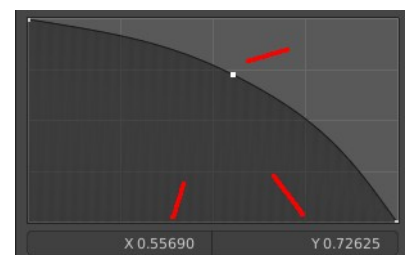

button down and move them to a new location.

Adding Points

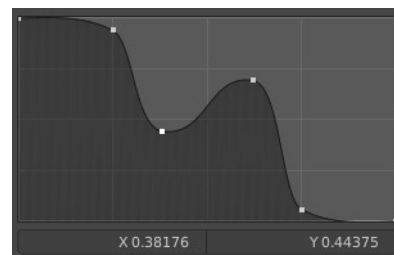

Navigation elements

The navigation elements at the top are described from left to right.

Zoom in and out

The two buttons with the magnifying glass at it zooms in and out in the curve window.

Tools

Tools is a menu where you can find some curve related tools.

Reset View

Resets the curve windows zoom.

Vector Handle

Set handle type to Vector.

Auto Handle

Set handle type to Auto.

Auto Clamped Handle

Set handle type to Auto Clamped.

Extend horizontal

Extends the curve horizontal before the first curve point and after the last curve point.

Extend vertical

Extends the curve vertical before the first curve point and after the last curve point.

Reset Curve

Resets the curve to the initial shape.

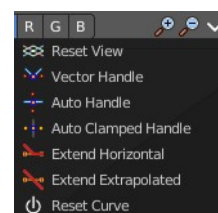

Use Clipping

Clipping options. Set up clipping for the stroke. The blue button at the top turns clipping on or off.

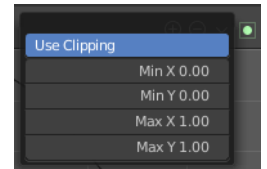

Delete Points

Deletes the selected curve point.

Bright / Contrast modifier

Adjusts the brightness and contrast of the modifier input.

Mask Input Type

Type of input data used for mask.

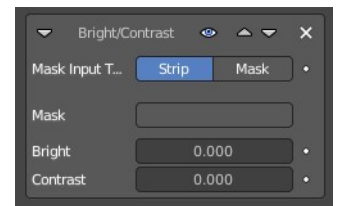

Mask

The strip used as mask input for the modifier.

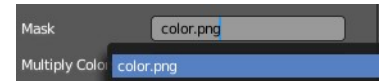

Bright

Adjust the luminosity of the colors.

Contrast

Adjust the contrast of the colors.

Mask modifier

Use it for masking the other modifiers in the stack which are below.

Mask Input Type

Type of input data used for mask.

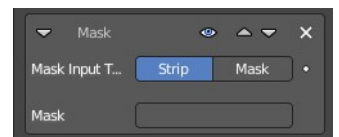

Mask

The strip used as mask input for the modifier.

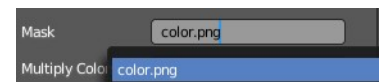

White Balance modifier

Use it to adjust the white balance by choosing the color that should be white.

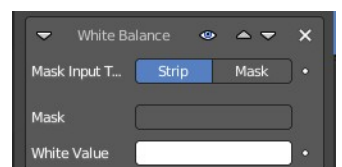

Mask Input Type

Type of input data used for mask.

Mask

The strip used as mask input for the modifier.

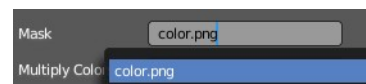

White Value

The color that defines white in the strip.

Tone map modifier

Used to map one set of colors to another in order to approximate the appearance of high dynamic range images in a medium that has a more limited dynamic range.

Mask Input Type

Type of input data used for mask.

Mask

The strip used as mask input for the modifier.

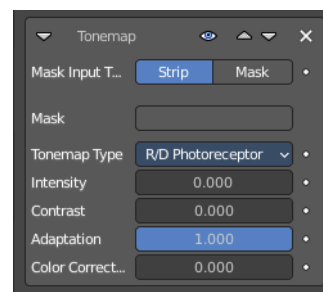

Tone map Type

What tone mapping algorithm to use.

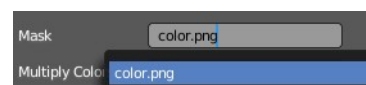
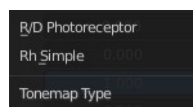

Intensity

A value less than zero darkens the image. A value higher than zero brightens the image.

Contrast

Adjust the contrast. A value of 0 uses the input value.

Adaption

The color adaption. If 0 global, if 1 based on pixel intensity.

Color Correction

The color correction. If 0 same for all channels. If 1 each independent.

14.3.6 Editors - Video Sequence Editor - Sidebar - Sequencer - Proxy&Cache tab

Table of content

Cache Settings panel.....	1
Cache Raw.....	1
Cache Preprocessed.....	1
Cache Composite.....	2
Cache Final.....	2
Strip Cache panel.....	2
Enable Strip Cache.....	2
Cache Raw.....	2
Cache Preprocessed.....	2
Cache Composite.....	2
Proxy Settings Panel.....	2
Storage.....	2
Per Strip.....	2
Project.....	2
Proxy Directory.....	2
Set Selected Strip Proxies.....	3
Rebuild Proxy and Time code Indices.....	3
Strip Proxy & Time code panel.....	3
Custom Proxy.....	3
Proxy Custom Directory.....	3
Proxy Custom File.....	3
Resolutions.....	3
Overwrite.....	3
Build Jpeg Quality.....	3
Time code Index.....	3

Cache Settings panel

The Cache is used to save frames in memory for preview, so they can be later displayed much faster than rendered from scratch. Cache capacity can be set in System tab of the Preferences.

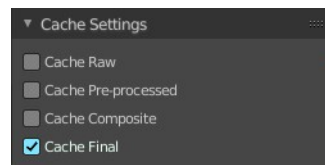

In this panel you can set up types of images that will be cached for all strips.

Cache Raw

Cache raw images read from drive, for faster tweaking of strip parameters at the cost of memory usage.

Cache Preprocessed

Cache preprocessed images, for faster tweaking of effects at the cost of memory usage.

Cache Composite

Cache intermediate composited images, for faster tweaking of stacked strips at the cost of memory usage.

Cache Final

Cache final image for each frame.

Strip Cache panel

Similar to Cache Settings Panel, this panel sets the types of images that will be cached for the active strip.

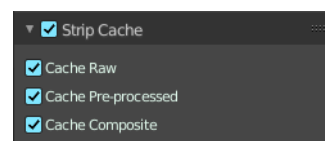

Enable Strip Cache

Enable overriding the cache defaults. When disabled, Cache Settings will be used.

Cache Raw

Cache raw images read from drive, for faster tweaking of strip parameters at the cost of memory usage.

Cache Preprocessed

Cache preprocessed images, for faster tweaking of effects at the cost of memory usage.

Cache Composite

Cache intermediate composited images, for faster tweaking of stacked strips at the cost of memory usage.

Proxy Settings Panel

Storage

Defines whether the proxies are for individual strips or the entire sequence.

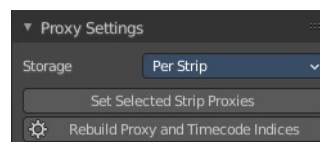

Per Strip

Proxies are stored in the directory of the input.

Project

All proxies are stored in one directory.

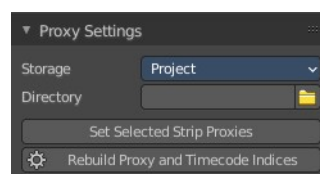

Proxy Directory

The location to store the proxies for the project.

Set Selected Strip Proxies

Set proxy size and overwrite flag for all selected strips.

Rebuild Proxy and Time code Indices

Generates Proxies and Time codes for all selected strips, same as doing Strip ? Rebuild Proxy and Time code indices.

Strip Proxy & Time code panel

Custom Proxy

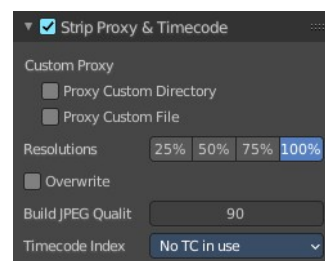

Proxy Custom Directory

Use a custom directory to store data. Activating the tool reveals a directory picker.

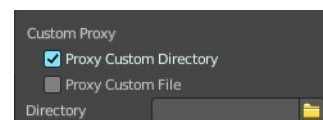

Proxy Custom File

Use a custom file to read proxy data from. Activating the tool reveals a directory picker.

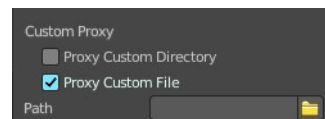

You can either show the directory or the custom file path directory picker.

Resolutions

Buttons to control how big the proxies are. The available options are 25%, 50%, 75%, 100 percent of original strip size.

Overwrite

Saves over any existing proxies in the proxy storage directory.

Build Jpeg Quality

Defines the quality of the JPEG images used for proxies.

Time code Index

When you are working with footage directly copied from a camera without pre-processing it, there might be bunch of artifacts, mostly due to seeking a given frame in sequence. This happens because such footage usually

does not have correct frame rate values in their headers. This issue can still arise when the source clip has the same frame rate as the scene settings. In order for Blender to correctly calculate frames and frame rate there are two possible solutions:

Preprocess your video with e.g. MEncoder to repair the file header and insert the correct keyframes.

Use Proxy/Time code option in Blender.

The following time codes are supported:

No TC in use – do not use any time code

Record Run

Free Run

Free Run (rec date)

Record Run No Gaps

Note! Record Run is the time code which usually is best to use, but if the clip's file is totally damaged, Record Run No Gaps will be the only chance of getting acceptable result.

14.3.7 Editors - Video Sequence Editor - Sidebar - Sequencer - View tab

Table of content

View Settings Panel.....	1
Proxy Render Size.....	1
Use Proxies.....	1
Prefetch Frames.....	1
Channel.....	1
Show Overexposed.....	2
Frame Overlay Panel.....	2
Set Overlay Region.....	2
Frame offset.....	2
Overlay Type.....	2
Overlay Lock.....	2
Scene Strip Display panel.....	2
Shading.....	2
Override scene settings.....	3

View Settings Panel

Note that this panel just shows when Preview As Backdrop is activated.

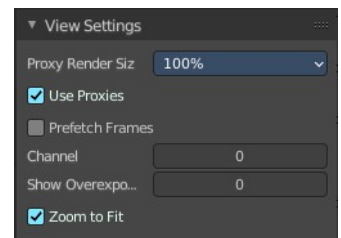

Proxy Render Size

Size to display proxies at in the preview region. Using a smaller preview size will increase speed.

Proxies is a simplified data set to speed up workflow.

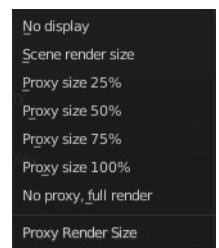

Use Proxies

Use proxy images instead of the real material to speed up workflow.

Prefetch Frames

Render frames ahead of current frame in the background for faster playback.

Channel

Which channel number to show in the image preview. The value 0 is the result of all strips combined.

Show Overexposed

Shows overexposed (bright white) areas using a zebra pattern. The threshold can be adjust with the slider.

Frame Overlay Panel

Note that this panel just shows when Preview As Backdrop is activated.

Display an overlay on top of the sequencer with a frame offset of the content.

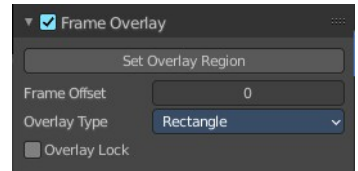

When the feature is active then you will see a green dashed line in the sequencer timeline.

Set Overlay Region

Box select a portion of the viewport to display the overlay content.

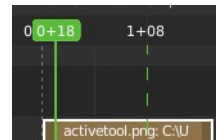

Frame offset

What offset frame to use, relative to the current frame position.

Overlay Type

The overlay draw type.

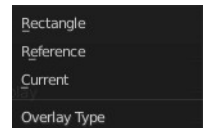

Overlay Lock

Locks the overlay frame to the current frame. It will not go ahead when you play the video.

Scene Strip Display panel

Note that this panel just shows when Preview As Backdrop is activated.

Settings for the strip type Scene Strip.

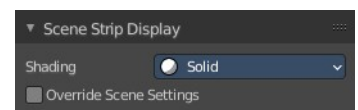

Shading

How to display the scene content in the preview window.

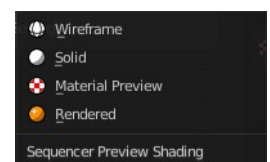

Override scene settings

Use the workbench render settings from the sequencer scene instead of the settings instead of each individual scene used in the strip.



15 Movie Clip Editor

Table of content

Movie Clip Editor.....	2
Areas.....	3
Modes and Sub modes.....	3
Clip, Graph and Dope sheet subeditors.....	4
Tracking Mode - Clip Subeditor.....	4
Navigation elements.....	4
Pan the View.....	4
Zoom In/Out the View.....	4
Timeline.....	4
Tracking Mode - Graph Subeditor.....	4
Tracking Mode - Dope sheet Subeditor.....	5
Mask Mode.....	5
Navigation elements.....	5
Pan the View.....	5
Zoom In/Out the View.....	5
2D Cursor.....	6
Last Operator Set 2D cursor.....	6
Add Vertex and Slide.....	6
Last Operator Add Vertex and Slide.....	6
Location X / Y.....	6
Navigating in the viewport.....	6
Hotkeys.....	6
Tracking mode - Clip Sub mode - Context menu.....	6
Copy Track Settings.....	7
Copy from Active Track.....	7
Copy Color.....	7
Copy Tracks.....	7
Paste Tracks.....	7
Disable Markers.....	7
Enable Markers.....	7
Last operator Disable Markers.....	7
Action.....	7
Hide Tracks.....	7
Show Tracks.....	7
Last Operator Hide Tracks.....	8
Unselected.....	8
Lock Tracks.....	8
Unlock Tracks.....	8
Last Operator Lock Tracks.....	8
Action.....	8
Join Tracks.....	8
Delete Track.....	8
Mask mode - Context menu.....	8
Add Vertex and Slide.....	8
Set Handle Type.....	9
Last operator Set Handle Type.....	9
Type.....	9

- Switch Direction.....9
- Toggle Cyclic.....9
- Copy Splines.....9
- Paste Splines.....9
- Re-key Shape Points.....9
- Clear Feather Weight.....9
- Reset Feather Animation.....9
- Make Parent.....9
- Clear Parent.....10
- Delete.....10
- Tracking Introduction.....10
 - Manual Lens Calibration.....10
 - Camera and Object Motion Solving.....10
 - Tools for Scene Orientation and Stabilization.....10
- Marker.....11
- Track.....11
- Quick Favourites menu.....12
- Slider snapping.....12
- Short tutorial.....12
 - Preparing the video.....13
 - Tracking the object.....14
 - Orientation and dimensions.....15
 - Reloading a project.....15

Movie Clip Editor

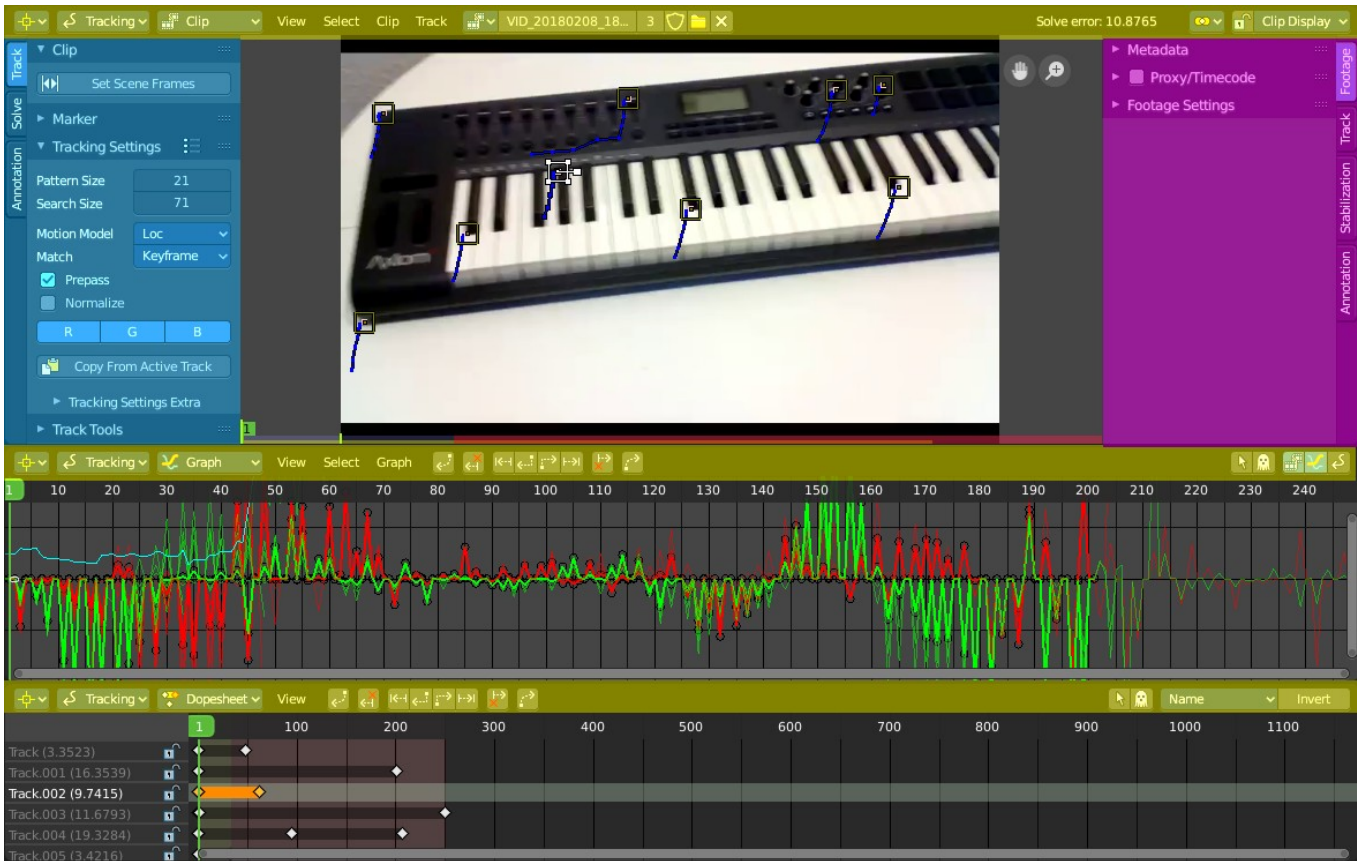

The Movie Clip Editor is the editor where you deal with the footage for motion tracking. Here you load your footage movies, mask them out, set the markers, and calculate the tracks.

Areas

The Movie Clip editor is divided into several areas has several tool areas. In the Clip editor we have header, tool shelf, sidebar and viewport. In the other modes there is just the header and the viewport.

Yellow – Header

Blue - Tool Shelf

Pink - Sidebar

Note that this editor does not have a tool area above the header. All tool settings are in the sidebar in the Tool tab.

Modes and Sub modes

The Movie Clip Editor has two modes. Tracking and Mask mode. The tracking mode has three sub modes that reveals three different sub editors.



Clip, Graph and Dope sheet subeditors

The Movie clip editor is three editors in one. The actual Clip editor, a Graph editor, and a Dope sheet editor. You can switch to the different editor types with the View drop down box in the header.

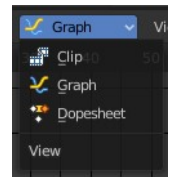

Tracking Mode - Clip Subeditor

The clip editor contains the footage related tools and settings. Here you deal with the footage movie. It's the main window that you see in the Motion tracking layout. The Clip Editor is used for tracking.

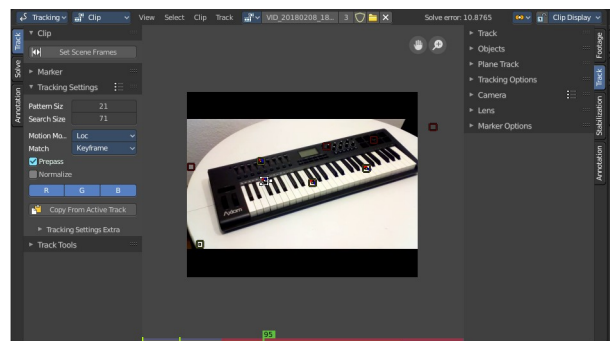

Navigation elements

In the upper right corner you will find two navigation elements.



Pan the View

Pans the view

Zoom In/Out the View

Zooms in or out.

Timeline

At the ground you can see a timeline. The green slider can be dragged around. You can set and show the current position in the video.



The timeline shows different colors, dependent of the state for this video area. Pink is the area where the tracking works fine. Red the area where the tracking has too much solve errors to show a useful result.

The green lines marks the Keyframe A and Keyframe B, which is the solve area.

Tracking Mode - Graph Subeditor

The Graph editor is the place where you can see and deal with the function curves of the recorded tracks for the single markers.

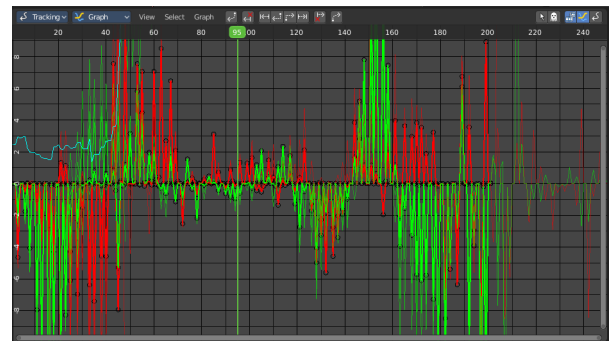

The timeline slider can be moved with the right mouse button. Or with the left mouse button when you grab the handler in the timeline.

Tracking Mode - Dope sheet Subeditor

The Dope sheet Editor is the place where you deal with the keyframes for the tracks.

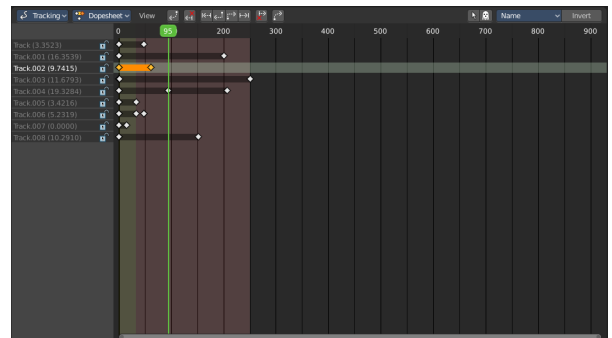

Mask Mode

In Mask mode you can mask out parts of the footage by adding splines and adjust them to cover the needed areas.

Masks have many purposes. They can be used in a motion tracking workflow to mask out, or influence a particular object in the footage. They can be used for manual rotoscoping to pull a particular object out of the footage. Or as a rough matte for green screen keying. This is done in the Node editor in compositing mode by a mask node.

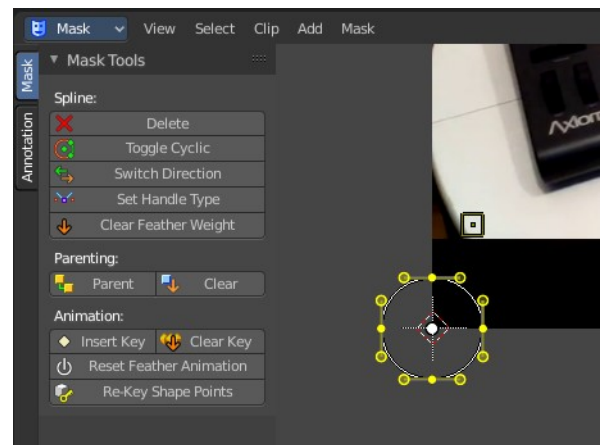

Masks are independent from a particular image of movie clip. And so they can just as well be used for creating motion graphics or other effects in the compositor.

Masks are defined by splines. Means you work with splines, and you have a bunch of spline tools available.

Navigation elements



In the upper right corner you will find two navigation elements.

Pan the View

Pans the view

Zoom In/Out the View

Zooms in or out.

2D Cursor

In Mask mode you will see a 2d cursor down left. It is for example the point at which the mask primitives are created. This 2D cursor can be set and moved by hotkey ALT + Right Mouse

Last Operator Set 2D cursor

Location X / Y

Adjust the position of the 2D cursor.

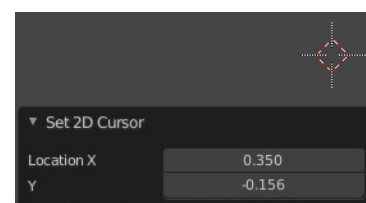

Add Vertex and Slide

You can create mask spline primitives from the Add menu. But you can also draw your own mask spline with hotkey Ctrl + Left Mouse.

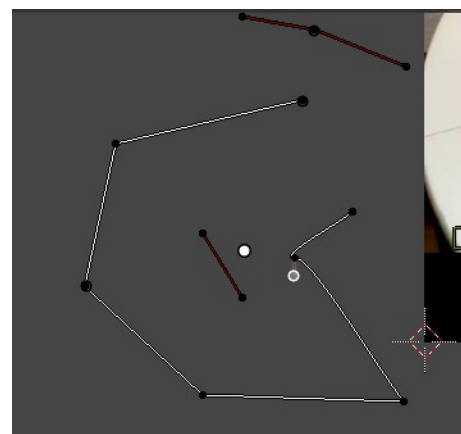

Last Operator Add Vertex and Slide

Location X / Y

The location of the latest created vertex point.



Navigating in the viewport

This navigation is valid for all three Movie Clip Editor sub types and both, the tracking mode and the mask mode.

Hotkeys

Pan the view - MMB

Zoom - Mouse Wheel, MMB+CTRL, Numpad + / -

View All - Home

Tracking mode - Clip Sub mode - Context menu

When you double right click into the viewport, then you will open a menu. The Context menu. Its content is to 100% double content to already existing menus. And it is despite the name not contextual.

Graph and Dope sheet sub modes does not have a context menu.

Copy Track Settings

Copies track settings from active to selected track. You need to select the source track first, then hold down shift, then select the target track. Then perform copy track settings.

Copy from Active Track

Copies track settings from active to default settings.

Copy Color

Copies color to all selected tracks. What color? Ask the Blender developers ...

Copy Tracks

Copies the selected tracks.

Paste Tracks

Pastes the selected tracks.

Disable Markers

Disables the currently selected marker(s)

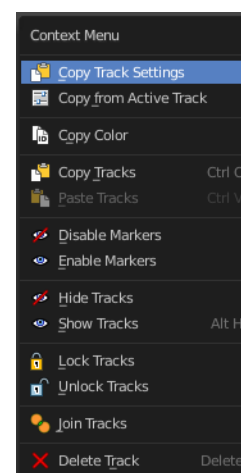

Enable Markers

Enables the currently selected marker(s)

Last operator Disable Markers

Action

Edit box where you can again choose if you want to enable or disable the selected marker(s).

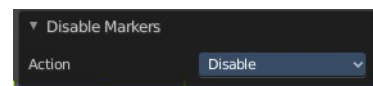

Hide Tracks

Hides the selected track(s)

Show Tracks

Shows the selected track(s)

Last Operator Hide Tracks

Unselected

Hide the unselected tracks.



Lock Tracks

Locks the selected tracks. You will see the locks in the Dopesheet view.

Unlock Tracks

Unlocks the selected tracks. You will see the locks in the Dopesheet view.

Last Operator Lock Tracks

Action

Lock or unlock the selected tracks.

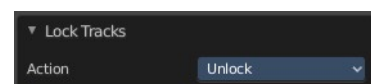

Join Tracks

Joins the selected tracks.

Delete Track

Deletes the selected tracks.

Mask mode - Context menu

When you double right click into the viewport, then you will open a menu. The Context menu. Its content is to 100% double content to already existing menus. And it is despite the name not contextual.

This functionality becomes active when you create a mask spline from the Add menu.

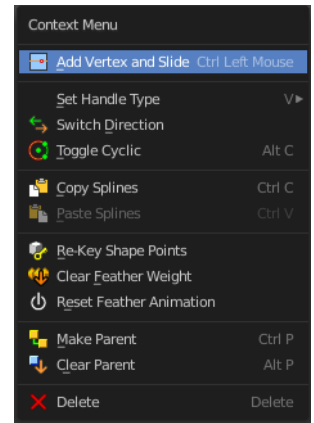

Add Vertex and Slide

Add a vertex with a handle to draw a free hand polygon.

This tool is hotkey only, and should only be used with the mouse.

Set Handle Type

In this sub menu you can set the handle type for the currently selected spline points.

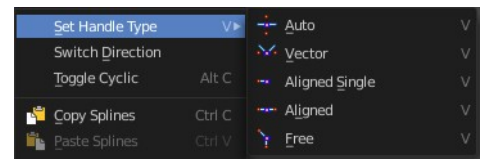

Last operator Set Handle Type

Type

Choose the handle type again.

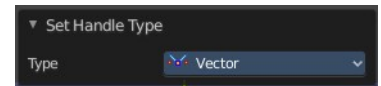

Switch Direction

Switch the direction in which the spline points. A spline has a direction. A starting point and an endpoint. By switching the starting point becomes the end point, the end point becomes the starting point.

Toggle Cyclic

Make the spline closed or open.

Copy Splines

Copies the currently selected spline.

Paste Splines

Pastes a copied spline.

Re-key Shape Points

Recalculate animation data on selected points for frames selected in the dopesheet.

Clear Feather Weight

Reset the feather weight to zero.

The curve type that is used to create mask splines is almost a Bézier curve. But it has some differences. Smooth edges of the mask are defined by feathering. The curve needed to support feathering in a way that stuck to the curve as you edited it, for ease of editing an animation. These are called S-Curves.

Besides the handles, every control point also has points that define the feather between the current point and the next point on the spline. Each feather point is stored in UV space, where U means position across spline segment, and V means distance between main spline and feather points.

Reset Feather Animation

Resets the feather offset across all animated frames.

Make Parent

Set the mask's parenting.

Clear Parent

Clears the mask's parenting.

Delete

Deletes the selected mask curve point.

Tracking Introduction

Match moving is a cinematic technique that allows the insertion of computer graphics into live-action footage (a movie) with correct position, scale, orientation, and motion relative to the objects in the shot. And this is what motion tracking does.

Bforartists motion tracker supports tools for 2D tracking and 3D motion tracking. This includes camera tracking and object tracking, as well as some special features like the plane track for compositing. Tracks can also be used to move and deform masks for rotoscoping in the Mask Editor. This is available as a special mode in the Movie Clip Editor.

Manual Lens Calibration

All cameras record distorted video. That's how optical lenses work. For accurate camera motion you need the exact value of the focal length and the “strength” of distortion.

Focal length can only be automatically obtained from the camera's settings or from the EXIF information. Both is not necessarily available. There are some tools which can help to find approximate values to compensate for distortion. There are also fully manual tools where you can use a grid which is getting affected by distortion model and deformed cells defines straight lines in the footage.

You can also use the grease pencil for this – just draw a line which should be straight on the footage using poly line brush and adjust the distortion values to make the grease pencil match lines on the footage.

To calibrate your camera more accurately, use the grid calibration tool from OpenCV. OpenCV is using the same distortion model, so it should not be a problem.

Camera and Object Motion Solving

Bforartists supports the solving of camera motion, including tripod shots,. It includes also the solving of object motion in relation to the motion of the camera. In addition to that there is the Plane Track, which solves the motion of all markers on one plane.

Tools for Scene Orientation and Stabilization

After solve, you need to orient the real scene in the 3D scene for more convenient compositing. There are tools to define the floor, the scene origin, and the X/Y axes to perform scene orientation.

Sometimes, the video footage includes spurious jumps and tilting movements, like e.g. when using a hand held camera. Based on some tracked image elements, the 2D Stabilization is able to detect and compensate such movements to improve the quality of the final result.

Marker

A marker is a tracking point in the movie. A point where the position of the pixel underneath the marker gets tracked. That's where the camera tries to follow the motion.

Each marker is represented by a rectangle. You can insert a marker by hand or automatically with the Detect feature.

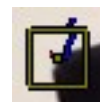

When you select a marker then it will be displayed with handlers. One in each corner, and a straight line from the center of the marker. This Handlers can be manipulated with the mouse.



The handlers in the corners allows to distort the marker, to fit it to distortions in the movie.



The straight handler from the center allows you to rotate and scale the marker.



Every marker has also a search area, where the searching for the tracking happens.

The search area can be enabled in the Marker Display panel in the Properties Sidebar.

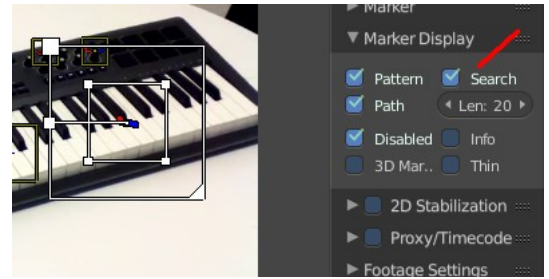

This area usually scales with the marker. To scale this search area separately you can use the handlers of this search area.

Or you can scale the marker only by pressing the scale hotkey twice.

Track

A track is the recorded movement of a marker. The movement is recorded in keyframes and curves. Once recorded you can see the track for the markers in the Dopesheet editor in the Movie Clip Editor.

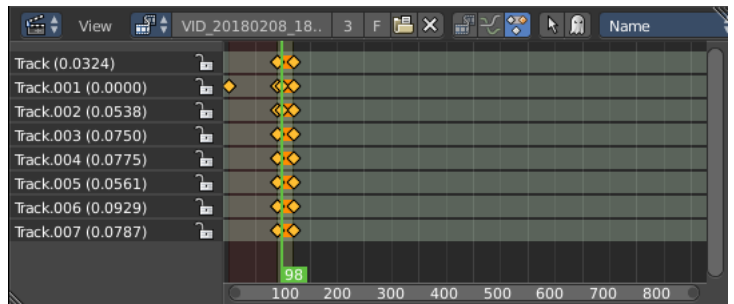

And you can see the curves for this track(s) in the Graph editor.

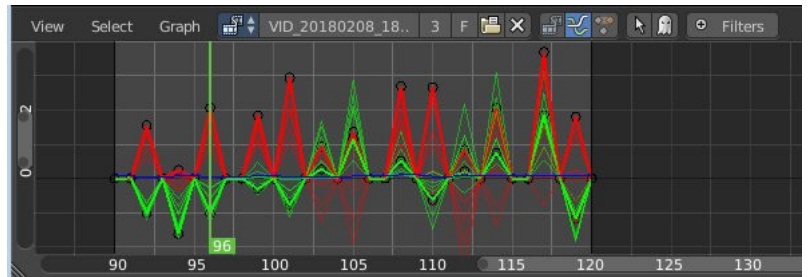

Quick Favourites menu

When you right click at a menu or a button, then a right click menu will open. Tools have usually a Add to Quick Favourites menu entry.

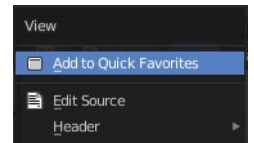

The Quick Menu is empty by default. With Add to Quick favourites you can add this menu to the Quick menu.

In the 3D view we have a menu called Quick in the header, which shows this content then. In the Movie Clip Editor you can just call it with its hotkey. Q. It has no regular menu entry here.

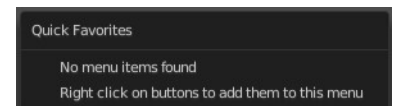

Slider snapping

Snapping also works at sliders. Hover with the mouse over the slider, start to slide, and holding down **Ctrl** will snap the sliders in incremental steps.



When it's a default value between 0 and 1 then it usually snaps in 0.1 steps. When it's a default value over 1 then it usually snaps in steps of 10.

The increment snapping also works at the frame slider. here the incremental snapping happens by the frame rate that you have defined. With a frame rate of 24 it will snap in steps of 24 frames when holding down ctrl.

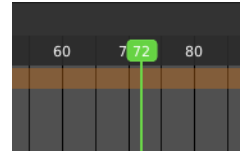

Short tutorial

There are too many steps involved to get Motion tracking working. You can't figure it out by your own, nothing is self explaining. So here comes a short workflow tutorial.

Note that we will just cover some of the basics here, some first steps. And we describe the setup for a ground tracking case here. I would suggest to search for a Blender tracking tutorial for more details.

Preparing the video

Load a video.

Set the frame to the one where you want to start the tracking. The range of the movie to work with can be set in the Timeline at the bottom of the layout. I have chosen frame 90 to 120 here. Since especially the first frames of my example movie were very blurry.



Click the Detect Features button in the tool shelf in the Track tab in the Marker panel. This sets some markers automatically, and adds tracks in the movie clip editor in dopesheet mode. Every track represents one marker.

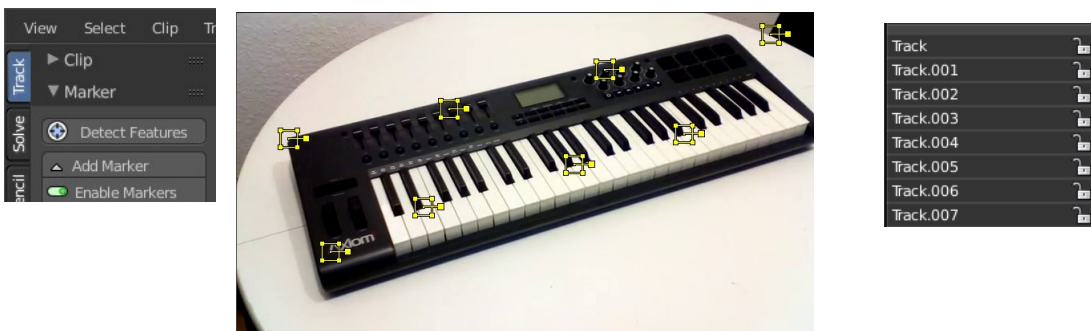

You can add a few more markers manually with the Add Marker button, and place them at marcant locations in the current image of the movie. Borders or Corners for example. To do so, click the Add Marker button, then click in the image. We need minimum eight markers to have enough stability. The Add Marker button is below the Detect Features button.

Selected markers can be moved with the left mouse. You can fine tune the position of the marker in the Track panel in the Properties sidebar. Simply move the image there to the required position.



Now choose a camera preset in the properties sidebar in the Camera Data panel. If unsure, and your camera isn't listed, select Blender. The presets can be found in the header.

Or type in the values manually. Sensor and Optical Center ...

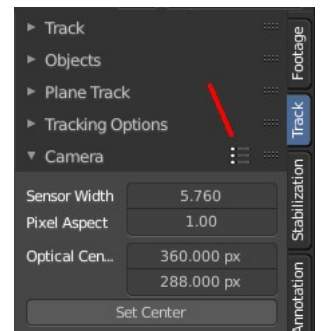

Select all markers.

Click the Track Forward button in the Track panel. This records everything. And you get data in the Graph Editor view. Blue and red lines for every marker.

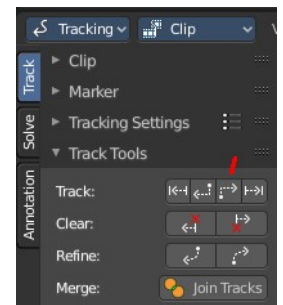
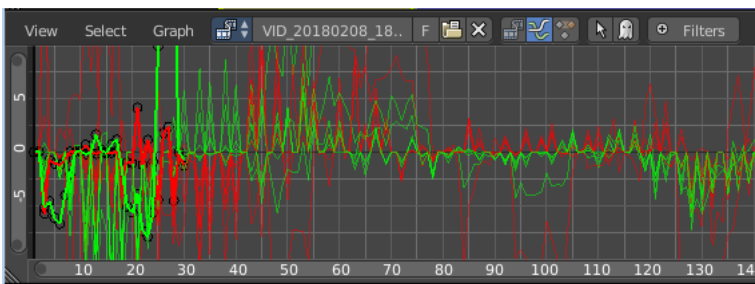

Some markers may go crazy at this point. Motion means blurry graphics. And then a marker can loose its tracking position. Or the tracking point moves out of the visible area.

You can either remove such markers after tracking when you have enough working tracks left. Remember we need eight valid tracks. You can also try to add new markers, and repeat the procedure with this new markers.

Or you can manually adjust the markers, and add a keyframe where they loose their position. Scroll to the frames where the marker is loosing its position, move it back into location, and add a keyframe for it. Adding keyframes is done in the Track menu.

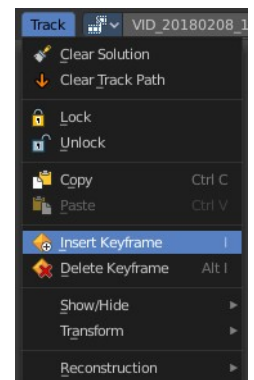

Tracking the object

This was the preparation of the movie material. Now for the tracking part. We need a camera. And something to track. A cube will do it for now.

In the 3D view, create or select the object that you want to track.

Now go into camera view, and adjust it so that it shows the content somehow in the center. Our cube for example.

Go to the solve tab into the solve panel. First adjust the range. I had tracked frame 90 to frame 120. So the default of 1 and 30 will not work since there are no keyframes for the markers at this position. And so you will get an error.

When done click at the solve camera motion button. This calculates the camera motion.

In the solve tab in the Scene Setup panel click at Set as Background. This will show our movie as background now in the 3D view in the camera view.

In the solve tab in the Geometry panel, click at 3D Markers to Mesh. You can also click Link Empty to Track. This will create an empty where you can parent things at.

Then click at Setup Tracking Scene below the Set as Background button. This will create a ground plane, which is used for shadow catching in the rendering. And now our object should already follow the motion of the movie when you play back.

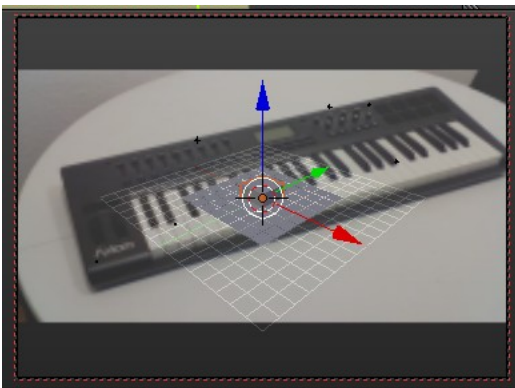
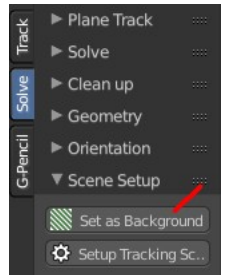
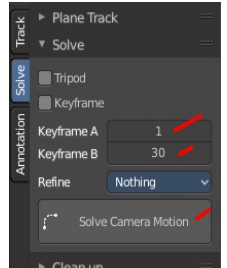

Orientation and dimensions

In the solve tab you can find the Orientation panel. This allows you to adjust the orientation of the object along marker points. Select three of your markers, and click at Floor, and the object will orient along this three points.

This may or may not lead to useful results. In our case it didn't. Even after selecting other markers. So we need to rotate our object manually.

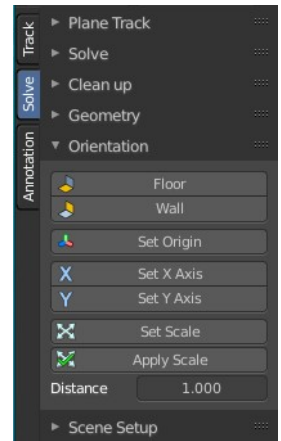
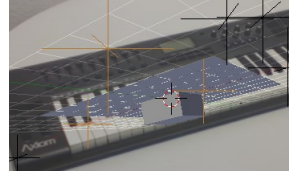

Reloading a project

When you save your project and reload it then you might notice that the Movie Clip editor loads empty. This is because Bforartists has by default "Load UI" unticked. The UI does not load from the previous project. And so it looks like the movie is missing and the project is empty.

There is nothing missing. You just need to select the movie again in the dropdown box at the top.

You can also tick Load UI in the file browser when you load the blend file.

When you work more often with motion tracking, then you might want to activate Load UI in the user preferences permanently.

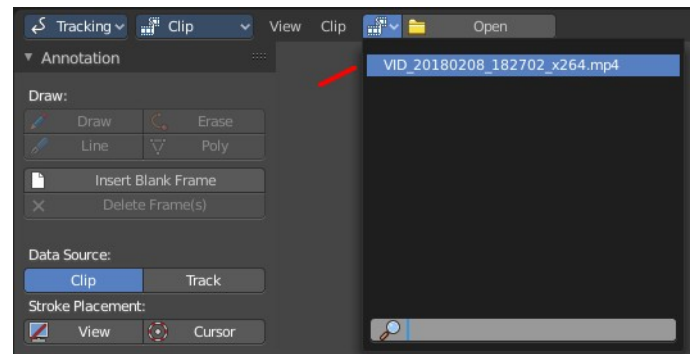



15.1 Editors - Movie Clip Editor - Header

Table of content

Movie Clip Editor - Header.....1
 Header right click menus.....1
 Editortype Menu.....1

Movie Clip Editor - Header

The Header contains various menus, navigation elements, settings and tools for the viewport.

The header is divided into two areas. Left menus. Right settings.



The Movie Clip Editor is three editors in one. And the Clip editor in mask mode looks also different. So we need to explain the content for all three editor types plus the sub mode mask.

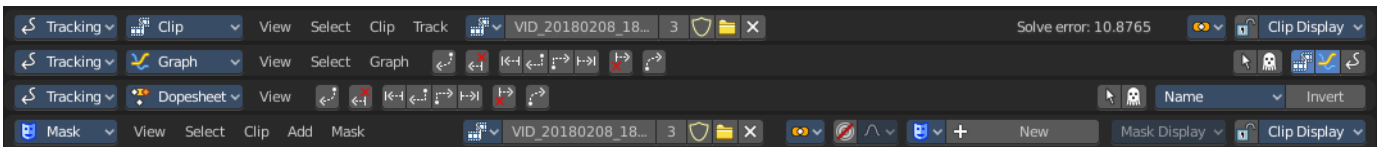

Header right click menus

The general right click menu functionality is explained in chapter 6 Editors introduction.

Editortype Menu

Bforartists is made of several editor types. Headers can display a menu where you can switch to other editor types.

This menu is hidden by default. It is meant to edit the layouts, and should not be necessary for regular work. You can reveal it in the header right click menu.

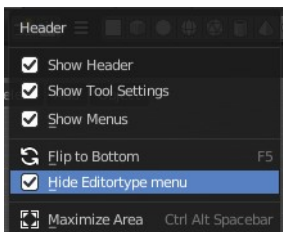
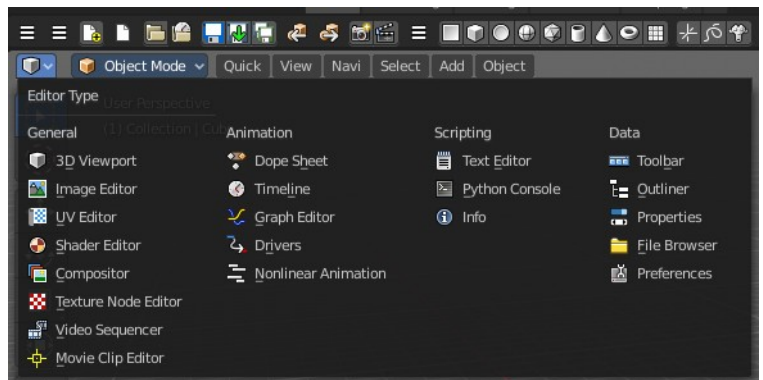



15.1.1 Editors - Movie Clip Editor - Header Tools and Options

Table of content

Movie Clip Editor - Header.....	3
Movie Clip prop.....	3
List of clips in the scene.....	3
Search form.....	3
Clip Edit Box.....	3
Number of Fake Users.....	3
Fake User.....	3
Open.....	4
Remove.....	4
Info String.....	4
Pivot Point.....	4
Lock to Selection.....	4
Mask Display.....	5
Mask Display.....	5
Spline.....	5
Edge Display.....	5
Overlay.....	5
Overlay Mode.....	5
Clip Display.....	5
Clip Display.....	5
R G B.....	5
BW.....	5
Mute Footage.....	5
Render Undistorted.....	5
Show Metadata.....	6
Show Stable.....	6
Grid.....	6
Calibration.....	6
Display Aspect Ratio X Y.....	6
Marker Display.....	6
Pattern.....	6
Search.....	6
Path.....	6
Length.....	6
Show Disabled.....	6
Info.....	6
3D Markers.....	6
Display Thin.....	6
Mask Display.....	7
Mask Display.....	7
Spline.....	7
Edge Display Type.....	7
Outline.....	7
Dash.....	7
Black.....	7
White.....	7
Overlay.....	7

Overlay Mode.....	7
Alpha Channel.....	7
Combined.....	7
Blending Factor.....	7
Marker Tools.....	8
Refine Markers Backwards.....	8
Clear Track Path Backwards.....	8
Track Markers Backwards.....	8
Track Markers Sequence Backwards.....	8
Track Markers Sequence Forwards.....	8
Track Markers Forwards.....	8
Clear Track Path Forwards.....	8
Refine Markers Forwards.....	8
Graph editor Options.....	8
Only selected.....	8
Display Hidden.....	9
Show Frames.....	9
Show Track Motion.....	9
Show Tracks Error.....	9
Options panel.....	9
Show Seconds.....	9
Sync Visible Range.....	9
Dopesheet editor Options.....	9
Only selected.....	9
Display Hidden.....	9
Dope sheet Sort Field.....	9
Invert.....	9
Options panel.....	10
Show Seconds.....	10
Sync Visible Range.....	10
Proportional Editing.....	10
Proportional Editing.....	10
Settings.....	10
Mask Prop.....	10
Mask Prop.....	10
List of Masks.....	11
Mask Edit Box.....	11
Fake User.....	11
Search form.....	11
Mask Display.....	11
Mask Display.....	11
Smooth.....	11
Overlay.....	11
Edge Display Type.....	11
Gizmo.....	12
Show Gizmo.....	12
Viewport Gizmos.....	12
Navigate.....	12

Movie Clip Editor - Header

The Movie Clip Editor has two modes, and is three editors in one. So we have to explain the single header tools and options at a one by one base.

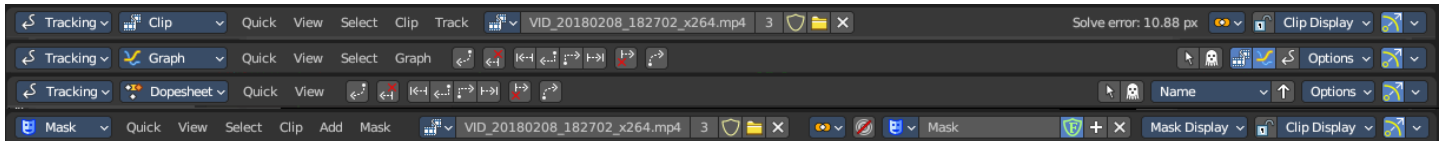

Movie Clip prop

Available in Tracking in Clip mode and Mask mode.

This property contains the list of loaded movie clips. When no movie clip is loaded or active, then it displays the Open Buttons. When a movie clip is loaded and active, then it displays the name of the currently active movie clip.

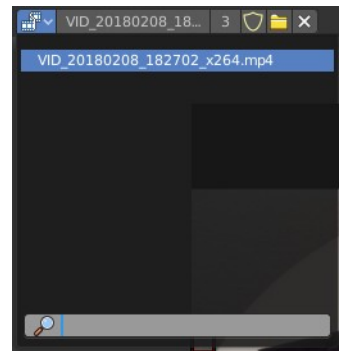

From left to right ...



List of clips in the scene

This is a list of the movie clips in the scene. Allows you to witch to other images.

Search form

Search for specific clips.

Clip Edit Box

The name of the currently selected movie clip. You can rename the movie clip here too.

Number of Fake Users

In case this file has a fake user assigned, then this number displays the number of fake users.

Fake User

With this button you assign a fake user to this selected image.

Data, like images, that is not longer linked to anything else gets removed when you save and reload a scene. Bforartists has the concept of fake users to go around this behavior. An image with a fake user is in fact linked to something. And so it is not lost when you save and reload the scene.

Open

Open a new movie clip.

Remove

Removes the movie clip. Note that it will not be removed when it has a fake user assigned. Then the clip becomes simply inactive. You can still use it from the list again.

Info String

Available in Tracking in Clip mode.

A string, giving you some informations about the scene. In this case the number of solve errors for the current tracking.

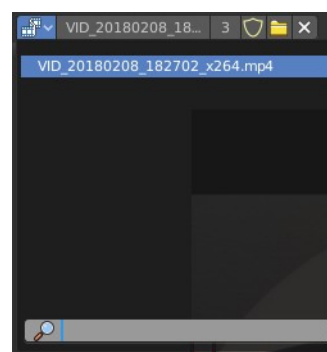

Pivot Point

Available in Tracking in Clip mode and Mask mode.

Adjust the pivot point for transform operations. The names should be self explaining.

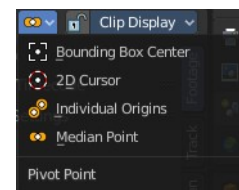

Lock to Selection

Available in Tracking in Clip mode.

With lock to selection disabled the viewport stands still and the markers moves. With lock to selection enabled the view is centered at the current selected marker, and the video moves around.

Available in Tracking in Clip mode and Mask mode.

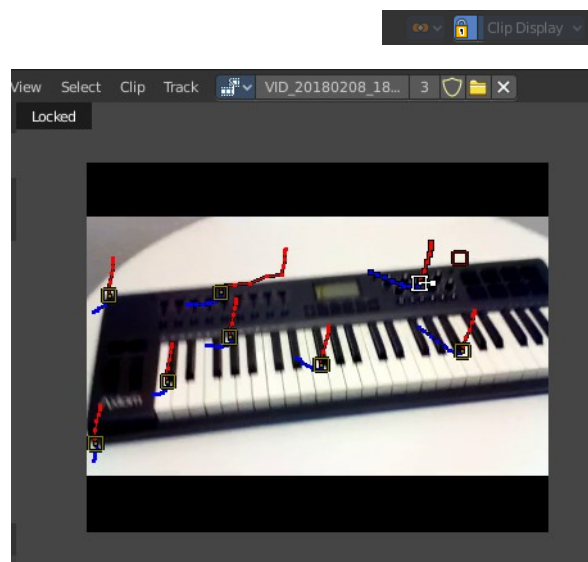

Mask Display

Available in Mask mode.

These are display options for mask overlays.

Mask Display

Spline

Display spline overlays.

Edge Display

Changes the spline overlay to outline, dash, black or white edges.

Overlay

Displays an overlay overlays.

Overlay Mode

Show combined color channels or alpha channel. When using combined, the Blending Factor slider can be changed.

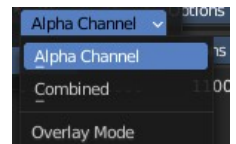
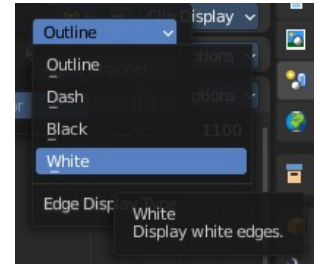

Clip Display

Available in Tracking in Clip mode and Mask mode.

Display options for the tracking footage.

Clip Display

R G B

Display the red green and blue channels of the footage

BW

Display the footage in black and white.

Mute Footage

Hide the footage.

Render Undistorted

Render Preview undistorted.

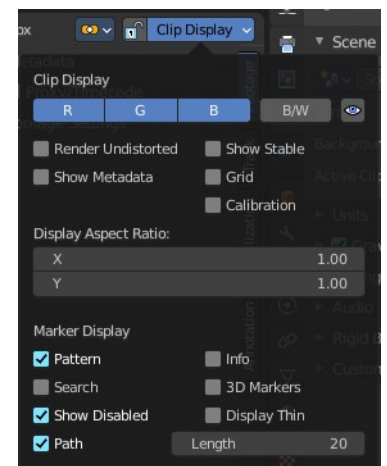

Show Metadata

Shows the metadata of the clip if available.

Show Stable

Show stable footage in editor. Stabilization needs to be enabled.

Grid

Displays a red grid over the footage that displays the lens distortion.

Calibration

Use manual calibration helpers.

Display Aspect Ratio X Y

The aspect ratio to display the footage.

Marker Display

Pattern

Displays the rectangles around the markers.

Search

Shows a search bound box around the currently selected marker.

Path

Shows the paths for the markers.

Length

How much of the path is displayed before and after the current position in the movie clip.

Show Disabled

Show also disabled markers.

Info

Displays an information string at the currently selected markers.

3D Markers

Displays a green dot at the center of the marker.

Display Thin

Displays the markers, marker widgets and marker lines with thin lines.

Mask Display

Available in Tracking in the Mask mode.

Mask Display

Spline

Show splines in as a mask overlay

Edge Display Type

A drop down that shows the different spline mask overlay types.

Outline

Display white edges with a black outline.

Dash

Display dashed black-white edges.

Black

Display black edges.

White

Display white edges.

Overlay

Show mask overlays.

Overlay Mode

A drop down that shows different mask overlay types.

Alpha Channel

Show the alpha channel of the mask.

Combined

Show the combined space background of the image in the mask

Blending Factor

When combined is activated, you can control the overlay blending factor of rasterized masks.

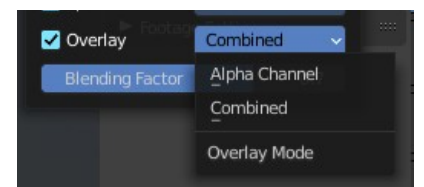
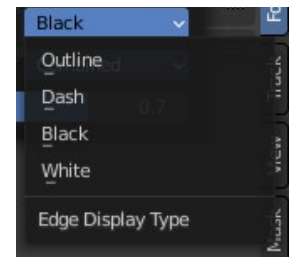
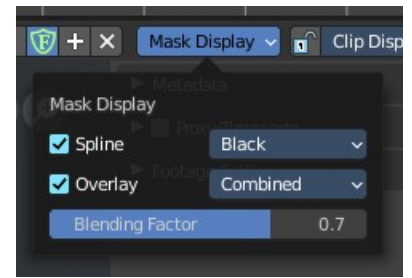

Marker Tools

Available in Tracking mode in Graph and Dope sheet mode.



Tools to refine and modify the markers.

Refine Markers Backwards

Refine selected markers position by running the tracker from tracks reference to current frame.

Clear Track Path Backwards

Clear tracks before the current position.

Track Markers Backwards

Track selected markers backwards.

Track Markers Sequence Backwards

Track selected marker sequence backwards.

Track Markers Sequence Forwards

Track selected marker sequence forwards.

Track Markers Forwards

Track selected markers forwards.

Clear Track Path Forwards

Clear tracks after the current position.

Refine Markers Forwards

Refine selected markers position by running the tracker from tracks reference to current frame.

Graph editor Options

Only selected



Only display channels relating to the current objects and data.

Display Hidden

Display also channels from objects/bones that are not visible.

Show Frames

Show curve for per frame average error. Camera motion should be solved first.

Show Track Motion

Display the speed curves for the selected tracks. Red is X direction. Green is Y direction.

Show Tracks Error

Display the reprojection error curve for the selected tracks.

Options panel

Show Seconds

Option. Display the timeline numbering in seconds instead of frames.

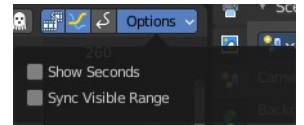
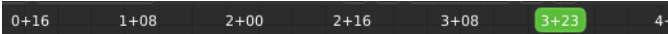

Sync Visible Range

Option. Synchronize the visible timeline range with other time based editors.

Dopesheet editor Options

Only selected

Only display channels relating to the current objects and data.

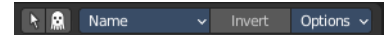

Display Hidden

Display also channels from objects/bones that are not visible.

Dope sheet Sort Field

Sort the list of the tracks by chosen method.

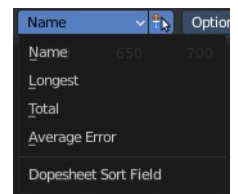

Invert

Invert the sort order of dope sheet channels.

Options panel

Show Seconds

Option. Display the timeline numbering in seconds instead of frames.

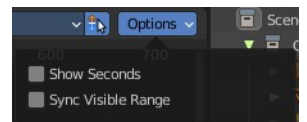

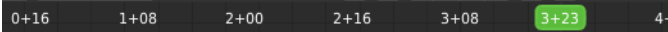

Sync Visible Range

Option. Synchronize the visible timeline range with other time based editors.

Proportional Editing

Proportional Editing

Enables proportional editing.

Proportional Editing is a way of transforming selected elements (such as vertices, or in this case the handlers for the mask spline curves) while having that transformation affect other nearby elements with a falloff. For example, moving a single vertex will move unselected vertices within a given range. And the falloff means that selected vertices that are closer to the selected vertex will move more than those farther from it.

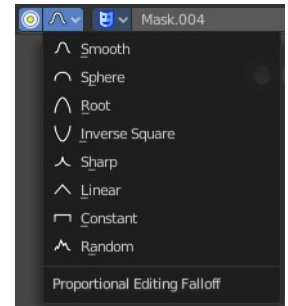

Settings

Choose between different falloff methods for the proportional editing. The settings are hidden when you have proportional editing off.

Mask Prop

Mask Prop



When you are in Mask mode then you can create a new mask, and work with this mask then.

Masks have many purposes. They can be used to mask out, or influence a particular object in the footage in Motion tracking. They can be used for manual rotoscoping to pull a particular object out of the footage. They can be used as a rough matte for green-screen keying.

Masks are independent from a particular image of movie clip, and so they can also be used for creating motion graphics or other effects in the compositor.

Masks can be driven over the time so that they follow some object from the footage. For example a running actor. This can be achieved with shape keys or parenting the mask to tracking markers.

List of Masks

This is a list of the masks in the scene. Allows you to switch to other masks.

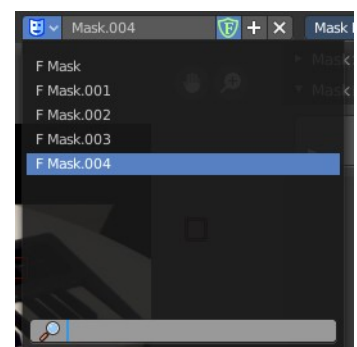

Mask Edit Box

The name of the currently selected mask. And you can rename the image mask too.

Fake User

With this button you assign a fake user to this selected mask. Masks get created with a fake user already. Means when you save the scene and reopen it, then this mask will still be there.

Data, like images, that is not longer linked to anything else gets removed when you save and reload a scene. Bforartists has the concept of fake users to go around this behavior. An image with a fake user is in fact linked to something. And so it is not lost when you save and reload the scene.

Search form

Search for specific masks.

Mask Display

Mask Display

In Mask mode and with a Render result. Adjust the display of the mask.



Smooth

Smoothens the outline of the mask curve.

Overlay

When it's a closed curve then this closed area gets displayed as filled where it covers the image. When you tick Overlay then a second drop down box becomes active.

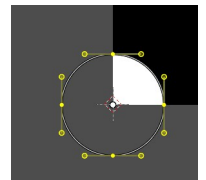
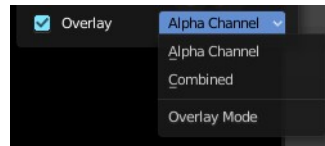

Edge Display Type

The mask curve can be displayed in different styles.

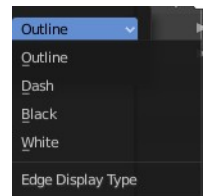

Gizmo

Show Gizmo

Show or hide all gizmos in the editor.

Viewport Gizmos

Navigate

Show or hide the Navigate Gizmo.

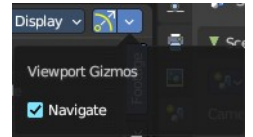



15.1.10 Editors - Movie Clip Editor - Header - Mask Mode - Mask Menu

Table of content

- Masking preface.....3
- S-Curves.....3
- Mask Menu.....4
 - Transform.....4
 - Move.....4
 - Last Operator Move.....4
 - Values.....4
 - Axis Ortho.....4
 - Orientation.....4
 - Proportional Editing.....4
 - Proportional Editing Falloff.....5
 - Proportional size.....5
 - Connected.....5
 - Projected (2D).....5
 - Rotate.....5
 - Last Operator Rotate.....5
 - Angle.....5
 - Axis.....5
 - Orientation.....5
 - Proportional Editing.....5
 - Proportional Editing Falloff.....5
 - Proportional size.....5
 - Connected.....6
 - Projected (2D).....6
- Scale.....6
 - Last Operator Resize.....6
 - Scale X Y Z.....6
 - Orientation.....6
 - Proportional Editing.....6
 - Proportional Editing Falloff.....6
 - Proportional size.....6
 - Connected.....6
 - Projected (2D).....6

- To Sphere.....7
- Usage.....7
- Last Operator To Sphere.....7
 - Factor.....7
 - Proportional editing.....7
 - Proportional Falloff.....7
 - Proportional Size.....7
 - Connected.....7
 - Projected(2D).....7
- Shear.....7
- Last Operator Shear.....7
 - Offset.....7

Shear Axis.....	7
Axis.....	8
Axis Ortho.....	8
Orientation.....	8
Proportional editing.....	8
Proportional Falloff.....	8
Proportional Size.....	8
Connected.....	8
Projected(2D).....	8
Push/Pull.....	8
Last Operator Push/Pull.....	8
Factor.....	8
Proportional editing.....	8
Proportional Falloff.....	9
Proportional Size.....	9
Connected.....	9
Projected(2D).....	9
Scale Feather.....	9
Last Operator Transform.....	9
Values.....	9
Axis.....	9
Orientation.....	9
Proportional Editing.....	9
Proportional Editing Falloff.....	10
Proportional size.....	10
Connected.....	10
Projected (2D).....	10
Clear Feather Weight.....	10
Duplicate.....	10
Delete.....	10
Copy Splines.....	10
Paste Splines.....	10
Make Parent.....	10
Clear Parent.....	10
Toggle Cyclic.....	10
Switch Direction.....	10
Recalc Normals.....	11
Set Handle Type.....	11
Animation.....	11
Insert Shape Key.....	11
Clear Shape Key.....	11
Reset Feather Animation.....	11
Re-key Shape points.....	11
Show / Hide.....	11
Show Hidden.....	11
Hide Selected.....	11
Hide Unselected.....	11
Last operator Hide Layer.....	11
Unselected.....	11

Masking preface

Masks have many purposes. They can be used in a motion tracking workflow to mask out, or influence a particular object in the footage. They can be used for manual rotoscoping to pull a particular object out of the footage. Or as a rough matte for green screen keying. This is done in the Node editor in compositing mode by a mask node.

Masks are independent from a particular image of movie clip. And so they can just as well be used for creating motion graphics or other effects in the compositor.

Masks are defined by splines. Means you work with splines, and you have a bunch of spline tools available.

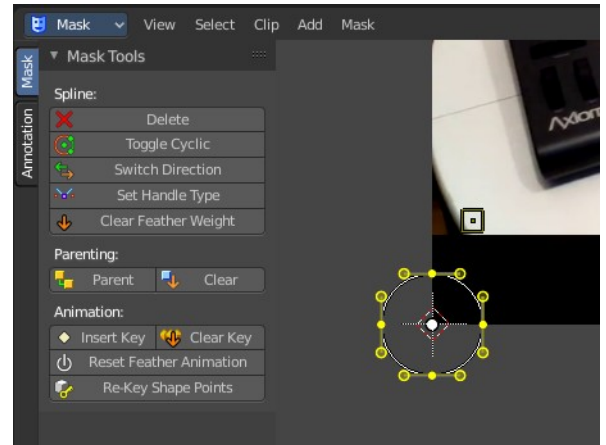

S-Curves

The curve type used for creating mask splines is almost a Bezier curve. But there are some differences. Smooth edges of the mask are defined by feathering. These are called S-Curves.

Besides the handles, every control point also has points that define the feather between the current point and the next point on the spline. Each feather point is stored in UV space, where U means position across spline segment, and V means distance between main spline and feather points.

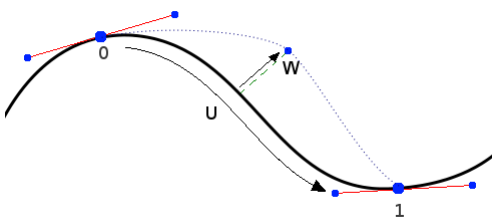

This allows for deforming the main spline in almost any way, and the feather will be updated automatically to reflect that change.

For example if there is just rotation of the spline, feather would stay completely unchanged. If one point's feather is moved, the other feathers will be automatically stretched uniformly along that segment and the overall shape will be almost the same as artists would want it to be.

Mask Menu

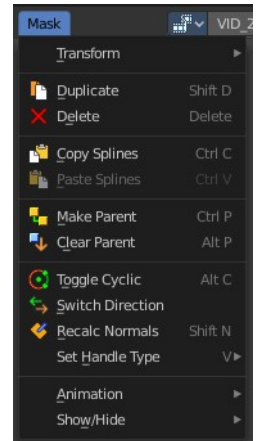

Transform

Move

Move the selected curve spline or points.

Last Operator Move

Values

Adjust the move amount.

X, Y and Z defines the position.

Axis Ortho

Along which axis to move.

Orientation

Orientation is a drop-down box where you can choose the type of orientation for the transform action.

Proportional Editing

Proportional Editing is a drop-down box where you can choose to use proportional editing. When you choose one of the active methods then the neighbor geometry gets influenced too in a proportional way.

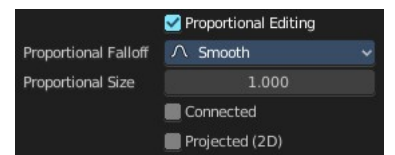
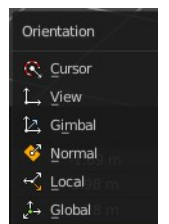
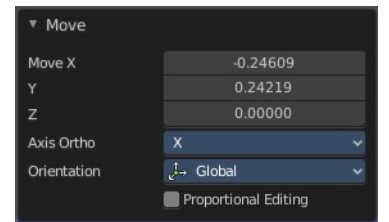
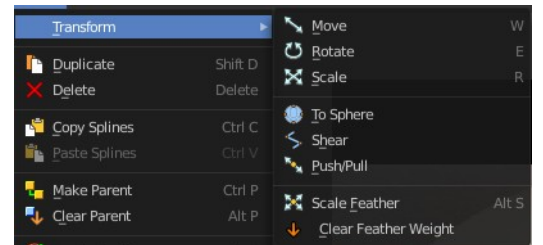

Proportional Editing Falloff

Proportional Editing Falloff is a drop-down box where you can choose a method for the falloff for the proportional editing.

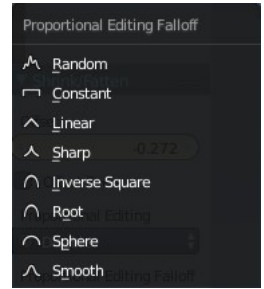

Proportional size

Proportional size is an edit box to Adjust the strength of the Proportional falloff.

Connected

Just edit geometry that is directly connected with the current selection. 4 Bforartists 2 Reference Manual - 7.1.4 Editors - 3D View - Header - Navigation Menu

Projected (2D)

Edit geometry that is in 2d space aligned with the current selection. This one goes from the current view in depth direction.

Rotate

Rotate the selected curve spline or points.

Last Operator Rotate

Angle

Adjust the angle.

Axis

Along which axis to rotate

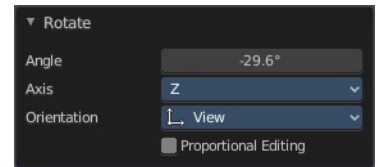

Orientation

Orientation is a drop-down box where you can choose the type of orientation for the transform action.

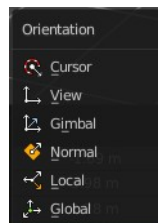

Proportional Editing

Proportional Editing is a drop-down box where you can choose to use proportional editing. When you choose one of the active methods then the neighbor geometry gets influenced too in a proportional way.

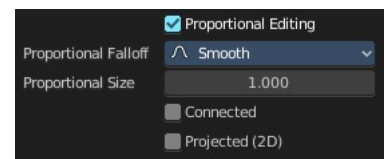

Proportional Editing Falloff

Proportional Editing Falloff is a drop-down box where you can choose a method for the falloff for the proportional editing.

Proportional size

Proportional size is an edit box to adjust the strength of the Proportional falloff.

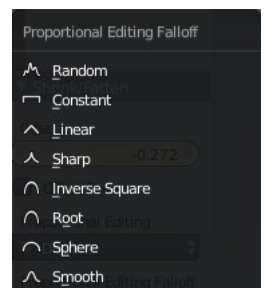

Connected

Just edit geometry that is directly connected with the current selection. 4 Bforartists 2 Reference Manual - 7.1.4 Editors - 3D View - Header - Navigation Menu

Projected (2D)

Edit geometry that is in 2d space aligned with the current selection. This one goes from the current view in depth direction.

Scale

Scale the selected curve spline or points.

Last Operator Resize

Scale X Y Z

Adjust the scaling.

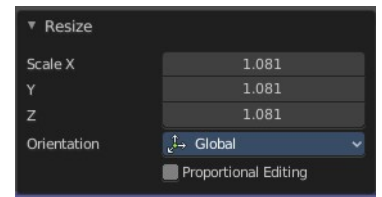

Orientation

Orientation is a drop-down box where you can choose the type of orientation for the transform action.

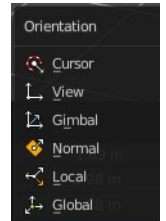

Proportional Editing

Proportional Editing is a drop-down box where you can choose to use proportional editing. When you choose one of the active methods then the neighbor geometry gets influenced too in a proportional way.

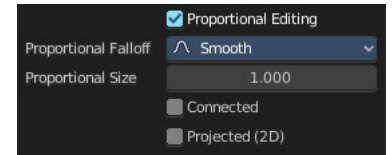

Proportional Editing Falloff

Proportional Editing Falloff is a drop-down box where you can choose a method for the falloff for the proportional editing.

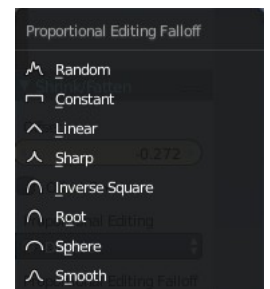

Proportional size

Proportional size is an edit box to adjust the strength of the Proportional falloff.

Connected

Just edit geometry that is directly connected with the current selection. 4 Bforartists 2 Reference Manual - 7.1.4 Editors - 3D View - Header - Navigation Menu

Projected (2D)

Edit geometry that is in 2d space aligned with the current selection. This one goes from the current view in depth direction.

To Sphere

Shapes a selection of objects into the shape of a sphere. The calculation happens with the object origins.

In Object mode this tool requires to have more than one object selected.

Usage

Select the objects, activate the tool, then drag the mouse in the 3D viewport. In the header you will read the current factor then. Which tells you how close you are towards the sphere shape.

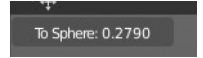

Last Operator To Sphere

Factor

The factor to transform the selection into a shape form.

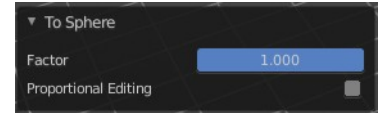

Proportional editing

Enables proportional editing. Activating proportional editing reveals further settings.

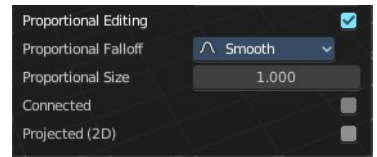

Proportional Falloff

Adjust the falloff methods.

Proportional Size

See and adjust the falloff radius.

Connected

The proportional falloff gets calculated for connected parts only.

Projected(2D)

The proportional falloff gets calculated in the screen space. Depth doesn't play a role. When it's in the radius, then it gets calculated.

Shear

Shear shears the selection.

In Object mode this tool requires to have more than one object selected.

Last Operator Shear

Offset

Adjust an offset.

Shear Axis

The shear tool works along a imaginary 2d plane. The shear axis controls if the items are sheared along the x or the y axes of this plane. This is the plane along which the transformation happens. You can shear along the x or the y axis of this plane.

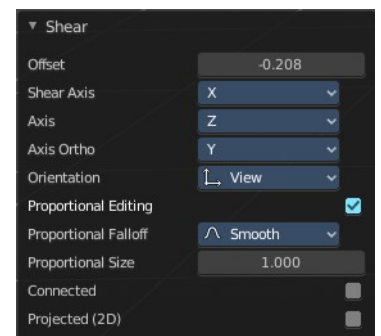

To make things even more complicated, the orientation of this imaginary plane is defined by the Axis and Axis Ortho items below.

Axis

Defines one axis of the imaginary shear axis plane.

Axis Ortho

Defines the other axis of the imaginary shear axis plane.

Orientation

Choose the orientation for the shear action.

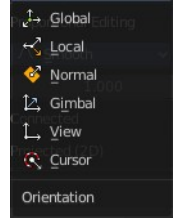

Proportional editing

Enables proportional editing. Activating proportional editing reveals further settings.

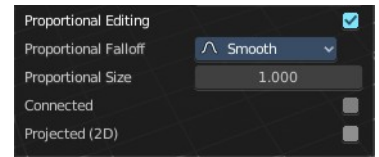

Proportional Falloff

Adjust the falloff methods.

Proportional Size

See and adjust the falloff radius.

Connected

The proportional falloff gets calculated for connected parts only.

Projected(2D)

The proportional falloff gets calculated in the screen space. Depth doesn't play a role. When it's in the radius, then it gets calculated.

Push/Pull

It pushes or pulls the object positions relative to the center of the selection.

In Object mode this tool requires to have more than one object selected.

Last Operator Push/Pull

Factor

Adjust the strength of influence of the tool.

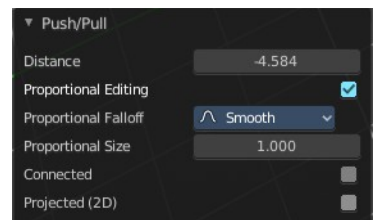

Proportional editing

Enables proportional editing. Activating proportional editing reveals further settings.

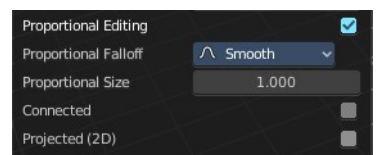

Proportional Falloff

Adjust the falloff methods.

Proportional Size

See and adjust the falloff radius.

Connected

The proportional falloff gets calculated for connected parts only.

Projected(2D)

The proportional falloff gets calculated in the screen space. Depth doesn't play a role. When it's in the radius, then it gets calculated.

Scale Feather

Scale feather weight for the selected points.

The curve type that is used to create mask splines is almost a Bezier curve. But it has some differences. Smooth edges of the mask are defined by feathering. The curve needed to support feathering in a way that stuck to the curve as you edited it, for ease of editing an animation. These are called S-Curves.

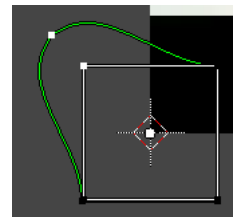

Besides the handles, every control point also has points that define the feather between the current point and the next point on the spline. Each feather point is stored in UV space, where U means position across spline segment, and V means distance between main spline and feather points.

Last Operator Transform

Values

Adjust the scale amount.

X, Y and Z defines the position. W defines the rotation.

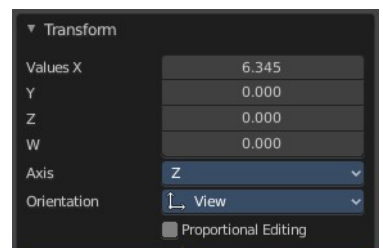

Axis

Around which axis to rotate. X, Y or Z.

Orientation

Orientation is a drop-down box where you can choose the type of orientation for the transform action.

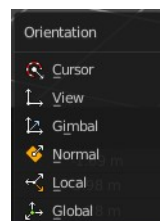

Proportional Editing

Proportional Editing is a drop-down box where you can choose to use proportional editing. When you choose one of the active methods then the neighbor geometry gets influenced too in a proportional way.

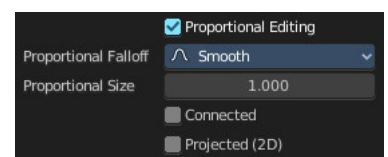

Proportional Editing Falloff

Proportional Editing Falloff is a drop-down box where you can choose a method for the falloff for the proportional editing.

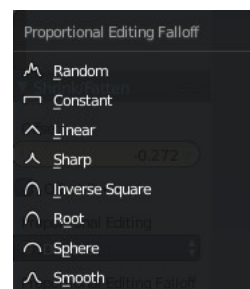

Proportional size

Proportional size is an edit box to adjust the strength of the Proportional falloff.

Connected

Just edit geometry that is directly connected with the current selection. 4 Bforartists 2 Reference Manual - 7.1.4 Editors - 3D View - Header - Navigation Menu

Projected (2D)

Edit geometry that is in 2d space aligned with the current selection. This one goes from the current view in depth direction.

Clear Feather Weight

Reset the feather weight to zero.

Duplicate

Duplicates the selected curve and moves it.

Delete

Deletes the selected mask curve point.

Copy Splines

Copies the currently selected spline.

Paste Splines

Pastes a copied spline.

Make Parent

Set the mask's parenting.

Clear Parent

Clears the mask's parenting.

Toggle Cyclic

Make the spline closed or open.

Switch Direction

Switch the direction in which the spline points. A spline has a direction. A starting point and an endpoint. By switching the starting point becomes the end point, the end point becomes the starting point.

Recalc Normals

Recalculate the direction of the selected spline handlers.

Set Handle Type

In this sub menu you can set the handle type for the currently selected spline points.

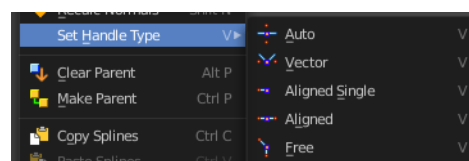

Animation

Insert Shape Key

Inserts a shape key keyframe.

The inserted keyframes can then be found in the dope sheet editor in mask mode.

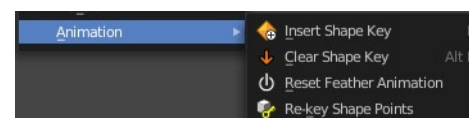

Clear Shape Key

Clears an existing shape key keyframe.

Reset Feather Animation

Resets the feather offset across all animated frames.

Re-key Shape points

Recalculate animation data on selected points for frames selected in the dope sheet.

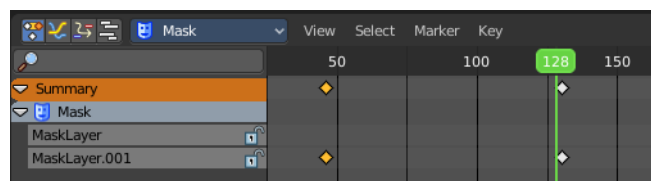

Show / Hide

Show Hidden

Reveals all hidden curves

Hide Selected

Hides the selected curve.

Hide Unselected

Hides the unselected curves.



Last operator Hide Layer

Unselected

Hide selected or unselected curves.

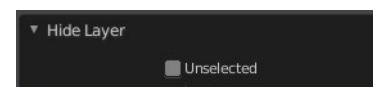



15.1.2 Editors - Movie Clip Editor - Header - Quick Menu

Table of content

- Quick Menu.....1
- Adding an operator to the Quick menu.....1
- Adding a menu to the Quick menu.....1
- Order.....2
- Removing an operator from the Quick menu.....2
- Context and mode dependent content.....2

Quick Menu

The quick menu, or in long Quick Favorites menu, is a menu that can be customized to your needs. Here you can add operators for quick access.

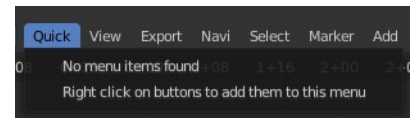

It is located in the header. But it can be called by hotkey Q directly under the mouse. This hotkey works in other editors too.

When the menu is empty, then you will see the message "No Menu Items found". This means that you first have to add some tools to the menu. It is a user configurable menu.

Note that added operators in this menu does not have icons. Just text.

Adding an operator to the Quick menu

Open the panel or the menu where your operator is that you want to add.

Let's add the open command from the File menu. Open the File menu, right click at open, and choose Add to Quick Favorites.

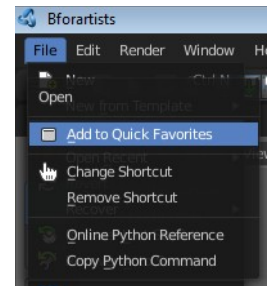

Do the same with Save As. We should now have two new menu items in the Quick menu, which you can use now.

As a rule of thumb, when the right click menu has an Add to Quick Favorites, then you can add it to the quick menu.

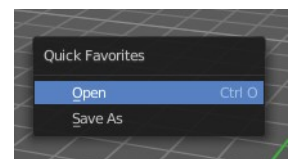

Note that you can also add operators from the tool shelf at the left. And also operators from other editor types. Some other editors have their own quick menu though. The Image Editor for example. These operators gets added in the quick menu of the image editor then. And does not show in the quick menu in the header of the 3D view.

Adding a menu to the Quick menu

It is also possible to add a menu to the Quick menu. For example the whole Add menu. The way is the same. Right click at it, and choose Add to Quick Favorites.

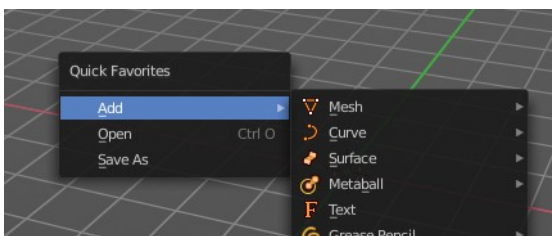
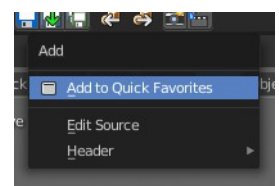

Order

You might notice that the add menu adds at the top of the menu, and not at the bottom as you would expect. First comes menus, then comes operators. And they get added in the order in which you add them.

Besides that, operators and menus gets added in the order that you add them. They cannot be sorted afterwards. So be careful how you add them. You can of course always remove operators and menus, and re-add them at the end of the list.

Removing an operator from the Quick menu

Removing is as simple as adding. Right click at the operators in the Quick menu, and choose Remove from Quick favorites.

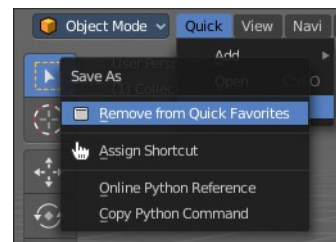

Context and mode dependent content

The quick favorites. menu exists in nearly all editors. But it is just in the 3D view available in the header. So that you know this functionality exists. In the other editors you call it with hotkey Q.

The content of the quick favorites. menu changes, dependent over which editor you are, and in what mode you are. When you add for example an operator from the image editor, then this operator just shows in the quick menu when you call the menu from the image editor. Same goes for the modes. Edit mode tools will just show in edit mode. And so on.



15.1.3 Editors - Movie Clip Editor - Header - View Menu

Table of content

Movie Clip Editor Modes.....	2
View Menu in Tracking mode in Clip sub mode.....	2
Toolbar.....	3
Sidebar.....	3
Adjust Last Operation.....	3
Frame Selected.....	3
View All.....	3
View Fit.....	3
Center View to Cursor.....	3
Annotations (Legacy).....	3
Draw Annotation.....	4
Draw Line Annotation.....	4
Draw Polyline Annotation.....	4
Erase Annotation.....	4
Add Annotation Layer.....	4
Erase Annotation Active Keyframe.....	4
Zoom In.....	4
Zoom Out.....	4
Fractional Zoom.....	4
Pie menus.....	4
Area.....	5
Horizontal Split.....	5
Vertical Split.....	5
Duplicate Area into New Window.....	5
Toggle Maximize Area.....	5
Toggle Full screen Area.....	5
Close Area.....	5
View Menu in in Tracking mode in Graph sub mode.....	5
Frame Selected.....	5
Frame All.....	6
Zoom In + Zoom Out.....	6
Pie menus.....	6
Area.....	6
Horizontal Split.....	6
Vertical Split.....	6
Duplicate Area into New Window.....	6
Toggle Maximize Area.....	6
Toggle Full screen Area.....	6
Close Area.....	7
View Menu in in Tracking mode in Dopesheet sub mode.....	7
Frame All.....	7
Zoom In + Zoom Out.....	7
Pie menus.....	7
Area.....	7
Horizontal Split.....	7
Vertical Split.....	7

- Duplicate Area into New Window.....7
- Toggle Maximize Area.....8
- Toggle Full screen Area.....8
- Close Area.....8
- View Menu in Mask mode.....8
 - Toolbar.....8
 - Sidebar.....8
 - Adjust Last Operation.....8
 - Set 2D Cursor.....9
 - Frame Selected.....9
 - View All.....9
 - View Fit.....9
 - Center View to Cursor.....9
 - Zoom In.....9
 - Zoom Out.....9
 - Fractional Zoom.....9
 - Pie menus.....9
 - Area.....10
 - Horizontal Split.....10
 - Vertical Split.....10
 - Duplicate Area into New Window.....10
 - Toggle Maximize Area.....10
 - Toggle Full screen Area.....10
 - Close Area.....10

Movie Clip Editor Modes

The Movie Clip Editor is three editors in one. And the Clip editor in mask mode looks also different. So we need to explain the content for all three editor types plus the Mask mode.

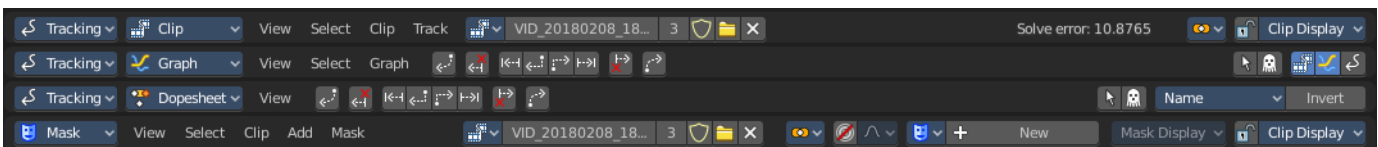

View Menu in Tracking mode in Clip sub mode

The View menu contains all View related tools.

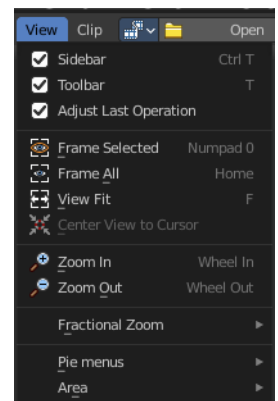

Toolbar

Shows or hides the toolbar at the left.

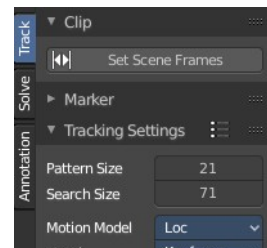

Sidebar

Shows or hides the sidebar at the right in the viewport.

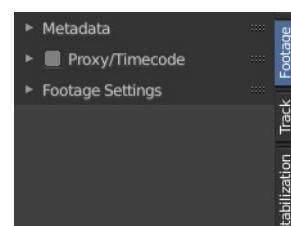

Adjust Last Operation

Shows the adjust last operation panel down left.

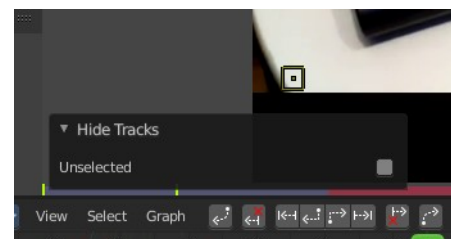

Frame Selected

Zooms to the selection.

View All

View all zooms in or out in the viewport until all selected objects are displayed fitting in the viewport.

View Fit

View all zooms in or out in the viewport to fit the current selection into the viewport.

Center View to Cursor

Center Cursor centers the view to the 2D cursor.

Annotations (Legacy)

This group of operators is useful to take notes without changing tool-shelf operators. These notes can be colored in the View tab of the Property Shelf. Each layer is a single color. You can also animate the notes with keyframes, editable in the dopesheet.

Note: *These are legacy operators, meaning they are equally available in the Toolshelf as a modal operator.*

Draw Annotation

Starts the annotation free hand draw tool in the editor.

Draw Line Annotation

Starts the annotation line draw tool to draw straight lines in the editor.

Draw Polyline Annotation

Starts the annotation Polyline draw tool in the editor which allows to draw multiple connected straight lines in the editor.

Erase Annotation

Starts the annotation erase tool in the editor which erases any strokes in the editor.

Add Annotation Layer

Starts a new annotation layer.

Erase Annotation Active Keyframe

Erases the active keyframe of the annotation.

Zoom In

Zooms into the view.

Zoom Out

Zooms out of the view.

Fractional Zoom

A set of predefined zoom factors.

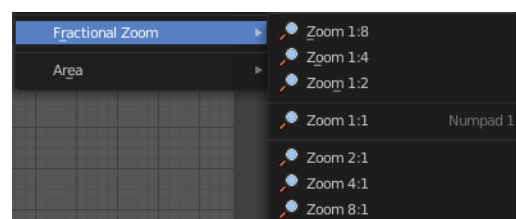

Pie menus

Lists the available pie menus, and gives you the ability to read the hotkeys and assign own hotkeys.

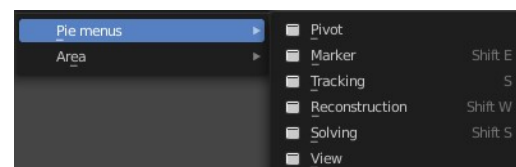

Area

This menu contains general view functionality. And exists in most other editor types too.

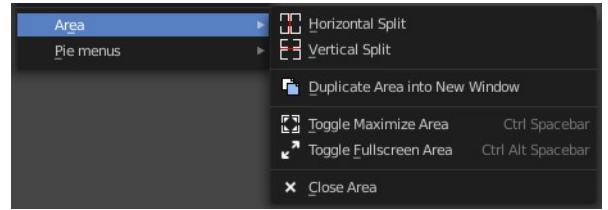

Horizontal Split

Splits the current view horizontally into two independent editor windows.

Vertical Split

Splits the current view vertically into two independent editor windows.

Duplicate Area into New Window

Duplicate Area into New Window makes the selected editor window floating. You can then drag it around at the monitor. It is not connected with the rest of the UI anymore.

A separated window cannot be merged into the main window again. You have to close it when not longer needed.

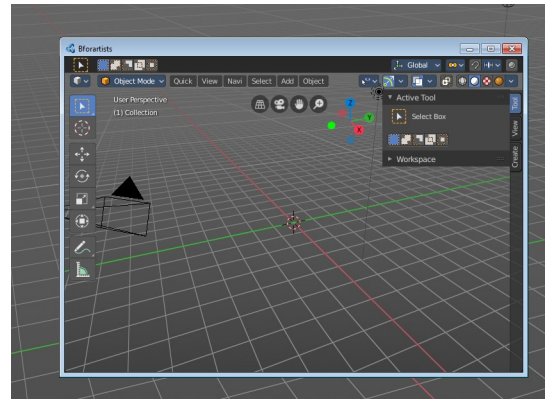

Toggle Maximize Area

Displays the editor maximized with menus.

To return from the maximized view press hotkey ctrl + spacebar. Or reuse the menu item in the area menu.

Toggle Full screen Area

Displays the editor maximized without menus.

To return from the full screen view press hotkey ctrl + alt + spacebar.

Close Area

Close the area window.

View Menu in in Tracking mode in Graph sub mode

The View menu contains all View related tools.

Frame Selected

Centers the view at the current frame(s).

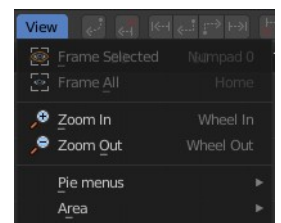

Frame All

Views all content, zoomed in to fit into the viewport.

Zoom In + Zoom Out

Zoom in and out in the viewport.

Pie menus

Lists the available pie menus, and gives you the ability to read the hotkeys and assign own hotkeys.

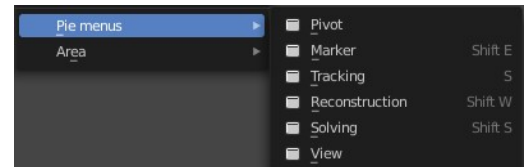

Area

This menu contains general view functionality. And exists in most other editor types too.

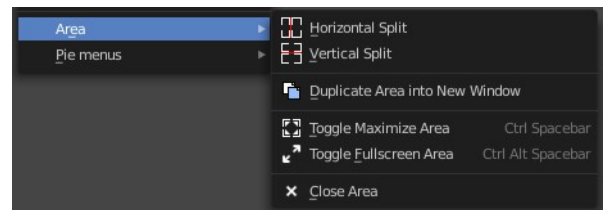

Horizontal Split

Splits the current view horizontally into two independent editor windows.

Vertical Split

Splits the current view vertically into two independent editor windows.

Duplicate Area into New Window

Duplicate Area into New Window makes the selected editor window floating. You can then drag it around at the monitor. It is not connected with the rest of the UI anymore.

A separated window cannot be merged into the main window again. You have to close it when not longer needed.

Toggle Maximize Area

Displays the editor maximized with menus.

To return from the maximized view press hotkey ctrl + spacebar. Or reuse the menu item in the area menu.

Toggle Full screen Area

Displays the editor maximized without menus.

To return from the full screen view press hotkey ctrl + alt + spacebar.

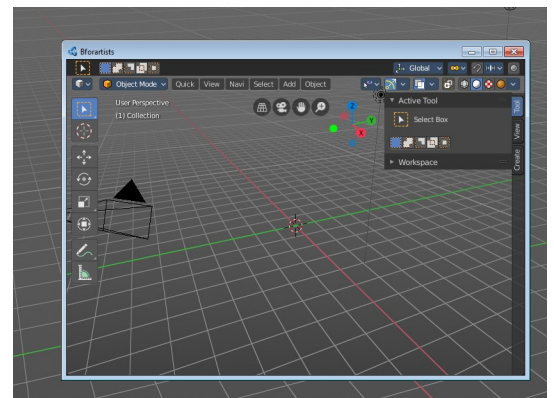

Close Area

Close the area window.

View Menu in Tracking mode in Dopesheet sub mode

The View menu contains all View related tools.

Frame All

Show all content, zoomed to fit into the viewport.

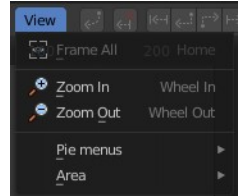

Zoom In + Zoom Out

Zooms in and out in the viewport.

Pie menus

Lists the available pie menus, and gives you the ability to read the hotkeys and assign own hotkeys.

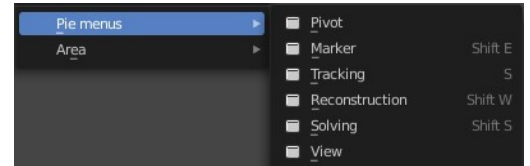

Area

This menu contains general view functionality. And exists in most other editor types too.

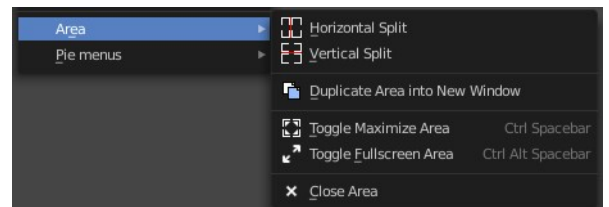

Horizontal Split

Splits the current view horizontally into two independent editor windows.

Vertical Split

Splits the current view vertically into two independent editor windows.

Duplicate Area into New Window

Duplicate Area into New Window makes the selected editor window floating. You can then drag it around at the monitor. It is not connected with the rest of the UI anymore.

A separated window cannot be merged into the main window again. You have to close it when not longer needed.

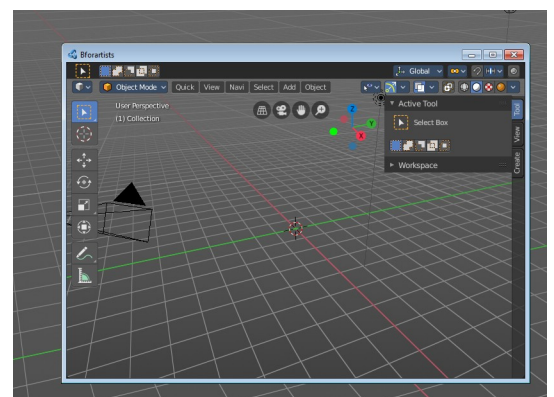

Toggle Maximize Area

Displays the editor maximized with menus.

To return from the maximized view press hotkey ctrl + spacebar. Or reuse the menu item in the area menu.

Toggle Full screen Area

Displays the editor maximized without menus.

To return from the full screen view press hotkey ctrl + alt + spacebar.

Close Area

Close the area window.

View Menu in Mask mode

The View menu contains all View related tools.

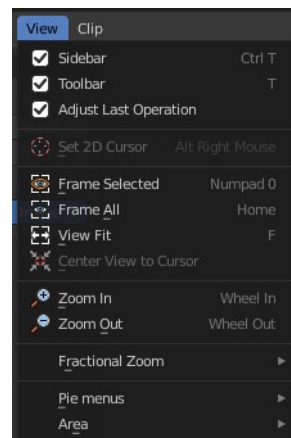

Toolbar

Shows or hides the toolbar at the left.

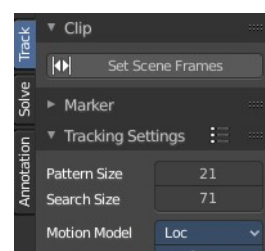

Sidebar

Shows or hides the sidebar at the right in the viewport.

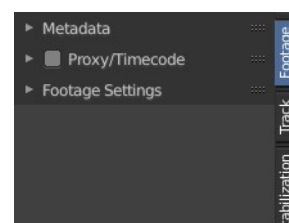

Adjust Last Operation

Shows the adjust last operation panel down left.

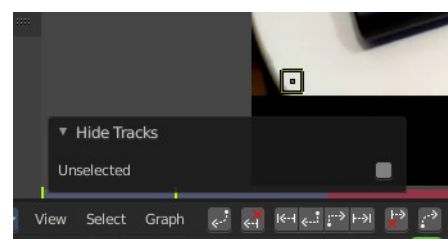

Set 2D Cursor

The 2D cursor is the center for mask creation and modification. Hotkey only tool! Please use the hotkey!

Frame Selected

Zooms to the selection.

View All

View all zooms in or out in the viewport until all selected objects are displayed fitting in the viewport.

View Fit

View all zooms in or out in the viewport to fit the current selection into the viewport.

Center View to Cursor

Center Cursor centers the view to the 2D cursor.

Zoom In

Zooms into the view.

Zoom Out

Zooms out of the view.

Fractional Zoom

A set of predefined zoom factors.

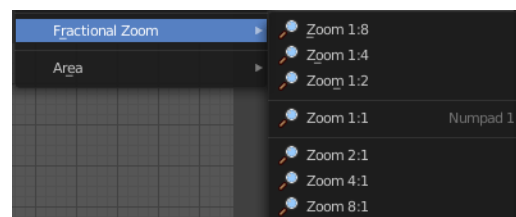

Pie menus

Lists the available pie menus, and gives you the ability to read the hotkeys and assign own hotkeys.

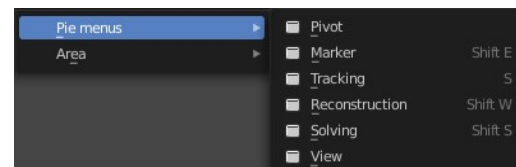

Area

This menu contains general view functionality. And exists in most other editor types too.

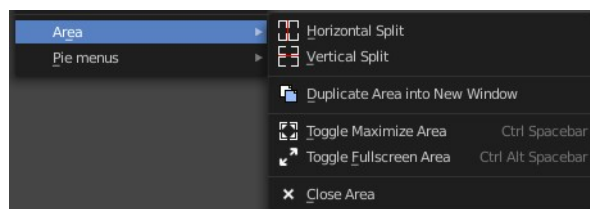

Horizontal Split

Splits the current view horizontally into two independent editor windows.

Vertical Split

Splits the current view vertically into two independent editor windows.

Duplicate Area into New Window

Duplicate Area into New Window makes the selected editor window floating. You can then drag it around at the monitor. It is not connected with the rest of the UI anymore.

A separated window cannot be merged into the main window again. You have to close it when not longer needed.

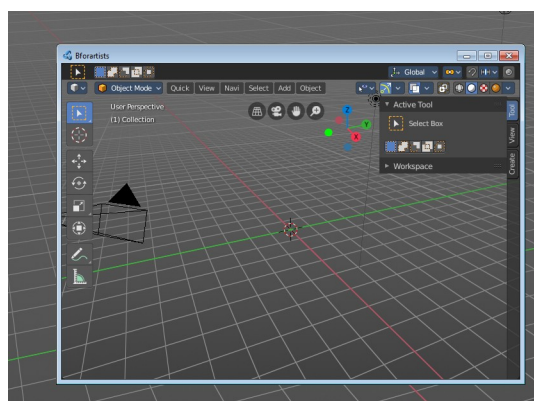

Toggle Maximize Area

Displays the editor maximized with menus.

To return from the maximized view press hotkey ctrl + spacebar. Or reuse the menu item in the area menu.

Toggle Full screen Area

Displays the editor maximized without menus.

To return from the full screen view press hotkey ctrl + alt + spacebar.

Close Area

Close the area window.



15.1.4 Editors - Movie Clip Editor - Header - Select Menu

Table of content

Movie Clip Editor Modes.....	2
Select Menu in Tracking mode in Clip sub mode.....	2
All.....	2
None.....	2
Inverse.....	2
Box Select.....	2
Circle Select.....	2
Lasso Select.....	2
Grouped.....	2
Select Stabilization tracks.....	3
Select Stabilization Rotation tracks.....	3
Select Menu in Tracking mode in Graph sub mode.....	3
All.....	3
None.....	3
Inverse.....	3
Box Select.....	3
Select Menu in Mask mode.....	3
All.....	3
None.....	3
Inverse.....	3
Box Select.....	3
Circle Select.....	4
Lasso Select.....	4
Linked.....	4
More.....	4
Less.....	4

Movie Clip Editor Modes

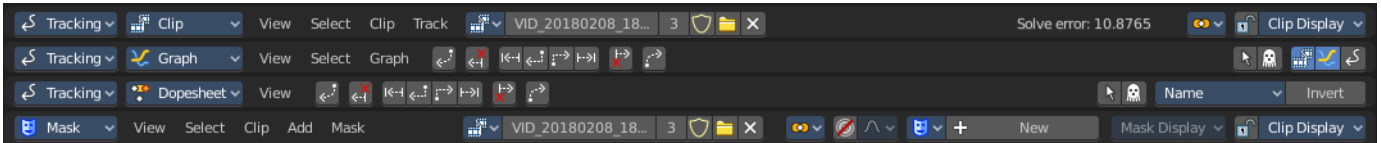

The Movie Clip Editor is three editors in one. And the Clip editor in mask mode looks also different. So we need to explain the content for all editor types plus the Mask mode that has a Select menu.

The Dope sheet mode has no Select menu.

Select Menu in Tracking mode in Clip sub mode

All

Select everything.

None

Select nothing.

Inverse

Invert the current selection.

Box Select

Draw a rectangle to box select markers.

It adds to selection by default. To subtract from selection hold down Shift key.

Circle Select

Circle select enters the Circle Select mode. This is a special select mode where you can select elements by moving with the mouse over it. It adds to selection by default.

To subtract from selection hold down Shift key. To exit the Circle select click with the right mouse button.

The pencil radius of the circle select tool can be adjusted with the scroll wheel.

Lasso Select

A sub menu with the available lasso select modes.

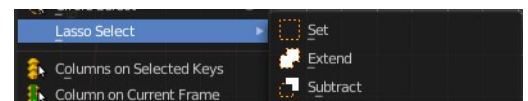

Grouped

Here you can select objects that are in the same group by the chosen method. The items should be self explaining.

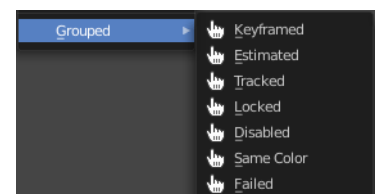

Select Stabilization tracks

Select the tracks that are used for translation stabilization.

Select Stabilization Rotation tracks

Select the tracks that are used for rotation stabilization.

Select Menu in Tracking mode in Graph sub mode

All

Select everything.

None

Select nothing.

Inverse

Invert the current selection.

Box Select

Draw a rectangle to box select markers.

It adds to selection by default. To subtract from selection hold down Shift key.

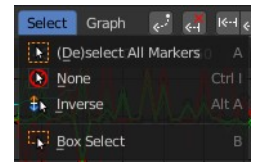

Select Menu in Mask mode

Note that you need to have a mask so that the content becomes active.

All

Select everything.

None

Select nothing.

Inverse

Invert the current selection.

Box Select

Draw a rectangle to box select markers.

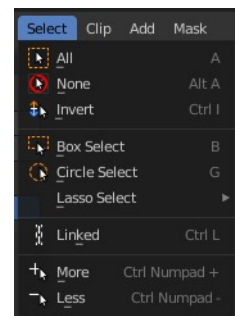

It adds to selection by default. To subtract from selection hold down Shift key.

Circle Select

Circle select enters the Circle Select mode. This is a special select mode where you can select elements by moving with the mouse over it. It adds to selection by default.

To subtract from selection hold down Shift key. To exit the Circle select click with the right mouse button.

The pencil radius of the circle select tool can be adjusted with the scroll wheel.

Lasso Select

A sub menu with the available lasso select modes.

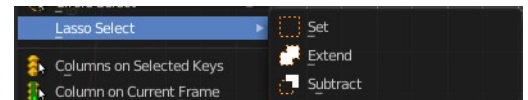

Linked

Select all curve points that are linked to the already selected points.

More

Increase the selection by one point.

Less

Decrease the selection by one point.

15.1.5 Editors - Movie Clip Editor - Header - Tracking Mode - Clip Submode - Clip Menu

Table of content

Clip Menu.....	1
Open Clip.....	1
Set Scene Frames.....	1
Prefetch Frames.....	1
Reload Clip.....	1
Set as Background.....	1
Setup Tracking Scene.....	1

Clip Menu

Open Clip

Opens an Image Sequence or a movie clip.

Set Scene Frames

Set the start and end frame of the frames to match the start and end frame of the clips.



Prefetch Frames

Prefetch frames from disk for faster playback and/or tracking.

Reload Clip

Reloads the movie clip.

Set as Background

Set the current movie clip as the camera background in the 3d view.

Setup Tracking Scene

Prepare the scene fro compositing 3d objects into this footage.

15.1.6 Editors - Movie Clip Editor - Header - Tracking Mode - Clip Submode - Track Menu

Table of content

Track Menu.....	3
Transform.....	3
Move.....	3
Last Operator Move Last.....	3
Move X Y Z.....	3
Axis Ortho.....	3
Orientation.....	3
Proportional editing.....	4
Proportional Falloff.....	4
Proportional Size.....	4
Connected.....	4
Projected(2D).....	4
Resize.....	4
Last Operator Resize Last.....	4
Resize X Y Z.....	4
Orientation.....	4
Proportional editing.....	4
Proportional Falloff.....	4
Proportional Size.....	4
Connected.....	5
Projected(2D).....	5
Reconstruction.....	5
Track Motion.....	5
Backwards.....	5
Frame Backwards.....	5
Forwards.....	5
Frame Forwards.....	5
Clear.....	5
Before.....	5
After.....	5
Track Path.....	5
Solution.....	6
Refine.....	6
Backwards.....	6
Backwards.....	6
Add Marker.....	6
Detect Features.....	6
Last Operator Detect Features.....	6
Placement.....	6
Whole frame.....	6
Inside Grease Pencil.....	6
Outside Grease Pencil.....	7
Margin.....	7
Threshold.....	7
Distance.....	7

Create Plane Track.....	7
Solve Camera Motion.....	7
Join Tracks.....	7
Copy.....	7
Paste.....	7
Copy Settings to Defaults.....	7
Apply default settings.....	8
Animation.....	8
Insert Keyframe.....	8
Delete Keyframe.....	8
Show/Hide.....	8
Show Hidden.....	8
Hide Selected.....	8
Hide Unselected.....	8
Last operator Hide Tracks.....	8
Unselected.....	8
Clean up.....	8
Clean Tracks.....	8
Filter Tracks.....	8
Delete Track.....	9
Delete Marker.....	9
Reconstruction.....	9
Set Origin.....	9
Last Operator Set Origin.....	9
Use Median.....	9
Set Floor.....	9
Set Wall.....	9
Last Operator Set Plane.....	9
Plane.....	9
Set X Axis.....	9
Set Y Axis.....	10
Last Operator Set Axis.....	10
Axis.....	10
Set Scale.....	10
Last Operator Set Scale.....	10
Distance.....	10
Apply Scale.....	10
Last operator Apply Solution Scale.....	10
Distance.....	10
3D Markers to Mesh.....	10
Link Empty to Track.....	10

Track Menu

Contains tracking functionality. Note that lots of this content is currently a double entry to the content in the tool shelf. The tool shelf content will most probably vanish in the future, in favour of a tool shelf with buttons like in the 3d view.

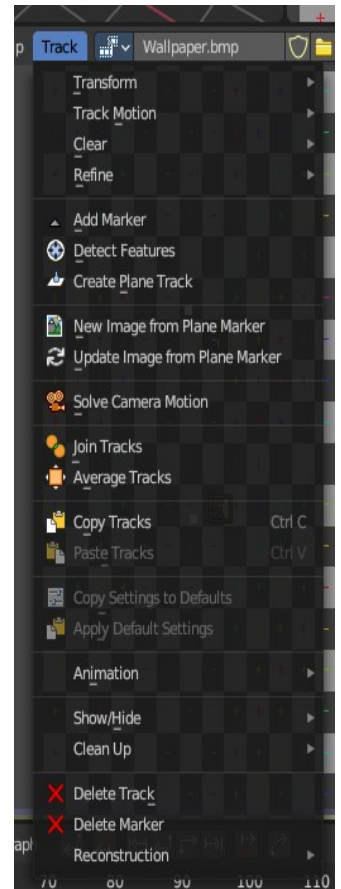

Transform

Track navigation.

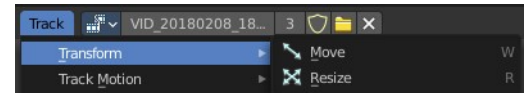

Move

Move the selected track(s).

Last Operator Move Last

Move X Y Z

The transform values. Set x and y position of the track. Z value has no influence.

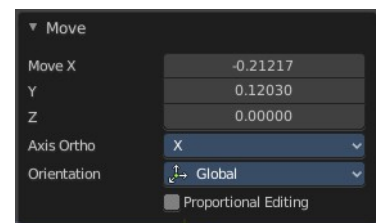

Axis Ortho

Defines the other axis of an imaginary shear axis plane.

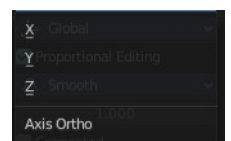

Orientation

Choose the orientation for the shear action.

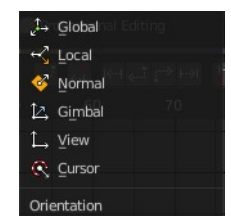

Proportional editing

Enables proportional editing. Activating proportional editing reveals further settings.

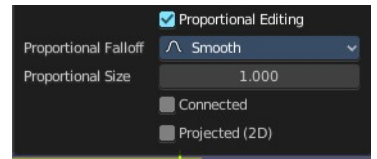

Proportional Falloff

Adjust the falloff methods.

Proportional Size

See and adjust the falloff radius.

Connected

The proportional falloff gets calculated for connected parts only.

Projected(2D)

The proportional falloff gets calculated in the screen space. Depth doesn't play a role. When it's in the radius, then it gets calculated.

Resize

Resize the selected track(s).

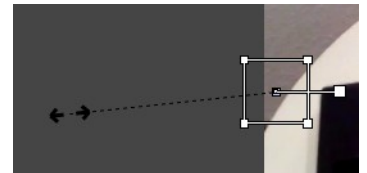

Last Operator Resize Last

Resize X Y Z

The transform values. Set x and y position of the track. Z value has no influence.

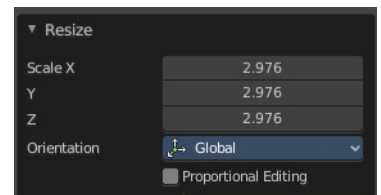

Orientation

Choose the orientation for the shear action.

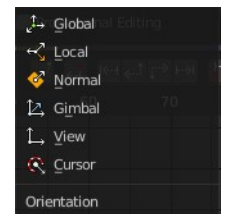

Proportional editing

Enables proportional editing. Activating proportional editing reveals further settings.

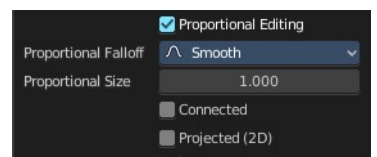

Proportional Falloff

Adjust the falloff methods.

Proportional Size

See and adjust the falloff radius.

Connected

The proportional falloff gets calculated for connected parts only.

Projected(2D)

The proportional falloff gets calculated in the screen space. Depth doesn't play a role. When it's in the radius, then it gets calculated.

Reconstruction

This menu once contained nothing but double menu entries that can be found in the panels. It is part of the Blender menu structure. And a add-on may add an entry here. So it remains for compatibility reasons.

Track Motion

Backwards

Track backwards the whole range.

Frame Backwards

Track backwards frame wise.

Forwards

Track forwards the whole range.

Frame Forwards

Track forwards frame wise.

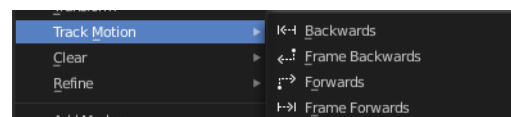

Clear

Before

Clears track paths before the current position.

After

Clears track paths after the current position.

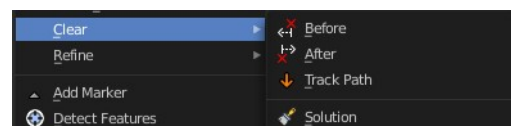

Track Path

Clears the currently active Track Path.

Solution

Clears all calculated data.

Refine

Backwards

Refine selectet marker positions forwards.

Backwards

Refine selectet marker positions forwards.

Add Marker

Add a marker. The marker will appear under the mouse, and stick until you click.

Detect Features

Adds automatically markers at the current movie position, and tries to detect marcant areas in the current frame that are useful for tracking. It also sets keyframes at this position.

When enough marcant areas are available then it adds up to eight markers that way.

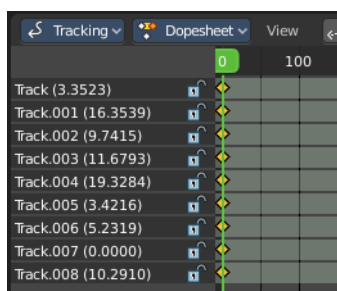
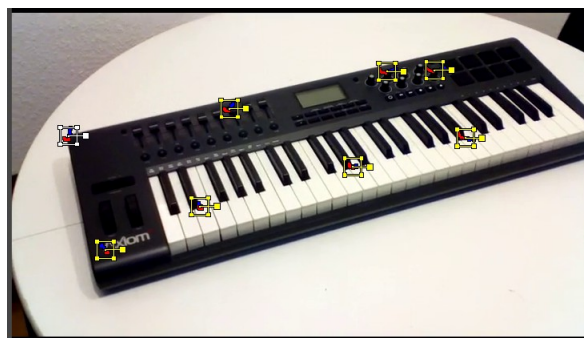

Last Operator Detect Features

Placement

Placement is a drop down box where you can limit the placement of the markers.

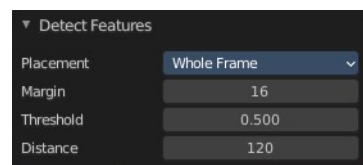

Whole frame

The markers can be at every position of the current frame image.

Inside Grease Pencil

The markers have to be inside the Grease Pencil.

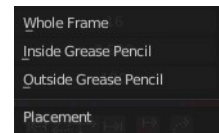

Outside Grease Pencil

The markers have to be outside Grease Pencil.

Margin

Gives a margin to the border of the frame image. Markers have to stay away from the border by the given amount.

Threshold

The threshold level to consider the current position of the marker as good enough for tracking.

Distance

The minimum distance between two markers.

Create Plane Track

Creates a plane track. A plane track can be used to map an image or a movie at an area in your clip. The Plane track.

New Image from Plane Marker

Create new image from the content of the plane marker from the pixels of the movie clip that the plane marker “sees” at the current frame. This allows you to create and impose an un-warped texture of any flat surface in the footage.

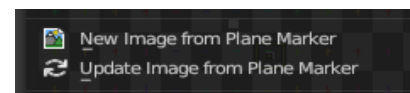

To use, create and select four tracking points then create a Plane Marker. Once you’ve selected the Plane Marker, create the new image - then edit the image in the Image Editor.

Update Image from Plane Marker

Update current image used by plane marker from the content of the plane marker. This updates the pixels of the active Plane Track’s image.

Allows you to update the texture of any flat surface in the footage.

Solve Camera Motion

Starts the calculation for the camera motion to match the track motion.

There should be at least eight common tracks on the both of the selected keyframes.

There should be noticeable parallax effects between these two keyframes.

The average re-projection error is reported to the information space and to the clip editor header. Re-projection error means the average distance between reconstructed 3D position of tracks projected back to footage and original position of tracks. Re-projection error below 0.3 means accurate re-projection, (0.3 - 3.0) means quite nice solving which still can be used. Values above 3 means some tracks should be tracked more accurately, or that values for focal length or distortion coefficients were set incorrectly.

Join Tracks

Joins selected tracks.

Copy

Copy selected tracks to clipboard.

Paste

Pastes selected tracks from clipboard.

Copy Settings to Defaults

Copies track settings from active track to default settings.

Apply default settings

Copy tracking settings from active tracks to selected tracks. You need to select the source track first, then hold down shift, then select the target track. Then perform copy track settings.

Animation

Insert Keyframe

Inserts a keyframe at current position in spreadsheet sub mode panel.

Delete Keyframe

Deletes keyframes at current position in dope sheet sub mode panel.

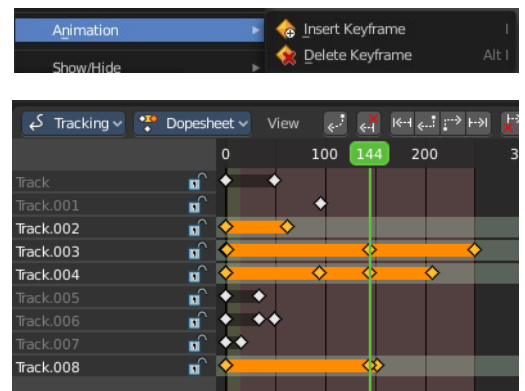

Show/Hide

Show or hide tracks.

Show Hidden

Show all hidden tracks.

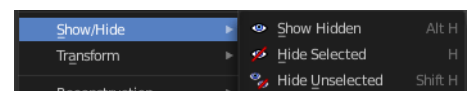

Hide Selected

Hide the selected tracks.

Hide Unselected

Hide the unselected tracks.

Last operator Hide Tracks

Unselected

Hide selected or unselected tracks.

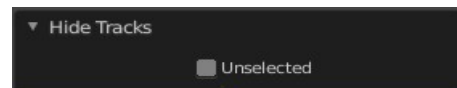

Clean up

Clean Tracks

Clean tracks with high error values or few frames.

Filter Tracks

Filter out tracks that has weird looking spikes in motion curves.



Delete Track

Delete the selected track.

Delete Marker

Delete the selected marker.

Reconstruction

Set Origin

Set active marker as origin in 3D space.

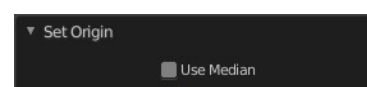
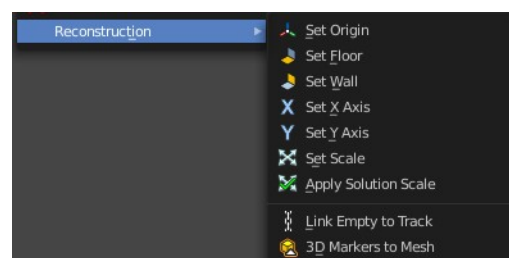

Last Operator Set Origin

Use Median

Set Origin to Median Point of selected bundles.

Set Floor

Set plane in the 3D space as a Floor plane, based at three selected markers. You need to have three markers selected. Or you will get an error message.

Set Wall

Set plane in the 3D space as a Wall plane, based at three selected markers.

Last Operator Set Plane

Plane

A drop down box to choose if you want to set the selected markers as plane or as floor.

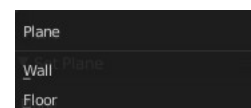
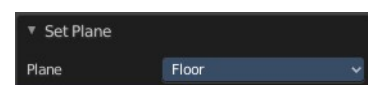

Set X Axis

Set X axis rotation in 3D space, based at the selected marker. You need to have one marker selected. Or you will get an error.

Set Y Axis

Set X axis rotation in 3D space, based at the selected marker. You need to have one marker selected. Or you will get an error.

Last Operator Set Axis

Axis

A drop down box to choose if you want to use the axis to X or to Y

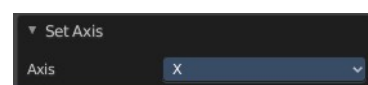

Set Scale

Set scale of scene by scaling camera, based at two selected markers. You need to have two markers selected. Or you will get an error.

Last Operator Set Scale



Distance

The distance between two bundles used for scene scaling.

Apply Scale

Apply scale to solution.

Last operator Apply Solution Scale

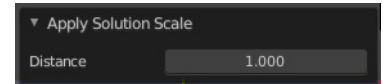

Distance

The distance between two bundles used for scene scaling.

3D Markers to Mesh

Creates a vertex cloud using the coordinates of the reconstructed tracks.

Link Empty to Track

Creates an Empty which will be copying movement of active track.



15.1.7 Editors - Movie Clip Editor - Header - Tracking Mode - Graph Submode - Graph Menu

Table of content

- Track Menu.....1
- Delete Curve.....1
- Delete Knot.....1
- Clear Track Path Remained.....1
- Clear Track Path Up To.....1
- Clear Track Path All.....1
- Disable Markers.....1
- Move.....2
- Rotate.....2
- Resize.....2

Track Menu

Delete Curve

Deletes the track that correspondent to the current curve.

Delete Knot

Deletes the selected curve points.

Clear Track Path Remained

Clears the track path after the current position.

Clear Track Path Up To

Clears the track path up to the current position.

Clear Track Path All

Clears the complete track path.

Disable Markers

Disables the selected curve points.

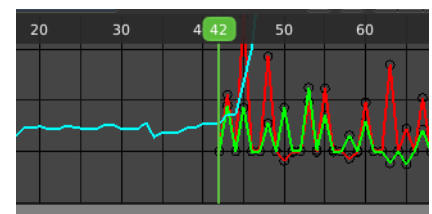
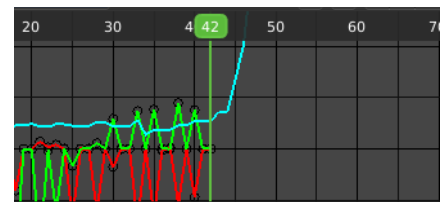
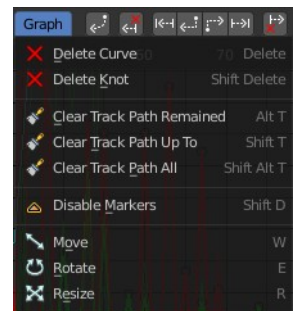

Move

Moves the selected curve points.

Rotate

Rotates the selected curve points.

Resize

Scales the selected curve points.



15.1.8 Editors - Movie Clip Editor - Header - Mask Mode - Clip Menu

Table of content

Clip Menu.....	1
Open Clip.....	1
Prefetch Frames.....	1
Reload Clip.....	1

Clip Menu

Open Clip

Opens an Image Sequence or a movie clip.

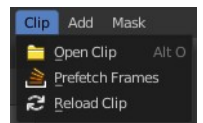

Prefetch Frames

Prefetch frames from disk for faster playback and/or tracking.

Reload Clip

Reloads the movie clip.



15.1.9 Editors - Movie Clip Editor - Header - Mask Mode - Add Menu

Table of content

Add Menu.....	1
Circle.....	1
Last Operator Add Circle.....	1
Size.....	1
Location X Y.....	2
Square.....	2
Last Operator Add Square.....	2
Size.....	2
Location X Y.....	2
Adding more curve points.....	2
Last operator Add Vertex and Slide.....	2
Location X Y.....	2

Add Menu

Masking can be done by using curves. In the Add menu you will find two spline primitives. You can choose between a circle Bezier curve object and a square Bezier curve object.

You select curve points by clicking with the left mouse button at them. Holding down Shift will add to the selection. Clicking in the off will deselect everything.

Circle

Adds a Bezier circle that you can use for masking.

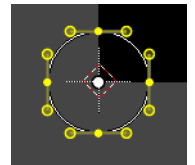

This circle element can be modified by right clicking at the handlers and pulling at the handlers until the desired result is achieved. The yellow points are handlers. The whole curve can be moved around with right mouse button. See also Transform sub menu in the Mask menu.

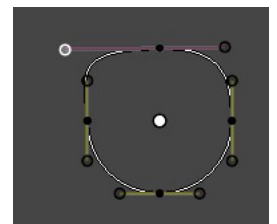

Last Operator Add Circle

Size

The size of the circle.

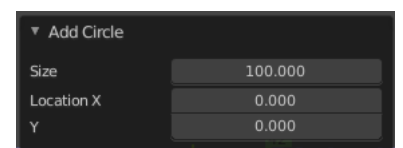

Location X Y

The location of the circle.

Square

Adds a Bezier circle that you can use for masking.

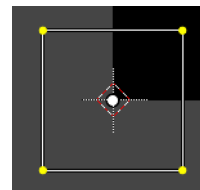

This circle element can be modified by right clicking at the handlers and pulling at the handlers until the desired result is achieved. The yellow points are handlers. The whole curve can be moved around with right mouse button. See also Transform sub menu in the Mask menu.

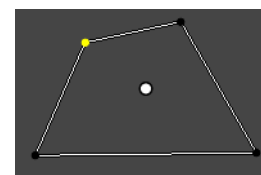

Last Operator Add Square

Size

The size of the circle.

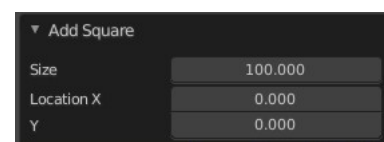

Location X Y

The location of the circle.

Adding more curve points

You can add more curve points by holding down ctrl and clicking left at a curve.

You can create a spline from scratch with this method too. Simply hold down Ctrl, click into the viewport, and created your needed spline points. To close the created mask spline use Toggle Cyclic from the mask menu.

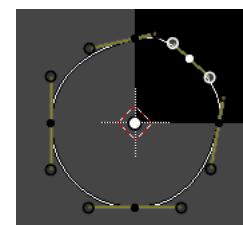

Last operator Add Vertex and Slide

Location X Y

The location of the created spline point.





15.2 Editors - Movie Clip Editor - Tool shelf

Table of content

Tool Shelf.....	1
Track Tab and Solve Tab in Tracking Mode.....	1
Annotation tab.....	1
Draw.....	1
Draw.....	1
Erase.....	2
Line.....	2
Poly.....	2
Stroke Placement.....	2
View.....	2
Cursor.....	2

Tool Shelf

The Tool Shelf exists for the Tracking Mode in Clip submodule. And for Mask mode.

In Tracking Mode it contains the tools to do the tracking. And in Mask Mode some mask tool functionality.

The submodes Graph and Dopesheet does not have a tool shelf. Here you can find a list of the tracks instead.

The content is differing, dependant of the mode you are in. Tracking mode has other tools than the Masking mode.

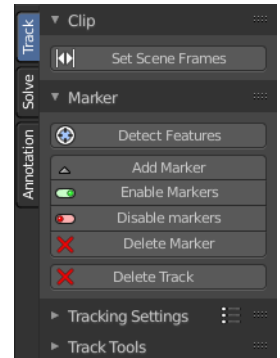

Track Tab and Solve Tab in Tracking Mode

The track tab contains the tools around the movie side of things. Markers, tracking etc.

The solve tab contains the tools around the scene side of things. Scene setup, camera motion, etc.

Annotation tab

The Annotation tab contains the usual Annotation tools to draw and erase strokes. The tools should be self explaining

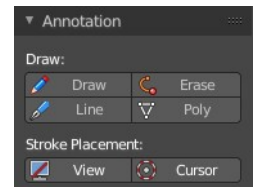

Draw

Draw

Draw freehand strokes.

Erase

Erase strokes.

Line

Draw a line by clicking at a starting point and then at the end point.

Poly

Draw a polygon by clicking at the places where a corner should be.

Stroke Placement

View

Place the strokes relative to the view.

Cursor

Place the strokes relative to the cursor.



15.2.1 Editors - Movie Clip Editor - Tool shelf - Tracking Mode

Table of content

Detailed Table of content.....	2
Track tab - Clip Panel.....	4
Set Scene Frames.....	4
Track tab - Marker Panel.....	4
Detect Features.....	5
Add Marker.....	6
Enable Markers.....	6
Disable Markers.....	6
Delete Marker.....	6
Delete Track.....	6
Track tab - Tracking Settings Panel.....	6
Tracking Presets.....	6
Pattern Size.....	7
Search Size.....	7
Motion.....	7
Match.....	7
Prepass.....	7
Normalize.....	7
R G B.....	7
Copy from Active Track.....	7
Tracking Settings Extra.....	8
Track tab - Track Tools Panel.....	8
Track.....	8
Clear.....	8
Refine.....	9
Merge.....	9
Solve tab - Plane Track Panel.....	9
Solve tab - Solve Panel.....	10
Tripod.....	11
Keyframe.....	11
Keyframe A.....	11
Keyframe B.....	11
Refine.....	11
Solve Camera Motion.....	11
Solve tab - Cleanup Panel.....	11
Clean Tracks.....	11
Filter Tracks.....	12
Solve tab - Geometry Panel.....	12
3D Markers to Mesh.....	12
Link Empty to Track.....	12
Solve tab - Orientation Panel.....	12
Floor.....	13
Wall.....	13
Set Origin.....	13
Set X Axis.....	13
Set Y Axis.....	13
Set Scale.....	13

Apply Scale.....	14
Distance.....	14
Solve tab - Scene Setup Panel.....	14
Set as Background.....	14
Setup Tracking Scene.....	14
Annotation tab.....	14
Draw:.....	15
Data Source.....	15
Stroke Placement.....	15

Detailed Table of content

3.5 - Movie Clip Editor

Detailed Table of content.....	2
Track tab - Clip Panel.....	4
Set Scene Frames.....	4
Track tab - Marker Panel.....	4
Detect Features.....	5
Last Operator Detect Features.....	5
Placement.....	5
Whole frame.....	5
Inside Grease Pencil.....	5
Outside Grease Pencil.....	5
Margin.....	5
Threshold.....	5
Distance.....	5
Add Marker.....	6
Enable Markers.....	6
Disable Markers.....	6
Last operator Disable Markers.....	6
Action.....	6
Delete Marker.....	6
Delete Track.....	6
Track tab - Tracking Settings Panel.....	6
Tracking Presets.....	6
Pattern Size.....	7
Search Size.....	7
Motion.....	7
Match.....	7
Prepass.....	7
Normalize.....	7
R G B.....	7
Copy from Active Track.....	7
Tracking Settings Extra.....	8
Weight.....	8
Correlation.....	8
Frames Limit.....	8
Margin.....	8
Use Mask.....	8
Track tab - Track Tools Panel.....	8

Track.....	8
Clear.....	8
Last Operator Clear Track Path.....	8
Action.....	8
Clear active.....	9
Refine.....	9
Backwards.....	9
Merge.....	9
Join Track.....	9
Average Tracks.....	9
Last Operator Average Tracks.....	9
Keep Original.....	9
Solve tab - Plane Track Panel.....	9
Solve tab - Solve Panel.....	10
Tripod.....	11
Keyframe.....	11
Keyframe A.....	11
Keyframe B.....	11
Refine.....	11
Solve Camera Motion.....	11
Solve tab - Cleanup Panel.....	11
Clean Tracks.....	11
Last Operator Clean Tracks.....	12
Frames.....	12
Error.....	12
Select.....	12
Filter Tracks.....	12
Last Operator Filter Tracks.....	12
Track Threshold.....	12
Solve tab - Geometry Panel.....	12
3D Markers to Mesh.....	12
Link Empty to Track.....	12
Solve tab - Orientation Panel.....	12
Floor.....	13
Wall.....	13
Last Operator Set Plane.....	13
Plane.....	13
Set Origin.....	13
Last Operator Set Origin.....	13
Use Median.....	13
Set X Axis.....	13
Set Y Axis.....	13
Last Operator Set Axis.....	13
Axis.....	13
Set Scale.....	13
Last Operator Set Scale.....	14
Distance.....	14
Apply Scale.....	14
Last operator Apply Solution Scale.....	14
Distance.....	14
Distance.....	14
Solve tab - Scene Setup Panel.....	14
Set as Background.....	14

Setup Tracking Scene.....	14
Annotation tab.....	14
Draw:.....	15
Draw.....	15
Erase.....	15
Line.....	15
Poly.....	15
Insert Blank Frame.....	15
Last Operator Insert Blank Frame.....	15
All Layers.....	15
Delete Frame(s).....	15
Data Source.....	15
Clip / Track.....	15
Stroke Placement.....	15
View / Cursor.....	15

Track tab - Clip Panel

The Clip panel contains movie related tools.

Set Scene Frames

Sets the length, means start and end frame of the tracking to match the start and end frame of the active movie.

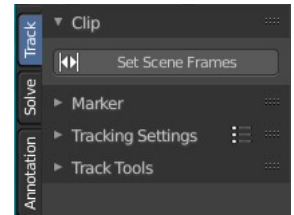

You can see the length of the active movie in the Properties sidebar in the Footage tab in the Footage Settings panel. And the tracking length and position can be seen and set in the time line.

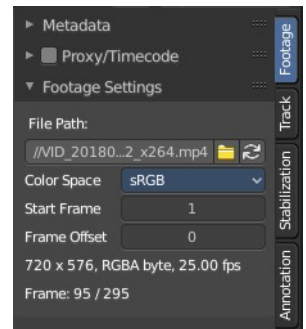

The default range for tracking is from 1 to 250. But our movie is 295 frames long. Pressing the Set Scene Frames button makes the range going from 1 to 295 here.

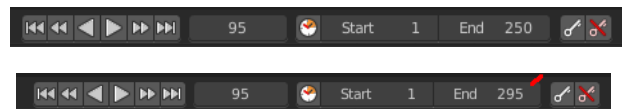

Track tab - Marker Panel

The marker panel contains marker related tools.

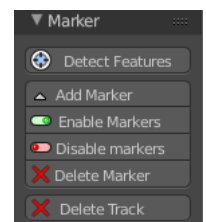

Detect Features

Adds automatically markers at the current movie position, and tries to detect marcant areas in the current frame that are useful for tracking. It also sets keyframes at this position.

When enough marcant areas are available then it adds up to eight markers that way.

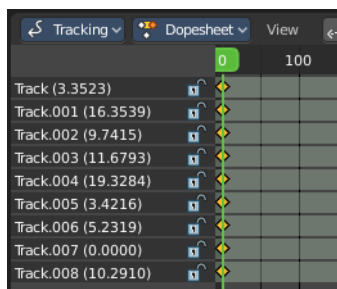
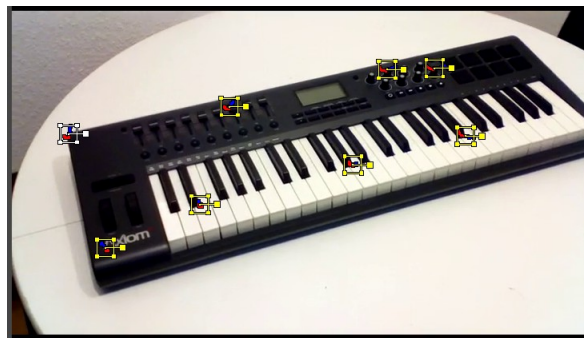

Last Operator Detect Features

Placement

Placement is a drop down box where you can limit the placement of the markers.

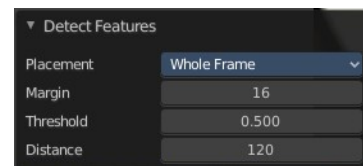

Whole frame

The markers can be at every position of the current frame image.

Inside Grease Pencil

The markers have to be inside the Grease Pencil.

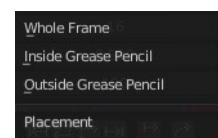

Outside Grease Pencil

The markers have to be outside Grease Pencil.

Margin

Gives a margin to the border of the frame image. Markers have to stay away from the border by the given amount.

Threshold

The threshold level to consider the current position of the marker as good enough for tracking.

Distance

The minimum distance between two markers.

Add Marker

Adds a marker by hand. First click the tool, then click at the location where you want to place it.

You can reposition this marker afterwards by simply clicking at it and move it to a new position.

Enable Markers

Enables the currently selected marker(s).

Disable Markers

Disables the currently selected marker(s)

Last operator Disable Markers

Action

Edit box to choose if you want to enable or disable the selected marker(s).

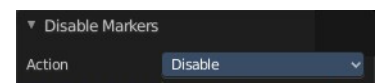

Delete Marker

Deletes the currently selected marker(s) data. The track stays available. And the marker is still there too. But cleared.

Delete Track

Deletes marker, marker data and track data.

Track tab - Tracking Settings Panel

In the Tracking Settings Panel you will find some settings for Tracking.

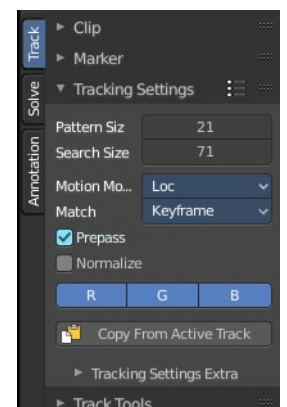
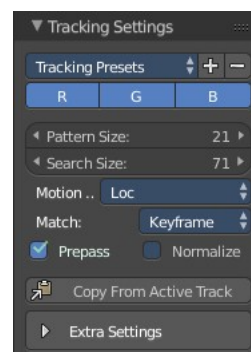

Tracking Presets

In the header is a drop down box to choose between some predefined tracking presets.

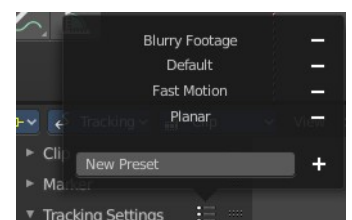

+ Button adds a new preset with the current settings. First give the preset a name in the edit box.

- Button removes the current tracking preset.

Pattern Size

Size of pattern area for newly created tracks.

Search Size

Size of search area for newly created tracks.

Motion

Choose between different motion models for tracking.

Loc stands for location. Rot for Rotation, etc.

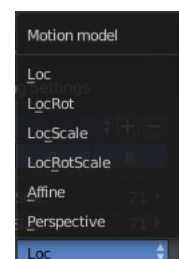

Match

The pattern match method.

Keyframe matches the tracking from the keyframe.

Previous frame matches the tracking from the previous frame. Regardless if there is a keyframe recorded or not.

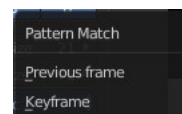

Prepass

Use a Brute Force translation - only initialization when tracking.

Normalize

Normalize light intensities when tracking.

R G B

By default all three colors gets used for calculation. But you can enable or disable specific color range.

Copy from Active Track

Copy tracking settings from active track to default settings

Tracking Settings Extra

Extra settings is a sub menu that contains some not so often used settings.

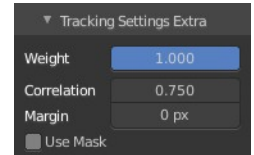

Weight

Influence of newly created track on a final solution.

Correlation

Default minimum value of correlation between matched pattern and reference that is still treated as successful tracking.

Frames Limit

In every tracking cycle the numbers of given frames are tracked.

Margin

Default distance from image boundary at which markers stops tracking.

Use Mask

Use a Grease Pencil data block as a mask.

Track tab - Track Tools Panel

The tracking tools.

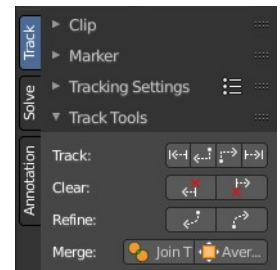

Track

Track selected markers in chosen direction. Usually you want to play them forward. But you can also track backwards. And by one step.

The two play buttons in the center tracks the whole range. The two outer buttons tracks just frame wise.

Tip

To select good points for tracking, use points in the middle of the footage timeline and track backwards and forwards from there. This will provide a greater chance of the marker and point staying in the camera shot.

Clear

The left button clears the track before the chosen position. The right button clears the track after the chosen position.



Last Operator Clear Track Path

Action

Choose the direction.

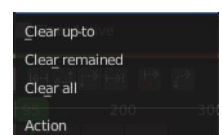
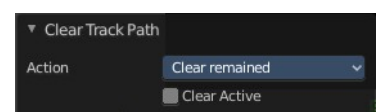

Clear up to clears the track before the chosen position.

Clear remained clears the track after the chosen position.

Clear all clears the whole track.

Clear active

When ticked, just the active track gets cleared.

Refine

Refine selected marker position in given direction from the current position.

Last operator Refine Markers

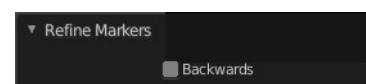

Backwards

Refine in backwards directory.

Merge

Join Track

Joins selected tracks.

Average Tracks

Averages selected tracks into active.

Last Operator Average Tracks

Keep Original

Keep the original track.

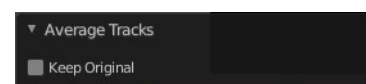

Solve tab - Plane Track Panel

Create a plane track. A plane track can be used to map an image or a movie at an area in your clip. The Plane track.

A plane track can be used to replace things like billboards and screens on the footage with another image or video. It can also be used for masking.

It is also possible to have some tracks appear and disappear during the time. This required to have two neighbor frames have at least 4 common tracks.

You need to select at least four markers. And the four markers should preferably be at the corners of the area in which you want to map the image or movie.

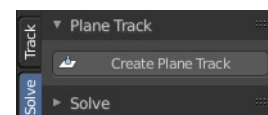

With the left mouse button and clicking at one of the corners of the cage you can move the plane track plane around in the view.

With the right mouse button and clicking at one of the corners of the cage you can move the single corners, and fit the plane into the area of the movie.



In the sidebar, open the Track tab and the Plane Track panel. Here you can now load an image or movie that gets displayed in this rectangle now, create a new image, or browse for already existing images in the project.

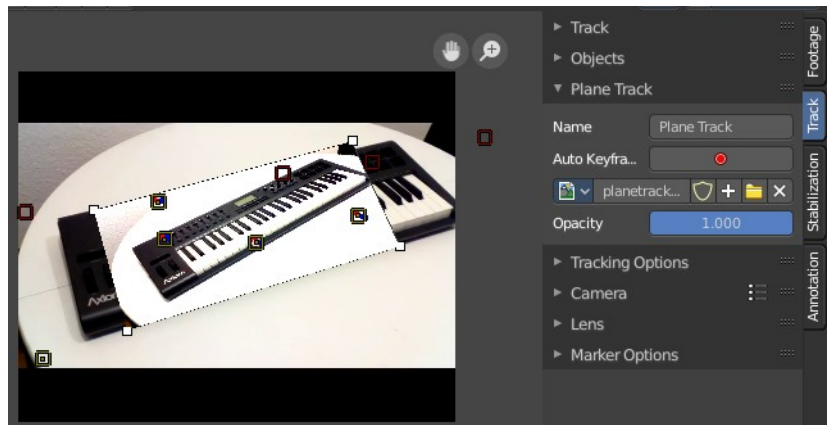
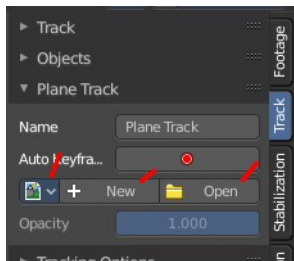

Solve tab - Solve Panel

The Solve Panel contains functionality around solving the camera motion.

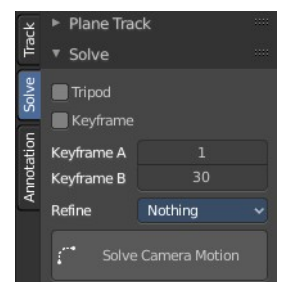

Tripod

Tripod tracking is a special method to track a stable camera position, and uses special solver. Tripod Motion can be used for footage where the camera does not move and only rotates. Here you can enable Tripod camera tracking. Keyframe A and B are greyed out then.

Note that Tripod behaves different from regular solver. More tracks doesn't imply to have more accuracy. 5-10 solver is recommended.

Keyframe

Automatically select Keyframes when solving camera / object motion

Keyframe A

The first keyframe for camera tracking.

Keyframe B

The last keyframe for camera tracking.

Refine

Choose between different refine methods.

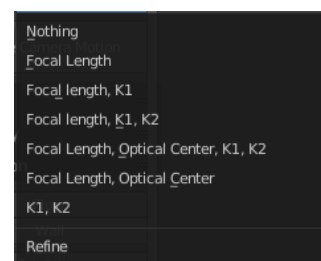

Solve Camera Motion

Starts the calculation for the camera motion to match the track motion.

There should be at least eight common tracks on the both of the selected keyframes.

There should be noticeable parallax effects between these two keyframes.

The average re-projection error is reported to the information space and to the clip editor header. Re-projection error means the average distance between reconstructed 3D position of tracks projected back to footage and original position of tracks. Re-projection error below 0.3 means accurate re-projection, (0.3 - 3.0) means quite nice solving which still can be used. Values above 3 means some tracks should be tracked more accurately, or that values for focal length or distortion coefficients were set incorrectly.

Solve tab - Cleanup Panel

This panel contains tools to clean up tracks.

Clean Tracks

Cleans tracks with high error values or few frames. The tracks or segments in question can either be selected, or directly removed. Dependent of the settings.

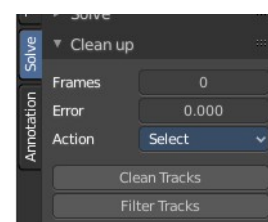

Last Operator Clean Tracks

Frames

Adjust the number of "few" frames for clean track. 0 means the feature gets ignored.

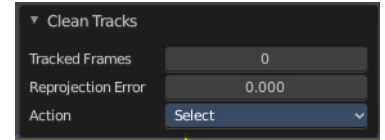

Error

Adjust the error value for Clean Tracks.

See also Last Operator Clean Tracks.

Select

The action that should happen when you click at Clean Tracks. Default is select.

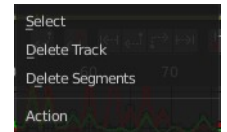

Filter Tracks

Removes tracks with too high spikes in their motion curve.

Last Operator Filter Tracks

Track Threshold

Filter threshold to select problematic tracks.



Solve tab - Geometry Panel

3D Markers to Mesh

Creates a vertex cloud using the coordinates of the reconstructed tracks.

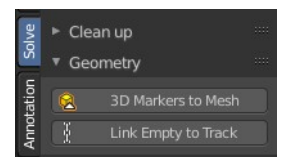

Link Empty to Track

Creates an Empty which will be copying movement of active track.

Solve tab - Orientation Panel

Here you will find some orientation functionality to match the geometry in the 3D view to the movie.

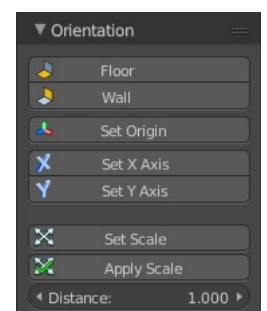

Floor

Set plane in the 3D space as a Floor plane, based at three selected markers. You need to have three markers selected. Or you will get an error message.

Wall

Set plane in the 3D space as a Wall plane, based at three selected markers.

Last Operator Set Plane

Plane

A drop down box to choose if you want to set the selected markers as plane or as floor.

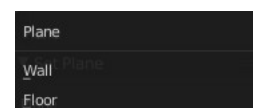
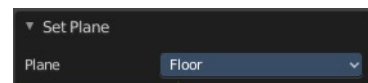

Set Origin

Set active marker as origin in 3D space.

Last Operator Set Origin

Use Median

Set Origin to Median Point of selected bundles.

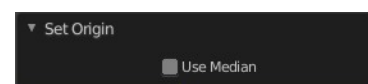

Set X Axis

Set X axis rotation in 3D space, based at the selected marker. You need to have one marker selected. Or you will get an error.

Set Y Axis

Set X axis rotation in 3D space, based at the selected marker. You need to have one marker selected. Or you will get an error.

Last Operator Set Axis

Axis

A drop down box to choose if you want to use the axis to X or to Y

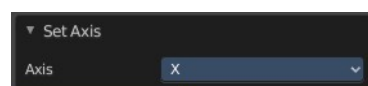

Set Scale

Set scale of scene by scaling camera, based at two selected markers. You need to have two markers selected. Or you will get an error.

Last Operator Set Scale



Distance

The distance between two bundles used for scene scaling.

Apply Scale

Apply scale to solution.

Last operator Apply Solution Scale

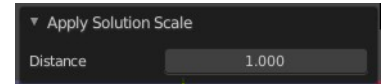

Distance

The distance between two bundles used for scene scaling.

Distance

The distance between two bundles used for scene scaling. This setting is a pre value, and gets used for Set Scale as well as for Apply Scale when you perform those tools.

Solve tab - Scene Setup Panel

Set as Background

Sets the current movie as background in the 3D view. You need to be in camera view to see the movie in the background.

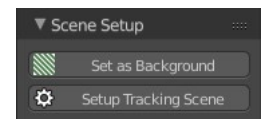

Setup Tracking Scene

Prepare Scene for composing 3D objects into this footage.

This feature will create a ground plane, which is used for shadow catching in the rendering.

Annotation tab

The annotation tool is available in multiple editors. With this tool you can write notes at the screen. The annotate tools is the little brother of the grease pencil object in the 3D view.

Further settings for annotations can be found in the sidebar. Here you can also remove an annotation when you don't longer need it. And here you can also adjust the size of the stroke.

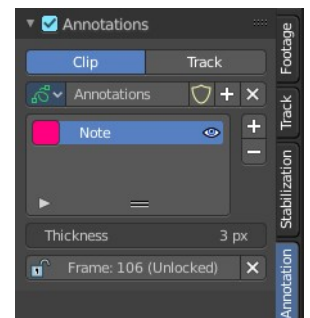
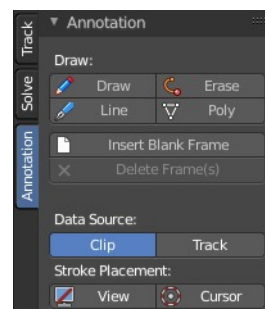

Draw:

Draw

Draw free-hand strokes in the main window.

Erase

Activate the eraser brush.

Line

Click and drag to create a line.

Poly

Click multiple times to create multiple connected lines. The current polygon is finished when Esc or RMB is pressed. When you hold down the right mouse button then you can activate and use the eraser tool to remove parts of the polygon again.

Insert Blank Frame

Insert a blank animation frame at the current position.

Last Operator Insert Blank Frame

All Layers

Create a blank frame in all annotation layers, not only in the active.

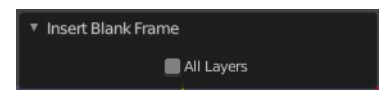

Delete Frame(s)

Delete current animation frame.

Data Source

Clip / Track

Where the annotation stroke comes from. From the movie clip, or from the track.

Stroke Placement

View / Cursor

Stick stroke to the view, or to the cursor. The cursor is visible in Mask mode.



15.3 Editors - Movie Clip Editor - Sidebar

Table of content

Introduction.....	1
Right Click menus.....	1

Introduction

The Movie Clip Editor is made of several areas. And it is made of several modes with different editor types.

At the right side you will find the sidebar in Tracking Mode with Clip view. And in Masking mode. In the sidebar you will find further options and settings for the Movie Clip Editor and its tools.

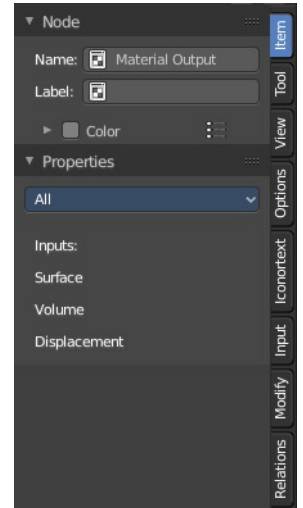

Right Click menus

You will open the usual right click menus when clicking with the right mouse at elements in the sidebar. Its content is in big parts self explaining.

The right click menus are explained in the chapter 6 Editors Introduction.

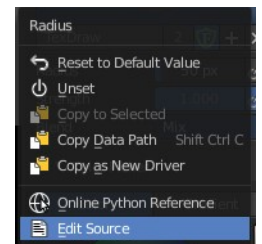



15.3.1 Editors - Movie Clip Editor - Sidebar - Footage tab

Table of content

Preface.....	1
Footage Tab - Metadata Panel.....	1
Footage Tab - Proxy/Time code Panel.....	2
Build Original.....	2
Build Undistorted.....	2
Quality.....	2
Proxy Custom Directory.....	2
Build Proxy / Time code.....	2
Delete Proxy.....	2
Time code Index.....	2
Proxy Size.....	3
Footage Tab - Footage Settings Panel.....	3
File Path.....	3
Color Space.....	3
Start Frame.....	3
Frame Offset.....	3
Footage Information string.....	3

Preface

Note that the correct mode is Tracking Mode in Clip View. In Graph and Dopesheet View there is no sidebar.

Note also that some panels exists in both modes, tracking and masking. They have sometimes different content though.

Footage Tab - Metadata Panel

Displays the metadata of the footage if available. The panel stays empty if there is none.

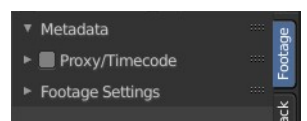

Footage Tab - Proxy/Time code Panel

This content shows in Tracking Mode and Masking mode.

A proxy is a smaller replacement image for the main image. Think of it as a thumbnail. The creation may take some time. But once done, all other calculations happens much faster. So it can make sense to use proxies for bigger footage.

Make sure to disable the Proxy images before doing the final render!

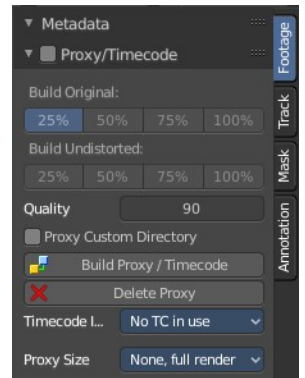

Build Original

Define the resolution of the proxy images.

Build Undistorted

Builds the proxy images from the undistorted original images for the sizes set above.

Quality

Defines the quality of the JPEG images used for proxies.

Proxy Custom Directory

By default, all generated proxy images are storing to the <path of original footage>/BL_proxy/<clip name> folder. Define a custom directory.

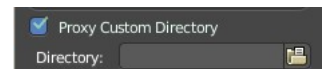

Build Proxy / Time code

(Re)creates the proxy images and the time code.

Delete Proxy

Deletes the proxy images and the time code.

Time code Index

When you are working with footage directly copied from a camera without pre-processing it, then there might be a bunch of artifacts. In this case the calculation can give errant result. One way to avoid this is to use the Proxy / Time code option. Another method would be to use a external tool like Mencoder to repair the file header and insert correct keyframes.

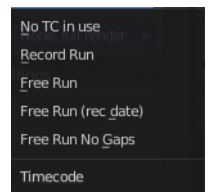

Note

Record Run is recommended for most needs. But when the clip's file is totally damaged, *Record Run No Gaps* will be the only chance of getting acceptable result.

Proxy Size

This setting defines which proxy image resolution is used for display in the viewport. If there is no generated proxies, render size is set to “No proxy, full render”.

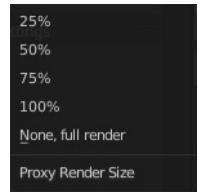

Footage Tab - Footage Settings Panel

This content shows in Tracking Mode and Masking mode.

The panel contains some footage related settings.

File Path

The file path for the currently loaded and active video. Here you can also load another video, or refresh the video.

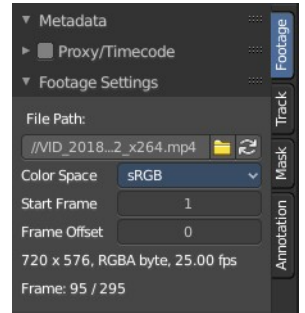

Color Space

The color space for the currently loaded and active video.

Start Frame

The start frame for the currently loaded and active video.

Frame Offset

Define a frame offset.

Footage Information string

Here you will find some information about the footage. Size, color mode, fps, current position ...



15.3.2 Editors - Movie Clip Editor - Sidebar - Track tab

Table of content

Detailed Table of content.....	1
Preface.....	2
Track Tab - Track Panel.....	2
Track tab - Objects Panel.....	4
Track tab - Plane Track Panel.....	4
Track tab - Tracking Options Panel.....	5
Track tab - Camera Panel.....	7
Track tab - Camera Panel - Lens Subpanel.....	7
Track tab - Marker Options Panel.....	8

Detailed Table of content

Detailed table of content

Detailed Table of content.....	1
Preface.....	2
Track Tab - Track Panel.....	2
Edit Box.....	2
Enable.....	2
Lock.....	3
Track Scope.....	3
Color Settings.....	3
R, G, B.....	3
B/W.....	3
Alpha.....	3
Weight.....	3
Stab Weight.....	3
Average Error.....	3
Custom Color.....	4
Color Preset.....	4
Copy Color.....	4
Color.....	4
Track tab - Objects Panel.....	4
Add, Remove Tracking Object.....	4
Search Field.....	4
Track tab - Plane Track Panel.....	4
Name.....	5
Auto Keyframe.....	5
Image prop.....	5
Image browser.....	5
Edit Box.....	5
Fake User.....	5
New Image.....	5
Remove.....	5
Opacity.....	5

Track tab - Tracking Options Panel.....	5
Motion Model.....	6
Match.....	6
Prepass.....	6
Normalize.....	6
Tracking Options Extras.....	6
Correlation.....	6
Margin.....	6
Use Mask.....	6
Frames Limit.....	6
Speed.....	6
Track tab - Camera Panel.....	7
Presets.....	7
Add Camera Preset.....	7
Sensor Width.....	7
Pixel Aspect.....	7
Track tab - Camera Panel - Lens Subpanel.....	7
Focal length.....	7
Units.....	7
Optical center.....	8
Set Center.....	8
Lens Distortion.....	8
Track tab - Marker Options Panel.....	8
Enabled.....	8
Position.....	8
Offset.....	8
Pattern Area.....	8
Search Area.....	9

Preface

Note that the correct mode is Tracking Mode in Clip View. In Graph and Dopesheet View there is no sidebar.

Note also that most panels just shows in tracking mode, and not in masking mode.

Track Tab - Track Panel

Marker settings for the currently selected marker.

Edit Box

Read and edit the name of the currently selected marker.

Enable

Enable the currently selected marker.



Lock

Lock the currently selected marker.

Track Scope

This is a preview image and fine tune window for the currently selected marker. The fade cross stays always in the center, but you can move the image with the left mouse. This automatically records the changed position, and inserts a keyframe at the current position if necessary.

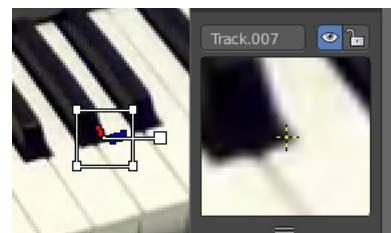

You can pull it vertically bigger by pulling at the handler below the image. And horizontally bigger by pulling out the properties sidebar.

If an anchor is used (the position in the image which is tracking is different from the position which is used for parenting), a preview widget will display the area around the anchor position.

Color Settings

R, G, B

Use red, green and blue color in the preview image.

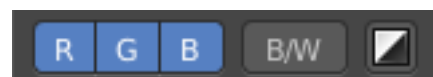

B/W

Use a greyscale preview image.

Alpha

Use existing alpha channel for preview image.

Weight

The influence of this track to the final solution. Altering the weights of problem tracking markers can correct or greatly reduce undesirable jumps. This parameter can be animated.

Stab Weight

Stabilization weight. The influence of this track on 2D stabilization.

Average Error

The average error of this marker.

Custom Color

Give the markers different colors. This also affects the list of markers in Dope sheet view.

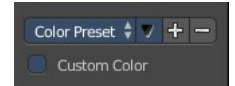
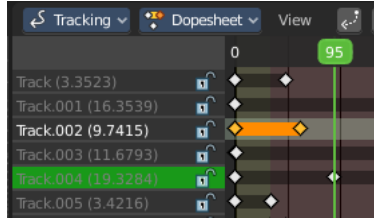
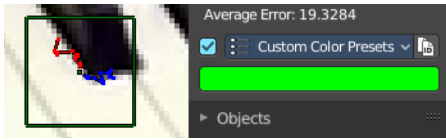

Color Preset

A dropdown box to choose between some predefined colors.

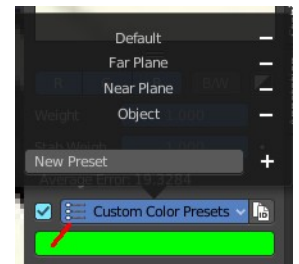

Copy Color

Copy the color of the currently chosen preset.

Color

When you tick custom color then a color field will appear below. It displays the current custom color, and allows you to change the color by clicking at it. A color picker will appear.



Track tab - Objects Panel

This content shows in Tracking Mode and Masking mode.

A list of the tracked objects. Usually the camera. But you can track every other object too.

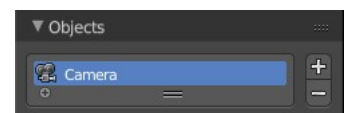

Add, Remove Tracking Object

The plus and minus buttons at the right allows you to add new objects to the list, or to remove existing objects from the list.

Search Field

The list field contains a hidden search field. Click at the little + button down left to reveal it.



Track tab - Plane Track Panel

This content is just active and visible when you have a Plane track in your footage.

See also in the Tool shelf in the Solve tab in the Plane Track panel.

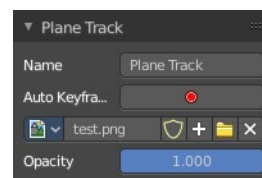

Name

The name of the Plane track.

Auto Keyframe

Use Auto Keyframe when moving plane track corners.

Image prop

Image browser

See and load images or movies that you want to display inside of the Plane track. Note that this image needs to exist already so that it gets displayed in the list. As a image node for example.

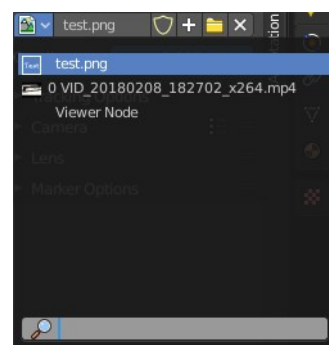

Edit Box

The name of the current active image or movie. Click at it to change the name.

Fake User

With this button you assign a fake user to this selected mask. Masks get created with a fake user already. Means when you save the scene and reopen it, then this mask will still be there.

Data, like images, that is not longer linked to anything else gets removed when you save and reload a scene. Bforartists has the concept of fake users to go around this behaviour. An image with a fake user is in fact linked to something. And so it is not lost when you save and reload the scene.

New Image

Calls a file browser to choose a image or movie.

Remove

Removes the current active image or movie. It is still in the Image browser though. To delete it completely you can use the Purge command in the File menu in the Cleanup submenu. See also Fake User.

Opacity

The opacity of the image or movie.

Track tab - Tracking Options Panel

This content is visible when you have at least one of the markers selected.

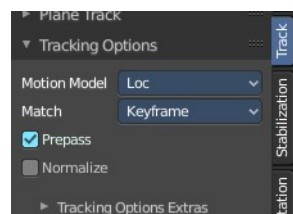

Motion Model

Choose the motion model for the marker.

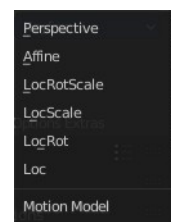

Match

Choose the pattern match method.

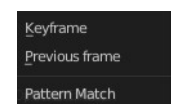

Prepass

Use a brute-force translation only pre-track before refinement.

Normalize

Normalize light intensities while tracking.

Tracking Options Extras

A sub menu that contains some not so often used settings.

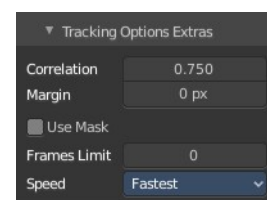

Correlation

Default minimum value of correlation between matched pattern and reference that is still treated as successful tracking.

Margin

Default distance from image boundary at which markers stops tracking.

Use Mask

Use a Grease Pencil data block as a mask.

Frames Limit

In every tracking cycle the numbers of given frames are tracked.

Speed

A drop down box to choose the tracking speed. This is just a preview feature. The tracking quality is not affected.

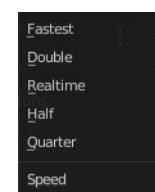

Track tab - Camera Panel

The settings for the camera with which you have recorded the footage movie. Every camera has some specific settings. And this needs to be calculated too to match the footage to the 3D content.

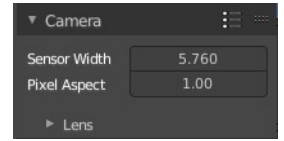

Presets

A drop down box to choose between different camera presets. When your camera is not listed then you need to do the settings manually.



Add Camera Preset

This is at the end of the list. Add a new preset, and give it a name. To remove the preset click at the minus sign besides the preset in the list

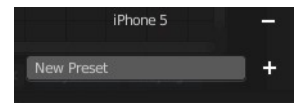

Sensor Width

The width of the CCD Sensor in your used camera. This value can be found in the camera specifications.

Pixel Aspect

The Pixel Aspect ratio of the CCD Sensor in your used camera. This value can be found in the camera specifications.

This value can also be guessed. For example, when the footage should be 1920×1080, but the images themselves are 1280×1080, then the pixel aspect is: $1920 / 1280 = 1.5$.

Track tab - Camera Panel - Lens Subpanel

This panel belongs to the Camera panel above. Type in your lens values from the camera with which you have recorded your footage movie.

Focal length

The focal length units with which the movie was shot. You can choose between millimeter and pixel.

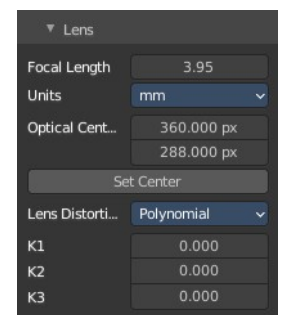

Units

The units to use for the camera focal length.

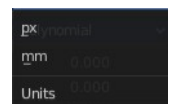

Optical center

The optical center. Usually in the middle of the movie. But some cameras also have an offset here.

In most cases it is equal to the image center, but it can be different in some special cases. Check camera/lens specifications in such cases. To set the optical center to the center of image, there is a Return button below the sliders.

Set Center

Center the optical center.

Lens Distortion

The lens distortion of your camera. You can choose between two distortion models. Polynomial and Divisions.

Basically, just tweak K1 until solving is most accurate for the known focal length (but also take grid and grease pencil into account to prevent “impossible” distortion).

The brown model also provides P1 and P2 values.

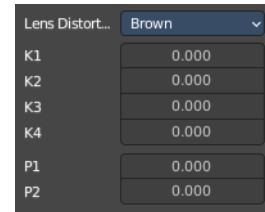
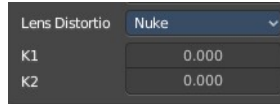
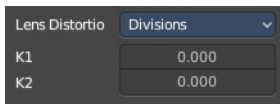
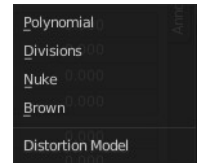

Track tab - Marker Options Panel

The Marker panel contains the settings for the selected marker(s). Here you can also enable or disable the marker.

Enabled

Enable the selected marker(s).

Position

The position of the selected marker(s) in pixel. Zero is down left.

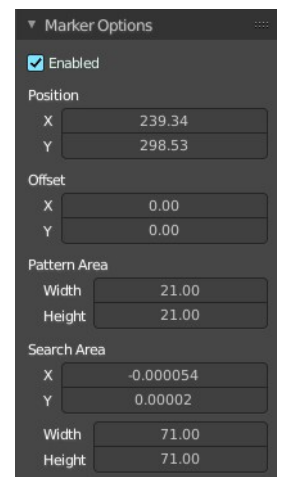

Offset

You can give the marker handler an offset. So that it gets displayed besides the marker.

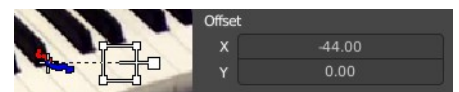

Pattern Area

The handler size.

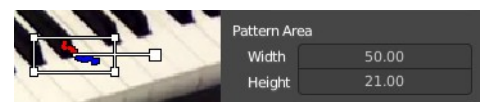

Search Area

The size and position of the search area for this marker for tracking.

The search area can be turned on in the Clip Display options in the header up right.

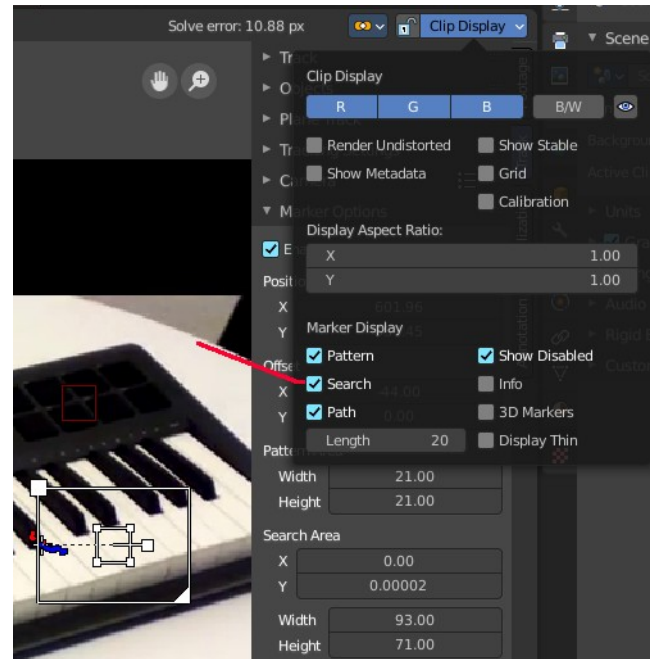



15.3.3 Editors - Movie Clip Editor - Sidebar - Tracking Mode - Stabilization tab

Table of content

Tracking Mode - 2D Stabilization Panel.....	1
Anchor Frame.....	2
Rotation / Scale.....	2
Tracks for Location.....	2
Tracks for Rotation/Scale.....	2
Autoscale.....	2
Max.....	2
Expected Position.....	2
X / Y.....	2
Expected Rotation.....	2
Expected Scale.....	2
Influence.....	3
Interpolate.....	3

Tracking Mode - 2D Stabilization Panel

The purpose of 2D Stabilization is to smooth out jerky camera handling on existing real world footage. To activate the 2D stabilizer, you need to set the toggle in the panel, and additionally you need to enable *Show Stable* in the Display panel. Then you'll need to set up some tracking points to detect the image movements. And you need to set a proper starting point, the anchor frame.

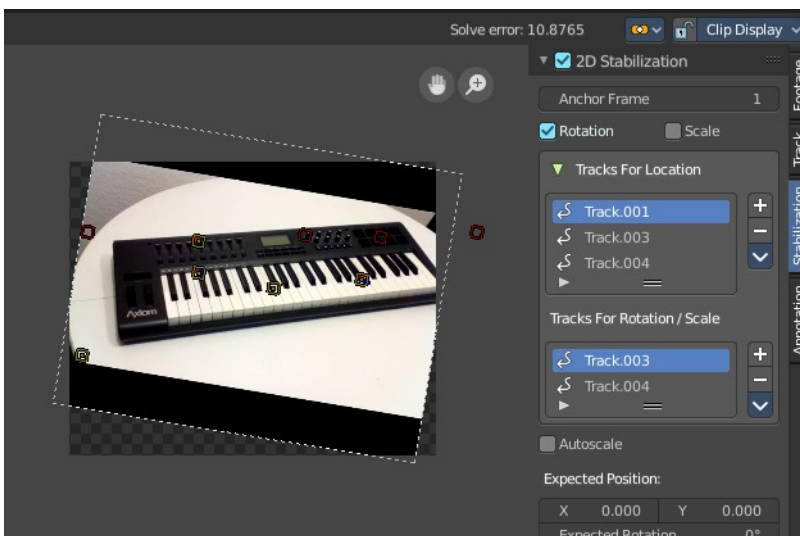
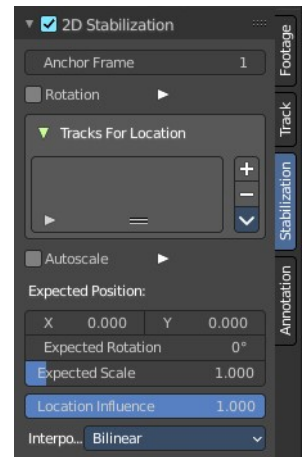
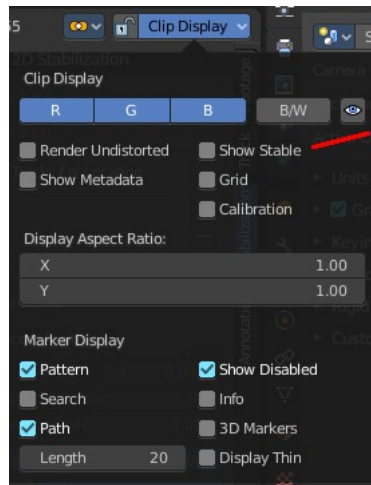

Anchor Frame

The first frame of the stabilization.

Rotation / Scale

Normally you just stabilize the position. Here you can stabilize rotation and scale too. Note that you can't activate scale independently here. It appears when you activate Rotation.



Tracks for Location

The list of markers that gets used for location stabilization.

With the plus and minus button at the right you can add selected markers, or remove the markers from the list.

Tracks for Rotation/Scale

The list of markers that gets used for rotation/scale stabilization.

With the plus and minus button at the right you can add selected markers, or remove the markers from the list.

This list is just visible when you have at least Rotation activated.

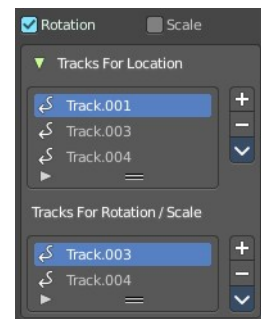

Autoscale

The stabilization will lead to areas where the movie doesn't show at the canvas anymore. Autoscale scales the content so that the whole canvas is covered again.



Max

The maximum value for Autoscale. This slider appears when you activate Autoscale.

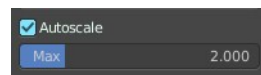

Expected Position

X / Y

The position of the movie at the canvas.

Expected Rotation

Rotate the movie at the canvas manually.

Expected Scale

Scale the movie at the canvas manually. Note that this slider is not showing when you have Autoscale activated.

Influence

The influence of stabilization algorithm. You can independently adjust location, rotation and scale. When you have rotation off, then the sliders for rotation influence and scale influence are not showing.

Location Influence	1.000
Rotation Influence	1.000
Scale Influence	1.000

Interpolate

Adjust the interpolation mode for images. For rotation and scale the images needs to be recalculated.

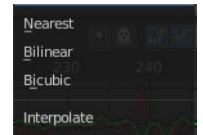



15.3.4 Editors - Movie Clip Editor - Sidebar - View tab

Table of content

Preface.....	1
2D Cursor Tab.....	1
Annotations Panel.....	1
Clip / Track.....	2
Annotations prop.....	2
Drop down box.....	2
Edit Box.....	2
Fake User.....	2
Add Annotation.....	2
Delete Annotation.....	2
List of Annotation Strokes.....	2
Thickness.....	2
Frame Locked/Unlocked.....	3
Delete Active Frame.....	3

Preface

Note that the correct mode is Tracking Mode in Clip View. In Graph and Dope sheet View there is no sidebar.

Note also that some panels exists in both modes, tracking and masking.

2D Cursor Tab

Just shows in Mask mode. Tracking has no 2D cursor.

This panel shows the location of the 2d cursor, based at the lower left corner of the footage image. The edit boxes also allows you to set the cursor position by numeric values.

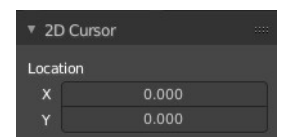

Annotations Panel

The Annotations panel is the place to manage the Annotation layers and materials.

When you don't have drawn an annotation yet then the panel just contains a New button.

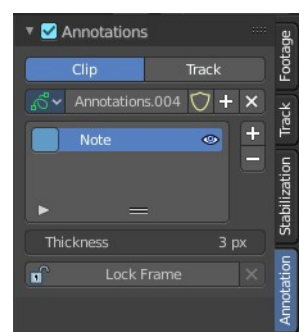
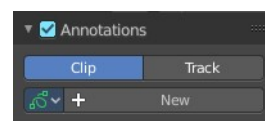

Clip / Track

Where the Grease Pencil comes from. From the movie Clip, or from a track.

Annotations prop

Add, remove and rename new annotations.

Drop down box

A list of the available annotation layers.

Edit Box

The name of the current annotation. You can rename the annotation to your needs here.

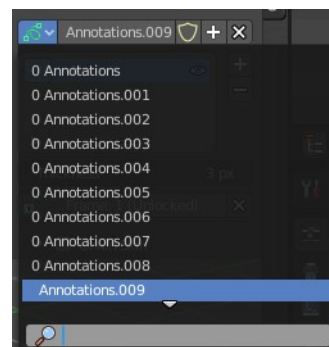

Fake User

Assign a fake user to this annotation. Fake users is an odd concept to keep data in the scene even if it has no user somewhere. The fake user is then a dummy user so that the object is not deleted when saving the scene.

Add Annotation

Add a new annotation.

Delete Annotation

Delete the annotation.

List of Annotation Strokes

A list of the Annotation layers for the current Annotation. Every layer can have an own color.

At the right side you find buttons to sort them and to add and remove new Annotation layers.

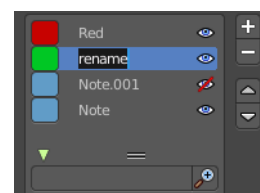

You can change the color by clicking at the color field. A color dialog will pop up. You can rename annotation layers by double clicking at it.

The eye icon allows you to make it invisible And it has a search field.

Thickness

The thickness of the annotation stroke.

Frame Locked/Unlocked

Lock frame displayed by current layer. This toggles whether the active layer is the only one that can be edited.

Delete Active Frame

This feature is active when there is an animation. Delete the active frame from the active annotations layer.



16 Editors - Dope Sheet

Table of content

The Dopesheet Editor.....	2
Time cursor.....	2
Keyframe types.....	2
Markers.....	3
Recording.....	3
Viewport Navigation.....	4
Viewport navigation.....	4
Dope Sheet Channel Context Menu.....	4
Frame selected channels.....	4
Mute Channel.....	4
Unmute Channel.....	4
Protect Channels.....	5
Unprotect Channels.....	5
Group Channels.....	5
Ungroup Channels.....	5
Toggle Channel Editability.....	5
Extrapolation Mode submenu.....	5
Extrapolation Mode.....	5
Constant Extrapolation.....	5
Linear Extrapolation.....	5
Make Cyclic.....	5
Clear Cyclic.....	5
Expand Channels.....	5
Collapse Channels.....	5
Move submenu.....	6
Delete Channels.....	6
Dope Sheet Context Menu.....	6
Copy.....	6
Paste.....	6
Paste Flipped.....	6
Keyframe Type.....	6
Handle Type.....	6
Interpolation Mode.....	7
Easing Mode.....	7
Insert Keyframes.....	7
Duplicate.....	7
Delete Keyframes.....	7
Delete Breakdowns.....	7
Delete Duplicate Frames.....	7
Mirror.....	7
Snap.....	7
Slider snapping.....	8
Quick Favorites menu.....	8

The Dopesheet Editor

The Dopesheet Editor is the editor type to edit the keyframe data of your animation data. The Dopesheet editor is part of five editor types that deals with your animation data. It is some kind of a chart, and gives you an overview over all of your animation data.

The Dope sheet editor has several areas.



Header (Yellow)

Channel list (Green)

Sidebar (Blue)

Viewport (no color)

The header is divided into two parts too. Left tools and menus. Right Options.

Time cursor

The Time Cursor is the green line. It is used to set and display the current time frame.

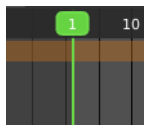

Keyframe types

The keyframes can have different color and shape.

Gray - Unselected keyframe.

Yellow - Selected keyframe.

Diamond - Free keyframe handle.

Round - Auto Clamped keyframe handle.

Circle - Automatic Keyframe handle.

Square - Vector Keyframe handle.

Rhombus - Aligned Keyframe handle.

Various colors - You can give keyframes an own color with the keyframe type drop down menu at the right.

Gray bar between keys - The two keyframes are identical.

Green line between keys - Fixed keyframe interpolation.

Upwards arrow - Maximum Extreme keyframe. You need to enable *Show Curve extremes* in the Marker options in the sidebar.

Downwards arrow - Minimum Extreme keyframe. You need to enable *Show Curve extremes* in the Marker options in the sidebar.

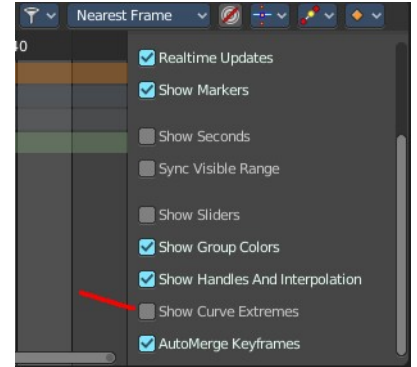

Markers

Markers are visible hints to denote frames with key points or significant events within an animation. A marker could mark a character's animation starts, the position change of a camera, or a door that opens.

Markers can be added, deleted and renamed from the Marker menu. Once created they reside at the bottom of the viewport.

To select a marker click at it.

To move a marker click and drag.

The active marker is highlighted, and shows a dotted line upwards.

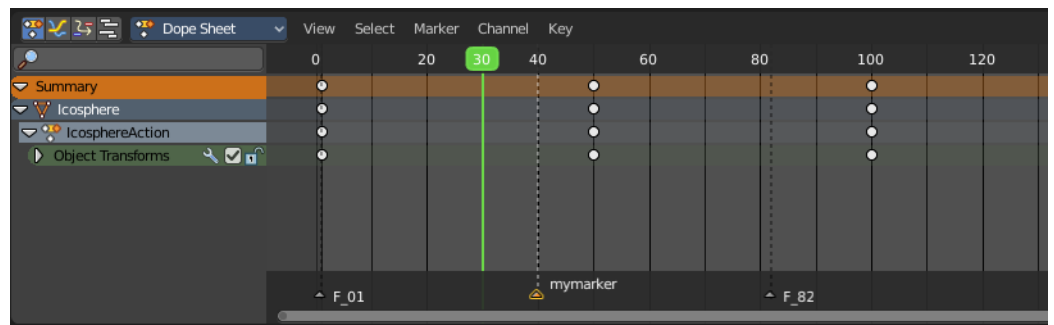

When a frame matches the marker position then the info string in the 3D view shows the name of this marker too.

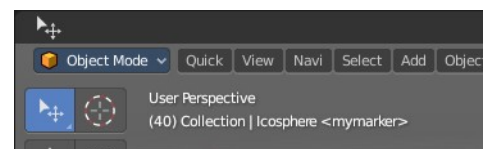

Recording

You usually set and record the keyframes in the 3D view. Or by activating the decorators besides a menu item in a panel.

The Dope Sheet Editor also allows you to record keyframes. Have a look in the Key menu for Insert Keyframes.

There is an exception. The grease pencil object. This is because it can have two types of keyframes. One in object mode. For the whole object. And one in edit mode. For animating points of the curve geometry. This is what the Grease Pencil mode belongs to.

In Grease Pencil mode the changes at the geometry are recorded automatically by modifying the current geometry at the current frame. There is no extra Insert Keyframes menu item. The keyframes gets generated when you modify the geometry.

Viewport Navigation

Navigation in the viewport happens by mouse or hotkeys. Some of them does not have a menu entry. And needs to be explained here.

Viewport navigation

Right mouse button moves the frame marker.

Clicking left at the number bar moves the frame marker.

Middle mouse button pans the view.

Holding ctrl + middle mouse button zooms the view.

Scroll Wheel zooms the view.

To drag a keyframe click at it and drag the mouse.

Dope Sheet Channel Context Menu

When you right click into the channel area, then you will call the Dope Sheet Channel context menu.

Frame selected channels

Centers the selected channels in view.

Mute Channel

This channel is not calculated.

Unmute Channel

This channel is calculated.

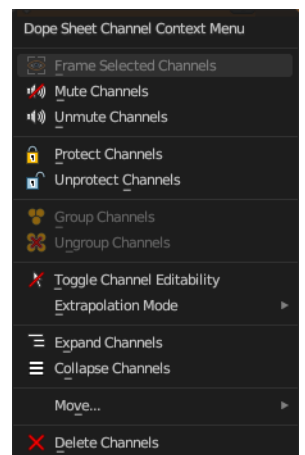

Protect Channels

Protect channels from editing.

Unprotect Channels

Enables editing of channels again.

Group Channels

Groups channels together.

Ungroup Channels

Ungroup grouped channels. Beware, the channels will not return to their initial group.

Toggle Channel Editability

Protects or unprotects the selected channels.

Extrapolation Mode submenu

Extrapolation Mode

Sets the extrapolation mode for the selected F-Curves. Means how the curve acts at the beginning and the end of the F-Curve.

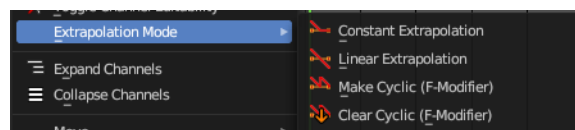

Constant Extrapolation

The animation curve continues straight at the end.

Linear Extrapolation

The animation curve continues the last direction.

Make Cyclic

Makes the animation loopable. The interpolation curves are adjusted so that the first frame fits to the last frame.

Clear Cyclic

Removes the cyclic extrapolation.

Expand Channels

Expands the channels.

Collapse Channels

Collapses the channels.

Move submenu

Sort the order of the channels. The menu items should be self explaining.

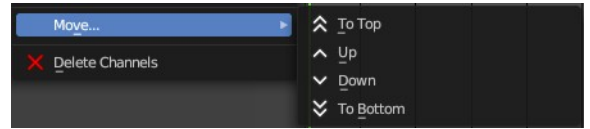

Delete Channels

Removes the selected channels.

Dope Sheet Context Menu

When you right click into the dope sheet viewport then you will call the Dope Sheet context menu.

Copy

Copies the currently selected keyframe(s).

Paste

Pastes copied keyframe(s).

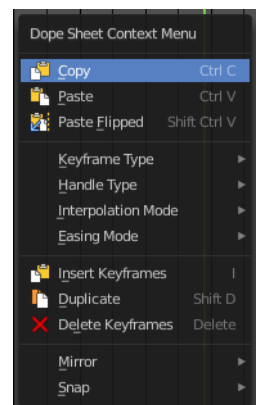
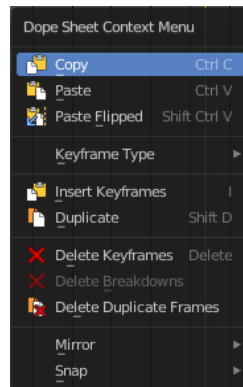

Paste Flipped

Pastes copied keyframe(s), but flipped.

Keyframe Type

Recolor the currently selected keyframes.

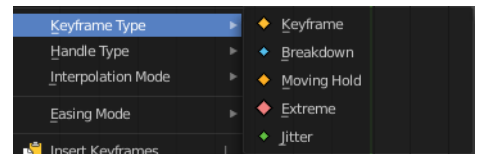

Handle Type

Set the handle type for the currently selected keyframes.

This is a feature for the Graph editor, where each curve point has its own handler with which you can influence the curve behavior. But the handler type also influences how the animation curve acts at the chosen keyframes. So it has its use in the dope sheet editor too.

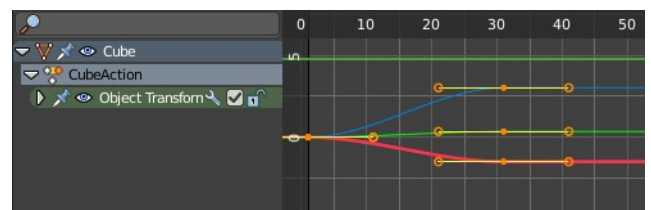
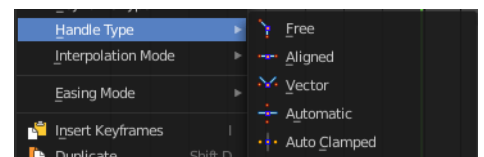

Interpolation Mode

The Interpolation mode defines how the curve acts from keyframe to keyframe. You can have a linear curve between two keyframes instead of a bent one for example.



The easing methods here in the interpolation mode menu are for the easing shape. There is also an easing menu where you can choose a easing method.

Easing Mode

Choose a easing method. The easing methods in the interpolation mode menu are for the easing shape.

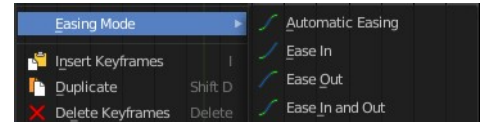

Insert Keyframes

Insert a keyframe at the current position.

Duplicate

Duplicate the selected keyframe(s).

Delete Keyframes

Delete the selected keyframe(s).

Delete Breakdowns

In Grease Pencil mode. Deletes breakdown poses generated by interpolating between two grease pencil frames.

Delete Duplicate Frames

In Grease Pencil mode. Deletes all duplicated frames.

Mirror

Mirrors the animation by the given method.

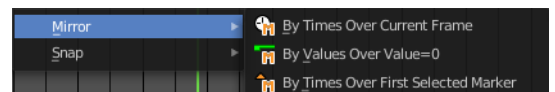

Snap

Snaps the selected keyframes by the given method.

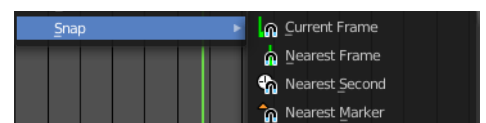

Slider snapping

Snapping also works at sliders. Hover with the mouse over the slider, start to slide, and holding down **Ctrl** will snap the sliders in incremental steps.



When it's a default value between 0 and 1 then it usually snaps in 0.1 steps. When it's a default value over 1 then it usually snaps in steps of 10.

The increment snapping also works at the frame slider. Here the incremental snapping happens by the frame rate that you have defined. With a frame rate of 24 it will snap in steps of 24 frames when holding down ctrl.

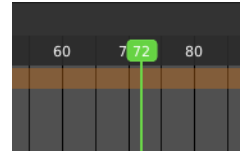

Quick Favorites menu

When you right click at a menu or a button, then a right click menu will open. Tools have usually a Add to Quick Favorites menu entry.

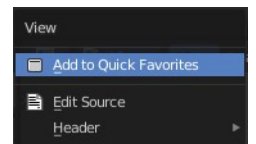

The Quick Menu is empty by default. With Add to Quick favorites you can add this menu to the Quick menu.

In the 3D view we have a menu called Quick in the header, which shows this content then. In the Dope Sheet Editor you can just call it with its hotkey. Q. It has no regular menu entry here.

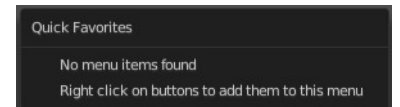



16.1.1 Editors - Dope Sheet - Header tools and options

Table of content

Introduction.....	2
Header Tabs.....	2
Dope Sheet Modes.....	2
Dope Sheet.....	2
Action Editor.....	3
Shape Key Editor.....	3
Grease Pencil.....	3
Mask.....	4
Cache File.....	4
Show Hide elements.....	4
Summary.....	4
Only Show Selected.....	4
Show Hidden.....	4
Only Show Errors.....	4
Dope Sheet Mode - Filters.....	4
Filter by Collection.....	5
Filter by Type.....	5
Options.....	5
Sort Data Blocks.....	5
Multi Word Match Search.....	5
All Modes - Proportional Editing.....	5
All Modes - Keyframe Easing, Handle Type, Keyframe Interpolation, Keyframe Type.....	5
Easing Mode.....	5
Handle Type.....	5
Interpolation Mode.....	6
Keyframe Type.....	6
All Modes but Grease Pencil - Auto Snap.....	6
Action & Shape Key mode tools.....	6
Next Layer / Previous Layer.....	6
Push Down.....	6
Stash.....	7
Action Data Browser prop.....	7
Action Data Browser.....	7
Number of Fake Users.....	7
Fake User.....	7
New Action.....	7
Unlink Action.....	7
Grease Pencil mode tools.....	7
Add new Layer.....	7
Remove Layer.....	7
Layer Specials.....	8
Duplicate layer.....	8
Show All.....	8
Hide Others.....	8
Lock All.....	8
Unlock All.....	8
Autolock inactive Layers.....	8

- Merge Down.....8
- Copy Layer to object.....8
- Move Grease Pencil Layer upwards.....8
- Move Grease Pencil Layer downwards.....8
- Isolate Layer with visibility.....8
- Isolate Layer without visibility.....8
- Options.....9
 - Real-time Updates.....9
 - Show Seconds.....9
 - Sync visible range.....9
 - Show Sliders.....9
 - Show Handles and Interpolation.....9
 - Show Curve Extremes.....9
 - AutoMerge Keyframes.....9
 - Show Markers.....10
 - Lock Markers.....10
 - Sync Markers.....10

Introduction

The header contains various menus and tools. This chapter here is about the tools, modes and options elements in the header.

The text menus are covered in an own chapter each. They vary too much, dependent of mode and object type.



Header Tabs

The tabs at the very left allows you to switch between the four most important editor types by one click. Dope sheet Editor, Graph Editor, Driver Editor, NLA Editor.



Dope Sheet Modes

The Dope sheet has different modes. Each mode has its own purpose. In Mask mode you can for example see and edit the keyframes for mask animations, from the movie clip editor for example.

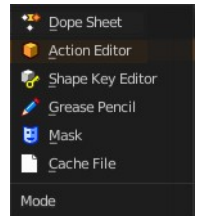

Dope Sheet

Display the keyframe animation of all currently selected object in the 3d view.

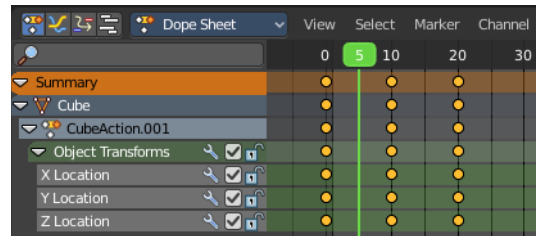

Action Editor

Display and edit the Action part of a keyframe animation of the currently active object in the 3d view. Just the data for this one object is displayed.

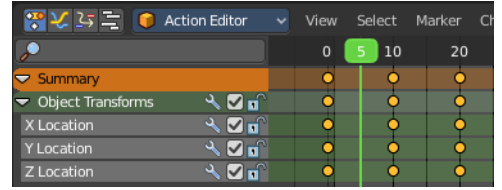

Actions are a generic containers for F-Curves. Actions can contain any number of F-Curves, and can be attached to any data block. For example, an action that modifies the 'X location' and 'Y location' properties can be shared across multiple objects, since both objects have 'X location' and 'Y location' properties available.

The Action editor allows you to edit the animation in various ways. For example also turn a keyframe animation into a clip for the NLA editor.

The animation data is build in a hierarchical way. From top to bottom.

Actions - Record and contain animation data.

Groups - Are groups of channels.

Channels - Contains record properties.

F-Curves - F-Curves are used to interpolate the difference between the keyframes.

Keyframes - Keyframes are used to set the values of properties bound to a point in time.

Shape Key Editor

Display and and edit the keyframes for shape key animations. Shape keys is vertex animation.

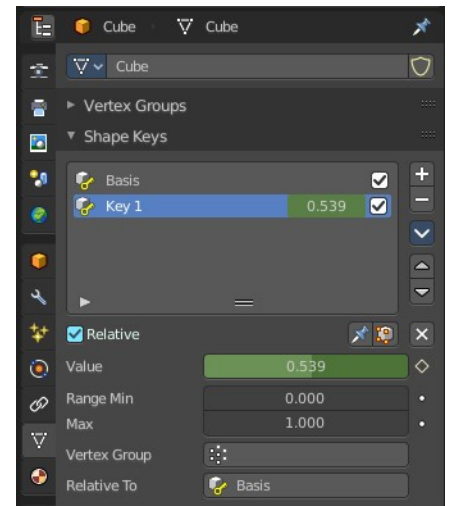
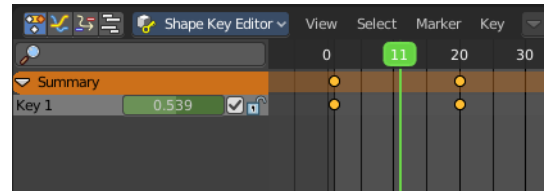

Grease Pencil

Display and and edit the keyframes for animated grease pencil strokes. This mode is for when you animate grease pencil strokes and colors at a vertex level. When you record

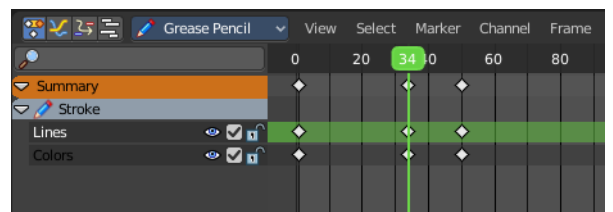

keyframes at an object level then those keyframes gets displayed in the Dope sheet and Action mode.

Mask

Display and edit the keyframes for animated mask curves. Like from the movie clip editor.

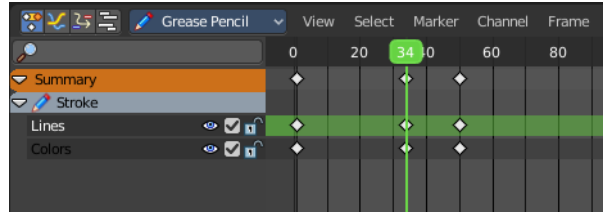

Cache File

NOT DOCUMENTED BY BLENDER. NOT TO FIND OUT HOW TO USE.

From the Blender Manual: Cache File: Alembic Todo 2.78.

Show Hide elements

Summary

Display the Summary label above the list of elements.

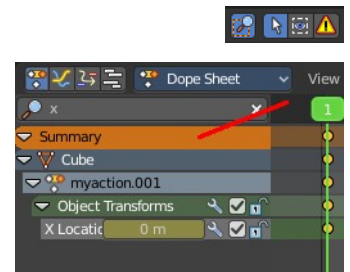

Only Show Selected

Display only the data for the selected object in the list of elements. If off it displays all available animation data of the whole scene.

Show Hidden

Include channels from objects / bones that are not visible. This feature just works with Only Selected off.

Only Show Errors

Only display F-Curves and Drivers that have errors or are disabled.

Dope Sheet Mode - Filters

The show hide elements allows you to filter out the general elements. The Filters panel allows you to filter out further elements.

Note that this filter methods just exists for the dope sheet mode. In other modes the panel does not show.

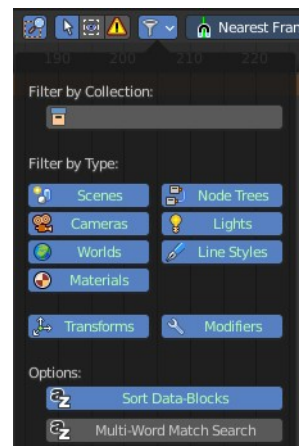

Filter by Collection

Just display the content from the chosen collection in the list of elements.

Filter by Type

In this section you can choose what type of animation data should be displayed. The names should be self explaining.



Options

Sort Data Blocks

Alphabetically sort the data in the list of elements.

Multi Word Match Search

Enable Multi Word matching for the search in the list of elements.

All Modes - Proportional Editing

Enable proportional editing.

Proportional editing allows you for example to scale two keyframes and influence the not selected neighbour keyframes in a proportional way. Or the proportional editing of fcurve points.

The dropdown menu to choose the proportional editing falloff method is just available when the proportional tool is active.

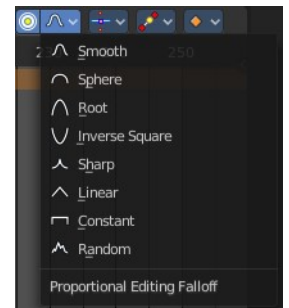

All Modes - Keyframe Easing, Handle Type, Keyframe Interpolation, Keyframe Type

Easing Mode

Choose between different easing modes for the selected keyframes. Easing is a method to fade in and out curves.

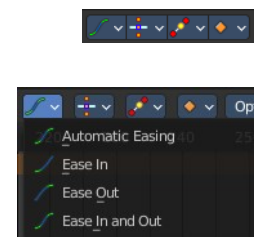

Handle Type

Set the handle type for the currently selected keyframes.

This is a feature for the Graph editor, where each curve point has its own handler with which you can influence the curve behaviour. But the handler type also influences how the animation curve acts at the chosen keyframes. So it has its use in the dopesheet editor

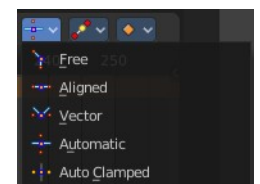

too.

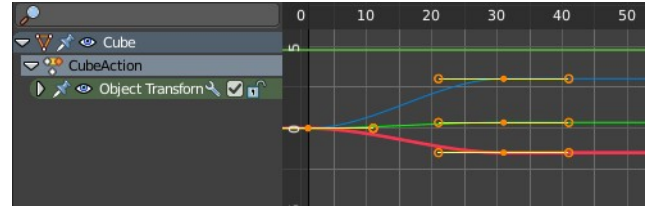

Interpolation Mode

The Interpolation mode defines how the curve acts from keyframe to keyframe. You can have a linear curve between two keyframes instead of a bent one for example.

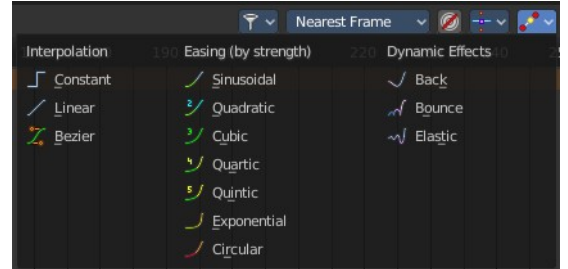

The easing methods here in the interpolation mode menu are for the easing shape. There is also an easing menu where you can choose an easing method.

Keyframe Type

Recolor the currently selected keyframes. Or create the next keyframe with this chosen keyframe color.

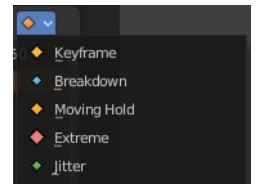

All Modes but Grease Pencil - Auto Snap

Adjust how the selected keyframe or fcurve point snaps to other elements.

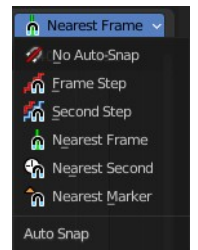

Action & Shape Key mode tools



Next Layer / Previous Layer

When there is more than one animated object in the scene then you have most probably more than one action in the scene too. Switch to previous or next actions to use them in the current object.

Push Down

Adds the active action on to the NLA stack as a contributing strip. The same can be done by pressing the Push Down button in the NLA Editor.

Stash

Stashes the active action on to the NLA stack. This means it is added as a non-contributing stack in the same way that it would if you were creating a new action instead.

Note

Push down and Stash adds the action to the NLA stack. It is cleared / unassigned from the active action slot.

This means that the action cannot be edited anymore from the Action or Graph Editors, unless you enter “Tweak Mode” on the corresponding strips later.

Action Data Browser prop

When there is more than one animated object in the scene then you have most probably more than one action in the scene too. The Action Data Browser allows you to display, select and rename the available actions in the scene.

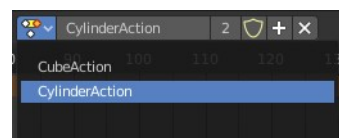

Action Data Browser

The list of available actions in the scene.

Number of Fake Users

Displays the current number of fake users for the active action.

Fake User

Assign a fake user to this action. Fake users is a odd concept to keep data in the scene even if it has no user somewhere. The fake user is then a dummy user so that the object is not deleted when saving the scene.

New Action

Add a new blank action.

Unlink Action

Delete the current active action.

Grease Pencil mode tools

Add new Layer

Adds a new blank grease pencil layer.

Remove Layer

Removes the currently selected grease pencil layer.

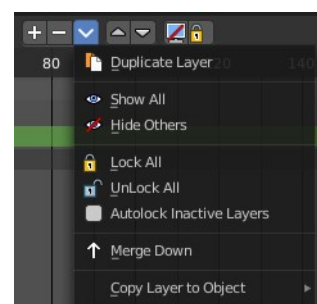

Layer Specials

A menu with grease pencil functionality.

Duplicate layer

Duplicates the currently selected grease pencil layer.

Show All

Shows all hidden grease pencil layers.

Hide Others

Hides all grease pencil layers but the selected.

Lock All

Locks all grease pencil layers.

Unlock All

Unlocks all grease pencil layers.

Autolock inactive Layers

Lock automatically all layers except active one.

Merge Down

Merge the current layer with the layer below.

Copy Layer to object

Copies the grease pencil layer to another object.

Move Grease Pencil Layer upwards

Moves the grease pencil layer upwards in the hierarchy.

Move Grease Pencil Layer downwards

Moves the grease pencil layer downwards in the hierarchy.

Isolate Layer with visibility

Locks and hides the currently active grease pencil layer.

Isolate Layer without visibility

Locks the currently active grease pencil layer.

Options

Real-time Updates

When transforming keyframes then this transformation is also immediately visible in other editors.

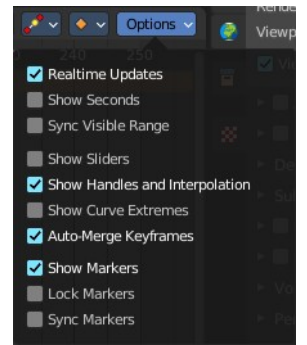

Show Seconds

Show the timing in the timeline area in seconds instead of frames.

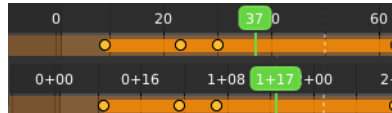

Sync visible range

Synchronize the visible timeline range with other visible time based editors. When you zoom in or out in the one editor, then it zooms in or out in the other editor too. Each editor to sync needs to have Sync Visible Range ticked.

Show Sliders

Shows the value sliders for f-curve channels in the channel list.



Show Handles and Interpolation

With this option on the keyframes shows different shapes that depends of their handle type.

With this option off all keyframes shows as diamond shape.

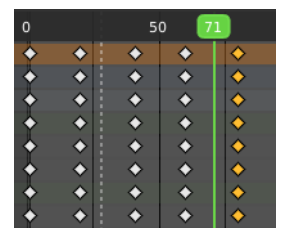
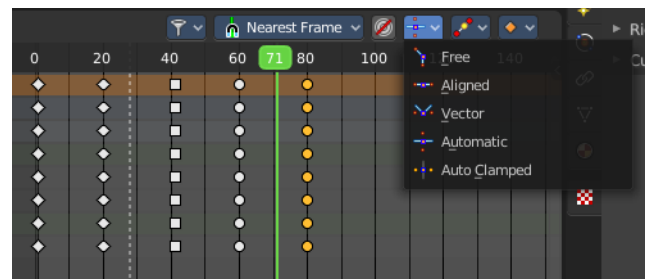

Show Curve Extremes

Shows the curve extremes at the keyframe icons.



AutoMerge Keyframes

Automatically merge nearby keyframes.

Show Markers

Display the markers row at the bottom of the view.

Lock Markers

Make the markers uneditable.

Sync Markers

Sync markers with keyframe edits. When you move the keyframes, then the markers will move too.



16.1.2 Editors - Dope Sheet - Header - Quick Menu

Table of content

- Quick Menu.....1
- Adding an operator to the Quick menu.....1
- Adding a menu to the Quick menu.....1
- Order.....2
- Removing an operator from the Quick menu.....2
- Context and mode dependent content.....2

Quick Menu

The quick menu, or in long Quick Favorites menu, is a menu that can be customized to your needs. Here you can add operators for quick access.

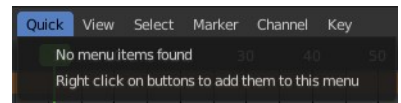

It is located in the header. But it can be called by hotkey Q directly under the mouse. This hotkey works in other editors too.

When the menu is empty, then you will see the message "No Menu Items found". This means that you first have to add some tools to the menu. It is a user configurable menu.

Note that added operators in this menu does not have icons. Just text.

Adding an operator to the Quick menu

Open the panel or the menu where your operator is that you want to add.

Let's add the open command from the File menu. Open the File menu, right click at open, and choose Add to Quick Favorites.

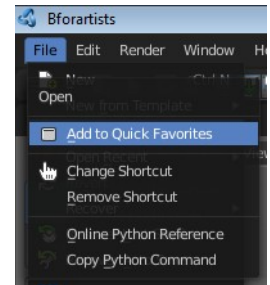

Do the same with Save As. We should now have two new menu items in the Quick menu, which you can use now.

As a rule of thumb, when the right click menu has an Add to Quick Favorites, then you can add it to the quick menu.

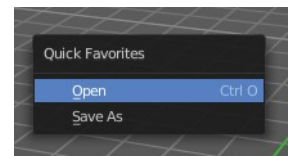

Note that you can also add operators from the tool shelf at the left. And also operators from other editor types. Some other editors have their own quick menu though. The Image Editor for example. These operators gets added in the quick menu of the image editor then. And does not show in the quick menu in the header of the 3D view.

Adding a menu to the Quick menu

It is also possible to add a menu to the Quick menu. For example the whole Add menu. The way is the same. Right click at it, and choose Add to Quick Favorites.

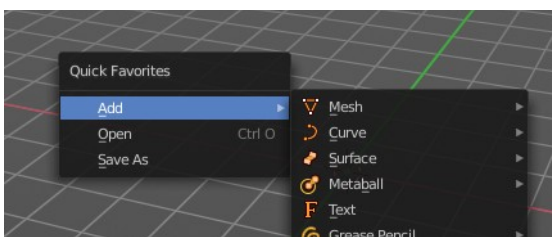
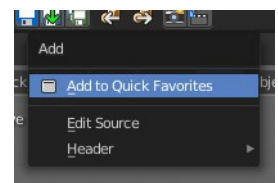

Order

You might notice that the add menu adds at the top of the menu, and not at the bottom as you would expect. First comes menus, then comes operators. And they get added in the order in which you add them.

Besides that, operators and menus gets added in the order that you add them. They cannot be sorted afterwards. So be careful how you add them. You can of course always remove operators and menus, and re-add them at the end of the list.

Removing an operator from the Quick menu

Removing is as simple as adding. Right click at the operators in the Quick menu, and choose Remove from Quick favorites.

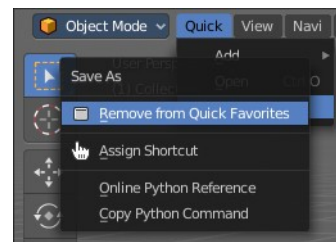

Context and mode dependent content

The quick favorites. menu exists in nearly all editors. But it is just in the 3D view available in the header. So that you know this functionality exists. In the other editors you call it with hotkey Q.

The content of the quick favorites. menu changes, dependent over which editor you are, and in what mode you are. When you add for example an operator from the image editor, then this operator just shows in the quick menu when you call the menu from the image editor. Same goes for the modes. Edit mode tools will just show in edit mode. And so on.



16.1.3 Editors - Dope Sheet - View Menu

Table of content

Dopesheet Editor - View Menu.....	1
Channels List.....	1
Sidebar.....	1
Set Preview Range.....	2
Clear Preview Range.....	2
Auto Set Preview Range.....	2
Zoom In.....	2
Zoom Out.....	2
Zoom Border.....	2
Frame All.....	3
Frame Selected.....	3
Go to current Frame.....	3
Pie menus.....	3
Area.....	3
Horizontal Split.....	3
Vertical Split.....	3
Duplicate Area into New Window.....	3
Toggle Maximize Area.....	3
Toggle Full screen Area.....	3
Close Area.....	4

Dopesheet Editor - View Menu

The View menu contains all View related tools.

The content is for all modes the same.

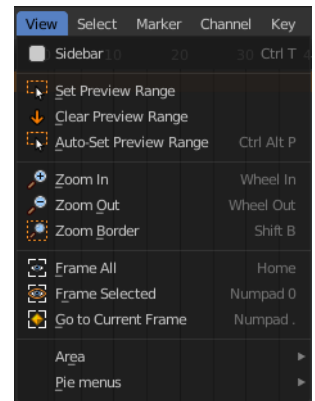

Channels List

Shows or hides the Channels list at the left in the viewport.

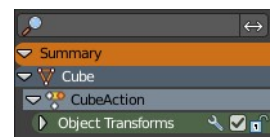

Sidebar

Shows or hides the sidebar at the right in the viewport.

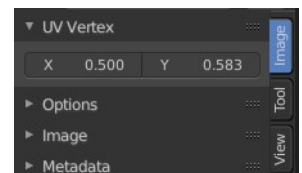

Set Preview Range

Rectangle select an area of the timeline that gets previewed. The playback now just happens in this marked area.

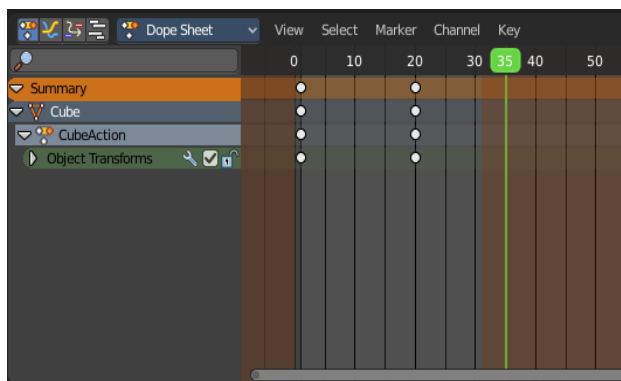
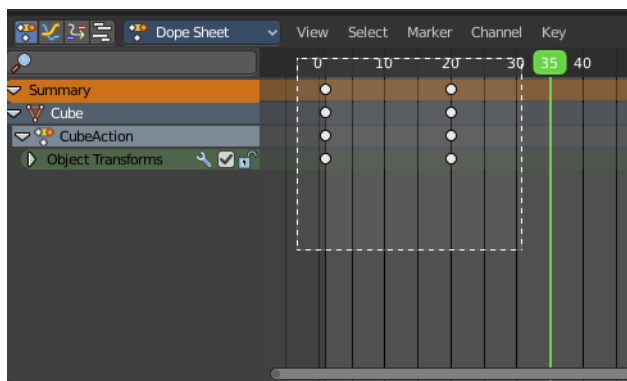

Clear Preview Range

Clears an existing preview range.

Auto Set Preview Range

Sets the preview range between the first and last keyframe of the animation.

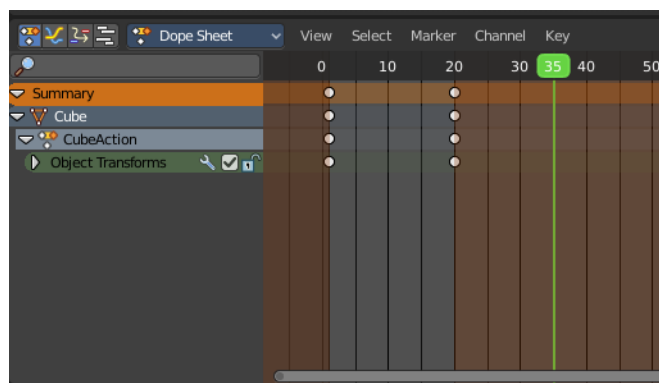

Zoom In

Zooms into the viewport.

Zoom Out

Zooms out of the viewport.

Zoom Border

Draws a rectangle and zooms then to fit the size of this rectangle.

Zooming in is done with drawing the rectangle with left mouse button. Zooming out is done with drawing the rectangle with middle mouse button.

Frame All

Zooms in or out in the viewport until all objects in the scene are displayed fitting in the viewport.

Frame Selected

Centers the view at the currently selected keyframe(s).

Go to current Frame

Centers the view at the frame slider.

Pie menus

Lists the available pie menus, and gives you the ability to read the hotkeys and assign own hotkeys.



Area

This menu contains general view functionality. And exists in most other editor types too.

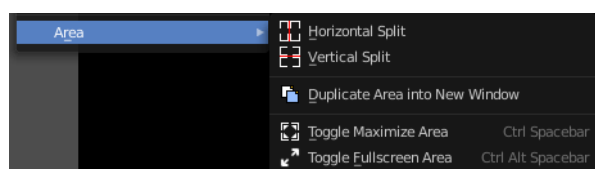

Horizontal Split

Splits the current view horizontally into two independent editor windows.

Vertical Split

Splits the current view vertically into two independent editor windows.

Duplicate Area into New Window

Duplicate Area into New Window makes the selected editor window floating. You can then drag it around at the monitor. It is not connected with the rest of the UI anymore.

A separated window cannot be merged into the main window again. You have to close it when not longer needed.

Toggle Maximize Area

Displays the editor maximized with menus.

To return from the maximized view press hotkey ctrl + spacebar. Or reuse the menu item in the area menu.

Toggle Full screen Area

Displays the editor maximized without menus.

To return from the full screen view press hotkey ctrl + alt + spacebar.

Close Area

Closes the area window.

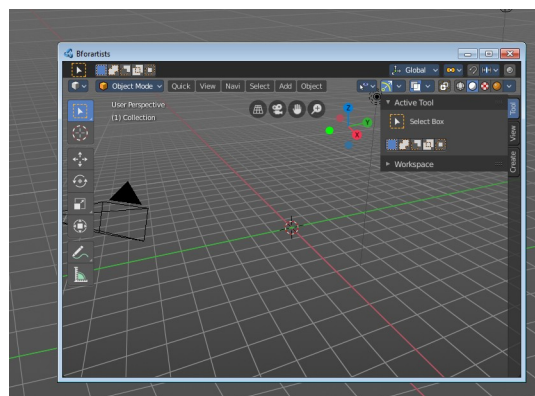



16.1.4 Editors - Dope Sheet - Select Menu

Table of content

Dopesheet Editor - Select Menu.....	1
All.....	1
None.....	1
Inverse.....	1
Box Select.....	1
Box Select(Axis Range).....	2
Circle Select.....	2
Columns on Selected Keys.....	2
Columns on Current Frame.....	2
Columns on Selected Markers.....	2
Between Selected Markers.....	2
Linked.....	2
Before current Frame.....	2
After current Frame.....	2
More.....	3
Less.....	3

Dopesheet Editor - Select Menu

The Select menu contains various tools to select elements.

The content is the same in all modes. With one exception. Grease Pencil mode is missing the More / Less menu items.

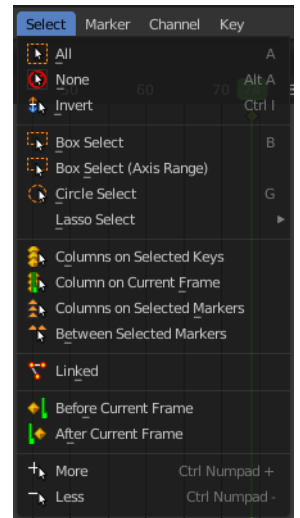

All

Select everything.

None

Select nothing.

Inverse

Invert the current selection.

Box Select

Box select enters the Border Select mode. Select elements by dragging a rectangle around it. Just what's inside of the rectangle gets selected then.

It adds to selection by default. To subtract from selection hold down Shift key.

The selection gets applied when you release the mouse. You leave the mode automatically when you release the

mouse.

Box Select(Axis Range)

Box select enters the Border Select mode. Select elements by dragging a rectangle around it. And what's inside the horizontal range of the rectangle gets selected then. Even when the keyframes are outside of the rectangle.

It adds to selection by default. To subtract from selection hold down Shift key.

The selection gets applied when you release the mouse. You leave the mode automatically when you release the mouse.

Circle Select

Circle select enters the Circle Select mode. This is a special select mode where you can select elements by moving with the mouse over it. It adds to selection by default.

To subtract from selection hold down Shift key. To exit the Circle select click with the right mouse button.

The pencil radius of the circle select tool can be adjusted with the scroll wheel.

Lasso Select

A sub menu with the available lasso select modes.

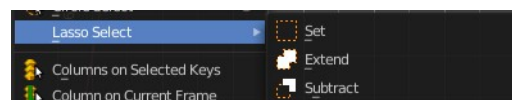

Columns on Selected Keys

Select the keyframes in the columns of the currently selected keyframe.

Columns on Current Frame

Select the keyframes in the columns of the current frame.

Columns on Selected Markers

Select the keyframes in the columns of the selected markers.

Between Selected Markers

Select the keyframes between the selected markers. You need to have markers in the view for this feature.

Linked

Select all UV vertices linked to the active UV map. The previous selection gets cleared.

Before current Frame

Select the keyframes before the current frame.

After current Frame

Select the keyframes after the current frame.

More

Grow the selection.

Less

Shrink the selection.



16.1.5 Editors - Dope Sheet - Marker Menu

Table of content

Dopesheet Editor - Marker Menu.....	1
Add Marker.....	1
Duplicate Marker.....	1
Duplicate Marker to Scene.....	1
Delete Marker.....	2
Bind Camera to Markers.....	2
Rename Marker.....	2
Grab/Move Marker.....	2
Jump to Next Marker.....	2
Jump to Previous Marker.....	2

Dopesheet Editor - Marker Menu

Markers are visual landmarks. They can mark a start of a specific animation sequence, the end of a camera movement, and so on.

When you add one then a marker area appears at the bottom of the timeline.

Markers can be pulled around by clicking at them and dragging them left or right. The active marker is yellow.

By holding down shift you can select more than one marker.

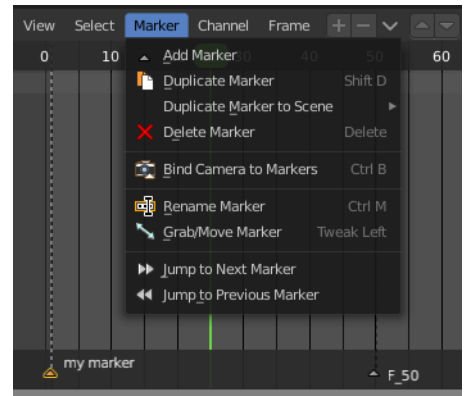

Add Marker

Adds a marker at the current frame position

Duplicate Marker

Duplicates the selected marker(s). The duplicate(s) sticks at the mouse until you click to give it the target destination.

Duplicate Marker to Scene

Duplicate markers to other scenes. A blend file can contain more than one scene. See Scene Properties in the Properties editor.

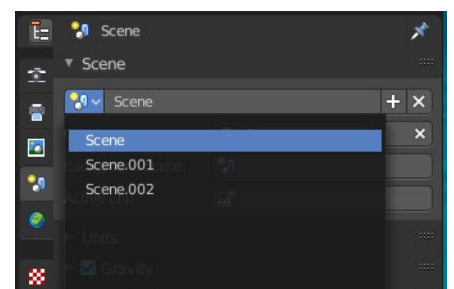
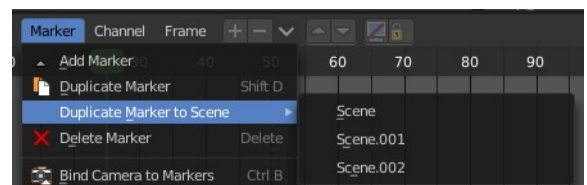

Delete Marker

Deletes the selected marker(s).

Bind Camera to Markers

Bind camera to markers turns an object into a camera object. This can be any object in the scene. Not just camera objects.

When the current frame position does not have a marker yet, then it creates a marker at the current frame position.

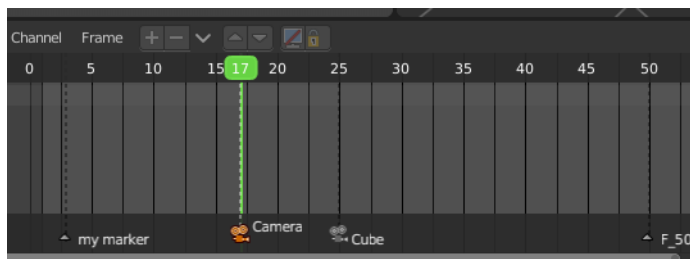

By binding different objects or cameras at different marker locations you can switch cameras automatically.

The marker with a bind camera attached will show a camera icon.

Rename Marker

A menu will open up where you can rename the active marker.



Grab/Move Marker

Hotkey only functionality! This menu item exists to show the hotkey to move the marker.

Jump to Next Marker

Sets the frame position to the next marker.

Jump to Previous Marker

Sets the frame position to the previous marker.



16.1.6 Editors - Dope Sheet - Channel Menu

Table of content

Dopesheet Editor - Channel Menu.....	1
Channel Menu - Dope sheet + Action Editor mode.....	1
Delete Channels.....	1
Group Channels.....	1
Ungroup Channels.....	2
Channel Settings.....	2
Toggle Channel Editability.....	2
Extrapolation Mode.....	2
Constant Extrapolation.....	2
Linear Extrapolation.....	2
Make Cyclic.....	3
Clear Cyclic.....	3
Expand Channels.....	3
Collapse Channels.....	3
Move.....	3
Revive Disabled F-Curves.....	3
Frame Selected Channels.....	3
Channel Menu - Grease Pencil mode.....	3
Delete Channels.....	3
Channel Settings.....	3
Move.....	4

Dopesheet Editor - Channel Menu

This menu contains functionality to manage the channels in the channels list at the left.

The menu doesn't exist in all modes. It exists in Dope sheet, Action Editor and Grease Pencil mode. And has different content.

Channel Menu - Dope sheet + Action Editor mode

Delete Channels

Deletes the selected channels and all its keyframes.

Group Channels

Creates a custom group from the selected channels.

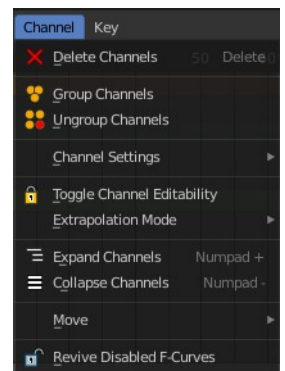

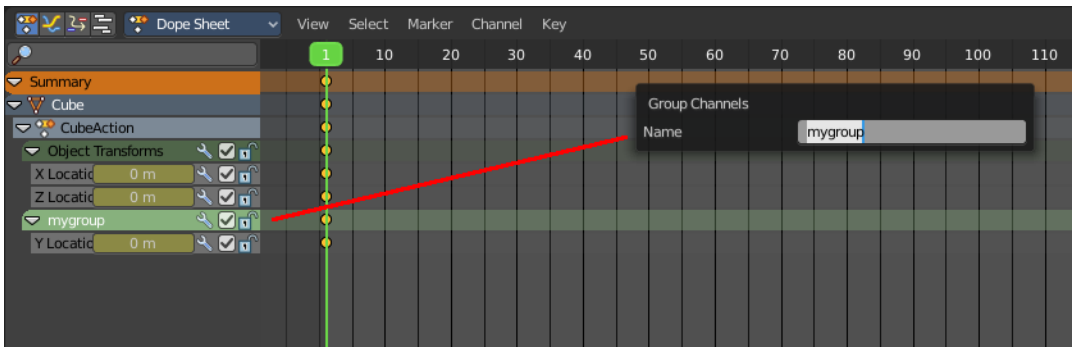

Ungroup Channels

Removes the selected channels from the group, and adds them back to the original hierarchy.

Channel Settings

Adjust the locks and check boxes in the channels list from outside of the channels list for all selected elements at once. With Toggle Mute you could for example disable all selected channels at once.

The menu items should be self explaining.

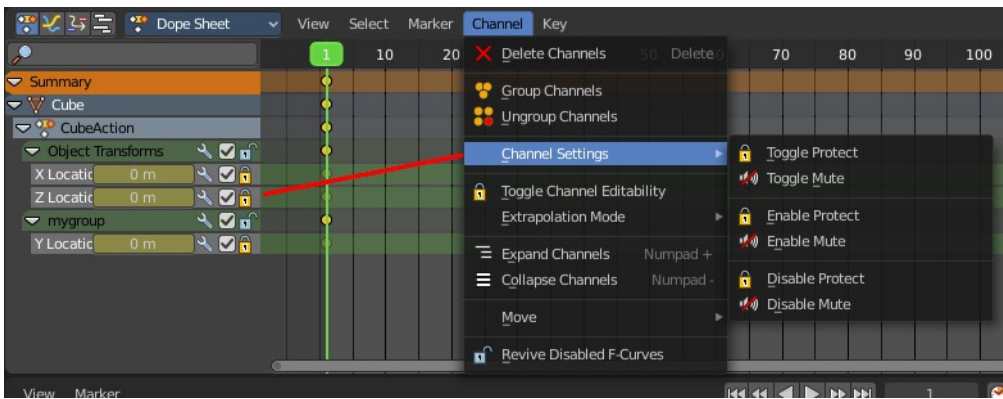

Toggle Channel Editability

Toggles the locks in the channel list from their previous state to locked and back.

Extrapolation Mode

Sets the extrapolation mode for the selected F-Curves. Means how the curve acts at the beginning and the end of the F-Curve.

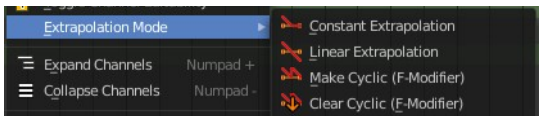

Constant Extrapolation

The animation curve continues straight at the end.

Linear Extrapolation

The animation curve continues the last direction.

Make Cyclic

Makes the animation loopable. The interpolation curves are adjusted so that the first frame fits to the last frame.

Clear Cyclic

Removes the cyclic extrapolation.

Expand Channels

Expands all channels in the channel list.

Collapse Channels

Collapses all channels in the channels list.

Move

Sort the items in the channels list.

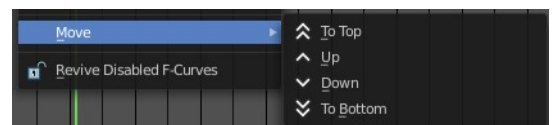

Revive Disabled F-Curves

Clears the disabled tag from all f-curves to get broken F-Curves working again.

Frame Selected Channels

Resets the viewable area to show the selected channel keyframes. This will change the zoom to fit all in the selected channel.

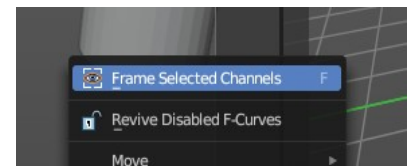

Channel Menu - Grease Pencil mode

Delete Channels

Deletes the selected channels and all its keyframes.

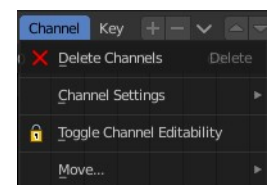

Channel Settings

Adjust the locks and check boxes in the channels list from outside of the channels list for all selected elements at once. With Toggle Mute you could for example disable all selected channels at once.

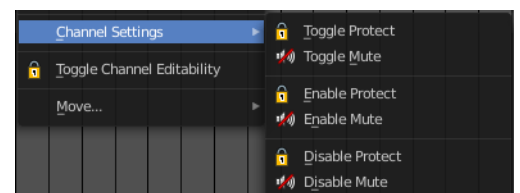

The menu items should be self explaining.

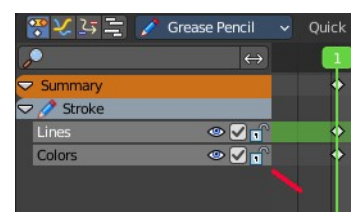

Move

Sort the items in the channels list.

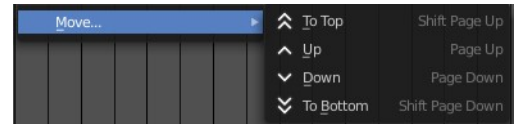



16.1.7 Editors - Dope Sheet - Key Menu

Table of content

Dopesheet Editor - Key Menu.....	1
Transform.....	2
Grab/Move.....	2
Extend.....	2
Slide.....	2
Scale.....	2
Last Operator Transform.....	2
Values.....	2
Axis.....	2
Orientation.....	2
Mirror Editing.....	2
Proportional editing.....	2
Proportional Falloff.....	2
Proportional Size.....	3
Connected.....	3
Projected(2D).....	3
Snap.....	3
Mirror.....	3
Insert Keyframes.....	3
Jump to Keyframes.....	3
Copy Keyframes.....	3
Paste Keyframes.....	3
Paste Flipped.....	3
Duplicate.....	3
Delete Keyframes.....	3
Delete Breakdowns.....	4
Clean Keyframes.....	4
Clean Channels.....	4
Sample Keyframes.....	4
Discontinuity (Euler Filter).....	4

Dopesheet Editor - Key Menu

The key menu contains functionality to manage the keyframes.

The menu exist in all modes. In Grease Pencil mode it contains not so much functionality.

The grease pencil object is a special object in this regards. It can have keyframes at an object level. And keyframes at a stroke level, which the grease pencil mode is meant for.

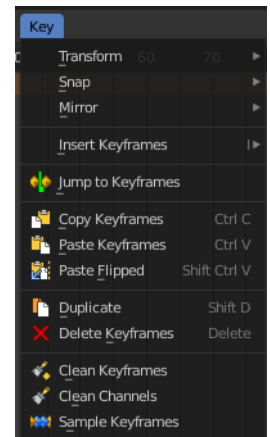
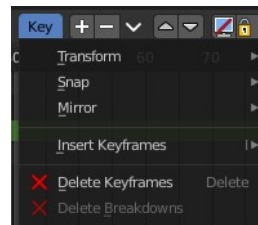

Transform

Grab/Move

Moves the selected keyframe(s).

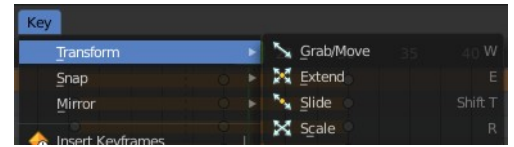

Extend

Moves the last keyframes of the selection.

Slide

Slides a selected keyframe between two other keyframes.

Scale

Scales the selected keyframes. You need to have more than one keyframe selected.

Last Operator Transform

The last operator is nearly equal for the transform operations above.

Values

The transform values.

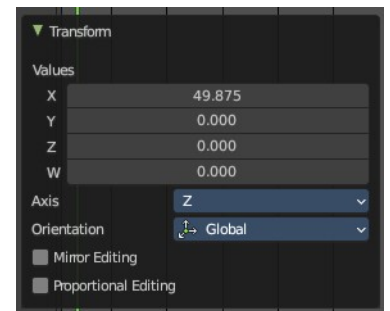

Axis

Which axis is up.

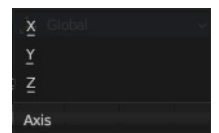

Orientation

Choose the orientation in which the transform should happen.

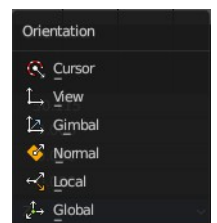

Mirror Editing

Just with Grab/Move. Allow mirror edit the transform.

Proportional editing

Enables proportional editing. Activating proportional editing reveals further settings.

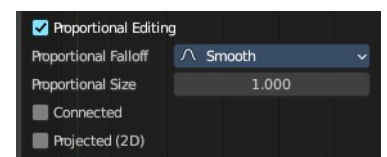

Proportional Falloff

Adjust the falloff methods.

Proportional Size

See and adjust the falloff radius.

Connected

The proportional falloff gets calculated for connected parts only.

Projected(2D)

The proportional falloff gets calculated in the screen space. Depth doesn't play a role. When it's in the radius, then it gets calculated.

Snap

Snaps the selected keyframes by the chosen method.

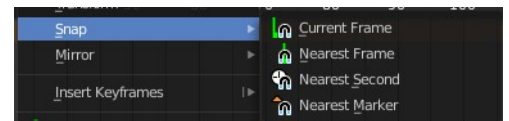

Mirror

Flips the selected keyframes over the current frame position.

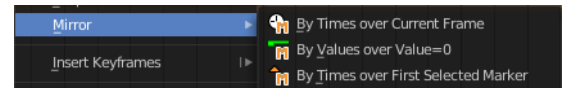

Insert Keyframes

Choose a method how to insert a new keyframe at the current frame position.

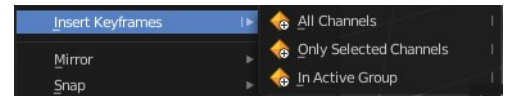

Jump to Keyframes

Sets the frame marker at the average position of the currently selected keyframes.

Copy Keyframes

Copy selected keyframes.

Paste Keyframes

Pastes copied keyframes.

Paste Flipped

Pastes copied keyframes, but flipped.

Duplicate

Duplicate selected keyframes.

Delete Keyframes

Deletes selected keyframes.

Delete Breakdowns

Remove breakdown frames generated by interpolating between two grease pencil frames.

Clean Keyframes

Simplify FCurves by deleting keyframes that are close to each other in all channels

Clean Channels

Simplify FCurves by deleting keyframes that are close to each other in selected channels.

Sample Keyframes

Adds keyframes at every unit between the selected keyframes.

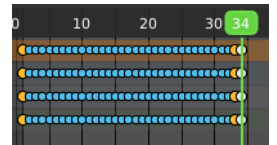

Discontinuity (Euler Filter)

Fix large jumps and flips in the selected Euler Rotation F-Curves arising from the rotation values being clipped when baking physics.

This operator only affects Euler rotation animation.



16.2 Editors - Dope Sheet - Channel list

Table of content

Dopesheet Editor - Channel List.....	1
Hotkeys.....	1
Search field.....	1
Expand / collapse triangle.....	2
Object type Icon.....	2
Channel name.....	2
Enable F-Curve Modifiers.....	2
Mute Channel.....	2
Lock Channel.....	2
Slider values.....	2
Shape key values.....	3
Opacity values.....	3
Mask Layer.....	3
Onion Skinning.....	3

Dopesheet Editor - Channel List

The channel list contains your objects and their animation channels. See also the different modes.

The channel list area can be resized by dragging the right border to left or right.

The list has several elements, to turn on or off different features, Or to expand or collapse the hierarchy.

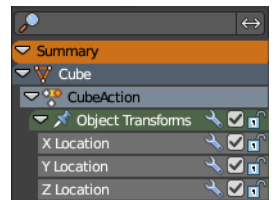

Hotkeys

Hotkey A selects all channels.

Hotkey Alt A deselects everything.

Left mouse and dragging activates box select.

Clicking at a channel selects it.

Clicking at a channel while holding down shift adds to the selection or removes from the selection.



Search field

At the top is a search field that allows you to filter the channel list by search terms.



Invert

Inverts the search result.

Expand / collapse triangle

The triangle icon at the left allows you to expand or collapse the hierarchy.

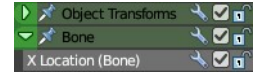

Pin

Keep the channels visible in Graph Editor for editing.

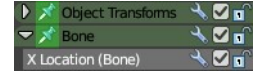

Object type Icon

This icon shows what kind of object this channel belongs to. These icons have no functionality.



Channel name

The name of the channel name and element. Some elements can be renamed. Like the action or object type.

To rename an element double click at it. Type in the new name. Then press Enter or click elsewhere.

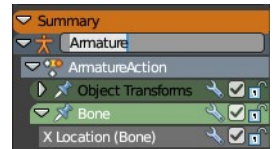

Enable F-Curve Modifiers

In the Graph editor you can add F-Curve modifiers. In the other animation editor types, like the Dope Sheet editor, you can enable or disable these modifiers by the Enable F-Curve Modifiers setting in the channel list.

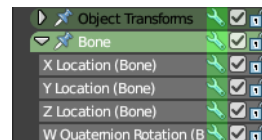

For further informations about the F-Curve modifiers see the graph editor chapters.

Mute Channel

Mutes the selected channel. It will not be calculated.

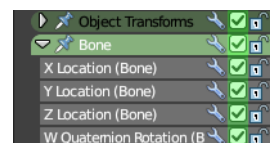

Lock Channel

Locks the selected channel. It is not longer editable.

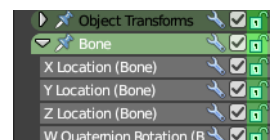

Slider values

F-Curves can show a slider value in the channel list. This can be adjusted in the sidebar in the View options panel. Show Sliders is off by default.



You can edit these values. Double click to make it editable. Enter or click elsewhere to confirm. When you confirm, then the original keyframe gets updated.

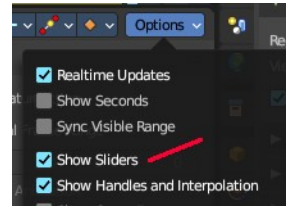

When no keyframe exists at the current position, then this keyframe gets created.

Shape key values

Shape key mode only.

In Shape key mode the channels shows the blend value. You can also edit it. Double click to make it editable. Enter or click elsewhere to confirm. When you confirm, then the original keyframe gets updated.

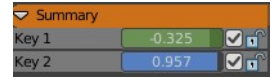

When no keyframe exists at the current position, then this keyframe gets created.

Opacity values

Grease Pencil only.

In Grease Pencil mode the channels shows the opacity values. You can also edit it. Double click to make it editable. Enter or click elsewhere to confirm. When you confirm, then the original keyframe gets updated.

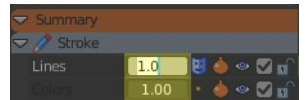

When no keyframe exists at the current position, then this keyframe gets created.

Mask Layer

Grease Pencil only.

Mask pixels from underlying drawing layers.

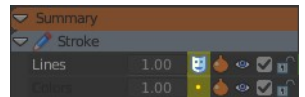

Onion Skinning

Grease Pencil only.

Display onion skins ghost frames from before and after the current frame.

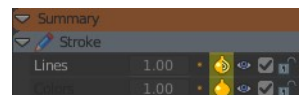



16.3 Editors - Dope Sheet - Sidebar

Table of content

Sidebar - Custom Properties.....	1
Add.....	2
Edit.....	2
Remove.....	2
Sidebar - Action panel.....	2
Manual Frame Range.....	2
Start / End.....	2
Cyclic Animation.....	2
Sidebar - Layer panel.....	2
Blend.....	2
Opacity.....	3
Use Lights.....	3
Autolock Inactive Layers.....	3
Masks.....	3
Enable.....	3
Layer Specials.....	3
Mask layer list.....	3
Layer name.....	3
Invert.....	3
Hide.....	3
Search.....	3
Invert.....	3
Resize.....	3
Adjustments.....	4
Tint color.....	4
Factor.....	4
Stroke Thickness.....	4
Pass Index.....	4
View Layer.....	4
Disallow Locked Materials Editing.....	4
Relations.....	4
Parent.....	4
Type.....	4
Display.....	4
Custom channel color.....	4
Show only on keyframed.....	4
Sidebar - Create Pose Asset panel.....	4
Create Pose Asset.....	5
Copy Pose as Asset.....	5
Convert Legacy Pose Library.....	5

Sidebar - Custom Properties

Here you can define custom properties that can be used for scripting.

Add

Adds a new property.

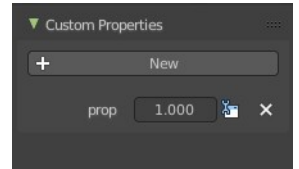

Edit

Opens a panel where you can adjust the settings for the custom property.

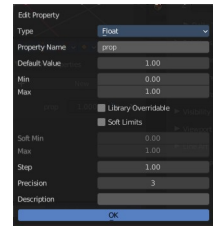

Remove

Removes the property.

Sidebar - Action panel

In Dope Sheet and Action Editor sub mode.

Manual Frame Range

Use a manual frame range.

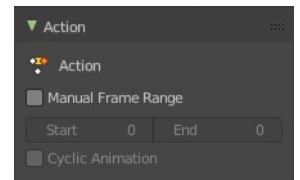
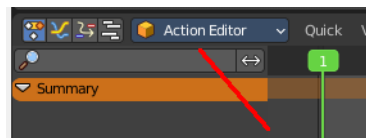

Start / End

The start and end frame of the manual range.

Cyclic Animation

If the animation in the manual frame range should cycle.

Sidebar - Layer panel

Grease Pencil mode only. This panel contains further settings for the grease pencil layers.

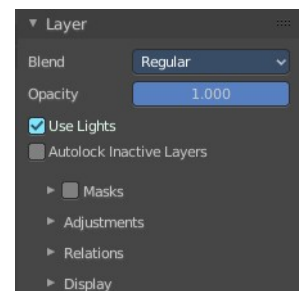

Blend

The blend mode for the current layer.

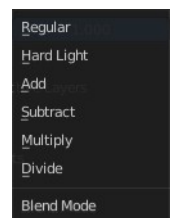

Opacity

The layer opacity.

Use Lights

Enable the use of lights on stroke and fill materials.

Autolock Inactive Layers

Lock automatically all layers except active one to avoid accidental changes.

Masks

Use masking.

Enable

Activate the use of masks. Every existing grease pencil layer can be used as mask.

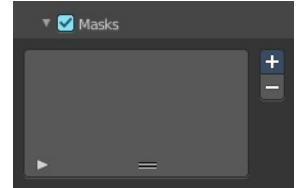

Layer Specials

Choose the grease pencil layer that you want to add and use as a mask.

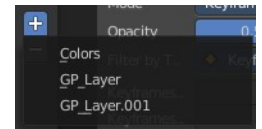

Mask layer list

The list of the mask layers.

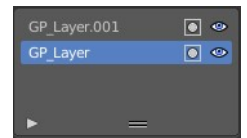

Layer name

The name of the layer. Double clicking at it enables to edit the name.

Invert

Invert the mask.

Hide

Show or hide the mask.

Search

At the end of the list you will find a search field. It can be revealed by clicking at the triangle button. Type in the term that you want to search for.



Invert

Inverts the filtering of the content.

Resize

The list can be resized by the handler with the two lines at the bottom.

Adjustments

Tint color

The color for tinting stroke colors. This prop can be animated by clicking the Animate Property button at the end.

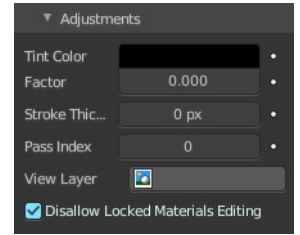

Factor

The factor for color tinting. This prop can be animated by clicking the Animate Property button at the end.

Stroke Thickness

Thickness change to apply to the current strokes in pixels. This prop can be animated by clicking the Animate Property button at the end.

Pass Index

Index number for the layer index pass. This prop can be animated by clicking the Animate Property button at the end.

View Layer

Only include layer in this View Layer render output. Leave blank to include always.

Disallow Locked Materials Editing

Avoids editing locked materials in the layer.

Relations

Parent

Parent object.

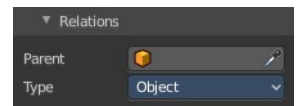

Type

The object type to parent to.

Display

Custom channel color

Give the selected channels another color in the channels list.

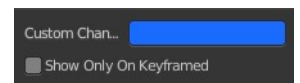

Show only on keyframed

In Paint mode display only layers with keyframe in current frame.

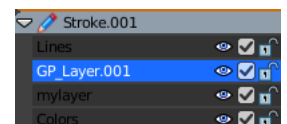

Sidebar - Create Pose Asset panel

This panel just shows when you have a armature selected and when you are in pose mode in the 3d view.

Create Pose Asset

Creates a pose asset from the selected armature in pose mode.

Copy Pose as Asset

Copies the current pose of the selected armature as an asset. You can then paste it into the asset library.

Convert Legacy Pose Library

Create a pose asset for each pose marker in the current action.

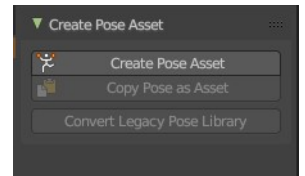



17 Editors - Timeline

Table of content

Timeline Editor.....	1
Time cursor.....	2
Keyframes.....	2
Markers.....	2
Viewport Navigation.....	3
Viewport navigation.....	3
Dope Sheet Channel Context Menu.....	3
Frame selected channels.....	4
Mute Channel.....	4
Unmute Channel.....	4
Protect Channels.....	4
Unprotect Channels.....	4
Group Channels.....	4
Ungroup Channels.....	4
Toggle Channel Editability.....	4
Extrapolation Mode submenu.....	4
Extrapolation Mode.....	4
Constant Extrapolation.....	4
Linear Extrapolation.....	4
Make Cyclic.....	5
Clear Cyclic.....	5
Expand Channels.....	5
Collapse Channels.....	5
Move submenu.....	5
Delete Channels.....	5
Dope Sheet Context Menu.....	5
Copy.....	5
Paste.....	5
Paste Flipped.....	5
Keyframe Type.....	5
Handle Type.....	6
Interpolation Mode.....	6
Easing Mode.....	6
Insert Keyframes.....	6
Duplicate.....	6
Delete Keyframes.....	6
Mirror.....	6
Snap.....	7
Slider snapping.....	7
Quick Favorites menu.....	7

Timeline Editor

The Timeline Editor is the editor type that contains playback and record elements and some further animation settings. The Timeline editor is part of five editor types that deals with your animation data.

The Dope sheet editor has several areas. Usually you will just see the header. To reveal the rest of it you have to pull the upper border of the timeline editor upwards.



Header (Green)

Channel list (Green). This channel list panel is hidden by default. You have to click at the small button up left to reveal it.

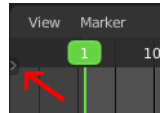

Sidebar (Blue). This Sidebar panel is hidden by default. You have to click at the small button up left to reveal it.

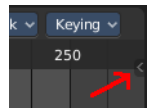

Viewport (no color)

The header is divided into three parts too. Left tools and menus. Right Options. And in the middle the playback elements for the animation.



Menus (Yellow)

Playback tools (Green)

Options (Blue)

Time cursor

The Time Cursor is the green line. It is used to set and display the current time frame.

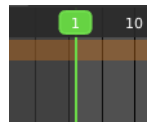

Keyframes

The timeline displays the keyframes. Different from the Dope Sheet it displays all keyframe type with one icon. A rhombus shape.

Markers

Markers are visible hints to denote frames with key points or significant events within an animation. A marker

could mark a character's animation starts, the position change of a camera, or a door that opens.

Markers can be added, deleted and renamed from the Marker menu. Once created they reside at the bottom of the viewport.

To select a marker click at it.

To move a marker click and drag.

The active marker is highlighted, and shows a dotted line upwards.

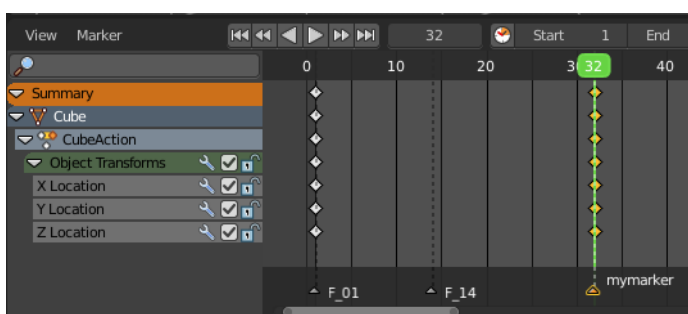

When a frame matches the marker position then the info string in the 3D view shows the name of this marker too.

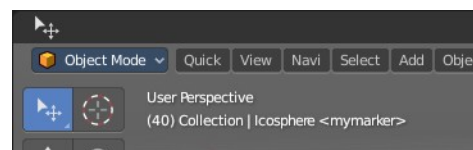

Viewport Navigation

Navigation in the viewport happens by mouse or hotkeys. Some of them does not have a menu entry. And needs to be explained here.

Viewport navigation

Right mouse button moves the frame marker.

Clicking left at the number bar moves the frame marker.

Middle mouse button pans the view.

Holding ctrl + middle mouse button zooms the view.

Scroll Wheel zooms the view.

To drag a keyframe click at it and drag the mouse.

Dope Sheet Channel Context Menu

When you right click into the channel area, then you will call the Dope Sheet Channel context menu.

Frame selected channels

Centers the selected channels in view.

Mute Channel

This channel is not calculated.

Unmute Channel

This channel is calculated.

Protect Channels

Protect channels from editing.

Unprotect Channels

Enables editing of channels again.

Group Channels

Groups channels together.

Ungroup Channels

Ungroup grouped channels. Beware, the channels will not return to their initial group.

Toggle Channel Editability

Protects or unprotects the selected channels.

Extrapolation Mode submenu

Extrapolation Mode

Sets the extrapolation mode for the selected F-Curves. Means how the curve acts at the beginning and the end of the F-Curve.

Constant Extrapolation

The animation curve continues straight at the end.

Linear Extrapolation

The animation curve continues the last direction.

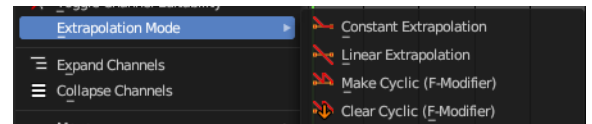
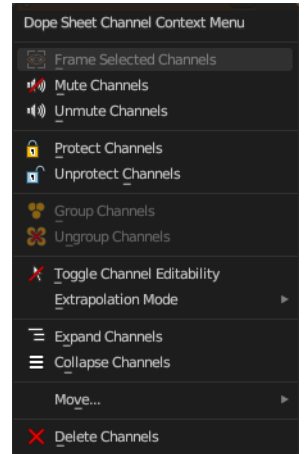

Make Cyclic

Makes the animation loopable. The interpolation curves are adjusted so that the first frame fits to the last frame.

Clear Cyclic

Removes the cyclic extrapolation.

Expand Channels

Expands the channels.

Collapse Channels

Collapses the channels.

Move submenu

Sort the order of the channels. The menu items should be self explaining.

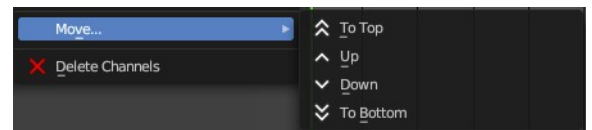

Delete Channels

Removes the selected channels.

Dope Sheet Context Menu

When you right click into the timeline viewport then you will call the Dope Sheet context menu.

Copy

Copies the currently selected keyframe(s).

Paste

Pastes copied keyframe(s)

Paste Flipped

Pastes copied keyframe(s), but flipped.

Keyframe Type

Recolor the currently selected keyframes.

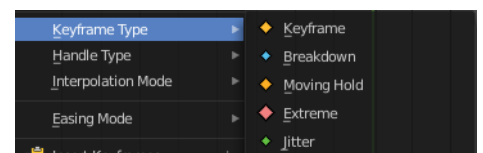
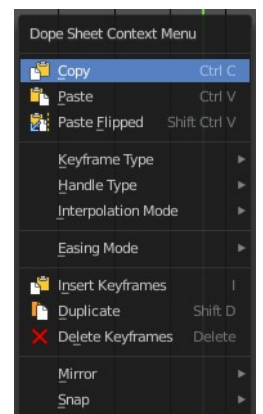

Handle Type

Set the handle type for the currently selected keyframes.

This is a feature for the Graph editor, where each curve point has its own handler with which you can influence the curve behavior. But the handler type also influences how the animation curve acts at the chosen keyframes. So it has its use in the dope sheet editor too.

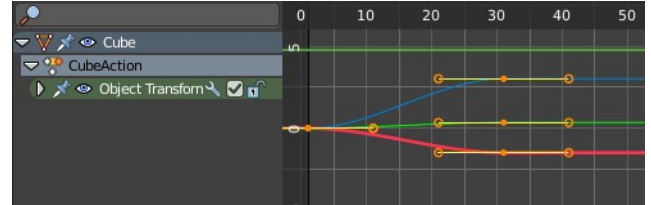
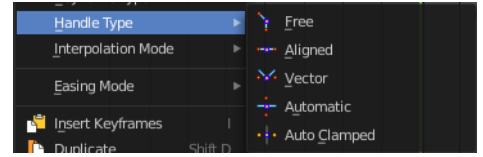

Interpolation Mode



The Interpolation mode defines how the curve acts from keyframe to keyframe. You can have a linear curve between two keyframes instead of a bent one for example.

The easing methods here in the interpolation mode menu are for the easing shape. There is also an easing menu where you can choose a easing method.

Easing Mode

The easing methods in the interpolation mode menu are for the easing shape. This menu allows you to choose an easing method.

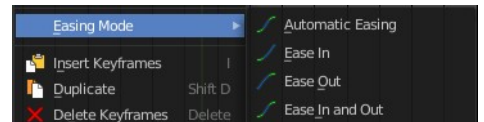

Insert Keyframes

Insert a keyframe at the current position.

Duplicate

Duplicate the selected keyframe(s).

Delete Keyframes

Delete the selected keyframe(s).

Mirror

Mirrors the animation by the given method.

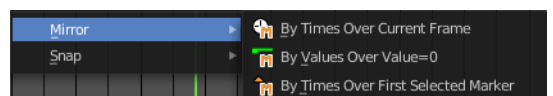

Snap

Snaps the selected keyframes by the given method.

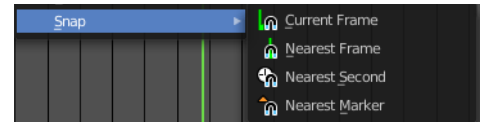

Slider snapping

Snapping also works at sliders. Hover with the mouse over the slider, start to slide, and holding down **Ctrl** will snap the sliders in incremental steps.

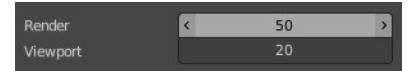

When it's a default value between 0 and 1 then it usually snaps in 0.1 steps. When it's a default value over 1 then it usually snaps in steps of 10.

The increment snapping also works at the frame slider. here the incremental snapping happens by the frame rate that you have defined. With a frame rate of 24 it will snap in steps of 24 frames when holding down ctrl.

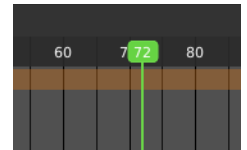

Quick Favorites menu

When you right click at a menu or a button, then a right click menu will open. Tools have usually a Add to Quick Favorites menu entry.

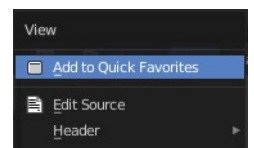

The Quick Menu is empty by default. With Add to Quick favorites you can add this menu to the Quick menu.

In the 3D view we have a menu called Quick in the header, which shows this content then. In the Dope Sheet Editor you can just call it with its hotkey. Q. It has no regular menu entry here.

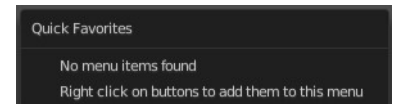



17.1.1 Editors - Timeline - Header Tools and Options

Table of content

Introduction.....	2
Playback Elements.....	2
Jump to Endpoint - start.....	2
Jump to Keyframe - previous.....	2
Play Animation - backward.....	2
Play Animation - forward.....	2
Jump to Keyframe - next.....	2
Jump to Endpoint - end.....	3
Cancel animation.....	3
Current Frame.....	3
Set Start Frame.....	3
Use Preview Range.....	3
Start.....	3
End.....	3
Set End Frame.....	3
Insert Keyframe.....	3
Delete active keying set keyframe.....	3
Active Keying Set.....	3
Auto Keying.....	4
Auto Keyframing Popover.....	4
Auto keying mode.....	4
Add & Replace.....	4
Replace.....	4
Only Active Keying Set.....	4
Layered Recording.....	4
Cycle aware keying.....	4
Active Keying Set.....	4
Playback Panel.....	5
Sync Mode.....	5
No Sync.....	5
Frame Dropping.....	5
AV Sync.....	5
Audio Scrubbing.....	5
Mute Audio.....	5
Sub frames.....	5
Limit Playback to Frame Range.....	5
Follow Current Frame.....	5
Play Animation in	5
Keying Panel.....	6
New Keyframe Type.....	6
Auto Keyframing.....	6
Auto Keying Mode.....	6
Auto Keyframe Insert Keying Set.....	6
Layered Recording.....	6
Cycle Aware Keying.....	6
Options.....	7
Only show errors.....	7

Only show selected.....	7
Show Seconds.....	7
Sync visible range.....	7
Show Markers.....	7
Lock Markers.....	7
Show Cache.....	7
Softbody, Particles, etc.....	7

Introduction

The header contains various menus and tools. This chapter here is about the tools and options elements in the header.

The text menus are covered in an own chapter each.

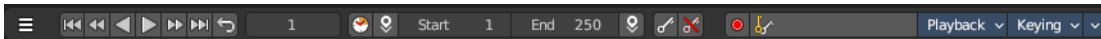

Playback Elements

The playback elements allows you to play your animation, and set the animation range.



Jump to Endpoint - start

Jumps to the first frame.

Jump to Keyframe - previous

Jumps to the keyframe before the current position.

Play Animation - backward

Plays the animation in reverse direction.

Play Animation - forward

Plays the animation.

Jump to Keyframe - next

Jumps to the keyframe after the current position.

Jump to Endpoint - end

Jumps to the last frame.

Cancel animation

Cancels the animation and returns to the original frame.

Current Frame

The edit box with the position of the current frame. Click at the value and type in another value to jump to another frame.

Set Start Frame

Sets the current frame position as the start frame.

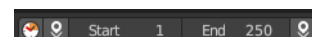

Use Preview Range

Toggle an alternative range used to preview animations. The Preview range works for the UI playback, but will not work for rendering an animation.

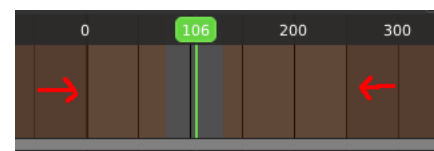

The preview range is displayed in orange color. The original playback range that is used for rendering is still displayed in grey underneath. When Use Preview Range is on, then the animation will loop between the Preview range.

Start

The start frame for the animation in current mode.

End

The end frame for the animation in current mode.

Set End Frame

Sets the current frame position as the end frame.

Insert Keyframe

Inserts a keyframe. You need to have a keying set assigned already. See Active Keying Set drop down box.

Delete active keying set keyframe

Removes the keyframe at the current position in the current active keying set.

Active Keying Set

Objects needs a so called keying set so that you can record animation for it. It is a container for the animation, a set of keyframe channels. When you try to record an animation without an existing keying set, then you will get a warning since the channels for the keyframes are missing.



In this property you can choose a method from the builtin keying sets.

Auto Keying

With auto keying on every manipulation in the 3d view will automatically create a keyframe, or update the existing keyframe at the current position.

Note that Auto Keying just works with transform properties (Objects and Bones) in the 3d View. It will not work to animate colors in the Properties Editor for example.

Auto Keyframing Popover

Auto keying settings. These settings shows when you have auto keying activated.

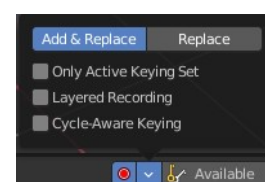

Auto keying mode

Add & Replace

Replace existing keyframes and add new ones where no keyframes exists.

Replace

Just replace existing keyframes.

Only Active Keying Set

Automatic keyframe insertion using active keying set only.

Layered Recording

Add a new nla track and strip for every loop or pass made over the animation. This allows non destructive tweaking.

Cycle aware keying

For channels with cyclic extrapolation, the keyframe insertion is automatically remapped inside the cycle time range, and keeps the ends in sync.

Active Keying Set

Choose your keying set.

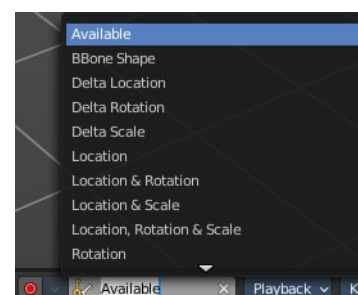

Playback Panel

Here you can find various options for playback.

Sync Mode

How to synchronize playback.

No Sync

Don't synchronize. Play every frame.

Frame Dropping

Drop frames if playback is too slow.

AV Sync

Drop frames to synchronize to Audio Playback.

Audio Scrubbing

Play existing audio from sequence editor when scrubbing.

Mute Audio

Mute existing audio from sequence editor.

Sub frames

Show current scene sub frame and allow to set it by using interface tools.

Limit Playback to Frame Range

Don't allow frame selection with the mouse outside of the play range.

Follow Current Frame

Follow current frame in editors.

Play Animation in ...

Plays the animation in the chosen editor types.

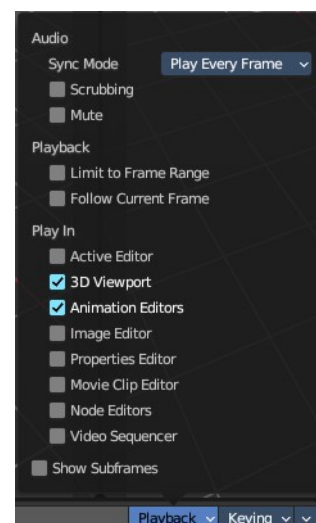
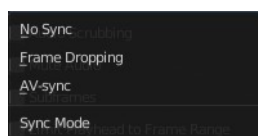

Keying Panel

Some more keying options.

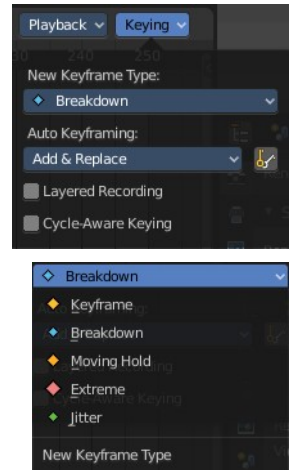

New Keyframe Type

Recolor the currently selected keyframes. Or create the next keyframe with this chosen keyframe color.

Auto Keyframing

Auto Keying Mode

Just replace existing keyframes, or add keyframes too.

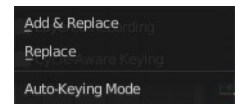

Auto Keyframe Insert Keying Set

Automatic Keyframe Insertion using the active keying set only.

Layered Recording

Add a new NLA Track and Strip for every loop/ pass made over the animation to allow non destructive tweaking.

Cycle Aware Keying

For channels with cyclic extrapolation, keyframe insertion is automatically remapped inside the cycle time range, and keeps the ends in sync.

Options

Only show errors

Only include f-curves that are disabled or have errors.

Only show selected

Just show the keyframes from the selected object.

Show Seconds

Show the timing in the timeline area in seconds instead of frames.

Sync visible range

Synchronize the visible timeline range with other visible time based editors. When you zoom in or out in the one editor, then it zooms in or out in the other editor too. Each editor to sync needs to have Sync Visible Range ticked.

Show Markers

Display the markers row at the bottom of the view.

Lock Markers

Make the markers uneditable.

Show Cache

Show animation information for cached objects like Particles.

Softbody, Particles, etc.

Include or exclude what kind of cache types you want to display.

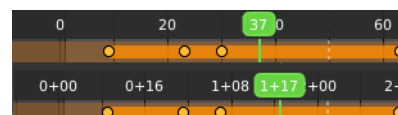
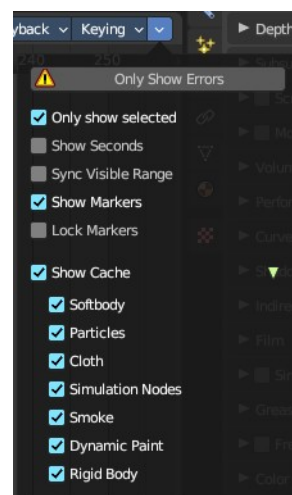



17.1.2 Editors - Timeline - View Menu

Table of content

View Menu.....	1
Sidebar.....	1
Zoom In.....	1
Zoom Out.....	1
Zoom Border.....	1
Frame All.....	1
Go to current Frame.....	2
Area.....	2
Horizontal Split.....	2
Vertical Split.....	2
Duplicate Area into New Window.....	2
Toggle Maximize Area.....	2
Toggle Full screen Area.....	2
Close Area.....	2

View Menu

The View menu contains all View related tools.

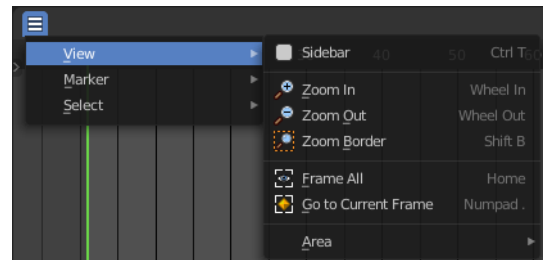

Sidebar

Shows or hides the sidebar at the right in the viewport.

Zoom In

Zooms in.

Zoom Out

Zooms out.

Zoom Border

Draw a rectangle to zoom to the selection.

Frame All

Zooms in or out in the viewport until all objects in the scene are displayed fitting in the viewport.

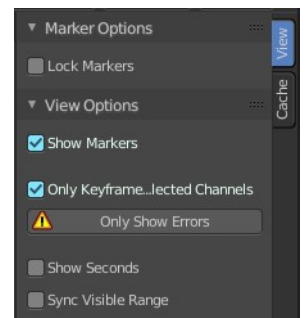

Go to current Frame

Centers the view at the frame slider.

Area

This menu contains general view functionality. And exists in most other editor types too.

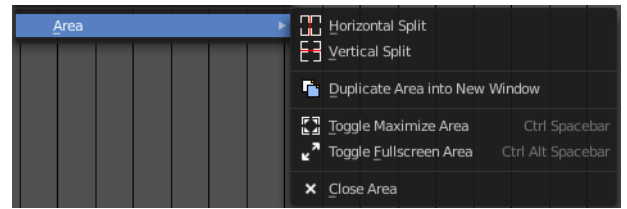

Horizontal Split

Splits the current view horizontally into two independent editor windows.

Vertical Split

Splits the current view vertically into two independent editor windows.

Duplicate Area into New Window

Duplicate Area into New Window makes the selected editor window floating. You can then drag it around at the monitor. It is not connected with the rest of the UI anymore.

A separated window cannot be merged into the main window again. You have to close it when not longer needed.

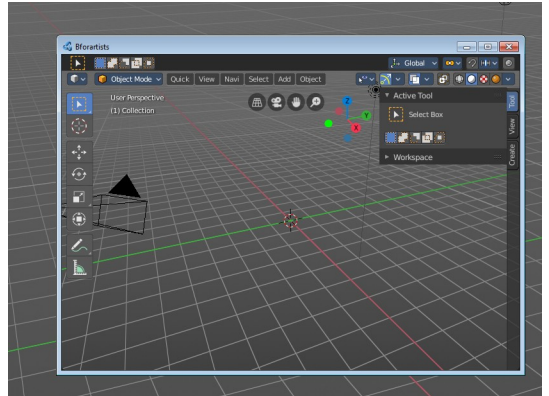

Toggle Maximize Area

Displays the editor maximized with menus.

To return from the maximized view press hotkey ctrl + spacebar. Or reuse the menu item in the area menu.

Toggle Full screen Area

Displays the editor maximized without menus.

To return from the full screen view press hotkey ctrl + alt + spacebar.

Close Area

Closes the area window.



17.1.3 Editors - Timeline - Marker Menu

Table of content

Timeline - Marker Menu.....	1
Add Marker.....	1
Duplicate Marker.....	2
Duplicate Marker to Scene.....	2
Delete Marker.....	2
Bind Camera to Markers.....	2
Rename Marker.....	2
Move Marker.....	2
Select sub menu.....	2
All.....	2
None.....	3
Invert.....	3
Before Current Frame.....	3
After Current Frame.....	3
Jump to Next Marker.....	3
Jump to Next Marker.....	3
Jump to Previous Marker.....	3

Timeline - Marker Menu

Markers are visual landmarks. They can mark a start of a specific animation sequence, the end of a camera movement, and so on.

When you add one then a marker area appears at the bottom of the timeline.

Markers can be pulled around by clicking at them and dragging them left or right. The active marker is yellow.

By holding down shift you can select more than one marker.

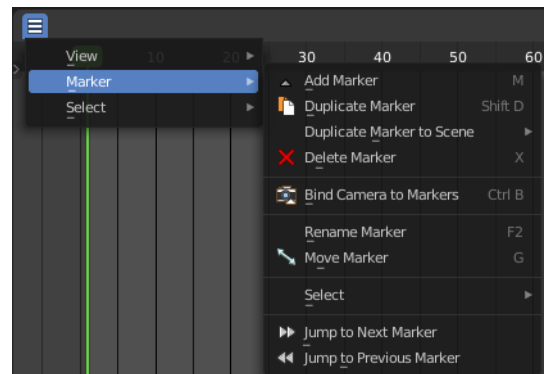

Add Marker

Adds a marker at the current frame position.

Duplicate Marker

Duplicates the selected marker(s). The duplicate(s) sticks at the mouse until you click to give it the target destination.

Duplicate Marker to Scene

A blend file can contain more than one scene. See Scene Properties in the Properties editor. Here you can duplicate markers to other scenes.

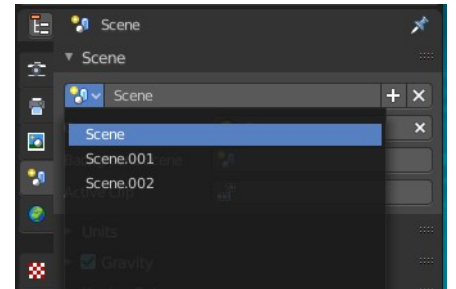
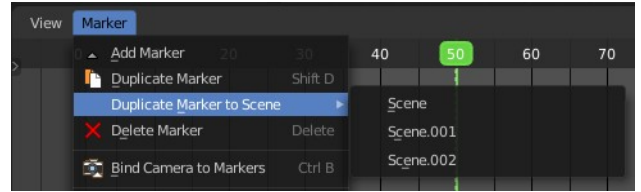

Delete Marker

Deletes the selected marker(s).

Bind Camera to Markers

Bind camera to markers turns an object into a camera object. This can be any object in the scene. Not just camera objects.

When the current frame position does not have a marker yet, then it creates a marker at the current frame position.

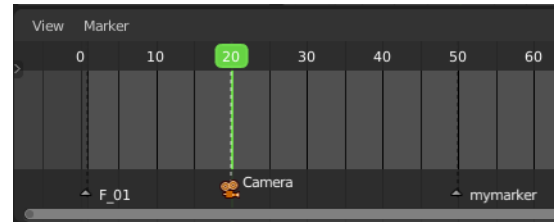

By binding different objects or cameras at different marker locations you can switch cameras automatically.

The marker with a bind camera attached will show a camera icon.

Rename Marker

A menu will open up where you can rename the active marker.

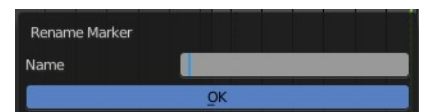

Move Marker

Hotkey only functionality! This menu item exists to show the hotkey to move the marker.

Select sub menu

All

Select all markers.

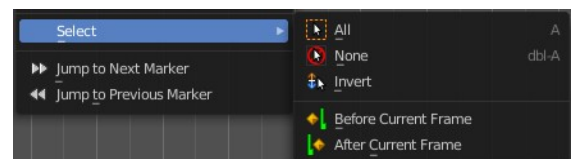

None

Deselect all markers.

Invert

Inverts the current selection.

Before Current Frame

Selects the markers before the current frame.

After Current Frame

Selects the markers after the current frame.

Jump to Next Marker

Jump to Next Marker

Sets the frame position to the next marker.

Jump to Previous Marker

Sets the frame position to the previous marker.



17.1.4 Editors - Timeline - Select Menu

Table of content

Timeline - Select Menu.....	1
All.....	1
None.....	1
Inverse.....	1
Box Select.....	1
Box Select(Axis Range).....	2
Circle Select.....	2
Lasso Select.....	2
Columns on Selected Keys.....	2
Columns on Current Frame.....	2
Columns on Selected Markers.....	2
Between Selected Markers.....	2
Linked.....	2
Before current Frame.....	2
After current Frame.....	3
More.....	3
Less.....	3

Timeline - Select Menu

The Select menu contains various tools to select elements.

All

Select everything.

None

Select nothing.

Inverse

Invert the current selection.

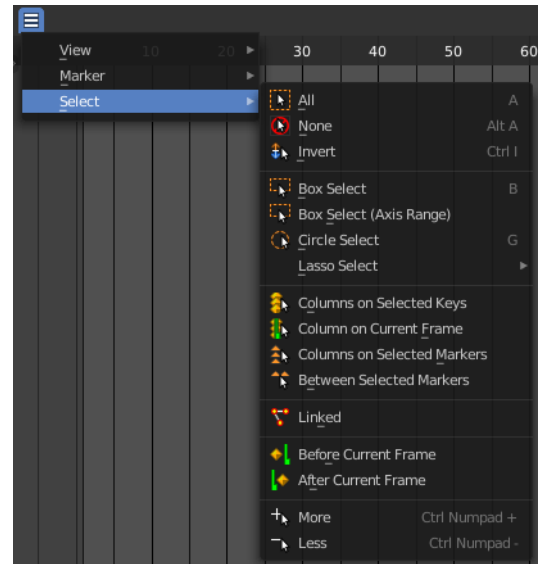

Box Select

Box select enters the Border Select mode. Select elements by dragging a rectangle around it. Just what's inside of the rectangle gets selected then.

It adds to selection by default. To subtract from selection hold down Shift key.

The selection gets applied when you release the mouse. You leave the mode automatically when you release the

mouse.

Box Select(Axis Range)

Box select enters the Border Select mode. Select elements by dragging a rectangle around it. And what's inside the horizontal range of the rectangle gets selected then. Even when the keyframes are outside of the rectangle.

It adds to selection by default. To subtract from selection hold down Shift key.

The selection gets applied when you release the mouse. You leave the mode automatically when you release the mouse.

Circle Select

Circle select enters the Circle Select mode. This is a special select mode where you can select elements by moving with the mouse over it. It adds to selection by default.

To subtract from selection hold down Shift key. To exit the Circle select click with the right mouse button.

The pencil radius of the circle select tool can be adjusted with the scroll wheel.

Lasso Select

A sub menu with the available lasso select modes.

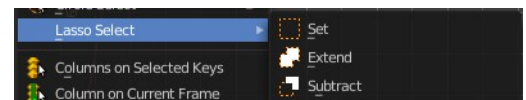

Columns on Selected Keys

Select the keyframes in the columns of the currently selected keyframe.

Columns on Current Frame

Select the keyframes in the columns of the current frame.

Columns on Selected Markers

Select the keyframes in the columns of the selected markers.

Between Selected Markers

Select the keyframes between the selected markers. You need to have markers in the view for this feature.

Linked

Select all UV vertices linked to the active UV map. The previous selection gets cleared.

Before current Frame

Select the keyframes before the current frame.

After current Frame

Select the keyframes after the current frame.

More

Grow the selection.

Less

Shrink the selection.



17.2 Editors - Timeline - Channel list

Table of content

Timeline - Channel List.....	1
Hotkeys.....	1
Search field.....	1
Expand / collapse triangle.....	2
Object type Icon.....	2
Channel name.....	2
Enable F-Curve Modifiers.....	2
Mute Channel.....	2
Lock Channel.....	2

Timeline - Channel List

The channel list contains your objects and their animation channels. It is basically the same list than the one in the dope sheet editor. The timeline has no modes like the Dope Sheet though. And so you will just see the content from the dope sheet mode. And not shape key animation or grease pencil edit mode animation for example.

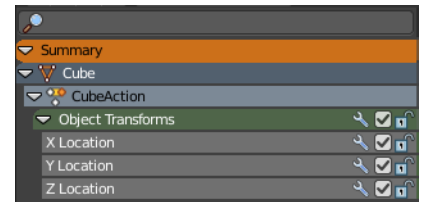

The channel list area is hidden by default. You need to reveal it by clicking at the small button up left. It can be resized by dragging the right border to left or right.

The list has several elements, to turn on or off different features, Or to expand or collapse the hierarchy.

Hotkeys

Hotkey A selects all channels.

Hotkey Alt A deselects everything.

Left mouse and dragging activates box select.

Clicking at a channel selects it.

Clicking at a channel while holding down shift adds to the selection or removes from the selection.

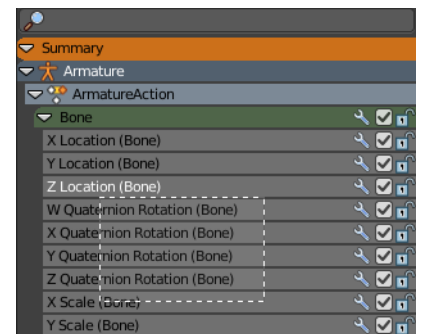

Search field

At the top is a search field that allows you to filter the channel list by search terms.

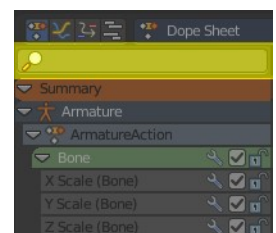

Expand / collapse triangle

The triangle icon at the left allows you to expand or collapse the hierarchy.

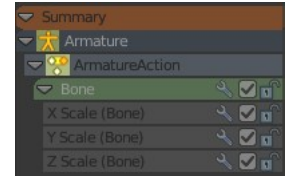
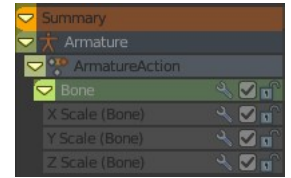

Object type icon

This icon shows what kind of object this channel belongs to. These icons have no functionality.

Channel name

The name of the channel name and element. Some elements can be renamed. Like the action or object type.

To rename an element double click at it. Type in the new name. Then press Enter or click elsewhere.

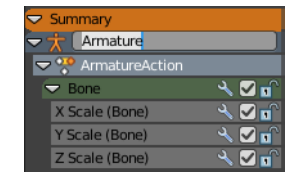

Enable F-Curve Modifiers

In the Graph editor you can add F-Curve modifiers. In the other animation editor types, like the Dope Sheet editor, you can enable or disable these modifiers by the Enable F-Curve Modifiers setting in the channel list.



For further informations about the F-Curve modifiers see the graph editor chapters.

Mute Channel

Mutes the selected channel. It will not be calculated.

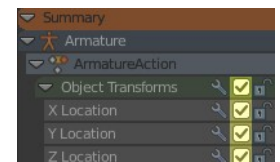

Lock Channel

Locks the selected channel. It is not longer editable.

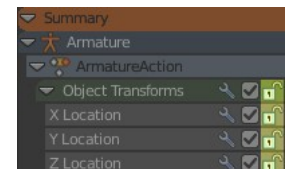



18 Editors - Graph Editor

Table of content

Graph Editor.....	3
Time cursor.....	3
F-Curves.....	3
Keyframes.....	3
Handles.....	4
Markers.....	4
Viewport Navigation.....	4
Viewport navigation.....	4
Dope Sheet Channel Context Menu.....	5
Frame selected channels.....	5
Mute Channel.....	5
Unmute Channel.....	5
Protect Channels.....	5
Unprotect Channels.....	5
Group Channels.....	5
Ungroup Channels.....	5
Toggle Channel Editability.....	5
Extrapolation Mode submenu.....	5
Extrapolation Mode.....	5
Constant Extrapolation.....	6
Linear Extrapolation.....	6
Make Cyclic.....	6
Clear Cyclic.....	6
Expand Channels.....	6
Collapse Channels.....	6
Move submenu.....	6
Delete Channels.....	6
F-Curve Context Menu.....	6
Copy.....	6
Paste.....	6
Paste Flipped.....	6
Last operator Paste Keyframes / Flipped.....	7
Offset.....	7
Type.....	7
Flipped.....	7
Handle Type.....	7
Last Operator Set Keyframe Handle Type.....	7
Type.....	7
Interpolation Mode.....	7
Last Operator Set Keyframe Interpolation.....	8
Type.....	8
Easing Mode.....	8
Last Operator Set Keyframe Easing Type.....	8
Type.....	8
Insert Keyframes.....	8
Duplicate.....	8
Last Operator Duplicate.....	8

Mode.....	8
Values X / Y.....	8
Axis.....	8
Orientation.....	8
Proportional editing.....	8
Proportional Falloff.....	9
Proportional Size.....	9
Connected.....	9
Projected(2D).....	9
Delete Keyframes.....	9
Mirror.....	9
Last Operator Mirror Keys.....	9
Type.....	9
Snap.....	9
Last Operator Snap Keys.....	9
Type.....	9
Slider snapping.....	9
Quick Favorites menu.....	10

Graph Editor

The Graph Editor allows you to adjust animation curves for your animations. So called Function curves. In short F-Curves

The Graph editor has several areas.

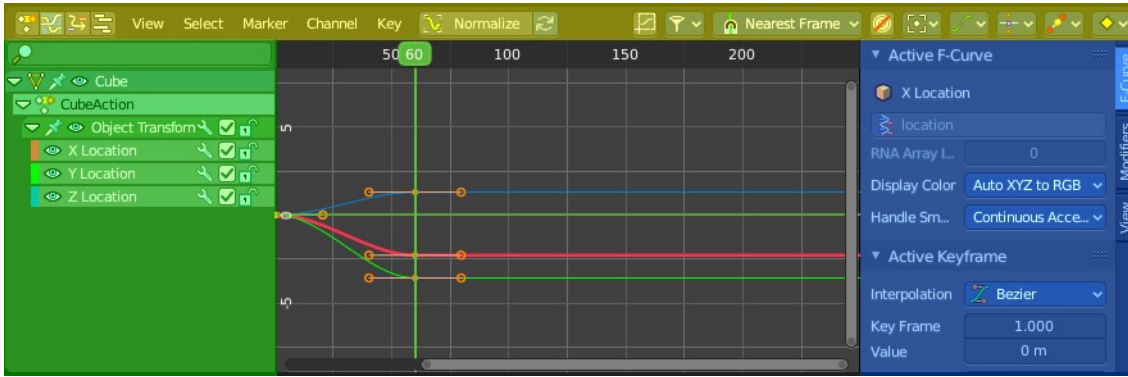

Header (Yellow)

Channel list (Green).

Sidebar (Blue).

Viewport (no color)

The header is divided into two parts. Left tools and menus. Right Options. And in the middle the playback elements for the animation.



Menus (Green)

Options (Yellow)

Time cursor

The Time Cursor is the green line. It is used to set and display the current time frame.

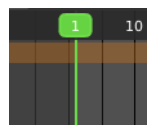

F-Curves

The timeline displays the function curves for the animation. This curve can also be manipulated in various ways.

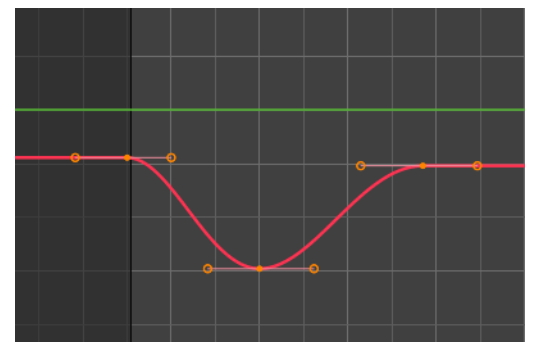

Keyframes

In the Graph editor every keyframe is represented by a dot and the handlers for it.

Handles

Every keyframe has handles assigned. The curve can be manipulated by dragging these handlers. You can also change the handle type in the Keyframe Handle Type menu in the header. To make the curve sharp at this keyframe for example.

Markers

Markers are visible hints to denote frames with key points or significant events within an animation. A marker could mark a character's animation starts, the position change of a camera, or a door that opens.

Markers can be added, deleted and renamed from the Marker menu. Once created they reside at the bottom of the viewport.

To select a marker click at it.

To move a marker click and drag.

The active marker is highlighted, and shows a dotted line upwards.

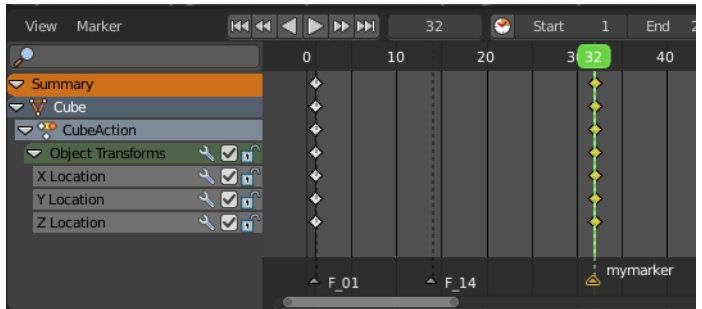

When a frame matches the marker position then the info string in the 3D view shows the name of this marker too.

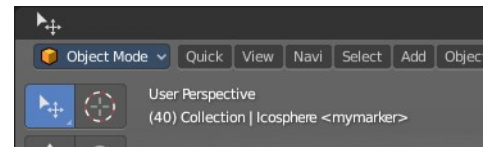

Viewport Navigation

Navigation in the viewport happens by mouse or hotkeys. Some of them does not have a menu entry. And needs to be explained here.

Viewport navigation

Right mouse button moves the frame marker.

Clicking left at the number bar moves the frame marker.

Middle mouse button pans the view.

Holding ctrl + middle mouse button zooms the view.

Scroll Wheel zooms the view.

To drag a keyframe click at it and drag the mouse.

To manipulate a keyframe, grab one of its handlers and drag.

Dope Sheet Channel Context Menu

When you right click into the channel area, then you will call the Dope Sheet Channel context menu.

Frame selected channels

Centers the selected channels in view.

Mute Channel

This channel is not calculated.

Unmute Channel

This channel is calculated.

Protect Channels

Protect channels from editing.

Unprotect Channels

Enables editing of channels again.

Group Channels

Groups channels together.

Ungroup Channels

Ungroup grouped channels. Beware, the channels will not return to their initial group.

Toggle Channel Editability

Protects or unprotects the selected channels.

Extrapolation Mode submenu

Extrapolation Mode

Sets the extrapolation mode for the selected F-Curves. Means

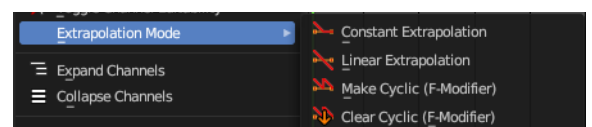
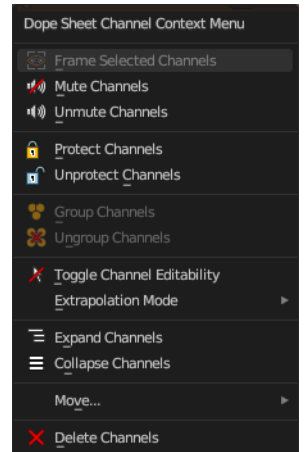

how the curve acts at the beginning and the end of the F-Curve.

Constant Extrapolation

The animation curve continues straight at the end.

Linear Extrapolation

The animation curve continues the last direction.

Make Cyclic

Makes the animation loopable. The interpolation curves are adjusted so that the first frame fits to the last frame.

Clear Cyclic

Removes the cyclic extrapolation.

Expand Channels

Expands the channels.

Collapse Channels

Collapses the channels.

Move submenu

Sort the order of the channels. The menu items should be self explaining.

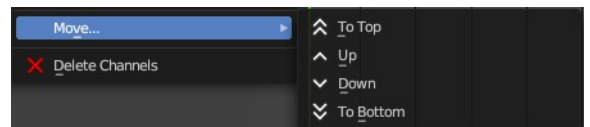

Delete Channels

Removes the selected channels.

F-Curve Context Menu

When you right click into the viewport then you will call the F-Curve context menu.

Copy

Copies the currently selected keyframe(s).

Paste

Pastes copied keyframe(s)

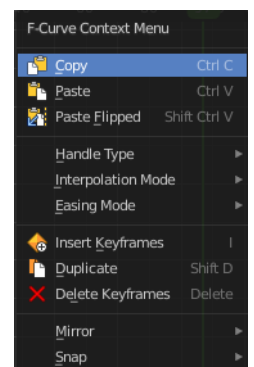

Paste Flipped

Pastes copied keyframe(s), but flipped.

Last operator Paste Keyframes / Flipped

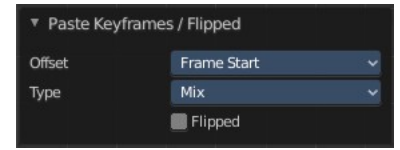

Offset

Define a time offset to paste the keys.

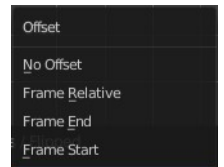

Type

The paste method.

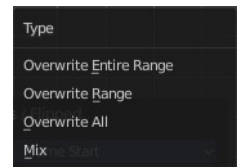

Flipped

Paste copied curve point(s) flipped.

Handle Type

Set the handle type for the currently selected keyframes.

This is a feature for the Graph editor, where each curve point has its own handler with which you can influence the curve behavior. But the handler type also influences how the animation curve acts at the chosen keyframes. So it has its use in the dope sheet editor too.

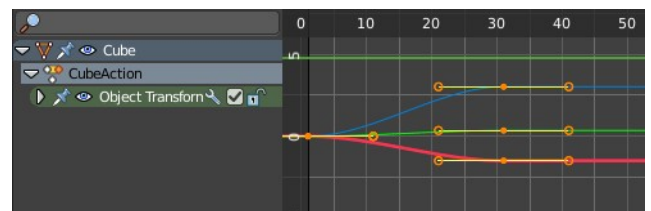
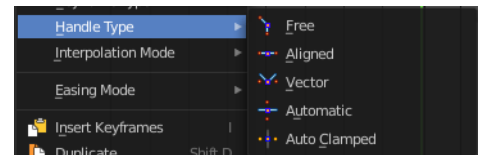

Last Operator Set Keyframe Handle Type

Type

Set the handle type for the currently selected curve point.

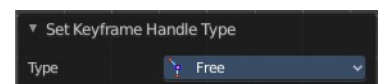

Interpolation Mode

The Interpolation mode defines how the curve acts from keyframe to keyframe. You can have

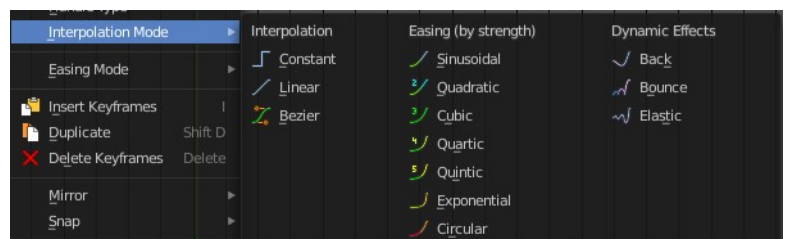

a linear curve between two keyframes instead of a bent one for example.

The easing methods here in the interpolation mode menu are for the easing shape. There is also an easing menu where you can choose a easing method.

Last Operator Set Keyframe Interpolation

Type

Set the interpolation mode.



Easing Mode

The easing methods in the interpolation mode menu are for the easing shape. This menu allows you to choose an easing method.

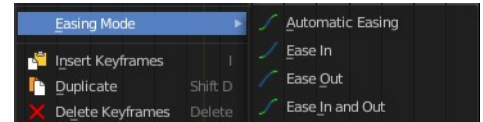

Last Operator Set Keyframe Easing Type

Type

Set the easing type.

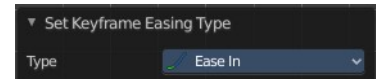

Insert Keyframes

Insert a keyframe at the current position.

Duplicate

Duplicate the selected keyframe(s).

Last Operator Duplicate

Mode

Values X / Y

The x and y values for the pasted keyframes. Note that these values starts at the position of the original copied keyframe. These values are relative.

Values Z and W have no effect here.

Axis

These values have no effect.

Orientation

These values have no effect.

Proportional editing

Enables proportional editing. Activating proportional editing reveals further settings.

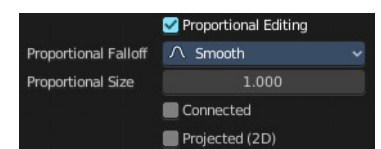
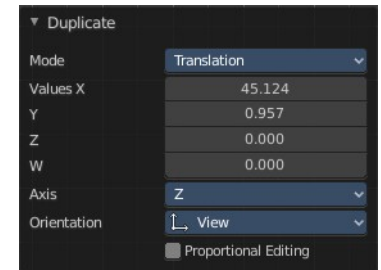

Proportional Falloff

Adjust the falloff methods.

Proportional Size

See and adjust the falloff radius.

Connected

The proportional falloff gets calculated for connected parts only.

Projected(2D)

The proportional falloff gets calculated in the screen space. Depth doesn't play a role. When it's in the radius, then it gets calculated.

Delete Keyframes

Delete the selected keyframe(s).

Mirror

Mirrors the animation by the given method.

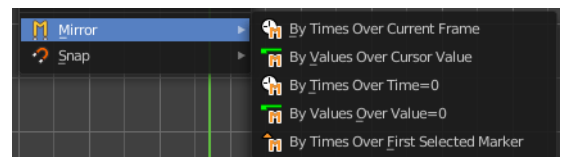

Last Operator Mirror Keys

Type

Flips the selected keyframes over the current frame position by the chosen method.

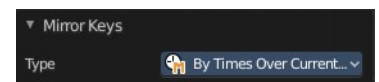

Snap

Snaps the selected keyframes by the given method.

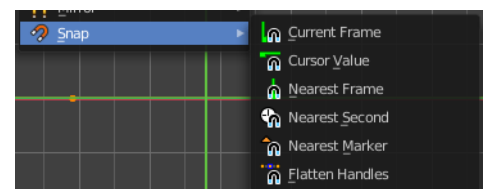

Last Operator Snap Keys

Type

Snaps the selected keyframes by the chosen method.

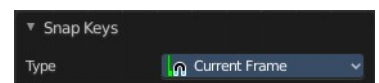

Slider snapping

Snapping also works at sliders. Hover with the mouse over the slider, start to slide, and holding down **Ctrl** will snap the sliders in incremental steps.



When it's a default value between 0 and 1 then it usually snaps in 0.1 steps. When it's a default value over 1 then it usually snaps in steps of 10.

The increment snapping also works at the frame slider. Here the incremental snapping happens by the frame rate that you have defined. With a frame rate of 24 it will snap in steps of 24 frames when holding down ctrl.

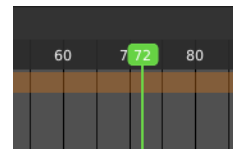

Quick Favorites menu

When you right click at a menu or a button, then a right click menu will open. Tools have usually a Add to Quick Favorites menu entry.

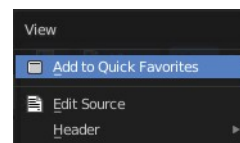

The Quick Menu is empty by default. With Add to Quick favorites you can add this menu to the Quick menu.

In the 3D view we have a menu called Quick in the header, which shows this content then. In the Dope Sheet Editor you can just call it with its hotkey. Q. It has no regular menu entry here.

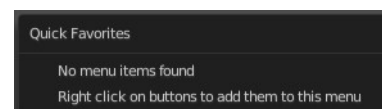



18.1.1 Editors - Graph Editor - Header tools and options

Table of content

- Introduction.....1
- Header Tabs.....2
- Use Normalization, Create Ghost Curves.....2
 - Use Normalization.....2
 - Auto Normalization.....2
 - Create Ghost Curves.....2
- Show Hide elements.....2
 - Only Show Selected.....2
 - Show Hidden.....2
 - Only Show Errors.....3
- Filters.....3
 - Filter by Collection.....3
 - Filter by Type.....3
 - Options.....3
 - Sort Data Blocks.....3
- Auto Snap.....3
- Proportional Editing.....3
- Pivot Point.....4
 - Bounding Box Center.....4
 - 2D Cursor.....4
 - Individual Centers.....4
- Easing Mode.....4
 - Easing Mode.....4
 - Last Operator Set Keyframe Easing Type.....4
 - Type.....4
- Keyframe Handle Type.....4
 - Last Operator Set Keyframe Handle Type.....5
 - Type.....5
- Keyframe Interpolation.....5
 - Last Operator Set Keyframe Interpolation.....5
 - Type.....5
- Options.....5
 - Real-time Updates.....5
 - Show Seconds.....5
 - Sync visible range.....5
 - Show Sliders.....6
 - AutoMerge Keyframes.....6
 - Use High Quality Display.....6
 - Show Extrapolation.....6
 - Show Handles.....6
 - Only selected Curve Keyframes.....6
 - Only Selected Keyframes Handles.....6
 - Show Markers.....6
 - Lock Markers.....6

Introduction

The header contains various menus and tools. This chapter here is about the tools, modes and options elements in the header.

The text menus are covered in a own chapter each. They vary too much, dependent of mode and object type.



Header Tabs

The tabs at the very left allows you to switch between the four most important editor types by one click. Dope sheet Editor, Graph Editor, Driver Editor, NLA Editor.



Use Normalization, Create Ghost Curves

Use Normalization



Normalizes the curves so that the maximum does not exceed 1 and the minimum does not go lower than -1

Auto Normalization

Automatically recalculate curve normalization when you modify the curve.

Create Ghost Curves

Creates a snapshot of the current curves, and displays it as a background image in the viewport. This background image is not permanent, and will be deleted when you close Bforartists.

When a ghost background image is created then the button turns into a delete button with which you can remove the ghost image.

Show Hide elements



Only Show Selected

Display only the data for the selected object in the list of elements. If off it displays all available animation data of the whole scene.

Show Hidden

Include channels from objects / bones that are not visible. This feature just works with Only Selected off.

Only Show Errors

Only display F-Curves and Drivers that have errors or are disabled.

Filters

The show hide elements allows you to filter out the general elements. The Filters panel allows you to filter out further elements.

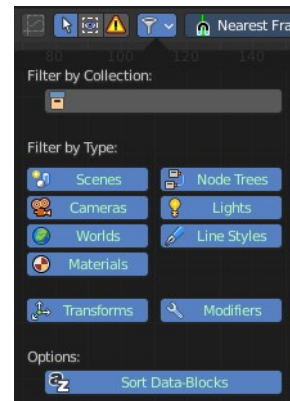

Filter by Collection

Just display the content from the chosen collection in the list of elements.

Filter by Type

In this section you can choose what type of animation data should be displayed. The names should be self explaining.

Options

Sort Data Blocks

Alphabetically sort the data in the list of elements.

Auto Snap

Adjust how the selected keyframe or fcurve point snaps to other elements.

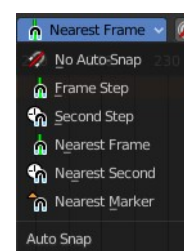

Proportional Editing

Enable proportional editing.

Proportional editing allows you for example to scale two keyframes and influence the not selected neighbor keyframes in a proportional way. Or the proportional editing of fcurve points.

The drop down menu to choose the proportional editing falloff method is just available when the proportional tool is active.

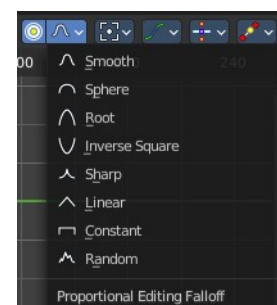

Pivot Point

The pivot point defines the center of manipulations.

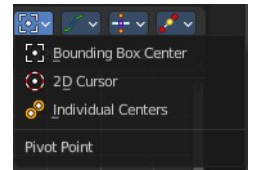

Bounding Box Center

Transformation happens around the bounding box center.

2D Cursor

Transformation happens around the timeline cursor.

Individual Centers

Transformation happens around the individual centers of the selected elements.

Easing Mode

Easing Mode

The easing methods in the interpolation mode menu are for the easing shape. This menu allows you to choose an easing method.

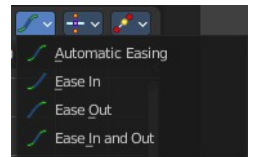

Last Operator Set Keyframe Easing Type

Type

Set the easing type.

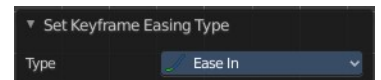

Keyframe Handle Type

Set the handle type for the currently selected keyframes.

This is a feature for the Graph editor, where each curve point has its own handler with which you can influence the curve behavior. But the handler type also influences how the animation curve acts at the chosen keyframes. So it has its use in the dope sheet editor too.

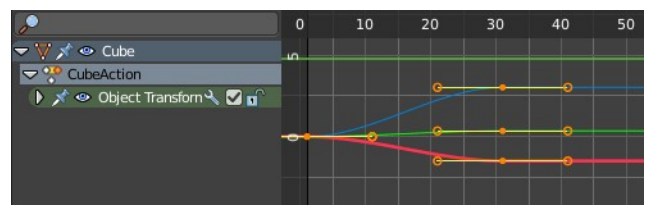
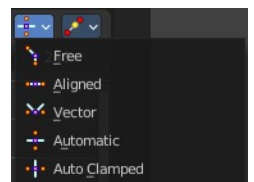

Last Operator Set Keyframe Handle Type

Type

Set the handle type for the currently selected curve point.

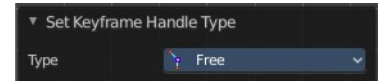

Keyframe Interpolation

The keyframe interpolation mode defines how the curve acts from keyframe to keyframe. You can have a linear curve between two keyframes instead of a bent one for example.

The easing methods here in the interpolation mode menu are for the easing shape. There is also an easing menu where you can choose a easing method.

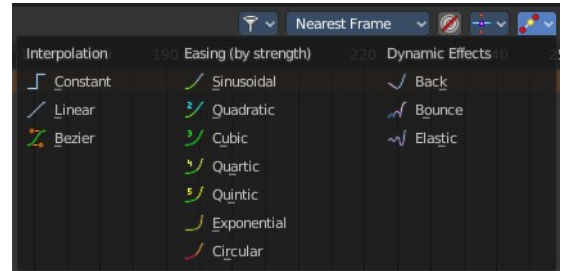

Last Operator Set Keyframe Interpolation

Type

Set the interpolation mode.



Options

Real-time Updates

When transforming keyframes then this transformation is also immediately visible in other editors.

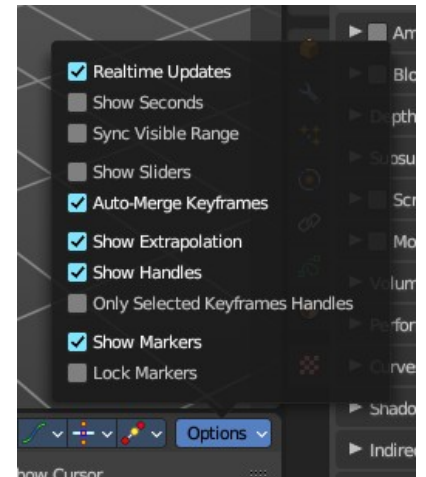

Show Seconds

Show the timing in the timeline area in seconds instead of frames.

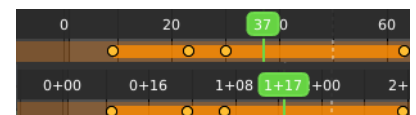

Sync visible range

Synchronize the visible timeline range with other visible time based editors. When you zoom in or out in the one editor, then it zooms in or out in the other editor too. Each editor to sync needs to have Sync Visible Range

ticked.

Show Sliders

Shows the value sliders for f-curve channels in the channel list.



AutoMerge Keyframes

Automatically merge nearby keyframes.

Show Extrapolation

Shows the curves after the last keyframe.

Show Handles

Show the handles at the keyframes.

Only Selected Keyframes Handles

Just show the handles of the keyframes from the selected curves.

Show Markers

Display the markers row at the bottom of the view.

Lock Markers

Make the markers uneditable.



18.1.2 Editors - Graph Editor - Header - Quick Menu

Table of content

Quick Menu.....	1
Adding an operator to the Quick menu.....	1
Adding a menu to the Quick menu.....	1
Order.....	2
Removing an operator from the Quick menu.....	2
Context and mode dependent content.....	2

Quick Menu

The quick menu, or in long Quick Favorites menu, is a menu that can be customized to your needs. Here you can add operators for quick access.

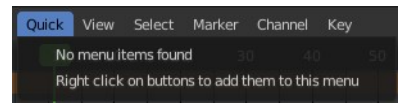

It is located in the header. But it can be called by hotkey Q directly under the mouse. This hotkey works in other editors too.

When the menu is empty, then you will see the message "No Menu Items found". This means that you first have to add some tools to the menu. It is a user configurable menu.

Note that added operators in this menu does not have icons. Just text.

Note that Graph Editor and Drivers Editor shares the same quick menu.

Adding an operator to the Quick menu

Open the panel or the menu where your operator is that you want to add.

Let's add the open command from the File menu. Open the File menu, right click at open, and choose Add to Quick Favorites.

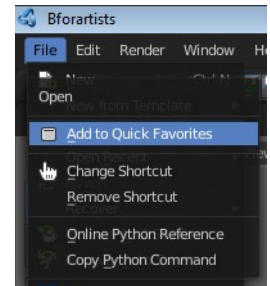

Do the same with Save As. We should now have two new menu items in the Quick menu, which you can use now.

As a rule of thumb, when the right click menu has an Add to Quick Favorites, then you can add it to the quick menu.

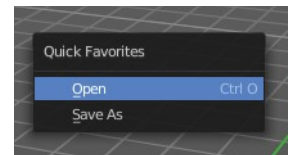

Note that you can also add operators from the tool shelf at the left. And also operators from other editor types. Some other editors have their own quick menu though. The Image Editor for example. These operators gets added in the quick menu of the image editor then. And does not show in the quick menu in the header of the 3D view.

Adding a menu to the Quick menu

It is also possible to add a menu to the Quick menu. For example the whole Add menu. The way is the same. Right click at it, and choose Add to Quick Favorites.

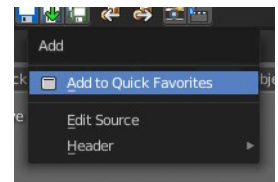

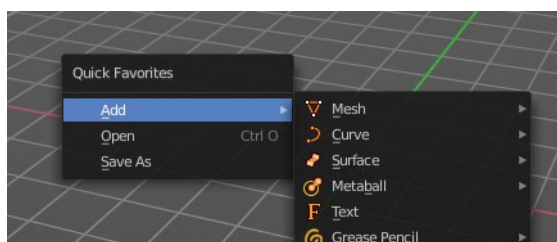

Order

You might notice that the add menu adds at the top of the menu, and not at the bottom as you would expect. First comes menus, then comes operators. And they get added in the order in which you add them.

Besides that, operators and menus gets added in the order that you add them. They cannot be sorted afterwards. So be careful how you add them. You can of course always remove operators and menus, and re-add them at the end of the list.

Removing an operator from the Quick menu

Removing is as simple as adding. Right click at the operators in the Quick menu, and choose Remove from Quick favorites.

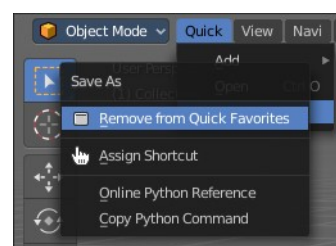

Context and mode dependent content

The quick favorites. menu exists in nearly all editors. But it is just in the 3D view available in the header. So that you know this functionality exists. In the other editors you call it with hotkey Q.

The content of the quick favorites. menu changes, dependent over which editor you are, and in what mode you are. When you add for example an operator from the image editor, then this operator just shows in the quick menu when you call the menu from the image editor. Same goes for the modes. Edit mode tools will just show in edit mode. And so on.



18.1.3 Editors - Graph Editor - View Menu

Table of content

Graph Editor - View Menu.....	1
Channels List.....	1
Sidebar.....	2
Adjust last Operation.....	2
Set Preview Range.....	2
Clear Preview Range.....	2
Auto Set Preview Range.....	2
Zoom In.....	2
Zoom Out.....	2
Zoom Border.....	3
Frame All.....	3
Frame Selected.....	3
Go to current Frame.....	3
Area.....	3
Horizontal Split.....	3
Vertical Split.....	3
Duplicate Area into New Window.....	3
Toggle Maximize Area.....	3
Toggle Full screen Area.....	3
Close Area.....	4
Pie menus.....	4

Graph Editor - View Menu

The View menu contains all View related tools.

The content is for all modes the same.

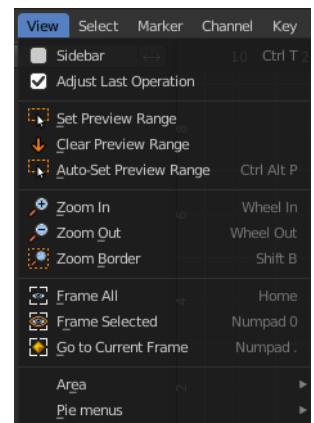

Channels List

Shows or hides the Channels list at the left in the viewport.



Sidebar

Shows or hides the sidebar at the right in the viewport.

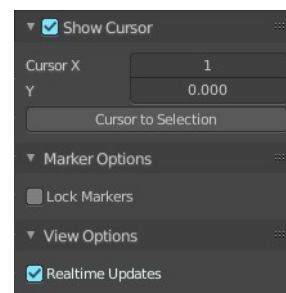

Adjust last Operation

Show the Adjust Last Operation panel down left when you perform a tool.

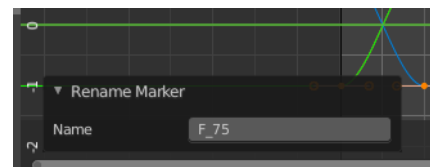

Set Preview Range

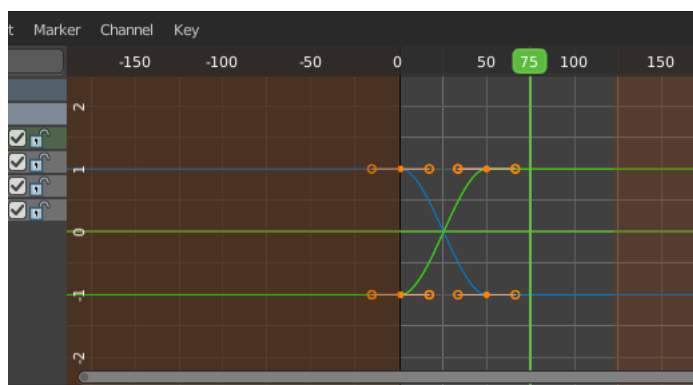
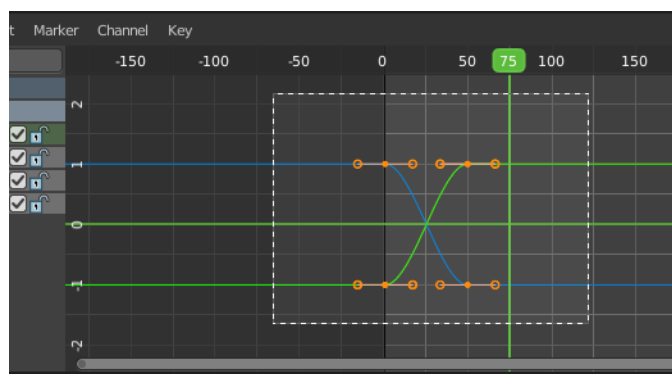

Rectangle select an area of the timeline that gets previewed. The playback now just happens in this marked area.

Clear Preview Range

Clears an existing preview range.

Auto Set Preview Range

Sets the preview range between the first and last keyframe of the animation.

Zoom In

Zooms into the viewport.

Zoom Out

Zooms out of the viewport.

Zoom Border

Draws a rectangle and zooms then to fit the size of this rectangle.

Zooming in is done with drawing the rectangle with left mouse button. Zooming out is done with drawing the rectangle with middle mouse button.

Frame All

Zooms in or out in the viewport until all objects in the scene are displayed fitting in the viewport.

Frame Selected

Centers the view at the currently selected keyframe(s).

Go to current Frame

Centers the view at the frame slider.

Area

This menu contains general view functionality. And exists in most other editor types too.

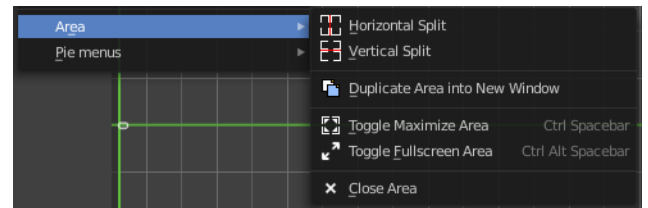

Horizontal Split

Splits the current view horizontally into two independent editor windows.

Vertical Split

Splits the current view vertically into two independent editor windows.

Duplicate Area into New Window

Duplicate Area into New Window makes the selected editor window floating. You can then drag it around at the monitor. It is not connected with the rest of the UI anymore.

A separated window cannot be merged into the main window again. You have to close it when not longer needed.

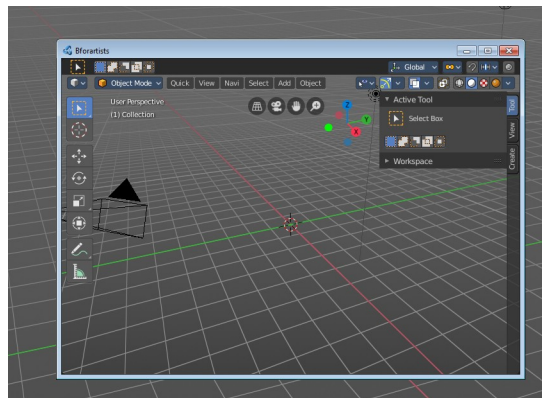

Toggle Maximize Area

Displays the editor maximized with menus.

To return from the maximized view press hotkey ctrl + spacebar. Or reuse the menu item in the area menu.

Toggle Full screen Area

Displays the editor maximized without menus.

To return from the full screen view press hotkey ctrl + alt + spacebar.

Close Area

Closes the area window.

Pie menus

Lists the available pie menus, and gives you the ability to read the hotkeys and assign own hotkeys.





18.1.4 Editors - Graph Editor - Select Menu

Table of content

Graph Editor - Select Menu.....	1
All.....	1
None.....	1
Inverse.....	2
Box Select.....	2
Box Select(Axis Range).....	2
Last Operator Box Select.....	2
Axis Range.....	2
Include Handles.....	2
Tweak.....	2
Mode.....	2
Circle Select.....	2
Lasso Select.....	3
Columns on Selected Keys.....	3
Columns on Current Frame.....	3
Columns on Selected Markers.....	3
Between Selected Markers.....	3
Last Operator Select All.....	3
Mode.....	3
Linked.....	3
Before current Frame.....	3
After current Frame.....	3
Last Operator Select Left/Right.....	3
Mode.....	3
Extend Select.....	3
More.....	4
Less.....	4

Graph Editor - Select Menu

The Select menu contains various tools to select elements.

The content is the same in all modes. With one exception. Grease Pencil mode is missing the More / Less menu items.

All

Select everything.

None

Select nothing.

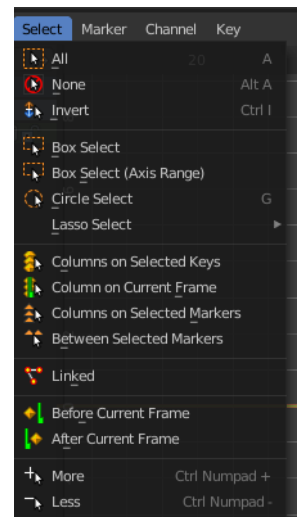

Inverse

Invert the current selection.

Box Select

Box select enters the Border Select mode. Select elements by dragging a rectangle around it. Just what's inside of the rectangle gets selected then.

It adds to selection by default. To subtract from selection hold down Shift key.

The selection gets applied when you release the mouse. You leave the mode automatically when you release the mouse.

Box Select(Axis Range)

Box select enters the Border Select mode. Select elements by dragging a rectangle around it. And what's inside the horizontal range of the rectangle gets selected then. Even when the keyframes are outside of the rectangle.

It adds to selection by default. To subtract from selection hold down Shift key.

The selection gets applied when you release the mouse. You leave the mode automatically when you release the mouse.

Last Operator Box Select

Axis Range

What's inside the horizontal range of the rectangle gets selected.

Include Handles

Also select the curve handles.

Tweak

Operator has been activated using a tweak event.

Mode

The selection mode to use.

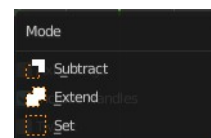
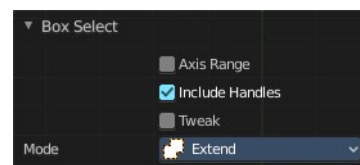

Circle Select

Circle select enters the Circle Select mode. This is a special select mode where you can select elements by moving with the mouse over it. It adds to selection by default.

To subtract from selection hold down Shift key. To exit the Circle select click with the right mouse button.

The pencil radius of the circle select tool can be adjusted with the scroll wheel.

Lasso Select

A sub menu with the available lasso select modes.

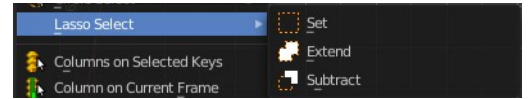

Columns on Selected Keys

Select the keyframes in the columns of the currently selected keyframe.

Columns on Current Frame

Select the keyframes in the columns of the current frame.

Columns on Selected Markers

Select the keyframes in the columns of the selected markers.

Between Selected Markers

Select the keyframes between the selected markers. You need to have markers in the view for this feature.

Last Operator Select All

Mode

The selection mode to use.

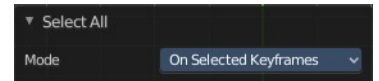

Linked

Select all UV vertices linked to the active UV map. The previous selection gets cleared.

Before current Frame

Select the keyframes before the current frame.

After current Frame

Select the keyframes after the current frame.

Last Operator Select Left/Right

Mode

The selection mode to use.

Extend Select

Extend the current selection.

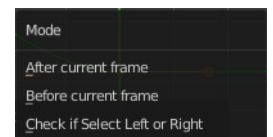
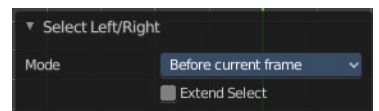

More

Grow the selection.

Less

Shrink the selection.



18.1.5 Editors - Graph Editor - Marker Menu

Table of content

Dopesheet Editor - Marker Menu.....	1
Add Marker.....	1
Duplicate Marker.....	1
Last Operator Duplicate Time Marker.....	1
Frames.....	1
Duplicate Marker to Scene.....	2
Last Operator Make Links to Scene.....	2
Scene.....	2
Delete Marker.....	2
Bind Camera to Markers.....	2
Rename Marker.....	2
Last Operator Rename Marker.....	2
Name.....	2
Grab/Move Marker.....	2
Jump to Next Marker.....	3
Jump to Previous Marker.....	3

Dopesheet Editor - Marker Menu

Markers are visual landmarks. They can mark a start of a specific animation sequence, the end of a camera movement, and so on.

When you add one then a marker area appears at the bottom of the timeline.

Markers can be pulled around by clicking at them and dragging them left or right. The active marker is yellow.

By holding down shift you can select more than one marker.

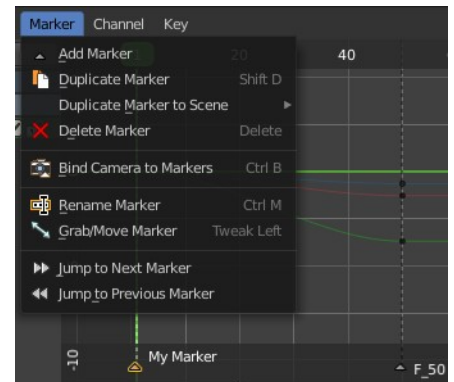

Add Marker

Adds a marker at the current frame position.

Duplicate Marker

Duplicates the selected marker(s). The duplicate(s) sticks at the mouse until you click to give it the target destination.

Last Operator Duplicate Time Marker

Frames

The target frame to position the duplicated marker.

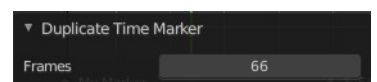

Duplicate Marker to Scene

Duplicate markers to other scenes. A blend file can contain more than one scene. See Scene Properties in the Properties editor.

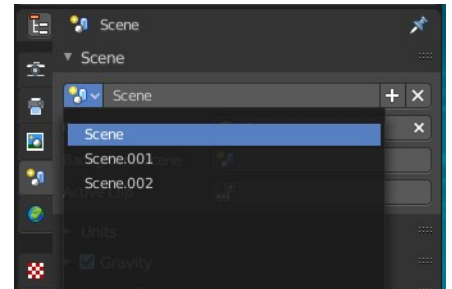
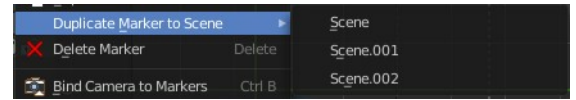

Last Operator Make Links to Scene

Scene

The target scene to duplicate the markers.

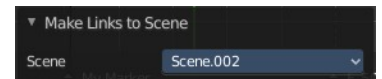

Delete Marker

Deletes the selected marker(s).

Bind Camera to Markers

Bind camera to markers turns an object into a camera object. This can be any object in the scene. Not just camera objects.

When the current frame position does not have a marker yet, then it creates a marker at the current frame position.

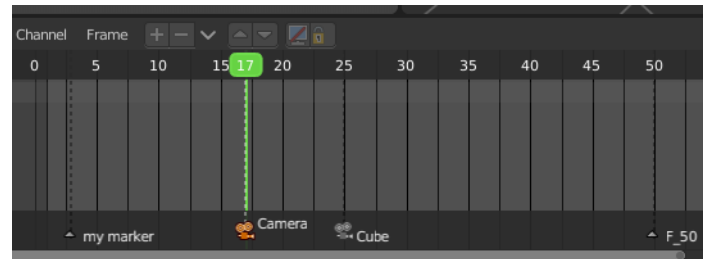

By binding different objects or cameras at different marker locations you can switch cameras automatically.

The marker with a bind camera attached will show a camera icon.

Rename Marker

A menu will open up where you can rename the active marker.

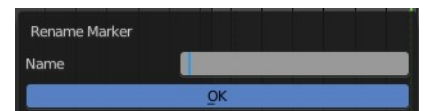

Last Operator Rename Marker

Name

Rename the active marker.

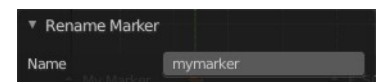

Grab/Move Marker

Hotkey only functionality! This menu item exists to show the hotkey to move the marker.

Jump to Next Marker

Sets the frame position to the next marker.

Jump to Previous Marker

Sets the frame position to the previous marker.



18.1.6 Editors - Graph Editor - Channel Menu

Table of content

Dopesheet Editor - Channel Menu.....	2
Channel Menu - Dope sheet + Action Editor mode.....	2
Delete Channels.....	2
Group Channels.....	2
Ungroup Channels.....	2
Channel Settings.....	2
Protect Channels.....	3
Unprotect Channels.....	3
Toggle Channel Editability.....	3
Last Operator Toggle Channel Settings.....	3
Type.....	3
Add F-Curve Modifier.....	3
Generator.....	4
Built-In Function.....	4
Envelope.....	4
Cycles.....	4
Noise.....	4
Limits.....	4
Stepped Interpolation.....	4
Extrapolation Mode.....	4
Constant Extrapolation.....	4
Linear Extrapolation.....	4
Make Cyclic.....	4
Clear Cyclic.....	4
Bake Sound to F-Curves.....	5
Last Operator Set Keyframe Interpolation.....	5
Type.....	5
Reveal Curves.....	5
Last Operator Reveal Curves.....	5
Select.....	5
Hide selected Curves.....	5
Hide unselected curves.....	5
Last Operator Hide Curves.....	5
Unselected.....	5
Expand Channels.....	5
Last Operator Expand Channels.....	5
All.....	5
Collapse Channels.....	5
Last Operator Collapse Channels.....	6
All.....	6
Move.....	6
Last Operator Move Channels.....	6
Direction.....	6
Frame selected Channels.....	6
Revive Disabled F-Curves.....	6
Discontinuity (Euler) Filter.....	6

Dopesheet Editor - Channel Menu

This menu contains functionality to manage the channels in the channels list at the left.

The menu doesn't exist in all modes. It exists in Dope sheet, Action Editor and Grease Pencil mode. And has different content.

Channel Menu - Dope sheet + Action Editor mode

Delete Channels

Deletes the selected channels and all its keyframes.

Group Channels

Creates a custom group from the selected channels.

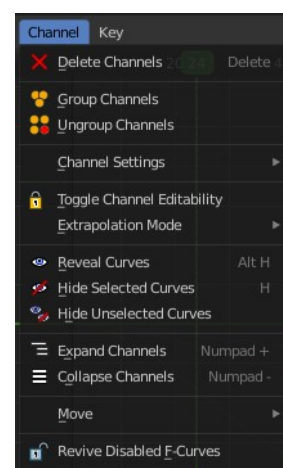
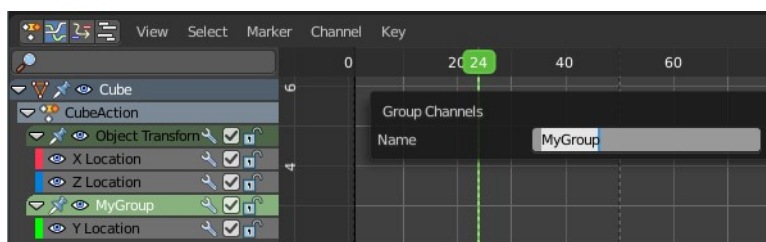

Ungroup Channels

Removes the selected channels from the group, and adds them back to the original hierarchy.

Channel Settings

Adjust the locks and check boxes in the channels list from outside of the channels list for all selected elements at once. With Toggle Mute you could for example disable all selected channels at once.

The menu items should be self explaining.

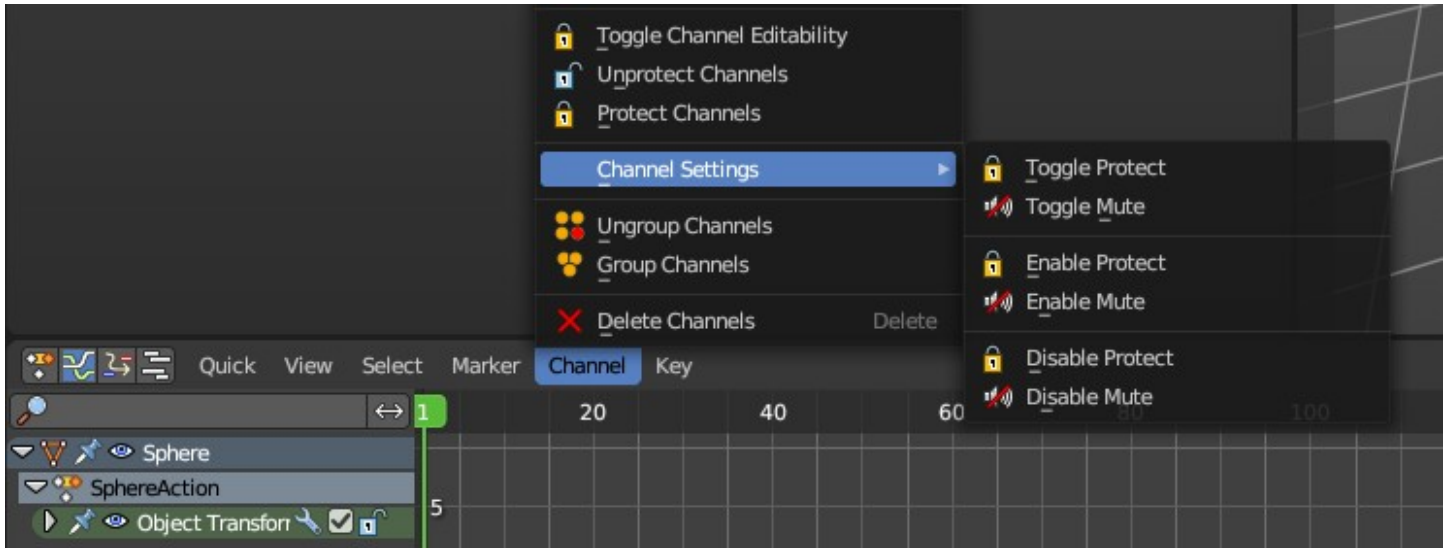

Protect Channels

This sets the editability on the selected channels to be locked. This makes sure you cannot edit these channels.

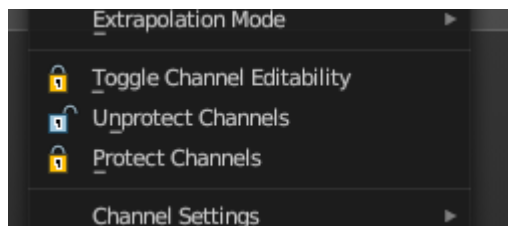

Unprotect Channels

This sets the editability on the selected channels to be unlocked. This means you can now edit them.

Toggle Channel Editability

Toggles the locks in the channel list from their previous state to locked and back. This toggles all the selected channels' editability to inverse its protected or unprotected state. This means whatever was protected, now is not protected – and whatever is unprotected is now protected. Consider this an inverse toggle.

Last Operator Toggle Channel Settings

Type

The type to toggle.

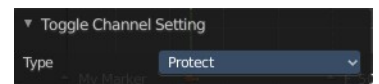

Add F-Curve Modifier

This group of operators adds modifiers to the the selected curve channel. This is useful for procedural animation. To access the modifier stack, open the Property Shelf and switch to the Modifier tab.

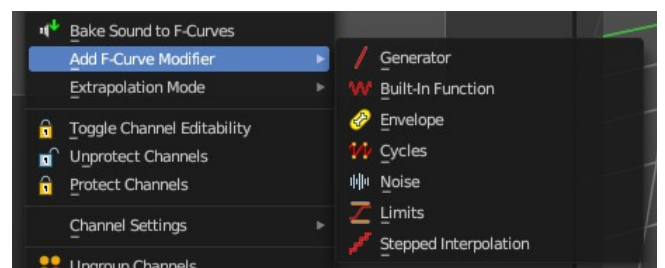

Generator

Generator creates a polynomial function. These are basic mathematical formulas that represent lines, parabolas, and other more complex curves, depending on the values used.

Built-In Function

These are additional formulas, each with the same options to control their shape.

Envelope

Allows you to adjust the overall shape of a curve with control points.

Cycles

Cycles allows you add cyclic motion to a curve that has two or more control points. The options can be set for before and after the curve.

Noise

Modifies the curve with a noise formula. This is useful for creating subtle or extreme randomness to animated movements, like camera shake.

Limits

Limit curve values to specified X and Y ranges.

Stepped Interpolation

Gives the curve a stepped appearance by rounding values down within a certain range of frames.

Extrapolation Mode

Sets the extrapolation mode for the selected F-Curves. Means how the curve acts at the beginning and the end of the F-Curve.

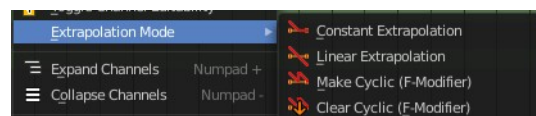

Constant Extrapolation

The animation curve continues straight at the end.

Linear Extrapolation

The animation curve continues the last direction.

Make Cyclic

Makes the animation loopable. The interpolation curves are adjusted so that the first frame fits to the last frame.

Clear Cyclic

Removes the cyclic extrapolation.

Bake Sound to F-Curves

This operator takes a sound file and uses its sound wave to create the animation data. When running it, you will be prompted to load an audio file to apply to the selected channels.

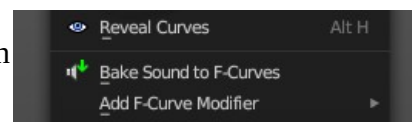

Last Operator Set Keyframe Interpolation

Type

Set the extrapolation mode for the selected F-Curves.

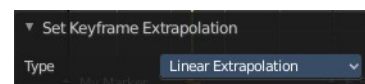

Bake Curve

Bake selected F-Curves to a set of sampled points. This makes the curve not longer editable.

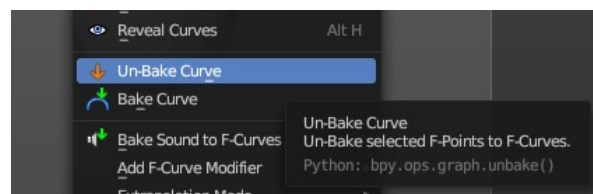

Un-Bake Curve

Un-bake a baked F-Curve to make it editable again.

Reveal Curves

Reveals all hidden curves.

Last Operator Reveal Curves

Select

Select all revealed curves.

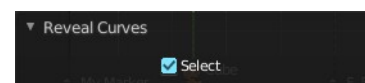

Hide selected Curves

Hides the selected curves.

Hide unselected curves

Hides the unselected curves.

Last Operator Hide Curves

Unselected

Hide the unselected or selected curves.



Expand Channels

Expands all channels in the channel list.

Last Operator Expand Channels

All

Expand all Channels, or just the selected channels.

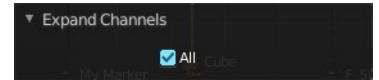

Collapse Channels

Collapses all channels in the channels list.

Last Operator Collapse Channels

All

Collapse all Channels, or just the selected channels.

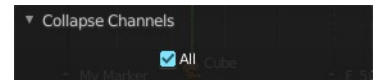

Move

Sort the items in the channels list.

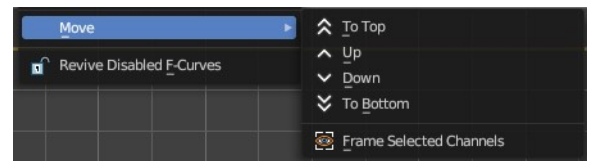

Last Operator Move Channels

Direction

Sort the items in the channels list.

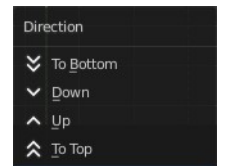
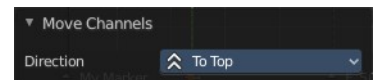

Frame selected Channels

Centers the view at the selected channels.

Revive Disabled F-Curves

Clears the disabled tag from all f-curves to get broken F-Curves working again.

Discontinuity (Euler) Filter

Try to fix large jumps and flips in the selected F Curve. This jumps can appear when rotation values are clipping by baking physics.



18.1.7 Editors - Graph Editor - Key Menu

Table of content

Graph Editor - Key Menu.....	4
Transform.....	4
Snap.....	7
Mirror.....	8
Insert Keyframes.....	8
Jump to Selected.....	9
Copy Keyframes.....	9
Paste Keyframes.....	9
Paste Flipped.....	9
Duplicate.....	9
Delete Keyframes.....	10
Decimate (Ratio).....	10
Decimate (Allowed Change).....	10
Slider Operators submenu.....	11
Clean Keyframes.....	13
Clean Channels.....	13
Smooth Keys.....	14
Sample Keyframes.....	14

Detailed table of content

Detailed table of content

Graph Editor - Key Menu.....	4
Transform.....	4
Grab/Move.....	4
Last Operator Move.....	4
Move X, Y Z.....	4
Orientation.....	4
Proportional editing.....	4
Proportional Falloff.....	5
Proportional Size.....	5
Connected.....	5
Projected(2D).....	5
Extend.....	5
Last Operator Transform.....	5
Values X, Y Z, W.....	5
Axis.....	5
Orientation.....	5
Proportional editing.....	5
Proportional Falloff.....	5
Proportional Size.....	5
Connected.....	5
Projected(2D).....	6
Rotate.....	6
Last Operator Rotate.....	6

Angle.....	6
Axis.....	6
Orientation.....	6
Proportional editing.....	6
Proportional Falloff.....	6
Proportional Size.....	6
Connected.....	6
Projected(2D).....	6
Scale.....	6
Last Operator Resize.....	7
Angle.....	7
Axis.....	7
Orientation.....	7
Proportional editing.....	7
Proportional Falloff.....	7
Proportional Size.....	7
Connected.....	7
Projected(2D).....	7
Snap.....	7
Last Operator Snap Keys.....	8
Type.....	8
Equalize Handles.....	8
Last Operator Equalize Handles.....	8
Side.....	8
Handle length.....	8
Flatten.....	8
Mirror.....	8
Last Operator Mirror Keys.....	8
Type.....	8
Insert Keyframes.....	8
Last Operator Insert Keyframes.....	9
Type.....	9
Jump to Selected.....	9
Copy Keyframes.....	9
Paste Keyframes.....	9
Paste Flipped.....	9
Last Operator Paste Keyframes / Flipped.....	9
Offset.....	9
Type.....	9
Flipped.....	9
Duplicate.....	9
Last Operator Duplicate.....	9
Mode.....	9
Values X / Y.....	9
Axis.....	10
Orientation.....	10
Proportional editing.....	10
Proportional Falloff.....	10
Proportional Size.....	10
Connected.....	10
Projected(2D).....	10
Delete Keyframes.....	10
Decimate (Ratio).....	10

Decimate (Allowed Change).....	10
Last Operator Decimate Keyframes.....	10
Mode.....	10
Remove or Max Error Margin.....	11
Slider Operators submenu.....	11
Breakdown.....	11
Last Operator Breakdown.....	11
Factor.....	11
Blend to Neighbour.....	11
Last Operator Blend to Neighbour.....	11
Blend.....	11
Blend to default Value.....	11
Last Operator Blend to Default.....	11
Factor.....	11
Ease.....	11
Ease.....	12
Last Operator Ease Keyframes.....	12
Factor.....	12
Blend to Ease.....	12
Last Operator Blend to Ease Keyframes.....	12
Curve Blend.....	12
Blend Offset.....	12
Last Operator Blend Offset Keyframes.....	12
Offset Factor.....	12
Match Slope.....	12
Last Operator Match Slope.....	13
Smooth (Gaussian).....	13
Smooth (Legacy).....	13
Butterworth Smooth.....	13
Blend to default Value.....	13
Last Operator Gaussian Smooth.....	13
Factor.....	13
Sigma.....	13
Filter width.....	13
Clean Keyframes.....	13
Clean Channels.....	13
Last Operator Clean Keyframes.....	13
Threshold.....	13
Channels.....	14
Smooth Keys.....	14
Sample Keyframes.....	14

Graph Editor - Key Menu

This menu contains functionality to manage keyframes.

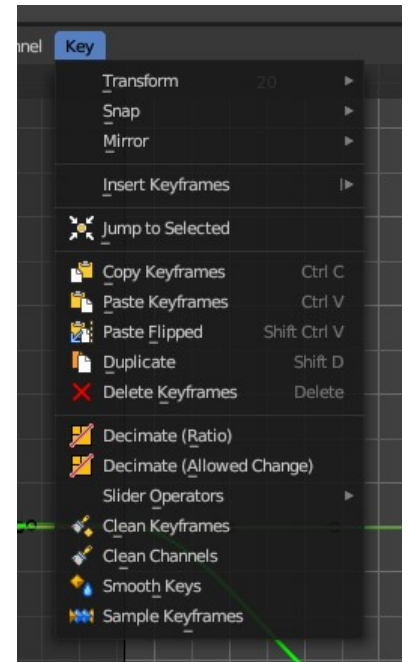

Transform

Grab/Move

Moves the selected keyframe(s).

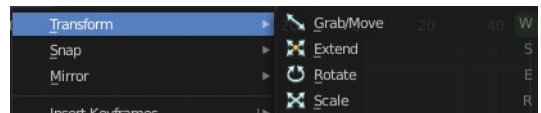

Last Operator Move

Move X, Y Z

The position. Attention, the actual world orientation and rotation does not matter here. It always starts with a value of zero, and moves relative to this zero then. For the actual location values have a look in the sidebar in the transform panel.

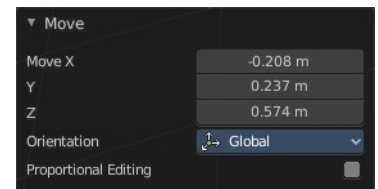

Orientation

The widget can have different orientations. The menu items should be self explaining.

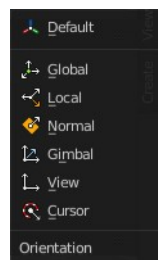

Proportional editing

Enables proportional editing. Activating proportional editing reveals further settings.

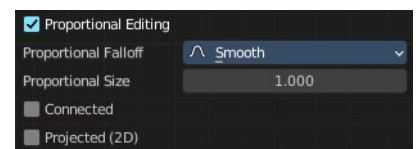

Proportional Falloff

Adjust the falloff methods.

Proportional Size

See and adjust the falloff radius.

Connected

The proportional falloff gets calculated for connected parts only.

Projected(2D)

The proportional falloff gets calculated in the screen space. Depth doesn't play a role. When it's in the radius, then it gets calculated.

Extend

Moves the last keyframes of the selection.

Last Operator Transform

Values X, Y Z, W

The new position.

Axis

Which axis to transform.

Orientation

The widget can have different orientations. The menu items should be self explaining.

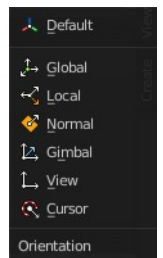
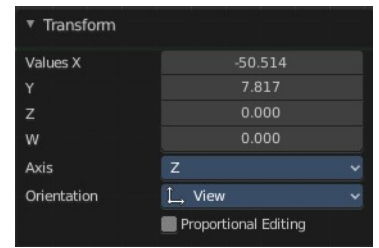

Proportional editing

Enables proportional editing. Activating proportional editing reveals further settings.

Proportional Falloff

Adjust the falloff methods.

Proportional Size

See and adjust the falloff radius.

Connected

The proportional falloff gets calculated for connected parts only.

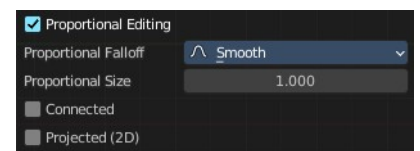

Projected(2D)

The proportional falloff gets calculated in the screen space. Depth doesn't play a role. When it's in the radius, then it gets calculated.

Rotate

Rotates the selection.

Last Operator Rotate

Angle

The rotation. Attention, the actual world orientation and rotation does not matter here. It always starts with a value of zero, and rotates relative to this zero then. For the actual rotation values have a look in the sidebar in the transform panel.

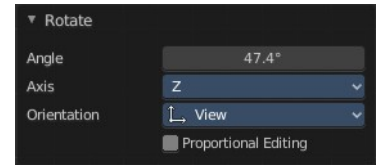

Axis

Which axis to rotate.

Orientation

The widget can have different orientations. The menu items should be self explaining.

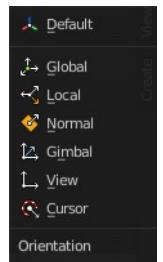

Proportional editing

Enables proportional editing. Activating proportional editing reveals further settings.

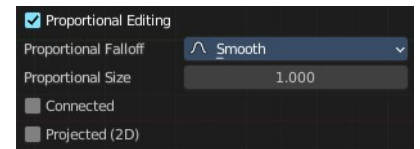

Proportional Falloff

Adjust the falloff methods.

Proportional Size

See and adjust the falloff radius.

Connected

The proportional falloff gets calculated for connected parts only.

Projected(2D)

The proportional falloff gets calculated in the screen space. Depth doesn't play a role. When it's in the radius, then it gets calculated.

Scale

Scales the selected keyframes. You need to have more than one keyframe selected.

Last Operator Resize

Angle

The rotation. Attention, the actual world orientation and rotation does not matter here. It always starts with a value of zero, and rotates relative to this zero then. For the actual rotation values have a look in the sidebar in the transform panel.

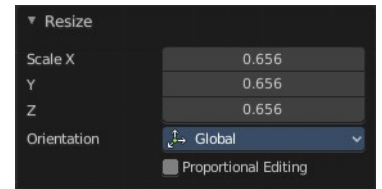

Axis

Which axis to rotate.

Orientation

The widget can have different orientations. The menu items should be self explaining.

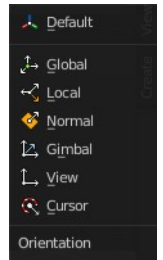

Proportional editing

Enables proportional editing. Activating proportional editing reveals further settings.

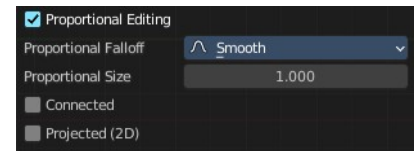

Proportional Falloff

Adjust the falloff methods.

Proportional Size

See and adjust the falloff radius.

Connected

The proportional falloff gets calculated for connected parts only.

Projected(2D)

The proportional falloff gets calculated in the screen space. Depth doesn't play a role. When it's in the radius, then it gets calculated.

Snap

Snaps the selected keyframes by the chosen method.

Cursor to Selection and Cursor Value to Selection does not have a last operator.

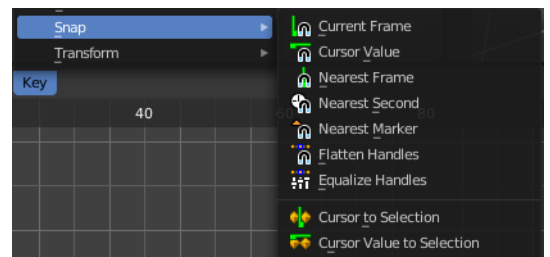

Last Operator Snap Keys

Type

Snaps the selected keyframes by the chosen method.

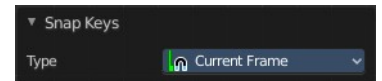

Equalize Handles

Equalize handles is not really a snap method. And therefore it also has another last operator. The Equalize Handles operator allows users to make selected handle lengths uniform: either respecting their original angle from the key control point or by flattening their angle (removing the overshoot sometimes produced by certain handle types).

Last Operator Equalize Handles

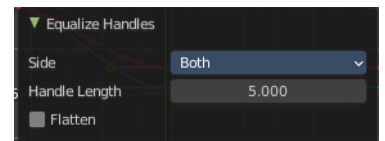

Side

Which side of the control point to affect.

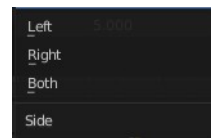

Handle length

How long the handles should become.

Flatten

Equalize the length of the handlers to the other keyframes.

Mirror

Flips the selected keyframes over the current frame position.

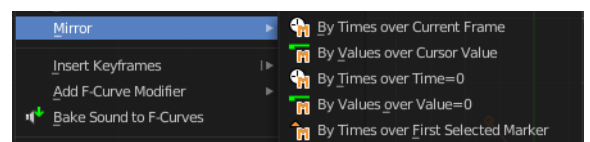

Last Operator Mirror Keys

Type

Flips the selected keyframes over the current frame position by the chosen method.

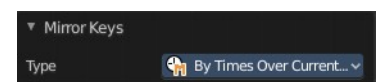

Insert Keyframes

Choose a method how to insert a new keyframe at the current frame position.

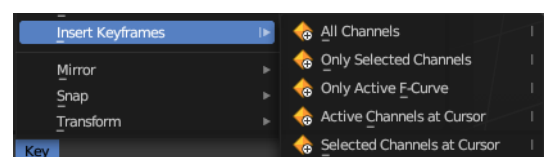

Last Operator Insert Keyframes

Type

Choose a method how to insert a new keyframe at the current frame position.

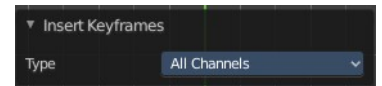

Jump to Selected

Sets the frame marker at the average position of the currently selected keyframes.

Copy Keyframes

Copy selected keyframes.

Paste Keyframes

Pastes copied keyframes.

Paste Flipped

Pastes copied keyframes, but flipped.

Last Operator Paste Keyframes / Flipped

Offset

Define an offset for the paste position.

Type

Choose a method how to paste the copied keyframes.

Flipped

Pastes keyframes from mirrored bones if they exists.

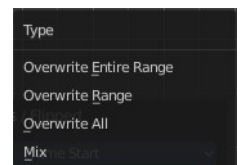
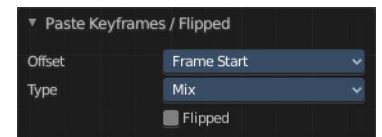

Duplicate

Duplicate selected keyframes.

Last Operator Duplicate

Mode

Values X / Y

The x and y values for the pasted keyframes. Note that these values starts at the position of the original copied keyframe. These values are relative.

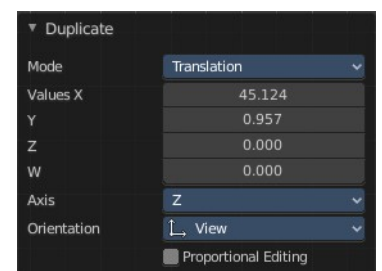

Values Z and W have no effect here.

Axis

These values have no effect.

Orientation

These values have no effect.

Proportional editing

Enables proportional editing. Activating proportional editing reveals further settings.

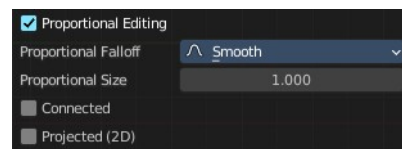

Proportional Falloff

Adjust the falloff methods.

Proportional Size

See and adjust the falloff radius.

Connected

The proportional falloff gets calculated for connected parts only.

Projected(2D)

The proportional falloff gets calculated in the screen space. Depth doesn't play a role. When it's in the radius, then it gets calculated.

Delete Keyframes

Deletes selected keyframes.

Decimate (Ratio)

Decimate F-Curves by removing keyframes that that has the least influence to the curve shape.

Decimate (Allowed Change)

Decimate F-Curves by specifying how much it can derivative from the original curve.

Last Operator Decimate Keyframes

This last operator appears for both decimate operators.

Mode

The decimate mode. Error margin is Allowed change.

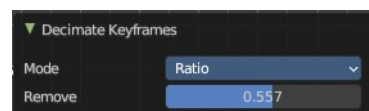
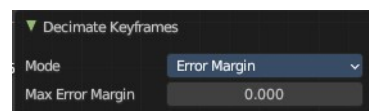

Remove or Max Error Margin

The percentage of keyframes to remove.

Slider Operators submenu

Breakdown

Relaxes the current pose to an inbetween position between the adjacent keyframes.

When you perform the tool then you will see a per cent slider in the header where you can read the percentual influence of the blending. Move the mouse to position the blend pose where you need it.

Last Operator Breakdown

Factor

The percentage of relaxing.

Blend to Neighbour

Blends the current pose with the neighbouring poses.

When you perform the tool then you will see a per cent slider in the header where you can read the percentual influence of the blending. Move the mouse to position the blend pose where you need it.

Last Operator Blend to Neighbour

Blend

The blend factor.

Blend to default Value

Blends the current pose to the default pose.

When you perform the tool then you will see a per cent slider in the header where you can read the percentual influence of the blending. Move the mouse to position the blend pose where you need it.

Last Operator Blend to Default

Factor

The blend factor.

Ease

Adds an ease in and ease out at the selected curves.

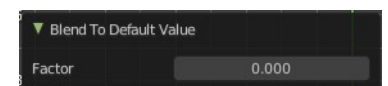
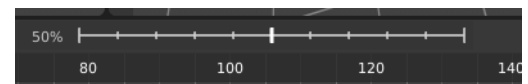
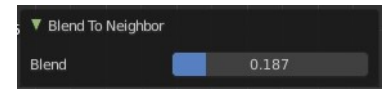
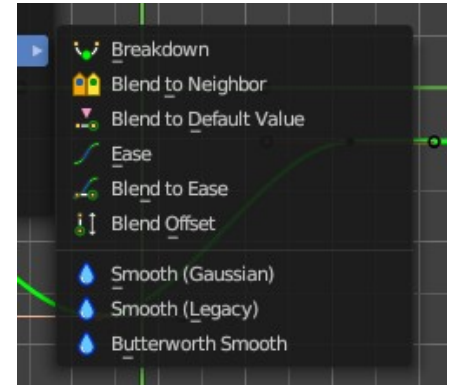

Ease

When you perform the tool then you will see a percent slider in the header where you can read the influence of the blending. Move the mouse to position the blend pose where you need it.

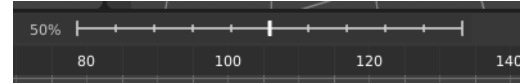

Last Operator Ease Keyframes

Factor

The blend factor.



Blend to Ease

This will blend keyframes from the current state to an ease-in or ease-out curve.

When you perform the tool then you will see a percent slider in the header where you can read the influence of the blending. Move the mouse to position the blend pose where you need it.

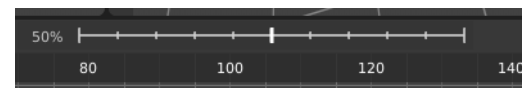

Last Operator Blend to Ease Keyframes

Curve Blend

The curve blend factor.

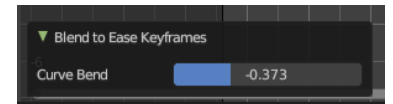

Blend Offset

Shift the selected keyframes to the value of the neighboring keys as a block.

When you perform the tool then you will see a percent slider in the header where you can read the influence of the blending. Move the mouse to position the blend pose where you need it.



Last Operator Blend Offset Keyframes

Offset Factor

The blend factor.

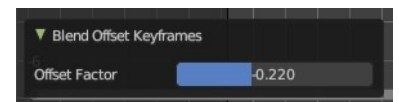

Match Slope

This operator is used to push the segment closer to the values of the next or previous pose. It blends selected keys to the slope of two neighboring keyframes before and after the selection.

Use this to push the segment closer to the values of the next or previous pose.

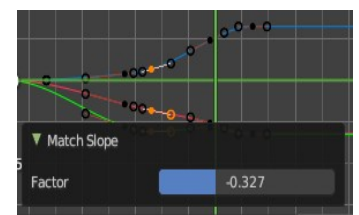

Last Operator Match Slope

The match slope factor.

Smooth (Gaussian)

Smoothens the selected curves with the Gaussian algorithm.

Smooth (Legacy)

Smoothens the selected curves with the legacy algorithm.

Butterworth Smooth

Smoothens the selected curves with the Butterworth algorithm.

Blend to default Value

Adds an ease in and ease out at the selected curves

When you perform the tool then you will see a per cent slider in the header where you can read the percentual influence of the blending. Move the mouse to position the blend pose where you need it.

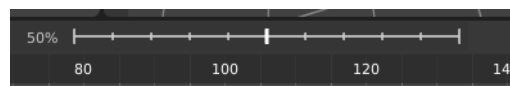

Last Operator Gaussian Smooth

Factor

The blend factor.

Sigma

The shape of the gaussian distribution. Lower values makes it sharper

Filter width

How far to each side in frames will the filter average the key values.



Clean Keyframes

Simplify FCurves by deleting keyframes that are close to each other in all channels.

Clean Channels

Simplify FCurves by deleting keyframes that are close to each other in selected channels.

Last Operator Clean Keyframes

Threshold

The threshold amount for the simplify algorithm.

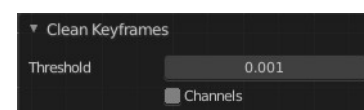

Channels

Clean keyframes or channels.

Smooth Keys

Make selected curves less bumpy.

Sample Keyframes

Adds keyframes at every unit between the selected keyframes.

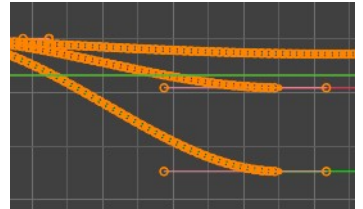



18.2 Editors - Graph Editor - Channel list

Table of content

Dopesheet Editor - Channel List.....	1
Hotkeys.....	1
Search field.....	1
Expand / collapse triangle.....	2
Object type Icon.....	2
Pin.....	2
Visibility.....	2
Channel name.....	2
Enable F-Curve Modifiers.....	2
Mute Channel.....	2
Lock Channel.....	2
Slider values.....	3

Dopesheet Editor - Channel List

The channel list contains your objects and their animation channels. See also the different modes.

The channel list area can be resized by dragging the right border to left or right.

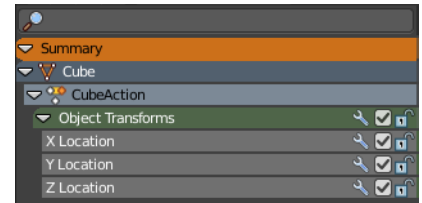

The list has several elements, to turn on or off different features, Or to expand or collapse the hierarchy.

Hotkeys

Hotkey A selects all channels.

Hotkey Alt A deselects everything.

Left mouse and dragging activates box select.

Clicking at a channel selects it.

Clicking at a channel while holding down shift adds to the selection or removes from the selection.

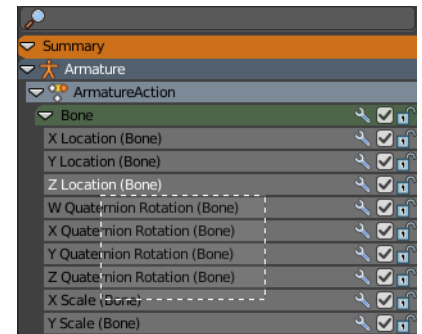

Search field

At the top is a search field that allows you to filter the channel list by search terms.

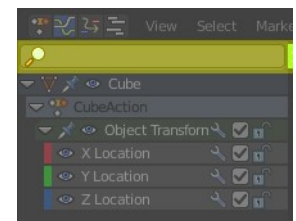

Expand / collapse triangle

The triangle icon at the left allows you to expand or collapse the hierarchy.

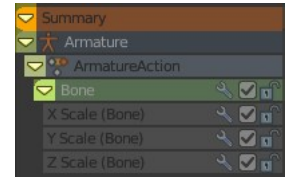

Object type icon

This icon shows what kind of object this channel belongs to. These icons have no functionality.

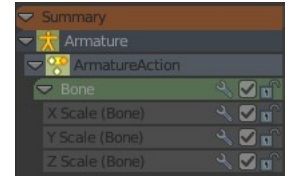

Pin

Normally just the channels for selected objects are visible. With Pin the channels remains visible in Graph Editor, even when you select another object.

Visibility

Hide the channel.

Channel name

The name of the channel name and element. Some elements can be renamed. Like the action or object type.

To rename an element double click at it. Type in the new name. Then press Enter or click elsewhere.

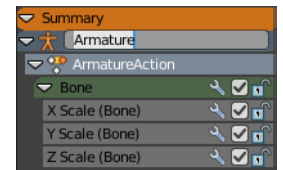

Enable F-Curve Modifiers

In the Graph editor you can add F-Curve modifiers in the sidebar. Enable or disable these modifiers by the Enable F-Curve Modifiers setting in the channel list.



Mute Channel

Mutes the selected channel. It will not be calculated.

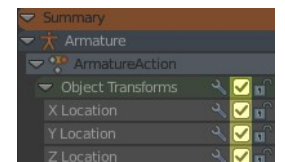

Lock Channel

Locks the selected channel. It is not longer editable.

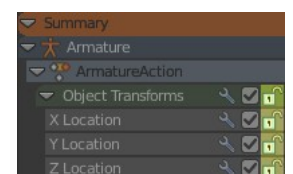

Slider values

F-Curves can show a slider value in the channel list. This can be adjusted in the sidebar in the View options panel. Show Sliders is off by default.

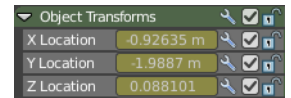

You can edit these values. Double click to make it editable. Enter or click elsewhere to confirm. When you confirm, then the original keyframe gets updated.

When no keyframe exists at the current position, then this keyframe gets created.



18.3 Editors - Graph Editor - Sidebar

Table of content

Introduction..... 1
Right Click menus..... 1

Introduction

The Movie Clip Editor is made of several areas. And it is made of several modes with different editor types.

At the right side you will find the sidebar in Tracking Mode with Clip view. And in Masking mode. In the sidebar you will find further options and settings for the Movie Clip Editor and its tools.

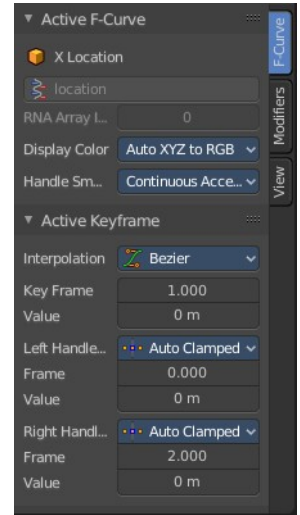

Right Click menus

You will open the usual right click menus when clicking with the right mouse at elements in the sidebar. Its content is in big parts self explaining.

The right click menus are explained in the chapter 6 Editors Introduction.

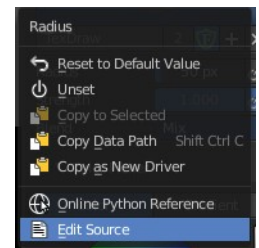



18.3.1 Editors - Graph Editor - Sidebar - F-Curve Tab

Table of content

F-Curve Tab - Active F-Curve Panel.....	1
Channel Name.....	1
RNA Path.....	1
RNA Array Index.....	1
Display Color.....	1
Handle Smoothing.....	2
None.....	2
Continuous Acceleration.....	2
F-Curve Tab - Active Keyframe Panel.....	2
Interpolation.....	2
Key Frame.....	2
Value.....	2
Left Handle Type / Right Handle Type.....	2
Free.....	2
Aligned.....	2
Vector.....	3
Automatic.....	3
Auto Clamped.....	3
Frame.....	3
Value.....	3

F-Curve Tab - Active F-Curve Panel

This panel displays the properties for the active F-Curve.

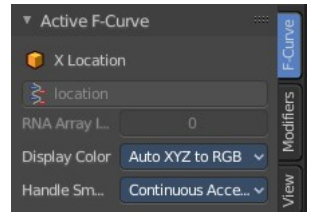

Channel Name

The name of the currently active F-Curve channel.

RNA Path

RNA Path to property. This is a read only information.

RNA Array Index

The RNA Array Index to the specific property affected by the F-Curve if applicable. This is a read only information.

Display Color

With what colors to display the curves. User defined allows you to choose a custom color for the curve. A color field appears. The other methods works random.

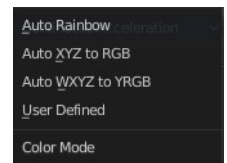
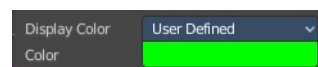

Handle Smoothing

Select the method to compute automatic Bezier Handles.

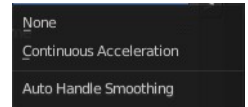

None

Only directly adjacent key values are used when computing the handles. Vector handles points directly at the adjacent keyframes.

Continuous Acceleration

Also keyframes behind the next or previous keyframe gets used for calculation. Which results in a smoother curve.

F-Curve Tab - Active Keyframe Panel

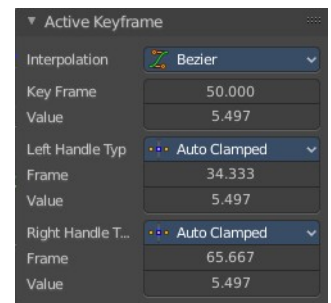

Interpolation

Set the interpolation type for this keyframe.

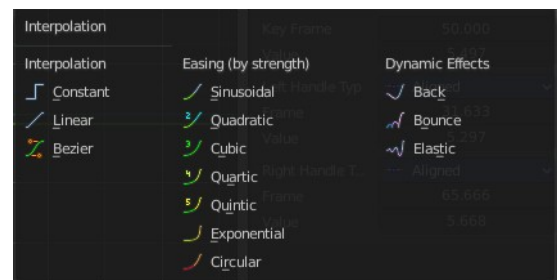

Key Frame

The current position of this keyframe.

Value

The Y value of this keyframe.

Left Handle Type / Right Handle Type

Set the handle type. The handles of a keyframe can be independent. Some constellations just works with some other constellations.

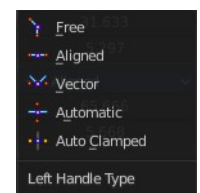

Free

Move and adjust the handles independently.

Aligned

With the left handler the right handler moves too.

Vector

Creates a curve with straight lines.

Automatic

Creates a smooth curve.

Auto Clamped

Creates a smooth curve that only changes the direction at other curve points. It is clamped to prevent overshoots in the curve shape.

Frame

The current frame of this handle.

Value

The current Y position of this handle.



18.3.2 Editors - Graph Editor - Sidebar - Modifiers Tab

Table of content

Detailed table of content.....	1
Modifiers Tab - Modifiers Panel.....	3
Modifier header.....	4
Generator modifier.....	4
Built- in Function modifier.....	5
Envelope modifier.....	6
Cycles modifier.....	8
Noise modifier.....	9
Limits modifier.....	10
Stepped Interpolation modifier.....	11

Detailed table of content

Detailed table of content

Detailed table of content.....	1
Modifiers Tab - Modifiers Panel.....	3
Add Modifier.....	3
Copy F-Curve Modifiers.....	3
Paste F-Curve Modifiers.....	3
Last Operator Add F-Curve Modifier.....	3
Type.....	3
Only Active.....	3
Modifier header.....	4
Triangle button.....	4
Active.....	4
Modifier name.....	4
Muted.....	4
Delete F-Curve Modifier.....	4
Generator modifier.....	4
Polynomial Mode.....	4
Additive.....	4
Poly Order Expanded mode.....	5
Poly Order Factorized mode.....	5
Restrict Frame Range.....	5
Start / End.....	5
In / Out.....	5
Use Influence.....	5
Influence.....	5
Built- in Function modifier.....	5
Curve Type.....	6
Amplitude.....	6
Phase Multiplier.....	6
Phase Offset.....	6
Value Offset.....	6
Restrict Frame Range.....	6

Start / End.....	6
In / Out.....	6
Use Influence.....	6
Influence.....	6
Envelope modifier.....	6
Envelope.....	7
Reference Value.....	7
Min.....	7
Max.....	7
Control Points.....	7
Add Point.....	7
Point values.....	7
Frame.....	7
Min.....	7
Max.....	7
Delete.....	7
Restrict Frame Range.....	8
Start / End.....	8
In / Out.....	8
Use Influence.....	8
Influence.....	8
Cycles modifier.....	8
Trivially Cyclic Curves.....	8
Before.....	8
Before Cycles.....	9
After.....	9
After Cycles.....	9
Restrict Frame Range.....	9
Start / End.....	9
In / Out.....	9
Use Influence.....	9
Influence.....	9
Noise modifier.....	9
Blend Type.....	9
Scale.....	10
Strength.....	10
Offset.....	10
Phase.....	10
Depth.....	10
Restrict Frame Range.....	10
Start / End.....	10
In / Out.....	10
Use Influence.....	10
Influence.....	10
Limits modifier.....	10
Minimum / Maximum X.....	11
Minimum / Maximum Y.....	11
Restrict Frame Range.....	11
Start / End.....	11
In / Out.....	11
Use Influence.....	11
Influence.....	11
Stepped Interpolation modifier.....	11

Step Size.....	11
Offset.....	12
Use Start Frame.....	12
Use End Frame.....	12
Restrict Frame Range.....	12
Start / End.....	12
In / Out.....	12
Use Influence.....	12
Influence.....	12

Modifiers Tab - Modifiers Panel

F-Curve modifiers are similar to Object modifiers. They allow to add adjustable non destructive effects. And they can be layered on top of each other.

Different to the Object modifiers you can't reorder this modifiers. You have to create it in the order that you need it.

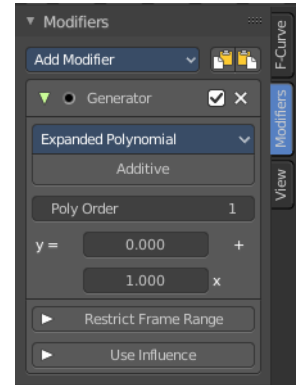
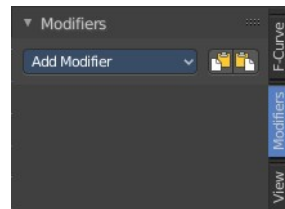

Add Modifier

The list of modifiers. Choose by clicking.

Copy F-Curve Modifiers

Copy the F-Curve Modifiers of the active F-Curve.

Paste F-Curve Modifiers

Paste copied F-Curve modifiers to the active F-Curve.

Last Operator Add F-Curve Modifier

Type

A drop down list with the Type of modifier to add.

Only Active

Only add a modifier to the currently active curve.

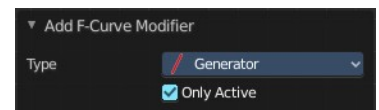

Modifier header

Every modifier is a panel. And every panel has a header area with some general UI elements.

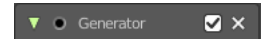

Triangle button

Every modifier panel can be expanded or collapsed by clicking at this triangle button.

Active

This is the panel that you currently edit. When you edit a panel while it is not set to the active one, then the changes will not be applied.

Modifier name

The name of the modifier. Read only.

Muted

Enable or disable this modifier.

Delete F-Curve Modifier

Delete this modifier.

Generator modifier

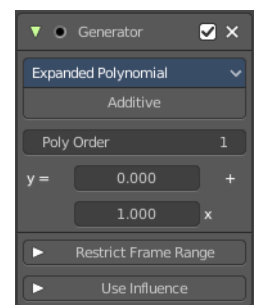

Polynomial Mode

Use Expanded Polynomial or Factorized Polynomial algorithm. With these mathematical formulas you can create lines, parabolas, and other more complex curves by changing the values in the poly order field.



Additive

Add on top of the existing curve instead of replacing the existing curve.

Poly Order Expanded mode

The polynomial formula for the Expanded mode. By increasing the Poly Order value you can add more polynomial fields to the formula.

Change the values to the desired results.

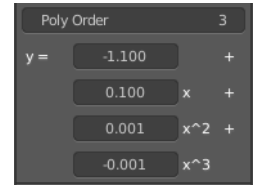

Poly Order Factorized mode

The polynomial formula for the Factorized mode. By increasing the Poly Order value you can add more polynomial fields to the formula.

Change the values to the desired results.

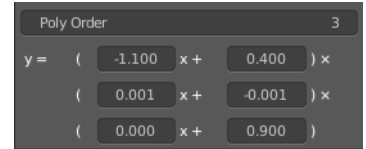

Restrict Frame Range

Expanding the Restrict Frame range sets it to active. It reveals some value slider then.

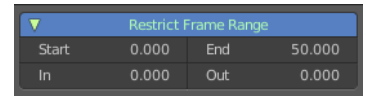

Start / End

The start and end frame of the generated curve.

In / Out

Fade the curve in or out for chosen frame numbers.

Use Influence

Temper the F-Curve Modifier effect by a default influence factor.

Expanding the Use Influence sets it to active. It reveals a value slider then.

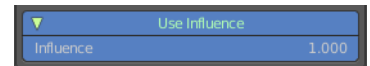

Influence

The influence factor.

Built- in Function modifier

Generate a curve by built in functions.

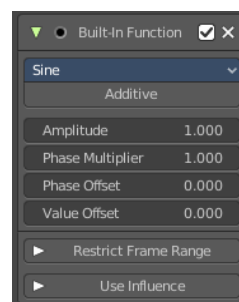

Curve Type

The available wave forms for the curve.

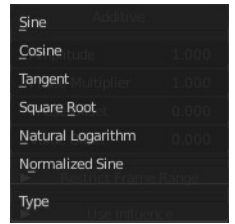

Amplitude

The amplitude of the curve wave. Adjusts the Y scaling.

Phase Multiplier

A phase multiplier for the curve wave. Adjusts the X scaling.

Phase Offset

A phase offset for the curve wave. Adjusts the Y scaling.

Value Offset

A constant value offset for the whole curve. Adjusts the X scaling.

Restrict Frame Range

Expanding the Restrict Frame range sets it to active. It reveals some value slider then.



Start / End

The start and end frame of the generated curve.

In / Out

Fade the curve in or out for chosen frame numbers.

Use Influence

Temper the F-Curve Modifier effect by a default influence factor.

Expanding the Use Influence sets it to active. It reveals a value slider then.

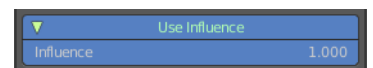

Influence

The influence factor.

Envelope modifier

The Envelope modifier allows you to modify the overall shape of the curve by control points.

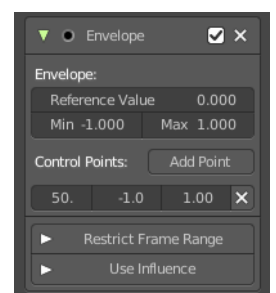

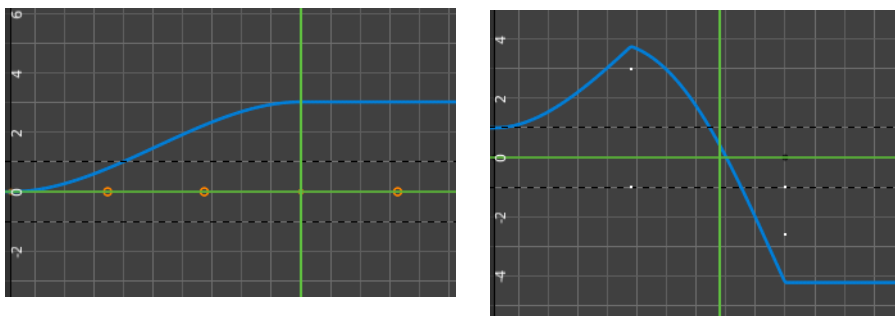

Envelope

Reference Value

Set the Y value to center the envelope around.

Min

The lower distance from reference value for 1:1 default influence.

Max

The higher distance from reference value for 1:1 default influence.

Control Points

Add Point

Add a control point. A control point has two sub points, a lower control point and a higher control point.

Point values

Adding a control point adds an entry in the Point Values list. Every added control point has its own values that can be modified here.

Frame

The frame position of this control point.

Min

The position of the lower control point.

Max

The position of the higher control point.

Delete

Delete this envelope control point.

Restrict Frame Range

Expanding the Restrict Frame range sets it to active. It reveals some value slider then.

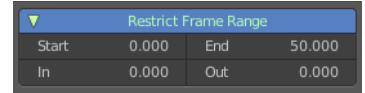

Start / End

The start and end frame of the generated curve.

In / Out

Fade the curve in or out for chosen frame numbers.

Use Influence

Temper the F-Curve Modifier effect by a default influence factor.

Expanding the Use Influence sets it to active. It reveals a value slider then.

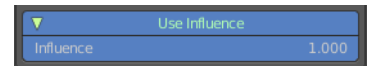

Influence

The influence factor.

Cycles modifier

Add a cyclic motion to a curve that has two or more control points. The option can be set before or after the curve.

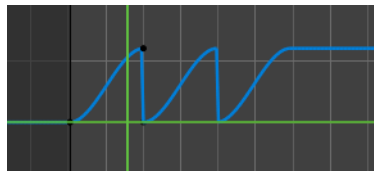
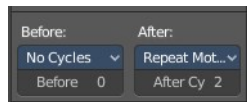
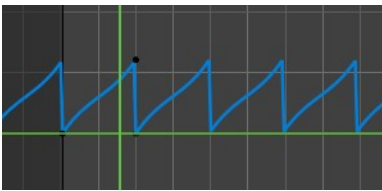
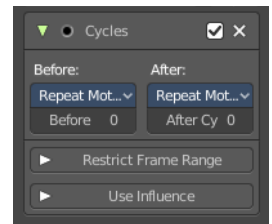

Trivially Cyclic Curves

When the Cycle Mode for both ends is set to either Repeat Motion or Repeat with Offset, and no other options of the modifier are changed from their defaults, it defines a simple infinite cycle.

This special case receives some additional support from other areas of Blender:

Automatic Bezier handle placement is aware of the cycle and adjusts to achieve a smooth transition.

The Cycle-Aware Keying option can be enabled to take the cycle into account when inserting new keyframes.

Before

Set the cycle mode before the first keyframe.



Before Cycles

Maximum number of cycles to allow before first keyframes. A value of 0 means infinite.

After

Set the cycle mode after the first keyframe.



After Cycles

Maximum number of cycles to allow after last keyframes. A value of 0 means infinite.

Restrict Frame Range

Expanding the Restrict Frame range sets it to active. It reveals some value slider then.



Start / End

The start and end frame of the generated curve.

In / Out

Fade the curve in or out for chosen frame numbers.

Use Influence

Temper the F-Curve Modifier effect by a default influence factor.

Expanding the Use Influence sets it to active. It reveals a value slider then.

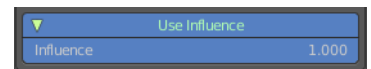

Influence

The influence factor.

Noise modifier

Adds noise to the curve.

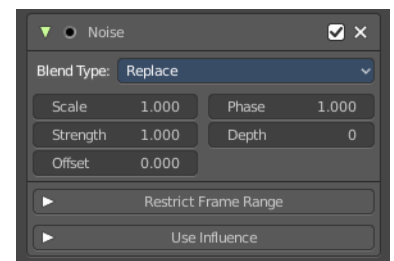
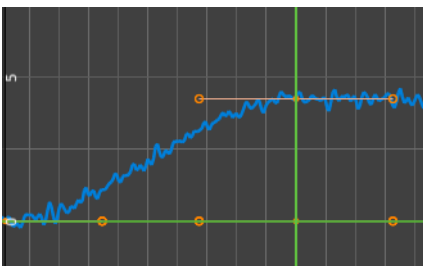

Blend Type

How to blend the noise with the curve.

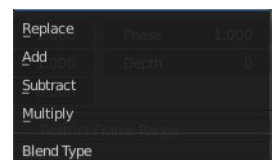

Scale

The overall size of the noise. The bigger the value the less frequent the noise.

Strength

Adjust the Y value of the noise.

Offset

Time offset of the noise.

Phase

The random seed for the noise.

Depth

How detailed the noise function is.

Restrict Frame Range

Expanding the Restrict Frame range sets it to active. It reveals some value slider then.

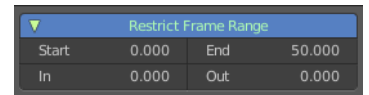

Start / End

The start and end frame of the generated curve.

In / Out

Fade the curve in or out for chosen frame numbers.

Use Influence

Temper the F-Curve Modifier effect by a default influence factor.

Expanding the Use Influence sets it to active. It reveals a value slider then.

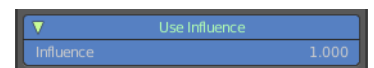

Influence

The influence factor.

Limits modifier

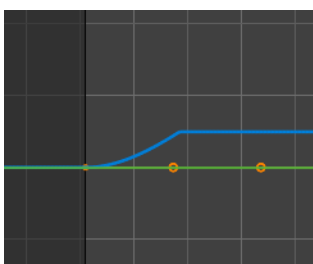

Sets limits to the curve in specified x and y range values.

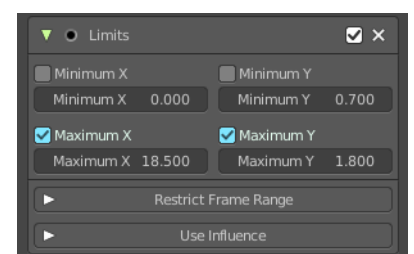

Minimum / Maximum X

Cuts the curve at these minimum and maximum frame values.

Minimum / Maximum Y

Clamps the curve at these minimum and maximum values.

Restrict Frame Range

Expanding the Restrict Frame range sets it to active. It reveals some value slider then.

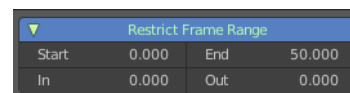

Start / End

The start and end frame of the generated curve.

In / Out

Fade the curve in or out for chosen frame numbers.

Use Influence

Temper the F-Curve Modifier effect by a default influence factor.

Expanding the Use Influence sets it to active. It reveals a value slider then.

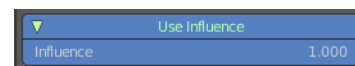

Influence

The influence factor.

Stepped Interpolation modifier

Adds steps to the curve by rounding the values.

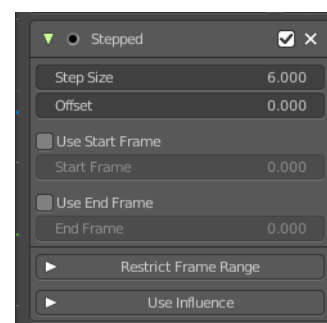
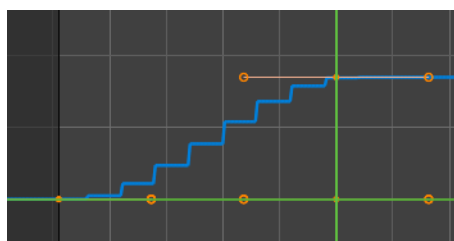

Step Size

The number of frames to hold each frame

Offset

A number of offset frames before frames get held.

Use Start Frame

Restrict the modifier so that it just acts before its end frame.

Use End Frame

Restrict the modifier so that it just acts after its start frame.

Restrict Frame Range

Expanding the Restrict Frame range sets it to active. It reveals some value slider then.

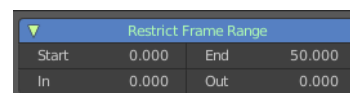

Start / End

The start and end frame of the generated curve.

In / Out

Fade the curve in or out for chosen frame numbers.

Use Influence

Temper the F-Curve Modifier effect by a default influence factor.

Expanding the Use Influence sets it to active. It reveals a value slider then.

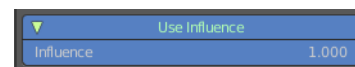

Influence

The influence factor.



18.3.3 Editors - Graph Editor - Sidebar - View Tab

Table of content

Show Cursor panel.....	1
Show Cursor checkbox.....	1
Cursor X.....	1
Cursor Y.....	1
Cursor to Selection.....	1
Cursor Value to Selection.....	1

Show Cursor panel

The vertical green line is the time cursor. The horizontal green line is called the cursor. Or ground line cursor. Together they are the 2d cursor.

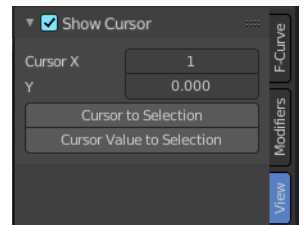
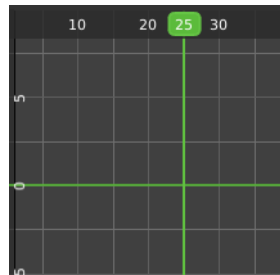

Show Cursor checkbox

Hides the green ground line cursor.

Cursor X

The frame position of the playhead cursor.

Cursor Y

The Y position of the ground line cursor.

Cursor to Selection

Sets both cursors to the center of the selection. This button also works when the ground line cursor is deactivated. In this case just the playhead cursor gets set to the center of the selection.

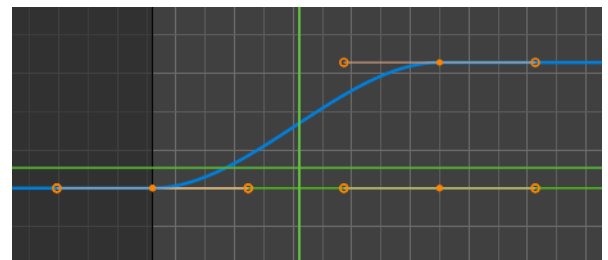

Cursor Value to Selection

Place the cursor value on the average value of selected keyframes.



19 Editors - Drivers Editor

Table of content

Drivers Editor.....	3
Time cursor.....	3
F-Curves.....	4
Handles.....	4
Viewport Navigation.....	4
Viewport navigation.....	4
Dope Sheet Channel Context Menu.....	4
Frame selected channels.....	4
Mute Channel.....	4
Unmute Channel.....	5
Protect Channels.....	5
Unprotect Channels.....	5
Group Channels.....	5
Ungroup Channels.....	5
Toggle Channel Editability.....	5
Extrapolation Mode submenu.....	5
Extrapolation Mode.....	5
Constant Extrapolation.....	5
Linear Extrapolation.....	5
Make Cyclic.....	5
Clear Cyclic.....	5
Expand Channels.....	5
Collapse Channels.....	6
Move submenu.....	6
Delete Channels.....	6
F-Curve Context Menu.....	6
Copy.....	6
Paste.....	6
Paste Flipped.....	6
Last operator Paste Keyframes / Flipped.....	6
Offset.....	6
Type.....	6
Flipped.....	7
Handle Type.....	7
Last Operator Set Keyframe Handle Type.....	7
Type.....	7
Interpolation Mode.....	7
Last Operator Set Keyframe Interpolation.....	7
Type.....	7
Easing Mode.....	7
Last Operator Set Keyframe Easing Type.....	8
Type.....	8
Insert Keyframes.....	8
Duplicate.....	8
Last Operator Duplicate.....	8
Mode.....	8
Values X / Y.....	8

Axis.....	8
Orientation.....	8
Proportional editing.....	8
Proportional Falloff.....	8
Proportional Size.....	8
Connected.....	8
Projected(2D).....	8
Delete Keyframes.....	9
Mirror.....	9
Last Operator Mirror Keys.....	9
Type.....	9
Snap.....	9
Last Operator Snap Keys.....	9
Type.....	9
Slider snapping.....	9
Quick Favorites menu.....	9
Editing the expression from the property.....	10
Simple Expressions.....	10
Variable Names.....	10
Literals.....	10
Globals.....	10
Constants.....	10
Operators.....	10
Functions.....	10
Drivers setup example.....	11
Control movement of a cube by rotation of a sphere.....	11
Add input variable.....	13

Drivers Editor

Drivers are a way to control values or properties by other values or properties. This is done by expressions. As an example, you can use the Y rotation of a sphere to control the X movement of a cube. The rotation of the sphere drives the cube then.

The Drivers Editor is the place to adjust the settings for drivers.

The Drivers editor has several areas.

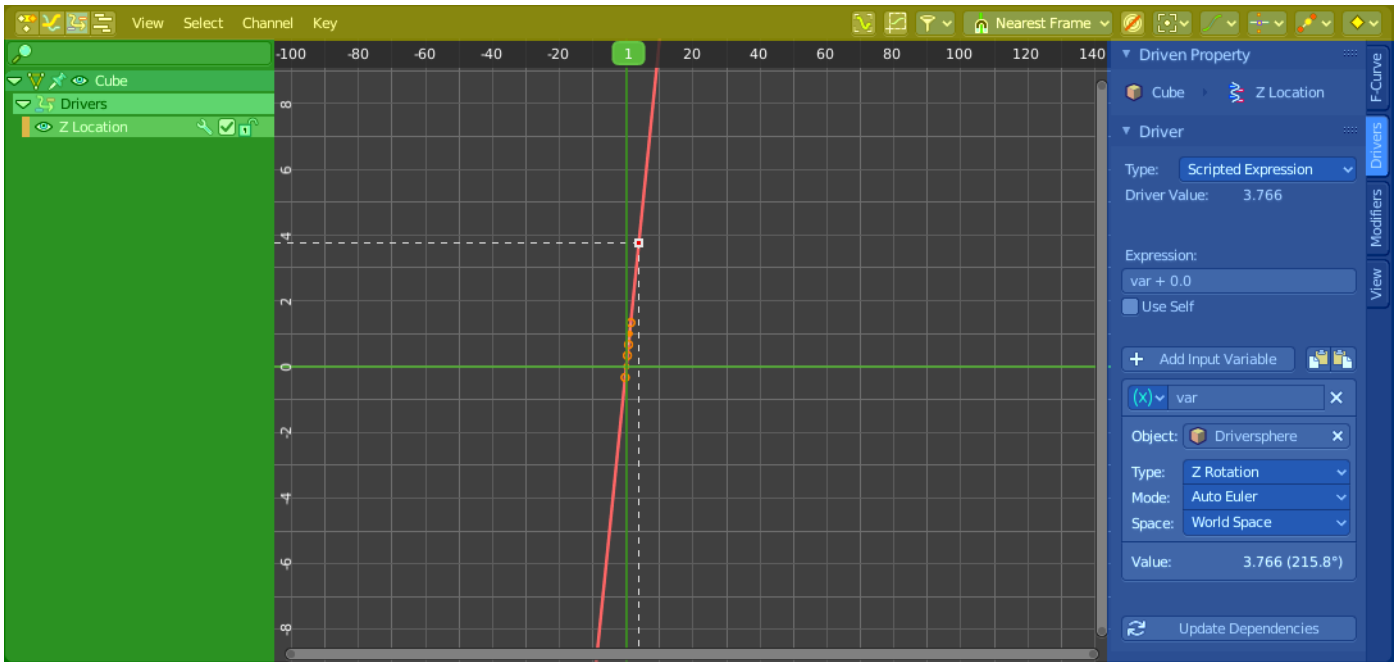

Header (Yellow)

Channel list (Green).

Sidebar (Blue). The sidebar needs to be revealed, which can be done by clicking at the small triangle button up right.

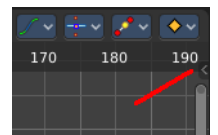

Viewport (no color)

The header is divided into two parts. Left tools and menus. Right Options.



Menus (Green)

Options (Yellow)

Time cursor

The Time Cursor is the green slider at the top. It is used to set and display the current time frame.

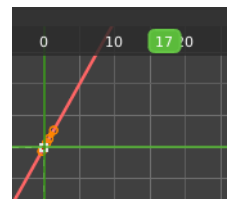

F-Curves

The timeline displays the function curves for the driver. This curve is controlled by the expression. But this curve can also be manipulated in various ways like any other F-Curve. Note that manipulating the curve does not manipulate the expression. It adds on top of it. And there is no way to reset it but create the driver from scratch. So be careful with manipulations.

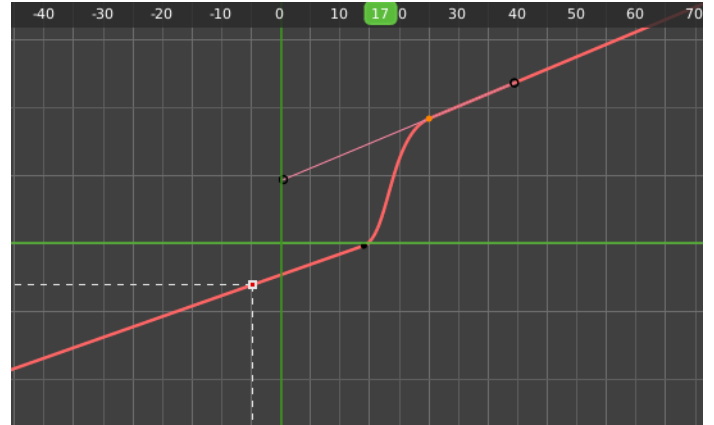

Handles

Every curve point has handles assigned. The curve can be manipulated by dragging these handlers. You can also change the handle type in the Keyframe Handle Type menu in the header. To make the curve sharp at this keyframe for example.

Viewport Navigation

Navigation in the viewport happens by mouse or hotkeys. Some of them does not have a menu entry. And needs to be explained here.

Viewport navigation

Clicking left at the number bar moves the frame marker.

Middle mouse button pans the view.

Holding ctrl + middle mouse button zooms the view.

Scroll Wheel zooms the view.

To manipulate a curve point, grab one of its handlers and drag.

Dope Sheet Channel Context Menu

When you right click into the channel area, then you will call the Dope Sheet Channel context menu.

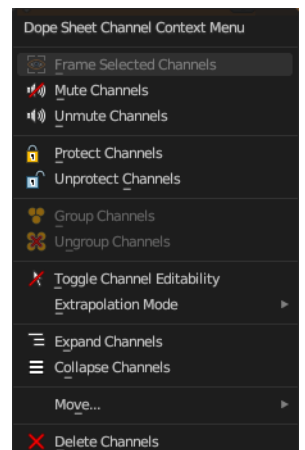

Frame selected channels

Centers the selected channels in view.

Mute Channel

This channel is not calculated.

Unmute Channel

This channel is calculated.

Protect Channels

Protect channels from editing.

Unprotect Channels

Enables editing of channels again.

Group Channels

Groups channels together.

Ungroup Channels

Ungroup grouped channels. Beware, the channels will not return to their initial group.

Toggle Channel Editability

Protects or unprotects the selected channels.

Extrapolation Mode submenu

Extrapolation Mode

Sets the extrapolation mode for the selected F-Curves. Means how the curve acts at the beginning and the end of the F-Curve.

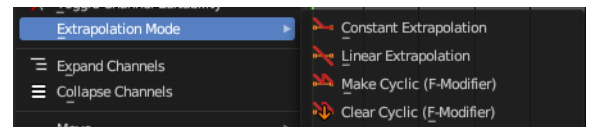

Constant Extrapolation

The animation curve continues straight at the end.

Linear Extrapolation

The animation curve continues the last direction.

Make Cyclic

Makes the animation loopable. The interpolation curves are adjusted so that the first frame fits to the last frame.

Clear Cyclic

Removes the cyclic extrapolation.

Expand Channels

Expands the channels.

Collapse Channels

Collapses the channels.

Move submenu

Sort the order of the channels. The menu items should be self explaining.

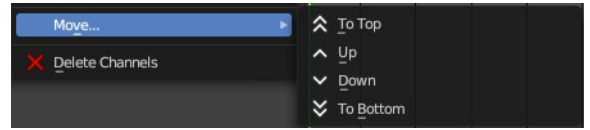

Delete Channels

Removes the selected channels.

F-Curve Context Menu

When you double right click into the viewport then you will call the F-Curve context menu.

Copy

Copies the currently selected curve point(s).

Paste

Pastes copied curve point(s)

Paste Flipped

Pastes copied curve point(s), but flipped.

Last operator Paste Keyframes / Flipped

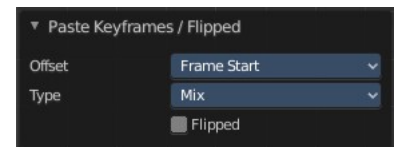
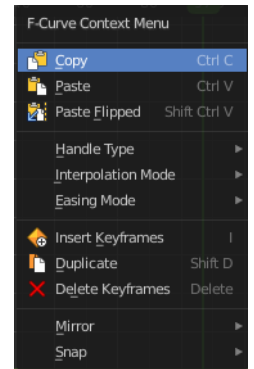

Offset

Define a time offset to paste the keys.

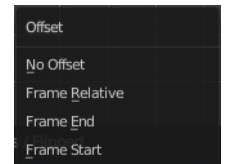

Type

The paste method.



Flipped

Paste copied curve point(s) flipped.

Handle Type

Set the handle type for the currently selected curve point.

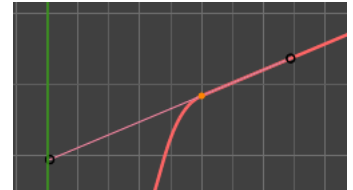
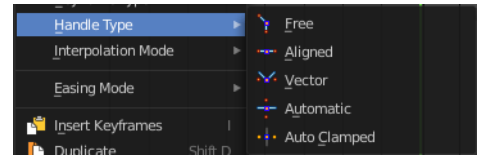

Last Operator Set Keyframe Handle Type

Type

Set the handle type for the currently selected curve point.

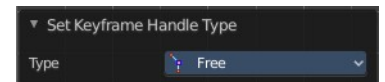

Interpolation Mode

The Interpolation mode defines how the curve acts from keyframe to keyframe. You can have a linear curve between two keyframes instead of a bent one for example.



The easing methods here in the interpolation mode menu are for the easing shape. There is also an easing menu where you can choose a easing method.

Last Operator Set Keyframe Interpolation

Type

Set the interpolation mode.

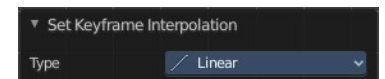

Easing Mode

The easing methods in the interpolation mode menu are for the easing shape. This menu allows you to choose an easing method.

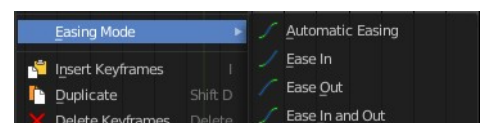

Last Operator Set Keyframe Easing Type

Type

Set the easing type.

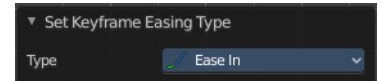

Insert Keyframes

Insert a keyframe at the current position. This functionality does not work from the Drivers editor.

Duplicate

Duplicate the selected curve point(s).

Last Operator Duplicate

Mode

Values X / Y

The x and y values for the pasted keyframes. Note that these values starts at the position of the original copied keyframe. These values are relative.

Values Z and W have no effect here.

Axis

These values have no effect.

Orientation

These values have no effect.

Proportional editing

Enables proportional editing. Activating proportional editing reveals further settings.

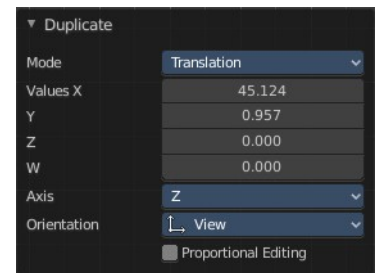

Proportional Falloff

Adjust the falloff methods.

Proportional Size

See and adjust the falloff radius.

Connected

The proportional falloff gets calculated for connected parts only.

Projected(2D)

The proportional falloff gets calculated in the screen space. Depth doesn't play a role. When it's in the radius, then it gets calculated.

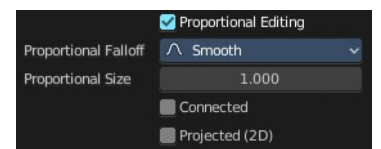

Delete Keyframes

Delete the selected curve point(s).

Mirror

Mirrors the animation by the given method.

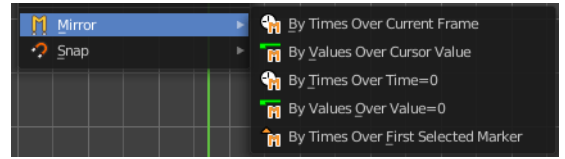

Last Operator Mirror Keys

Type

Flips the selected keyframes over the current frame position by the chosen method.

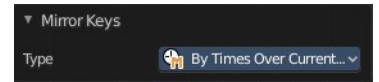

Snap

Snaps the selected keyframes by the given method.

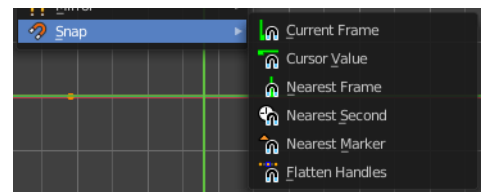

Last Operator Snap Keys

Type

Snaps the selected keyframes by the chosen method.

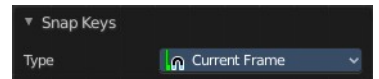

Slider snapping

Snapping also works at sliders. Hover with the mouse over the slider, start to slide, and holding down **Ctrl** will snap the sliders in incremental steps.



When it's a default value between 0 and 1 then it usually snaps in 0.1 steps. When it's a default value over 1 then it usually snaps in steps of 10.

The increment snapping also works at the frame slider. Here the incremental snapping happens by the frame rate that you have defined. With a frame rate of 24 it will snap in steps of 24 frames when holding down ctrl.

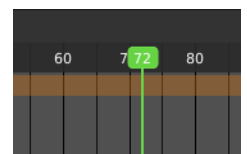

Quick Favorites menu

When you right click at a menu or a button, then a right click menu will open. Tools have usually a Add to Quick Favorites menu entry.

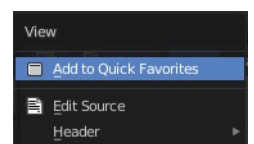

The Quick Menu is empty by default. With Add to Quick favorites you can add this menu

to the Quick menu.

In the 3D view we have a menu called Quick in the header, which shows this content then. In the Dope Sheet Editor you can just call it with its hotkey. Q. It has no regular menu entry here.

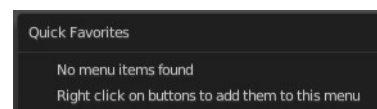

Editing the expression from the property

A property with a driver attached will turn pink.

When you click into the edit box, then the expression for the driver will appear. And you can edit this expression now without to edit the driver again.

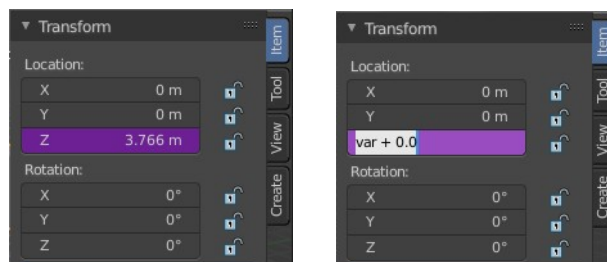

Simple Expressions

There are some advanced expression methods, called Simple Expressions.

Variable Names

Use only ASCII characters.

Literals

Floating point and decimal integer.

Globals

frame

Constants

pi, True, False

Operators

+, -, *, /, ==, !=, <, <=, >, >=, and, or, not, conditional operator/ ternary if

Functions

min, max, radians, degrees, abs, fabs, floor, ceil, trunc, int, sin, cos, tan, asin, acos, atan, atan2, exp, log, sqrt, pow, fmod

Simple expressions are evaluated even when Python script execution is disabled.

When an expression outside of this subset is used, Blender displays a “Slow Python expression” warning. However, as long as the majority of drivers use simple expressions, using a complex expression in select few is

OK.

Drivers setup example

Control movement of a cube by rotation of a sphere

Create a cube and a sphere, and place the sphere a bit off. We want to be able to select and modify it.

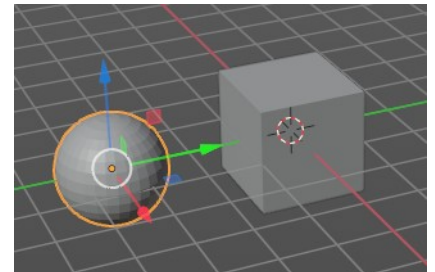

Select the cube.

In the Transform panel in the sidebar right click at the Z value and choose Add Driver. We will add the driver to the Z axis property of the cube.

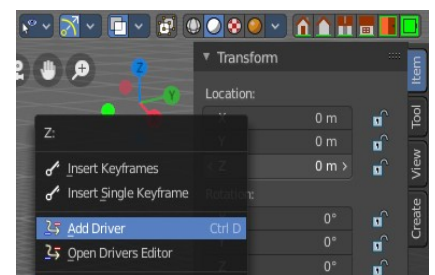

When you add a driver a panel will pop up where you can do the drivers setup.

In case you miss this panel by too fast clicking, it can be called again by right clicking at the property again and choose Edit Drivers from the menu.

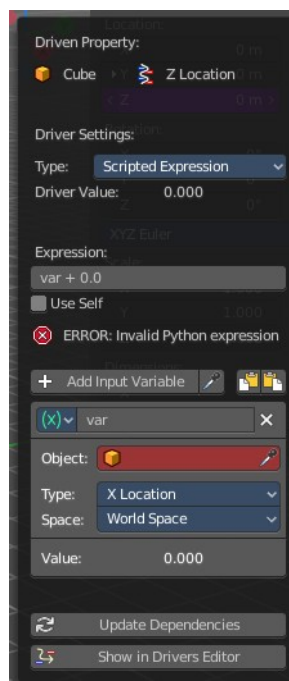

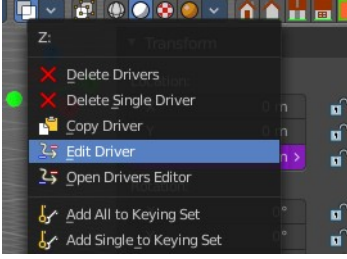

Don't worry about the ERROR: invalid Python expression at this point. we are going to change this now.

In the red field with the Object label choose the sphere.

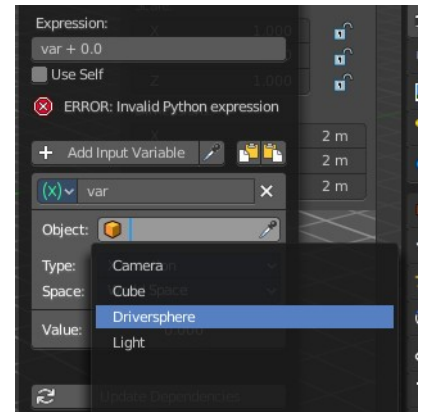

By default the X value influences now the Z position of the cube. So when you move the sphere in X direction, the cube will move in Z direction.

Let's change this to rotation around Z axis. Now the cube moves in Z axis when we rotate our sphere in Z axis.

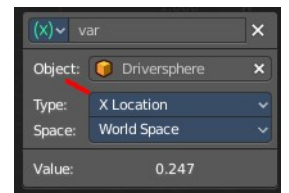
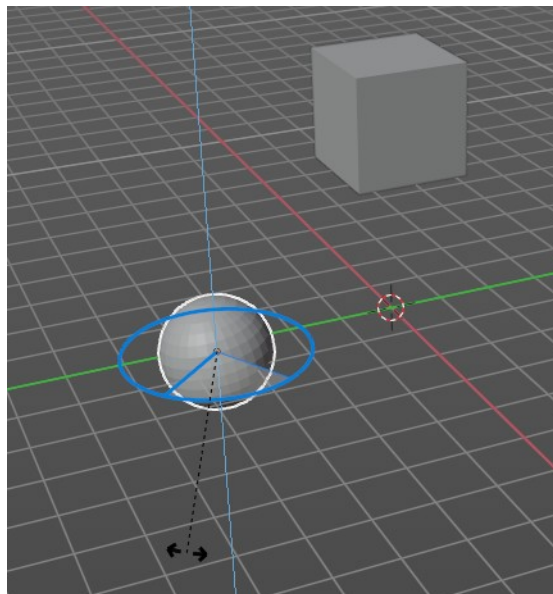

Let's have a look into our Drivers editor.

We have now content available- The channels list has an entry. And when you click at the Z Location channel in the channel list then the content and the driver settings panel in the sidebar will appear. It is the same than the one from the right click menu.

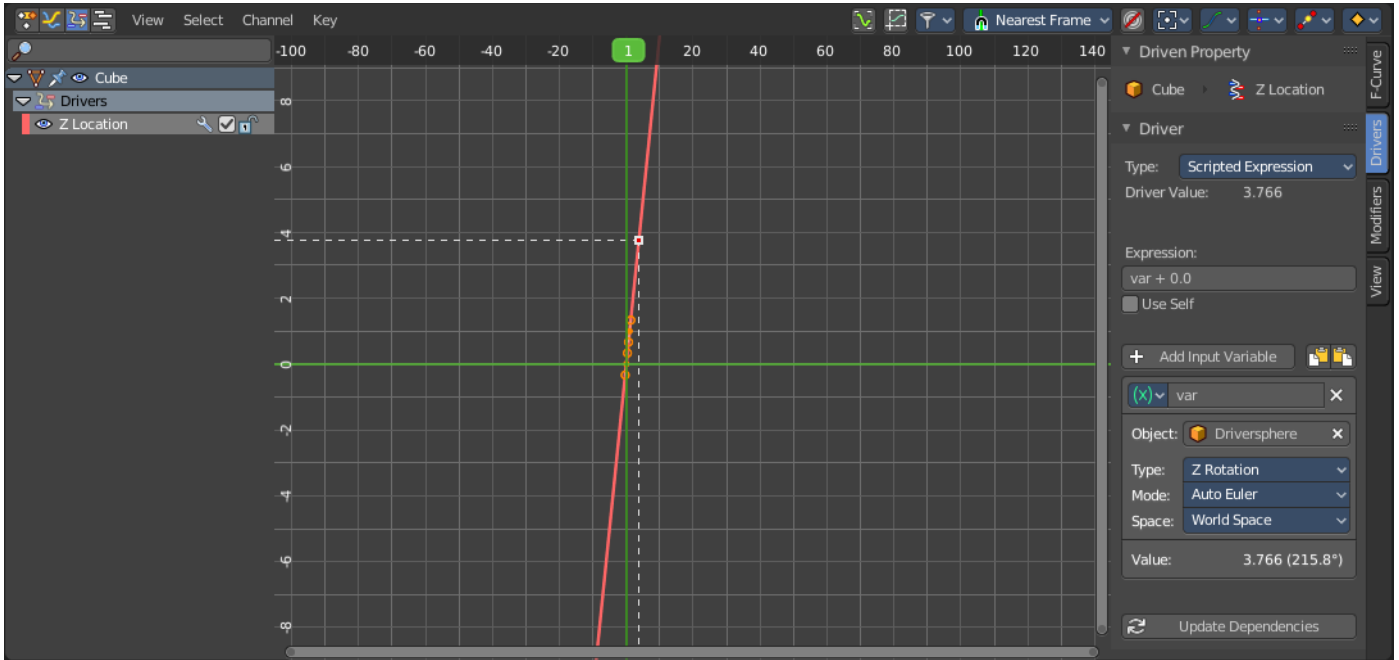

Let's have a closer look at how this all works. The Expression field is the place where the magic happens. When you change this expression then you can change the behavior of the driver. For example instead of `var + 0.0` you could add a multiplicator here to our variable called `var`. Let's say `var *2`. Then the cube moves in double speed of the rotation of our sphere.

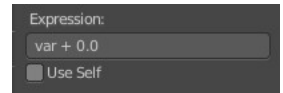

Add input variable

You could also add a second input value, and connect it with another object. Let's say a cone.

Add a cone object.

In the Driver add a new input variable.

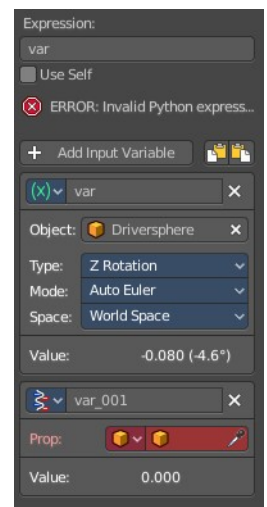

Change this input variable to type Transform Channel.

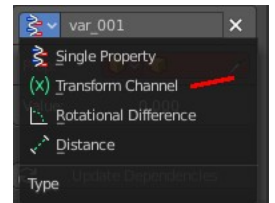

Now in the object field choose our cone object. And rename the input variable to something meaningful. Again set the type to your needs.

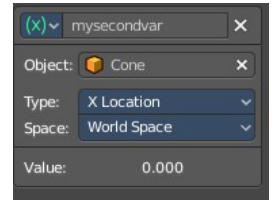

Now let's change the Expression to this: var + mysecondvar.

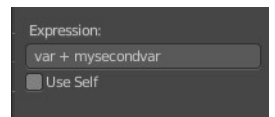

As a last step update the dependencies by clicking at the Update Dependencies button at the end, which will remove the Invalid Python Expression error.

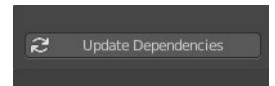

And now the driver is controlled by the Z rotation of our sphere, which is defined in the variable var. PLUS the x location of the cone object, which is defined in the variable mysecondvar.



19.1.1 Editors - Drivers Editor - Header tools and options

Table of content

Introduction.....	2
Header Tabs.....	2
Use Normalization, Create Ghost Curves.....	2
Use Normalization.....	2
Auto Normalization.....	2
Create Ghost Curves.....	2
Show Hide elements.....	2
Only Show Selected.....	2
Show Hidden.....	3
Only Show Errors.....	3
Filters.....	3
Filter by Collection.....	3
Filter by Type.....	3
Options.....	3
Sort Data Blocks.....	3
Auto Snap.....	3
Proportional Editing.....	4
Pivot Point.....	4
Bounding Box Center.....	4
2D Cursor.....	4
Individual Centers.....	4
Easing Mode.....	4
Easing Mode.....	4
Last Operator Set Keyframe Easing Type.....	4
Type.....	4
Keyframe Handle Type.....	5
Last Operator Set Keyframe Handle Type.....	5
Type.....	5
Keyframe Interpolation.....	5
Last Operator Set Keyframe Interpolation.....	5
Type.....	5
Options.....	6
Real-time Updates.....	6
Show Seconds.....	6
Sync visible range.....	6
Show Sliders.....	6
AutoMerge Keyframes.....	6
Use High Quality Display.....	6
Show Extrapolation.....	6
Show Handles.....	6
Only selected Curve Keyframes.....	6
Only Selected Keyframes Handles.....	6

Introduction

The header contains various menus and tools. This chapter here is about the tools, modes and options elements in the header.

The text menus are covered in a own chapter each. They vary too much, dependent of mode and object type.



Header Tabs

The tabs at the very left allows you to switch between the four most important editor types by one click. Dope sheet Editor, Graph Editor, Driver Editor, NLA Editor.



Use Normalization, Create Ghost Curves

Use Normalization



Normalizes the curves so that the maximum does not exceed 1 and the minimum does not go lower than -1

Auto Normalization

Automatically recalculate curve normalization when you modify the curve.

Create Ghost Curves

Creates a snapshot of the current curves, and displays it as a background image in the viewport. This background image is not permanent, and will be deleted when you close Bforartists.

When a ghost background image is created then the button turns into a delete button with which you can remove the ghost image.

Show Hide elements



Only Show Selected

Display only the data for the selected object in the list of elements. If off it displays all available animation data of the whole scene.

Show Hidden

Include channels from objects / bones that are not visible. This feature just works with Only Selected off.

Only Show Errors

Only display F-Curves and Drivers that have errors or are disabled.

Filters

The show hide elements allows you to filter out the general elements. The Filters panel allows you to filter out further elements.

Filter by Collection

Just display the content from the chosen collection in the list of elements.

Filter by Type

In this section you can choose what type of animation data should be displayed. The names should be self explaining.

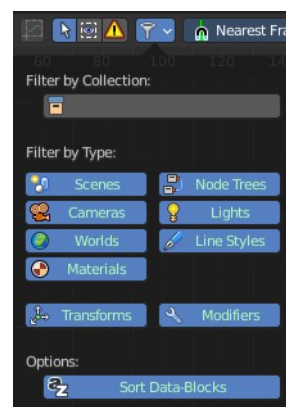

Options

Sort Data Blocks

Alphabetically sort the data in the list of elements.

Auto Snap

Adjust how the selected keyframe or fcurve point snaps to other elements.

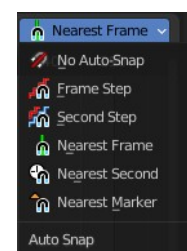

Proportional Editing

Enable proportional editing.

Proportional editing allows you for example to scale two keyframes and influence the not selected neighbor keyframes in a proportional way. Or the proportional editing of fcurve points.

The drop down menu to choose the proportional editing falloff method is just available when the proportional tool is active.

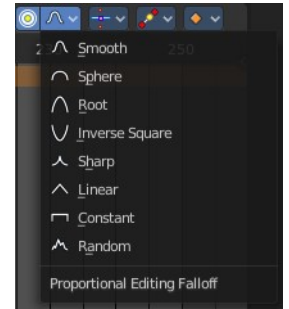

Pivot Point

The pivot point defines the center of manipulations.

Bounding Box Center

Transformation happens around the bounding box center.

2D Cursor

Transformation happens around the timeline cursor.

Individual Centers

Transformation happens around the individual centers of the selected elements.

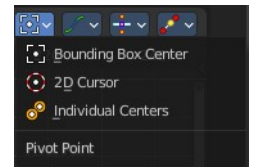

Easing Mode

Easing Mode

The easing methods in the interpolation mode menu are for the easing shape. This menu allows you to choose an easing method.

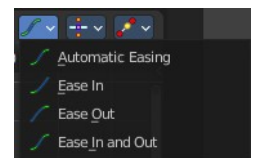

Last Operator Set Keyframe Easing Type

Type

Set the easing type.

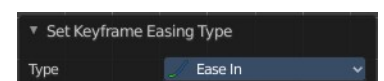

Keyframe Handle Type

Set the handle type for the currently selected keyframes.

This is a feature for the Graph editor, where each curve point has its own handler with which you can influence the curve behavior. But the handler type also influences how the animation curve acts at the chosen keyframes. So it has its use in the dope sheet editor too.

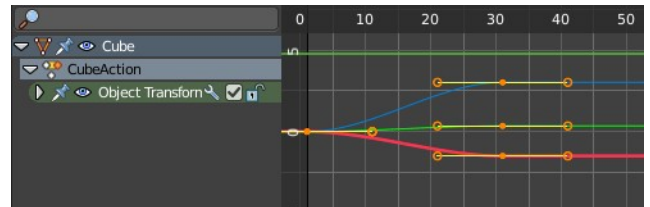
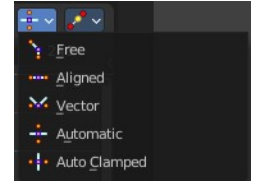

Last Operator Set Keyframe Handle Type

Type

Set the handle type for the currently selected curve point.

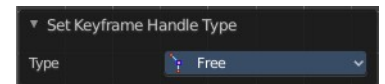

Keyframe Interpolation

The keyframe interpolation mode defines how the curve acts from keyframe to keyframe. You can have a linear curve between two keyframes instead of a bent one for example.

The easing methods here in the interpolation mode menu are for the easing shape. There is also an easing menu where you can choose a easing method.

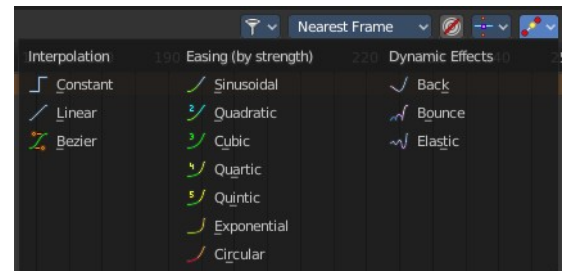

Last Operator Set Keyframe Interpolation

Type

Set the interpolation mode.

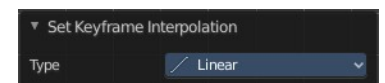

Options

Real-time Updates

When transforming keyframes then this transformation is also immediately visible in other editors.

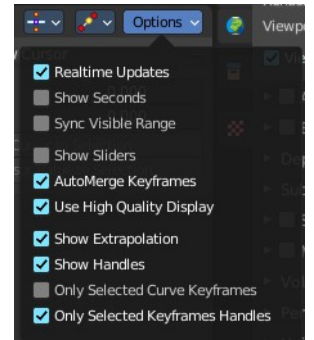

Show Seconds

Show the timing in the timeline area in seconds instead of frames.

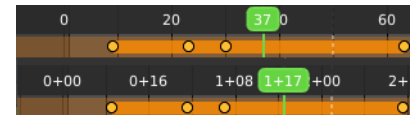

Sync visible range

Synchronize the visible timeline range with other visible time based editors. When you zoom in or out in the one editor, then it zooms in or out in the other editor too. Each editor to sync needs to have Sync Visible Range ticked.

Show Sliders

Shows the value sliders for f-curve channels in the channel list.



AutoMerge Keyframes

Automatically merge nearby keyframes.

Use High Quality Display

Display the curves in highest quality.

Show Extrapolation

Shows the curves after the last keyframe.

Show Handles

Show the handles at the keyframes.

Only selected Curve Keyframes

Just show the keyframes from the selected curves.

Only Selected Keyframes Handles

Just show the handles of the keyframes from the selected curves.



19.1.2 Editors - Drivers Editor - Header - Quick Menu

Table of content

Quick Menu.....	1
Adding an operator to the Quick menu.....	1
Adding a menu to the Quick menu.....	1
Order.....	2
Removing an operator from the Quick menu.....	2
Context and mode dependent content.....	2

Quick Menu

The quick menu, or in long Quick Favorites menu, is a menu that can be customized to your needs. Here you can add operators for quick access.

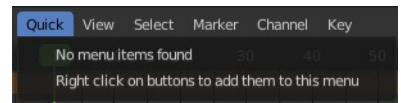

It is located in the header. But it can be called by hotkey Q directly under the mouse. This hotkey works in other editors too.

When the menu is empty, then you will see the message "No Menu Items found". This means that you first have to add some tools to the menu. It is a user configurable menu.

Note that added operators in this menu does not have icons. Just text.

Note that Graph Editor and Drivers Editor shares the same quick menu.

Adding an operator to the Quick menu

Open the panel or the menu where your operator is that you want to add.

Let's add the open command from the File menu. Open the File menu, right click at open, and choose Add to Quick Favorites.

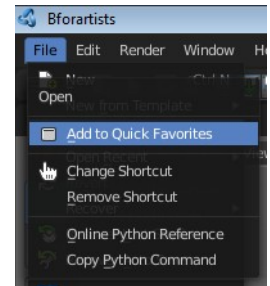

Do the same with Save As. We should now have two new menu items in the Quick menu, which you can use now.

As a rule of thumb, when the right click menu has an Add to Quick Favorites, then you can add it to the quick menu.

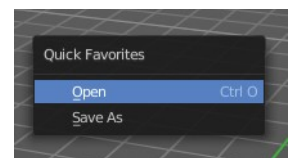

Note that you can also add operators from the tool shelf at the left. And also operators from other editor types. Some other editors have their own quick menu though. The Image Editor for example. These operators gets added in the quick menu of the image editor then. And does not show in the quick menu in the header of the 3D view.

Adding a menu to the Quick menu

It is also possible to add a menu to the Quick menu. For example the whole Add menu. The way is the same. Right click at it, and choose Add to Quick Favorites.

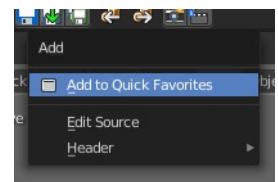

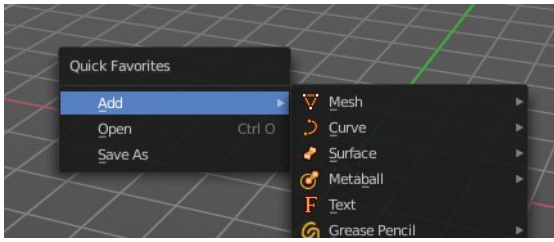

Order

You might notice that the add menu adds at the top of the menu, and not at the bottom as you would expect. First comes menus, then comes operators. And they get added in the order in which you add them.

Besides that, operators and menus gets added in the order that you add them. They cannot be sorted afterwards. So be careful how you add them. You can of course always remove operators and menus, and re-add them at the end of the list.

Removing an operator from the Quick menu

Removing is as simple as adding. Right click at the operators in the Quick menu, and choose Remove from Quick favorites.

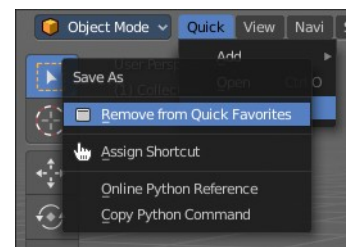

Context and mode dependent content

The quick favorites. menu exists in nearly all editors. But it is just in the 3D view available in the header. So that you know this functionality exists. In the other editors you call it with hotkey Q.

The content of the quick favorites. menu changes, dependent over which editor you are, and in what mode you are. When you add for example an operator from the image editor, then this operator just shows in the quick menu when you call the menu from the image editor. Same goes for the modes. Edit mode tools will just show in edit mode. And so on.



19.1.3 Editors - Drivers Editor - View Menu

Table of content

Drivers Editor - View Menu.....	1
Channels List.....	1
Sidebar.....	2
Adjust last Operation.....	2
Set Preview Range.....	2
Clear Preview Range.....	2
Auto Set Preview Range.....	2
Zoom In.....	2
Zoom Out.....	2
Zoom Border.....	2
Frame All.....	3
Frame Selected.....	3
Go to current Frame.....	3
Area.....	3
Horizontal Split.....	3
Vertical Split.....	3
Duplicate Area into New Window.....	3
Toggle Maximize Area.....	3
Toggle Full screen Area.....	3
Close Area.....	3

Drivers Editor - View Menu

The View menu contains all View related tools.

The content is for all modes the same.

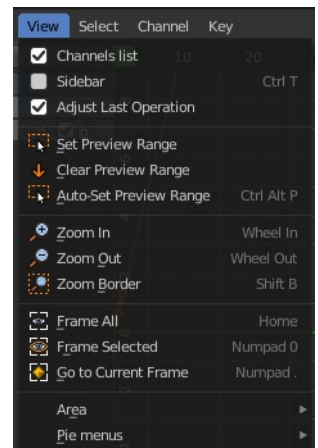

Channels List

Shows or hides the Channels list at the left in the viewport.



Sidebar

Shows or hides the sidebar at the right in the viewport.

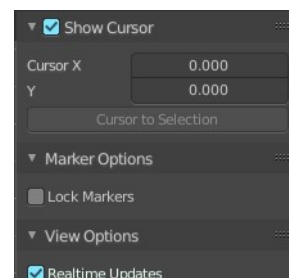

Adjust last Operation

Show the Adjust Last Operation panel down left when you perform a tool.

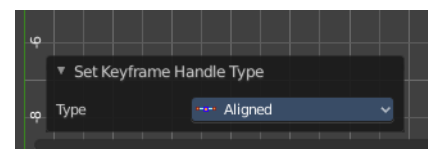

Set Preview Range

Rectangle select an area of the timeline that gets previewed. The playback now just happens in this marked area.

Note that you can set the range in the Drivers editor, but the preview range is currently not visible in the Drivers editor. You need to check it in the Dope Sheet editor for example.



Clear Preview Range

Clears an existing preview range.

Auto Set Preview Range

Sets the preview range between the first and last keyframe of the animation.

Zoom In

Zooms into the viewport.

Zoom Out

Zooms out of the viewport.

Zoom Border

Draws a rectangle and zooms then to fit the size of this rectangle.

Zooming in is done with drawing the rectangle with left mouse button. Zooming out is done with drawing the rectangle with middle mouse button.

Frame All

Zooms in or out in the viewport until all objects in the scene are displayed fitting in the viewport.

Frame Selected

Centers the view at the currently selected keyframe(s).

Go to current Frame

Centers the view at the frame slider.

Area

This menu contains general view functionality. And exists in most other editor types too.

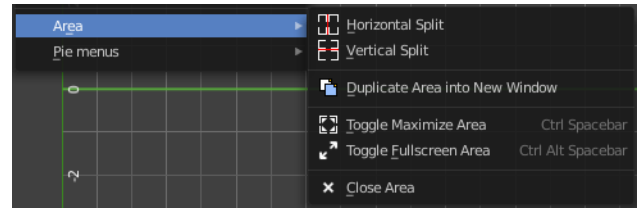

Horizontal Split

Splits the current view horizontally into two independent editor windows.

Vertical Split

Splits the current view vertically into two independent editor windows.

Duplicate Area into New Window

Duplicate Area into New Window makes the selected editor window floating. You can then drag it around at the monitor. It is not connected with the rest of the UI anymore.

A separated window cannot be merged into the main window again. You have to close it when not longer needed.

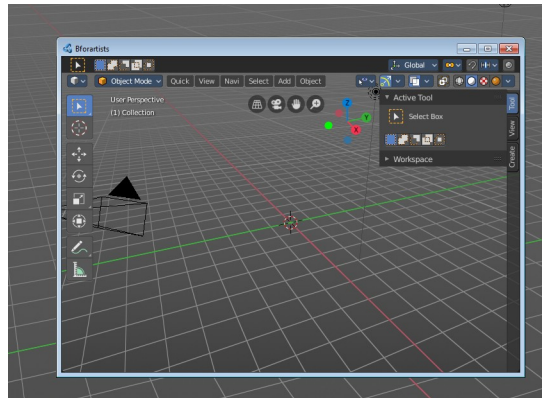

Toggle Maximize Area

Displays the editor maximized with menus.

To return from the maximized view press hotkey ctrl + spacebar. Or reuse the menu item in the area menu.

Toggle Full screen Area

Displays the editor maximized without menus.

To return from the full screen view press hotkey ctrl + alt + spacebar.

Close Area

Closes the editor.



19.1.4 Editors - Drivers Editor - Select Menu

Table of content

Drivers Editor - Select Menu.....	1
All.....	1
None.....	1
Inverse.....	1
Box Select.....	2
Box Select(Axis Range).....	2
Last Operator Box Select.....	2
Axis Range.....	2
Include Handles.....	2
Tweak.....	2
Mode.....	2
Circle Select.....	2
Lasso Select.....	2
Columns on Selected Keys.....	2
Columns on Current Frame.....	3
Linked.....	3
Before current Frame.....	3
After current Frame.....	3
Last Operator Select Left/Right.....	3
Mode.....	3
Extend Select.....	3
More.....	3
Less.....	3

Drivers Editor - Select Menu

The Select menu contains various tools to select elements.

The content is the same in all modes. With one exception. Grease Pencil mode is missing the More / Less menu items.

All

Select everything.

None

Select nothing.

Inverse

Invert the current selection.

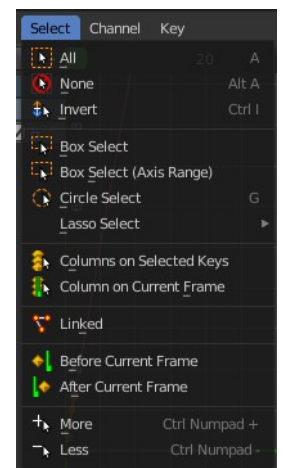

Box Select

Box select enters the Border Select mode. Select elements by dragging a rectangle around it. Just what's inside of the rectangle gets selected then.

It adds to selection by default. To subtract from selection hold down Shift key.

The selection gets applied when you release the mouse. You leave the mode automatically when you release the mouse.

Box Select(Axis Range)

Box select enters the Border Select mode. Select elements by dragging a rectangle around it. And what's inside the horizontal range of the rectangle gets selected then. Even when the keyframes are outside of the rectangle.

It adds to selection by default. To subtract from selection hold down Shift key.

The selection gets applied when you release the mouse. You leave the mode automatically when you release the mouse.

Last Operator Box Select

Axis Range

What's inside the horizontal range of the rectangle gets selected.

Include Handles

Also select the curve handles.

Tweak

Operator has been activated using a tweak event.

Mode

The selection mode to use.

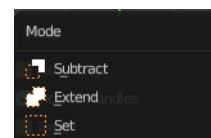
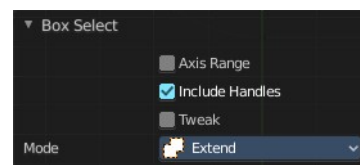

Circle Select

Circle select enters the Circle Select mode. This is a special select mode where you can select elements by moving with the mouse over it. It adds to selection by default.

To subtract from selection hold down Shift key. To exit the Circle select click with the right mouse button.

The pencil radius of the circle select tool can be adjusted with the scroll wheel.

Lasso Select

A sub menu with the available lasso select modes.

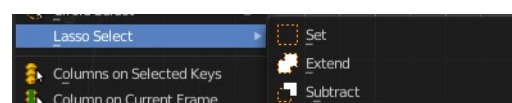

Columns on Selected Keys

Select the keyframes in the columns of the currently selected keyframe.

Columns on Current Frame

Select the keyframes in the columns of the current frame.

Linked

Select all UV vertices linked to the active UV map. The previous selection gets cleared.

Before current Frame

Select the keyframes before the current frame.

After current Frame

Select the keyframes after the current frame.

Last Operator Select Left/Right

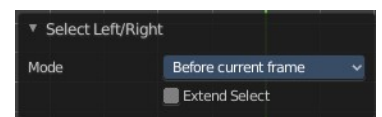

Mode

The selection mode to use.

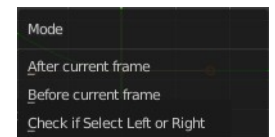

Extend Select

Extend the current selection.

More

Grow the selection.

Less

Shrink the selection.



19.1.5 Editors - Drivers Editor - Channel Menu

Table of content

Dopesheet Editor - Channel Menu.....	2
Channel Menu - Dopesheet + Action Editor mode.....	2
Delete Channels.....	2
Delete Invalid Drivers.....	2
Group Channels.....	2
Ungroup Channels.....	2
Channel Settings.....	2
Last Operator Toggle Channel Settings.....	3
Type.....	3
Toggle Channel Editability.....	3
Last Operator Toggle Channel Editability.....	3
Type.....	3
Extrapolation Mode.....	3
Constant Extrapolation.....	3
Linear Extrapolation.....	3
Make Cyclic.....	3
Clear Cyclic.....	3
Last Operator Set Keyframe Interpolation.....	3
Type.....	3
Reveal Curves.....	3
Last Operator Reveal Curves.....	3
Select.....	3
Hide selected Curves.....	4
Hide unselected curves.....	4
Last Operator Hide Curves.....	4
Unselected.....	4
Expand Channels.....	4
Last Operator Expand Channels.....	4
All.....	4
Collapse Channels.....	4
Last Operator Collapse Channels.....	4
All.....	4
Move.....	4
Last Operator Move Channels.....	4
Direction.....	4
Revive Disabled F-Curves.....	4

Dopesheet Editor - Channel Menu

This menu contains functionality to manage the channels in the channels list at the left.

The menu doesn't exist in all modes. It exists in Dopesheet, Action Editor and Grease Pencil mode. And has different content.

Channel Menu - Dopesheet + Action Editor mode

Delete Channels

Deletes the selected channels and all its keyframes.

Delete Invalid Drivers

Deletes invalid drivers.

Group Channels

Creates a custom group from the selected channels.

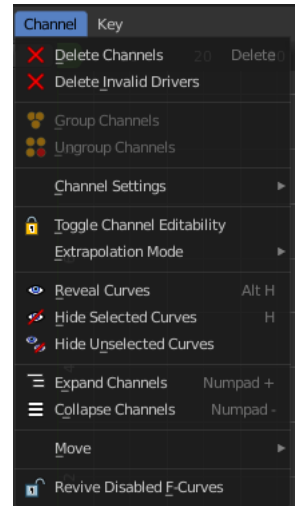
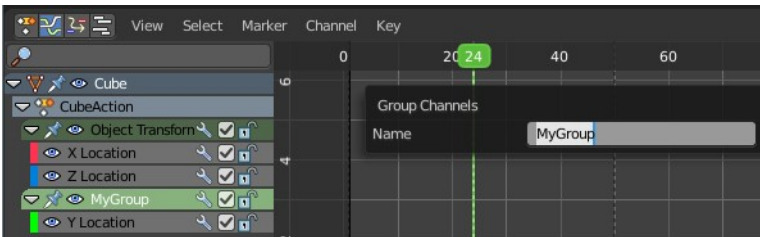

Ungroup Channels

Removes the selected channels from the group, and adds them back to the original hierarchy.

Channel Settings

Adjust the locks and check boxes in the channels list from outside of the channels list for all selected elements at once. With Toggle Mute you could for example disable all selected channels at once.

The menu items should be self explaining.

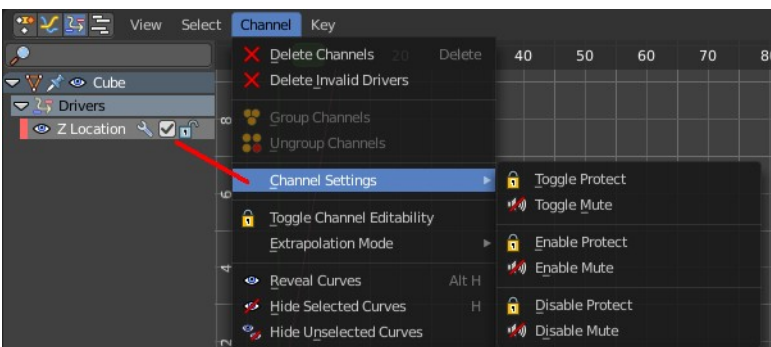

Last Operator Toggle Channel Settings

Type

The type to toggle.

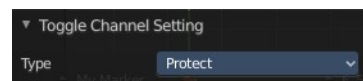

Toggle Channel Editability

Toggles the locks in the channel list from their previous state to locked and back.

Last Operator Toggle Channel Editability

Type

The type to toggle.

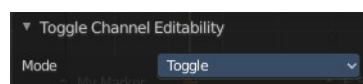

Extrapolation Mode

Sets the extrapolation mode for the selected F-Curves. Means how the curve acts at the beginning and the end of the F-Curve.

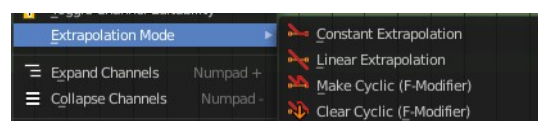

Constant Extrapolation

The animation curve continues straight at the end.

Linear Extrapolation

The animation curve continues the last direction.

Make Cyclic

Makes the animation loopable. The interpolation curves are adjusted so that the first frame fits to the last frame.

Clear Cyclic

Removes the cyclic extrapolation.

Last Operator Set Keyframe Interpolation

Type

Set the extrapolation mode for the selected F-Curves.

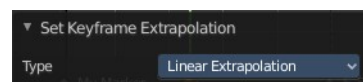

Reveal Curves

Reveals all hidden curves.

Last Operator Reveal Curves

Select

Select all revealed curves.

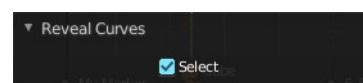

Hide selected Curves

Hides the selected curves.

Hide unselected curves

Hides the unselected curves.

Last Operator Hide Curves

Unselected

Hide the unselected or selected curves.



Expand Channels

Expands all channels in the channel list.

Last Operator Expand Channels

All

Expand all Channels, or just the selected channels.

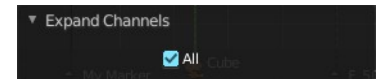

Collapse Channels

Collapses all channels in the channels list.

Last Operator Collapse Channels

All

Collapse all Channels, or just the selected channels.

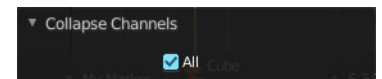

Move

Sort the items in the channels list.

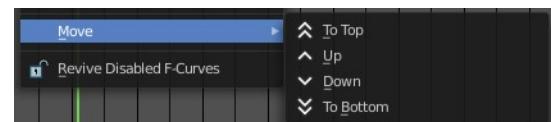

Last Operator Move Channels

Direction

Sort the items in the channels list.

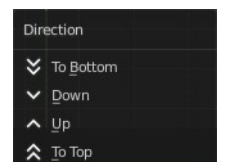
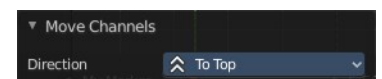

Revive Disabled F-Curves

Clears the disabled tag from all f-curves to get broken F-Curves working again.



19.1.6 Editors - Drivers Editor - Key Menu

Table of content

Drivers Editor - Key Menu.....	3
Transform.....	3
Grab/Move.....	3
Last Operator Move.....	3
Move X, Y Z.....	3
Orientation.....	3
Proportional editing.....	3
Proportional Falloff.....	3
Proportional Size.....	4
Connected.....	4
Projected(2D).....	4
Extend.....	4
Last Operator Transform.....	4
Values X, Y Z, W.....	4
Axis.....	4
Orientation.....	4
Proportional editing.....	4
Proportional Falloff.....	4
Proportional Size.....	4
Connected.....	4
Projected(2D).....	4
Rotate.....	5
Last Operator Rotate.....	5
Angle.....	5
Axis.....	5
Orientation.....	5
Proportional editing.....	5
Proportional Falloff.....	5
Proportional Size.....	5
Connected.....	5
Projected(2D).....	5
Scale.....	5
Last Operator Resize.....	6
Angle.....	6
Axis.....	6
Orientation.....	6
Proportional editing.....	6
Proportional Falloff.....	6
Proportional Size.....	6
Connected.....	6
Projected(2D).....	6
Snap.....	6
Last Operator Snap Keys.....	6
Type.....	6
Mirror.....	7
Last Operator Mirror Keys.....	7
Type.....	7

Insert Keyframes.....	7
Last Operator Insert Keyframes.....	7
Type.....	7
Jump to Keyframes.....	7
Copy Keyframes.....	7
Paste Keyframes.....	7
Paste Flipped.....	7
Last Operator Paste Keyframes / Flipped.....	7
Offset.....	7
Type.....	7
Flipped.....	8
Duplicate.....	8
Last Operator Duplicate.....	8
Mode.....	8
Values X / Y.....	8
Axis.....	8
Orientation.....	8
Proportional editing.....	8
Proportional Falloff.....	8
Proportional Size.....	8
Connected.....	8
Projected(2D).....	8
Delete Keyframes.....	8
Decimate (Ratio).....	9
Decimate (Allowed Change).....	9
Last Operator Decimate Keyframes.....	9
Mode.....	9
Remove or Max Error Margin.....	9
Clean Keyframes.....	9
Clean Channels.....	9
Last Operator Clean Keyframes.....	9
Threshold.....	9
Channels.....	9
Smooth Keys.....	9
Sample Keyframes.....	9
Bake Curve.....	9
Discontinuity (Euler) Filter.....	10

Drivers Editor - Key Menu

This menu contains functionality to manage the keyframes.

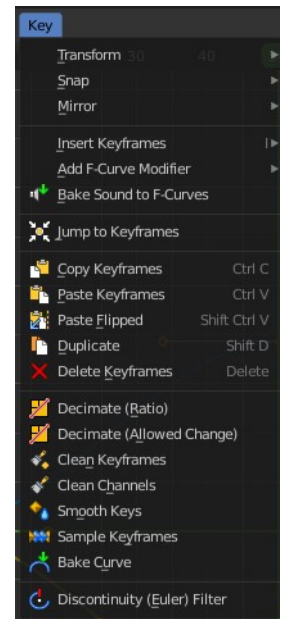

Transform

Grab/Move

Moves the selected keyframe(s).

Last Operator Move

Move X, Y Z

The position. Attention, the actual world orientation and rotation does not matter here. It always starts with a value of zero, and moves relative to this zero then. For the actual location values have a look in the sidebar in the transform panel.

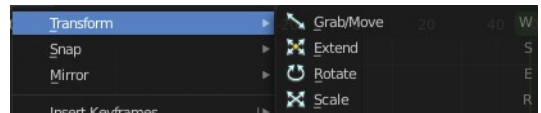

Orientation

The widget can have different orientations. The menu items should be self explaining.

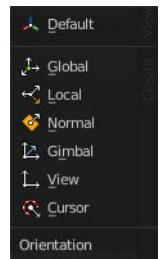
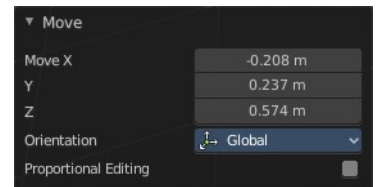

Proportional editing

Enables proportional editing. Activating proportional editing reveals further settings.

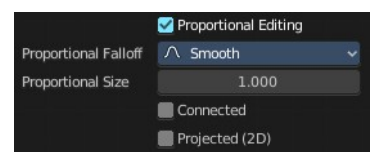

Proportional Falloff

Adjust the falloff methods.

Proportional Size

See and adjust the falloff radius.

Connected

The proportional falloff gets calculated for connected parts only.

Projected(2D)

The proportional falloff gets calculated in the screen space. Depth doesn't play a role. When it's in the radius, then it gets calculated.

Extend

Moves the last keyframes of the selection.

Last Operator Transform

Values X, Y Z, W

The new position.

Axis

Which axis to transform.

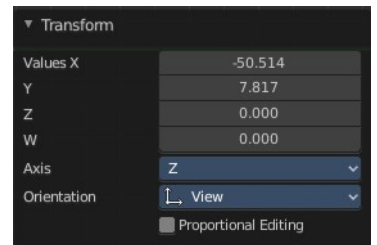

Orientation

The widget can have different orientations. The menu items should be self explaining.

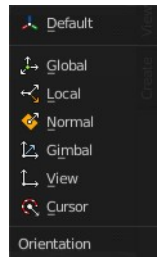

Proportional editing

Enables proportional editing. Activating proportional editing reveals further settings.

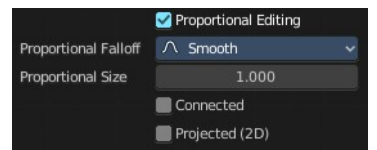

Proportional Falloff

Adjust the falloff methods.

Proportional Size

See and adjust the falloff radius.

Connected

The proportional falloff gets calculated for connected parts only.

Projected(2D)

The proportional falloff gets calculated in the screen space. Depth doesn't play a role. When it's in the radius, then it gets calculated.

Rotate

Rotates the selection.

Last Operator Rotate

Angle

The rotation. Attention, the actual world orientation and rotation does not matter here. It always starts with a value of zero, and rotates relative to this zero then. For the actual rotation values have a look in the sidebar in the transform panel.

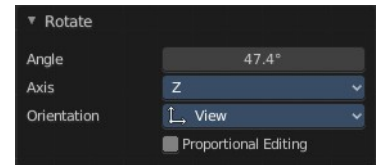

Axis

Which axis to rotate.

Orientation

The widget can have different orientations. The menu items should be self explaining.

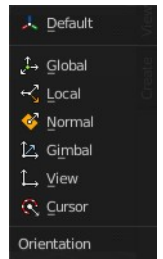

Proportional editing

Enables proportional editing. Activating proportional editing reveals further settings.

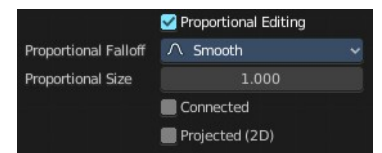

Proportional Falloff

Adjust the falloff methods.

Proportional Size

See and adjust the falloff radius.

Connected

The proportional falloff gets calculated for connected parts only.

Projected(2D)

The proportional falloff gets calculated in the screen space. Depth doesn't play a role. When it's in the radius, then it gets calculated.

Scale

Scales the selected keyframes. You need to have more than one keyframe selected.

Last Operator Resize

Angle

The rotation. Attention, the actual world orientation and rotation does not matter here. It always starts with a value of zero, and rotates relative to this zero then. For the actual rotation values have a look in the sidebar in the transform panel.

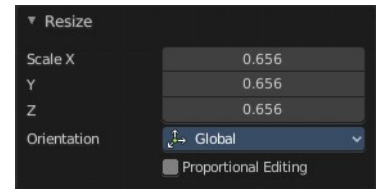

Axis

Which axis to rotate.

Orientation

The widget can have different orientations. The menu items should be self explaining.

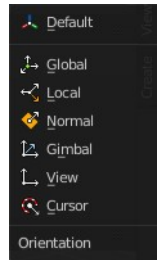

Proportional editing

Enables proportional editing. Activating proportional editing reveals further settings.

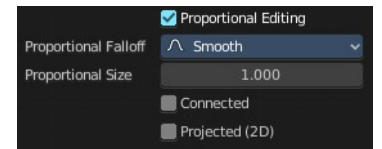

Proportional Falloff

Adjust the falloff methods.

Proportional Size

See and adjust the falloff radius.

Connected

The proportional falloff gets calculated for connected parts only.

Projected(2D)

The proportional falloff gets calculated in the screen space. Depth doesn't play a role. When it's in the radius, then it gets calculated.

Snap

Snaps the selected keyframes by the chosen method.

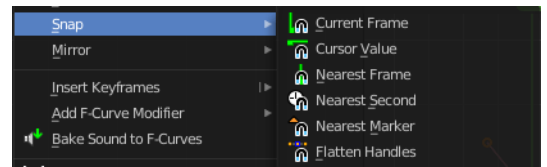

Last Operator Snap Keys

Type

Snaps the selected keyframes by the chosen method.

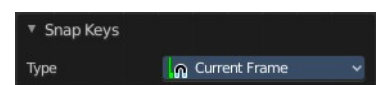

Mirror

Flips the selected keyframes over the current frame position.

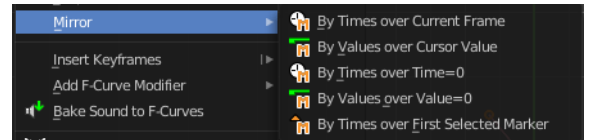

Last Operator Mirror Keys

Type

Flips the selected keyframes over the current frame position by the chosen method.

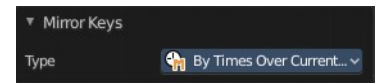

Insert Keyframes

Choose a method how to insert a new keyframe at the current frame position.

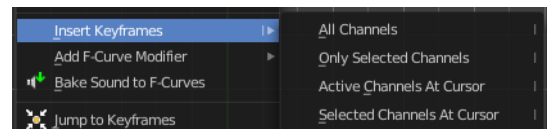

Last Operator Insert Keyframes

Type

Choose a method how to insert a new keyframe at the current frame position.

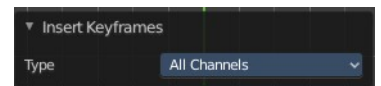

Jump to Keyframes

Sets the frame marker at the average position of the currently selected keyframes.

Copy Keyframes

Copy selected keyframes.

Paste Keyframes

Pastes copied keyframes.

Paste Flipped

Pastes copied keyframes, but flipped.

Last Operator Paste Keyframes / Flipped

Offset

Define an offset for the paste position.

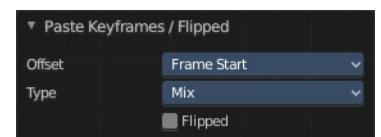

Type

Choose a method how to paste the copied keyframes.

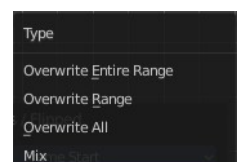

Flipped

Pastes keyframes from mirrored bones if they exists.

Duplicate

Duplicate selected keyframes.

Last Operator Duplicate

Mode

Values X / Y

The x and y values for the pasted keyframes. Note that these values starts at the position of the original copied keyframe. These values are relative.

Values Z and W have no effect here.

Axis

These values have no effect.

Orientation

These values have no effect.

Proportional editing

Enables proportional editing. Activating proportional editing reveals further settings.

Proportional Falloff

Adjust the falloff methods.

Proportional Size

See and adjust the falloff radius.

Connected

The proportional falloff gets calculated for connected parts only.

Projected(2D)

The proportional falloff gets calculated in the screen space. Depth doesn't play a role. When it's in the radius, then it gets calculated.

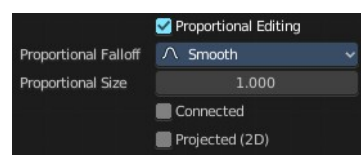
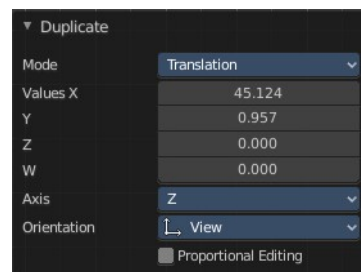

Delete Keyframes

Deletes selected keyframes.

Decimate (Ratio)

Decimate F-Curves by removing keyframes that that has the least influence to the curve shape.

Decimate (Allowed Change)

Decimate F-Curves by specifying how much it can deviate from the original curve.

Last Operator Decimate Keyframes

Mode

The decimate mode. Error margin is Allowed change.

Remove or Max Error Margin

The percentage of keyframes to remove.

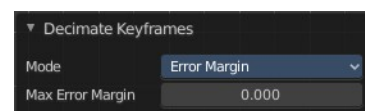

Clean Keyframes

Simplify FCurces by deleting keyframes that are close to each other in all channels.

Clean Channels

Simplify FCurces by deleting keyframes that are close to each other in selected channels.

Last Operator Clean Keyframes

Threshold

The threshold amount for the simplify algorithm.

Channels

Clean keyframes or channels.

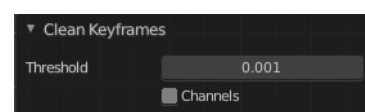

Smooth Keys

Make selected curves less bumpy.

Sample Keyframes

Adds keyframes at every unit between the selected keyframes.

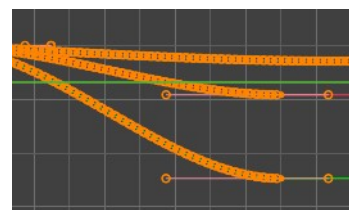

Bake Curve

Bake selected F-Curves to a set of sampled points. This makes the curve not longer editable.

Discontinuity (Euler) Filter

Try to fix large jumps and flips in the selected F Curve. This jumps can appear when rotation values are clipping by baking physics.



19.2 - Drivers Editor - Channel list

Table of content

Drivers Editor - Channel List.....	1
Hotkeys.....	1
Search field.....	1
Expand / collapse triangle.....	1
Object type Icon.....	1
Pin.....	2
Visibility.....	2
Channel name.....	2
Enable F-Curve Modifiers.....	2
Mute Channel.....	2
Lock Channel.....	2
Slider values.....	2

Drivers Editor - Channel List

The channel list contains your objects and their animation channels. See also the different modes.

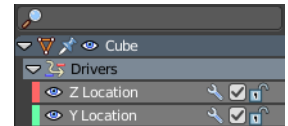

The channel list area can be resized by dragging the right border to left or right.

The list has several elements, to turn on or off different features, Or to expand or collapse the hierarchy.

Hotkeys

Hotkey A selects all channels.

Hotkey Alt A deselects everything.

Left mouse and dragging activates box select.

Clicking at a channel selects it.

Clicking at a channel while holding down shift adds to the selection or removes from the selection.

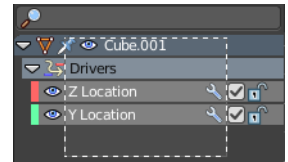

Search field

At the top is a search field that allows you to filter the channel list by search terms.



Expand / collapse triangle

The triangle icon at the left allows you to expand or collapse the hierarchy.

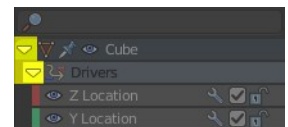

Object type Icon

This icon shows what kind of object this channel belongs to. These icons have no

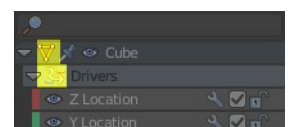

functionality.

Pin

Normally just the channels for selected objects are visible. With Pin the channels remains visible in Drivers Editor, even when you select another object.

Visibility

Hide the channel.

Channel name

The name of the channel name and element. Some elements can be renamed. Like the action or object type.

To rename an element double click at it. Type in the new name. Then press Enter or click elsewhere.

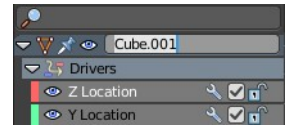

Enable F-Curve Modifiers

In the Drivers editor you can add F-Curve modifiers in the sidebar. Enable or disable these modifiers by the Enable F-Curve Modifiers setting in the channel list.

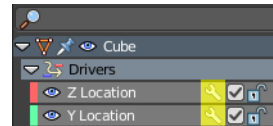

Mute Channel

Mutes the selected channel. It will not be calculated.

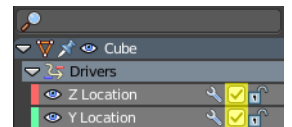

Lock Channel

Locks the selected channel. It is not longer editable.

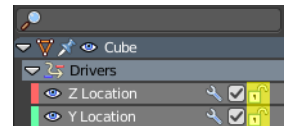

Slider values

F-Curves can show a slider value in the channel list. This can be adjusted in the sidebar in the View options panel. Show Sliders is off by default.

You can edit these values. Double click to make it editable. Enter or click elsewhere to confirm. When you confirm, then the original keyframe gets updated.

When no keyframe exists at the current position, then this keyframe gets created.

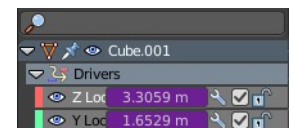



19.3.1 Editors - Drivers Editor - Sidebar - F-Curve Tab

Table of content

- F-Curve Tab - Active F-Curve Panel.....1
 - Channel Name.....1
 - RNA Path.....1
 - RNA Array Index.....1
 - Display Color.....1
 - Handle Smoothing.....2
 - None.....2
 - Continuous Acceleration.....2
- F-Curve Tab - Active Keyframe Panel.....2
 - Interpolation.....2
 - Key Frame.....2
 - Value.....2
 - Left Handle Type / Right Handle Type.....2
 - Free.....2
 - Aligned.....3
 - Vector.....3
 - Automatic.....3
 - Auto Clamped.....3
 - Frame.....3
 - Value.....3

F-Curve Tab - Active F-Curve Panel

This panel displays the properties for the active F-Curve.

Note that you need to have a channel selected to reveal the tabs.

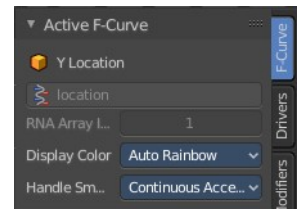

Channel Name

The name of the currently active F-Curve channel.

RNA Path

RNA Path to property. This is a read only information.

RNA Array Index

The RNA Array Index to the specific property affected by the F-Curve if applicable. This is a read only information.

Display Color

With what colors to display the curves. User defined allows you to choose a custom color for the curve. A color field appears. The other methods works

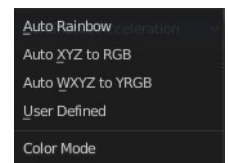

random.

Handle Smoothing

Select the method to compute automatic Bezier Handles.

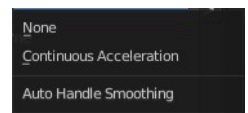

None

Only directly adjacent key values are used when computing the handles. Vector handles points directly at the adjacent keyframes.

Continuous Acceleration

Also keyframes behind the next or previous keyframe gets used for calculation. Which results in a smoother curve.

F-Curve Tab - Active Keyframe Panel

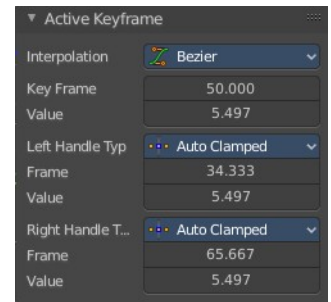

Interpolation

Set the interpolation type for this keyframe.

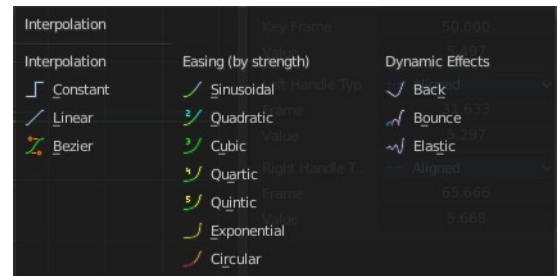

Key Frame

The current position of this keyframe.

Value

The Y value of this keyframe.

Left Handle Type / Right Handle Type

Set the handle type. The handles of a keyframe can be independent. Some constellations just works with some other constellations.

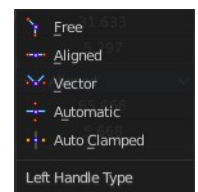

Free

Move and adjust the handles independently.

Aligned

With the left handler the right handler moves too.

Vector

Creates a curve with straight lines.

Automatic

Creates a smooth curve.

Auto Clamped

Creates a smooth curve that only changes the direction at other curve points. It is clamped to prevent overshoots in the curve shape.

Frame

The current frame of this handle.

Value

The current Y position of this handle.



19.3.2 Editors - Drivers Editor - Sidebar - Drivers Tab

Table of content

Driven Property Panel.....	2
Driver Panel.....	2
Type.....	2
Built in functions.....	2
Scripted Expression.....	2
Expression.....	2
Use Self.....	2
Add Input Variable.....	3
Copy Driver variable.....	3
Paste Driver variable.....	3
Driver variable panel.....	3
Variable type.....	3
Single Property.....	3
Prop.....	3
Type.....	3
ID.....	4
Path.....	4
Setting up by hand.....	4
Setting up by Copy as New Driver.....	4
Value.....	5
Transform Channel.....	5
Type.....	5
Rotation Mode.....	5
Transform space.....	6
World Space.....	6
Transform Space.....	6
Local Space.....	6
Value.....	6
Rotational Difference.....	6
Object 1.....	6
Bone Name.....	6
Object 2.....	6
Value.....	6
Distance.....	6
Object 1.....	6
Bone Name.....	6
Transform space.....	6
World Space.....	6
Transform Space.....	7
Local Space.....	7
Object 2.....	7
Transform space.....	7
World Space.....	7
Transform Space.....	7
Local Space.....	7
Value.....	7
Variable name.....	7

Delete Target Variable.....7
 Update Dependencies.....7

Driven Property Panel

This panel displays the driven property of the object. It is read only.

Note that you need to have a channel selected to show the tabs.

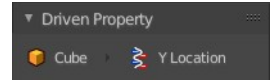

Driver Panel

The actual driver with all its settings.

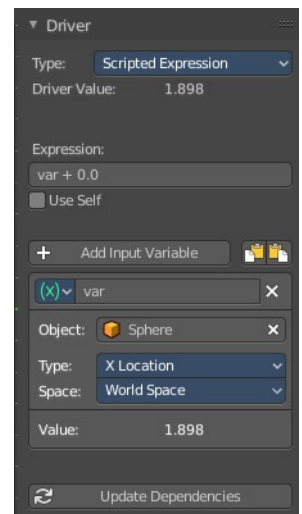

Type

Built in functions

Average, Sum, Min and Max are Built-In functions. The driven property will have the value of the average, sum, lowest or highest values of the referenced driver variables. Remember that you can add more than one input variable. So when you for example use the X position of two cubes as the input, and the method Average, then the driven object will be located at the average X value of cube 1 and cube 2.

When there is just one Input variable, then the driven object will be positioned at the value of the driver object.

Scripted Expression

Allows you to use Python expressions that can refer to the driver variables by name. An expression allows you to use standard constants and math functions.

Expression

A text field with the current expression. Not available with all variable types.

Use Self

The variable Self can be used for drivers to reference their own data. Example:

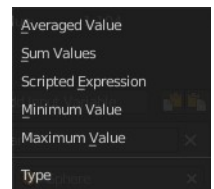

self.location.x applied to the Y rotation property of the same object will make the object tumble when moving. Note that dependencies for properties accessed via self may not be fully tracked.

Add Input Variable

Adds a new driver variable.

Copy Driver variable

Copies the driver variable.

Paste Driver variable

Pastes a copied driver variable.

Driver variable panel

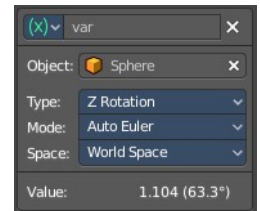

Variable type

The type of variable to use.

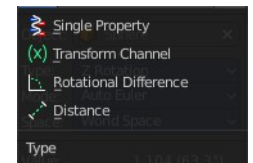

Single Property

Allows you to retrieve a single value of a RNA Property, specified by a data block reference (the source object) and a path string (the property of this source object).

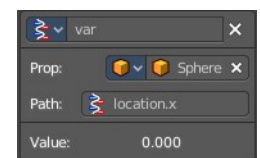

Prop

Type

Define the input type of the object. You can retrieve values from nearly every object type.

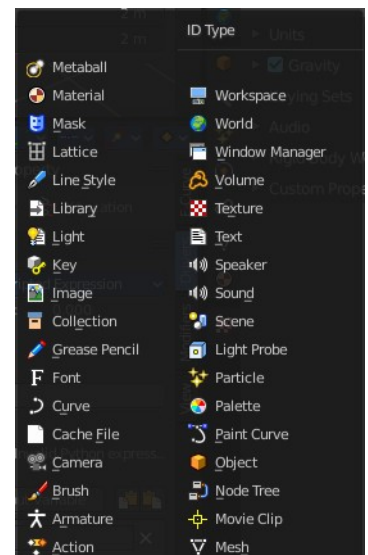

ID

The source object. This is also a drop down field where you can pick objects from the scene.

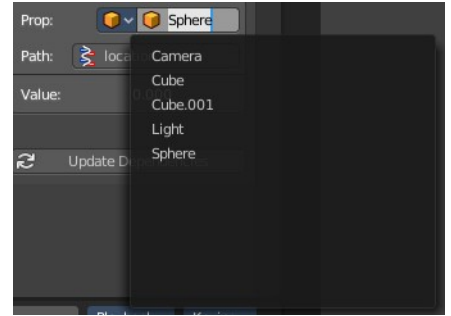

Path

The path string to use. This defines the property where you get the value from.

Setting up by hand

Have a look at the python tool tip in the property of the source object. The bpy.data string gives you a hint of the expression that you need.

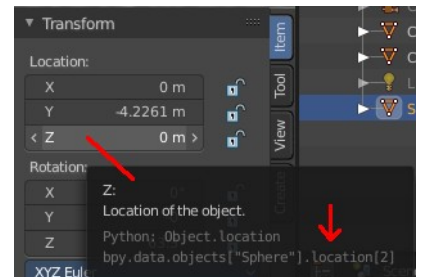

For example, if i want to use the Z location of the sphere as the driver value.

The python string in the tool tip of the Z location property says

```
bpy.data.objects["Sphere"].location[2]
```

The sphere is already chosen as the source object. Remains the part behind objects["Sphere"] in the string.

location[2]

To use location[2] in the path will already work. But you can point directly to the single axis too. The tool tip uses an array for the axis. 0 for X, 1 for Y and 2 for Z. When you want to use the axis letters, then you need a dot between location and the axis letter. And so the other working string is:

location.z

Setting up by Copy as New Driver

The easier way is to right click at the value that you want to use as the driver value. Here choose Copy as new Driver. In the target property choose Paste Driver. And this creates a driver with the correct values then that contains all relevant settings.

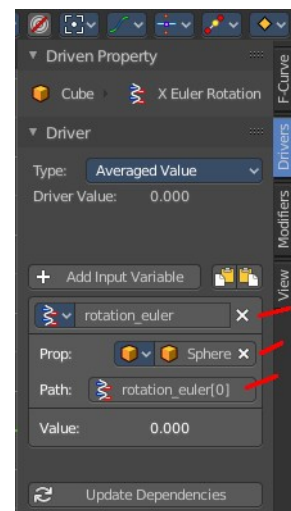
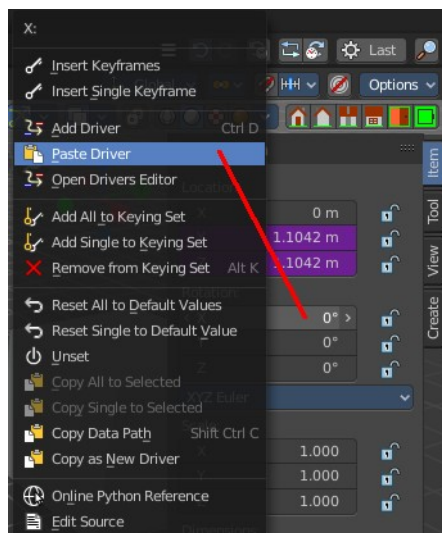
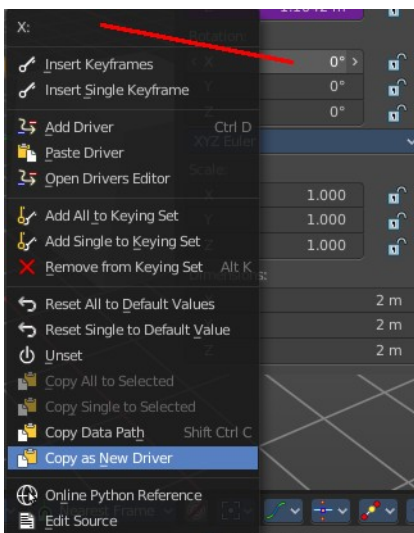

Value

The result of the driver variable. Read only.

Transform Channel

Uses the transform values of the source object.

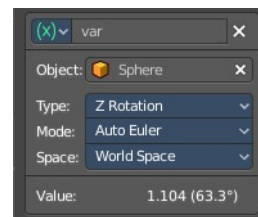

Type

The transform type.



Rotation Mode

Just for Rotation transformations. The rotation mode.



Transform space

In which transform space the transformation should happen.

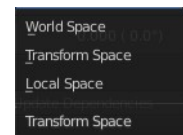

World Space

Transforms includes effect of parenting / restpose and constraints.

Transform Space

Transforms don't include effect of parenting / restpose and constraints.

Local Space

Transforms include constraints, but not effect of parenting / restpose.

Value

The result of the driver variable. Read only.

Rotational Difference

Use the angle between two bones. The parent bone acts as the second bone here.

Object 1

The source armature.

Bone Name

The source bone of this armature.

Object 2

The target object.

Value

The result of the driver variable. Read only.

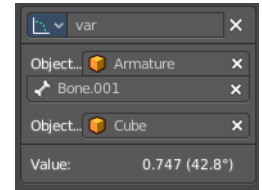
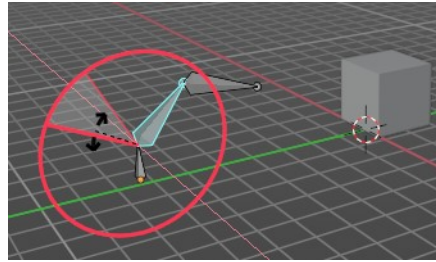

Distance

The distance between two bones or objects is used for the driver.

Object 1

The source armature.

Bone Name

The source bone of this armature.

Transform space

In which transform space the transformation should happen.

World Space

Transforms includes effect of parenting / restpose and constraints.

Transform Space

Transforms don't include effect of parenting / restpose and constraints.

Local Space

Transforms include constraints, but not effect of parenting / restpose.

Object 2

The target object.

Transform space

In which transform space the transformation should happen.

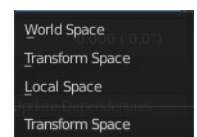
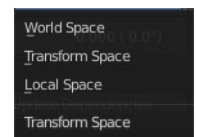
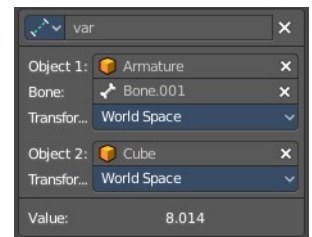

World Space

Transforms includes effect of parenting / restpose and constraints.

Transform Space

Transforms don't include effect of parenting / restpose and constraints.

Local Space

Transforms include constraints, but not effect of parenting / restpose.

Value

The result of the diver variable. Read only.

Variable name

The name of the variable. This name of the variable is used for calculation in the expression. This variable can be renamed. Make sure to update the name of the variable in the expression then too.

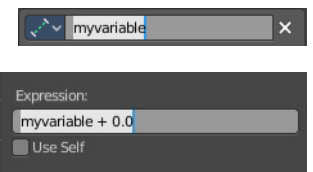

Delete Target Variable

Removes the variable.

Update Dependencies

Some changes may not update automatically. Update dependencies updates all the changes done to the drivers.



19.3.3 Editors - Drivers Editor - Sidebar - Modifiers Tab

Table of content

Detailed table of content.....	1
Modifiers Tab - Modifiers Panel.....	3
Modifier header.....	3
Generator modifier.....	4
Built- in Function modifier.....	5
Envelope modifier.....	6
Cycles modifier.....	8
Noise modifier.....	9
Limits modifier.....	10
Stepped Interpolation modifier.....	11

Detailed table of content

Detailed table of content

Detailed table of content.....	1
Modifiers Tab - Modifiers Panel.....	3
Add Modifier.....	3
Copy F-Curve Modifiers.....	3
Paste F-Curve Modifiers.....	3
Last Operator Add F-Curve Modifier.....	3
Type.....	3
Only Active.....	3
Modifier header.....	3
Triangle button.....	4
Active.....	4
Modifier name.....	4
Muted.....	4
Delete F-Curve Modifier.....	4
Generator modifier.....	4
Polynomial Mode.....	4
Additive.....	4
Poly Order Expanded mode.....	4
Poly Order Factorized mode.....	5
Restrict Frame Range.....	5
Start / End.....	5
In / Out.....	5
Use Influence.....	5
Influence.....	5
Built- in Function modifier.....	5
Curve Type.....	5
Amplitude.....	5
Phase Multiplier.....	6
Phase Offset.....	6
Value Offset.....	6
Restrict Frame Range.....	6

Start / End.....	6
In / Out.....	6
Use Influence.....	6
Influence.....	6
Envelope modifier.....	6
Envelope.....	7
Reference Value.....	7
Min.....	7
Max.....	7
Control Points.....	7
Add Point.....	7
Point values.....	7
Frame.....	7
Min.....	7
Max.....	7
Delete.....	7
Restrict Frame Range.....	7
Start / End.....	7
In / Out.....	8
Use Influence.....	8
Influence.....	8
Cycles modifier.....	8
Trivially Cyclic Curves.....	8
Before.....	8
Before Cycles.....	8
After.....	8
After Cycles.....	9
Restrict Frame Range.....	9
Start / End.....	9
In / Out.....	9
Use Influence.....	9
Influence.....	9
Noise modifier.....	9
Blend Type.....	9
Scale.....	9
Strength.....	10
Offset.....	10
Phase.....	10
Depth.....	10
Restrict Frame Range.....	10
Start / End.....	10
In / Out.....	10
Use Influence.....	10
Influence.....	10
Limits modifier.....	10
Minimum / Maximum X.....	11
Minimum / Maximum Y.....	11
Restrict Frame Range.....	11
Start / End.....	11
In / Out.....	11
Use Influence.....	11
Influence.....	11
Stepped Interpolation modifier.....	11

Step Size.....	11
Offset.....	11
Use Start Frame.....	12
Use End Frame.....	12
Restrict Frame Range.....	12
Start / End.....	12
In / Out.....	12
Use Influence.....	12
Influence.....	12

Modifiers Tab - Modifiers Panel

F-Curve modifiers are similar to Object modifiers. They allow to add adjustable non destructive effects. And they can be layered on top of each other.

Different to the Object modifiers you can't reorder this modifiers. You have to create it in the order that you need it.

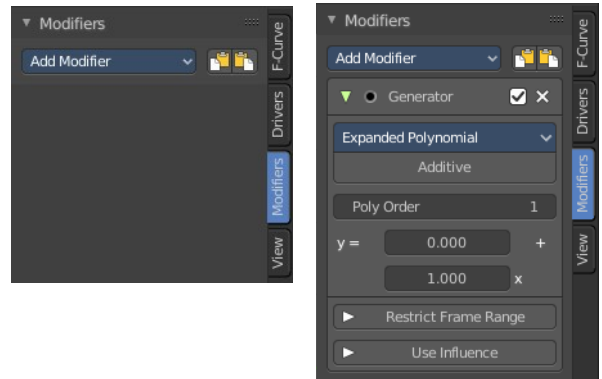

Add Modifier

The list of modifiers. Choose by clicking.

Copy F-Curve Modifiers

Copy the F-Curve Modifiers of the active F-Curve.

Paste F-Curve Modifiers

Paste copied F-Curve modifiers to the active F-Curve.

Last Operator Add F-Curve Modifier

Type

A drop down list with the Type of modifier to add.

Only Active

Only add a modifier to the currently active curve.

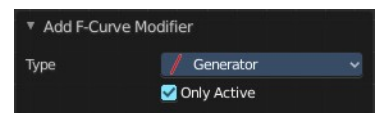
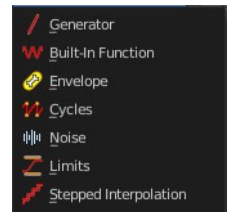

Modifier header

Every modifier is a panel. And every panel has a header area with some general UI elements.

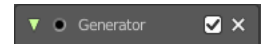

Triangle button

Every modifier panel can be expanded or collapsed by clicking at this triangle button.

Active

This is the panel that you currently edit. When you edit a panel while it is not set to the active one, then the changes will not be applied.

Modifier name

The name of the modifier. Read only.

Muted

Enable or disable this modifier.

Delete F-Curve Modifier

Delete this modifier.

Generator modifier

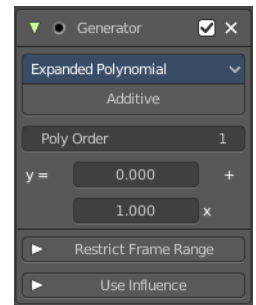

Polynomial Mode

Use Expanded Polynomial or Factorized Polynomial algorithm. With these mathematical formulas you can create lines, parabolas, and other more complex curves by changing the values in the poly order field.



Additive

Add on top of the existing curve instead of replacing the existing curve.

Poly Order Expanded mode

The polynomial formula for the Expanded mode. By increasing the Poly Order value you can add more polynomial fields to the formula.

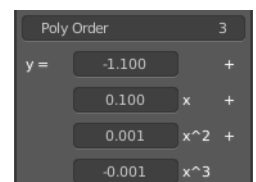

Change the values to the desired results.

Poly Order Factorized mode

The polynomial formula for the Factorized mode. By increasing the Poly Order value you can add more polynomial fields to the formula.

Change the values to the desired results.

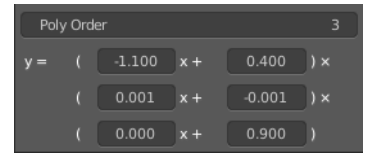

Restrict Frame Range

Expanding the Restrict Frame range sets it to active. It reveals some value slider then.

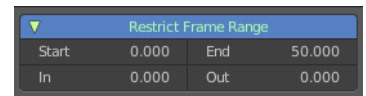

Start / End

The start and end frame of the generated curve.

In / Out

Fade the curve in or out for chosen frame numbers.

Use Influence

Temper the F-Curve Modifier effect by a default influence factor.

Expanding the Use Influence sets it to active. It reveals a value slider then.

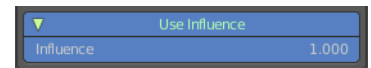

Influence

The influence factor.

Built- in Function modifier

Generate a curve by built in functions.

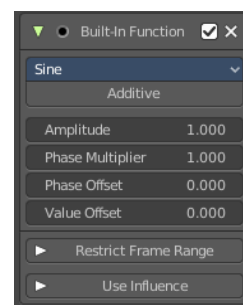

Curve Type

The available wave forms for the curve.

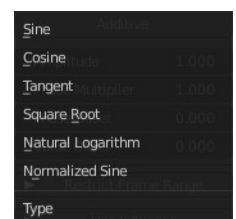

Amplitude

The amplitude of the curve wave. Adjusts the Y scaling.

Phase Multiplier

A phase multiplier for the curve wave. Adjusts the X scaling.

Phase Offset

A phase offset for the curve wave. Adjusts the Y scaling.

Value Offset

A constant value offset for the whole curve. Adjusts the X scaling.

Restrict Frame Range

Expanding the Restrict Frame range sets it to active. It reveals some value slider then.

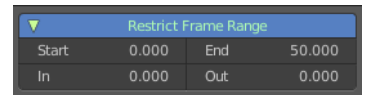

Start / End

The start and end frame of the generated curve.

In / Out

Fade the curve in or out for chosen frame numbers.

Use Influence

Temper the F-Curve Modifier effect by a default influence factor.

Expanding the Use Influence sets it to active. It reveals a value slider then.

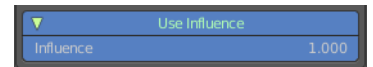

Influence

The influence factor.

Envelope modifier

The Envelope modifier allows you to modify the overall shape of the curve by control points.

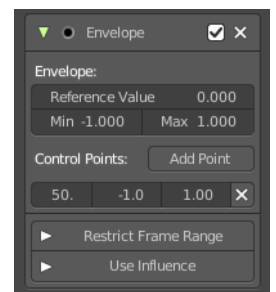
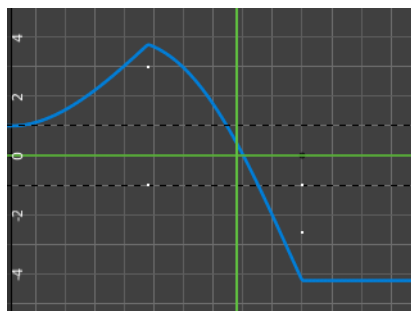
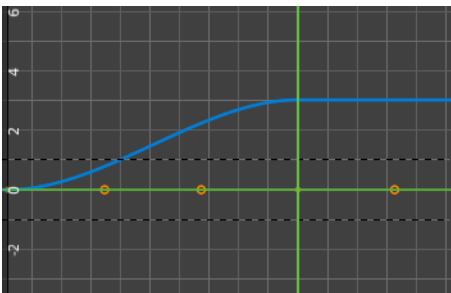

Envelope

Reference Value

Set the Y value to center the envelope around.

Min

The lower distance from reference value for 1:1 default influence.

Max

The higher distance from reference value for 1:1 default influence.

Control Points

Add Point

Add a control point. A control point has two sub points, a lower control point and a higher control point.

Point values

Adding a control point adds an entry in the Point Values list. Every added control point has its own values that can be modified here.

Frame

The frame position of this control point.

Min

The position of the lower control point.

Max

The position of the higher control point.

Delete

Delete this envelope control point.

Restrict Frame Range

Expanding the Restrict Frame range sets it to active. It reveals some value slider then.



Restrict Frame Range			
Start	0.000	End	50.000
In	0.000	Out	0.000

Start / End

The start and end frame of the generated curve.

In / Out

Fade the curve in or out for chosen frame numbers.

Use Influence

Temper the F-Curve Modifier effect by a default influence factor.

Expanding the Use Influence sets it to active. It reveals a value slider then.

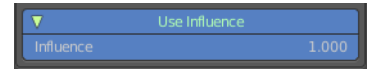

Influence

The influence factor.

Cycles modifier

Add a cyclic motion to a curve that has two or more control points. The option can be set before or after the curve.

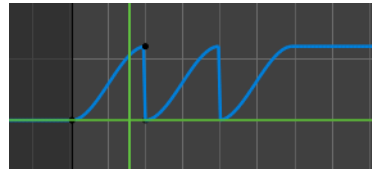
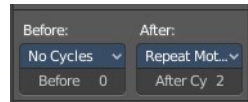
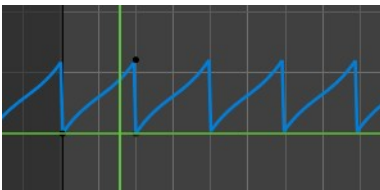
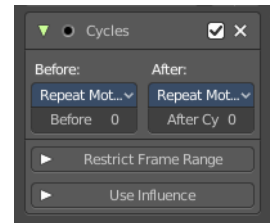

Trivially Cyclic Curves

When the Cycle Mode for both ends is set to either Repeat Motion or Repeat with Offset, and no other options of the modifier are changed from their defaults, it defines a simple infinite cycle.

This special case receives some additional support from other areas of Blender:

Automatic Bezier handle placement is aware of the cycle and adjusts to achieve a smooth transition.

The Cycle-Aware Keying option can be enabled to take the cycle into account when inserting new keyframes.

Before

Set the cycle mode before the first keyframe.

Before Cycles

Maximum number of cycles to allow before first keyframes. A value of 0 means infinite.

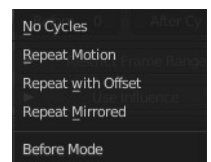

After

Set the cycle mode after the first keyframe.



After Cycles

Maximum number of cycles to allow after last keyframes. A value of 0 means infinite.

Restrict Frame Range

Expanding the Restrict Frame range sets it to active. It reveals some value slider then.

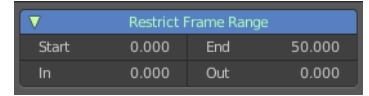

Start / End

The start and end frame of the generated curve.

In / Out

Fade the curve in or out for chosen frame numbers.

Use Influence

Temper the F-Curve Modifier effect by a default influence factor.

Expanding the Use Influence sets it to active. It reveals a value slider then.

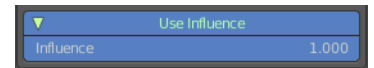

Influence

The influence factor.

Noise modifier

Adds noise to the curve.

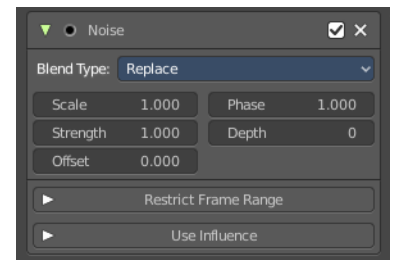
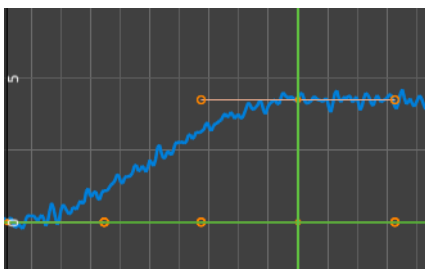

Blend Type

How to blend the noise with the curve.

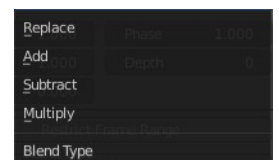

Scale

The overall size of the noise. The bigger the value the less frequent the noise.

Strength

Adjust the Y value of the noise.

Offset

Time offset of the noise.

Phase

The random seed for the noise.

Depth

How detailed the noise function is.

Restrict Frame Range

Expanding the Restrict Frame range sets it to active. It reveals some value slider then.

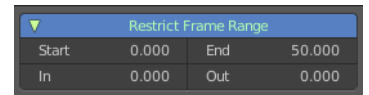

Start / End

The start and end frame of the generated curve.

In / Out

Fade the curve in or out for chosen frame numbers.

Use Influence

Temper the F-Curve Modifier effect by a default influence factor.

Expanding the Use Influence sets it to active. It reveals a value slider then.

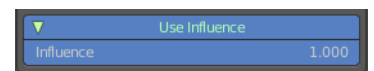

Influence

The influence factor.

Limits modifier

Sets limits to the curve in specified x and y range values.

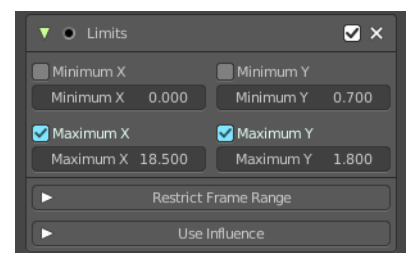
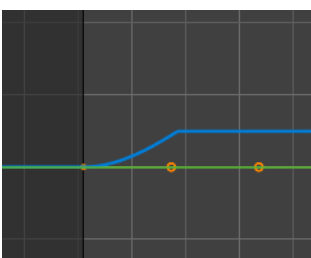

Minimum / Maximum X

Cuts the curve at these minimum and maximum frame values.

Minimum / Maximum Y

Clamps the curve at these minimum and maximum values.

Restrict Frame Range

Expanding the Restrict Frame range sets it to active. It reveals some value slider then.

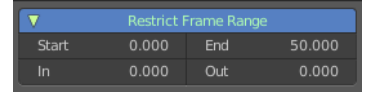

Start / End

The start and end frame of the generated curve.

In / Out

Fade the curve in or out for chosen frame numbers.

Use Influence

Temper the F-Curve Modifier effect by a default influence factor.

Expanding the Use Influence sets it to active. It reveals a value slider then.

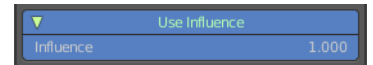

Influence

The influence factor.

Stepped Interpolation modifier

Adds steps to the curve by rounding the values.

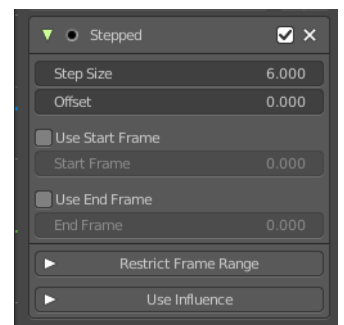
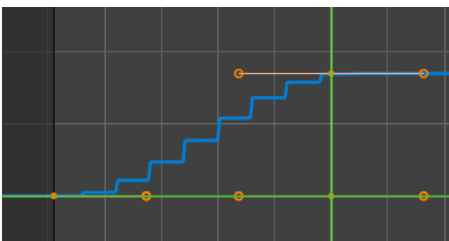

Step Size

The number of frames to hold each frame

Offset

A number of offset frames before frames get held.

Use Start Frame

Restrict the modifier so that it just acts before its end frame.

Use End Frame

Restrict the modifier so that it just acts after its start frame.

Restrict Frame Range

Expanding the Restrict Frame range sets it to active. It reveals some value slider then.

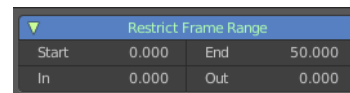

Start / End

The start and end frame of the generated curve.

In / Out

Fade the curve in or out for chosen frame numbers.

Use Influence

Temper the F-Curve Modifier effect by a default influence factor.

Expanding the Use Influence sets it to active. It reveals a value slider then.

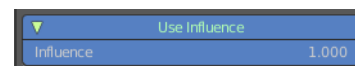

Influence

The influence factor.



19.3.4 Editors - Driver Editor - Sidebar - View Tab

Table of content

Show Cursor panel.....	1
Show Cursor checkbox.....	1
Cursor X.....	1
Cursor Y.....	1
Cursor to Selection.....	1
Cursor Value to Selection.....	1

Show Cursor panel

The green playhead at the top is the time cursor. The horizontal green line is called the cursor. Or ground line cursor. Together they are the 2d cursor.

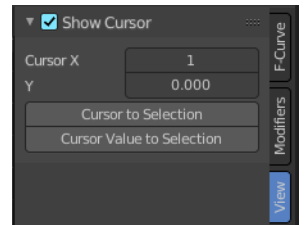
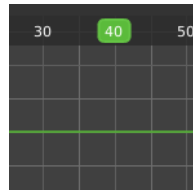

Show Cursor checkbox

Hides the green ground line cursor.

Cursor X

The frame position of the playhead cursor.

Cursor Y

The Y position of the ground line cursor.

Cursor to Selection

Sets both cursors to the center of the selection. This button also works when the ground line cursor is deactivated. In this case just the playhead cursor gets set to the center of the selection.

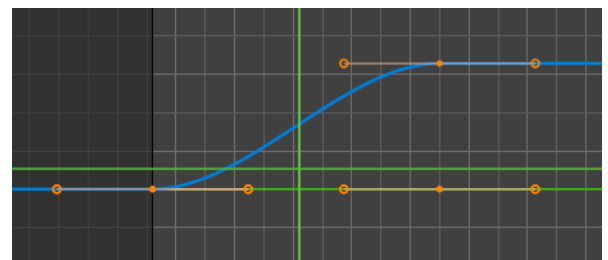

Cursor Value to Selection

Place the cursor value on the average value of selected keyframes.



20 Editors - Nonlinear Animation Editor

Table of content

Non-Linear Animation Editor.....	2
Editor Areas.....	2
Time cursor.....	2
Strip types.....	2
Action Strips.....	3
Transition Strips.....	3
Meta Strips.....	3
Sound Clip Strips.....	3
Viewport Navigation.....	3
Viewport navigation.....	3
Dope Sheet Channel Context Menu.....	4
Frame selected channels.....	4
Mute Channel.....	4
Unmute Channel.....	4
Protect Channels.....	4
Unprotect Channels.....	4
Group Channels.....	4
Ungroup Channels.....	4
Toggle Channel Editability.....	4
Extrapolation Mode submenu.....	4
Extrapolation Mode.....	4
Constant Extrapolation.....	4
Linear Extrapolation.....	5
Make Cyclic.....	5
Clear Cyclic.....	5
Expand Channels.....	5
Collapse Channels.....	5
Move submenu.....	5
Delete Channels.....	5
NLA Context Menu.....	5
Start Editing Stashed Actions.....	5
Start Tweaking Strip Actions(Full Stack).....	6
Start Tweaking Strip Actions(Lower Stack).....	6
Duplicate.....	6
Rename.....	6
Linked Duplicate.....	6
Split Strips.....	6
Delete Strips.....	6
Add Meta Strips.....	7
Remove Meta Strips.....	7
Swap Strips.....	7
Snap.....	7
Slider snapping.....	7
Quick Favorites menu.....	7
How to.....	7

Non-Linear Animation Editor

In the NLA Editor you can use and work with so called Actions, which contains the animation data. Instead of working with the single keyframes you work with strips made from these keyframes.

Editor Areas

The Non-Linear Animation Editor has several areas.

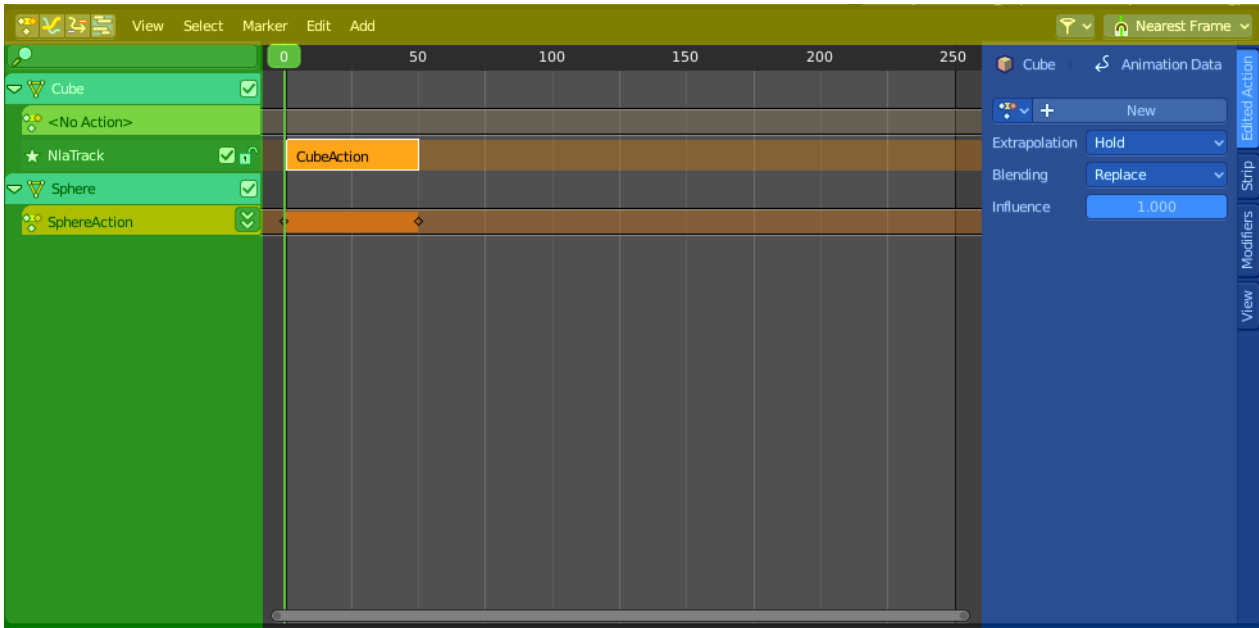

Header (Yellow)

Channel list (Green)

Sidebar (Blue). The sidebar needs to be revealed, which can be done by clicking at the small triangle button up right.

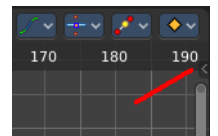

Viewport (no color)

The header is divided into two parts. Left tools and menus. Right Options.



Menus (Green)

Options (Yellow)

Time cursor

The Time Cursor is the green slider at the top. It is used to set and display the current time frame.

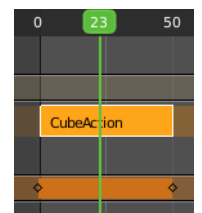

Strip types

There are three types of strips.

Action Strips

Action Strips contains the actual converted keyframe data.

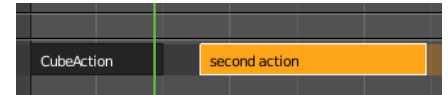

Transition Strips

Transition strips can be created by adding a transition between two Action strips. Select both action strips. In the Add menu choose Add Transition.



Meta Strips

Meta Strips can be created by joining action strips together. Meta Strips still contains the Action strips that they are made of, and can be ungrouped in the add menu with remove meta.



Sound Clip Strips

Controls when a speaker plays a sound clip. This strip type requires a Speaker object with a sound clip assigned. You can create a speaker object in the 3D view. The sample can be loaded in the Object Data Properties tab in the Properties editor then.

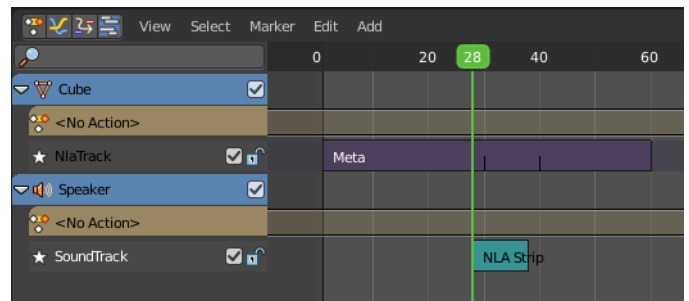

Viewport Navigation

Navigation in the viewport happens by mouse or hotkeys. Some of them does not have a menu entry. And needs to be explained here.

Viewport navigation

Clicking left at the number bar moves the frame marker.

Middle mouse button pans the view.

Holding ctrl + middle mouse button zooms the view.

Scroll Wheel zooms the view.

Dope Sheet Channel Context Menu

When you right click into the channel area, then you will call the Dope Sheet Channel context menu.

Frame selected channels

Centers the selected channels in view.

Mute Channel

This channel is not calculated.

Unmute Channel

This channel is calculated.

Protect Channels

Protect channels from editing.

Unprotect Channels

Enables editing of channels again.

Group Channels

Groups channels together.

Ungroup Channels

Ungroup grouped channels. Beware, the channels will not return to their initial group.

Toggle Channel Editability

Protects or unprotects the selected channels.

Extrapolation Mode submenu

Extrapolation Mode

Sets the extrapolation mode for the selected F-Curves. Means how the curve acts at the beginning and the end of the F-Curve.

Constant Extrapolation

The animation curve continues straight at the end.

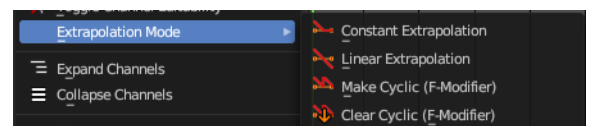
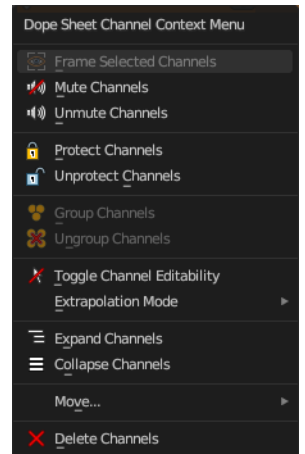

Linear Extrapolation

The animation curve continues the last direction.

Make Cyclic

Makes the animation loopable. The interpolation curves are adjusted so that the first frame fits to the last frame.

Clear Cyclic

Removes the cyclic extrapolation.

Expand Channels

Expands the channels.

Collapse Channels

Collapses the channels.

Move submenu

Sort the order of the channels. The menu items should be self explaining.

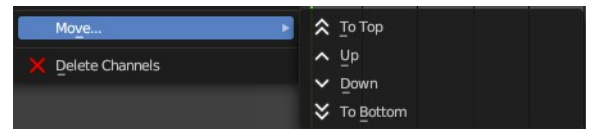

Delete Channels

Removes the selected channels.

NLA Context Menu

When you double right click into the viewport then you will call the NLA context menu.

Start Editing Stashed Actions

Same as Start Tweaking Strip Actions. But with Solo already ticked. Which allows editing of the animation data for this strip only.

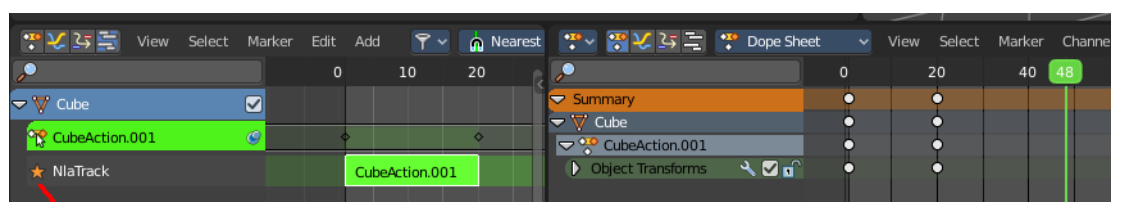
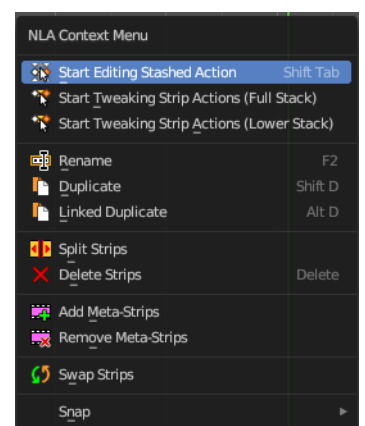
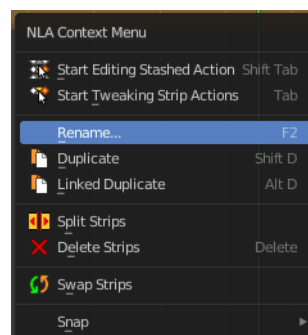

Start Tweaking Strip Actions(Full Stack)

Allows you to edit the keyframe data within the Action strip. The strip will turn grey, and in the Dope Sheet editor you will find the keyframes again, which you can tweak now. Preserves the pose that you visually keyed while upper strips are evaluating.

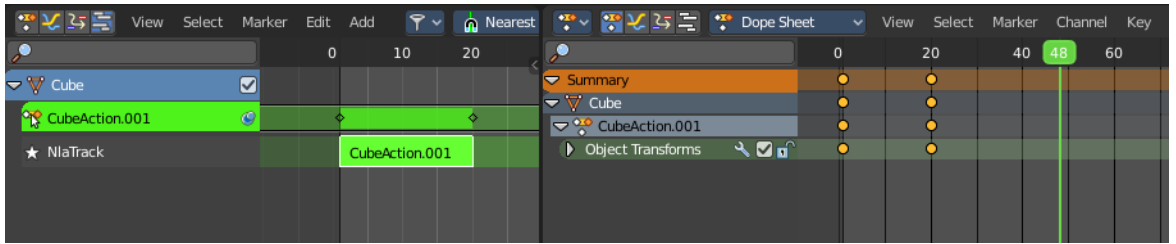

Start Tweaking Strip Actions(Lower Stack)

Allows you to edit the keyframe data within the Action strip. The strip will turn grey, and in the Dope Sheet editor you will find the keyframes again, which you can tweak now.

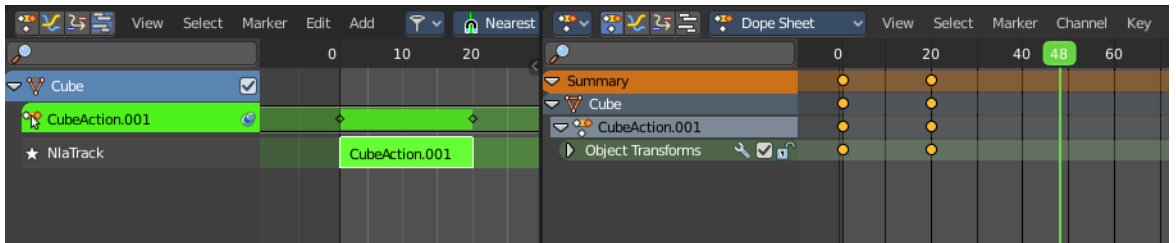

Duplicate

Duplicates the selected strip(s), and creates a new track for the duplicates. This copy is independent.

Rename

Allows you to rename the current NLA strip. The operator calls a rename popup.

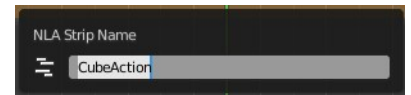

Linked Duplicate

Duplicates the selected strip(s), and creates a new track for the duplicates. This copy is linked to the original action strip. Modifications at the original will also affect the linked action strip.

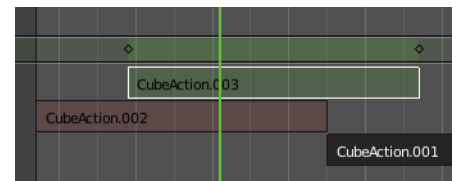

Linked strips are visually different from normal strips. And when you start to modify the linked duplicate, then the original strip will turn red.

Split Strips

Splits the selected strip(s) at the marker position.

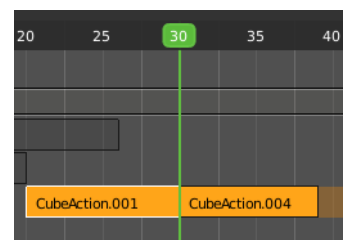

Delete Strips

Deletes the selected strips.

Add Meta Strips

Turns selected strips into a meta strip. A group of strips.

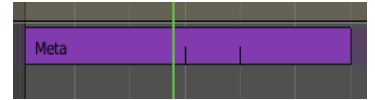

Remove Meta Strips

Ungroups the meta strips into its original action strips.

Swap Strips

Swaps the selected strips.

Snap

Snaps the selected strips by the chosen method.

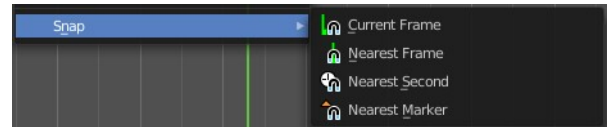

Slider snapping

Snapping also works at sliders. Hover with the mouse over the slider, start to slide, and holding down **ctrl** will snap the sliders in incremental steps.



When it's a default value between 0 and 1 then it usually snaps in 0.1 steps. When it's a default value over 1 then it usually snaps in steps of 10.

The increment snapping also works at the frame slider. here the incremental snapping happens by the frame rate that you have defined. With a frame rate of 24 it will snap in steps of 24 frames when holding down ctrl.

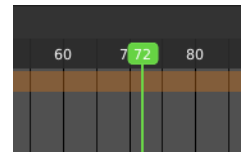

Quick Favorites menu

When you right click at a menu or a button, then a right click menu will open. Tools have usually a Add to Quick Favorites menu entry.

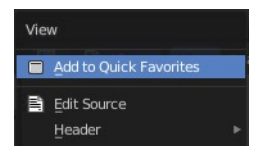

The Quick Menu is empty by default. With Add to Quick favorites you can add this menu to the Quick menu.

In the 3D view we have a menu called Quick in the header, which shows this content then. In the Dope Sheet Editor you can just call it with its hotkey. Q. It has no regular menu entry here.

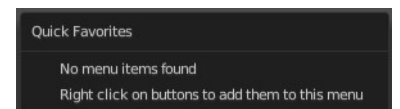

How to

First create a keyframe animation.

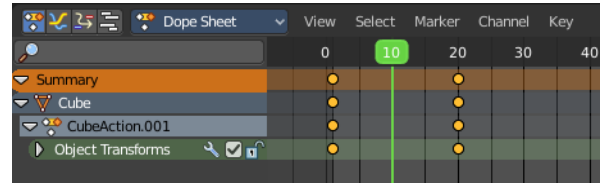

Switch to NLA editor.

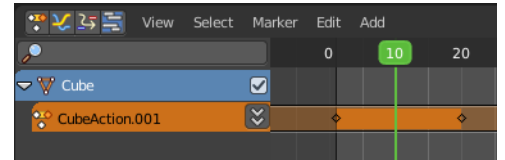

Click at the Push Down Action button to create the Action strip for this keyframe animation.

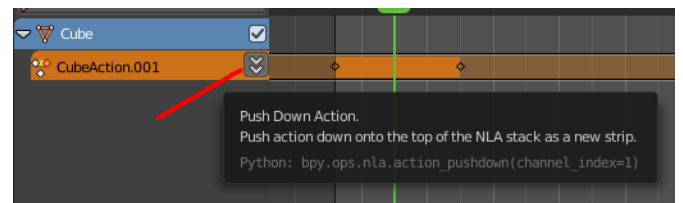

This turns your keyframe sequence into a single Action strip, which can now be used in the NLA editor.

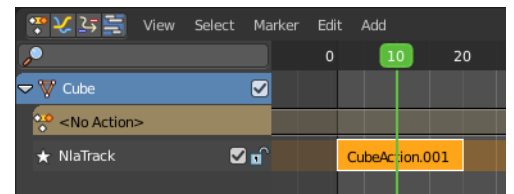

You will notice that the keyframes in the Dope Sheet editor are gone. They are now part of the Action strip.

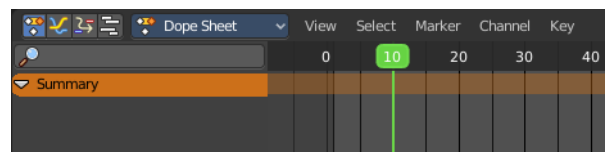

When you want to edit the keyframes of an Action strip then you need to enter the tweak mode by activating Start Tweaking Strip Actions.

This turns the strip to green to tell you that you are now in tweak mode. And it reveals the keyframes, which you can now edit in Dope Sheet editor.

To leave the edit mode click the menu item again, or press Tab key.

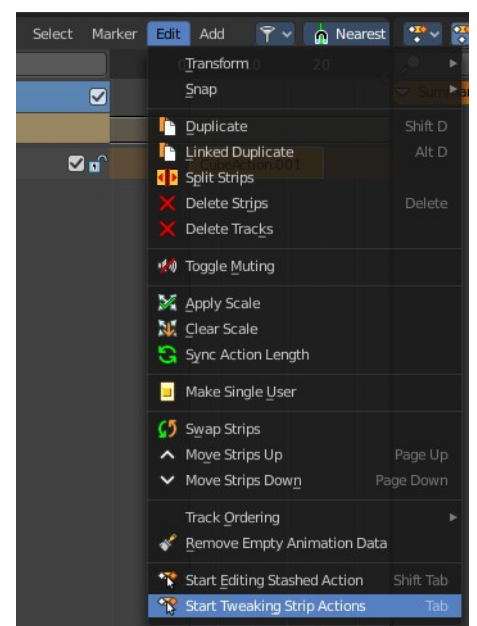

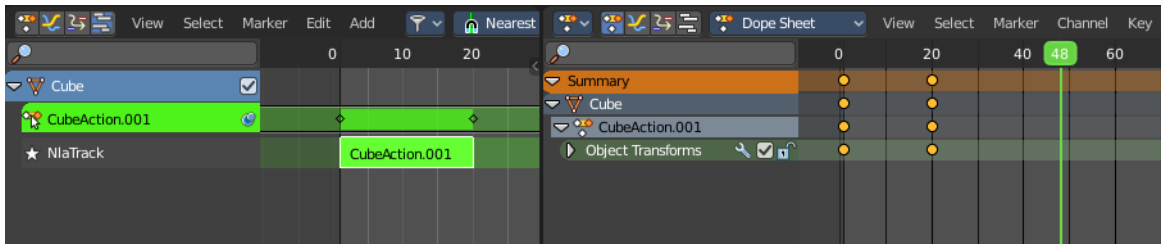



20.1.1 Editors - NLA Editor - Header tools and options

Table of content

Introduction.....	1
Header Tabs.....	1
Tweak Mode.....	2
Tweak.....	2
Isolate.....	2
Show Hide elements.....	2
Only Show Selected.....	2
Show Hidden.....	2
Include Missing NLA.....	3
Filters.....	3
Filter by Collection.....	3
Filter by Type.....	3
Options.....	3
Sort Data Blocks.....	3
Auto Snap.....	3
Options.....	3
Real-time Updates.....	4
Show Seconds.....	4
Sync visible range.....	4
Show Control F-Curves.....	4
Show Markers.....	4
Show Local Markers.....	4
Lock Markers.....	4

Introduction

The header contains various menus and tools. This chapter here is about the tools, modes and options elements in the header.

The text menus are covered in an own chapter each.

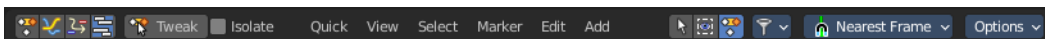

Header Tabs

The tabs at the very left allows you to switch between the four most important editor types by one click. Dope sheet Editor, Graph Editor, Driver Editor, NLA Editor.



Tweak Mode

Tweak



The tweak mode allows you to edit the keyframe data within an Action clip while evaluating the full stack. The strip will turn green and in the Dope Sheet editor you will find the Action clip's keyframes, which you can now tweak.

Playback will show a blend of all NLA tracks while you edit the Action clip.

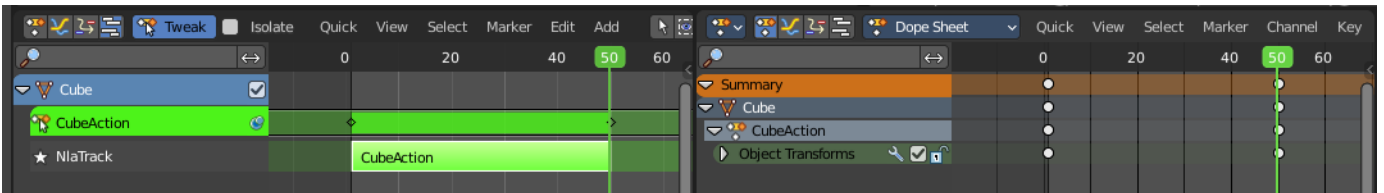

Isolate

Tweak with the Isolate checkbox on allows editing of the animation data on only the selected and isolated Action Clip.

Playback will show only the keyframes of of the isolated Action clip.

Note: You can also isolate a clip by clicking on the star icon at the left.

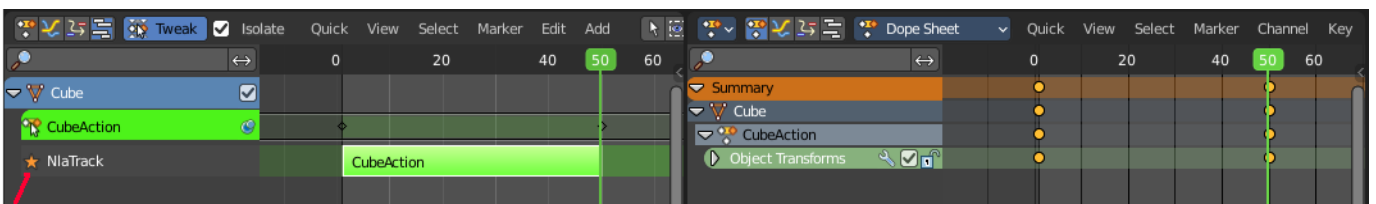

There are similar Tweak mode tool in the Edit menu too where you can edit with the full stack, lower stack or isolated Action clips. Leaving the Tweak mode is for the first two methods evaluated in the header.

Show Hide elements



Only Show Selected

Display only the data for the selected object in the list of elements. If off it displays all available animation data of the whole scene.

Show Hidden

Include channels from objects / bones that are not visible. This feature just works with Only Selected off.

Include Missing NLA

Include Animation data blocks without NLA data.

Filters

The show hide elements allows you to filter out the general elements. The Filters panel allows you to filter out further elements.

Filter by Collection

Just display the content from the chosen collection in the list of elements.

Filter by Type

In this section you can choose what type of animation data should be displayed. The names should be self explaining.



Options

Sort Data Blocks

Alphabetically sort the data in the list of elements.

Auto Snap

Adjust how the selected keyframe or fcurve point snaps to other elements.

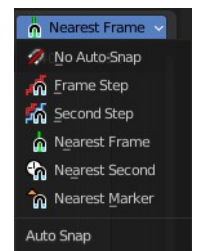

Options

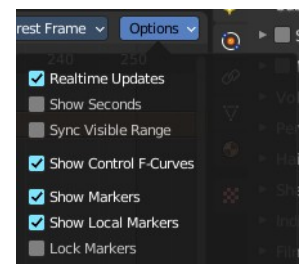

Real-time Updates

When transforming keyframes then this transformation is also immediately visible in other editors.

Show Seconds

Show the timing in the timeline area in seconds instead of frames.

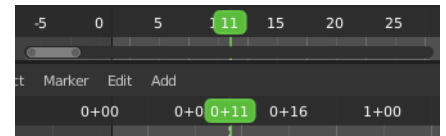

Sync visible range

Synchronize the visible timeline range with other visible time based editors. When you zoom in or out in the one editor, then it zooms in or out in the other editor too. Each editor to sync needs to have Sync Visible Range ticked.

Show Control F-Curves

Shows existing f-curves in the action strip. Like for keyframed Animated influence.

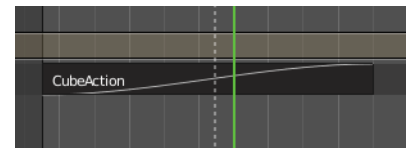

Show Markers

Display the markers.

Show Local Markers

Show action-local markers on the strips.

Lock Markers

Make the markers uneditable.



20.1.2 Editors - NLA Editor - Header - Quick Menu

Table of content

Quick Menu.....	1
Adding an operator to the Quick menu.....	1
Adding a menu to the Quick menu.....	1
Order.....	2
Removing an operator from the Quick menu.....	2
Context and mode dependent content.....	2

Quick Menu

The quick menu, or in long Quick Favorites menu, is a menu that can be customized to your needs. Here you can add operators for quick access.

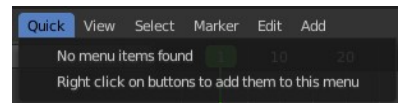

It is located in the header. But it can be called by hotkey Q directly under the mouse. This hotkey works in other editors too.

When the menu is empty, then you will see the message "No Menu Items found". This means that you first have to add some tools to the menu. It is a user configurable menu.

Note that added operators in this menu does not have icons. Just text.

Adding an operator to the Quick menu

Open the panel or the menu where your operator is that you want to add.

Let's add the open command from the File menu. Open the File menu, right click at open, and choose Add to Quick Favorites.

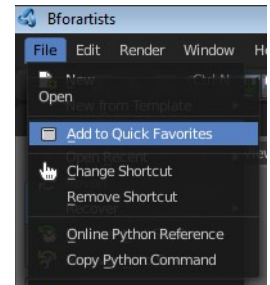

Do the same with Save As. We should now have two new menu items in the Quick menu, which you can use now.

As a rule of thumb, when the right click menu has an Add to Quick Favorites, then you can add it to the quick menu.

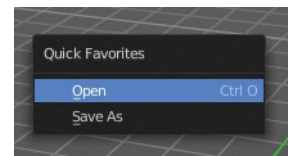

Note that you can also add operators from the tool shelf at the left. And also operators from other editor types. Some other editors have their own quick menu though. The Image Editor for example. These operators gets added in the quick menu of the image editor then. And does not show in the quick menu in the header of the 3D view.

Adding a menu to the Quick menu

It is also possible to add a menu to the Quick menu. For example the whole Add menu. The way is the same. Right click at it, and choose Add to Quick Favorites.

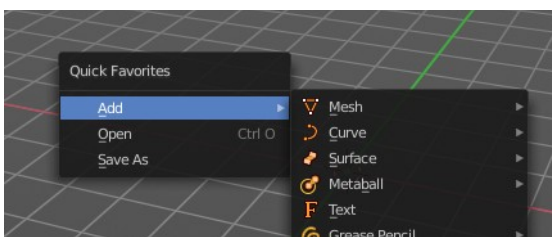
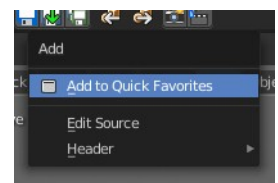

Order

You might notice that the add menu adds at the top of the menu, and not at the bottom as you would expect. First comes menus, then comes operators. And they get added in the order in which you add them.

Besides that, operators and menus gets added in the order that you add them. They cannot be sorted afterwards. So be careful how you add them. You can of course always remove operators and menus, and re-add them at the end of the list.

Removing an operator from the Quick menu

Removing is as simple as adding. Right click at the operators in the Quick menu, and choose Remove from Quick favorites.

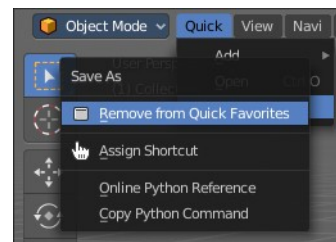

Context and mode dependent content

The quick favorites. menu exists in nearly all editors. But it is just in the 3D view available in the header. So that you know this functionality exists. In the other editors you call it with hotkey Q.

The content of the quick favorites. menu changes, dependent over which editor you are, and in what mode you are. When you add for example an operator from the image editor, then this operator just shows in the quick menu when you call the menu from the image editor. Same goes for the modes. Edit mode tools will just show in edit mode. And so on.



20.1.3 Editors - NLA Editor - View Menu

Table of content

NLA Editor - View Menu.....	1
Channels List.....	2
Sidebar.....	2
Set Preview Range.....	2
Clear Preview Range.....	2
Auto Set Preview Range.....	2
Area.....	2
Horizontal Split.....	2
Vertical Split.....	2
Duplicate Area into New Window.....	3
Toggle Maximize Area.....	3
Toggle Full screen Area.....	3
Close Area.....	3
Zoom In.....	3
Zoom Out.....	3
Zoom Border.....	3
Frame All.....	3
Frame Selected.....	3
Go to current Frame.....	4
Pie menus.....	4
Area.....	4
Horizontal Split.....	4
Vertical Split.....	4
Duplicate Area into New Window.....	4
Toggle Maximize Area.....	4
Toggle Full screen Area.....	4
Close Area.....	4

NLA Editor - View Menu

The View menu contains all View related tools.

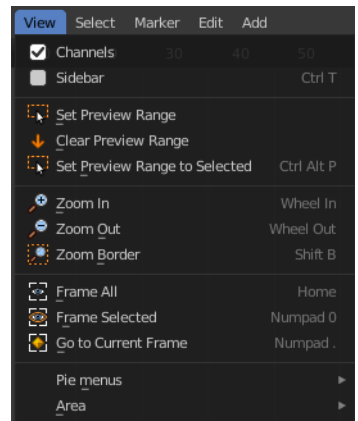

Channels List

Shows or hides the Channels list at the left in the viewport.

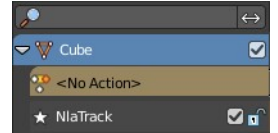

Sidebar

Shows or hides the sidebar at the right in the viewport.

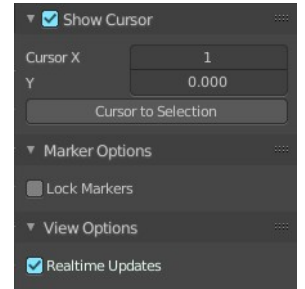

Set Preview Range

Rectangle select an area of the timeline that gets previewed. The playback now just happens in this marked area.

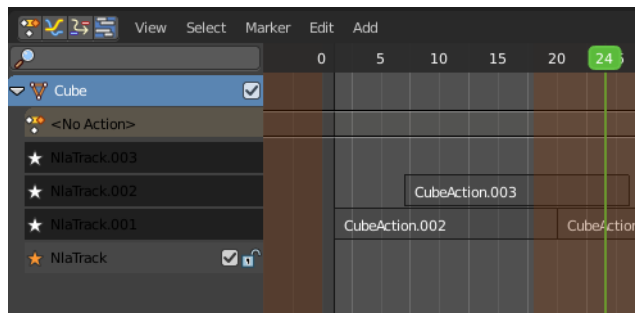
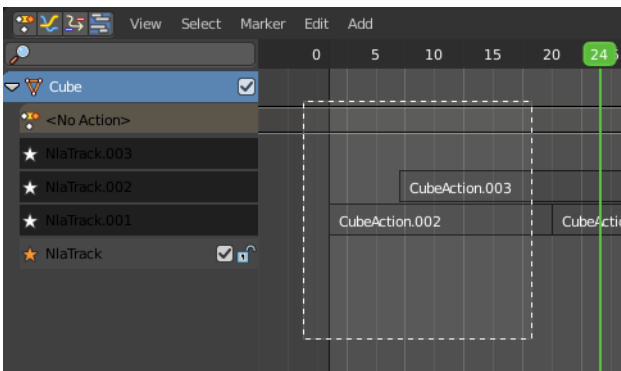

Clear Preview Range

Clears an existing preview range.

Auto Set Preview Range

Sets the preview range between the first and last keyframe of the animation.

Area

This menu contains general view functionality. And exists in most other editor types too.

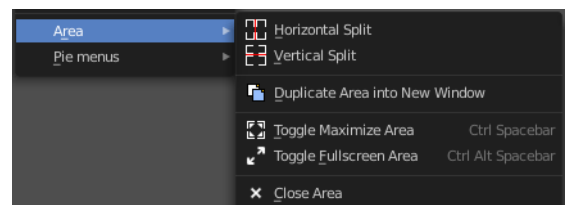

Horizontal Split

Splits the current view horizontally into two independent editor windows.

Vertical Split

Splits the current view vertically into two independent editor windows.

Duplicate Area into New Window

Duplicate Area into New Window makes the selected editor window floating. You can then drag it around at the monitor. It is not connected with the rest of the UI anymore.

A separated window cannot be merged into the main window again. You have to close it when not longer needed.

Toggle Maximize Area

Displays the editor maximized with menus.

To return from the maximized view press hotkey ctrl + spacebar. Or reuse the menu item in the area menu.

Toggle Full screen Area

Displays the editor maximized without menus.

To return from the full screen view press hotkey ctrl + alt + spacebar.

Close Area

Closes the area window.

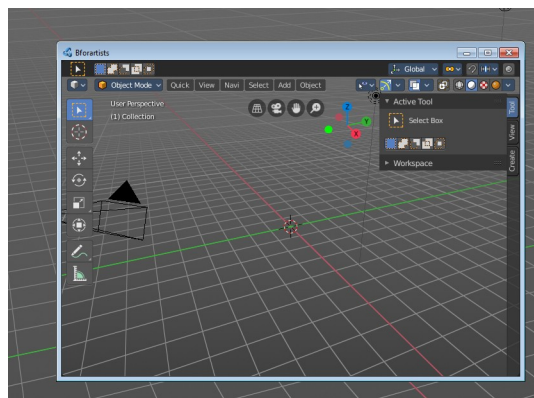

Zoom In

Zooms into the viewport.

Zoom Out

Zooms out of the viewport.

Zoom Border

Draws a rectangle and zooms then to fit the size of this rectangle.

Zooming in is done with drawing the rectangle with left mouse button. Zooming out is done with drawing the rectangle with middle mouse button.

Frame All

Zooms in or out in the viewport until all objects in the scene are displayed fitting in the viewport.

Frame Selected

Centers the view at the currently selected keyframe(s).

Go to current Frame

Centers the view at the frame slider.

Pie menus

Lists the available pie menus, and gives you the ability to read the hotkeys and assign own hotkeys.



Area

This menu contains general view functionality. And exists in most other editor types too.

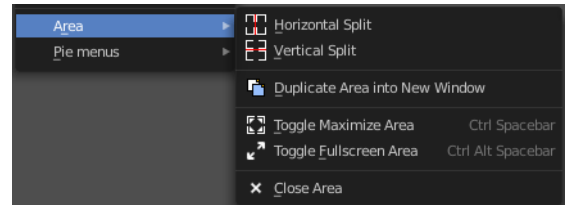

Horizontal Split

Splits the current view horizontally into two independent editor windows.

Vertical Split

Splits the current view vertically into two independent editor windows.

Duplicate Area into New Window

Duplicate Area into New Window makes the selected editor window floating. You can then drag it around at the monitor. It is not connected with the rest of the UI any more.

A separated window cannot be merged into the main window again. You have to close it when not longer needed.

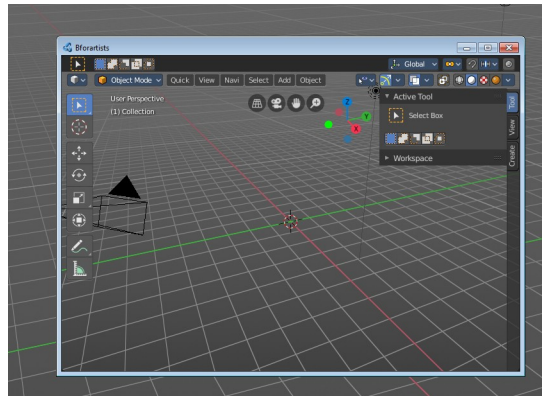

Toggle Maximize Area

Displays the editor maximized with menus.

To return from the maximized view press hotkey ctrl + spacebar. Or reuse the menu item in the area menu.

Toggle Full screen Area

Displays the editor maximized without menus.

To return from the full screen view press hotkey ctrl + alt + spacebar.

Close Area

Closes the area window.



20.1.4 Editors - NLA Editor - Select Menu

Table of content

NLA Editor - Select Menu.....	1
All.....	1
None.....	1
Inverse.....	1
Box Select.....	1
Box Select(Axis Range).....	2
Last Operator Box Select.....	2
Axis Range.....	2
Include Handles.....	2
Tweak.....	2
Mode.....	2
Circle Select.....	2
Before current Frame.....	2
After current Frame.....	2
Last Operator Select Left/Right.....	2
Mode.....	3
Extend Select.....	3

NLA Editor - Select Menu

The Select menu contains various tools to select elements.

The content is the same in all modes. With one exception. Grease Pencil mode is missing the More / Less menu items.

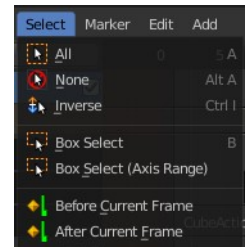

All

Select everything.

None

Select nothing.

Inverse

Invert the current selection.

Box Select

Box select enters the Border Select mode. Select elements by dragging a rectangle around it. Just what's inside of the rectangle gets selected then.

It adds to selection by default. To subtract from selection hold down Shift key.

The selection gets applied when you release the mouse. You leave the mode automatically when you release the mouse.

Box Select(Axis Range)

Box select enters the Border Select mode. Select elements by dragging a rectangle around it. And what's inside the horizontal range of the rectangle gets selected then. Even when the keyframes are outside of the rectangle.

It adds to selection by default. To subtract from selection hold down Shift key.

The selection gets applied when you release the mouse. You leave the mode automatically when you release the mouse.

Last Operator Box Select

Axis Range

What's inside the horizontal range of the rectangle gets selected.

Include Handles

Also select the curve handles.

Tweak

Operator has been activated using a tweak event.

Mode

The selection mode to use.

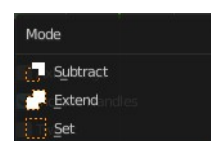
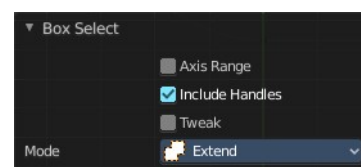

Circle Select

Circle select enters the Circle Select mode. This is a special select mode where you can select elements by moving with the mouse over it. It adds to selection by default.

To subtract from selection hold down Shift key. To exit the Circle select click with the right mouse button.

The pencil radius of the circle select tool can be adjusted with the scroll wheel.

Before current Frame

Select the keyframes before the current frame.

After current Frame

Select the keyframes after the current frame.

Last Operator Select Left/Right

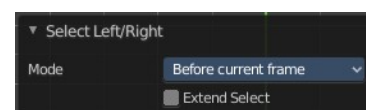

Mode

The selection mode to use.

Extend Select

Extend the current selection.

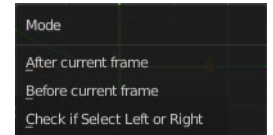



21.1.5 Editors - NLA Editor - Marker Menu

Table of content

NLA Editor - Marker Menu.....	1
Add Marker.....	1
Duplicate Marker.....	1
Last Operator Duplicate Time Marker.....	2
Frames.....	2
Duplicate Marker to Scene.....	2
Last Operator Make Links to Scene.....	2
Scene.....	2
Delete Marker.....	2
Bind Camera to Markers.....	2
Rename Marker.....	2
Last Operator Rename Marker.....	3
Name.....	3
Move Marker.....	3
Select sub menu.....	3
All.....	3
None.....	3
Invert.....	3
Before Current Frame.....	3
After Current Frame.....	3
Jump to Next Marker.....	3
Jump to Previous Marker.....	3

NLA Editor - Marker Menu

Markers are visual landmarks. They can mark a start of a specific animation sequence, the end of a camera movement, and so on.

When you add one then a marker area appears at the bottom of the timeline.

Markers can be pulled around by clicking at them and dragging them left or right. The active marker is yellow.

By holding down shift you can select more than one marker.

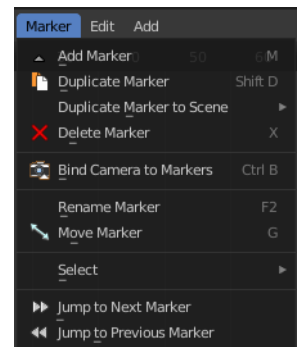

Add Marker

Adds a marker at the current frame position

Duplicate Marker

Duplicates the selected marker(s). The duplicate(s) sticks at the mouse until you click to give it the target destination.

Last Operator Duplicate Time Marker

Frames

The target frame to position the duplicated marker.



Duplicate Marker to Scene

Duplicate markers to other scenes. A blend file can contain more than one scene. See Scene Properties in the Properties editor.

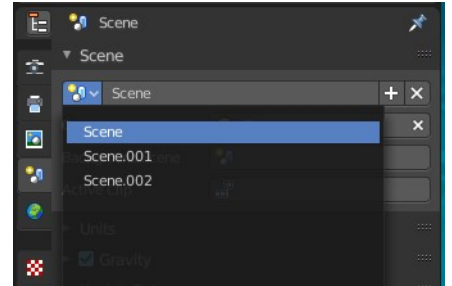
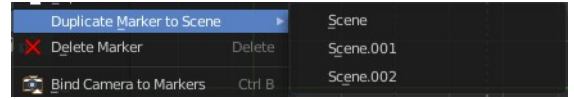

Last Operator Make Links to Scene

Scene

The target scene to duplicate the markers.

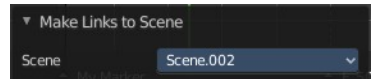

Delete Marker

Deletes the selected marker(s).

Bind Camera to Markers

Bind camera to markers turns an object into a camera object. This can be any object in the scene. Not just camera objects.

When the current frame position does not have a marker yet, then it creates a marker at the current frame position.

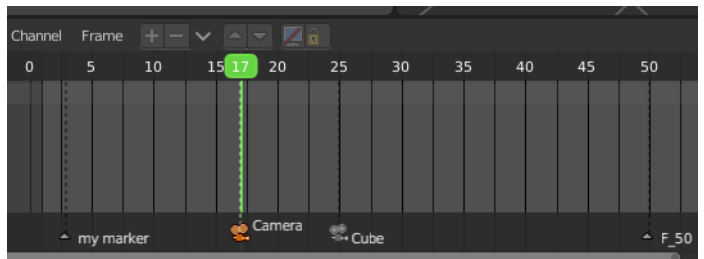

By binding different objects or cameras at different marker locations you can switch cameras automatically.

The marker with a bind camera attached will show a camera icon.

Rename Marker

A menu will open up where you can rename the active marker.

Note that for the hotkey to work you need to hover over the Marker region.

In the NLA viewport F2 will call the rename menu to rename the clip instead.

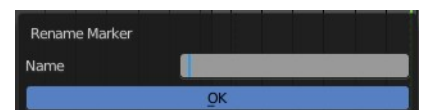

Last Operator Rename Marker

Name

Rename the active marker.

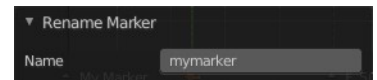

Move Marker

Hotkey only functionality! This menu item exists to show the hotkey to move the marker.

Select sub menu

All

Select all markers.

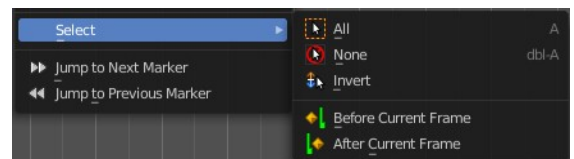

None

Deselect all markers.

Invert

Inverts the current selection

Before Current Frame

Selects the markers before the current frame.

After Current Frame

Selects the markers after the current frame.

Jump to Next Marker

Sets the frame position to the next marker.

Jump to Previous Marker

Sets the frame position to the previous marker.



20.1.6 Editors - NLA Editor - Edit Menu

Table of content

NLA Editor - Edit Menu.....	2
Transform.....	2
Grab/Move.....	2
Last Operator Move.....	2
Move X, Y Z.....	2
Orientation.....	2
Mirror Editing.....	2
Proportional editing.....	2
Extend.....	3
Last Operator Transform.....	3
Values X, Y Z, W.....	3
Axis.....	3
Orientation.....	3
Mirror Editing.....	3
Proportional editing.....	3
Scale.....	3
Last Operator Resize.....	3
Angle.....	3
Axis.....	3
Orientation.....	3
Mirror Editing.....	4
Proportional editing.....	4
Snap.....	4
Bake Action.....	4
Duplicate.....	4
Linked Duplicate.....	4
Split Strips.....	4
Rename.....	4
Delete Strips.....	5
Delete Tracks.....	5
Apply Scale.....	5
Clear Scale.....	5
Sync Action Length.....	5
Make Single User.....	5
Swap Strips.....	5
Move strips up.....	5
Move Strips down.....	5
Track Ordering.....	5
Remove Empty Animation Data.....	5
Tweak Isolated Action.....	6
Tweak Action (Full Stack).....	6
Tweak Action (Lower Stack).....	6

NLA Editor - Edit Menu

This menu contains functionality to manage the keyframes.

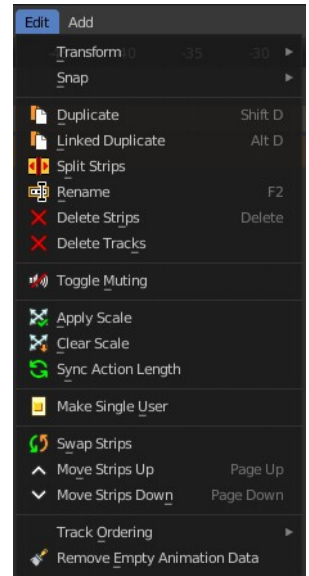

Transform

Grab/Move

Moves the selected keyframe(s).

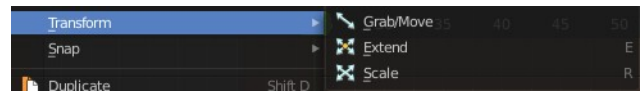

Last Operator Move

Move X, Y Z

The position. Attention, the actual world orientation and rotation does not matter here. It always starts with a value of zero, and moves relative to this zero then. For the actual location values have a look in the sidebar in the transform panel.

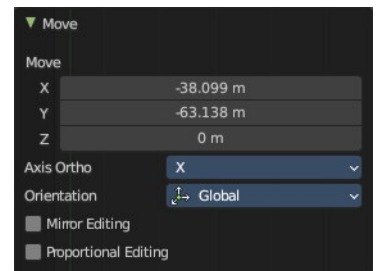

Orientation

The widget can have different orientations. The menu items should be self explaining.

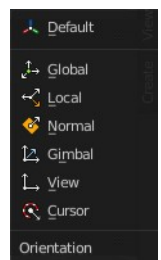

Mirror Editing

Enable Mirror editing

Proportional editing

Proportional editing is not available for this mode.

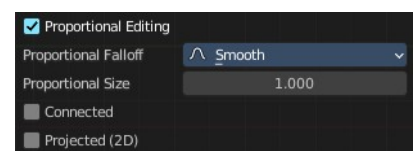

Extend

Moves the last keyframes of the selection.

Last Operator Transform

Values X, Y Z, W

The new position.

Axis

Which axis to transform.

Orientation

The widget can have different orientations. The menu items should be self explaining.

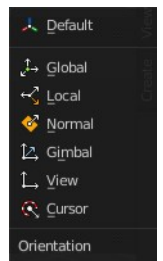
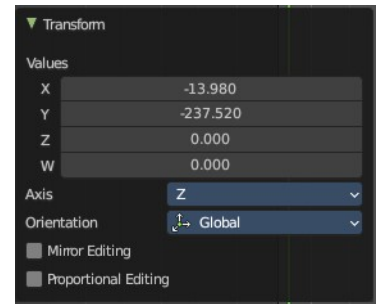

Mirror Editing

Enable Mirror editing

Proportional editing

Proportional editing is not available for this mode.

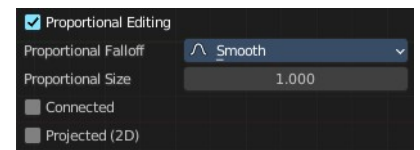

Scale

Scales the selected keyframes. You need to have more than one keyframe selected.

Last Operator Resize

Angle

The rotation. Attention, the actual world orientation and rotation does not matter here. It always starts with a value of zero, and rotates relative to this zero then. For the actual rotation values have a look in the sidebar in the transform panel.

Axis

Which axis to rotate.

Orientation

The widget can have different orientations. The menu items should be self explaining.

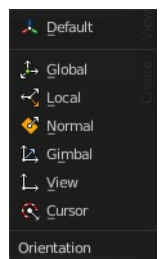
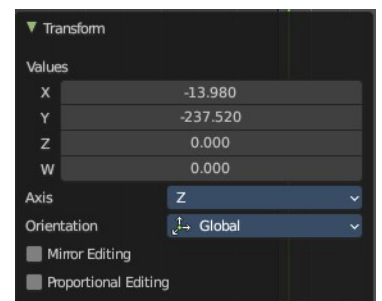

Mirror Editing

Enable Mirror editing

Proportional editing

Proportional editing is not available for this mode.

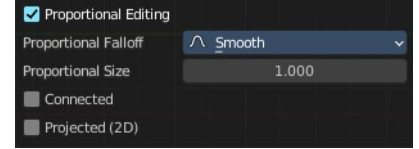

Snap

Snaps the selected keyframes by the chosen method.

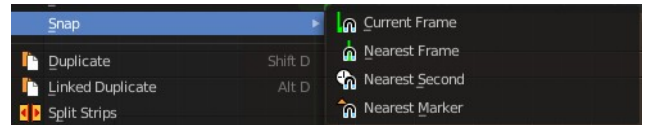

Bake Action

Bakes all selected objects locations/scale/rotation animations to an action.

To use this operator, a dialogue will prompt to define the parameters before applying the bake action.

The final animation of the selected objects or bones is computed with all modifiers, drivers, and constraints applied with keyed results per frame step in a range.

Duplicate

Duplicate selected keyframes.

Linked Duplicate

Duplicates the selected strip(s), and creates a new track for the duplicates. This copy is linked to the original action strip. Modifications at the original will also affect the linked action strip.

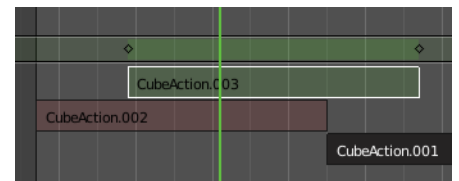

Linked strips are visually different from normal strips. And when you start to modify the linked duplicate, then the original strip will turn red.

Split Strips

Splits the selected strip(s) at the marker position.

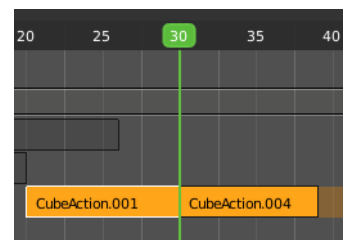

Rename

Allows you to rename the current NLA strip. The operator calls a rename



popup.

Delete Strips

Deletes the selected strips.

Delete Tracks

Deletes the selected track(s).

Toggle Muting

Disables the selected action clip. Be careful, there is no visual hint if the clip is muted or not.

Apply Scale

Applies the current scale of the clips to be 1.

Clear Scale

Resets the scale of the clip back to 1.

Sync Action Length

Synchronize the length of the action with the keyframe length used in the strip.

Make Single User

You can create linked duplicates. Make single user makes them into individual clips.

Swap Strips

Swaps the selected strips.

Move strips up

Moves the selected action strips upwards into the next track.

Move Strips down

Moves the selected action strips downwards into the next track.

Track Ordering

Order the tracks.

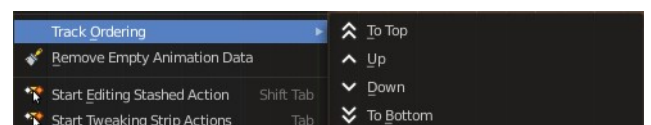

Remove Empty Animation Data

Removes action clips that are empty.

Tweak Isolated Action

Allows you to edit the keyframe data within the Action strip while isolating the active Action clip from all tracks. This mode allows you to insert keyframes into the isolated Action clip.

This tweak mode is similar to the one in the header with the Isolate toggle turned on. This tweak mode in the header does not preserve the pose of the full stack.

Leaving the Tweak mode is for all methods evaluated in the header.

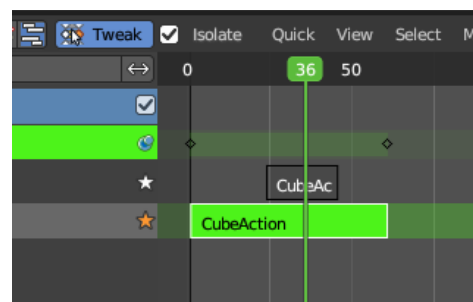

Tweak Action (Full Stack)

Allows you to edit the keyframe data within the Action strip while evaluating all Action clips in the NLA stack. This mode allows you to insert keyframes and preserve the pose that you visually key while all strips are evaluating.

This tweak mode is also accessed from the “tweak” button in the header when the isolate checkbox is disabled.

Leaving the Tweak mode is for all methods evaluated in the header.

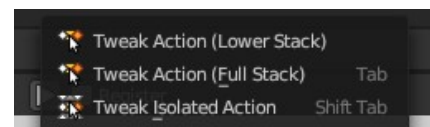

Tweak Action (Lower Stack)

Allows you to edit the keyframe data within the Action strip while evaluating only Action clips located below the active track in the NLA stack. This mutes all tracks above the active Action clip track and only evaluates tracks below.

This tweak mode is similar to the one in the header but it allows you to insert keyframes and preserve the pose that you visually keyed while lower strips are evaluating only.

Leaving the Tweak mode is for all methods evaluated in the header.



20.1.7 Editors - NLA Editor - Add Menu

Table of content

NLA Editor - Add Menu.....	1
Add Action Strip.....	1
Add Transition.....	1
Add Sound Clip.....	1
Add Meta Strips.....	1
Remove Meta Strips.....	2
Add Tracks.....	2
Add Tracks Above Selected.....	2
Include Selected Objects.....	2

NLA Editor - Add Menu

A menu where you can add various elements to the NLA.

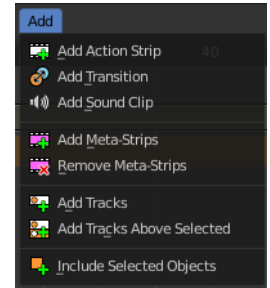

Add Action Strip

Adds an action strip. Opens a popup menu where you can choose what animation data this new action strip should contain.

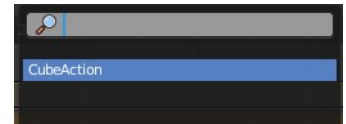

Add Transition

Adds a transition strip between two selected action strips.



Add Sound Clip

Adds a sound clip at the marker position.

A Sound Clip Controls when a speaker plays a sound. This strip type requires a Speaker object with a sound clip assigned. You can create a speaker object in the 3D view. The sample can be loaded in the Object Data Properties tab in the Properties editor then.

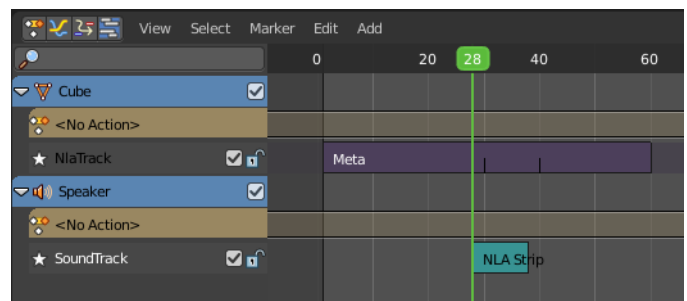

Add Meta Strips

Turns selected strips into a meta strip. A group of strips.

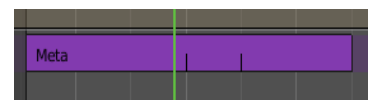

Remove Meta Strips

Ungroups the meta strips into its original action strips.

Add Tracks

Adds a new track in the Channel list.

Add Tracks Above Selected

Adds a new track in the Channel list.

Include Selected Objects

Objects without animation or a NLA strip will not appear in the channel list. With this command you can load selected objects into the NLA, regardless if they have animation yet or not.



20.2 Editors - NLA Editor - Channel list

Table of content

NLA Editor - Channel List.....	1
Action channel and NLA Track channel.....	1
Hotkeys.....	1
Search field.....	1
Expand / collapse triangle.....	2
Object type Icon.....	2
Pin.....	2
Mute.....	2
Lock.....	2
Push Down Action.....	2
Solo.....	2
Channel / Track name.....	2

NLA Editor - Channel List

The channel list contains your objects and their animation channels.

The channel list area can be resized by dragging the right border to left or right.

The list has several elements, to turn on or off different features, Or to expand or collapse the hierarchy.



Action channel and NLA Track channel

An action channel is a channel with keyframe animation. Before converting the animation to an action.

A track channel is a channel with an action strip. After converting the animation to an action.

Hotkeys

Hotkey A selects all channels.

Hotkey Alt A deselects everything.

Left mouse and dragging activates box select.

Clicking at a channel selects it.

Clicking at a channel while holding down shift adds to the selection or removes from the selection.

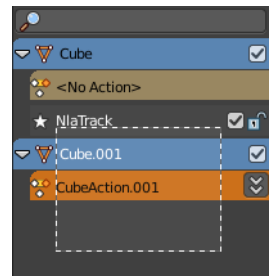

Search field

At the top is a search field that allows you to filter the channel list by search terms.



Expand / collapse triangle

The triangle icon at the left allows you to expand or collapse the hierarchy.



Object type Icon

This icon shows what kind of object this channel belongs to. These icons have no functionality.

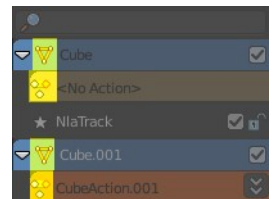

Pin

In Tweaking mode. When unpinned display action without any time remapping. The keyframes remains at their initial position when you move the action strip.



Mute

Mutes the channel.

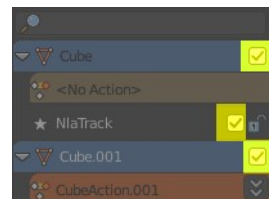

Lock

Locks the channel from editing.

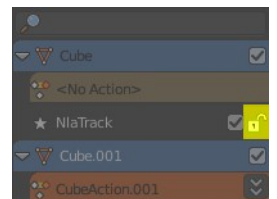

Push Down Action

Tracks that are no Action strips yet shows this button. Converts a keyframe animation to an Action strip.

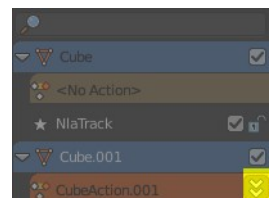

Solo

Just edit this track.

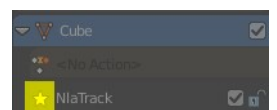

Channel / Track name

The name of the channel name and element. Some elements can be renamed. Like the



action or object type.

To rename an element double click at it. Type in the new name. Then press Enter or click elsewhere.



20.3.1 Editors - NLA Editor - Sidebar - Edited Action tab

Table of content

Edited Action Tab.....	1
Animation data property.....	1
Data Browser.....	1
Action Edit Box.....	1
Number of users.....	1
Fake User.....	2
Add.....	2
Remove Action.....	2
Extrapolation.....	2
Hold.....	2
Hold Forward.....	2
Nothing.....	2
Blending.....	2
Replace.....	2
Combine.....	2
Add, Subtract, Multiply.....	3
Influence.....	3

Edited Action Tab

This tab allows you to edit existing actions or add more actions. This way you can add several actions to an object. Add action, record keyframes, and then push down the action to create an action strip of it.

With selecting an action channel, with a not pushed down action, it shows the current action. When you select a track channel then it shows a New button where you can add more action channels.

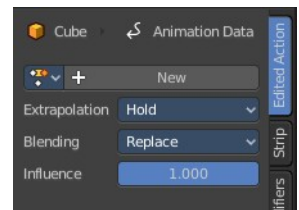
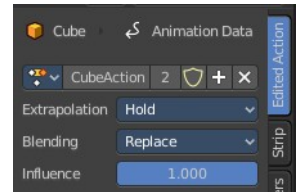

Animation data property

Data Browser

The list of available actions in the scene.

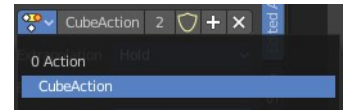

Action Edit Box

The name of the current active action. You can rename the action here too.

Number of users

The number of users for this data.

Fake User

Has this data a fake user assigned. Fake user is a concept to keep data in the scene even when it has no users.

Add

Adds a new blank Action.

Remove Action

Removes the action from the current channel.

Extrapolation

Action to take for gaps past the strip extents.



Hold

Affects both sides of the strip. This should only be set on the very first strip.

Hold Forward

Affects the region after the clip, only. This can be set on any strip.

Nothing

Affects only the region of the strip itself. This can be set on any strip.

Blending

Affects how the property values directly produced by the strip are combined with the result of evaluating the stack below. The bottom-most strip is blended on top of the default values of the properties.

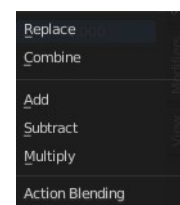

Replace

The top strip is linearly blended in with the accumulated result according to influence, completely overwriting it if influence is set to 100%.

Combine

Depending on the type of each property, one of the following methods is automatically chosen:

Axis/Angle Rotation

$result = previous + value * influence$

This results in averaging the axis and adding the amount of rotation.

Quaternion Rotation

Quaternion math is applied to all four channels of the property at once:

$\text{result} = \text{previous} \times \text{value} \times \text{influence}$

Proportional (Scale)

$\text{result} = \text{previous} * (\text{value} / \text{default}) \times \text{influence}$

Others

$\text{result} = \text{previous} + (\text{value} - \text{default}) * \text{influence}$

This allows layering actions that can also be used as a standalone. Properties keyframed at their default values remain at default.

Add, Subtract, Multiply

The result of the strip is multiplied, subtracted, or added to the accumulated results, and then blended in according to influence.

$\text{result} = \text{mix}(\text{previous}, \text{previous} (+ - *) \text{value}, \text{influence})$

Influence

Amount the active Action contributes to the result of the NLA stack.



20.3.2 Editors - NLA Editor - Sidebar - Strip tab

Table of content

Strip Tab.....	1
Name.....	1
Mute.....	2
Active Strip panel.....	2
Frame Start + End.....	2
Extrapolation.....	2
Hold.....	2
Hold Forward.....	2
Nothing.....	2
Blending.....	2
Replace.....	2
Combine.....	2
Add, Subtract, Multiply.....	3
Blend In + Out.....	3
Auto Blend In/Out.....	3
Playback.....	3
Reversed.....	3
Cyclic Strip Time.....	3
Animated Influence.....	3
Influence.....	3
Animate Property.....	4
Animated Strip Time.....	4
Influence.....	4
Animate Property.....	4
Action Clip panel.....	4
Action.....	4
Frame Start / End.....	4
Sync Length.....	4
Now.....	4
Playback Scale.....	4
Repeat.....	5

Strip Tab

The settings for the currently selected action strip. You need to have a action strip selected to show this tab.

Name

The name of the currently selected action strip.

To rename the strip click into the edit field, change the name and press enter.

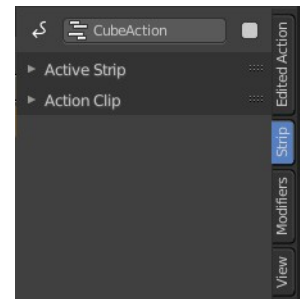

Mute

Disable the action strip.

Active Strip panel

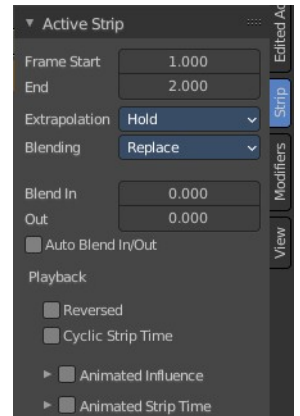

Frame Start + End

The start and end position of the strip.

Extrapolation

Action to take for gaps past the strip extents.

Hold

Affects both sides of the strip. This should only be set on the very first strip.

Hold Forward

Affects the region after the clip, only. This can be set on any strip.

Nothing

Affects only the region of the strip itself. This can be set on any strip.

Blending

Affects how the property values directly produced by the strip are combined with the result of evaluating the stack below. The bottom-most strip is blended on top of the default values of the properties.

Replace

The top strip is linearly blended in with the accumulated result according to influence, completely overwriting it if influence is set to 100%.

Combine

Depending on the type of each property, one of the following methods is automatically chosen:

Axis/Angle Rotation

$result = previous + value * influence$

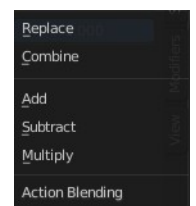

This results in averaging the axis and adding the amount of rotation.

Quaternion Rotation

Quaternion math is applied to all four channels of the property at once:

$result = previous \times value \times influence$

Proportional (Scale)

$result = previous * (value / default) \times influence$

Others

$result = previous + (value - default) * influence$

This allows layering actions that can also be used as a standalone. Properties keyframed at their default values remain at default.

Add, Subtract, Multiply

The result of the strip is multiplied, subtracted, or added to the accumulated results, and then blended in according to influence.

$result = mix(previous, previous (+-*)value, influence)$

Blend In + Out

Number of frames to fade in or out the action strip.

Auto Blend In/Out

Number of frames for blending in and out is automatically calculated from overlapping strips.

Playback

Reversed

The action strip is played in reversed order. This just works when timing is determined automatic.

Cyclic Strip Time

Cycle the action strip.

Animated Influence

Control the influence settings by an F-Curve instead of automatically determined. The F-Curve can be edited in the Graph Editor.

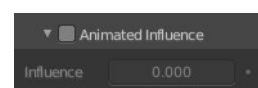

Influence

The influence value.

Animate Property

Set or remove a keyframe at current position.

Animated Strip Time

Control the Strip time settings by an F-Curve instead of automatically determined. The F-Curve can be edited in the Graph Editor.

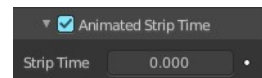

Influence

The influence value.

Animate Property

Set or remove a keyframe at current position.

Action Clip panel

This represents the 'object data' of the strip. Much like the transform values of an object.

Action

The action that is referenced in the strip. This can be changed to replace the current strip's value with another Action in the scene.

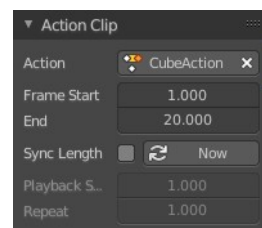

Frame Start / End

The start and end frame values of the strip.

Note. To loop the animation you might need to reduce the End Frame by one frame to have a loopable animation.

Note. If you select values that are above or below the actual keyframe count of the Action, then the F-curve Extrapolation will be applied.

Sync Length

Set the Start and End Frames to the first and last keyframed frames of the Action.

Now

Causes the Start and End Frames, above, to be reset to the first and last keyframed frames of the Action.

Playback Scale

Stretches the strip.

Repeat

Repeats the strip by the chosen value. With a value of 1 the strip plays once.



20.3.3 Editors - NLA Editor - Sidebar - Modifiers Tab

Table of content

Detailed table of content.....	1
Modifiers Tab - Modifiers Panel.....	3
Modifier header.....	4
Generator modifier.....	4
Built- in Function modifier.....	6
Envelope modifier.....	7
Cycles modifier.....	9
Noise modifier.....	10
Limits modifier.....	11
Stepped Interpolation modifier.....	12

Detailed table of content

Detailed table of content

Detailed table of content.....	1
Modifiers Tab - Modifiers Panel.....	3
Add Modifier.....	3
Copy F-Curve Modifiers.....	3
Paste F-Curve Modifiers.....	3
Last Operator Add F-Curve Modifier.....	4
Type.....	4
Only Active.....	4
Modifier header.....	4
Triangle button.....	4
Active.....	4
Modifier name.....	4
Muted.....	4
Delete F-Curve Modifier.....	4
Generator modifier.....	4
Polynomial Mode.....	5
Additive.....	5
Poly Order Expanded mode.....	5
Poly Order Factorized mode.....	5
Restrict Frame Range.....	5
Start / End.....	5
In / Out.....	5
Use Influence.....	5
Influence.....	6
Built- in Function modifier.....	6
Curve Type.....	6
Amplitude.....	6
Phase Multiplier.....	6
Phase Offset.....	6
Value Offset.....	6
Restrict Frame Range.....	6

Start / End.....	6
In / Out.....	6
Use Influence.....	7
Influence.....	7
Envelope modifier.....	7
Envelope.....	7
Reference Value.....	7
Min.....	7
Max.....	7
Control Points.....	8
Add Point.....	8
Point values.....	8
Frame.....	8
Min.....	8
Max.....	8
Delete.....	8
Restrict Frame Range.....	8
Start / End.....	8
In / Out.....	8
Use Influence.....	8
Influence.....	8
Cycles modifier.....	9
Trivially Cyclic Curves.....	9
Before.....	9
Before Cycles.....	9
After.....	9
After Cycles.....	9
Restrict Frame Range.....	9
Start / End.....	9
In / Out.....	10
Use Influence.....	10
Influence.....	10
Noise modifier.....	10
Blend Type.....	10
Scale.....	10
Strength.....	10
Offset.....	10
Phase.....	11
Depth.....	11
Restrict Frame Range.....	11
Start / End.....	11
In / Out.....	11
Use Influence.....	11
Influence.....	11
Limits modifier.....	11
Minimum / Maximum X.....	11
Minimum / Maximum Y.....	11
Restrict Frame Range.....	12
Start / End.....	12
In / Out.....	12
Use Influence.....	12
Influence.....	12
Stepped Interpolation modifier.....	12

Step Size.....12
 Offset.....12
 Use Start Frame.....12
 Use End Frame.....12
 Restrict Frame Range.....13
 Start / End.....13
 In / Out.....13
 Use Influence.....13
 Influence.....13

Modifiers Tab - Modifiers Panel

F-Curve modifiers are similar to Object modifiers. They allow to add adjustable non destructive effects. And they can be layered on top of each other.

Different to the Object modifiers you can't reorder this modifiers. You have to create it in the order that you need it.

Note that the F-Curve for the modifiers is just visible in the Graph editor when you are in Tweaking mode.

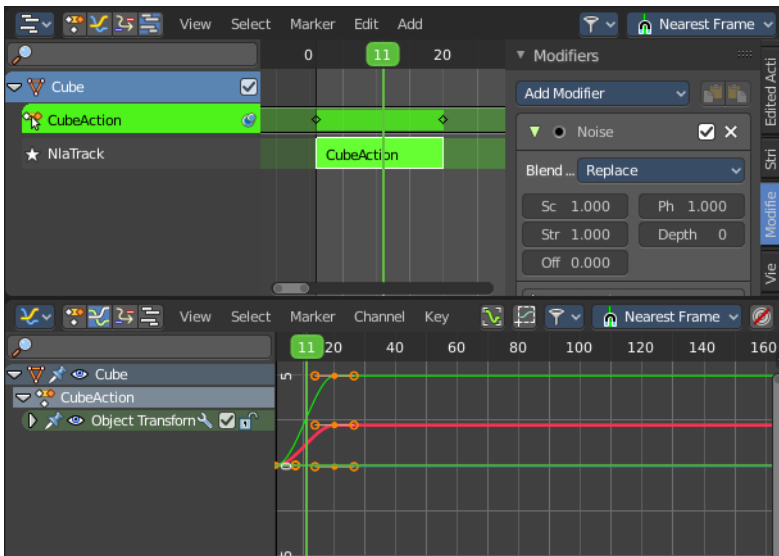
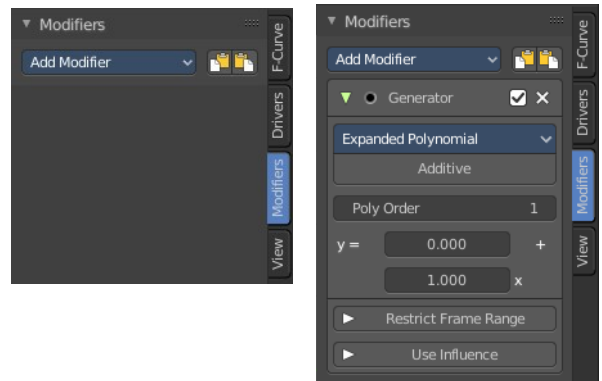

Add Modifier

The list of modifiers. Choose by clicking.

Copy F-Curve Modifiers

Copy the F-Curve Modifiers of the active F-Curve.

Paste F-Curve Modifiers

Paste copied F-Curve modifiers to the active F-Curve.

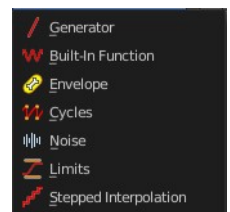

Last Operator Add F-Curve Modifier

Type

A drop down list with the Type of modifier to add.

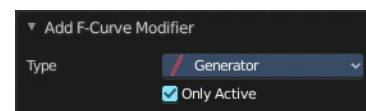

Only Active

Only add a modifier to the currently active curve.

Modifier header

Every modifier is a panel. And every panel has a header area with some general UI elements.



Triangle button

Every modifier panel can be expanded or collapsed by clicking at this triangle button.

Active

This is the panel that you currently edit. When you edit a panel while it is not set to the active one, then the changes will not be applied.

Modifier name

The name of the modifier. Read only.

Muted

Enable or disable this modifier.

Delete F-Curve Modifier

Delete this modifier.

Generator modifier

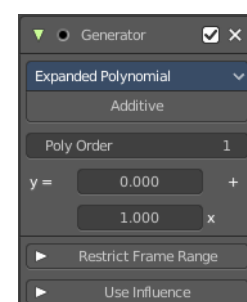

Polynomial Mode

Use Expanded Polynomial or Factorized Polynomial algorithm. With these mathematical formulas you can create lines, parabolas, and other more complex curves by changing the values in the poly order field.



Additive

Add on top of the existing curve instead of replacing the existing curve.

Poly Order Expanded mode

The polynomial formula for the Expanded mode. By increasing the Poly Order value you can add more polynomial fields to the formula.

Change the values to the desired results.

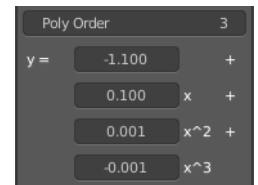

Poly Order Factorized mode

The polynomial formula for the Factorized mode. By increasing the Poly Order value you can add more polynomial fields to the formula.

Change the values to the desired results.

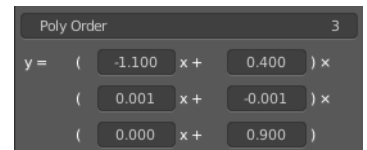

Restrict Frame Range

Expanding the Restrict Frame range sets it to active. It reveals some value slider then.



Start / End

The start and end frame of the generated curve.

In / Out

Fade the curve in or out for chosen frame numbers.

Use Influence

Temper the F-Curve Modifier effect by a default influence factor.

Expanding the Use Influence sets it to active. It reveals a value slider then.

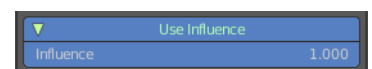

Influence

The influence factor.

Built- in Function modifier

Generate a curve by built in functions.

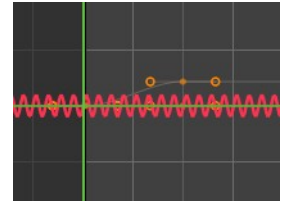
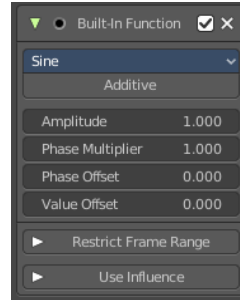

Curve Type

The available wave forms for the curve.

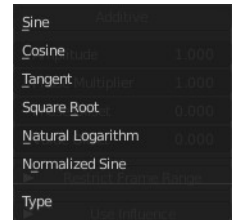

Amplitude

The amplitude of the curve wave. Adjusts the Y scaling.

Phase Multiplier

A phase multiplier for the curve wave. Adjusts the X scaling.

Phase Offset

A phase offset for the curve wave. Adjusts the Y scaling.

Value Offset

A constant value offset for the whole curve. Adjusts the X scaling.

Restrict Frame Range

Expanding the Restrict Frame range sets it to active. It reveals some value slider then.



Start / End

The start and end frame of the generated curve.

In / Out

Fade the curve in or out for chosen frame numbers.

Use Influence

Temper the F-Curve Modifier effect by a default influence factor.

Expanding the Use Influence sets it to active. It reveals a value slider then.

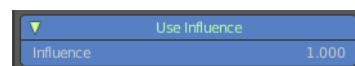

Influence

The influence factor.

Envelope modifier

The Envelope modifier allows you to modify the overall shape of the curve by control points.

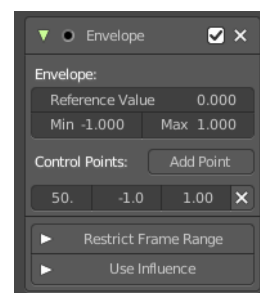
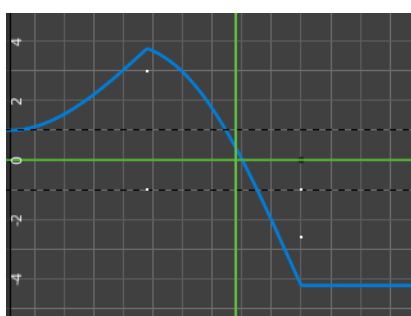
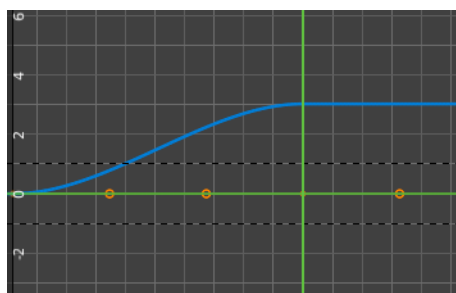

Envelope

Reference Value

Set the Y value to center the envelope around.

Min

The lower distance from reference value for 1:1 default influence.

Max

The higher distance from reference value for 1:1 default influence.

Control Points

Add Point

Add a control point. A control point has two sub points, a lower control point and a higher control point.

Point values

Adding a control point adds an entry in the Point Values list. Every added control point has its own values that can be modified here.

Frame

The frame position of this control point.

Min

The position of the lower control point.

Max

The position of the higher control point.

Delete

Delete this envelope control point.

Restrict Frame Range

Expanding the Restrict Frame range sets it to active. It reveals some value slider then.

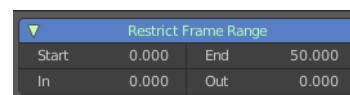

Start / End

The start and end frame of the generated curve.

In / Out

Fade the curve in or out for chosen frame numbers.

Use Influence

Temper the F-Curve Modifier effect by a default influence factor.

Expanding the Use Influence sets it to active. It reveals a value slider then.

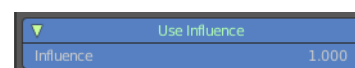

Influence

The influence factor.

Cycles modifier

Add a cyclic motion to a curve that has two or more control points. The option can be set before or after the curve.

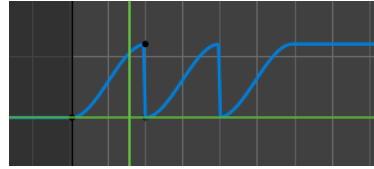
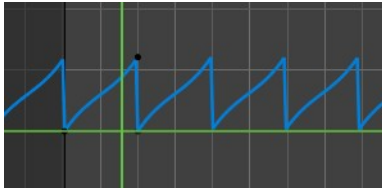
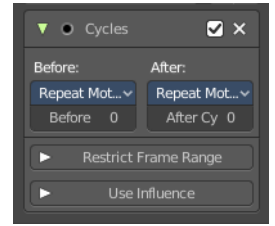

Trivially Cyclic Curves

When the Cycle Mode for both ends is set to either Repeat Motion or Repeat with Offset, and no other options of the modifier are changed from their defaults, it defines a simple infinite cycle.

This special case receives some additional support from other areas of Blender:

Automatic Bezier handle placement is aware of the cycle and adjusts to achieve a smooth transition.

The Cycle-Aware Keying option can be enabled to take the cycle into account when inserting new keyframes.

Before

Set the cycle mode before the first keyframe.



Before Cycles

Maximum number of cycles to allow before first keyframes. A value of 0 means infinite.

After

Set the cycle mode after the first keyframe.



After Cycles

Maximum number of cycles to allow after last keyframes. A value of 0 means infinite.

Restrict Frame Range

Expanding the Restrict Frame range sets it to active. It reveals some value slider then.

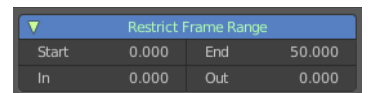

Start / End

The start and end frame of the generated curve.

In / Out

Fade the curve in or out for chosen frame numbers.

Use Influence

Temper the F-Curve Modifier effect by a default influence factor.

Expanding the Use Influence sets it to active. It reveals a value slider then.

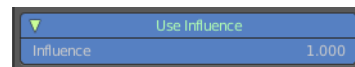

Influence

The influence factor.

Noise modifier

Adds noise to the curve.

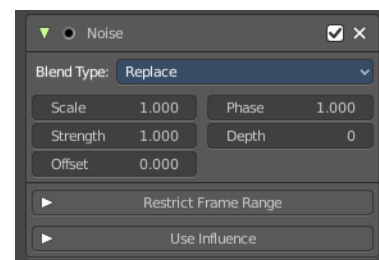
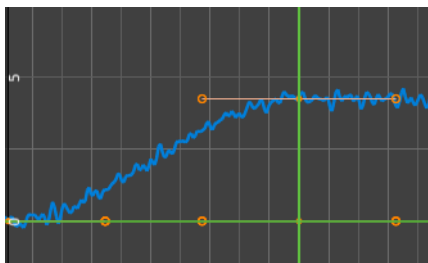

Blend Type

How to blend the noise with the curve.

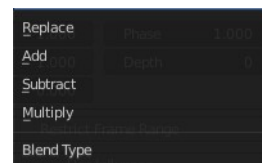

Scale

The overall size of the noise. The bigger the value the less frequent the noise.

Strength

Adjust the Y value of the noise.

Offset

Time offset of the noise.

Phase

The random seed for the noise.

Depth

How detailed the noise function is.

Restrict Frame Range

Expanding the Restrict Frame range sets it to active. It reveals some value slider then.

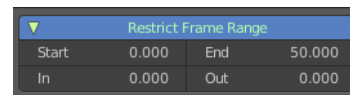

Start / End

The start and end frame of the generated curve.

In / Out

Fade the curve in or out for chosen frame numbers.

Use Influence

Temper the F-Curve Modifier effect by a default influence factor.

Expanding the Use Influence sets it to active. It reveals a value slider then.

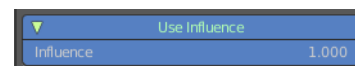

Influence

The influence factor.

Limits modifier

Sets limits to the curve in specified x and y range values.

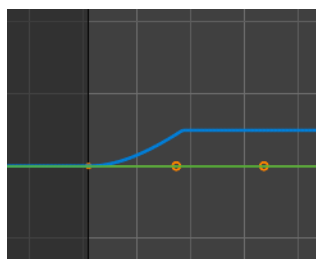

Minimum / Maximum X

Cuts the curve at these minimum and maximum frame values.

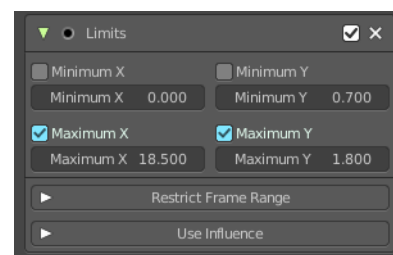

Minimum / Maximum Y

Clamps the curve at these minimum and maximum values.

Restrict Frame Range

Expanding the Restrict Frame range sets it to active. It reveals some value slider then.

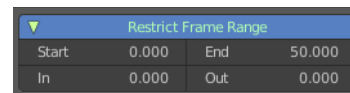

Start / End

The start and end frame of the generated curve.

In / Out

Fade the curve in or out for chosen frame numbers.

Use Influence

Temper the F-Curve Modifier effect by a default influence factor.

Expanding the Use Influence sets it to active. It reveals a value slider then.

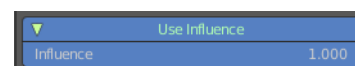

Influence

The influence factor.

Stepped Interpolation modifier

Adds steps to the curve by rounding the values.

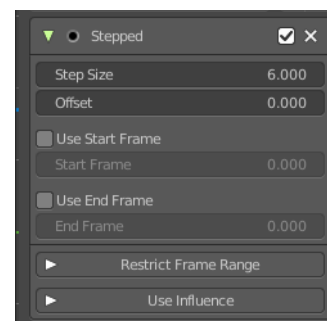
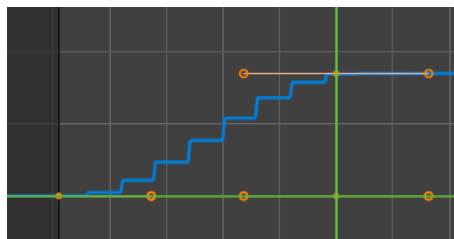

Step Size

The number of frames to hold each frame

Offset

A number of offset frames before frames get held.

Use Start Frame

Restrict the modifier so that it just acts before its end frame.

Use End Frame

Restrict the modifier so that it just acts after its start frame.

Restrict Frame Range

Expanding the Restrict Frame range sets it to active. It reveals some value slider then.

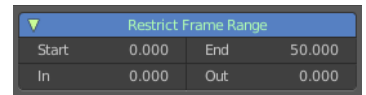

Start / End

The start and end frame of the generated curve.

In / Out

Fade the curve in or out for chosen frame numbers.

Use Influence

Temper the F-Curve Modifier effect by a default influence factor.

Expanding the Use Influence sets it to active. It reveals a value slider then.

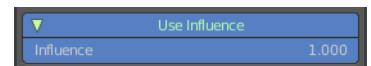

Influence

The influence factor.



21 Editors - Text Editor

Table of content

Text Editor.....	4
Slider snapping.....	4
Header - File Menu.....	5
New Text.....	5
Open Text.....	5
Reload.....	5
Edit Externally.....	5
Save.....	5
Save As.....	5
Templates.....	6
Redraw Timer.....	6
Debug Menu.....	6
Reload Scripts.....	6
Clean up Space Data.....	6
Memory Statistics.....	6
Header - View Menu.....	6
Sidebar.....	6
Zoom In.....	7
Zoom Out.....	7
Top of File.....	7
Bottom of File.....	7
Area.....	7
Horizontal Split.....	7
Vertical Split.....	7
Duplicate Area into new Window.....	7
Toggle Maximize Area.....	7
Toggle Fullscreen Area.....	7
Close Area.....	7
Header - Edit Menu.....	8
Cut.....	8
Copy.....	8
Paste.....	8
Duplicate Line.....	8
Move Line up.....	8
Move Line down.....	8
Select Text.....	8
Move Cursor.....	8
Delete.....	9
Select all.....	9
Select Line.....	9
Go to Line.....	9
Find.....	9
Find & Set Selection.....	9
Text Auto Complete.....	9
Text to 3D Object.....	9
One Object.....	9
One Object Per Line.....	9

Header - Format Menu.....	10
Indent.....	10
Unindent.....	10
Comment.....	10
Uncomment.....	10
Toggle comments.....	10
Whitespaces to Spaces.....	10
Whitespaces to Tabs.....	10
Header - Tools.....	10
Text Prop.....	10
List of text files.....	11
Search form.....	11
Text Edit Box.....	11
Unlink Datablock.....	11
File selector menu.....	11
New.....	11
Duplicate.....	11
Unlink Datablock.....	11
Fake User.....	11
Open Image.....	11
Unpack Item.....	12
User.....	12
Run Script.....	12
Register.....	12
Info String.....	12
Show Line Numbers, Wrap and Syntax Highlight.....	12
Tool Shelf.....	12
Properties Panel.....	12
Highlight.....	12
Live Edit.....	12
Font Size.....	12
Tab width.....	13
Show Margin.....	13
Margin Column.....	13
Find & Replace Panel.....	13
Find Edit Box.....	13
Find set selected.....	13
Find Next.....	13
Replace Edit Box.....	13
Replace set selected.....	13
Replace.....	14
Replace all.....	14
Match case.....	14
Wrap.....	14
All.....	14
Footer.....	14
Info String.....	14
Context menu.....	14
Cut.....	15
Copy.....	15
Paste.....	15
Move Line up.....	15
Move Line down.....	15

Indent.....	15
Unindent.....	15
Toggle comments.....	15
Text Auto Complete.....	15

Text Editor

The Text Editor is mainly used to write scripts. And so the functionality orients towards this usage. But you can also use it to write any text. To store some notes for the scene for example. See Tip below.

When you don't have a file loaded then the header content is rather small.

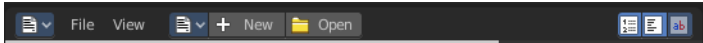

Once you create a new file, or load a file, you will see the toolbar change, and reveal further functionality.



Some text related functionality can also be found in the tool shelf at the right.

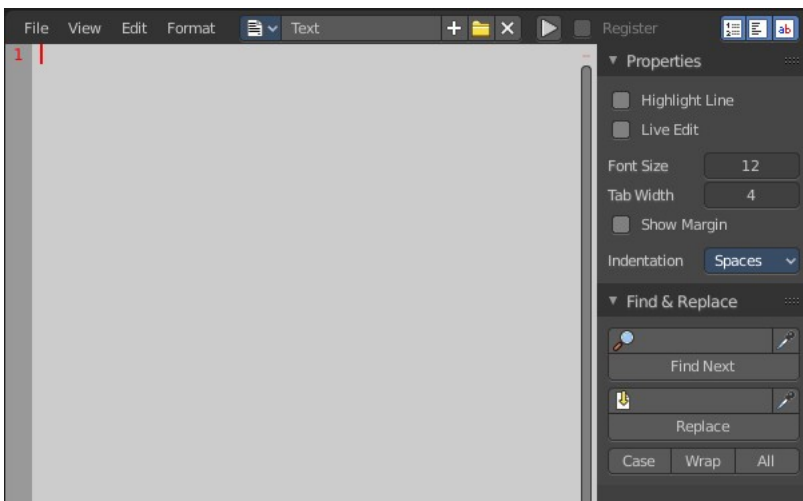

Tip

A Text window can be used to write in a README text explaining the contents of your blend file. Be sure to keep it visible when saving! And be sure to tell the receiver to activate Load UI to display the text file then. Bforartists has Load UI deactivated by default.

Slider snapping

Snapping also works at sliders. Hover with the mouse over the slider, start to slide, and holding down **ctrl** will snap the sliders in incremental steps.

When it's a default value between 0 and 1 then it usually snaps in 0.1 steps. When it's a default value over 1 then it usually snaps in steps of 10.

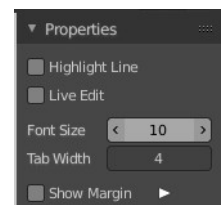

The increment snapping also works at the frame slider.

Header - File Menu

The File menu contains the load and save functionality. But also some Python and OSL templates. And some general debug functionality.

When no text is loaded then the menu is reduced.

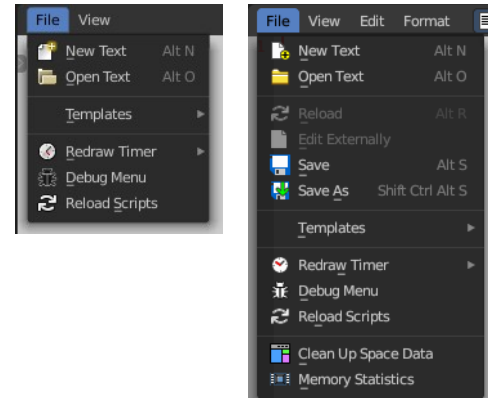

New Text

Creates a new text file.

Open Text

Open a text file.

Reload

It can happen that you work with an external script editor, like Visual Studio, and change your script there. The reload button reloads the current active text file from hard disk.

You will get a warning symbol in the header when the script in the text editor doesn't match with the external text anymore.



Edit Externally

Allows you to edit your file externally with a defined code editor like VS Code.

Note that you need to define the external editor in the preferences first.

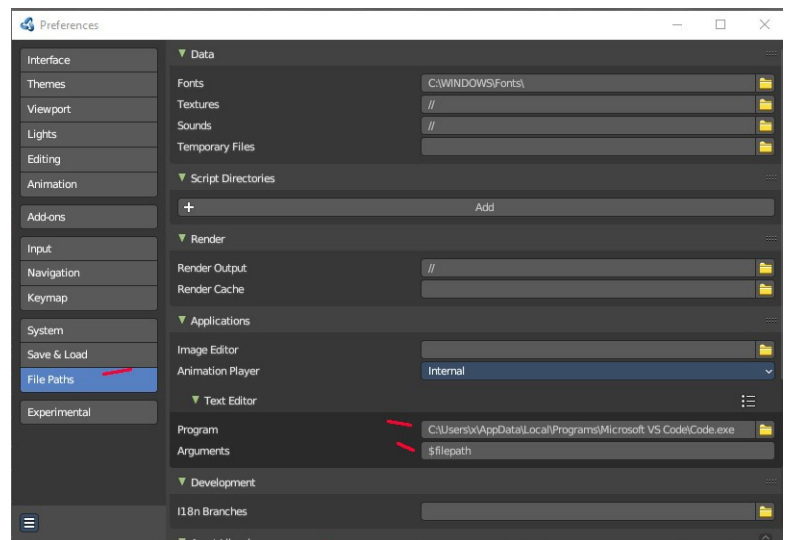

Save

Saves the text file. Overwrites the existing version immediately.

Save As

Save as opens a save as file dialog.

Templates

The Templates category contains some example scripts. There are two kind of templates. Python scripts and Open Shading Language scripts. The name of the files should tell you what the script is good for.

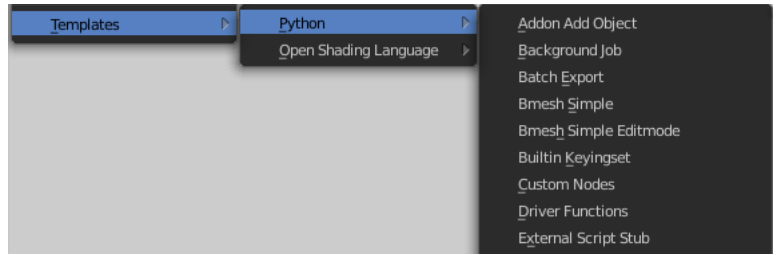

Redraw Timer

This is a relict from early Blender days. A debugging timer for the UI where you can test the redraw time of different UI elements.

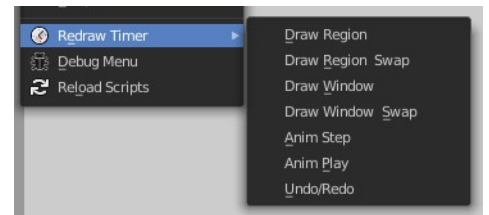

Debug Menu

Another development tool. Set the debug level.

```
bpy.data.window_managers["WinMan"].(null) = 5
```

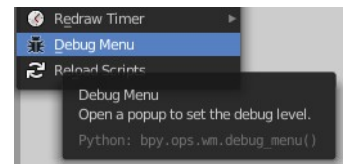

Reload Scripts

Reload Scripts reloads all active python scripts and addons. Including the Bforartists python UI files. This can be useful when you work at the UI or at an add-on. Then you don't have to close and reload Bforartists to see the changes. You can simply reload the scripts and keep Bforartists open.

Clean up Space Data

Remove unused settings for invisible editors.

Memory Statistics

Print memory statistics to the console. You need to have the console open.

```
total memory len: 19.353 MB  
peak memory len: 24.806 MB
```

Header - View Menu

The View menu contains some view related functionality.

Sidebar

Opens or closes the sidebar.

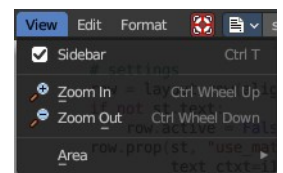

Zoom In

Zooms in to adjust the font size to use for displaying the text. The font size can also be adjusted in the sidebar.

Zoom Out

Zooms out to adjust the font size to use for displaying the text. The font size can also be adjusted in the sidebar.

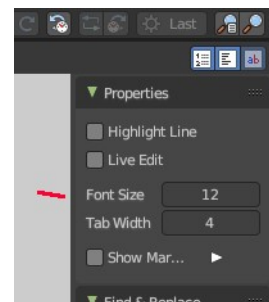

Top of File

Jumps to the top of the text file.

Bottom of File

Jumps to the bottom of the text file.

Area

Area is a menu with window related settings.

Horizontal Split

Splits the editor horizontally into two editors.

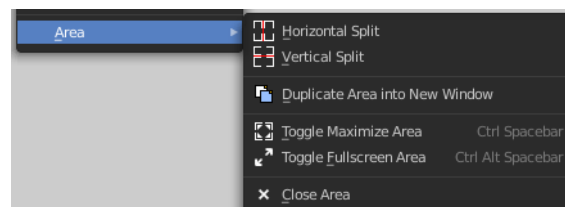

Vertical Split

Splits the editor vertically into two editors.

Duplicate Area into new Window

Creates a floating window out of the current editor

Toggle Maximize Area

Displays the editor maximized with menus.

To return to split view press hotkey Ctrl Up Arrow, or reuse the menu item in the View menu.

Toggle Fullscreen Area

Displays the editor maximized without menus.

To return from the full screen view press hotkey Alt F10, or use the little button that appears up right when you move the mouse in this corner.

Close Area

Closes the area window.

Header - Edit Menu

The Edit menu contains tools to modify the text.

Cut

Cuts the selected text.

Copy

Copies the selected text.

Paste

Pastes copied text at Text cursor position.

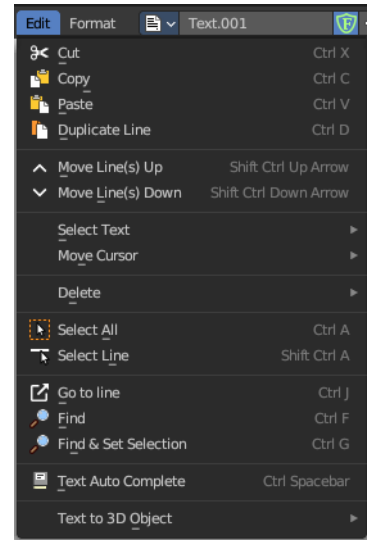

Duplicate Line

Duplicates the line where the Text cursor currently is.

Move Line up

Moves the line where the Text cursor is one line up.

Move Line down

Moves the line where the Text cursor is one line down.

Select Text

Select text is a sub menu that contains selection functionality, starting from the current position of the Text cursor. The buttons should be self explaining. And usually you use the hotkeys for this functionality.

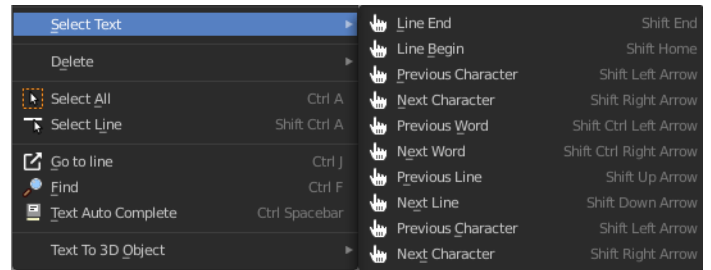

Move Cursor

This sub menu contains all available methods and its hotkeys to set the mouse cursor in the text.

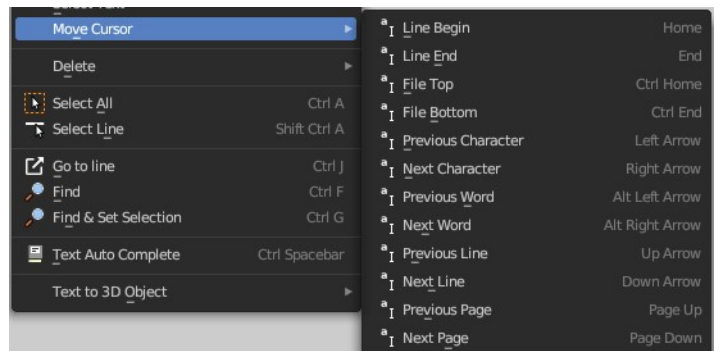

Delete

Delete is a sub menu with some special Delete methods, starting from the current position of the Text cursor. And usually you use the hotkeys for this functionality.

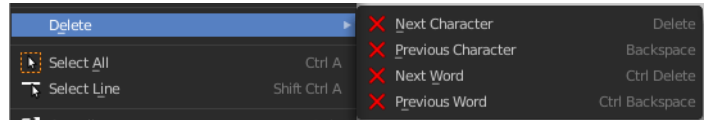

Select all

Selects all text.

Select Line

Selects the line where the Text cursor. currently is

Go to Line

This tool opens a sub menu where you can type in the line number and jump to this line then.

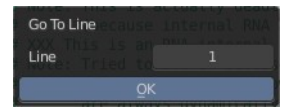

Find

Find opens the Tool Shelf, where you can find a Find & Replace panel. The Find & Replace panel is explained in the tool shelf chapter.

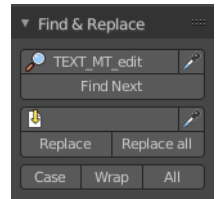

Find & Set Selection

Finds and selects the next text element that matches with the current selection. It's the same functionality than the Find Next button in the Find & Replace panel.

Text Auto Complete

Auto Complete tries to complete your text input.

Text to 3D Object

Text to 3D Object converts the text of the file to an editable 3D object in the 3D Viewport.



One Object

Converts the whole text into one object.

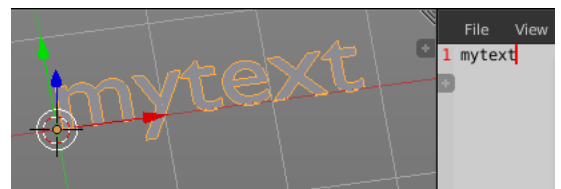

One Object Per Line

Converts every line of the text into a separate object.

Header - Format Menu

The format menu contains some formatting functionality.

Indent

Indents the text. Python requires proper indentation.

Unindent

Unindents the text.

Comment

Comments the text out. For Python usually with a # sign.

Uncomment

Uncomments commented text.

Toggle comments

Toggles the comments.

Whitespaces to Spaces

Converts Whitespaces in the text to Spaces.

Whitespaces to Tabs

Converts Whitespaces in the text to Tabs.

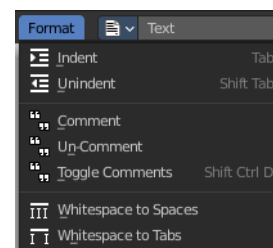

Header - Tools

The Header tools provides you with quick access functionality.



Text Prop

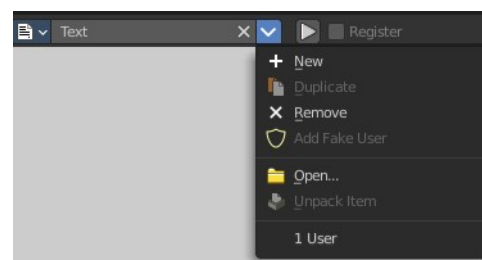

List of text files

This is a list of the images in the scene. This list allows you to switch to other images.

Search form

Search for specific images.

Text Edit Box

Read the name of the currently selected text. And you can rename the textfile here too.

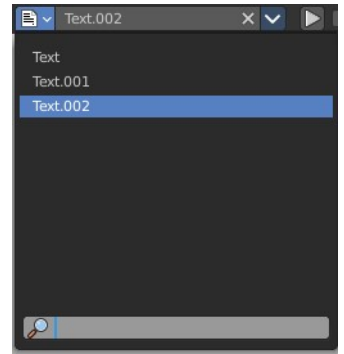

Unlink Datablock

This closes the selected text. Attention, different from the rest of the UI this text really vanishes immediately from the list then.

File selector menu

New

Create a new text file.

Duplicate

Not supported here.

Unlink Datablock

This deletes the selected image. Unfortunately not immediately. You need to save the scene and to reload it.

And you need to make sure that it is not linked to anything else. A mesh or a fake user for example. Have a look if there is a number besides the F button. When this is the case then the image has still a user, and so still loads with loading the scene.

Fake User

With this button you assign a fake user to this selected image.

Data, like images, that is not longer linked to anything else gets removed when you save and reload a scene. Bforartists has the concept of fake users to go around this behavior. An image with a fake user is in fact linked to something. And so it is not lost when you save and reload the scene.

Open Image

Opens the file browser to load an image.

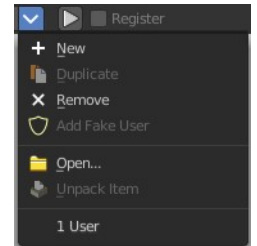

Unpack Item

Unpack packed files to a directory.

User

The number of users that uses this data. Data with a user number of 0 will be removed with closing Bforartists.

Run Script



This button is for python or OSL scripts. It executes the script.

Register

This checkbox is for Python or OSL Scripts. When checked the classes of the script gets registered in Bforartists.

Info String

Shows infos about the current text file. When it's an internal created file then it displays the String File: Internal. When it's an external loaded file, then the string displays the path to the location of the file.

Show Line Numbers, Wrap and Syntax Highlight



Show Line numbers displays a row of numbers at the left side of the text file.

Wrap words wraps the text to fit into the current editor size.

Syntax highlighting colors text parts fitting to the language.

Tool Shelf

The Tool Shelf is the place for some options and the text search panel.

Properties Panel

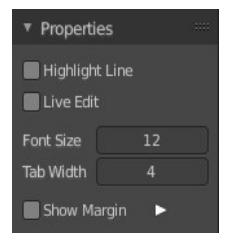

Highlight

Highlights the line where the text cursor is.

Live Edit

Updates the script while editing.

Font Size

The font size for the text editor

Tab width

Number of spaces to display tabs with. Default is four.

Show Margin

Shows a dotted line at the right. Note that we have currently a theming problem here with the default Bforartists theme. We have white text, means a white dotted line. And we have a white background. This means that the dotted line just shows with other themes where the header text color is black.

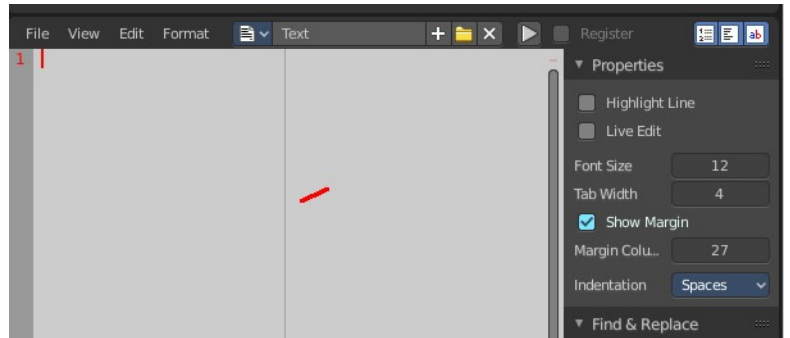

Margin Column

This edit box becomes visible when Show Margin is ticked.

Here you can adjust the width from the left at which the dotted margin line should show.

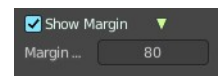

Find & Replace Panel

In the find panel you will find tools with text search and replace functionality.

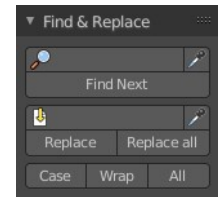

Find Edit Box

Here you can type in the string that you want to search.

Find set selected

Copies the currently selected text into the Find edit box, searches for a matching string in the text, and selects this match then.

Find Next

Searches for the next matching string in the text.

Replace Edit Box

Here you can type in the string that you want to replace in the text.

Replace set selected

Copies the currently selected text into the Find edit box, searches for a matching string in the text, and replaces

this match with the string in the Replace edit box.

Replace

Searches for the next matching string in the text. And replaces it the string in the Replace edit box.

Replace all

Searches for matching strings in the text. And replaces them all by the string in the Replace edit box.

Note

By default when the search does not find a matching string anymore in the text below the current selection, then you will get a warning that the search string is not present in the text file. It will not automatically start the search from the top again. You have to place the text cursor manually at the top of the text.

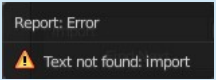

Or turn on the Wrap checkbox below.

Match case

When ticked then the search is Upper case sensitive.

Wrap

Starts the search from the top of the document when the search has reached the end of the document.

All

Search in all opened Text files, not just the currently active one.

Footer

Info String



This string shows infos about the current text file.

When it's an internal created file then it displays the String File: Internal.

When it's an external loaded file, then the string displays the full path to the location of the file.

Context menu

When you right click into the text editor then a popup menu opens up. It is to 100% made of double menu entries.

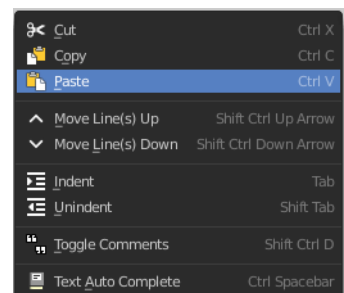

Cut

Cuts the selected text.

Copy

Copies the selected text.

Paste

Pastes copied text at Text cursor. position.

Move Line up

Moves the line where the Text cursor. is one line up.

Move Line down

Moves the line where the Text cursor. is one line down.

Indent

Indents the text. Python requires proper indentation.

Unindent

Unindents the text.

Toggle comments

Toggles the comments.

Text Auto Complete

Auto Complete tries to complete your text input.



22 Editors - Python Console

Table of content

Python Console.....	2
Console Menu.....	2
Console Execute.....	2
Clear.....	2
Clear Line.....	2
Copy as Script.....	2
Copy.....	2
Paste.....	2
Zoom Text Out.....	2
Zoom Text In.....	3
Languages.....	3
Area Menu.....	3
Horizontal Split.....	3
Vertical Split.....	3
Duplicate Area into new Window.....	3
Toggle Maximize Area.....	3
Toggle Fullscreen Area.....	3
Close Area.....	4
Edit Menu.....	4
Indent.....	4
Unindent.....	4
Cursor to Previous word.....	4
Cursor to Next word.....	4
Cursor to Line Begin.....	4
Cursor to Line End.....	4
Cursor to Previous Character.....	4
Cursor to Next character.....	4
Delete.....	5
Next character.....	5
Previous Character.....	5
Next Word.....	5
Previous Word.....	5
History Cycle.....	5
Auto complete.....	5
Usage.....	6
Accessing Built-in Python Console.....	6
First look at the Console Environment.....	6
Auto Completion at work.....	7
Before working with the modules.....	7
Examples.....	8
bpy.context.....	8
Try it out!.....	8
bpy.data.....	9
Try it out!.....	9
Exercise.....	9
bpy.ops.....	10
Try it out!.....	10

Python Console

The Python console is a quick way to execute commands, with access to the entire Python API, command history and auto-complete. It's a research tool for addon- and script developers. But also a place to quickly execute single operators or to try out some simple code.

Console Menu

The Console menu provides some console editor window specific functionality.

Console Execute

The expressions in the python console are not read only. You can execute them like you would do from a script. This button executes a selected command.

Clear

Clears all lines. The blue help text remains.

Clear Line

Clears the selected line(s).

Copy as Script

Copies the whole content of the console as a script that can be pasted into the Text editor.

Copy

Copies selected content.

Paste

Pastes copied content.

Zoom Text Out

Zooms out the text in the console window.

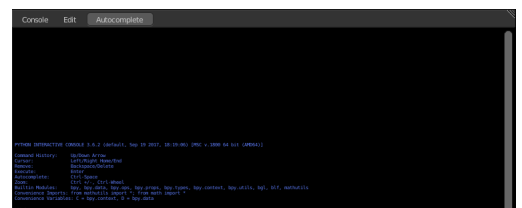
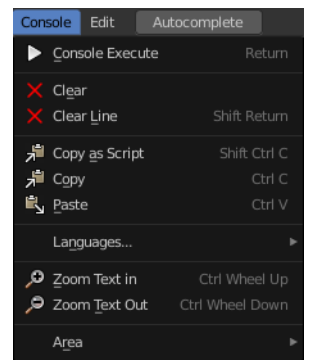

Zoom Text In

Zooms in the text in the console window.

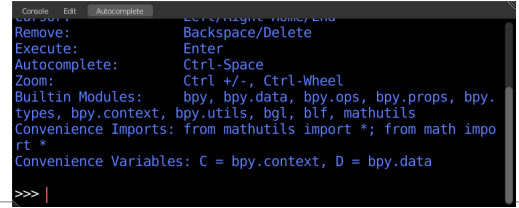

Languages

Languages is a sub menu where you can choose the language.

This menu looks pretty useless, since there is just one language available. Python. But it has its usage. With a click at the Python button you can restart the console when you have lost yourself in the deeps of the API.

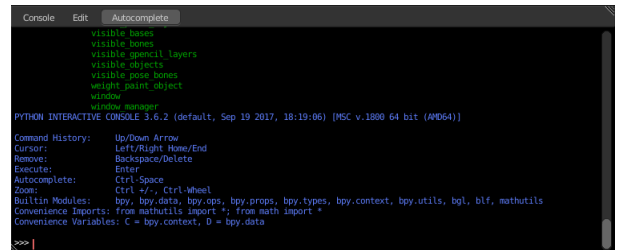

Area Menu

Area is a menu with window related settings.

Horizontal Split

Splits the editor horizontally into two editors.

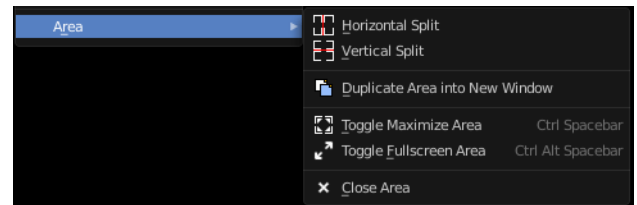

Vertical Split

Splits the editor vertically into two editors.

Duplicate Area into new Window

Creates a floating window out of the current editor.

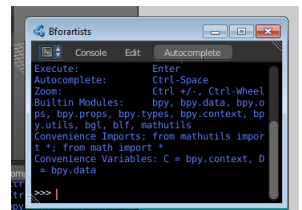

Toggle Maximize Area

Displays the editor maximized with menus.

To return to split view press hotkey Ctrl Spacebar, or reuse the menu item in the View menu.

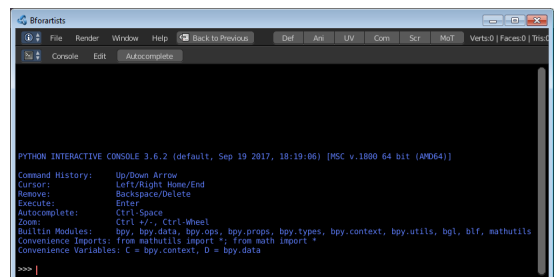

Toggle Fullscreen Area

Displays the editor maximized without menus.

To return from the full screen view press hotkey Ctrl Alt Spacebar, or use the little button that appears up right when you move the mouse in this corner.

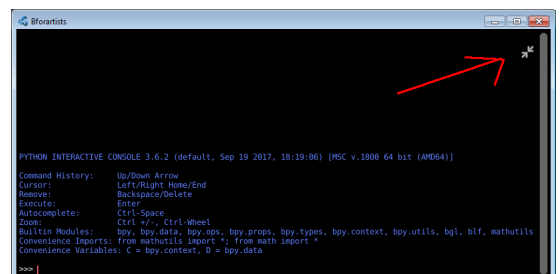

Close Area

Closes the area window.

Edit Menu

The Edit menu provides you with text specific functionality. Its content should be used by hotkeys. The menu is more to show that this functionality exists.

Indent

Indents the selected text.

Unindent

Removes indentation of the selected text.

Cursor to Previous word

Sets the caret in front of the previous word.

Cursor to Next word

Sets the caret in front of the next word.

Cursor to Line Begin

Sets the caret to line begin.

Cursor to Line End

Sets the caret to line end.

Cursor to Previous Character

Sets the caret in front of the previous character.

Cursor to Next character

Sets the caret in front of the next character.

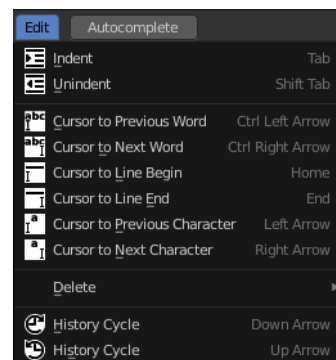

Delete

Delete is a sub menu with several delete methods.

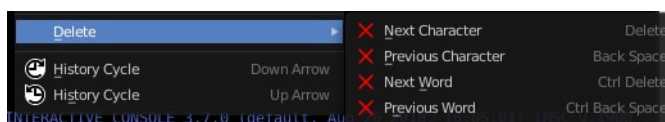

Next character

Deletes the character beyond the caret.

Previous Character

Deletes the character before the caret.

Next Word

Deletes the word beyond the caret.

Previous Word

Deletes the word before the caret.

History Cycle

Cycles through the history. Up arrow cycles forwards through the history.

Down arrow cycles backwards through the history.

What does this mean? When you write some text, then add something more, delete something, then all this steps are entries in the history. And with History cycle you can access this steps.

Auto complete

Auto complete is a functionality to auto complete what you have written in the console. It lists for example all available bpy operators when you type in `bpy.context.area`, and then hit the Auto complete button. That way you can go through the whole bpy hierarchy down to what you need for your code, starting with `bpy.`, and having a look at what is available.

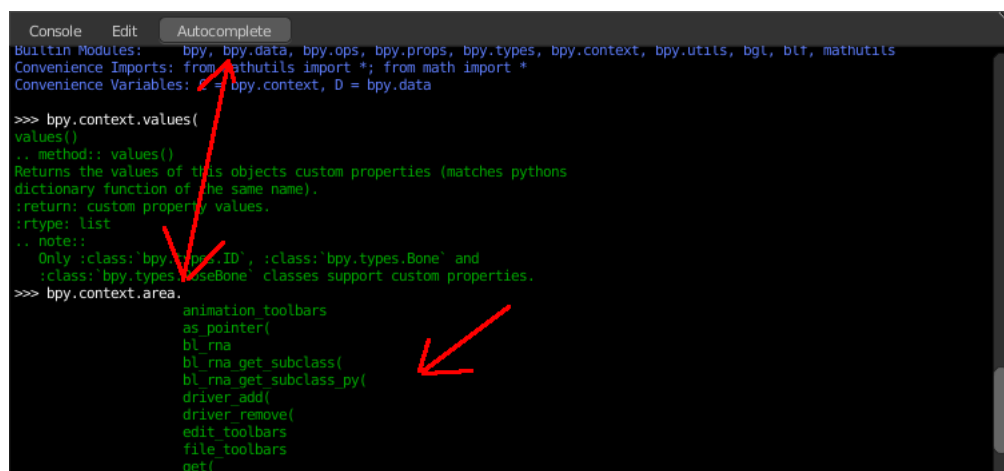

Usage

Accessing Built-in Python Console

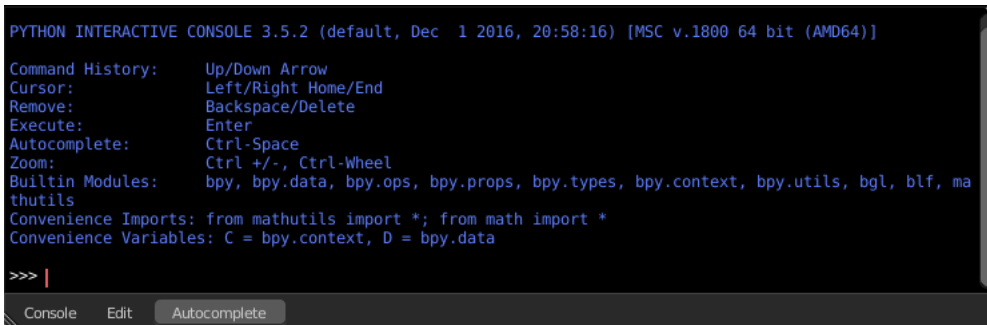

```
PYTHON INTERACTIVE CONSOLE 3.5.2 (default, Dec 1 2016, 20:58:16) [MSC v.1800 64 bit (AMD64)]
Command History: Up/Down Arrow
Cursor: Left/Right Home/End
Remove: Backspace/Delete
Execute: Enter
Autocomplete: Ctrl-Space
Zoom: Ctrl +/-, Ctrl-Wheel
Builtin Modules: bpy, bpy.data, bpy.ops, bpy.props, bpy.types, bpy.context, bpy.utils, bgl, blf, ma
thutils
Convenience Imports: from mathutils import *; from math import *
Convenience Variables: C = bpy.context, D = bpy.data
>>> |
```

From the screen shot above, you will notice that by clicking at the Auto complete button you can enable Auto-complete feature.

The command prompt is typical for Python 3.x, the interpreter is loaded and is ready to accept commands at the prompt `>>>`

First look at the Console Environment

To check what is loaded into the interpreter environment, type `dir()` at the prompt and execute it.

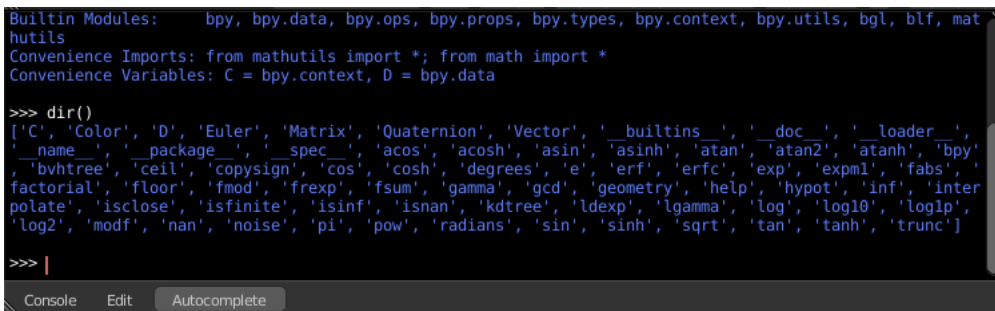

```
Builtin Modules: bpy, bpy.data, bpy.ops, bpy.props, bpy.types, bpy.context, bpy.utils, bgl, blf, ma
thutils
Convenience Imports: from mathutils import *; from math import *
Convenience Variables: C = bpy.context, D = bpy.data
>>> dir()
['C', 'Color', 'D', 'Euler', 'Matrix', 'Quaternion', 'Vector', '_builtins_', '_doc_', '_loader_',
'_name_', '_package_', '_spec_', 'acos', 'acosh', 'asin', 'asinh', 'atan', 'atan2', 'atanh', 'bpy',
'bvhtree', 'ceil', 'copysign', 'cos', 'cosh', 'degrees', 'e', 'erf', 'erfc', 'exp', 'expm1', 'fabs',
'factorial', 'floor', 'fmod', 'frexp', 'fsum', 'gamma', 'gcd', 'geometry', 'help', 'hypot', 'inf', 'inter
polate', 'isclose', 'isfinite', 'isinf', 'isnan', 'kdtree', 'ldexp', 'lgamma', 'log', 'log10', 'loglp',
'log2', 'modf', 'nan', 'noise', 'pi', 'pow', 'radians', 'sin', 'sinh', 'sqrt', 'tan', 'tanh', 'trunc']
>>> |
```

Following is a quick overview of the output

C

Quick access to `bpy.context`

D

Quick access to `bpy.data`

bpy

Top level Bforartists Python API module.

The rest of the commands are of various content. Most of them are mathematical expressions.

Auto Completion at work

Type bpy. and then press the Auto complete button.

```
Builtin Modules:  bpy, bpy.data, bpy.ops, bpy.props, bpy.types, bpy.context, bpy.utils, bgl, blf, mat
hutils
Convenience Imports: from mathutils import *; from math import *
Convenience Variables: C = bpy.context, D = bpy.data

>>> dir()
['C', 'Color', 'D', 'Euler', 'Matrix', 'Quaternion', 'Vector', '_builtins_', '_doc_', '_loader_',
'_name_', '_package_', '_spec_', 'acos', 'acosh', 'asin', 'asinh', 'atan', 'atan2', 'atanh', 'bpy',
'_bvhtree', 'ceil', 'copysign', 'cos', 'cosh', 'degrees', 'e', 'erf', 'erfc', 'exp', 'expm1', 'fabs',
'factorial', 'floor', 'fmod', 'frexp', 'fsum', 'gamma', 'gcd', 'geometry', 'help', 'hypot', 'inf', 'inter
polate', 'isclose', 'isfinite', 'isinf', 'isnan', 'kdtree', 'ldexp', 'lgamma', 'log', 'log10', 'loglp',
'log2', 'modf', 'nan', 'noise', 'pi', 'pow', 'radians', 'sin', 'sinh', 'sqrt', 'tan', 'tanh', 'trunc']

>>> bpy.|
```

A list of sub-modules inside of bpy will appear. These modules encapsulate all that we can do with Bforartists Python API.

Lets list all the contents of bpy.app module.

```
['C', 'Color', 'D', 'Euler', 'Matrix', 'Quaternion', 'Vector', '_builtins_', '_doc_', '_loader_',
'_name_', '_package_', '_spec_', 'acos', 'acosh', 'asin', 'asinh', 'atan', 'atan2', 'atanh', 'bpy',
'_bvhtree', 'ceil', 'copysign', 'cos', 'cosh', 'degrees', 'e', 'erf', 'erfc', 'exp', 'expm1', 'fabs',
'factorial', 'floor', 'fmod', 'frexp', 'fsum', 'gamma', 'gcd', 'geometry', 'help', 'hypot', 'inf', 'inter
polate', 'isclose', 'isfinite', 'isinf', 'isnan', 'kdtree', 'ldexp', 'lgamma', 'log', 'log10', 'loglp',
'log2', 'modf', 'nan', 'noise', 'pi', 'pow', 'radians', 'sin', 'sinh', 'sqrt', 'tan', 'tanh', 'trunc']

>>> bpy.app.version
(2, 78, 4)

>>> bpy.app.version_string
'2.78 (sub 4)'
```

Notice the green output above the prompt where you enabled auto-completion. What you see is the result of auto completion listing. In the above listing all are module attribute names, but if you see any name end with '(' , then that is a function.

We will make use of this a lot to help our learning the API faster. Now that you got a hang of this, lets proceed to investigate some of modules in bpy.

Before working with the modules.

If you look at the 3D Viewport in the default Bforartists scene, you will notice some objects. We have added a cube here too.

- All objects exist in a context and there can be various modes under which they are operated upon.
- At any instance, only one object is active and there can be more than one selected objects.
- All objects are data in the Bforartists file.
- There are operators/functions that create and modify these objects.

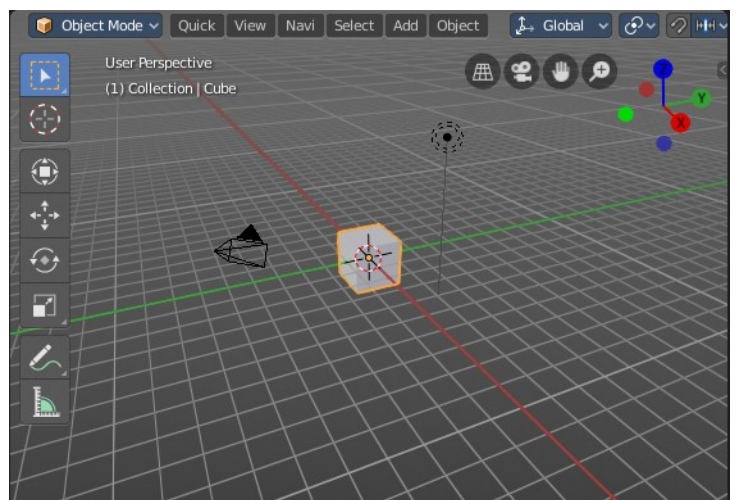

For all the scenarios listed above the bpy module provides functionality to access and modify data.

Examples

Note

For the commands below to show the proper output, make sure you have selected object(s) in the 3D view.

bpy.context

```
>>> bpy.context.mode
'OBJECT'

>>> bpy.context.object
bpy.data.objects['Cube']

>>> bpy.context.active_object
bpy.data.objects['Cube']

>>> bpy.context.selected_objects
[bpy.data.objects['Cube']]

>>> bpy.context.selected_objects
[bpy.data.objects['Cube'], bpy.data.objects['Lamp Hemi'], bpy.data.objects['Camera']]

>>> |
```

Try it out!

bpy.context.mode

Will print the current 3D View mode (Object, Edit, Sculpt etc.)

bpy.context.object or bpy.context.active_object

Will give access to the active object in the 3D View

```
>>> bpy.context.object.location.x = 1
```

Change x location to a value of 1

```
>>> bpy.context.object.location.x += 0.5
```

Move object from previous x location by 0.5 unit

```
>>> bpy.context.object.location = (1, 2, 3)
```

Changes x, y, z location

```
>>> bpy.context.object.location.xyz = (1, 2, 3)
```

Same as above

```
>>> type(bpy.context.object.location)
```

Data type of objects location

```
>>> dir(bpy.context.object.location)
```

Now that is a lot of data that you have access to

bpy.context.selected_objects

Will give access to a list of all selected objects.

```
>>> bpy.context.selected_objects
```

... then press **Ctrl-Spacebar**

```
>>> bpy.context.selected_objects[0]
```

Prints out name of first object in the list

```
>>> [object for object in bpy.context.selected_objects if object != bpy.context.object]
```

Complex one... But this prints a list of objects not including the active object

bpy.data

`bpy.data` has functions and attributes that give you access to all the data in the Bforartists file.

You can access following data in the current Bforartists file: objects, meshes, materials, textures, scenes, screens, sounds, scripts, ... etc.

That's a lot of data.

Try it out!

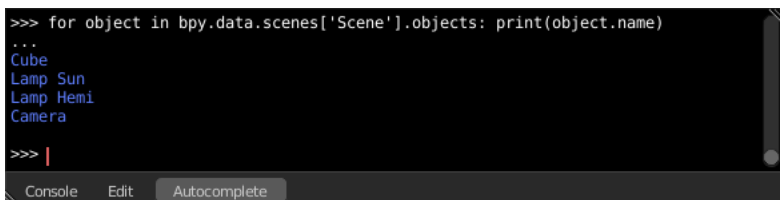

```
>>> for object in bpy.data.scenes['Scene'].objects: print(object.name)
...
Cube
Lamp_Sun
Lamp_Hemi
Camera
>>> |
```

The screenshot shows a dark-themed Python console window. The first line of code is `for object in bpy.data.scenes['Scene'].objects: print(object.name)`. Below it, the output shows the names of objects: `Cube`, `Lamp_Sun`, `Lamp_Hemi`, and `Camera`. At the bottom of the window, there are buttons for `Console`, `Edit`, and `Autocomplete`.

Exercise

```
>>> for object in bpy.data.scenes['Scene'].objects: print(object.name)
```

Return twice Prints the names of all objects belonging to the Bforartists scene with name “Scene”

```
>>> bpy.data.scenes['Scene'].objects.unlink(bpy.context.active_object)
```

Unlink the active object from the Bforartists scene named ‘Scene’

```
>>> bpy.data.materials['Material'].shadows
```

```
>>> bpy.data.materials['Material'].shadows = False
```

bpy.ops

The tool/action system in Bforartists is built around the concept of operators. These operators can be called directly from console or can be executed by click of a button or packaged in a python script. Very powerful they are..

Lets create a set of five Cubes in the 3D Viewport. First, delete the existing Cube object by selecting it and pressing X

Try it out!

The following commands are used to specify that the objects are created in layer 1. So first we define an array variable for later reference:

```
>>> mylayers = [False] * 20
>>> mylayers[0] = True
```

We create a reference to the operator that is used for creating a cube mesh primitive

```
>>> add_cube = bpy.ops.mesh.primitive_cube_add
```

Now in a for loop, we create the five objects like this (In the screenshot above, I used another method) Press ENTER-KEY twice after entering the command at the shell prompt.

```
>>> for index in range(0, 5): add_cube(location=(index * 3, 0, 0), layers=mylayers)
```

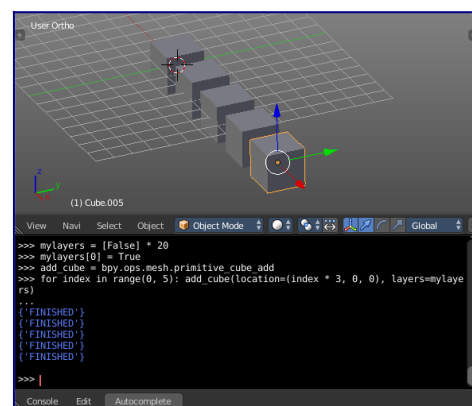



23 Editors - Info Editor

Table of content

Info Editor.....	1
Header.....	1
View Menu.....	2
Area Menu.....	2
Horizontal Split.....	2
Vertical Split.....	2
Duplicate Area into new Window.....	2
Toggle Maximize Area.....	2
Toggle Fullscreen Area.....	3
Close Area.....	3
Info Menu.....	3
All.....	3
None.....	3
Inverse.....	3
Toggle Selection.....	3
Box Select.....	3
Delete.....	3
Copy.....	3
Hotkey only functionality.....	3
Replay Operator - R.....	4

Info Editor

The Info Editor has just one purpose. It lists the performed operations in the current session. And displays them as Python commands. Here you can also find error messages.

You can find the Info Editor in the scripting layout down left.

You can copy text from the Info Editor by marking some text, and then use the hotkey ctrl + c to copy it.

Header

In the Scripting Layout the header of the Info Editor is collapsed. Pull it down to reveal it. The Editor Type menu is explained in chapter 6 Editors introduction.

```
✓ bpy.ops.mesh.primitive_cube_add(size=2, enter_editmode=False, location=(0, 0, 0))
✓ bpy.ops.mesh.primitive_uv_sphere_add(radius=1, enter_editmode=False, location=(0, 0, 0))
✓ bpy.ops.object.editmode_toggle()
bpy.context.space_data.show_region_header = False
```

```
View Info
✓ bpy.ops.mesh.primitive_cube_add(size=2, enter_editmode=False, location=(0, 0, 0))
✓ bpy.ops.mesh.primitive_uv_sphere_add(radius=1, enter_editmode=False, location=(0, 0, 0))
✓ bpy.ops.object.editmode_toggle()
bpy.context.space_data.show_region_header = False
```

View Menu

Area Menu

Area is a menu with window related settings.

Horizontal Split

Splits the editor horizontally into two editors.

Vertical Split

Splits the editor vertically into two editors.

Duplicate Area into new Window

Creates a floating window out of the current editor.

Toggle Maximize Area

Displays the editor maximized with menus.

To return to split view press hotkey Ctrl Spacebar, click at the Back to Previous button, or reuse the menu item in the View menu.

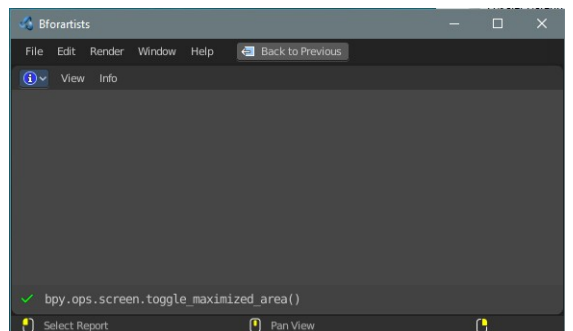
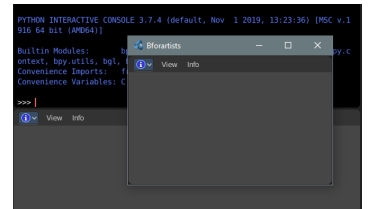
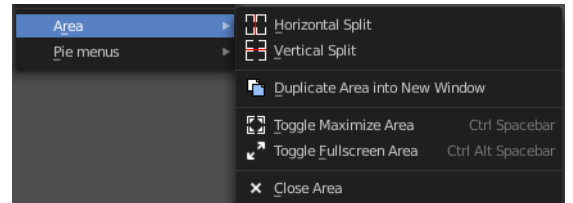

Toggle Fullscreen Area

Displays the editor maximized without menus.

To return from the full screen view press hotkey Ctrl Alt Spacebar, or use the little button that appears up right when you move the mouse in this corner.



Close Area

Closes the area window.

Info Menu

The Info menu provides some console editor window specific functionality.

All

Select all.

None

Select nothing.

Inverse

Inverts the selection.

Toggle Selection

Toggles the selection.

Box Select

Box select text.

Delete

Deletes selected content.

Copy

Copies selected content.

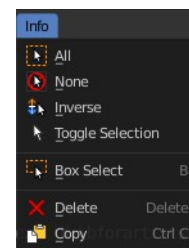

Hotkey only functionality

Important! These hotkeys works with the default Bforartists key map. And they do not list the N dof hotkeys. N dof is a 3d connexion mouse device that is also used for tablets.

Most of the tools can be found in the graphical UI. But there are still some tools that are hotkey only. Some have a UI brother with equal functionality. For example, Pick shortest path is the hotkey sister of Select shortest path. Some are hotkey only since they cannot be integrated in the graphical UI. Like calling the File menu under the mouse. Or mouse position dependent functionality like selecting an edge loop.

The navigation hotkeys and the context menus are excluded here since they are already covered.

Replay Operator - R

Replay Operator.



24 Editors - Toolbar

Table of content

- Detailed Table of Content.....1
- Introduction.....8
 - Limits.....9
- Menus.....9
 - Toolbar Type menu.....9
 - Toolbars Menus.....9
- Toolbar Settings Bforartists add-on.....10
- Create new toolbar.....10
- Save Toolbar state.....11
- Toolbar Types.....12
 - Toolbar Types.....12
 - Options.....12
- Toolbars File.....13
 - Available Toolbars.....13
- Toolbars Mesh Edit.....18
 - Available Toolbars.....18
- Toolbars Primitives.....22
 - Available Toolbars.....22
- Toolbars Image.....29
 - Available Toolbars.....29
- Toolbars Tools.....31
 - Available Toolbars.....31
- Toolbars Animation.....34
 - Available Toolbars.....34
- Toolbars Edit.....37
 - Available Toolbars.....37
- Toolbars Misc.....40
 - Available Toolbars.....41
 - Viewport.....41

Detailed Table of Content

23 Editors - Toolbar

- Detailed Table of Content.....1
- Introduction.....8
 - Limits.....9
- Menus.....9
 - Toolbar Type menu.....9
 - Toolbars Menus.....9
- Toolbar Settings Bforartists add-on.....10
- Create new toolbar.....10
- Save Toolbar state.....11
- Toolbar Types.....12
 - Toolbar Types.....12

Options.....	12
Show Quick Toggle.....	12
Toolbars File.....	13
Available Toolbars.....	13
Load / Save.....	13
File New.....	13
New from Template.....	13
Open.....	13
Open Recent.....	13
Save Blend File.....	13
Save As Blend File.....	13
Save Copy.....	14
Recover.....	14
Revert.....	14
Recover.....	14
Recover Last Session.....	14
Recover Autosave.....	14
Link Append.....	14
Link from Library.....	14
Append from Library.....	14
Import Menu.....	14
Export Menu.....	15
Import Common.....	15
Import FBX.....	15
Import Obj.....	15
Import ABC.....	15
Import Common 2.....	15
Import SVG into Grease Pencil.....	15
Import DAE.....	15
Import BVH.....	15
Import glTF2.....	15
Import Uncommon.....	15
Import STL.....	16
Import PLY.....	16
Import SVG.....	16
Export Common.....	16
Export FBX.....	16
Export Obj.....	16
Export ABC.....	16
Export Common 2.....	16
Export Grease Pencil to SVG.....	16
Export Grease Pencil to PDF.....	16
Export DAE.....	16
Export BVH.....	16
Export USD.....	16
Export glTF2.....	17
Export Uncommon.....	17
Export 3DS.....	17
Export PLY.....	17
Render.....	17
Render Image.....	17
Render Animation.....	17
Render Open GL.....	17

Open GL Render Image.....	17
Open GL Render Animation.....	17
Render Misc.....	17
Mixdown Audio.....	17
Show/ Hide Render view.....	17
Play rendered animation.....	18
Toolbars Mesh Edit.....	18
Available Toolbars.....	18
Vertices Split connect.....	18
Split.....	18
Vertex Connect Path.....	18
Vertex Connect.....	18
Vertices Misc.....	18
Convex Hull.....	18
Blend from Shape.....	19
Shape Propagate.....	19
Edges Subdiv.....	19
Subdivide Edge Ring.....	19
Un-Subdivide.....	19
Edges Sharp.....	19
Mark Sharp.....	19
Unmark Sharp.....	19
Edges Freestyle.....	19
Mark Freestyle Edge.....	19
Unmark Freestyle Edge.....	19
Edges Rotate.....	19
Rotate.....	19
Edges Misc.....	20
Edge Split.....	20
Bridge Edge loops.....	20
Faces general.....	20
Fill.....	20
Grid Fill.....	20
Beautify Faces.....	20
Solidify.....	20
Intersect.....	20
Boolean Intersect.....	20
Wire Frame.....	20
Faces Freestyle.....	20
Mark Freestyle Face.....	20
Unmark Freestyle Face.....	20
Faces Tris.....	21
Poke Faces.....	21
Triangulate Faces.....	21
Tris to Quads.....	21
Split by Edges.....	21
Faces Rotate Misc.....	21
Rotate UV's.....	21
Reverse UV's.....	21
Rotate Colors.....	21
Reverse Colors.....	21
Cleanup.....	21
Delete Loose.....	21

Decimate Geometry.....	21
Degenerate Dissolve.....	21
Make Planar Faces.....	21
Split Non Planar Faces.....	22
Split Concave Faces.....	22
Fill Holes.....	22
Toolbars Primitives.....	22
Available Toolbars.....	22
Mesh.....	22
Add Plane.....	22
Add Cube.....	22
Add Circle.....	22
Add UV Sphere.....	23
Add Cylinder.....	23
Add Cone.....	23
Add Torus.....	23
Add Grid.....	23
Curve.....	23
Add Bezier.....	23
Add Circle.....	23
Add Nurbs Curve.....	23
Add Nurbs Circle.....	23
Add Nurbs Path.....	23
Surface.....	23
Add Surface Curve.....	23
Add Surface Circle.....	24
Add Surface Patch.....	24
Add Surface Cylinder.....	24
Add Surface Sphere.....	24
Add Surface Torus.....	24
Metaball.....	24
Add Metaball of type Ball.....	24
Add Metaball of type Capsule.....	24
Add Metaball of type Plane.....	24
Add Metaball of type Ellipsoid.....	24
Add Metaball of type Cube.....	24
Point Cloud.....	24
Add Point Cloud.....	24
Volume.....	25
Import OpenVDB Volume.....	25
Add Volume.....	25
Grease Pencil.....	25
Blank.....	25
Stroke.....	25
Monkey.....	25
Scene Line Art.....	25
Collection Line Art.....	25
Lamp.....	25
Add Lamp of type Point.....	25
Add Lamp of type Sun.....	25
Add Lamp of type Spot.....	26
Add Lamp of type Area.....	26
Other.....	26

Add Text.....	26
Add Armature.....	26
Add Lattice.....	26
Add Camera.....	26
Add Speaker.....	26
Empties.....	26
Add Empty of type Plain Axes.....	26
Add Empty of type Sphere.....	26
Add Empty of type Circle.....	26
Add Empty of type Cone.....	26
Add Empty of type Cube.....	27
Add Empty of type Single Arrow.....	27
Add Empty of type Arrows.....	27
Add Empty of type Image.....	27
Image.....	27
Reference Image.....	27
Background Image.....	27
Light Probe.....	27
Reflection Cubemap.....	27
Reflection Plane.....	27
Irradiance Volume.....	27
Force Field.....	27
Add Physics Effector of Type Boid.....	27
Add Physics Effector of Type Charge.....	27
Add Physics Effector of Type Curve Guide.....	28
Add Physics Effector of Type Drag.....	28
Add Physics Effector of Type Force.....	28
Add Physics Effector of Type Harmonic.....	28
Add Physics Effector of Type Lenard-Jones.....	28
Add Physics Effector of Type Magnetic.....	28
Add Physics Effector of Type Smoke Flow.....	28
Add Physics Effector of Type Texture.....	28
Add Physics Effector of Type Turbulence.....	28
Add Physics Effector of Type Vortex.....	28
Add Physics Effector of Type Wind.....	28
Collection.....	28
Add Collection Instance.....	28
Toolbars Image.....	29
Available Toolbars.....	29
UV Mirror.....	29
UV Rotate.....	29
UV Align.....	29
Align Straighten.....	29
Align Straighten X.....	29
Align Straighten Y.....	29
Align Auto.....	29
Align X.....	29
Align Y.....	29
Align Rotation.....	30
UV Unwrap.....	30
Mark Seam.....	30
Clear Seam.....	30
Seams from Islands.....	30

Unwrap Angle Based.....	30
Unwrap Conformal.....	30
UV Modify UV.....	30
Pin.....	30
Unpin.....	30
Weld.....	30
Remove Doubles UV.....	30
Average Island Scale.....	30
Pack Island.....	31
Copy mirrored UV Coordinates.....	31
Toolbars Tools.....	31
Available Toolbars.....	31
Parent.....	31
Make Parent.....	31
Clear Parent.....	31
Object to Data.....	31
Make Single User.....	31
Link Data.....	32
Link to SCN.....	32
Link to SCN.....	32
Linked Objects.....	32
Make Local.....	32
Make Library Override.....	32
Join.....	32
Join.....	32
Origin.....	32
Set Geometry to Origin.....	32
Set Origin to Geometry.....	32
Set Origin to 3D cursor.....	32
Set Origin to Center of Mass.....	33
Set Origin to Center of Volume.....	33
Shading.....	33
Shade Smooth.....	33
Shade Flat.....	33
Autosmooth.....	33
Autosmooth angle.....	33
Add / Clear Custom Split Normals Data.....	33
Data Transfer.....	33
Transfer Mesh Data.....	33
Transfer Mesh Data Layout.....	33
Join UV's.....	33
Relations.....	34
Make Vertex Parent.....	34
Toolbars Animation.....	34
Available Toolbars.....	34
Keyframes.....	34
Insert Keyframe Menu.....	34
Delete Keyframe.....	34
Bake Action.....	35
Remove Animation.....	35
Calculate Object Paths.....	35
Clear Object Paths.....	35
Play.....	35

Jump to Endpoint.....	35
Jump to Keyframe.....	35
Play Animation.....	35
Play Animation.....	35
Jump to Keyframe.....	35
Jump to Endpoint.....	35
Current Frame.....	35
Range.....	35
Use Preview Range.....	36
Lock Frame Selection to Range.....	36
Frame Start.....	36
Frame End.....	36
Keying set.....	36
Insert Keyframe.....	36
Delete Keying set Keyframe.....	36
Use Keyframe Insert Auto.....	36
Keying set Drop down box.....	36
Sync.....	36
Keyframe Type.....	36
Toolbars Edit.....	37
Available Toolbars.....	37
Edit.....	37
Dissolve Vertices.....	37
Dissolve Edges.....	37
Dissolve Faces.....	37
Remove Doubles.....	37
Limited Dissolve.....	37
Dissolve Selection.....	37
Edge Collapse.....	37
Merge.....	38
Separate.....	38
Weight in Edit.....	38
Normalize all.....	38
Normalize.....	38
Mirror.....	38
Invert.....	38
Clean.....	38
Quantize.....	38
Levels.....	38
Smooth.....	38
Limit Total.....	38
Fix Deforms.....	39
Object Apply.....	39
Apply Location.....	39
Apply Rotation.....	39
Apply Scale.....	39
Apply All.....	39
Apply Rotation & Scale.....	39
Apply Visual Transform.....	39
Apply Make Duplicates real.....	39
Object Apply Deltas.....	39
Location.....	39
Rotation.....	39

Scale.....	39
All.....	40
Transforms to Delta Anims.....	40
Object Clear.....	40
Location.....	40
Rotation.....	40
Scale.....	40
Origin.....	40
Toolbars Misc.....	40
Available Toolbars.....	41
Viewport.....	41
Undo / Redo.....	41
Undo.....	41
Redo.....	41
Undo History.....	41
Undo History.....	41
Repeat.....	41
Repeat.....	41
Repeat History.....	41
Scene.....	41
View Layer.....	42
Adjust last Operation.....	42
Operatorsearch.....	42
Search Menu.....	42
Search Operator.....	42
Info.....	43

Introduction



The Toolbar editor is what you normally have to avoid in UI design. It's a bunch of double menu entries. It is made by lots of tools that already exists elsewhere.

But the value of this double menu here is that it is configurable. This customizable toolbar makes it possible to have the most needed tools at top UI level. This can save a ton of clicks, tabbing, scrolling, and digging in sub menus. And you can display what you need for your personal workflow. And hide away the rest.

The toolbar editor uses pure Icon buttons.

Parts of the toolbars are just visible when you are in the right mode. The full Primitives toolbar for example in just visible in Object mode. Parts of it are visible in Edit mode, dependent of what type of object you modify. And in the other modes the toolbars are hidden.

Parts of the toolbars are just visible when the right object type in the scene exists / is selected.

As told, the toolbars are double menu entries. This means the description of the tools in this chapter will be as short as possible. Closer descriptions, like how to use the tools, can be found in the other chapters where the tools comes from. The Tool Shelf in the 3D View for example.

Limits

- The toolbar does not contain all possible tools. More the opposite, the selection is very limited. Lots of tools depends to be performed in the editor type where you want to do the change. They just work there. And not in other editors. This affects for example most tools in edit mode. And the toolbar is another editor. This limits the available tools in the toolbar dramatically.
- The toolbars have a fixed order. The content is not sortable. The sorting is defined by the order of the toolbar type. And inside the toolbar type by the order in the toolbars menu. You would need to have to edit the python file to change this order.
- Just the toolbar types are independent. The check boxes to display the toolbars themselves are global. Means when you set one toolbar type to Primitives, and activate all the primitives types there, then other toolbars with this toolbar type will have the same primitives types displayed.

Menus

Toolbar Type menu

The first entry of a toolbar is the Toolbar Type menu.

Choose what kind of Toolbar Type you want to show. You can show multiple types of toolbars at once.

The toolbar types are independent from each other. You can set up every toolbar to display different content.

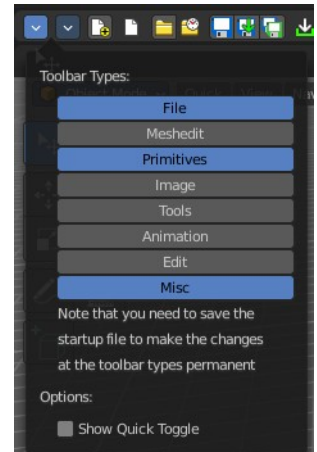

Toolbars Menus

Every toolbar type has several toolbars to display.

In the toolbar menu at the front of a toolbar type you can choose what toolbars you want to display.

The toolbars are not independent. This setup is global. When you for example tick the Toolbar File in this toolbar, then it will be displayed in all other toolbars too. Including in other layouts.

These check boxes are also available in the Toolbar Settings Bforartists add-on

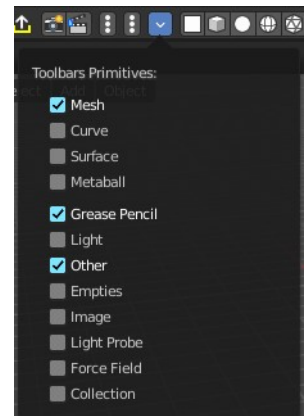

Toolbar Settings Bforartists add-on

The settings for the toolbar needs to be stored somewhere. This is done in an add-on called Toolbar Settings Bforartists.

This add-on contains the same check boxes than the single toolbars menus in the toolbar. But all of them at once.

Changing a setting here will automatically save the user preferences.

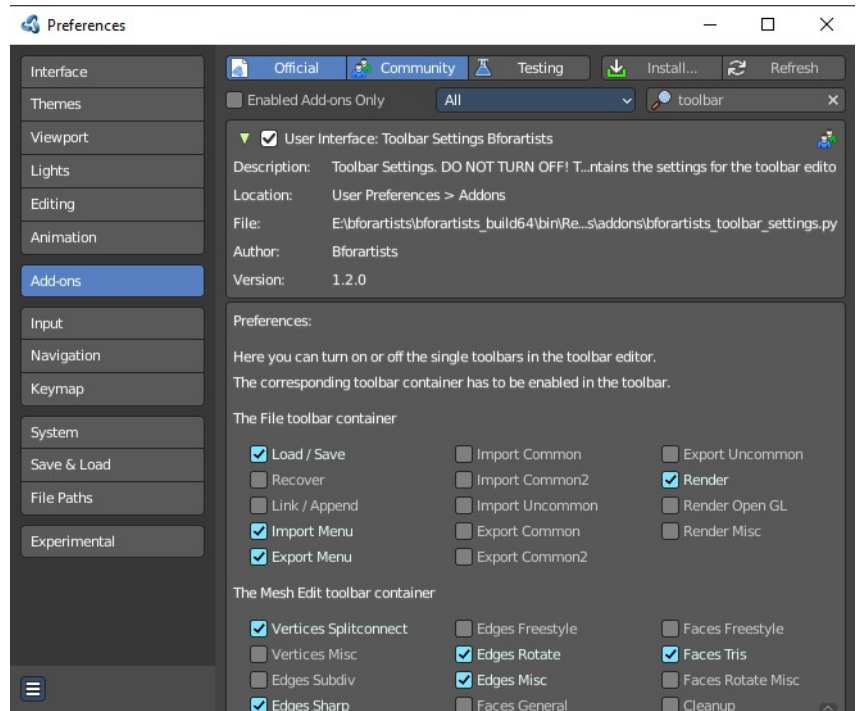

Warning!

Do not deactivate this add-on. The toolbar will not work then. It depends of the settings in the add-on!

Create new toolbar

You might want to create your own toolbar for a new layout. Let's explain the needed steps.

First create a new editor type. This can be done by dragging the triangle area of an existing editor. And will create a new editor.

Look at the right of this new created editor type. You will now see a small button. This is the Editor type menu. Open it by clicking at it. And choose Toolbar.

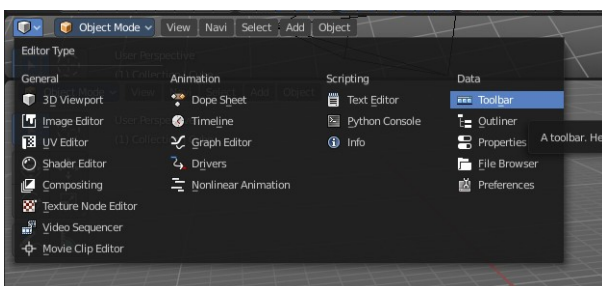
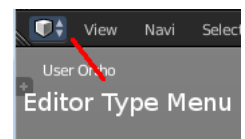
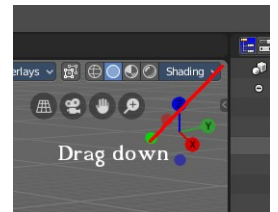

Now set up your new created Toolbar editor. Choose the toolbar types you want to display here. Then choose the toolbars to display.

The last step is to hide the Editor Type menu and to collapse the menus. Right click at the toolbar, and tick Collapse Menus and Hide Editortype menu.

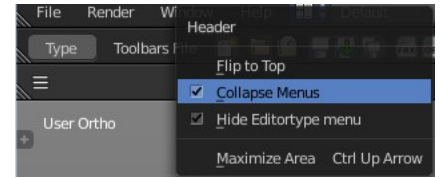

Save Toolbar state

Because of the autosave Preferences feature changes in the menus of the single toolbars are stored automatically.

When you activate for example the Curve toolbar in the Primitives, then the curve toolbar will stay activated when you close and open Bforartists.

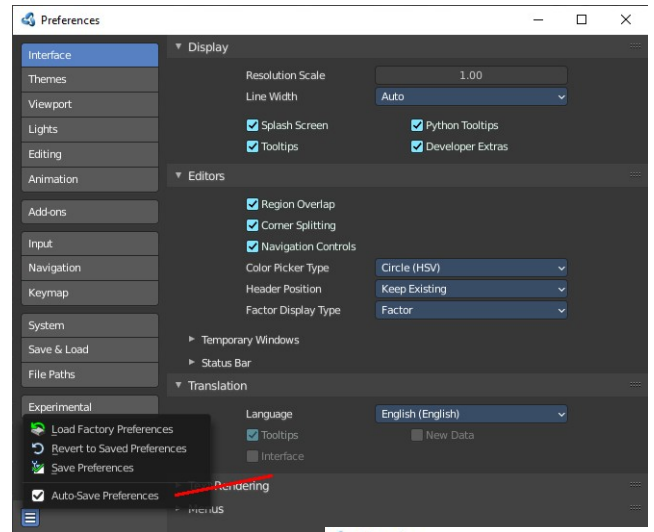

But the general setup of the toolbar type is layout. And so you have to save the startup file to make this changes permanent.

Be careful here. Saving the startup file saves every change at the layout. Including things like having a mesh in the scene.

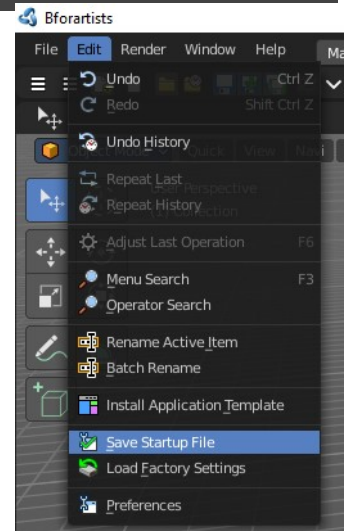

Toolbar Types

Currently the Toolbar editor contains eight toolbar types.

Toolbar Types

The single toolbar types.

Note that you need to save the startup file to make changes at the toolbar types permanent. They are part of the layout. Which was the only way to allow them to act independent from each other.

File - Contains some file menu related tools. Like load save. But also the render menu.

Mesh Edit - Contains tools for Meshes in Edit Mode.

Primitives - Contains the primitives from the Create tab in the Tool Shelf.

Image - Contains some tools for editing UV

Tools - Contains the content of the Relations panel in Object mode.

Animation - Contains Animation tools

Edit - Contains some tools from Object and Edit Mode

Misc - Contains Undo, and an empty menu as a place holder.

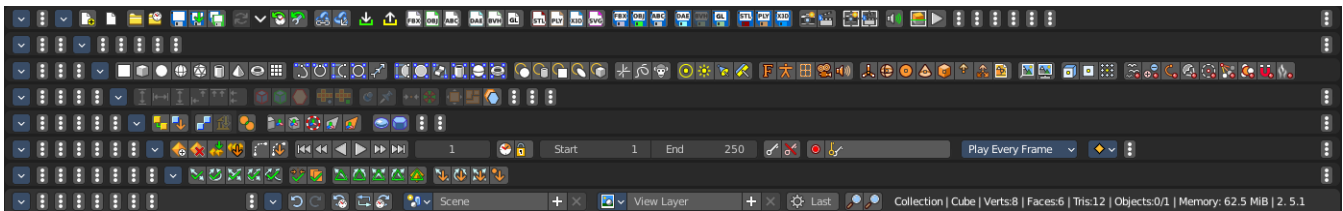
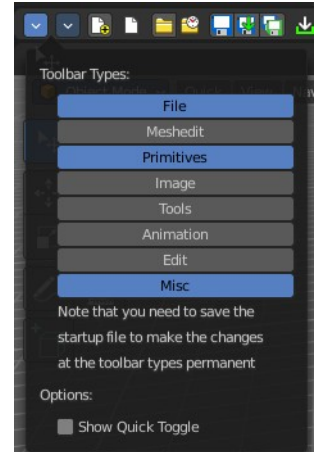

Options

Show Quick Toggle

By default you need to turn on or off the toolbar types in the toolbar type menu. Whith quick toggles turned on you will reveal small buttons besides the single toolbar types that allows you to expand or collapse the toolbar types from within the toolbar. Each quick toggle represents a toolbar type.



Toolbars File

The Toolbars File contains some file menu related tools. Like load save. But also the render menu.

These toolbars are available in all modes.

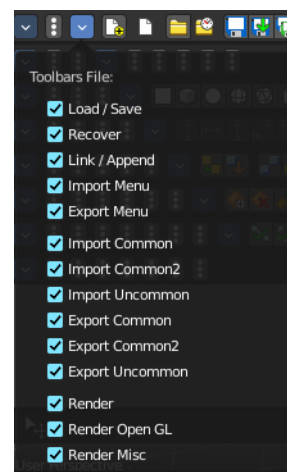

Available Toolbars

The description of the single buttons goes from left to right.

Load / Save

The original menu items are in the File menu of the Info editor.



File New

Creates a new scene, using the current template.

New from Template

Creates a new scene in one of the templates.

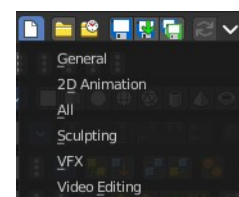

Open

Load a Blend file.

Open Recent

The recent files menu.

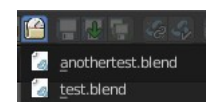

Save Blend File

Save a Blend file.

Save As Blend File

Save a Blend file as.

Save Copy

Saves a copy of the Blend file.

Recover

Revert

Reload the saved file.

Recover

Reload a startup file from one of the templates.

Recover Last Session

Open the last closed file, which is stored in the quit.blend.

Recover Autosave

Open an automatically saved file to recover it. Like after a crash. See Preferences , Save & Load , Autosave

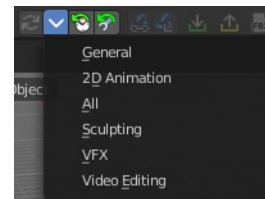

Link Append

The original menu items are in the File menu of the Info editor.



Link from Library

Link content from a Blend file

Append from Library

Append content

Import Menu

The Import menu is the same menu that you can find in the File menu of the Info editor. It contains all available file import types.

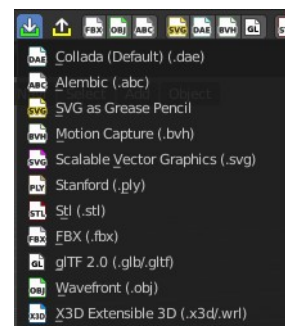

Export Menu

The Export menu is the same menu that you can find in the File menu of the Info editor.

It contains all available file export types.

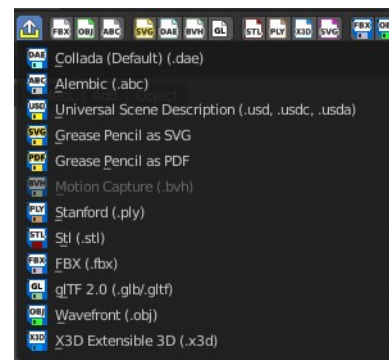

Import Common

The original menu items are in the File menu of the Info editor.



Import FBX

Import FBX files.

Import Obj

Import Object files.

Import ABC

Import Alembic files.

Import Common 2

The original menu items are in the File menu of the Info editor.



Import SVG into Grease Pencil

Import a svg file into a grease pencil object.

Import DAE

Import Collada files.

Import BVH

Import Biovision Motion Capture files.

Import glTF2

Import glTF2 files.

Import Uncommon

The original menu items are in the File menu of the Info editor.

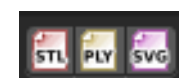

Import STL

Import STL files

Import PLY

Import PLY files.

Import SVG

Import SVG Files.

Export Common

The original menu items are in the File menu of the Info editor.



Export FBX

Export as FBX file.

Export Obj

Export as Obj file.

Export ABC

Export as Alembic file.

Export Common 2

The original menu items are in the File menu of the Info editor.



Export Grease Pencil to SVG

Exports a grease pencil object as an svg file.

Export Grease Pencil to PDF

Exports a grease pencil object as a PDF file.

Export DAE

Export as Collada file.

Export BVH

Export as BVH Motion Capture file.

Export USD

Export as USD file.

Export gITF2

Export as gITF2 file.

Export Uncommon



The original menu items are in the File menu of the Info editor.

Export 3DS

Export as 3DS.

Export PLY

Export as PLY file.

Render

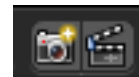

The original menu items are in the Render menu of the Info editor.

Render Image

Renders the current scene as an image by using the current offline renderer. Either Blender Internal or Cycles.

Render Animation

Renders the current scene as an animation. Either Blender Internal or Cycles.

Render Open GL

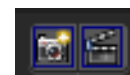

Open GL Render Image

Renders the current scene as an image by using the Viewport and Open GL.

Open GL Render Animation

Renders the current scene as an animation by using the Viewport and Open GL.

Render Misc

The original menu items are in the Render menu of the Info editor.



Mixdown Audio

Mixdown and export the scene's audio to an audio file.

Show/ Hide Render view

Toggles display of Render view.

Play rendered animation

Play rendered Animation sequence.

Toolbars Mesh Edit

The Toolbars Mesh Edit contains tools for Mesh Objects in Edit Mode. The original menu items are mainly in the Mesh menu in Edit Mode. In the Vertices, Edges and Faces sub menus.

This toolbars shows its content Edit mode.

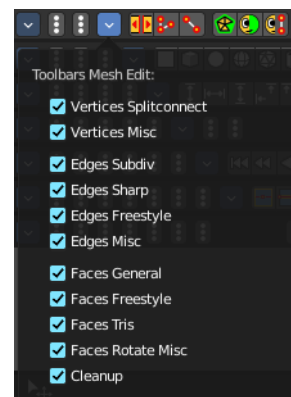

Available Toolbars

The description of the single buttons goes from left to right.

Vertices Split connect

Split

Splits two connected Vertices.

Vertex Connect Path

Connect Vertices by their selection order, creating edges, splitting faces

Vertex Connect

Connect selected vertices of faces, splitting the face.



Vertices Misc

Convex Hull

Enclose selected vertices in a convex polyhedron.



Blend from Shape

Blend in shape from a shape key.

Shape Propagate

Apply selected vertex locations to all other shape keys.

Edges Subdiv



Subdivide Edge Ring

Subdivides an Edge Ring.

Un-Subdivide

Unsubdivides selected edges and faces.

Edges Sharp

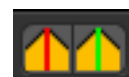

Mark Sharp

Mark selected edges as sharp.

Unmark Sharp

Unmark selected edges as sharp.

Edges Freestyle



Mark Freestyle Edge

Mark selected edges as Freestyle feature edges.

Unmark Freestyle Edge

Unmark selected edges as Freestyle feature edges.

Edges Rotate



Rotate

Rotate selected edges or adjoining faces.

Edges Misc



Edge Split

Split selected edges so that each neighbor face gets its own copy.

Bridge Edge loops

Create faces between selected edge loops.

Faces general



Fill

Fill a selected edge loop with faces.

Grid Fill

Fill grid from two loops.

Beautify Faces

Rearrange some faces to minimize degeneration.

Solidify

Create a solid skin by extruding. Compensating for sharp angles.

Intersect

Cut an intersection into faces.

Boolean Intersect

Cut solid geometry from selected to unselected.

Wire Frame

Create a solid wire frame from faces.

Faces Freestyle



Mark Freestyle Face

Mark selected faces for exclusion from freestyle feature edge detection.

Unmark Freestyle Face

Unmark selected faces for exclusion from freestyle feature edge detection.

Faces Tris



Poke Faces

Split a face into a fan.

Triangulate Faces

Triangulates selected faces.

Tris to Quads

Join triangle faces into quads.

Split by Edges

Split faces by loose edges.

Faces Rotate Misc



Rotate UV's

Rotate UV coordinates inside faces.

Reverse UV's

Flip direction of UV coordinates inside faces.

Rotate Colors

Rotate Vertex Colors inside faces.

Reverse Colors

Flip direction of Vertex Colors inside faces.

Cleanup



Delete Loose

Delete loose vertices, edges or faces.

Decimate Geometry

Simplify geometry by collapsing edges.

Degenerate Dissolve

Dissolve zero area faces and zero length edges.

Make Planar Faces

Flatten selected faces.

Split Non Planar Faces

Split non planar faces that exceeds the angle threshold.

Split Concave Faces

Make all faces convex.

Fill Holes

Fill in holes (boundary edge loops).

Toolbars Primitives

The toolbars Primitives contains the Add items from the Create tab.

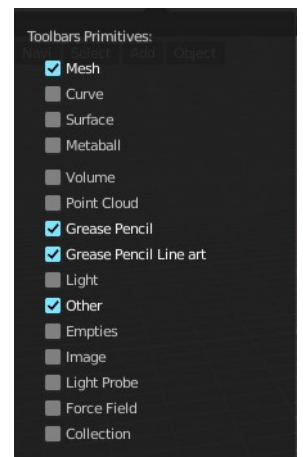
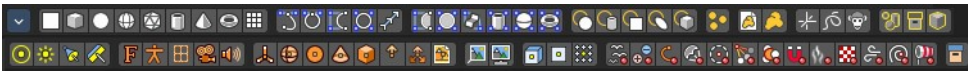

The full toolbar with all its content is just available in Object mode. In other modes it hides away. Single types are also visible in Edit mode. When you work at a mesh type, then the Mesh primitives toolbar is visible for example.

Available Toolbars

The description of the single buttons goes from left to right.

Mesh



The Mesh toolbar contains the Mesh primitives.

Add Plane

Add a Plane primitive.

Add Cube

Add a Cube primitive.

Add Circle

Add a Circle primitive.

Add UV Sphere

Add a UV Sphere primitive.

Add Cylinder

Add a Cylinder primitive.

Add Cone

Add a Cone primitive.

Add Torus

Add a Torus primitive.

Add Grid

Add a Grid primitive.

Curve

The Curve toolbar contains the Curve primitives.



Add Bezier

Add a Bezier curve primitive.

Add Circle

Add a Circle curve primitive.

Add Nurbs Curve

Add a Nurbs Curve primitive.

Add Nurbs Circle

Add a Nurbs Circle curve primitive.

Add Nurbs Path

Add a Nurbs Path curve primitive.

Surface

The Surface toolbar contains the Surface primitives.



Add Surface Curve

Add a Nurbs Surface curve primitive.

Add Surface Circle

Add a Nurbs Surface Circle primitive.

Add Surface Patch

Add a Nurbs Surface Patch primitive.

Add Surface Cylinder

Add a Nurbs Surface Cylinder primitive.

Add Surface Sphere

Add a Nurbs Surface Sphere primitive.

Add Surface Torus

Add a Nurbs Surface Torus primitive.

Metaball



The metaball toolbar contains the Metaball primitives.

Add Metaball of type Ball

Add Metaball of type Ball primitive.

Add Metaball of type Capsule

Add Metaball of type Capsule primitive.

Add Metaball of type Plane

Add Metaball of type Plane primitive.

Add Metaball of type Ellipsoid

Add Metaball of type Ellipsoid primitive.

Add Metaball of type Cube

Add Metaball of type Cube primitive.

Point Cloud



The Point Cloud toolbar contains the Point Cloud primitive.

Add Point Cloud

Add a point cloud primitive.

Volume

The Volume toolbar contains the Volume primitives.



Import OpenVDB Volume

Imports a OpenVDP volume object.

Add Volume

Adds a volume object.

Grease Pencil



Blank

Inserts a blank Grease Pencil Object. A blank Grease Pencil Object has just one color

Stroke

Inserts a Stroke Grease Pencil Object. A Stroke Grease Pencil Object has a few standard colors already.

Monkey

Inserts a Monkey Grease Pencil Object. This is a grease pencil object which contains the shape of a monkey already. This monkey is an example object.

Scene Line Art

Line Art is a modifier for the grease pencil object. Scene Line Art adds a grease pencil object with the Line Art Modifier set up for the whole scene.

Collection Line Art

Line Art is a modifier for the grease pencil object. Scene Line Art adds a grease pencil object with the Line Art Modifier set up for a collection.

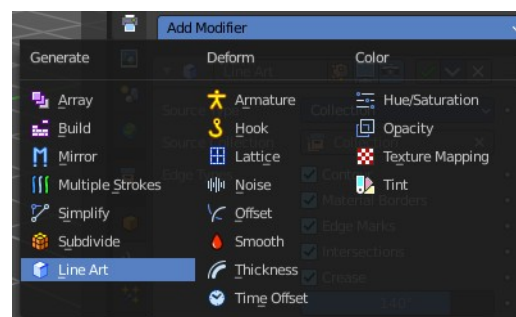

Lamp

The Lamp toolbar contains the different lamp types.



Add Lamp of type Point

Add Lamp of type Point.

Add Lamp of type Sun

Add Lamp of type Sun.

Add Lamp of type Spot

Add Lamp of type Spot.

Add Lamp of type Area

Add Lamp of type Area.

Other

The Other toolbar contains some other ground types like bones and text.



Add Text

Add a Text object.

Add Armature

Add an Armature object.

Add Lattice

Add a Lattice object.

Add Camera

Add a Camera object.

Add Speaker

Add a Speaker object.

Empties

The Empties toolbar contains the available empty types.



Add Empty of type Plain Axes

Add Empty of type Plain Axes.

Add Empty of type Sphere

Add Empty of type Sphere.

Add Empty of type Circle

Add Empty of type Circle.

Add Empty of type Cone

Add Empty of type Cone.

Add Empty of type Cube

Add Empty of type Cube.

Add Empty of type Single Arrow

Add Empty of type Single Arrow.

Add Empty of type Arrows

Add Empty of type Arrows.

Add Empty of type Image

Add Empty of type Image.

Image



Reference Image

Creates a plane with an image that can be used as a reference image.

Background Image

Creates a plane with an image that can be used as a Background image.

Light Probe



Reflection Cubemap

Creates a light probe with a reflection cubemap.

Reflection Plane

Creates a light probe with a reflection plane.

Irradiance Volume

Creates a light probe with Irradiance Volume.

Force Field

The Force Field toolbar contains the available Force field types.



Add Physics Effector of Type Boid

Add Physics Effector of Type Boid.

Add Physics Effector of Type Charge

Add Physics Effector of Type Charge.

Add Physics Effector of Type Curve Guide

Add Physics Effector of Type Curve Guide.

Add Physics Effector of Type Drag

Add Physics Effector of Type Drag.

Add Physics Effector of Type Force

Add Physics Effector of Type Force.

Add Physics Effector of Type Harmonic

Add Physics Effector of Type Harmonic.

Add Physics Effector of Type Lenard-Jones

Add Physics Effector of Type Lenard-Jones.

Add Physics Effector of Type Magnetic

Add Physics Effector of Type Magnetic.

Add Physics Effector of Type Smoke Flow

Add Physics Effector of Type Smoke Flow.

Add Physics Effector of Type Texture

Add Physics Effector of Type Texture.

Add Physics Effector of Type Turbulence

Add Physics Effector of Type Turbulence.

Add Physics Effector of Type Vortex

Add Physics Effector of Type Vortex.

Add Physics Effector of Type Wind

Add Physics Effector of Type Wind.

Collection

Add Collection Instance

Add a collection instance.

Toolbars Image

The toolbars Image contains some image related tools.

At the moment this toolbar contains just tools to edit

UV meshes. This means that you have to be in Edit mode with an UV mapped mesh to make the tools active.

The original menu items are in the Image menu of the UV Image Editor.

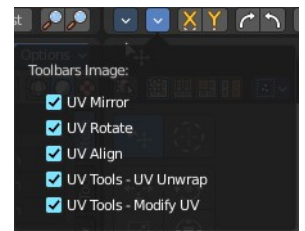

Available Toolbars

The description of the single buttons goes from left to right.

UV Mirror

Mirror along X or Y axis.



UV Rotate

Rotate by 90 degrees clockwise or counter clockwise.



UV Align

The UV Align toolbar contains tools to clean up and align the selected UV geometry.



Align Straighten

Align UV's along the line defined by the end points of the selection.

Align Straighten X

Align UV's along the line defined by the end points along the X axis.

Align Straighten Y

Align UV's along the line defined by the end points along the Y axis.

Align Auto

Automatically choose the axis on which there is most alignment already.

Align X

Align UV's at X axis.

Align Y

Align UV's at Y axis.

Align Rotation

Aligns the rotation of the selected geometry.

UV Unwrap

The UV Common toolbar contains tools for unwrapping.



Mark Seam

Mark selected UV Edges as Seam.

Clear Seam

Remove Seam from selected UV Edges.

Seams from Islands

Marks the border edges of the UV patches as Seam.

Unwrap Angle Based

Unwraps the selected geometry with the Angle based (ABF) method.

Unwrap Conformal

Unwraps the selected geometry with the Conformal (LSCM) method.

UV Modify UV

The UV Modify toolbar contains tools to clean up the UV mapping.



Pin

Pins the selected vertices.

Unpin

Unpins the selected vertices.

Weld

Weld the selected UV vertices together.

Remove Doubles UV

Removes double vertices

Average Island Scale

Average the size of separated UV patches, based at their size in 3D space.

Pack Island

Packs the UV patches so that they fit best into the UV space, and as few texture space as possible is wasted.

Copy mirrored UV Coordinates

Copy mirrored UV Coordinates at X axis based on a mirrored mesh.

Toolbars Tools

The Toolbars Tools contains some tools in object mode. The content from the relations panel and the edit panel in the tool shelf. And one tool in Edit mode. Make Vertex Parent. Since this is also part of the relations panel.

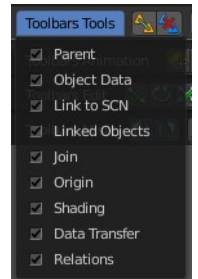

Available Toolbars

The description of the single buttons goes from left to right.

Parent



Make Parent

Parents the selected object to the active object.

Clear Parent

Removes the parenting.

Object to Data



Make Single User

Make linked data local to each object. This operator opens a popup to adjust further settings.

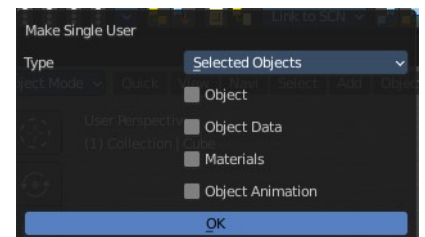

Link Data

Apply active object links to other selected objects.

This button is a menu to choose the link method.

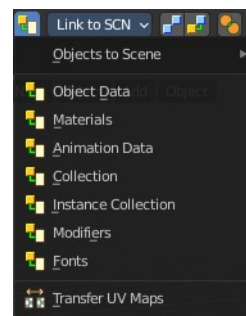

Link to SCN

Link to SCN

Link selection to another scene. This other scene has of course to exist.

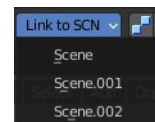

Linked Objects

Make Local

Make library linked data blocks local to this file.

Make Library Override

Add empty object to become local replacement data of a library linked object.



Join

Join

Join selected objects into active objects.



Origin

Set Geometry to Origin

Sets the geometry to origin.

Set Origin to Geometry

Sets the origin to geometry.

Set Origin to 3D cursor

Sets the origin to the 3D cursor.



Set Origin to Center of Mass

Sets the origin to the center of mass.

Set Origin to Center of Volume

Sets the origin to the center of volume.

Shading



Shade Smooth

Shades the geometry smooth.

Shade Flat

Shades the geometry flat.

Autosmooth

Activate auto smooth, and define the angle.

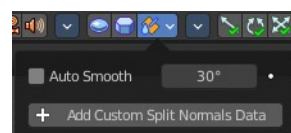

Autosmooth angle

The threshold angle. This angle is just available when there is no custom normals at the mesh.

When your mesh has custom normals then the option is greyed out. And a info text appears why it is greyed out. This can already happen when you import a mesh with normals.

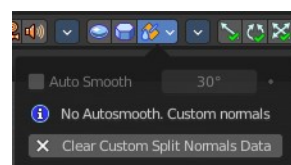

Note that you can still tick and untick the checkbox. It just has no effect anymore.

Add / Clear Custom Split Normals Data

Adds a custom split normals data layer, if none exists yet. In case custom normals exists at the mesh, for example because you have marked an edge sharp, then you can remove it here.

Data Transfer



Transfer Mesh Data

Transfers mesh data.

Transfer Mesh Data Layout

Transfers the mesh data layout.

Join UV's

Transfer UV Maps.

Relations

The Relations toolbar contains one tool in Edit mode. Make Vertex Parent.



Make Vertex Parent

Parents an object to the selected vertice(s).

Toolbars Animation

The Toolbars Animation contains tools around animation. The Toolbars Range, Play, Sync and Keying set are the toolbars from the Timeline. But separated into four independent parts.

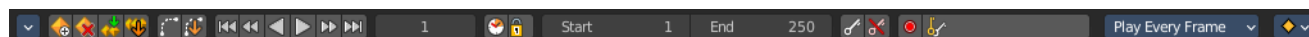
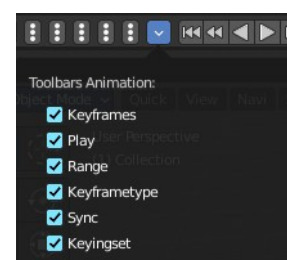

Available Toolbars

The description of the single buttons goes from left to right.

Keyframes

The Keyframes toolbar contains some keyframe tools. The original menu items can be found in the Tool Shelf in the Animation tab in the Animation panel.



The original menu items are in the Tool Shelf in the 3D View, in the Animation tab in the Animation panel.

Insert Keyframe Menu

When there is no keying set assigned to the currently selected object, then this button is a menu to choose a keying set. When there is already a keying set assigned, then you can record a keyframe with this button

Delete Keyframe

Deletes the current Keyframe

Bake Action

Bakes the animation to a new action

Remove Animation

Remove all keyframe animation for selected objects

Calculate Object Paths

Calculate motion paths for the selected objects.

Clear Object Paths

Clears motion paths for the selected objects.

Play



Jump to Endpoint

Jumps to beginning of animation.

Jump to Keyframe

Jumps to the previous keyframe Play Animation.

Play Animation

Plays animation reversed.

Play Animation

Plays animation forward.

Jump to Keyframe

Jumps to next keyframe.

Jump to Endpoint

Jumps to end of animation.

Current Frame

The current frame number.

Range



Use Preview Range

Use an alternative start/end frame grange for animation playback and OpenGL renders instead of the Render Properties start/end frame range.

Lock Frame Selection to Range

Don't allow frame to be selected with mouse outside of frame range.

Frame Start

The frame start point.

Frame End

The frame end point.

Keying set

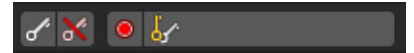

Insert Keyframe

Insert a keyframe.

Delete Keying set Keyframe

Delete Keyframe.

Use Keyframe Insert Auto

Auto insert keyframes at manipulation.

Keying set Drop down box

This is a drop down box to choose the keying set method.

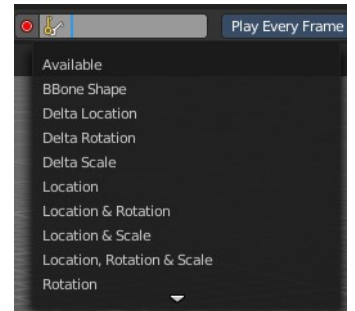

Sync

Sync is a drop down box where you can adjust the syncing method.

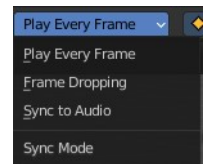

Keyframe Type

Keyframe Type is a drop down box to choose in what color the keyframe gets displayed in the Dope Sheet Editor.

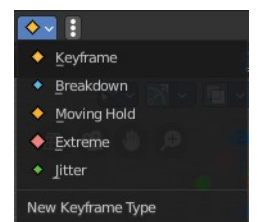

Toolbars Edit

The Toolbars Edit contains various toolbars around editing. Some content just shows when an object exists in the scene. Some content is visible in Object mode. Some content is visible in Edit mode.

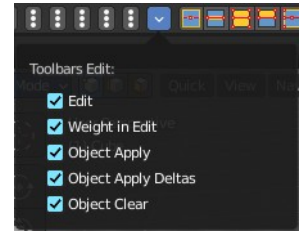
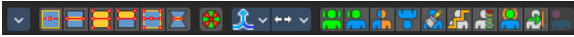

Available Toolbars

The description of the single buttons goes from left to right.

Edit

The Edit toolbar is just visible in Edit Mode. The original menu items are in the Tool Shelf in the 3D View in the Tools tab in the Mesh Tools panel.



Dissolve Vertices

Dissolve Vertices.

Dissolve Edges

Dissolve Edges.

Dissolve Faces

Dissolve Faces.

Remove Doubles

Removes double vertices.

Limited Dissolve

Dissolve Edges and Vertices limited by the surrounding angle.

Dissolve Selection

Dissolve Geometry dependent of selection mode.

Edge Collapse

Collapse selected edges.

Merge

Merges selected geometry. This is a drop down box to choose where to merge.

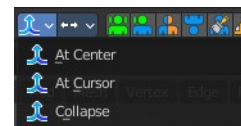

Separate

Separate the selection, and create a new object from it. This is a drop down box to choose the separate method.

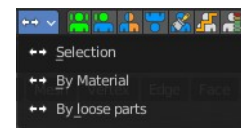

Weight in Edit



The Weight in Edit toolbar is just visible in Edit Mode for normal meshes, and Pose mode when you have a rigged character selected. The original menu items are in the Tool Shelf in the 3D View in the Tools tab in the Weight Tools panel. You need to have a Vertex Group applied.

Normalize all

Normalizes the whole mesh.

Normalize

Normalizes the selection

Mirror

Mirrors the selection.

Invert

Inverts the weighting.

Clean

Remove Vertex Assignments that are not required.

Quantize

Set Weights to a fixed number of steps.

Levels

Add some offset and multiply with some gain the weights of the active vertex group.

Smooth

Smooth weights for selected vertices.

Limit Total

Limit deform weights.

Object Apply

The Object Apply toolbar is just visible in Object Mode. The original menu items are in the Object menu in the 3D View. The Apply menu.



Apply Location

Apply location.

Apply Rotation

Apply Rotation.

Apply Scale

Apply Scale.

Apply All

Apply Location, Rotation, Scale.

Apply Rotation & Scale

Apply Rotation, Scale.

Apply Visual Transform

Apply Visual Transform.

Apply Make Duplicates real

Make Duplicates attached to this object real.

Object Apply Deltas

Object Apply deltas converts normal object transforms to delta transforms. Any existing delta transform will also be included.

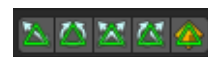

Location

Apply location.

Rotation

Apply Rotation.

Scale

Apply Scale.

All

Apply Location, Rotation, Scale.

Transforms to Delta Anims

Convert object animation for normal transforms to delta transforms.

Object Clear



The Object Clear toolbar is just visible in Object Mode. The original menu items are in the Object menu in the 3D View. The Clear menu.

Location

Resets the position of the object to zero.

Rotation

Resets the object's rotation to zero.

Scale

Resets the object's scale to 1.

Origin

Resets the Origin Position.

Toolbars Misc

The Toolbars Misc contains some miscellaneous tools. Undo, the Scene drop down box, Last Operator, Operator Search and scene informations.

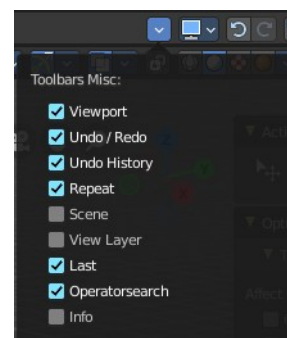

Available Toolbars

The description of the single buttons goes from left to right.

Viewport

Displays the viewport panel from the object properties tab in the properties editor.

This panel allows you to adjust the display of the selected object.

Note that you need to have an object selected to show this dropdown panel.

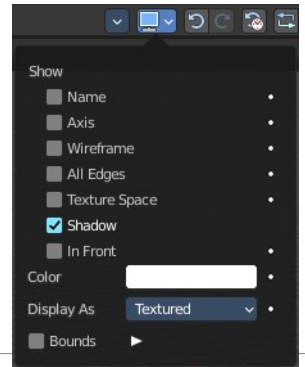

Undo / Redo



Undo

Undo the last step

Redo

Redo the last undone step

Undo History

Undo History

A click at at the button reveals a list of the last operations where you can undo more than one step.

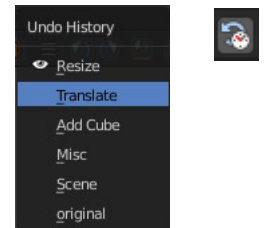

Repeat



Repeat

Repeats the last action

Repeat History

A click at at the button reveals a list of the last operations to choose from which undo step to repeat.

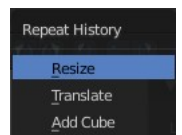

Scene

The Scene drop down box to choose and create a new scene data block. The original drop down box is in the Properties editor in the Scene Properties tab in the Scene panel.



View Layer

Show the active view layer and switch between available view layers.



The original drop down box is in the Properties editor in the View Layer Properties in the View Layer panel.

Adjust last Operation

Adjust the latest operation. This is the same panel than the one in the 3D view down left. At least when it comes to content.

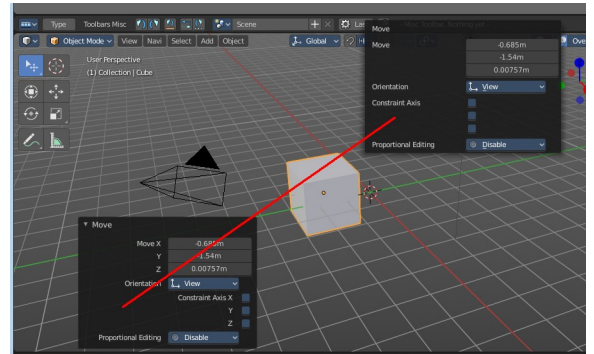

Operatorsearch

This toolbar contains two search options. The search menu allows you to search for menus. The operator search menu allows you to search for single operators.



Search Menu

The original menu item is in the header in the Edit menu. It lists the available menus, and allows searching.

This button calls the menu search menu.

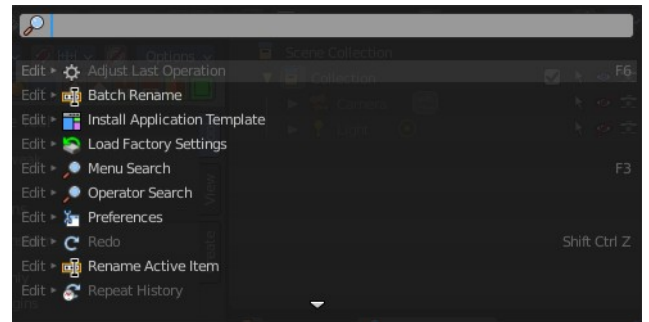

Search Operator

The original menu item is in the header in the Edit menu.

This button calls the Operator search menu. It lists the available operators, and allows searching.

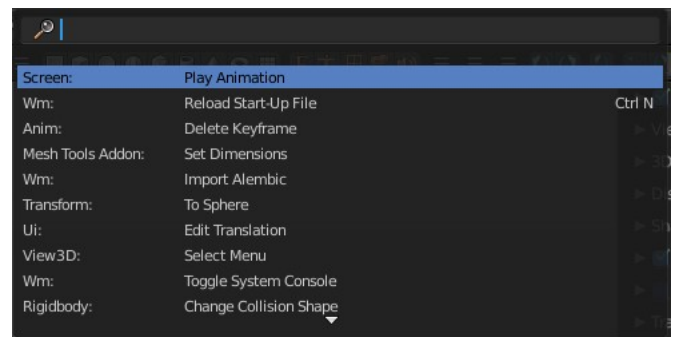

Info

The Info toolbar displays the scene statistics.

Collection | Cube | Verts:8 | Faces:6 | Tris:12 | Objects:1/1 | Memory: 16.0 MiB | 2.92.0 Alpha



25 Editors - Outliner

Table of content

Detailed table of content.....	2
Outliner.....	7
General hotkey functionality.....	7
Extended Functionality.....	7
Collections.....	8
Header - All Modes.....	8
Switch to Properties Editor / Outliner.....	8
Display Mode.....	8
View Menu.....	8
Search Field.....	10
Right Click Menus.....	10
Outliner Scene Operation.....	10
Outliner Data Operation.....	11
Collection.....	12
Object Menu.....	17
Outliner ID Data Operation.....	19
Outliner Animation Data Property.....	20
Level Restrictions.....	21
Scenes Mode.....	21
Collection Menu.....	21
Remove From Collection.....	22
Remove From all Unlinked Collections.....	22
Add selected To Active Collection.....	22
Remove Selected From Active Collection.....	22
Add Collection.....	23
New Scene.....	23
Filter.....	23
View Layer Mode.....	24
Collection Menu.....	24
Remove From Collection.....	25
Remove From all Unlinked Collections.....	25
Add selected To Active Collection.....	25
Remove Selected From Active Collection.....	25
Add Collection.....	25
Filter.....	26
Sequence Mode.....	27
Sync Outliner Selection.....	27
Blender File Mode.....	28
Filter.....	28
Outliner Library Operation.....	28
Data API Mode.....	29
Header tools.....	29
Library Override Mode.....	30
Library Override View Mode.....	30
Filter options.....	30
Filter.....	31
Orphan Mode.....	31

Clean Up.....	31
Filter.....	32
Status column.....	32
Hotkey only functionality.....	32
Insert Keyframe - I.....	33
Delete Keying Set Keyframe - Alt I.....	33
Hide - H.....	33
Unhide - Alt H.....	33

Detailed table of content

Detailed table of content

Detailed table of content.....	2
Outliner.....	7
General hotkey functionality.....	7
Extended Functionality.....	7
Collections.....	8
Header - All Modes.....	8
Switch to Properties Editor / Outliner.....	8
Display Mode.....	8
View Menu.....	8
Show Active.....	8
Show One Level.....	9
Hide One Level.....	9
Expand / Collapse All.....	9
Show Hierarchy.....	9
Box Select.....	9
Select All.....	9
Deselect All.....	9
Invert Selection.....	9
Pie menus.....	9
Area.....	9
Horizontal Split.....	9
Vertical Split.....	9
Duplicate Area into new Window.....	9
Toggle Maximize Area.....	10
Toggle Fullscreen Area.....	10
Close Area.....	10
Search Field.....	10
Right Click Menus.....	10
Outliner Scene Operation.....	10
Delete.....	10
Copy Settings.....	10
Linked Copy.....	10
Full Copy.....	11
Mark as Asset, Clear Asset, Clear Asset (Set Fake User).....	11
Outliner Data Operation.....	11
Select.....	11
Deselect.....	11
Hide.....	11

Unhide.....	11
Select Linked.....	11
Mark as Asset, Clear Asset, Clear Asset (Set Fake User).....	11
Collection.....	12
New Nested.....	12
New.....	12
Duplicate Collection.....	12
Duplicate Linked.....	12
Copy.....	12
Paste.....	12
Delete.....	12
Delete Hierarchy.....	12
Select Objects.....	12
Deselect Objects.....	12
Instance to Scene.....	12
Unlink.....	13
Visibility.....	13
Isolate.....	13
Show All Inside.....	13
Hide.....	13
Set Color Tag.....	13
ID Data.....	13
Unlink.....	14
Make Local.....	14
Add Library Override.....	14
Make Single User.....	14
Delete.....	14
Remap Users.....	14
Copy.....	14
Paste.....	14
Make Library Override Editable.....	14
Make Library Override Hierarchy.....	14
Reset Library Override.....	15
Reset Library Override Hierarchy.....	15
Resync Library Override Hierarchy.....	15
Resync Library Override Hierarchy Enforce.....	15
Delete Library Override Hierarchy.....	15
Clear Single Library Override.....	15
Copy.....	15
Paste.....	15
Add Fake User.....	15
Clear Fake User.....	15
Rename.....	15
Select Linked.....	15
Make Library Override.....	16
Selected.....	16
Content.....	16
Selected & Content.....	16
Reset Library Override.....	16
Selected.....	16
Content.....	16
Selected & Content.....	16
Clear Library Override.....	16

Selected.....	16
Content.....	16
Selected & Content.....	16
Troubleshoot Library Override.....	17
Resync.....	17
Resync Enforce.....	17
Delete.....	17
Mark as Asset.....	17
Clear Asset.....	17
Clear Asset (Set Fake User).....	17
Object Menu.....	17
Select.....	17
Select Hierarchy.....	17
Deselect.....	17
Copy.....	17
Paste.....	17
Delete.....	18
Delete Hierarchy.....	18
Unlink.....	18
ID Data.....	18
Unlink.....	18
Make Local.....	18
Make Single User.....	18
Delete.....	18
Remap Users.....	18
Copy.....	18
Paste.....	18
Add Fake User.....	18
Clear Fake User.....	19
Rename.....	19
Select Linked.....	19
Outliner ID Data Operation.....	19
Unlink.....	19
Make Local.....	19
Delete.....	19
Remap Users.....	19
Copy.....	19
Paste.....	19
Add Fake User.....	19
Clear Fake User.....	20
Rename.....	20
Select Linked.....	20
Mark as Asset.....	20
Clear Asset.....	20
Clear Asset (Set Fake User).....	20
Outliner Animation Data Property.....	20
Clear Animation Data.....	20
Set Action.....	20
Unlink Action.....	20
Refresh Drivers.....	20
Clear Drivers.....	20
Level Restrictions.....	21
Selectability.....	21

Hide from Viewport.....	21
Hide from Render.....	21
Scenes Mode.....	21
Collection Menu.....	21
Move to Collection.....	21
Last Operator Move to Collection.....	22
Name.....	22
Link to Collection.....	22
Last Operator Link to Collection.....	22
Name.....	22
Remove From Collection.....	22
Remove From all Unlinked Collections.....	22
Add selected To Active Collection.....	22
Remove Selected From Active Collection.....	22
Add Collection.....	23
New Scene.....	23
New.....	23
Copy Settings.....	23
Linked Copy.....	23
Full Copy.....	23
Filter.....	23
Restriction Toggles.....	23
Sort Alphabetically.....	23
Sync Selection.....	23
Show Mode Column.....	24
Search.....	24
Exact Match Search.....	24
Case Sensitive Search.....	24
View Layer Mode.....	24
Collection Menu.....	24
Move to Collection.....	24
Link to Collection.....	25
Remove From Collection.....	25
Remove From all Unlinked Collections.....	25
Add selected To Active Collection.....	25
Remove Selected From Active Collection.....	25
Add Collection.....	25
Filter.....	26
Restriction Toggles.....	26
Exclude from View Layer.....	26
Selectable.....	26
Hide in Viewport.....	26
Disable in Viewport.....	26
Disable in Renders.....	26
Holdout.....	26
Indirect only.....	26
Sort Alphabetically.....	26
Sync Selection.....	26
Show Mode Column.....	27
Search.....	27
Exact Match Search.....	27
Case Sensitive Search.....	27
Filter.....	27

Object State Filter.....	27
Invert.....	27
Sequence Mode.....	27
Sync Outliner Selection.....	27
Blender File Mode.....	28
Filter.....	28
Filter ID Type.....	28
Outliner Library Operation.....	28
Delete.....	28
Relocate.....	28
Reload.....	28
Data API Mode.....	29
Header tools.....	29
Edit Menu.....	29
Keying Set Add Selected.....	29
Keying Set Remove Selected.....	29
Add Drivers to Selected.....	29
Delete Drivers for Selected.....	29
Set Keying set.....	29
Add keyframe.....	29
Remove keyframe.....	29
Library Override Mode.....	30
Library Override View Mode.....	30
Properties.....	30
Hierarchies.....	30
Filter options.....	30
Sort alphabetically.....	30
Search.....	30
Exact match.....	30
Case sensitive.....	30
Filter.....	31
Filter ID Type.....	31
Orphan Mode.....	31
Clean Up.....	31
Clean Up menu.....	31
Unused Data.....	31
Recursive Unused Data.....	31
Unused Linked Data.....	32
Recursive Unused Linked Data.....	32
Unused Local Data.....	32
Recursive Unused Local Data.....	32
Filter.....	32
Filter ID Type.....	32
Status column.....	32
Hotkey only functionality.....	32
Insert Keyframe - I.....	33
Delete Keying Set Keyframe - Alt I.....	33
Hide - H.....	33
Unhide - Alt H.....	33

Outliner

The Outliner is an editor where you can organize the data in your scene. It is in the View Layer mode basically a list of the available objects and data in the scene, which is organized in so called collections. Think of it as a container that carries the scene data. This also includes things like brushes, textures and materials.

The outliner not only lists the data. But you can modify the data in various ways. And it has more than one mode. We will go through them, one by one.

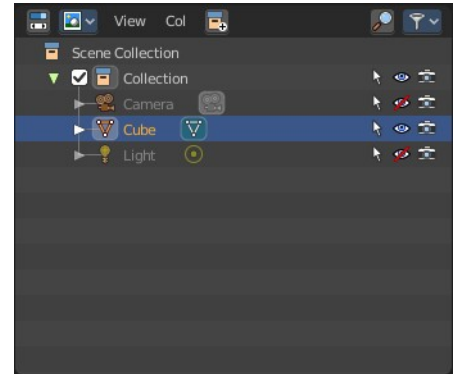

The outliner has some context menus that are available by a right click at an element. We will also cover them, one by one.

General hotkey functionality

There is some general hotkey functionality that works across the whole interface. And so it works in the outliner too.

Left click at an object selects it. When you select an object in the outliner, then it is also selected in the scene.

Dragging the mouse with left click box selects.

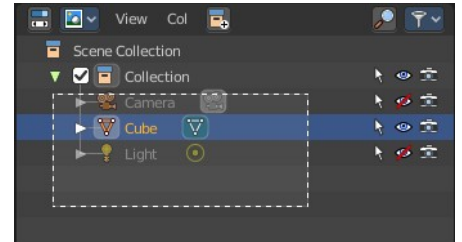

Like in the 3D view, Shift + LMB adds to the selection, or can remove the clicked object from the selection.

Ctrl+LMB enters the rename mode for the object. You can also double click at it. In both cases the text becomes editable.



You can drag objects into the hierarchy of other objects, and make them a child object by that.

You can navigate with the arrow buttons. Holding shift while navigating with the arrow buttons will extend the selection.

Delete hotkey deletes the selected items. Also selected collections.

Extended Functionality

The outliner has some extended functionality in some modes.

Objects with an arrow sign at the left are hierarchical objects. Hierarchy

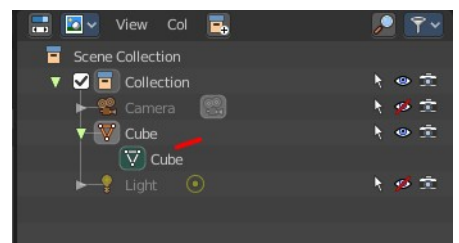

can be expanded and collapsed by clicking at the + and - signs.

When you click at a data block of some object types object, like the mesh component for a mesh or a curve object, then you will jump from object mode into edit mode. And vice versa.

Collections

Collections are containers that can contain objects or anything else in the scene. They can also include collections, and are fully recursive.

Header - All Modes

The header content changes, dependent of the display mode. Here we list the elements that are available in all display modes.

Switch to Properties Editor / Outliner

Sometimes you want to switch from Outliner to the Properties Editor, or vice versa. Since you sometimes don't have enough space for both, and end in dragging the borders of the editors around all the time. This two editors are connected by a menu that allows exactly that. A button in each header that switches to the other editor.

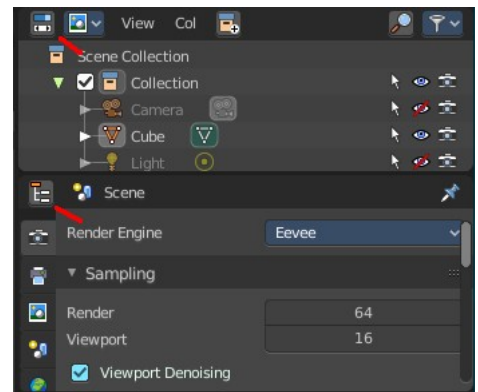

Display Mode

The Outliner has more than one purpose and workspace. In this drop down menu you can switch to different display modes. The available Modes are Scenes, View Layer, Sequence, Blender File, Data API and Orphan Data. We will cover their functionality in their own chapters.

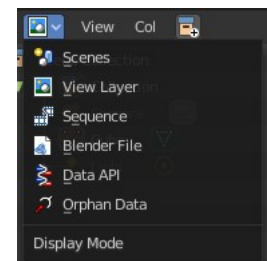

View Menu

The View menu contains general view related functionality.

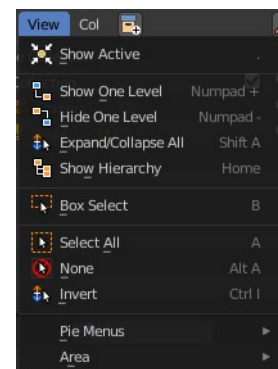

Show Active

Centers the view of the list to the active object.

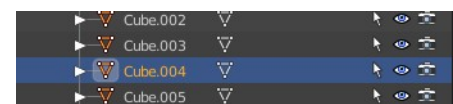

Show One Level

Expands the list hierarchy level by one.

Hide One Level

Collapses the list hierarchy level by one.

Expand / Collapse All

Expands or collapses all collapsed hierarchy. It's a toggle

Show Hierarchy

Open all object entries and close all others. For example, when you are in Scene view, and have the objects expanded, then the Show Hierarchy closes the objects hierarchy.

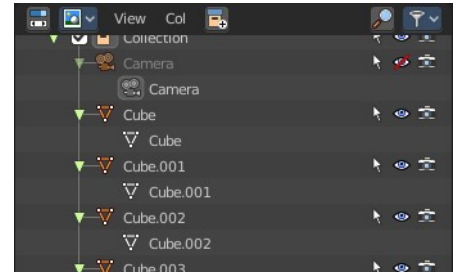

Box Select

Box select items in the list.

Select All

Select all items in the list.

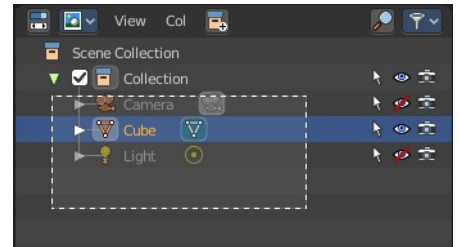

Deselect All

Deselect all items in the list.

Invert Selection

Inverts the selection. Unselected list items becomes selected, selected list items becomes unselected.

Pie menus

Lists the available pie menus, and gives you the ability to read the hotkeys and assign own hotkeys.



Area

Area is a menu with window related settings.

Horizontal Split

Splits the editor horizontally into two editors.

Vertical Split

Splits the editor vertically into two editors.

Duplicate Area into new Window

Creates a floating window out of the current editor

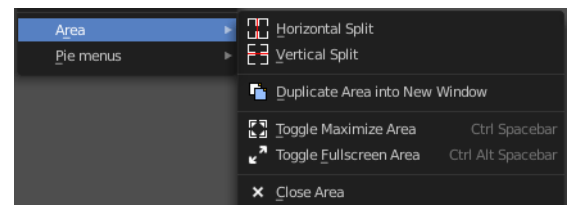

Toggle Maximize Area

Displays the editor maximized with menus.

To return to split view press hotkey Ctrl Up Arrow, or reuse the menu item in the View menu.

Toggle Fullscreen Area

Displays the editor maximized without menus.

To return from the full screen view press hotkey Alt F10, or use the little button that appears up right when you move the mouse in this corner.

Close Area

Closes the area window.

Search Field

Search for specific terms in the list. When the search term matches a name in the list, then the list will center at the first entry with the match.

This search field is collapsible, and closed by default to free some UI space.

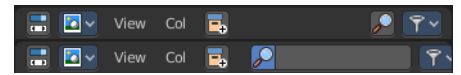

Right Click Menus

The Outliner comes with various right click functionality, dependent at what data you right click.

Outliner Scene Operation

This menu appears when you right click at a scene in Scene mode.

Delete

Deletes the currently selected scene.

Copy Settings

Creates an empty scene but also copies the settings from the active scene into the new one.

Linked Copy

This option creates a new scene with the same settings and contents as the active scene. However, instead of copying the objects, the new scene contains links to the objects in the old scene. Therefore, changes to objects in the new scene will result in the same changes to the original scene, because the objects used are literally the same. The reverse is also true.

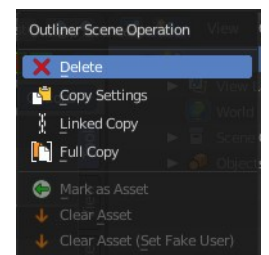

Full Copy

Using this option, nothing is shared. This option creates a fully independent scene with copies of the active scenes contents. Every object in the original scene is duplicated, and a duplicate, private copy of its object-data is made as well.

Mark as Asset, Clear Asset, Clear Asset (Set Fake User)

Scenes cannot be stored in the asset library. This menu entries are redundant.

Outliner Data Operation

This menu appears at various object types and when you for example right click at the View Layer item. It also appears at objects in Data API mode.

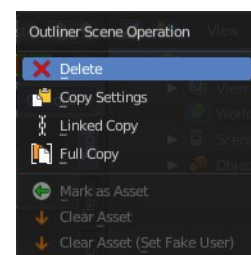

Select

Select the current element.

Deselect

Deselect the current element.

Hide

Hides the current element.

Unhide

Unhides the current element.

Select Linked

Does not show on all objects and tree elements. Selects the linked elements.

Mark as Asset, Clear Asset, Clear Asset (Set Fake User)

View Layers cannot be stored in the asset library. This menu entries are redundant.

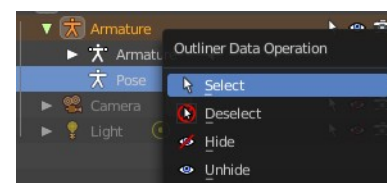

Collection

This menu appears when you right click at a collection. Clicking at a Scene collection will have not this much entries than clicking at the Collection item lower in the hierarchy.

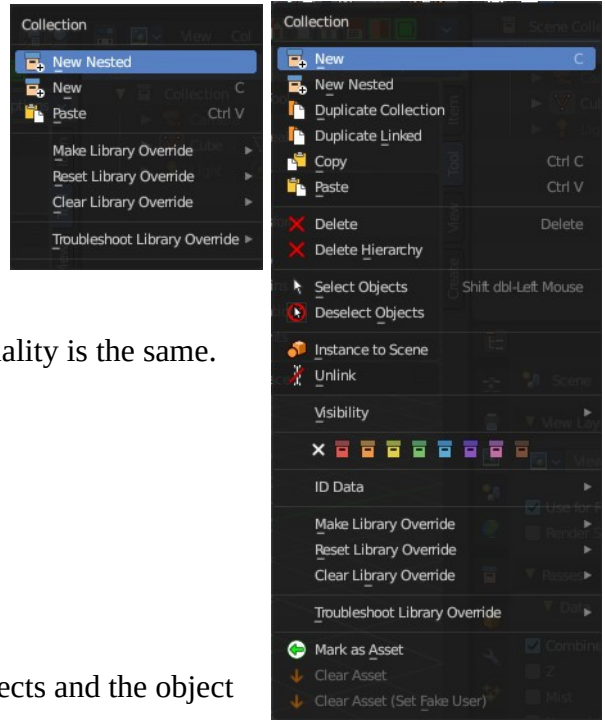

New Nested

Create a new nested collection. There is no difference. Both gets added in the selected collection as a child, and the functionality is the same. Ask the Blender developers what they did here.

New

Create a new scene collection.

Duplicate Collection

Duplicates the currently selected collection, all its children, objects and the object data.

Duplicate Linked

Recursively duplicate the selected collection, all its children and objects, including linked object data.

Copy

Copies the collection.

Paste

Pastes a copied collection.

Delete

Delete the collection. Objects in the hierarchy will remain.

Delete Hierarchy

Delete the collection. Objects in the hierarchy will be deleted too.

Select Objects

Select the objects in the collection.

Deselect Objects

Deselect the objects in the collection.

Instance to Scene

Instance selected collections to the active scene.

Unlink

Unlink selected collections from the active scene.

Visibility

Visibility is a sub menu with some visibility functionality. The greyed out menu items will become available when the functionality becomes available. For example, Show becomes available when something is hidden.



Isolate

Hide all but this collection and its parents.

Show All Inside

Reveals the collection and all its content.

Hide

Hides the collection.

Set Color Tag

Give the collections a colored icon.

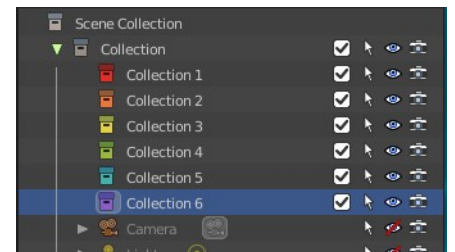
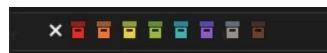

ID Data

Data related operations.

The content differs, dependant of the collection element that you right click at. And in which display mode you are. Linked collections have different content.

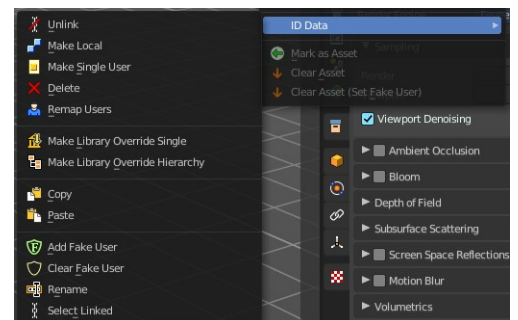
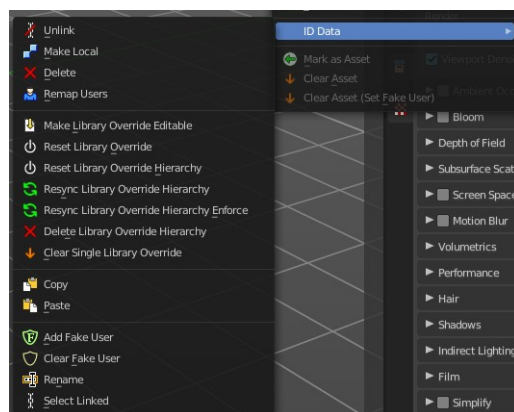
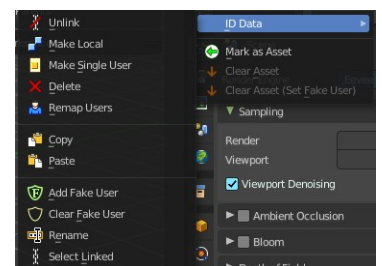

Unlink

Does basically the same than delete. It unlinks all data, and removes the object from the scene.

Make Local

For appended or linked data. Makes the selected object a local copy in the current blend file.

Add Library Override

Add a local library override to this collection.

This tool works different from Make Override in the outliner. It does not iterate through the hierarchy of objects and collections based on the selection. But works just for the currently selected object.

Library Overrides is the new system designed to replace and supersede Proxies. Most types of linked data-blocks can be overridden, and the properties of those overrides can then be edited. When the library data change, unmodified properties of the override one will be updated accordingly.

Make Single User

For duplicated content. Makes the data block of the selected object a single user.

Delete

Not functional in all situations. In the orphan data mode you can remove objects with this.

Remap Users

Remaps the user of a data block to another one of the same type. This allows you to replace all usages of a material or texture by another one.

Copy

Copies the user data block.

Paste

Pastes a copied user data block.

Make Library Override Editable

Just with a linked collection. Make a single, out of hierarchy, local override of this linked data.

This only applies to the active outliner item.

Make Library Override Hierarchy

Just with a linked collection. Make a local override of this linked data and its hierarchy of dependencies. Means the collection becomes local to the current blend file. And the hierarchy gets revealed.

This only applies to the active outliner item.

Reset Library Override

Just with a local made linked collection, by Make Library Override Hierarchy.

Reset this local override to its linked values.

Reset Library Override Hierarchy

Reset this local override to its linked values, including its hierarchical dependencies.

Resync Library Override Hierarchy

Rebuild this local override from its linked reference, including its hierarchical dependencies.

Resync Library Override Hierarchy Enforce

Rebuild this local override from its linked reference, including its hierarchical dependencies. But enforce the hierarchy to match the linked data. This ignores existing overrides on data pointer properties.

Delete Library Override Hierarchy

Deletes the selected element.

Clear Single Library Override

Deletes this local override if possible. If not reset it and mark it as not editable.

Copy

Copies the selected element.

Paste

Pastes the selected element.

Add Fake User

Adds a fake user to the selected object. Fake users is an odd concept to keep data in the scene even if it has no user somewhere. The fake user is then a dummy user so that the object is not deleted when saving the scene.

Clear Fake User

Removes the fake user from the selected object.

Rename

Rename the object in the outliner.

Select Linked

Selects all objects that are linked to the currently selected one.

Make Library Override

Library Overrides is a system designed to allow editing linked data, while keeping it in sync with the original library data. Most types of linked data-blocks can be overridden, and the properties of these overrides can then be edited.

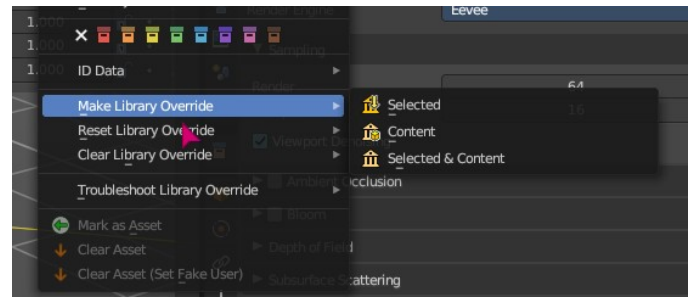

Selected

Add a library override to the selected collection.

Content

Add a library override to the content of the selected collection.

Selected & Content

Add a library override to both, the content of the selected collection, and the selected collection.

Reset Library Override

Library Overrides is a system designed to allow editing linked data, while keeping it in sync with the original library data. Most types of linked data-blocks can be overridden, and the properties of these overrides can then be edited.

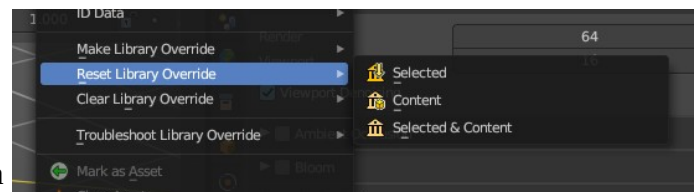

Selected

Reset a library override to the selected collection.

Content

Reset a library override to the content of the selected collection.

Selected & Content

Reset a library override to both, the content of the selected collection, and the selected collection.

Clear Library Override

Library Overrides is a system designed to allow editing linked data, while keeping it in sync with the original library data. Most types of linked data-blocks can be overridden, and the properties of these overrides can then be edited.

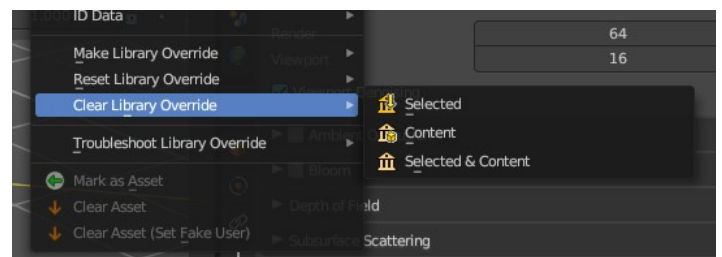

Selected

Clear the library override to the selected collection.

Content

Clear the library override to the content of the selected collection.

Selected & Content

Clear the library override to both, the content of the selected collection, and the selected collection.

Troubleshoot Library Override

Troubleshoot library Override operators are useful to help synchronize or remove overrides without needing to reload scene or the linked file.

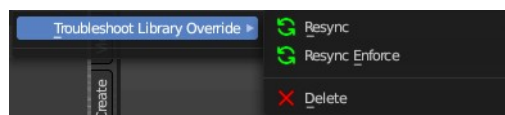

Resync

Rebuild the selected library overrides.

Resync Enforce

Rebuild the selected library overrides, enforcing libraries to match the linked data.

Delete

Delete the selected local library overrides. And relink the usage to the selected data.

Mark as Asset

Adds the collection to the asset library.

Clear Asset

Removes the collection from the asset library.

Clear Asset (Set Fake User)

Removes the collection from the asset library. But marks it with a fake user so that it remains in the scene.

Object Menu

This menu appears when you click at an object type. A mesh, a lamp, a camera ...

Select

Selects the object.

Select Hierarchy

Selects the object and its hierarchy.

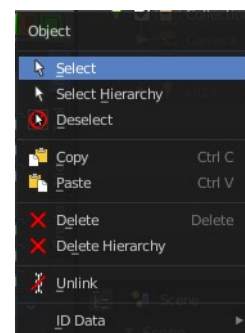

Deselect

Deselects the object.

Copy

Copies object.

Paste

Pastes copied object.

Delete

Deletes the selected object. Child objects gets unparented.

Delete Hierarchy

Deletes the selected object and all its child objects.

Unlink

Deletes the selected object.

ID Data

Data related operations. Note that the tool tips are currently missing here.

Unlink

Does basically the same than delete. It unlinks all data, and removes the object from the scene.

Make Local

For appended or linked data. Makes the selected object a local copy in the current blend file.

Make Single User

For duplicated content. Makes the data block of the selected object a single user.

Delete

Not functional in all situations. In the orphan data mode you can remove objects with this.

Remap Users

Remaps the user of a data block to another one of the same type. This allows you to replace all usages of a material or texture by another one.

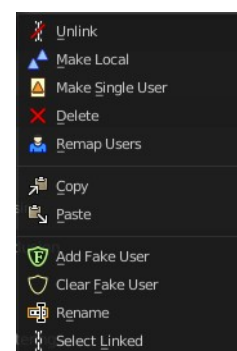

Copy

Copies ID data.

Paste

Pastes copied ID data.

Add Fake User

Adds a fake user to the selected object. Fake users is an odd concept to keep data in the scene even if it has no user somewhere. The fake user is then a dummy user so that the object is not deleted when saving the scene.

Clear Fake User

Removes the fake user from the selected object.

Rename

Rename the object in the outliner.

Select Linked

Selects all objects that are linked to the currently selected one.

Outliner ID Data Operation

This menu appears when you for example click at the mesh component of a mesh object. It is the same content than the ID Data menu from the Object menu.

Unlink

Does basically the same than delete. It unlinks all data, and removes the object from the scene.

Make Local

For appended or linked data. Makes the selected object a local copy in the current blend file.

Delete

Not functional in all situations. In the orphan data mode you can remove objects with this.

Remap Users

Remaps the user of a data block to another one of the same type. This allows you to replace all usages of a material or texture by another one.

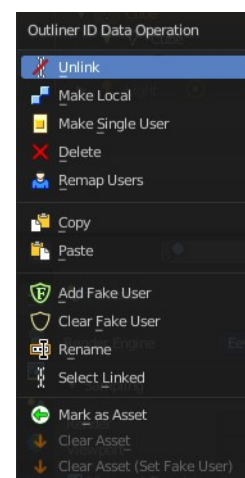

Copy

Copies ID data.

Paste

Pastes copied ID data.

Add Fake User

Adds a fake user to the selected object. Fake users is an odd concept to keep data in the scene even if it has no user somewhere. The fake user is then a dummy user so that the object is not deleted when saving the scene.

Clear Fake User

Removes the fake user from the selected object.

Rename

Rename the object in the outliner.

Select Linked

Selects all objects that are linked to the currently selected one.

Mark as Asset

Adds the collection to the asset library.

Clear Asset

Removes the collection from the asset library.

Clear Asset (Set Fake User)

Removes the collection from the asset library. But marks it as fake user so that it remains in the scene.

Outliner Animation Data Property

This menu appears with a right click at an Animation data.

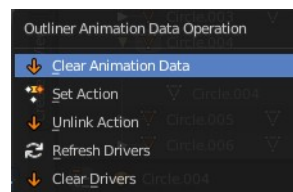

Clear Animation Data

Removes the whole animation.

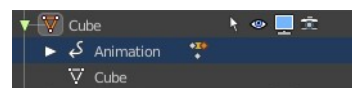

Set Action

Opens a popup menu where you can choose the action for this object.

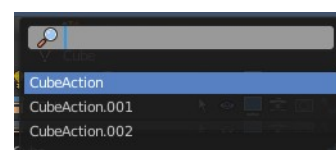

Unlink Action

Removes the action.

Refresh Drivers

Refreshes existing drivers.

Clear Drivers

Removes existing drivers.

Level Restrictions

Some list items have so called level restrictions. You can click at them, and so exclude the object from specific things. You can make more level restrictions available in the filter settings, which will be covered below. The by default activated are:



Selectability

Makes the object unselectable in the viewport. Or disables it, in case of a collection for example.

Hide from Viewport

Hides the object from the Viewport.

Hide from Render

Excludes the object from rendering.

Scenes Mode

The Scenes mode starts one hierarchy higher than the default View Layer Mode. It shows all available scenes and their content.

Normally you work with one scene. And so the default starts with the View Layer mode of the scene. But you can create more scenes in the Properties Editor in the Scene tab.

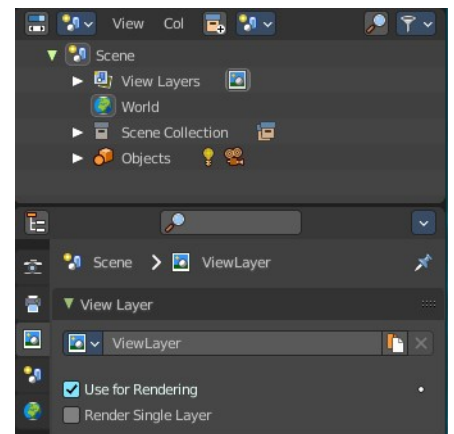

Collection Menu

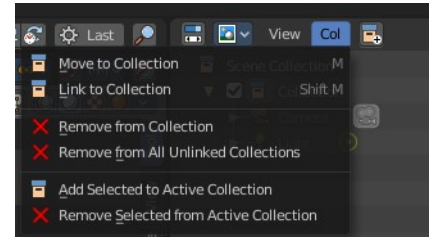

Move to Collection

Moves the selected object to a collection. The object is removed from the collection it was in.

By clicking at this menu item a popup will appear to choose the new collection. Allows also to create a new collection. Once done, the object will be moved to this new created collection.

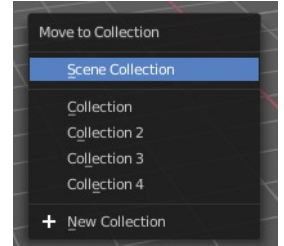
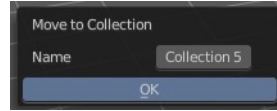

Last Operator Move to Collection

Name

Set a name for your new collection. When you haven't created a new collection, then this name stays blank.

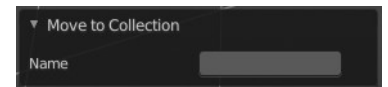

Link to Collection

Links the object to a collection. The object remains in the collection it was in.

By clicking at this menu item a popup will appear to choose the collection. Here you can also create a new collection. Once done, the object will be linked to this new created collection.

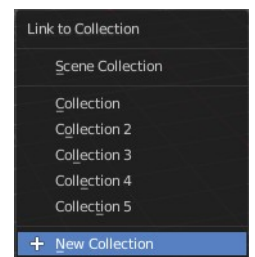
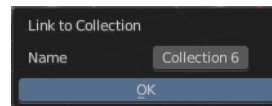

Last Operator Link to Collection

Name

Set a name for your new collection. When you haven't created a new collection, then this name stays blank.

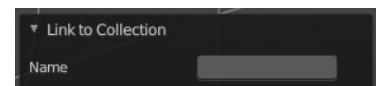

Remove From Collection

Objects can be in more than one collection. Remove from collection removes the selected object from the current collection.

When the object is in no collection anymore, then it gets removed.

Remove From all Unlinked Collections

Objects can be in more than one collection. Remove from all unlinked collection removes the selected object from all unlinked collections.

When the object is in no collection anymore, then it gets removed.

Add selected To Active Collection

Objects can be in more than one collection. Adds the selected object to the active collection.

Remove Selected From Active Collection

Objects can be in more than one collection. Removes the selected object from the active collection.

When the object is in no collection anymore, then it gets removed.

Add Collection



Add a collection inside of the current selected collection.

New Scene

New

Creates an empty scene with default values.

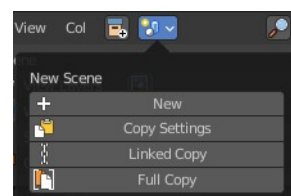

Copy Settings

Creates an empty scene but also copies the settings from the active scene into the new one.

Linked Copy

This option creates a new scene with the same settings and contents as the active scene. However, instead of copying the objects, the new scene contains links to the objects in the old scene. Therefore, changes to objects in the new scene will result in the same changes to the original scene, because the objects used are literally the same. The reverse is also true.

Full Copy

Using this option, nothing is shared. This option creates a fully independent scene with copies of the active scenes contents. Every object in the original scene is duplicated, and a duplicate, private copy of its object-data is made as well.

Filter

Options and filter settings.

Restriction Toggles

Enable or disable further level restrictions. Note that these toggles shows when you expand a scene hierarchy. Scenes itself have no such toggles.

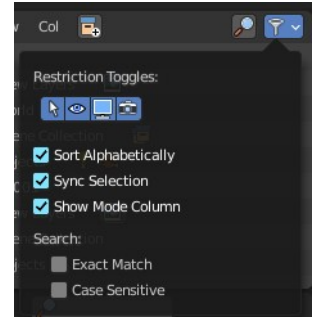

Sort Alphabetically

Sorts the content of the outliner in alphabetically order.

Sync Selection

Synchronize the selection between outliner and 3d view.

Show Mode Column

Display the Mode column at the left. When you are not in object mode, but in edit mode, or in vertex paint mode etc. , then a mode icon is displayed at the left of the object that you currently edit.



Search

Exact Match Search

The search result must fit exactly. For example, when you search for cam, then a camera should not display as a search result.

Case Sensitive Search

Search case sensitive.

View Layer Mode

The view layer mode shows the content of the current View Layer. This is the default mode.

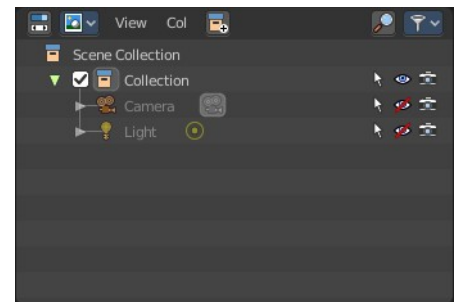

Collection Menu

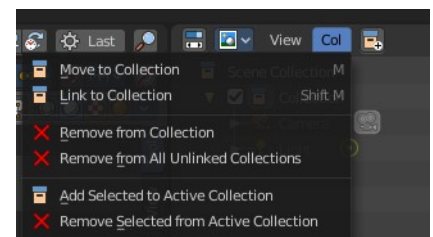

Move to Collection

Moves the selected object to a collection. The object is removed from the collection it was in.

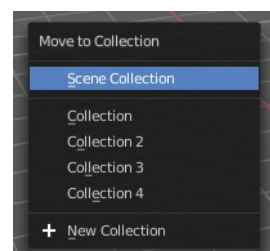
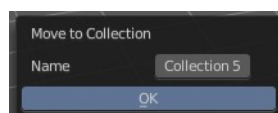

By clicking at this menu item a popup will appear to choose the new collection. Allows also to create a new collection. Once done, the object will be moved to this new created collection.

Link to Collection

Links the object to a collection. The object remains in the collection it was in.

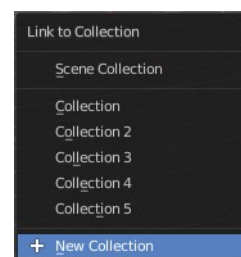
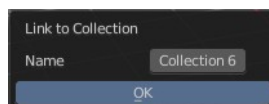

By clicking at this menu item a popup will appear to choose the collection. Here you can also create a new collection. Once done, the object will be linked to this new created collection.

Note that there is a tool called Add to collection in the Object Properties in the Collections panel that does a similar job. It links an object to other collections. But this Link to Collection tool here just lists the collections in the current view layer.

Remove From Collection

Objects can be in more than one collection. Remove from collection removes the selected object from the current collection.

When the object is in no collection anymore, then it gets removed.

Remove From all Unlinked Collections

Objects can be in more than one collection. Remove from all unlinked collection removes the selected object from all unlinked collections.

When the object is in no collection anymore, then it gets removed.

Add selected To Active Collection

Objects can be in more than one collection. Adds the selected object to the active collection.

Remove Selected From Active Collection

Objects can be in more than one collection. Removes the selected object from the active collection.

When the object is in no collection anymore, then it gets removed.

Add Collection

Add a collection inside of the current selected collection.



Filter

Options and filter settings.

Restriction Toggles

Enable or disable further level restrictions. To make the changes permanent you would have to save the startup file. This settings is part of the layout.

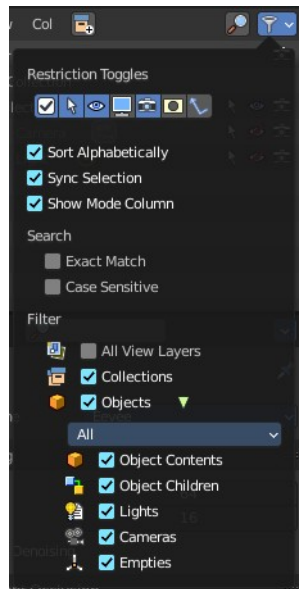

Exclude from View Layer

include / Exclude the collection from the view layer.

Selectable

Make the object selectable / unselectable.

Hide in Viewport

Show or hide the object in the viewport.

Disable in Viewport

Enable or disable the object in the viewport.

Disable in Renders

Enable or disable the object in the rendered result.

Holdout

Mask out objects in the collection from view layer.

Indirect only

Make the objects in the collection just distribute indirect lighting to the layer.

Sort Alphabetically

Sorts the content of the outliner in alphabetically order.

Sync Selection

Synchronize the selection between outliner and 3d view.

Show Mode Column

Display the Mode column at the left. When you are not in object mode, but in edit mode, or in vertex paint mode etc. , then a mode icon is displayed at the left of the object that you currently edit.



Search

Exact Match Search

The search result must fit exactly. For example, when you search for cam, then a camera should not display as a search result.

Case Sensitive Search

Search case sensitive.

Filter

Shows or hides the object and data types. The names should be self explaining. Note that the Library Override option just shows for appended objects.

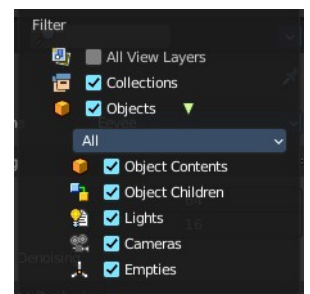

Object State Filter

Shows or hides objects by its state.

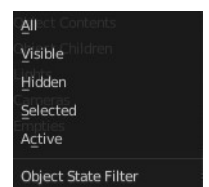

Invert

Inverts the object state filter.



Sequence Mode

This mode lists the loaded files when you work with the sequencer layout and have video material loaded.

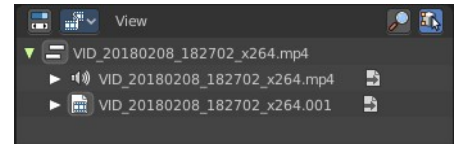

Sync Outliner Selection

Keep the selection in synchronization with the other editors. 3D View and VSE.

Blender File Mode

This mode lists the whole content of the current Blender file. It includes also things like the default brushes, which comes from the startup defaults.



Filter

Enable a filter to display a specific data type. You can just filter by one data type at a time. The rest will be hidden.

Filter ID Type

The menu to choose the data type that should be displayed.

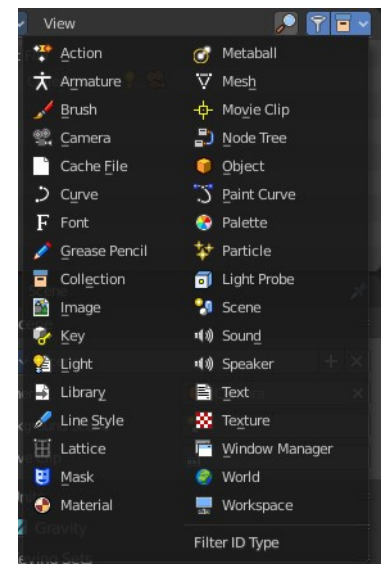

Outliner Library Operation

In this mode, you can see linked data from external *.blend files.

Grey arrows means the data is directly referenced from a linked *.blend file.

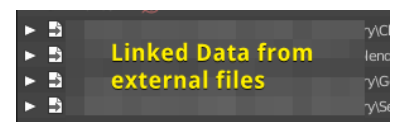

Green arrows means the data is indirectly referenced into another linked *.blend file.

Delete

Deletes linked libraries.

Relocate

Relocated the path of a linked library.

Reload

Reloads and refreshes the linked library in the current file.

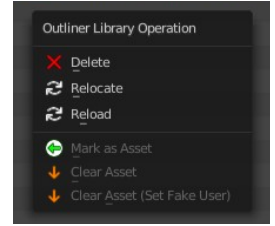

Data API Mode

Displays Low Level Blender data and its properties.

This view also reveals some properties. Like File is Saved or Use Autopack.

When no keying set is defined then you will get a No Keying set Active message instead of the Keying set element.

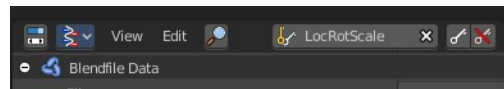
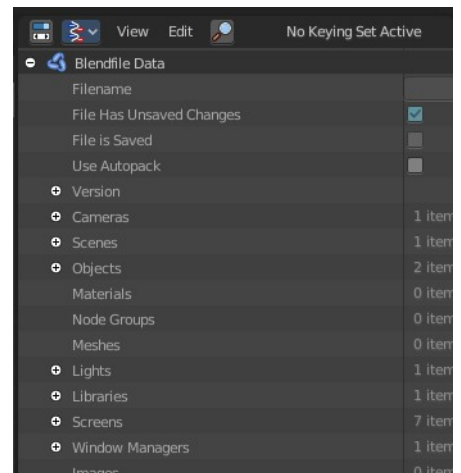

Header tools

Edit Menu

Keying Set Add Selected

Add a keying set to the selected object.

Keying Set Remove Selected

Remove the keying set from the selected object.

Add Drivers to Selected

Add a driver to the selected object.

Delete Drivers for Selected

Delete a driver from the selected object.

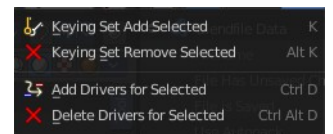

Set Keying set

Choose a keying set.

Add keyframe

Adds a keyframe for the selected element.

Remove keyframe

Removes the current keyframe from the selected element.

Library Override Mode

Lists the library overrides in the scene.

This feature is experimental and this lousy documented in the Blender manual that it is not to find out what library overrides are and how to use them. None of the mentioned ways to create a library override works.

What you can read there though is how great they are, and that they replace the proxies. So here comes the outliner section for the great library overrides. Whatever it is ...

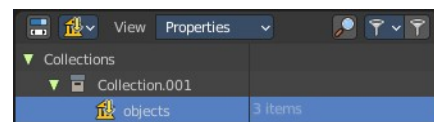

Library Override View Mode

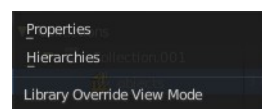

Properties

Show the properties of the library overrides.

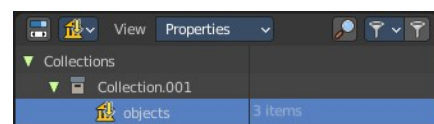

Hierarchies

Show the objects with library overrides in a hierarchical way.

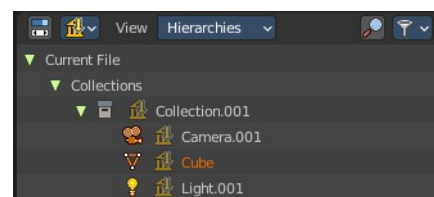

Filter options

Sort alphabetically

Sorts the library overrides in alphabetical order in the outliner list.

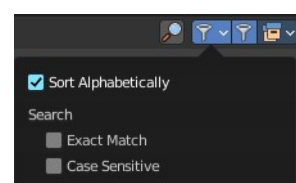

Search

Search options.

Exact match

Search with exact match.

Case sensitive

Take upper and lower case status into account.

Filter

Enable a filter to display a specific data type. You can just filter by one data type at a time. The rest will be hidden.

Filter ID Type

The menu to choose the data type that should be displayed.

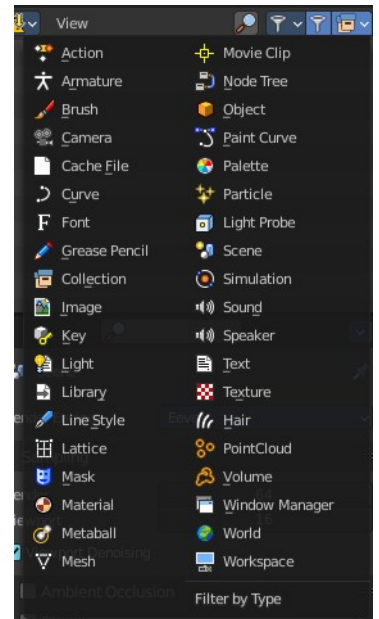

Orphan Mode

Bforartists has a special system to treat not longer used data. Unused data will normally remain in the scene as long as you haven't saved it and reloaded it. Means delete does not immediately remove a mesh completely from the scene for example. It will be orphan data now. Until you save and reopen the scene. The cleanup process happens at saving the blend file.

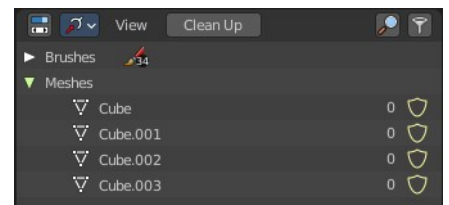

The Orphan Mode allows you to clean up the unused data without to save and reload the blend file. It lists all data that has no user in the scene. This includes the standard brushes from the startup configuration. Don't delete them!

Clean Up

Normally you would need to save the blend file and reload it to get rid of the orphan data. Clean Up removes all

orphan data from the blend file immediately. Note that this does not remove objects with a fake user associated.

Clean Up menu

The clean up button cleans up what is in the list. This is good enough for most cases. But sometimes you might want to have a bit more fine control.

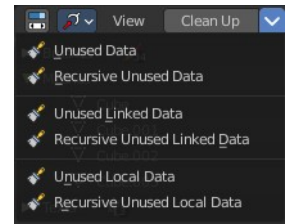

Unused Data

Removes unused data blocks.

Recursive Unused Data

Recursively removes unused data blocks. Means the child objects gets removed too.

Unused Linked Data

Removes unused data that is linked to this file.

Recursive Unused Linked Data

Recursively removes unused data that is linked to this file. Means the child objects gets removed too.

Unused Local Data

Removes unused local data.

Recursive Unused Local Data

Recursively removes unused local data. Means the child objects gets removed too.

Filter

Enable a filter to display a specific data type. You can just filter by one data type at a time. The rest will be hidden.

Filter ID Type

The menu to choose the data type that should be displayed.

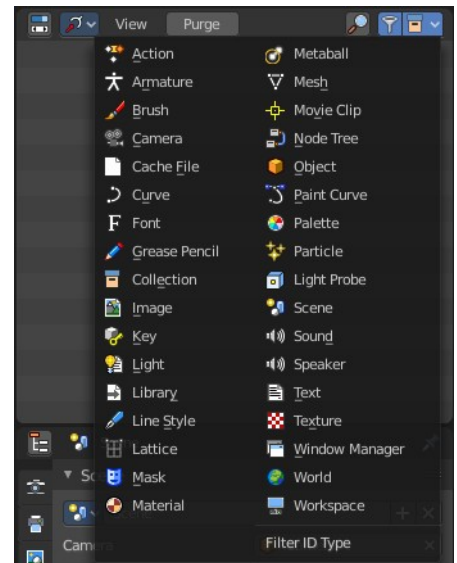

Status column

The number at the right tells you how many users the object has.



Objects with a power icon and an F besides the number have a fake user assigned. Objects with an X in the row is orphan data, and will be removed with the next save and reload of the blend file. Objects with the power icon will remain in the scene. They have a fake user.

To remove the Fake User at an object click at the Power icon. It will turn into the X button then. And the object will be removed at saving.

Hotkey only functionality

Important! These hotkeys works with the default Bforartists key map And they do not list the N dof hotkeys. N dof is a 3d connexion mouse device that is also used for tablets.

Most of the tools can be found in the graphical UI. But there are still some tools that are hotkey only. Some have a UI brother with equal functionality. For example, Pick shortest path is the hotkey sister of Select shortest path. Some are hotkey only since they cannot be integrated in the graphical UI. Like calling the File menu under the mouse. Or mouse position dependent functionality like selecting an edge loop.

The navigation hotkeys and the context menus are excluded here since they are already covered.

Insert Keyframe - I

Insert a keyframe at current position. You need to have a keying set added to the object.

Delete Keying Set Keyframe - Alt I

Remove existing keyframes.

Hide - H

Hides the object in the 3d view.

Unhide - Alt H

Unhides all hidden objects in the 3d view.



26 Editors - Properties Editor

Table of content

Properties Editor.....	1
Hotkey functionality.....	1
Slider snapping.....	2
Header and Tabs.....	2
Search.....	2
Options.....	2
Sync with Outliner.....	2
On.....	2
Off.....	2
Auto.....	2
Context pin.....	2
Editortype Menu.....	3
Navigation Tabs.....	3
Tabs position.....	3
Globals section.....	3
Object Data Section.....	3
Properties Editor - Context menu.....	4
Area.....	4
Horizontal Split.....	4
Vertical Split.....	4
Duplicate Area into New Window.....	4
Toggle Maximize Area.....	4
Toggle Full screen Area.....	4

Properties Editor

The Properties Editor is the core to manage the data in Bforartists. It is used to edit data and properties for the Active Scene and the Active Object. It contains Scene and Object related settings and properties. It contains all the tool settings for the current active tool. And it contains global settings and properties, like Render settings. Materials, Particle settings. etc.

The Properties editor is divided into several tabs. And the tabs are divided into several panels. The tabs buttons can be found asides.

Various content just appears when you are in the right context. Means when you have a specific object type selected, are in a specific mode, etc.

Hotkey functionality

You can scroll through the tabs by holding down ctrl and using the scroll wheel.

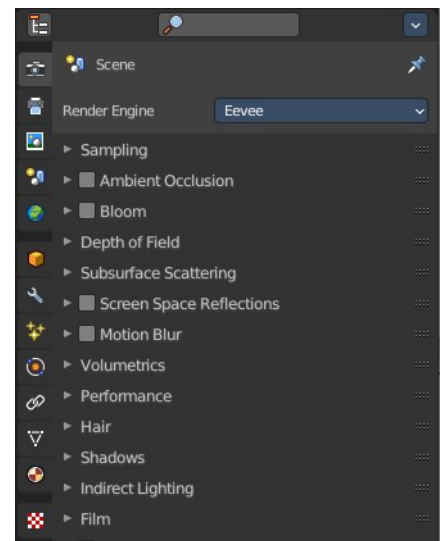

Slider snapping

Snapping also works at sliders. Hover with the mouse over the slider, start to slide, and holding down **Ctrl** will snap the sliders in incremental steps.



When it's a default value between 0 and 1 then it usually snaps in 0.1 steps. When it's a default value over 1 then it usually snaps in steps of 10.

Header and Tabs

The header contains a button to switch to Outliner and back. And it contains a search and a context pin.



Search

Allows you to search for specific terms. All not matching content is greyed out. When the matching term is in one of the closed panels, then this panel will open up.

Options

Sync with Outliner

Adjust if properties editor is in sync with the outliner. It can make sense to turn off sync for performance reasons.

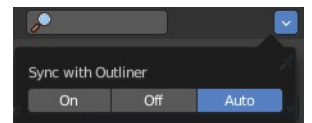

On

Always sync outliner with properties editor.

Off

Never sync outliner with properties editor.

Auto

Sync outliner with properties editor when they share an edge with each other.

Context pin

The header can also contain a pin icon in some areas. This pin icon allows you to collapse the tabs to just the tabs that are available for the currently selected kind of object type.

Editortype Menu

You can display a Editortype Menu in the header. This menu allows you to switch to another editor type. Note that this menu

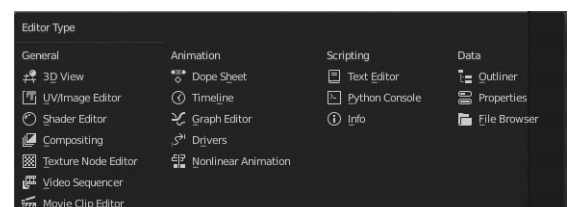

is hidden by default. You can reveal it in the right click menu of the header area.

Navigation Tabs

The navigation tabs to navigate in the Properties Editor are vertically aligned besides the editor.

It is divided into two sections. Globals Section. Green. and Object Data section. Blue.

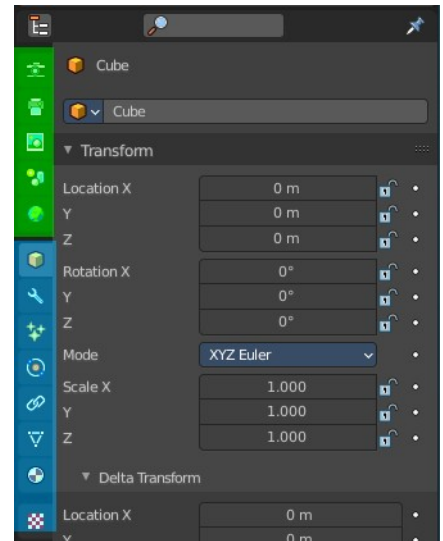

Tabs position

The tabs can be displayed at the left or at the right side. Either click right in the empty space of the tab area. This will bring up the Context menu where you can flip the whole tabs menu bar to the right or to the left. Or move with the mouse over the area and press F5.

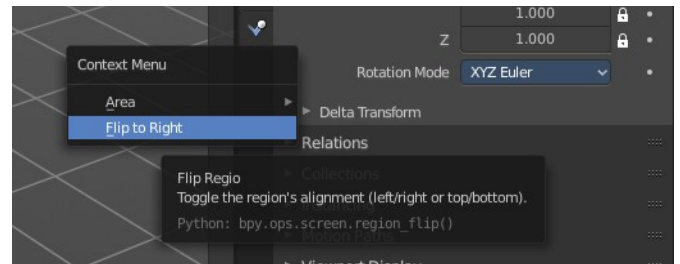

The navigation tabs are divided into three groups. Tools section, Globals section and Object Data Section. We will cover the content of the different tabs in the corresponding section of the manual.

Globals section

The Globals section contains everything that is not related to the currently selected object. But global. Render settings, View-, Scene- and World settings.



Object Data Section

The Object Data section contains everything that is related to the currently selected object. From mesh data across material up to texture and particle system.

The content differs, dependent of the currently active object. For an Armature you will have other tabs than for a Mesh object, and other tabs for a Lattice object for example.

There are some general tabs though for all object types. Like Object, Constraints, Texture, or Physics tab.



Properties Editor - Context menu

When you click into an empty area of the Properties editor then you call the context menu.

Area

This menu contains general view functionality. And exists in most other editor types too.

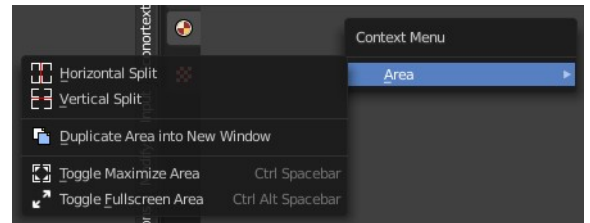

Horizontal Split

Splits the current view horizontally into two independent editor windows.

Vertical Split

Splits the current view vertically into two independent editor windows.

Duplicate Area into New Window

Duplicate Area into New Window makes the selected editor window floating. You can then drag it around at the monitor. It is not connected with the rest of the UI anymore.

A separated window cannot be merged into the main window again. You have to close it when not longer needed.

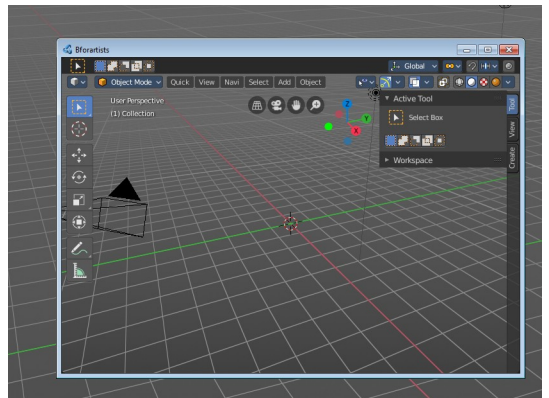

Toggle Maximize Area

Displays the editor maximized with menus.

To return from the maximized view press hotkey ctrl + spacebar. Or reuse the menu item in the area menu.

Toggle Full screen Area

Displays the editor maximized without menus.

To return from the full screen view press hotkey ctrl + alt + spacebar.



26.10 Editors - Properties Editor - Particle Properties Tab

Table of content

Intruduction.....	2
Particle Modifier.....	2
Workflow.....	2
Header.....	3
List of Particle Systems.....	3
Realtime.....	3
Render.....	3
Drag Handler.....	3
Search Field.....	3
Invert.....	3
Sort by Name.....	3
Add Particle System Slot.....	3
Remove Particle System Slot.....	3
Particle Specials.....	3
Copy Active to Selected Objects.....	3
Copy All to Selected Objects.....	3
Duplicate Particle Systems.....	3
Particle property.....	4
Particle settings browser.....	4
Edit Box.....	4
Fake User.....	4
New Particle Settings.....	4
Remove Particle Settings.....	4
Type.....	4
Emitter.....	4
Hair.....	4
Regrow.....	4
Advanced.....	4
Delete Edit.....	4
Disconnect Hair.....	5
Disconnect All.....	5

Intruduction

A particle system is used to animate lots of small objects at once. Particles. Each particle can be a point or a mesh, and can be joined or dynamic. They may react to different forces and influences. And they can have a life span.

There are two types of particles. Emitted particles and hair. Emitted particles are used for things like fire, smoke, mist and many other animated effects. Hair is used for hair effects, at characters for example. Some settings are the same for both types. These chapters are unioned. But each has also its own set of tools. These chapters are separated.

Particles uses a regular mesh object as the emitter. Other object types does not have the particle tab.

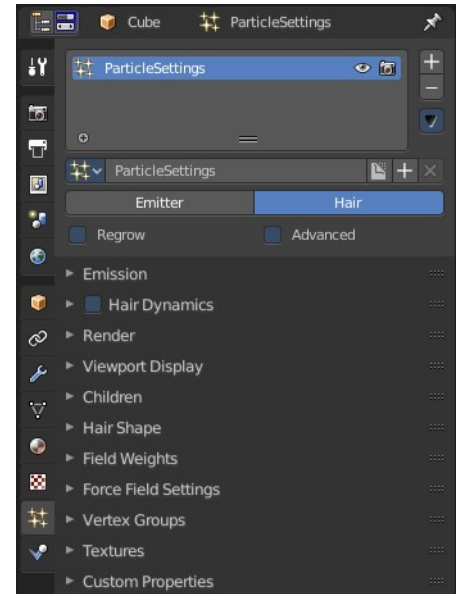

Particle Modifier

When you create a particle system then a particle modifier gets added in the Modifiers panel. This works also the other way around. You can also add a particle modifier in the modifier tab. The settings remains in the particles tab.

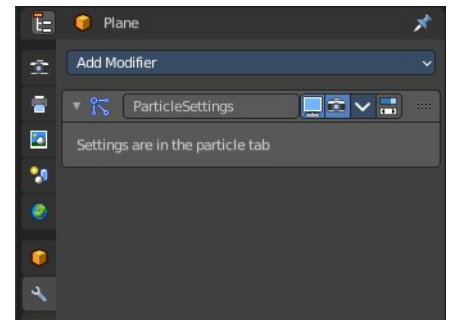

Workflow

Create a mesh.

Create one or more Particle Systems to emit from the mesh.

Choose the particle system type. Emit or Hair.

Go through the particle settings to adjust the Particle System settings to achieve the desired effect.

For Hair particle systems, switch to particle edit mode, and comb the emitter's flow.

To see the effect for emitted particles press play.

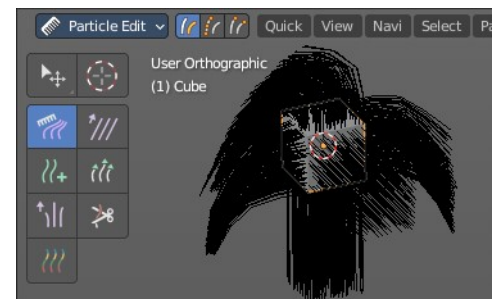
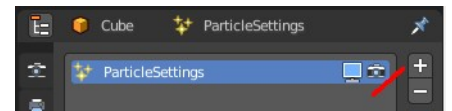

Header

List of Particle Systems

A list of the particle systems for this object. Double clicking allows to rename it.

Realtime

Display the particle system in the viewport.

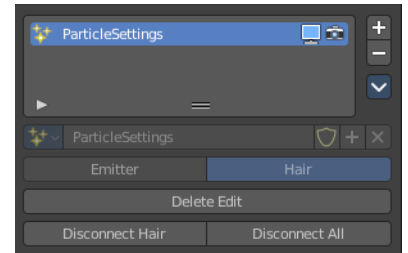

Render

Display the particle system in the rendered result.

Drag Handler

The two vertical lines at the end is a handler with which you can expand the list.

Search Field

You can expand a search field at the bottom of the list. Type in your term and hit enter to filter for your term.



Invert

Exclude the search term instead of searching for it.

Sort by Name

Sort the List by name.

Add Particle System Slot

Adds a new particle system.

Remove Particle System Slot

Remove the particle system.

Particle Specials

Copy Active to Selected Objects

Copies the active particle system to all selected objects.

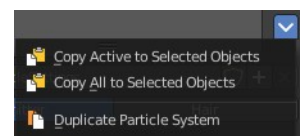

Copy All to Selected Objects

Copies all particle systems from the active object to all selected objects.

Duplicate Particle Systems

Duplicates the particle system within the active object. The Duplicate Settings option (in the Adjust Last

Operation panel) will duplicate settings as well, so the new particle system uses its own settings.

Particle property

Particle settings browser

A particle settings browser with the available particle systems in the scene.

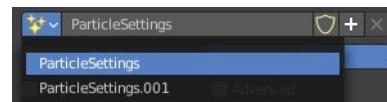

Edit Box

The name of the currently active palette. You can also rename the palette here. A click into the edit box makes the name editable.

Fake User

Fake User sets the element to have a fake user. Data without a user is normally not saved. But sometimes you want to force the data to be kept even when the data block has no user.

New Particle Settings

Add a new particle system.

Remove Particle Settings

Removes the particle system as the active particle system. Note that the particle system is still in the list.

Type

Main selector of the system type.

Note that some of the panels are identical for both particle types. But some not. Even when they have the same label.

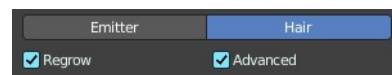

Emitter

Emitter type. Particles are emitted from the object.

Hair

Hair type, rendered as strands.

Regrow

Type Hair. Regrows the hair for each frame. This is useful when you are animating properties.

Advanced

Type Hair. Enables advanced settings, and reveals some more functionality. Which reflect the same ones as working in Emitter mode.

Delete Edit

Appears when you modify the particles in particle edit mode. Resets the

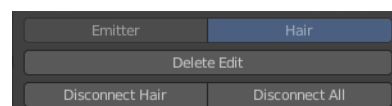

particle system to the default state before combing.

Disconnect Hair

Appears when you modify the particles in particle edit mode. Disconnect the selected hair from the emitter object.

Disconnect All

Appears when you modify the particles in particle edit mode. Disconnect the whole hair from the emitter object.



26.10.1 Editors - Properties Editor - Particle Properties Tab - Emitter

Table of content

Introduction.....	1
Workflow example.....	1

Introduction

There are two types of particles. Emitted particles and hair. Emitted particles are used for things like fire, smoke, mist and many other animated effects. Hair is used for hair and fur effects, at characters for example.

This manual part is for particles of type Emitter.

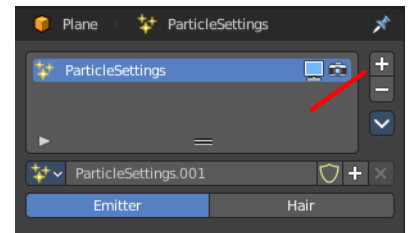

Workflow example

Create a plane.

Add a particle system.

Hit play. You will now see particles falling down from the plane.

Now you can start to tweak the settings until you are satisfied.

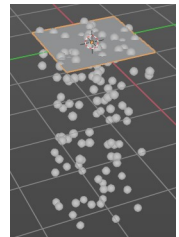



26.10.10 Editors - Properties Editor - Particle Properties Tab - Hair - Hair Dynamics panel

Table of content

Hair Dynamics panel.....	1
Quality Steps.....	1
Pin Goal Strength.....	1
Collisions.....	1
Quality.....	1
Distance.....	2
Impulse Clamping.....	2
Collision Collection.....	2
Structure.....	2
Vertex Mass.....	2
Stiffness.....	2
Random.....	2
Damping.....	2
Volume.....	2
Air Drag.....	2
Internal Friction.....	2
Voxel Grid Cell Size.....	3
Density Target.....	3
Density Strength.....	3

Hair Dynamics panel

Hair particles can have dynamic properties using physics. To enable hair physics, click the checkbox beside Hair Dynamics.

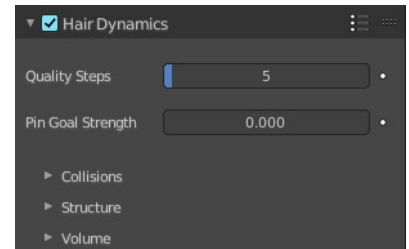

Quality Steps

Quality of the simulation in steps per frame (higher is better quality but slower).

Pin Goal Strength

Spring stiffness of the vertex target position.

Warning! If you use motion blur in your animation, you will need to bake one extra frame past the last frame which you will be rendering.

Collisions

Quality

A general setting for how fine and good a simulation you wish. Higher numbers take more time but ensure less tears and penetrations through the cloth.

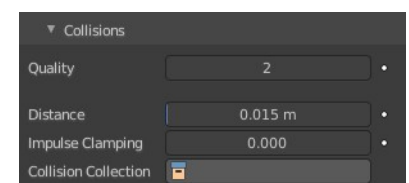

Distance

The distance another object must get to the cloth for the simulation to repel the cloth out of the way. Smaller values might cause errors but provide some speed-up while larger will give unrealistic results if too large and can be slow. It is best to find a good in between value.

Impulse Clamping

Prevents explosions in tight and complicated collision situations by restricting the amount of movement after a collision.

Collision Collection

Only objects that are a part of this Collection can collide with the cloth. Note that these objects must also have Collision physics enabled.

Structure

Vertex Mass

Value for the mass of the hair.

Stiffness

Controls the bending stiffness of the hair strands.

Random

Random stiffness of hair.

Damping

Damping of bending motion.

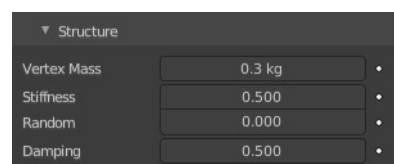

Volume

Some phenomena of real-world hair can be simulated more efficiently using a volumetric model instead of the basic geometric strand model. This means constructing a regular grid such as those used in fluid simulations and interpolating hair properties between the grid cells.

Air Drag

Controls how thick the air is around the hair causing the hair to flow slower.

Internal Friction

Amount of friction between individual hairs.

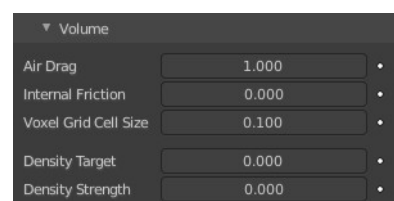

Voxel Grid Cell Size

Size of the voxel grid cells for interaction effects.

Density Target

Maximum density of the hair.

Density Strength

The influence that the Density Target has on the simulation.



26.10.11 Editors - Properties Editor - Particle Properties Tab - Hair - Cache Panel

Table of content

Cache Panel.....	1
Hints.....	2
Caches List.....	2
Drag Handler.....	2
Search Field.....	2
Invert.....	2
Sort by Name.....	2
Add New Cache.....	3
Delete current Cache.....	3
External.....	3
Index Number.....	3
File Path.....	3
Info string.....	3
Cache Step.....	3
Info string.....	3
Disk Cache.....	3
Use Library Path.....	4
Compression.....	4
None.....	4
Light.....	4
Heavy.....	4
Bake / Delete Bake.....	4
Calculate To Frame.....	4
Current Cache to Bake.....	4
Bake All Dynamics.....	4
Free All Bakes.....	5
Update All To Frame.....	5

Cache Panel

Particle data can be cached in memory or stored on a drive. This improves real-time response and avoids unnecessary recalculation of particles. But creates also big files.

The Emitter particle system uses a unified system for caching and baking (together with Soft Body and Cloth).

Important! The file needs to be saved after baking. When the file is not saved then some options are not available.

Important! The particle settings becomes unavailable once the particle cache is baked. You need to remove the bake when you want to change the settings.

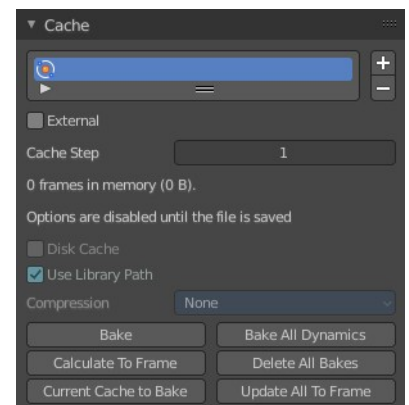

Hints

The simulation is only calculated for positive frames in between the Start and End frames of the Cache panel, whether you bake or not. So if you want a simulation that is longer than the default frame range, you have to change the End frame.

When an animation is played, each physics system writes each frame to the cache. Note that for the cache to fill up, one has to start the playback before or on the frame that the simulation starts.

The cache is cleared automatically on changes. But not on all changes, so it may be necessary to free it manually. For example if you change a force field.

The system is protected against changes after baking. If for example the mesh changes the simulation is not calculated anew.

The bake result can be cleared by clicking on the Free Bake button in the simulation cache settings.

A simulation can only be edited in Particle Edit Mode when it has been baked in memory. And cannot be edited if the Disk Cache is used.

If you are not allowed to write to the required sub directory caching will not happen. For example if your blend-file path is very long and your operating system has a limit on the path length that is supported.

Be careful with the sequence of modifiers in the modifier stack. You may have a different number of faces in the 3D Viewport and for rendering (For example when using subdivision surface). Then the rendered result may be very different from what you see in the 3D Viewport.

Caches List

The list of available caches. The caches have no name by default. Double click to add a name.



You can store and manage multiple caches at once for the same physics object. The active cache is the one that gets used.

Drag Handler

The two vertical lines at the end is a handler with which you can expand the list.

Search Field

You can expand a search field at the bottom of the list. Type in your term and hit enter to filter for your term.



Invert

Exclude the search term instead of searching for it.

Sort by Name

Sort the List by name.

Add New Cache

Add a new cache.

Delete current Cache

Deletes the selected cache.

External

Allows you to read the cache from a drive using a user-specified file path.

Note! The cache name in Caches List and the Index Number has to exactly match the external cache files name in order to work. The cache files name format is name_frame_index.bphys.

You can create such cache files when you tick Disk cache with External off, and save the blend file. Then the bphys files gets created in a folder besides the blend file.

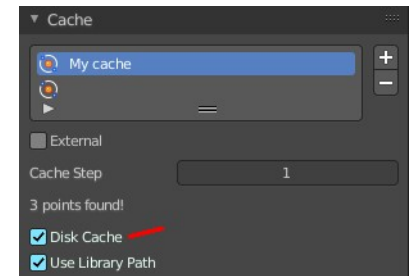
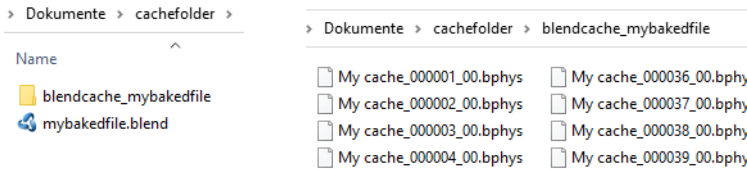

Index Number

The index number of cache files. (The last two digits of the files name.)

File Path

Select the directory path to the cache files.

Info string

An info string. Gives different messages, dependent of the status.

Cache Step

The interval for storing simulation data.

Note! Some physics systems (such as particles) allow for positions to be stored only on every nth frame, letting the positions for in-between frames be interpolated. Using a cache step greater than one will result in a smaller cache, but the result may differ from the original simulation.

Info string

An info string. Gives different messages, dependent of the status.

Disk Cache

Save the cache externally in a folder instead inside of the blend file. The cache of a baked simulation will be stored inside the blend-file when you save it. A folder named blendcache_[filename] will then be created along-

side the blend-file. The blend-file must be saved first and then again.

Use Library Path

Share the disk cache when the physics object is linked into another blend-file.

When this option is enabled, linked versions of the object will reference the same disk cache. Otherwise linked versions of the object will use independent caches.

Compression

The compression level for cached files.

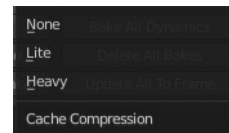

None

Do not compress the cache.

Light

Compression will optimize the speed of compressing/decompressing operations over file size.

Heavy

Compression will result in smaller cache files, but requires more CPU power to compress / decompress.

Bake / Delete Bake

Start baking. Once you have baked the cache the button turns into a Delete bake button. And allows you to remove the bake.



The baking progress can be seen in the footer. You need to be in Object Mode to bake.



Calculate To Frame

Bake only up to the current frame. Limited by End frame set in the cache settings.

Current Cache to Bake

Store any temporarily cached simulation data as a bake. Note that playing the animation will try to simulate any visible physics simulations. Depending on the physics type, this data may be temporarily cached. Normally such temporary caches are cleared when an object or setting is modified, but converting it to a bake will “save” it.

Bake All Dynamics

Bake all physics systems in the scene, even those of different types. Useful for baking complex setups involving interactions between different physics types.

Free All Bakes

Free bakes of all physics systems in the scene, even those of different types.

Update All To Frame

Bake all physics systems in the scene to the current frame.



26.10.12 Editors - Properties Editor - Particle Properties Tab - Hair - Rotation panel

Table of content

Rotation Panel.....	1
Orientation Axis.....	1
None.....	1
Normal.....	1
Normal-Tangent.....	1
Velocity.....	2
Global X, Y, Z.....	2
Object X, Y, Z.....	2
Randomize.....	2
Phase.....	2
Randomize Phase.....	2
Dynamic.....	2
Angular Velocity.....	2
Axis.....	2
Amount.....	2

Rotation Panel

Specify how the individual particles are rotated during their travel. To visualize the rotation of a particle you should choose visualization type Axis in the Visualization panel and increase the Display Size.

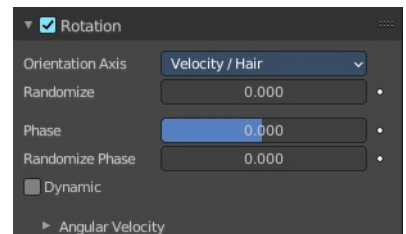

Orientation Axis

Sets the initial rotation of the particle by aligning the X axis in the direction of:

None

The global X axis.

Normal

Orient to the emitter's surface normal, the objects Y axis points outwards.

Normal-Tangent

As with normal, orient the Y axis to the surface normal. Also orient the X axis to the tangent for control over the objects rotation about the normal. requires UV coordinates, the UV rotation effects the objects orientation, currently uses the active UV map. This allow deformation without the objects rotating in relation to their surface.



Velocity

The particle's initial velocity.

Global X, Y, Z

One of the global axes.

Object X, Y, Z

One of the emitter object axes.

Randomize

Randomizes rotation.

Phase

Initial rotation phase.

Randomize Phase

Adds a random variation to the Phase.

Dynamic

If Dynamic is enabled, only initializes particles to the chosen rotation and angular velocity and let the physics simulation handle the rest. Particles then change their angular velocity if they collide with other objects (like in the real world due to friction between the colliding surfaces). Otherwise the angular velocity is predetermined at all times (i.e. set rotation to dynamic/constant).

Angular Velocity

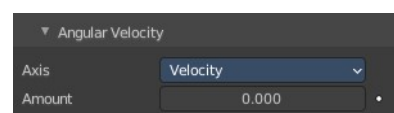

Axis

Which axis to use for the angular velocity.

Hint! If you use a Curve Guide do not turn on Dynamic. Curve Follow does also not work for particles.

Amount

The magnitude of angular velocity.

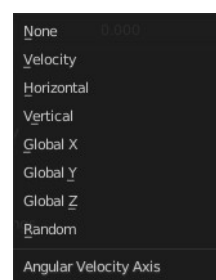



26.10.13 Editors - Properties Editor - Particle Properties Tab - Hair - Render panel

Table of content

Render Panel.....	2
Render As.....	2
All render methods.....	2
Show Emitter.....	2
None.....	2
Path.....	2
Material.....	2
Coordinates System.....	3
Path subpanel.....	3
B-Spline.....	3
Steps.....	3
Timing subpanel.....	3
Absolute Path Time.....	3
Start.....	3
End.....	3
Random.....	3
Extra subpanel.....	3
Parents Particles.....	3
Unborn.....	3
Dead.....	3
Object.....	4
Scale.....	4
Scale randomness.....	4
Object Sub tab.....	4
Instance Object.....	4
Global Coordinates.....	4
Object Rotation.....	4
Object Scale.....	4
Extra sub tab.....	4
Parents Particles.....	4
Unborn.....	4
Dead.....	4
Collection.....	4
Scale.....	5
Scale randomness.....	5
Collection Sub tab.....	5
Instance Collection.....	5
Whole collection.....	5
Pick Random.....	5
Global Coordinates.....	5
Object Rotation.....	5
Object Scale.....	5
Use Count.....	5
Active Dupli Object Index list.....	5
Drag Handler.....	5

Search Field.....	5
Invert.....	5
Sort by Name.....	6
Revert.....	6
Copy Particle Dupliobject.....	6
Remove Particle Dupliobject.....	6
Move Up / Down Dupli Object.....	6
Refresh Dupli Objects.....	6
Count.....	6
Extra sub tab.....	6
Parents Particles.....	6
Unborn.....	6
Dead.....	6

Render Panel

Hair particles can be rendered as a Path. And it can render Objects or collections as the hair particles.

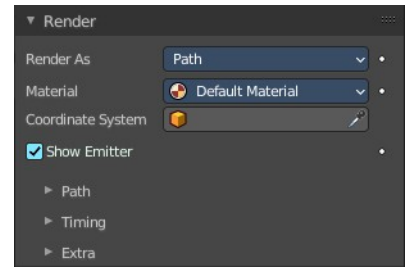

Render As

Render the particles with different methods.

All render methods

Show Emitter

Render the particle emitting mesh. This does not affect viewport rendering!

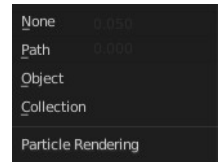

None

Don't render the particles.

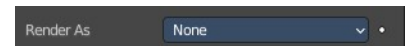

Path

Render the hair particles as paths.

Material

Set which of the object's materials is used to shade the particles.

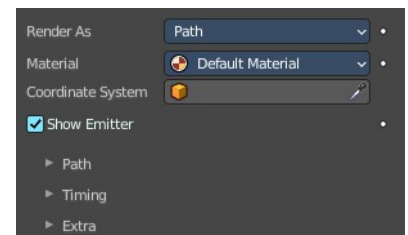

Coordinates System

Use a different object's coordinates to determine the birth of particles.

Path subpanel

B-Spline

Interpolate hair using B-splines. This may be an option for you if you want to use low Render values. You lose a bit of control but gain smoother paths.



Steps

Set the number of subdivisions of the rendered paths (the value is a power of 2). You should set this value carefully, because if you increase the render value by two you need four times more memory to render. Also the rendering is faster if you use low render values (sometimes drastically). But how low you can go with this value depends on the waviness of the hair (the value is a power of 2). This means 0 steps give 1 subdivision, 1 give 2 subdivisions, 2 → 4, 3 → 8, 4 → 16, ... n → n².

Timing subpanel

Absolute Path Time

Path timing is in absolute frames.

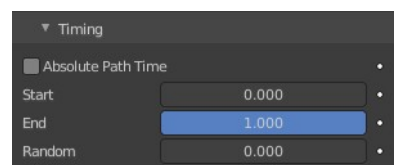

Start

Start time of the path.

End

End time of the path.

Random

Give the path length a random variation.

Extra subpanel

Parents Particles

Render also parent particles if child particles are used. Children have a lot of different deformation options, so the straight parents would stand between their curly children. So by default Parents are not rendered if you activate Children. See Children.

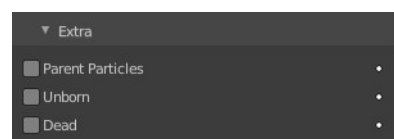

Unborn

Render particles before they are born.

Dead

Render particles after they have died. This is very useful if particles die in a collision Die on hit, so you can cover objects with particles.

Object

Render collections instead of the paths of the hair particles.

Scale

The scale factor of the object.

Scale randomness

Give the particle size a randomness.

Object Sub tab

Choose the object to render instead of the path.

Instance Object

Pick the object that you want to use as the particle.

Global Coordinates

Use the global coordinates of the object for duplication. This sets the particles to the position of the chosen object.

Object Rotation

Use the rotation of the object for duplication.

Object Scale

Use the scale of the object for duplication.

Extra sub tab

Parents Particles

Render also parent particles if child particles are used. Children have a lot of different deformation options, so the straight parents would stand between their curly children. So by default Parents are not rendered if you activate Children. See Children.

Unborn

Render particles before they are born.

Dead

Render particles after they have died. This is very useful if particles die in a collision Die on hit, so you can cover objects with particles.

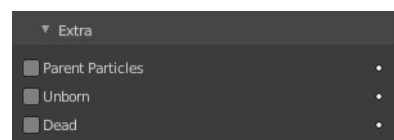
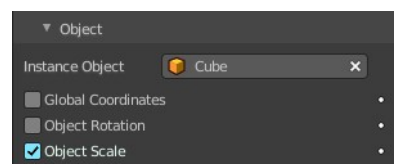
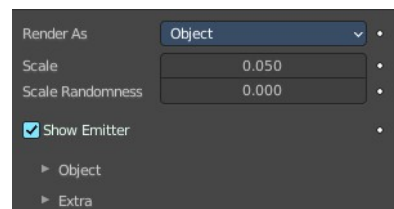

Collection

Render the content of a collection instead of the paths of the hair particles.

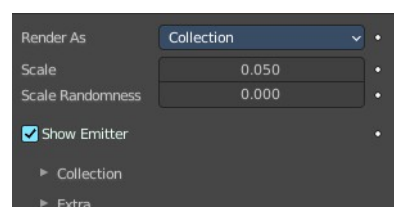

Scale

The scale factor of the object.

Scale randomness

Give the particle size a randomness.

Collection Sub tab

Choose the object to render instead of the path.

Instance Collection

Pick the collection that you want to use as the particle.

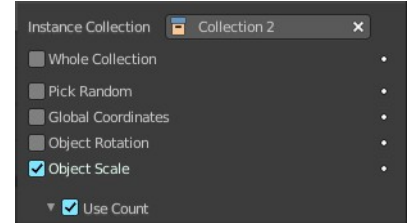

Whole collection

Use the whole collection at once.

Pick Random

Pick objects from the collection randomly.

Global Coordinates

Use the global coordinates of the object for duplication. This sets the particles to the position of the chosen object.

Object Rotation

Use the rotation of the object for duplication.

Object Scale

Use the scale of the object for duplication.

Use Count

Use objects multiple times in the collection.

Active Dupli Object Index list

The list with the objects from the collection. The number behind the object tells you how often this object is used in the particles, relative to the other objects.

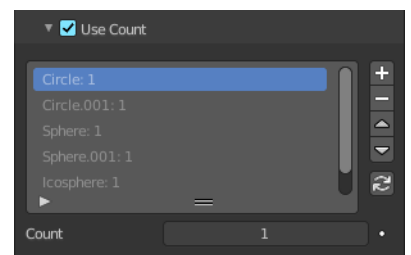

Drag Handler

The two vertical lines at the end is a handler with which you can expand the list.



Search Field

You can expand a search field at the bottom of the list. Type in your term and hit enter to filter for your term.



Invert

Exclude the search term instead of searching for it.

Sort by Name

Sort the List by name.

Revert

Revert the list. The last list item becomes the first, and vice versa.

Copy Particle Dupliobject

Duplicate the current dupli object.

Remove Particle Dupliobject

Remove the selected dupli object.

Move Up / Down Dupli Object

Move the dupli object up or down in the list.

Refresh Dupli Objects

Refresh the list of dupli objects and their weights.

Count

The number of times this object is repeated with respect to other objects.

Extra sub tab

Parents Particles

Render also parent particles if child particles are used. Children have a lot of different deformation options, so the straight parents would stand between their curly children. So by default Parents are not rendered if you activate Children. See Children.

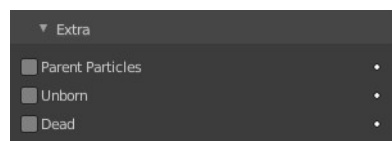

Unborn

Render particles before they are born.

Dead

Render particles after they have died. This is very useful if particles die in a collision Die on hit, so you can cover objects with particles.



26.10.14 Editors - Properties Editor - Particle Properties Tab - Hair - Viewport Display panel

Table of content

Viewport Display.....	1
Display as.....	1
None.....	1
Rendered.....	1
Point.....	2
Circle.....	2
Cross.....	2
Axis.....	2
Color.....	2
Fade Distance.....	2
Amount.....	2
Show Emitter.....	2
Size.....	2
Strand Steps.....	3

Viewport Display

How to display the particles in the 3d viewport.

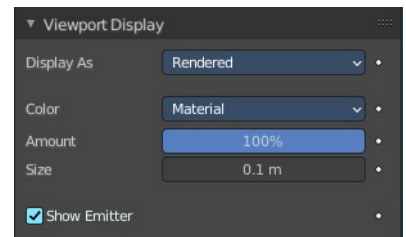

Display as

How to display the particles in the viewport.

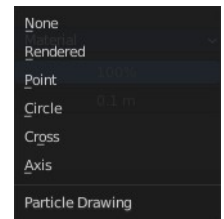

None

Don't display particles in the viewport.

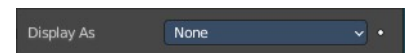

Rendered

Display the particles as rendered.

Important! These settings are dependent of the render as mode in the Render panel, and some settings just displays in the right mode.

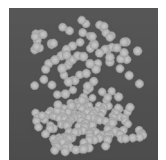

Point

Display the particles as Points.

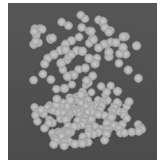

Circle

Display the particles as circles.

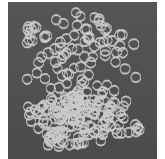

Cross

Displays each particle as a cross.

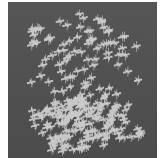

Axis

Displays each particle as an axis widget.

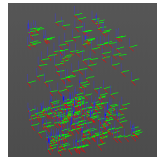

Color

What draw color to use for the particles.

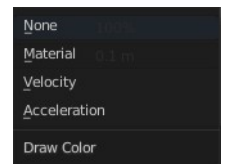

Fade Distance

With color mode Velocity and Acceleration. Maximum length of the particle color vector.

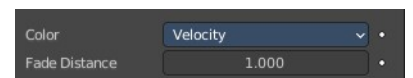

Amount

Percentage of particles to display in the 3d viewport. Choosing a display percentage lower 100 makes dynamics inaccurate without baking.

Show Emitter

Render the particle emitting mesh.

Size

Shows with render method Halo. Size of particles in viewport in Blender Units.

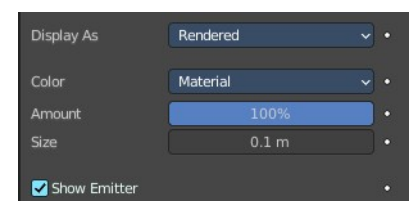
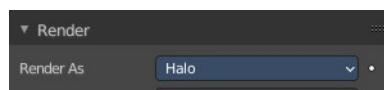

Strand Steps

Shows with render method With Path. How many steps paths are drawn with. The value needs to be a power of two.

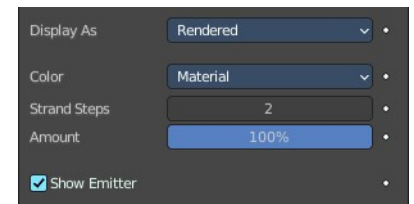
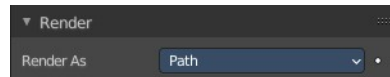



26.10.15 Editors - Properties Editor - Particle Properties Tab - Hair - Hair Shape panel

Table of content

Hair Shape panel.....	1
Strand Shape.....	1
Diameter Root.....	1
Tip.....	1
Diameter Scale.....	1
Close Tip.....	1

Hair Shape panel

These settings control the shape of hair curves for rendering.

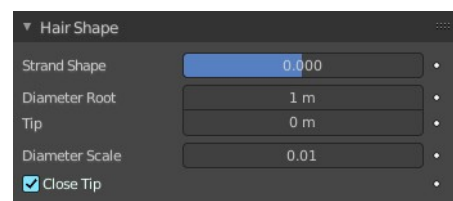

Strand Shape

A shape parameter that controls the transition in thickness between the root and tip. Negative values make the primitive rounded more towards the top, the value of zero makes the primitive linear, and positive values make the primitive rounded more towards the bottom.

Diameter Root

Multiplier of the hair width at the root.

Tip

Multiplier of the hair width at the tip.

Diameter Scale

Multiplier for the Root and Tip values. This can be used to change the thickness of the hair.

Close Tip

Sets the thickness at the tip to zero, even when using a non-zero tip multiplier.



26.10.16 Editors - Properties Editor - Particle Properties Tab - Hair - Field Weights panel

Table of content

Field weights panel.....	1
Effector Collection.....	1
Gravity.....	1
All.....	1
Force, Vortex, etc.....	1
Use For Growing Hair.....	1
Effect Children.....	1
Stiffness.....	2

Field weights panel

The Field Weight panel allows you to control how much influence each type of external force field, or effector, has on the particle system. Force fields are external forces that give dynamic system's motion.



Effector Collection

Limit effectors to a specified group. Only effectors in this group will have an effect on the current system.

Gravity

Control how much the Global Gravity has an effect on the system.

All

Scale all of the effector weights.

Force, Vortex, etc.

The influence for the single corresponding effector weights.

Use For Growing Hair

Use force fields when growing hair.

Effect Children

Apply effectors to children

Stiffness

Hair stiffness for effectors.

26.10.17 Editors - Properties Editor - Particle Properties Tab - Velocity panel

Table of content

Velocity Panel.....	1
Normal.....	1
Tangent.....	1
Tangent Phase.....	1
Object Aligned X Y Z.....	1
Object Velocity.....	1
Randomize.....	1

Velocity Panel

The initial velocity of particles can be set through different parameters, based on the type of the particle system.

Normal

The emitter's surface normals (i.e. let the surface normal give the particle a starting speed).

Tangent

Let the tangent speed give the particle a starting speed.

Tangent Phase

Rotates the surface tangent.

Object Aligned X Y Z

Give an initial velocity in the X, Y, and Z axes.

Object Velocity

Let the object give the particle a starting speed.

Randomize

Gives the starting speed a random variation.





26.10.18 Editors - Properties Editor - Particle Properties Tab - Physics panel

Table of content

Detailed table of content.....	1
Physics Panel.....	5
Physics Type.....	5
Physics Panel - Physics type None.....	5
Physics Panel - Physics type Newtonian.....	5
Mass.....	5
Multiply Mass with Size.....	5
Forces subpanel.....	5
Deflection subpanel.....	6
Integration subpanel.....	6
Physics Panel - Physics type Keyed.....	7
Mass.....	7
Multiply Mass with Size.....	7
Loops.....	7
Use Timing.....	7
Relations sub tab.....	8
Physics Panel - Physics type Boid.....	9
Mass.....	9
Multiply Mass with Size.....	9
Movement subpanel.....	9
Physics Panel - Physics type Fluid.....	16
Mass.....	16
Multiply Mass with Size.....	16
SPH Solver.....	16
Stiffness.....	16
Viscosity.....	17
Buoyancy.....	17
Forces subpanel.....	17
Deflection subpanel.....	17
Integration subpanel.....	17
Springs Subpanel.....	18
Fluid Interaction.....	19

Detailed table of content

Detailed table of content

Detailed table of content.....	1
Physics Panel.....	5
Physics Type.....	5
Physics Panel - Physics type None.....	5
Physics Panel - Physics type Newtonian.....	5
Mass.....	5
Multiply Mass with Size.....	5

Forces subpanel.....	5
Brownian.....	5
Drag.....	6
Damp.....	6
Deflection subpanel.....	6
Size Deflect.....	6
Die on Hit.....	6
Collision Collection.....	6
Integration subpanel.....	6
Integration.....	6
Euler.....	6
Verlet.....	6
Midpoint.....	6
RK4.....	7
Time step.....	7
Sub frames.....	7
Physics Panel - Physics type Keyed.....	7
Mass.....	7
Multiply Mass with Size.....	7
Loops.....	7
Use Timing.....	7
Relations sub tab.....	8
Particle Targets list.....	8
Drag Handler.....	8
Search Field.....	8
Invert.....	8
Sort by Name.....	8
New Particle Target.....	8
Move Up Target / Move Down Target.....	8
Target Object.....	8
System.....	8
Time.....	8
Duration.....	8
Physics Panel - Physics type Boid.....	9
Mass.....	9
Multiply Mass with Size.....	9
Movement subpanel.....	9
Allow Flight.....	9
Allow Land.....	9
Allow Climbing.....	9
Max Air Speed.....	9
Min Air Speed.....	10
Max Air Acceleration.....	10
Max Air Angular Velocity.....	10
Air Personal Space.....	10
Landing Smoothness.....	10
Max Land Speed.....	10
Jump Speed.....	10
Max Land Acceleration.....	10
Max Land Angular Velocity.....	10
Land Personal Space.....	10
Land Stick Force.....	10
Collision Collection.....	10

Battle subpanel.....	11
Health.....	11
Strength.....	11
Aggression.....	11
Accuracy.....	11
Range.....	11
Misc subpanel.....	11
Banking.....	11
Pitch.....	11
Height.....	11
Relations subpanel.....	11
Deflection.....	11
Force Fields.....	11
Particle Targets list.....	12
Drag Handler.....	12
Search Field.....	12
Invert.....	12
Sort by Name.....	12
New Particle Target.....	12
Move Up Target / Move Down Target.....	12
Target Object.....	12
System.....	12
Mode.....	12
Enemy.....	12
Friend.....	12
Neutral.....	13
Boid Brain subpanel.....	13
List of Rules.....	13
Search Field.....	13
Invert.....	13
Sort by Name.....	13
Add Boid Rule.....	13
All rules.....	13
Rule Evaluation.....	13
Average.....	13
Random.....	14
Fuzzy.....	14
Rule Fuzziness.....	14
In Air.....	14
On Land.....	14
Goal Boid Rule.....	14
Object.....	14
Predict.....	14
Avoid Boid Rule.....	14
Object.....	14
Predict.....	14
Fear Factor.....	14
Avoid Collision Boid Rule.....	15
Boids.....	15
Deflectors.....	15
Look Ahead.....	15
Separate Boid Rule.....	15
Flock Boid Rule.....	15

Follow Leader Boid Rule.....	15
Object.....	15
Distance.....	15
Line.....	15
Queue Size.....	15
Average Speed Boid Rule.....	15
Speed.....	15
Wander.....	15
Level.....	15
Fight Boid Rule.....	16
Fight Distance.....	16
Flee Distance.....	16
Remove Boid Rule.....	16
Move Up / Move Down Boid Rule.....	16
Physics Panel - Physics type Fluid.....	16
Mass.....	16
Multiply Mass with Size.....	16
SPH Solver.....	16
Double density.....	16
Classic.....	16
Stiffness.....	16
Viscosity.....	17
Buoyancy.....	17
Forces subpanel.....	17
Brownian.....	17
Drag.....	17
Damp.....	17
Deflection subpanel.....	17
Size Deflect.....	17
Die on Hit.....	17
Collision Collection.....	17
Integration subpanel.....	17
Integration.....	17
Euler.....	17
Verlet.....	18
Midpoint.....	18
RK4.....	18
Time step.....	18
Sub frames.....	18
Springs Subpanel.....	18
Force.....	18
Viscoelastic Springs.....	18
Elastic Limit.....	18
Plasticity.....	18
Initial Rest Length.....	18
Frames.....	19
Advanced.....	19
Rest Length.....	19
Factor Rest Length.....	19
Fluid Interaction.....	19
Particle Targets list.....	19
Search Field.....	19
Invert.....	19

Sort by Name.....19
Target Object.....19
System.....19

Physics Panel

The movement of particles can be controlled and influenced in various ways. Physics is one of it.

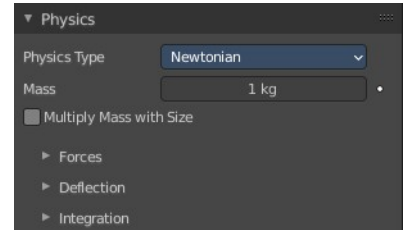

Physics Type

The kind of physics to influence the particles.

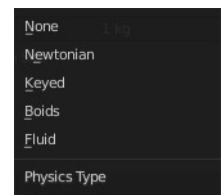

Physics Panel - Physics type None

The particles are created, and remains at their creation point.

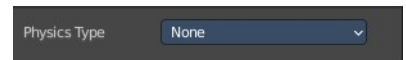

This physics type does not have further settings.

Physics Panel - Physics type Newtonian

Particles are influenced by gravity.

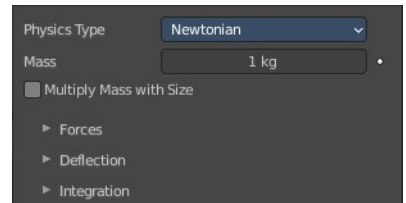

Mass

Specify the mass of the particles.

Multiply Mass with Size

Causes larger particles to have larger masses.

Forces subpanel

Brownian

Specify the amount of Brownian motion. Brownian motion adds random motion to the particles based on a Brownian noise field.

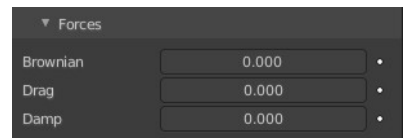

Drag

A force that reduces particle velocity in relation to its speed and size (useful in order to simulate air drag or water drag).

Damp

Reduces particle velocity (deceleration, friction, dampening).

Deflection subpanel

Size Deflect

Use the particle size in deflections.

Die on Hit

Kill particle when it hits a deflector object.

Collision Collection

If set, particles collide with objects from the collection.

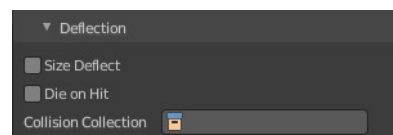

Integration subpanel

Integrators are a set of mathematical methods available to calculate the movement of particles. The following guidelines will help to choose a proper integrator, according to the behavior aimed at by the animator.

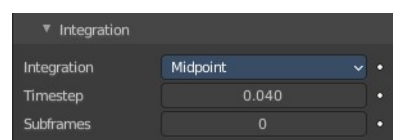

Integration

Euler

Also known as “Forward Euler”. Simplest integrator. Very fast but also with less exact results. If no dampening is used, particles get more and more energy over time. For example, bouncing particles will bounce higher and higher each time. Should not be confused with “Backward Euler” (not implemented) which has the opposite feature, the energy decrease over time, even with no dampening. Use this integrator for short simulations or simulations with a lot of dampening where speedy calculations are more important than accuracy.

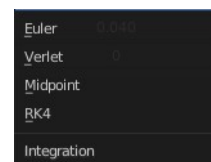

Verlet

Very fast and stable integrator, energy is conserved over time with very little numerical dissipation.

Midpoint

Also known as “2nd order Runge-Kutta”. Slower than Euler but much more stable. If the acceleration is constant (no drag for example), it is energy conservative. It should be noted that in example of the bouncing particles, the particles might bounce higher than they started once in a while, but this is not a trend. This integrator is a generally good integrator for use in most cases.

RK4

Short for “4th order Runge-Kutta”. Similar to Midpoint but slower and in most cases more accurate. It is energy conservative even if the acceleration is not constant. Only needed in complex simulations where Midpoint is found not to be accurate enough.

Time step

The amount of simulation time (in seconds) that passes during each frame.

Sub frames

The number of simulation steps per frame. Sub frames to simulate for improved stability and finer granularity in simulations. Use higher values for faster-moving particles.

Physics Panel - Physics type Keyed

The path of Keyed particles is determined between particles of any two (or more) particle systems. This allows the creation of a chains of systems to create long strands or groovy moving particles. Basically the particles have no dynamics but are interpolated from one system to the next each frame.

To setup Keyed particles you need at least two particle systems in the Keys list.

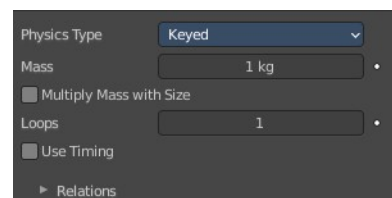

Mass

Specify the mass of the particles.

Multiply Mass with Size

Causes larger particles to have larger masses.

Loops

Sets the number of times the entire Keys list is repeated. Disabled if Use Timing is enabled.

Use Timing

Specify the timing for each key independently, using the Time and Duration options. By default, the Use Timing option is deactivated, and the particles will pass through all keys for a time equal to its lifetime. A shorter lifetime means faster movement. The lifetime will be split equally between the keys, this may lead to varying particle speeds between the targets.

Relations sub tab

Particle Targets list

A list of the available particle systems. You need at least two.

Drag Handler

The two vertical lines at the end is a handler with which you can expand the list.

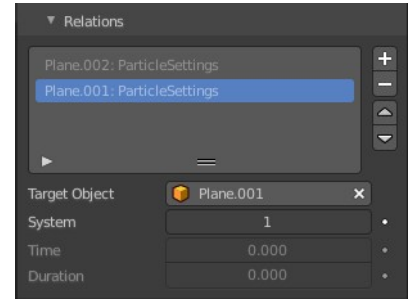

Search Field

You can expand a search field at the bottom of the list. Type in your term and hit enter to filter for your term.

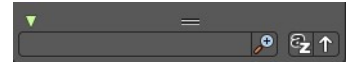

Invert

Exclude the search term instead of searching for it.

Sort by Name

Sort the List by name.

New Particle Target

Add a particle target. You need to specify the object that contains the particle system, which can be done below. Empty particle targets are marked as Invalid target!

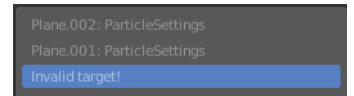

Move Up Target / Move Down Target

Move the selected particle target up or down in the list.

Target Object

Choose the target object that contains the particle system.

System

The index of the particle system on the target object.

Time

Becomes active when Use Timing is activated. The start time.

Duration

Becomes active when Use Timing is activated. The duration.

Physics Panel - Physics type Boid

Boids particle systems are controlled by a limited artificial intelligence, which can be programmed to follow basic rules and behaviors. They are ideal for simulating flocks, swarms, herds and schools of various kind of animals, insects and fishes or predators vs. preys simulations. They can react on the presence of other objects and on the members of their own system. Boids can handle only a certain amount of information, therefore the sequence of the Boid Brain rules is very important. In certain situations only the first three parameter are evaluated.

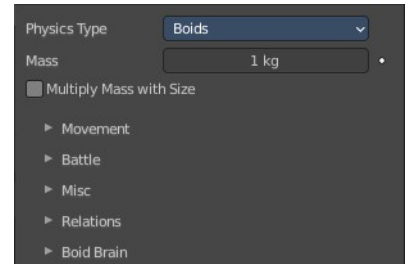

Mass

Specify the mass of the particles.

Multiply Mass with Size

Causes larger particles to have larger masses.

Movement subpanel

Boids try to avoid objects with activated Collision. They try to reach goal objects, and fly from “predators” according to the Boid Brain settings.

Boids can have different physics depending on whether they are in the air, or on land (on collision object).

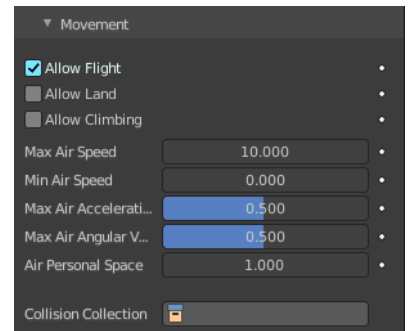

Allow Flight

Allow boids to move in the air.

Allow Land

Allow boids to move on land. Activating this setting will reveal further sliders.

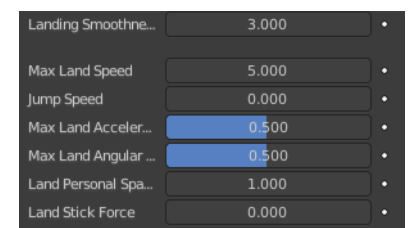

Allow Climbing

Allow boids to climb goal objects.

Max Air Speed

Set the Maximum velocity in the air.

Min Air Speed

Set the Minimum velocity in the air.

Max Air Acceleration

Lateral acceleration in air, percentage of the max velocity (turn). Defines how fast a boid is able to change direction.

Max Air Angular Velocity

Tangential acceleration in air, percent 180 degrees. Defines how much the boid can suddenly accelerate in order to fulfill a rule.

Air Personal Space

Radius of boids personal space in air. Percentage of particle size.

Landing Smoothness

How smoothly the boids land.

Max Land Speed

Set the Maximum velocity on land.

Jump Speed

Maximum speed for jumping.

Max Land Acceleration

Lateral acceleration on land, percent of max velocity (turn). Defines how fast a boid is able to change direction.

Max Land Angular Velocity

Tangential acceleration on land, percent 180 degrees. Defines how much the boid can suddenly accelerate in order to fulfill a rule.

Land Personal Space

Radius of boids personal space on land. Percentage of particle size.

Land Stick Force

How strong a force must be to start effecting a boid on land.

Collision Collection

Only collide with objects in this collection.

Battle subpanel

Health

Initial boid health when born.

Strength

Maximum caused damage per second on attack.

Aggression

Boid will fight this time stronger than enemy.

Accuracy

Accuracy of attack.

Range

Maximum distance of which a boid can attack.



Misc subpanel

Banking

Amount of rotation around velocity vector on turns. Banking of 1.0 gives a natural banking effect.

Pitch

Amount of rotation around side vector.

Height

Boid height relative to particle size.

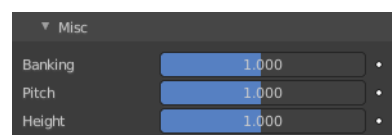

Relations subpanel

Boid particles can react with other particle systems. This list allows you to select other objects with their particle systems.

Deflection

Boids will try to avoid deflector objects according to the Collision rule's weight. It works best for convex surfaces (some work needed for concave surfaces).

Force Fields

As other physics types, Boids is also influenced by external force fields.

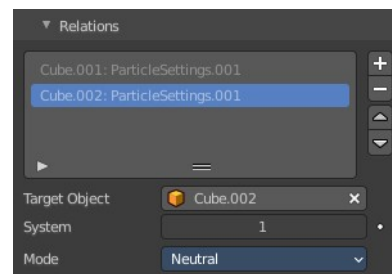

In addition, special Boid force fields can be used with the Boids physics. These effectors could be predators (positive Strength) that boids try to avoid, or targets (negative Strength) that boids try to reach according to the (respectively) Avoid and Goal rules of the Boid Brain.

Particle Targets list

A list of the available particle systems.

Drag Handler

The two vertical lines at the end is a handler with which you can expand the list.

Search Field

You can expand a search field at the bottom of the list. Type in your term and hit enter to filter for your term.



Invert

Exclude the search term instead of searching for it.

Sort by Name

Sort the List by name.

New Particle Target

Add a particle target. You need to specify the object that contains the particle system, which can be done below. Empty particle targets are marked as Invalid target!

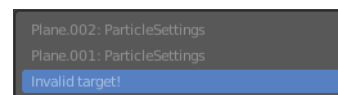

Move Up Target / Move Down Target

Move the selected particle target up or down in the list.

Target Object

Choose the target object that contains the particle system.

System

Index of the Object's particle system as set in the list view in the particle panel.

Mode

Enemy

Setting the type to Enemy will cause the systems to fight with each other.

Friend

Will make the systems work together.

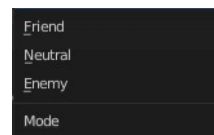

Neutral

Will not cause them to align or fight with each other.

Boid Brain subpanel

The Boid Brain panel controls how the boids particles will react with each other. The boids' behavior is controlled by a list of rules. Only a certain amount of information in the list can be evaluated. If the memory capacity is exceeded, the remaining rules are ignored.

The rules are by default parsed from top-list to bottom-list (thus giving explicit priorities), and the order can be modified using the little arrows buttons on the right side.

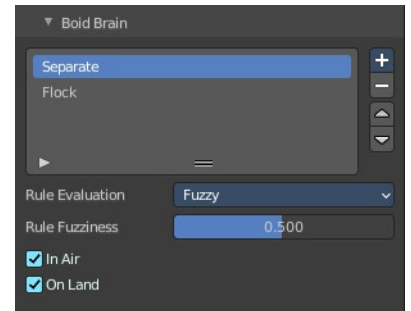

List of Rules

The list of the current rules.

Search Field

You can expand a search field at the bottom of the list. Type in your term and hit enter to filter for your term.



Invert

Exclude the search term instead of searching for it.

Sort by Name

Sort the List by name.

Add Boid Rule

A list of the available boid rules. Each rule has different settings.

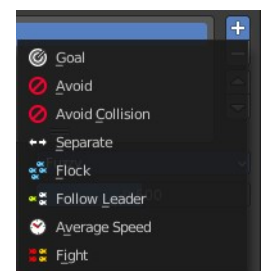

All rules

Rule Evaluation

There are three ways to control how rules are evaluated:

Average

All rules are averaged.

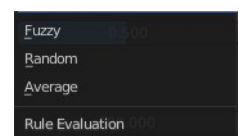

Random

A random rule is selected for each boid.

Fuzzy

Uses fuzzy logic to evaluate rules. Rules are gone through top to bottom. Only the first rule that affect above the Rule Fuzziness threshold is evaluated. The value should be considered how hard the boid will try to respect a given rule (a value of 1 means the Boid will always stick to it, a value of 0 means it will never). If the boid meets more than one conflicting condition at the same time, it will try to fulfill all the rules according to the respective weight of each.

Note! A given boid will try as much as it can to comply to each of the rules it is given, but it is more than likely that some rule will take precedence on other in some cases. For example, in order to avoid a predator, a boid could probably “forget” about Collision, Separate and Flock rules, meaning that “while panicked” it could well run into obstacles, e.g. even if instructed not to, most of the time.

Rule Fuzziness

The fuzziness for the rule evaluation method Fuzzy.

In Air

The current rule affects boids while they are flying.

On Land

The current rule affects boids while they are not flying.

Goal Boid Rule

Seek the goal.



Object

Specifies the goal object. If not specified, Boid force fields with negative Strength are used as goals.

Predict

Predict target’s movements.

Avoid Boid Rule

Avoid “predators”.



Object

Specifies the object to avoid. If not specified, Boid force fields with positive Strength are used as predators.

Predict

Predict target’s movements.

Fear Factor

Avoid object if danger from it is above this threshold.

Avoid Collision Boid Rule

Avoid objects with activated Deflection.



Boids

Avoid collision with other boids.

Deflectors

Avoid collision with deflector objects.

Look Ahead

Time to look ahead in seconds.

Separate Boid Rule

Boids move away from each other.

Flock Boid Rule

Copy movements of neighboring boids, but avoid each other.

Follow Leader Boid Rule

Follows a leader object instead of a boid.

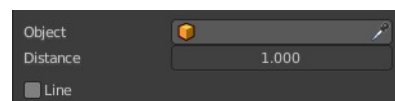

Object

Pick the leader object.

Distance

Distance behind leader to follow.

Line

Follow the leader in a line.

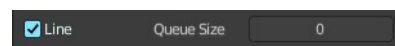

Queue Size

How many boids that are allowed to follow in a line.

Average Speed Boid Rule

Maintain average velocity.



Speed

Percentage of maximum speed.

Wander

How fast velocity's direction is randomized.

Level

How much velocity's Z component is kept constant.

Fight Boid Rule

Move toward nearby boids.

Fight Distance	100.000
Flee Distance	100.000

Fight Distance

Attack boids at a maximum of this distance.

Flee Distance

Flee to this distance.

Remove Boid Rule

Remove the boid rule from the list.

Move Up / Move Down Boid Rule

Move the boid rule up or down the list.

Physics Panel - Physics type Fluid

Fluid particles are similar to Newtonian particles. But the particles are influenced by internal forces like pressure, surface tension, viscosity, springs, etc. The range goes from liquids to slime, goo to sand and wispy.

Mass

Specify the mass of the particles.

Multiply Mass with Size

Causes larger particles to have larger masses.

SPH Solver

Smoothed-particle hydrodynamics (SPH) is a computational method used for simulating fluid flows. It is a mesh-free Lagrangian method where the coordinates move with the fluid.

Double density

An artistic solver with strong surface tension effects. Reveals the Spring sub panel.

Classic

A more physically accurate solver.

Stiffness

How incompressible the fluid is.

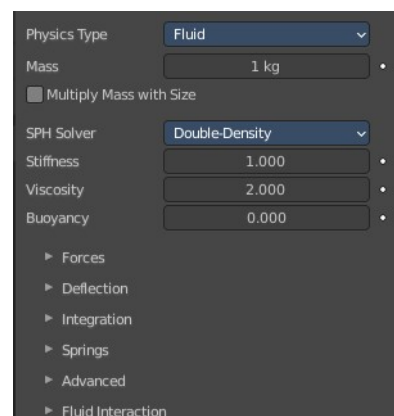

Viscosity

Linear viscosity. Use lower viscosity for thicker fluids.

Buoyancy

Artificial buoyancy force in negative gravity direction based on pressure differences inside the fluid.

Forces subpanel

Brownian

Specify the amount of Brownian motion. Brownian motion adds random motion to the particles based on a Brownian noise field.

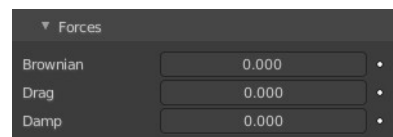

Drag

A force that reduces particle velocity in relation to its speed and size (useful in order to simulate air drag or water drag).

Damp

Reduces particle velocity (deceleration, friction, dampening).

Deflection subpanel

Size Deflect

Use the particle size in deflections.

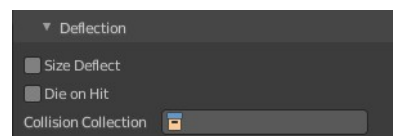

Die on Hit

Kill particle when it hits a deflector object.

Collision Collection

If set, particles collide with objects from the collection.

Integration subpanel

Integrators are a set of mathematical methods available to calculate the movement of particles. The following guidelines will help to choose a proper integrator, according to the behavior aimed at by the animator.

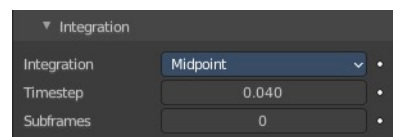

Integration

Euler

Also known as “Forward Euler”. Simplest integrator. Very fast but also with less exact results. If no dampening is used, particles get more and more energy over time. For example, bouncing particles will bounce higher and higher each time. Should not be confused with “Backward Euler”

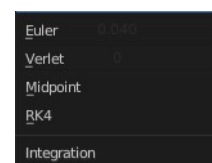

(not implemented) which has the opposite feature, the energy decrease over time, even with no dampening. Use this integrator for short simulations or simulations with a lot of dampening where speedy calculations are more important than accuracy.

Verlet

Very fast and stable integrator, energy is conserved over time with very little numerical dissipation.

Midpoint

Also known as “2nd order Runge-Kutta”. Slower than Euler but much more stable. If the acceleration is constant (no drag for example), it is energy conservative. It should be noted that in example of the bouncing particles, the particles might bounce higher than they started once in a while, but this is not a trend. This integrator is a generally good integrator for use in most cases.

RK4

Short for “4th order Runge-Kutta”. Similar to Midpoint but slower and in most cases more accurate. It is energy conservative even if the acceleration is not constant. Only needed in complex simulations where Midpoint is found not to be accurate enough.

Time step

The amount of simulation time (in seconds) that passes during each frame.

Sub frames

The number of simulation steps per frame. Sub frames to simulate for improved stability and finer granularity in simulations. Use higher values for faster-moving particles.

Springs Subpanel

Force

Spring force.

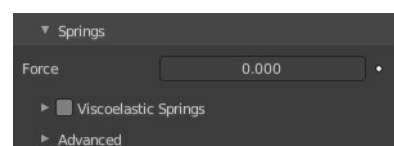

Viscoelastic Springs

Use viscoelastic springs instead of Hooke’s springs.

Elastic Limit

How much the spring has to be stretched/compressed in order to change its rest length.

Plasticity

How much the spring rest length can change after the elastic limit is crossed.

Initial Rest Length

Use initial length as spring rest length instead of $2 \times$ particle size.

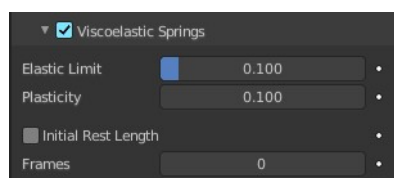

Frames

Create springs for this number of frames since particle's birth (0 is always).

Advanced

Rest Length

Rest length of springs. Factor of particle radius. Checkbox sets this to be a factor of $2 \times$ particle size.

Factor Rest Length

Spring rest length is a factor of $2 \times$ particle size.

Fluid Interaction

Add a particle system to interact with the fluid.

Particle Targets list

A list of the available particle systems.

Search Field

You can expand a search field at the bottom of the list. Type in your term and hit enter to filter for your term.

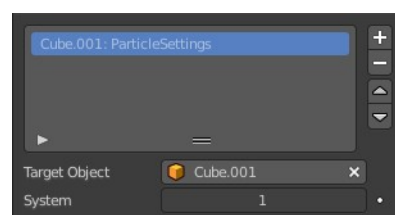

Invert

Exclude the search term instead of searching for it.

Sort by Name

Sort the List by name.

Target Object

Choose the target object that contains the particle system.

System

The index of the particle system on the target object.





26.10.19 Editors - Properties Editor - Particle Properties Tab - Children panel

Table of content

Detailed table of content.....	1
Children panel.....	5
Children panel - Type None.....	5
Child Type.....	5
Children panel - Type Simple.....	5
Children panel - Type Simple - Clumping subpanel.....	6
Use Clump Curve.....	6
Clump.....	7
Shape.....	8
Twist.....	8
Use Twist Curve.....	8
Clump Noise.....	8
Children panel - Type Simple + Interpolated - Roughness subpanel.....	8
Use Roughness Curve.....	8
Roughness.....	10
Size.....	10
Uniform, Size.....	10
Endpoint, Shape.....	10
Random, Size, Threshold.....	10
Children panel - Type Simple + Interpolated - Kink subpanel.....	10
Kink Type.....	10
Children panel - Type Interpolated.....	12
Display Amount.....	12
Render Amount.....	12
Length.....	12
Threshold.....	12
Seed.....	12
Virtual Parents.....	12
Long Hair.....	12
Children panel - Type Interpolated - Parting subpanel.....	13
Parting.....	13
Min.....	13
Max.....	13
Children panel - Type Interpolated - Clumping subpanel.....	13
Use Clump Curve.....	13
Clump.....	14
Shape.....	15
Clump Noise.....	15

Detailed table of content

Detailed table of content

Detailed table of content.....	1
--------------------------------	---

Children panel.....	5
Children panel - Type None.....	5
Child Type.....	5
None.....	5
Children panel - Type Simple.....	5
Simple.....	5
Display Amount.....	5
Render Amount.....	5
Length.....	5
Threshold.....	5
Seed.....	5
Size.....	5
Random Size.....	6
Radius.....	6
Roundness.....	6
Children panel - Type Simple - Clumping subpanel.....	6
Use Clump Curve.....	6
Selecting Points.....	6
Adding Points.....	6
Navigation elements.....	7
Zoom in and out.....	7
Tools.....	7
Reset View.....	7
Vector Handle.....	7
Auto Handle.....	7
Extend horizontal.....	7
Extend vertical.....	7
Auto Clamped Handle.....	7
Reset Curve.....	7
Use Clipping.....	7
Delete Points.....	7
Clump.....	7
Shape.....	8
Twist.....	8
Use Twist Curve.....	8
Clump Noise.....	8
Clump Noise Size.....	8
Children panel - Type Simple + Interpolated - Roughness subpanel.....	8
Use Roughness Curve.....	8
Selecting Points.....	9
Adding Points.....	9
Navigation elements.....	9
Zoom in and out.....	9
Tools.....	9
Reset View.....	9
Vector Handle.....	9
Auto Handle.....	9
Extend horizontal.....	9
Extend vertical.....	9
Auto Clamped Handle.....	9
Reset Curve.....	10
Use Clipping.....	10
Delete Points.....	10

Roughness.....	10
Size.....	10
Uniform, Size.....	10
Endpoint, Shape.....	10
Random, Size, Threshold.....	10
Children panel - Type Simple + Interpolated - Kink subpanel.....	10
Kink Type.....	10
Nothing.....	10
Curl, Radial, Wave, Braid.....	11
Amplitude.....	11
Clump.....	11
Flatness.....	11
Frequency.....	11
Shape.....	11
Spiral.....	11
Amplitude.....	11
Randomize Amplitude.....	11
Axis.....	11
Randomize Axis.....	11
Frequency.....	11
Shape.....	12
Steps.....	12
Children panel - Type Interpolated.....	12
Display Amount.....	12
Render Amount.....	12
Length.....	12
Threshold.....	12
Seed.....	12
Virtual Parents.....	12
Long Hair.....	12
Children panel - Type Interpolated - Parting subpanel.....	13
Parting.....	13
Min.....	13
Max.....	13
Children panel - Type Interpolated - Clumping subpanel.....	13
Use Clump Curve.....	13
Selecting Points.....	13
Adding Points.....	13
Navigation elements.....	14
Zoom in and out.....	14
Tools.....	14
Reset View.....	14
Vector Handle.....	14
Auto Handle.....	14
Extend horizontal.....	14
Extend vertical.....	14
Auto Clamped Handle.....	14
Reset Curve.....	14
Use Clipping.....	14
Delete Points.....	14
Clump.....	14
Shape.....	15
Clump Noise.....	15

Clump Noise Size.....15

Children panel

Children are Hair or Emitter particles originating from individual particles. They allow to work with a relatively low amount of Parent particles. Which reduces the calculation effort.

If you activate children, then the parents are no longer rendered. They can be re-enabled in the Render panel in the Extras subpanel. Parent Particles. By default, parent particles are not rendered because the shape of the children can be quite different from that of their parents.

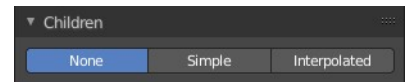

Children panel - Type None

Child Type

None

No children are generated. No settings.

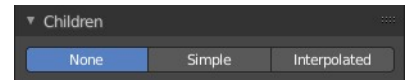

Children panel - Type Simple

Simple

Children are emitted from the parent position.

Display Amount

The number of children in the 3D Viewport.

Render Amount

The number of children to be rendered.

Length

Length of child paths.

Threshold

Amount of particles left untouched by child path length.

Seed

Offset in the random number table for child particles, to get a different randomized result.

Size

A multiplier for children size.

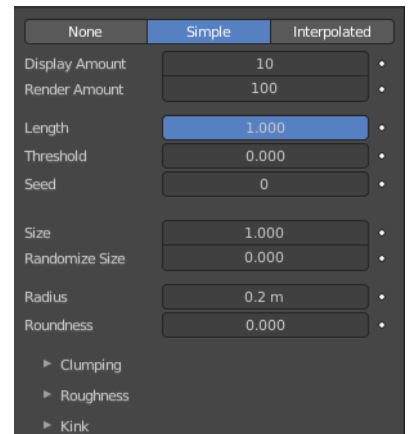

Random Size

Random variation to the size of child particles

Radius

The radius in which the children are distributed around their parents. This is 3D, so children may be emitted higher or lower than their parents.

Roundness

The roundness of the children around their parents. Either in a sphere (1.0) or in-plane (0.0).

Children panel - Type Simple - Clumping subpanel

Clumping allows as the name says to break the even look, and clump particles together.

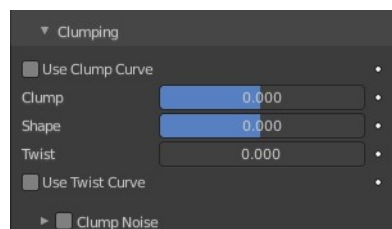

Use Clump Curve

Use a Curve instead of parameters to adjust the clumping.

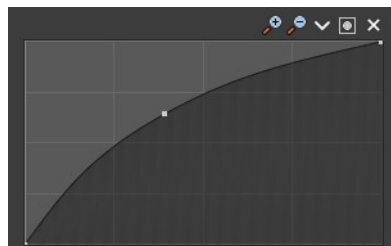

Selecting Points

You can select curve points. This reveals two edit boxes for the x and y coordinate of this point.

Selected points can be moved around. Left click at them, hold the mouse button down and move them to a new location.

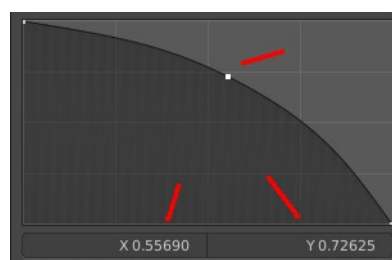

Adding Points

You can add new curve points by simply left clicking at the curve. Move the mouse to position them where you need it.

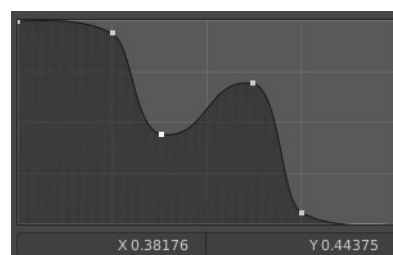

Navigation elements

The navigation elements at the top are described from left to right.



Zoom in and out

The two buttons with the magnifying glass at it zooms in and out in the curve window.

Tools

Tools is a menu where you can find some curve related tools.

Reset View

Resets the curve windows zoom.

Vector Handle

Set handle type to Vector.

Auto Handle

Set handle type to Auto.

Extend horizontal

Extend the curve horizontally before the first and after the last curve point.

Extend vertical

Extend the curve vertically before the first and after the last curve point.

Auto Clamped Handle

Set handle type to Auto Clamped.

Reset Curve

Resets the curve to the initial shape.

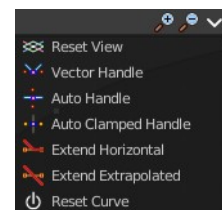

Use Clipping

Clipping options. Set up clipping for the stroke.

Delete Points

Deletes selected curve points.

Clump

Clumping amount along child strands. The children may meet at their tip (1.0) or start together at their root (-1.0).

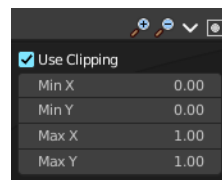

Shape

Form of Clump. Either inverse parabolic (0.99) or exponentially (-0.99).

Twist

Number of turn around parent along the strand.

Use Twist Curve

Use a Curve instead of parameters to adjust the twisting of the particles.

For controls see above, clump curve.

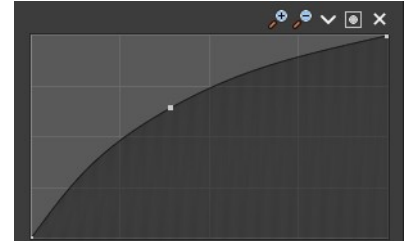

Clump Noise

Creates random clumps around the parent hair.



Clump Noise Size

The size of clump noise.

Children panel - Type Simple + Interpolated - Roughness sub-panel

Give the particles a roughness.

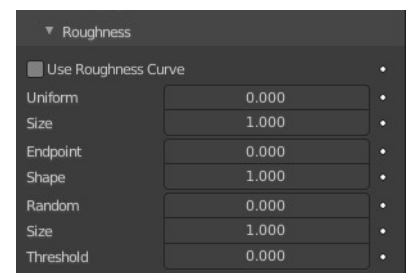

Use Roughness Curve

Use Curve Widget instead of parameters.

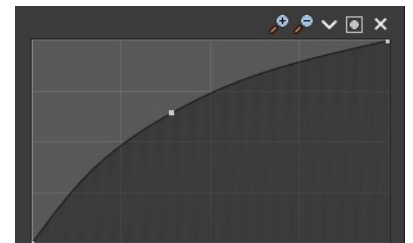

Selecting Points

You can select curve points. This reveals two edit boxes for the x and y coordinate of this point.

Selected points can be moved around. Left click at them, hold the mouse button down and move them to a new location.

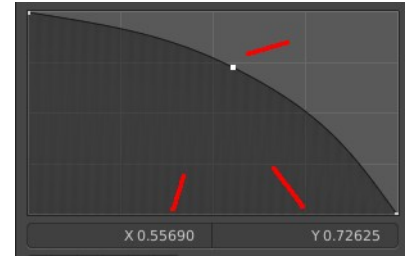

Adding Points

You can add new curve points by simply left clicking at the curve. Move the mouse to position them where you need it.

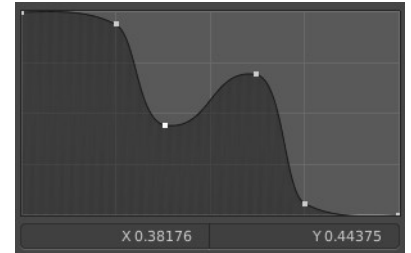

Navigation elements

The navigation elements at the top are described from left to right.

Zoom in and out

The two buttons with the magnifying glass at it zooms in and out in the curve window.



Tools

Tools is a menu where you can find some curve related tools.

Reset View

Resets the curve windows zoom.

Vector Handle

Set handle type to Vector.

Auto Handle

Set handle type to Auto.

Extend horizontal

Extend the curve horizontally before the first and after the last curve point.

Extend vertical

Extend the curve vertically before the first and after the last curve point.

Auto Clamped Handle

Set handle type to Auto Clamped.

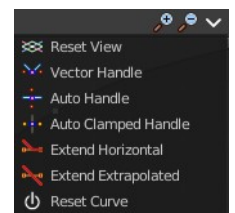

Reset Curve

Resets the curve to the initial shape.

Use Clipping

Clipping options. Set up clipping for the stroke.

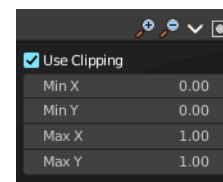

Delete Points

Deletes selected curve points.

Roughness

Amount of location dependent roughness.

Size

Size of location dependent roughness.

Uniform, Size

It is based on children location so it varies the paths in a similar way when the children are near.

Endpoint, Shape

“Rough End” randomizes path ends (a bit like random negative clumping). Shape may be varied from <1 (parabolic) to 10.0 (hyperbolic).

Random, Size, Threshold

It is based on a random vector so it is not the same for nearby children. The threshold can be specified to apply this to only a part of children. This is useful for creating a few stray children that will not do what others do.

Children panel - Type Simple + Interpolated - Kink subpanel

With Kink you can rotate the children around the parent.

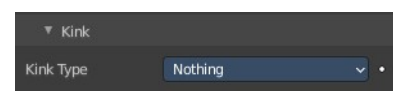

Kink Type

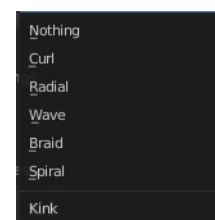

Nothing

Deactivated.

Curl, Radial, Wave, Braid

Curl - Children grow in a spiral around the parent hairs.

Radial - Children form around the parent a wave shape that passes through the parent hair.

Wave - Children form a wave, all in the same direction.

Braid - Children braid themselves around the parent hair.

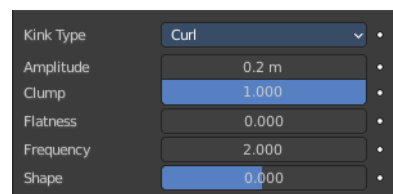

Amplitude

The amplitude of the offset.

Clump

How much clump effects kink amplitude.

Flatness

How flat the hairs are.

Frequency

The frequency of the offset (1/total length). The higher the frequency the more rotations are done.

Shape

Where the rotation starts (offset of rotation).

Spiral

Generates a spiral at the end of each hair.

Amplitude

The amplitude of the offset.

Randomize Amplitude

Give the amplitude a random variation.

Axis

Which axis to use for offset.

Randomize Axis

Randomize the orientation.

Frequency

The frequency of the offset (1/total length). The higher the frequency the more rotations are done.

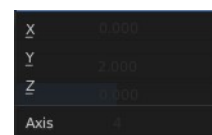
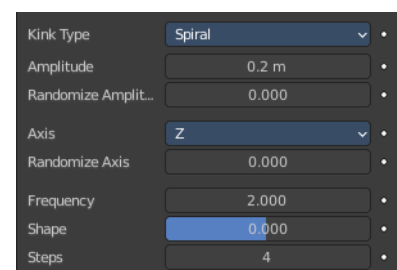

Shape

Where the rotation starts (offset of rotation).

Steps

Extra steps for resolution of special kink features.

Children panel - Type Interpolated

Children are emitted between the Parent particles on the faces of a mesh. They interpolate between adjacent parents. This is especially useful for fur, because you can achieve an even distribution. Some of the children can become virtual parents, which are influencing other particles nearby.

Display Amount

The number of children in the 3D Viewport.

Render Amount

The number of children to be rendered.

Length

Length of child paths.

Threshold

Amount of particles left untouched by child path length.

Seed

Offset in the random number table for child particles, to get a different randomized result.

Virtual Parents

Relative Amount of virtual parents.

Long Hair

Belongs to Hair particles. Calculate children that suit long hair well.

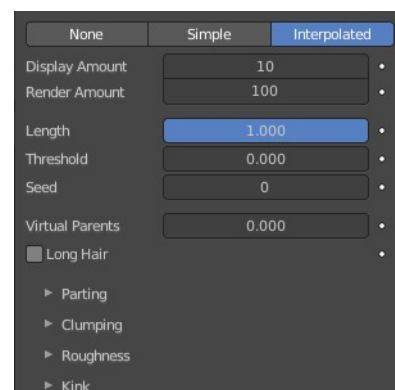

Children panel - Type Interpolated - Parting subpanel

This panel belongs to Hair particles.

Parting

Creates parting in the children based on parent strands.

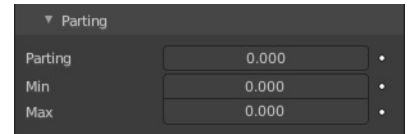

Min

Minimum root to tip angle. Tip distance / root distance for long hair.

Max

Maximum root to tip angle. Tip distance / root distance for long hair.

Children panel - Type Interpolated - Clumping subpanel

Clumping allows as the name says to break the even look, and clump particles together.

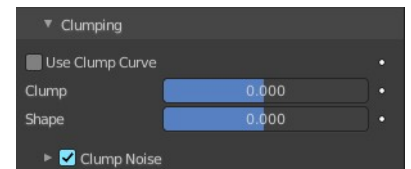

Use Clump Curve

Use a Curve instead of parameters to adjust the clumping.

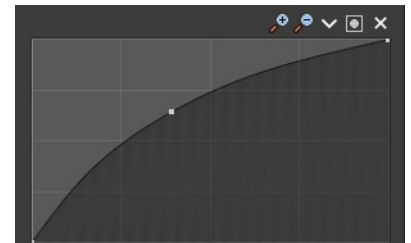

Selecting Points

You can select curve points. This reveals two edit boxes for the x and y coordinate of this point.

Selected points can be moved around. Left click at them, hold the mouse button down and move them to a new location.

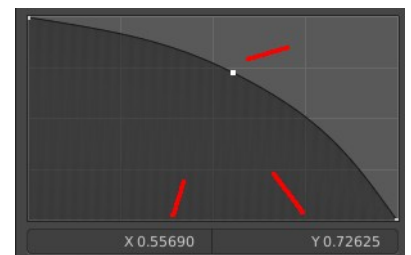

Adding Points

You can add new curve points by simply left clicking at the curve. Move the mouse to position them where you need it.

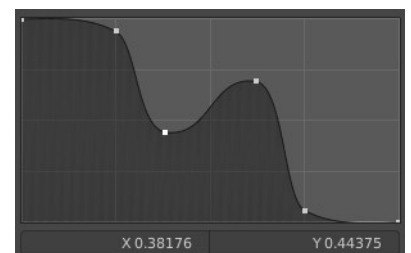

Navigation elements

The navigation elements at the top are described from left to right.



Zoom in and out

The two buttons with the magnifying glass at it zooms in and out in the curve window.

Tools

Tools is a menu where you can find some curve related tools.

Reset View

Resets the curve windows zoom.

Vector Handle

Set handle type to Vector.

Auto Handle

Set handle type to Auto.

Extend horizontal

Extend the curve horizontally before the first and after the last curve point.

Extend vertical

Extend the curve vertically before the first and after the last curve point.

Auto Clamped Handle

Set handle type to Auto Clamped.

Reset Curve

Resets the curve to the initial shape.

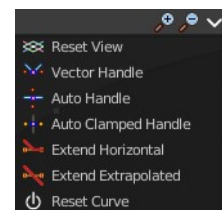

Use Clipping

Clipping options. Set up clipping for the stroke.

Delete Points

Deletes selected curve points.

Clump

Clumping amount along child strands. The children may meet at their tip (1.0) or start together at their root (-1.0).

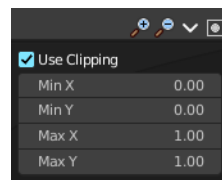

Shape

Form of Clump. Either inverse parabolic (0.99) or exponentially (-0.99).

Clump Noise

Creates random clumps around the parent hair.

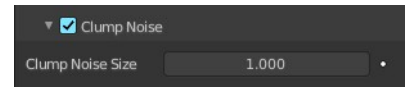

Clump Noise Size

The size of clump noise.



26.10.2 Editors - Properties Editor - Particle Properties Tab - Emitter - Emission Panel

Table of content

Emission Panel.....	1
Number.....	1
Seed.....	1
Frame Start.....	1
End.....	2
Lifetime.....	2
Lifetime Randomness.....	2
Source.....	2
Emit From.....	2
Vertices.....	2
Use Modifier Stack.....	2
Random Order.....	2
Faces & Volume.....	2
Use Modifier Stack.....	3
Distribution.....	3
Jittered.....	3
Random Order.....	3
Even Distribution.....	3
Particles/Face.....	3
Jittering Amount.....	3
Random.....	3
Random Order.....	3
Even Distribution.....	3
Grid.....	3
Invert Grid.....	3
Hexagonal Grid.....	3
Resolution.....	3
Random.....	3

Emission Panel

The buttons in the Emission panel control the way particles are emitted over time.

Number

The maximum amount of parent particles used in the simulation.

Seed

Blender uses this as starting point to produce random numbers during the simulation.

Frame Start

The start frame of particle emission. You may set negative values, which enables you to start the simulation be-

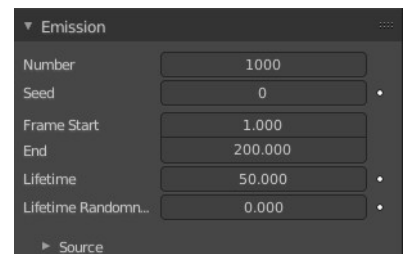

fore the actual rendering.

End

The end frame of particle emission.

Lifetime

The lifespan (in frames) of the particles.

Lifetime Randomness

A random variation of the lifetime of a given particle. The shortest possible lifetime is $\text{Lifetime} \times (1 - \text{Random})$. Values above 1.0 are not allowed. For example with the default Lifetime value of 50 a Random setting of 0.5 will give you particles with a live span ranging from 50 frames to $50 \times (1.0 - 0.5) = 25$ frames, and with a Random setting of 0.75 you will get particles with live spans ranging from 50 frames to $50 \times (1.0 - 0.75) = 12.5$ frames.

Source

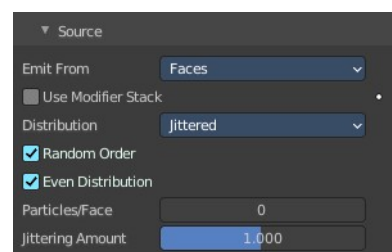

Emit From

Defines how and where the particles are emitted, giving precise control over their distribution. Defines also what content is displayed in the source sub panel.

Tip! You may use vertex groups to confine the emission, that is done in the Vertex Groups panel.

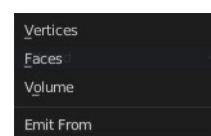

Vertices

Emits particles from the vertices of a mesh.

Use Modifier Stack

Take any Modifiers above the Particle Modifier in the modifier stack into account when emitting particles, else it uses the original mesh geometry.

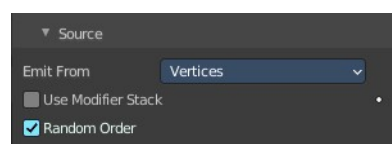

Random Order

The emitter element indices are gone through in a random order instead of linearly (one after the other).

Faces & Volume

Faces emits particles from the surface of a mesh's faces.

Volume emits particles from the volume of an enclosed mesh. Your mesh must be manifold to emit particles from the volume. Some modifiers like the Edge Split Modifier break up the surface, in which case volume emission will not work correctly!

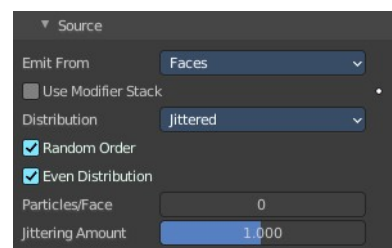

Use Modifier Stack

Take any Modifiers above the Particle Modifier in the modifier stack into account when emitting particles, else it uses the original mesh geometry.

Distribution

These settings control how the emissions of particles are distributed throughout the emission locations when emitting from either Faces or Volume.

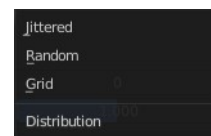

Jittered

Random Order

The emitter element indices are gone through in a random order instead of linearly (one after the other).

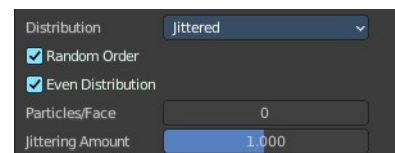

Even Distribution

Particle distribution is made even based on surface area of the elements, i.e. small elements emit less particles than large elements, so that the particle density is even.

Particles/Face

Number of emissions per face (0 = automatic).

Jittering Amount

Amount of jitter applied to the sampling.

Random

Random Order

The emitter element indices are gone through in a random order instead of linearly (one after the other).



Even Distribution

Particle distribution is made even based on surface area of the elements, i.e. small elements emit less particles than large elements, so that the particle density is even.

Grid

Invert Grid

Invert what is considered the object and what is not.

Hexagonal Grid

Uses a hexagonal-shaped grid instead of a rectangular one.

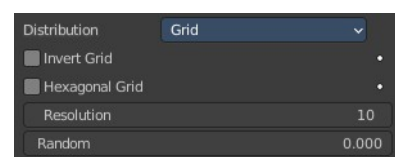

Resolution

Resolution of the grid.

Random

Add a random offset to grid locations.



26.10.20 Editors - Properties Editor - Particle Properties Tab - Force Field Settings panel

Table of content

Force Field Settings panel.....	4
Self Effect.....	4
Effector Amount.....	4
Type 1 and Type 2 Sub panels.....	4
Type 1 / 2.....	4
Force.....	4
Strength.....	4
Flow.....	4
Affect.....	4
Location.....	4
Rotation.....	4
Noise Amount.....	4
Seed.....	5
Gravitation.....	5
Absorption.....	5
Wind Factor.....	5
Wind.....	5
Strength.....	5
Flow.....	5
Affect.....	5
Location.....	5
Rotation.....	5
Noise Amount.....	5
Seed.....	5
Absorption.....	5
Wind Factor.....	5
Vortex.....	6
Strength.....	6
Flow.....	6
Affect.....	6
Location.....	6
Rotation.....	6
Noise Amount.....	6
Seed.....	6
Absorption.....	6
Wind Factor.....	6
Magnetic.....	6
Strength.....	6
Flow.....	6
Affect.....	6
Location.....	6
Rotation.....	6
Noise Amount.....	7
Seed.....	7
Absorption.....	7

Wind Factor.....	7
Harmonic.....	7
Strength.....	7
Damping.....	7
Rest Length.....	7
Affect.....	7
Location.....	7
Rotation.....	7
Noise Amount.....	7
Seed.....	7
Multiple Springs.....	7
Absorption.....	7
Wind Factor.....	7
Charge.....	8
Strength.....	8
Flow.....	8
Affect.....	8
Location.....	8
Rotation.....	8
Noise Amount.....	8
Seed.....	8
Absorption.....	8
Wind Factor.....	8
Lenard Jones.....	8
Strength.....	8
Flow.....	8
Affect.....	9
Location.....	9
Rotation.....	9
Noise Amount.....	9
Seed.....	9
Absorption.....	9
Wind Factor.....	9
Texture.....	9
Strength.....	9
Flow.....	9
Affect.....	9
Location.....	9
Rotation.....	9
Noise Amount.....	9
Seed.....	9
Absorption.....	9
Wind Factor.....	10
Curve Guide.....	10
Strength.....	10
Flow.....	10
Affect.....	10
Location.....	10
Rotation.....	10
Noise Amount.....	10
Seed.....	10
Absorption.....	10
Wind Factor.....	10

Boid.....	10
Strength.....	10
Flow.....	10
Affect.....	11
Location.....	11
Rotation.....	11
Noise Amount.....	11
Seed.....	11
Absorption.....	11
Wind Factor.....	11
Turbulence.....	11
Strength.....	11
Size.....	11
Flow.....	11
Affect.....	11
Location.....	11
Rotation.....	11
Noise Amount.....	11
Seed.....	11
Global.....	12
Absorption.....	12
Wind Factor.....	12
Drag.....	12
Linear.....	12
Quadratic.....	12
Affect.....	12
Location.....	12
Rotation.....	12
Noise Amount.....	12
Seed.....	12
Absorption.....	12
Wind Factor.....	12
Fluid Flow.....	13
Strength.....	13
Flow.....	13
Affect.....	13
Location.....	13
Rotation.....	13
Noise Amount.....	13
Seed.....	13
Absorption.....	13
Wind Factor.....	13
Falloff subpanel.....	13
Z Direction.....	13
Power.....	13
Min Distance.....	13
Max Distance.....	13

Force Field Settings panel

The Force Field Settings panel allows you to make each individual act as a force field, allowing them to affect other dynamic systems, or even, each other.

Self Effect

Causes the particle force fields to have an effect on other particles within the same system.

Effector Amount

Set how many of the particles act as force fields. 0 means all of them are effectors.

Type 1 and Type 2 Sub panels

You can give particle systems up to two force fields. By default they do not have any force field enabled. Choose an effector type from the selector to enable them.

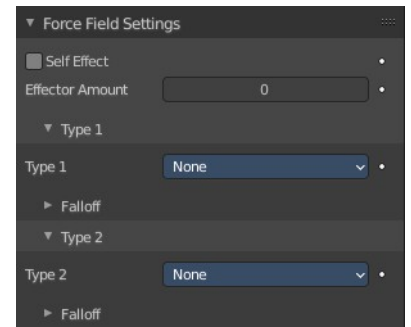

Type 1 / 2

Force

Radial field towards the center of an object.

Strength

The strength of the force.

Flow

Convert effector force into air force velocity.

Affect

Location

Affect the location of the particles.

Rotation

Affect the rotation of the particles.

Noise Amount

Amount of noise for the force effect.

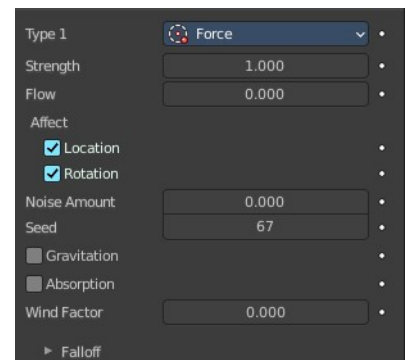
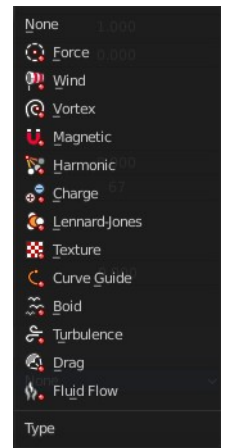

Seed

The random seed for the noise amount.

Gravitation

Multiply force by 1 divided through the distance in square.

Absorption

Force gets absorbed by collision objects.

Wind Factor

How much the force is reduced when acting parallel to a surface. Like a cloth.

Wind

Constant force along the Z axis.

Strength

The strength of the force.

Flow

Convert effector force into air force velocity.

Affect

Location

Affect the location of the particles.

Rotation

Affect the rotation of the particles.

Noise Amount

Amount of noise for the force effect.

Seed

The random seed for the noise amount.

Absorption

Force gets absorbed by collision objects.

Wind Factor

How much the force is reduced when acting parallel to a surface. Like a cloth.

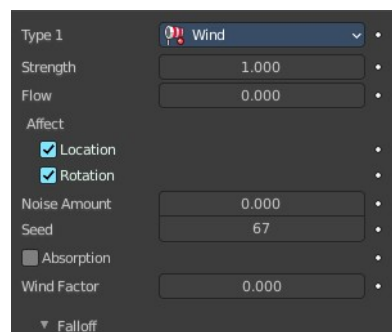

Vortex

Spiraling force that twists the force object's local Z axis.

Strength

The strength of the force.

Flow

Convert effector force into air force velocity.

Affect

Location

Affect the location of the particles.

Rotation

Affect the rotation of the particles.

Noise Amount

Amount of noise for the force effect.

Seed

The random seed for the noise amount.

Absorption

Force gets absorbed by collision objects.

Wind Factor

How much the force is reduced when acting parallel to a surface. Like a cloth.

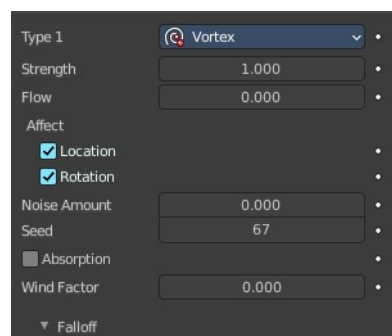

Magnetic

Force field depends of the speed of the particles.

Strength

The strength of the force.

Flow

Convert effector force into air force velocity.

Affect

Location

Affect the location of the particles.

Rotation

Affect the rotation of the particles.

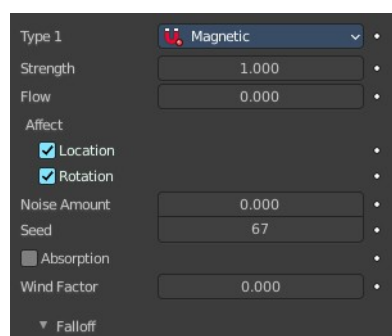

Noise Amount

Amount of noise for the force effect.

Seed

The random seed for the noise amount.

Absorption

Force gets absorbed by collision objects.

Wind Factor

How much the force is reduced when acting parallel to a surface. Like a cloth.

Harmonic

The source of this force field is the zero point of a harmonic oscillator.

Strength

The strength of the force.

Damping

Damping of the harmonic force.

Rest Length

The rest length of the harmonic force.

Affect

Location

Affect the location of the particles.

Rotation

Affect the rotation of the particles.

Noise Amount

Amount of noise for the force effect.

Seed

The random seed for the noise amount.

Multiple Springs

Every point is effected by multiple springs.

Absorption

Force gets absorbed by collision objects.

Wind Factor

How much the force is reduced when acting parallel to a surface. Like a cloth.

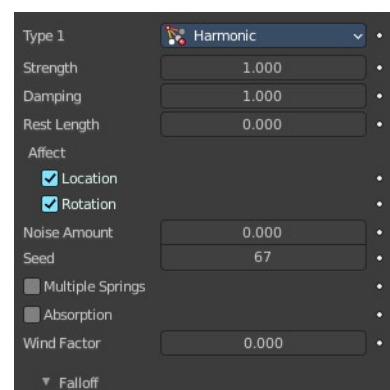

Charge

Special force field based on the charge of particles. Charge force fields just affects other charge force fields.

Strength

The strength of the force.

Flow

Convert effector force into air force velocity.

Affect

Location

Affect the location of the particles.

Rotation

Affect the rotation of the particles.

Noise Amount

Amount of noise for the force effect.

Seed

The random seed for the noise amount.

Absorption

Force gets absorbed by collision objects.

Wind Factor

How much the force is reduced when acting parallel to a surface. Like a cloth.

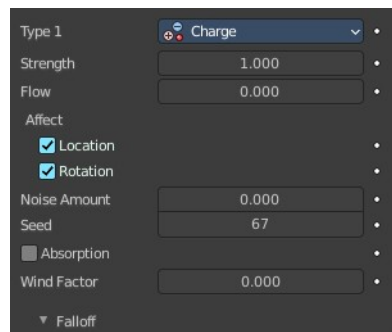

Lenard Jones

Force field based on the lennard jones potential. The Lennard-Jones potential describes the interactions of two neutral particles using a relatively simple mathematical model.

Strength

The strength of the force.

Flow

Convert effector force into air force velocity.

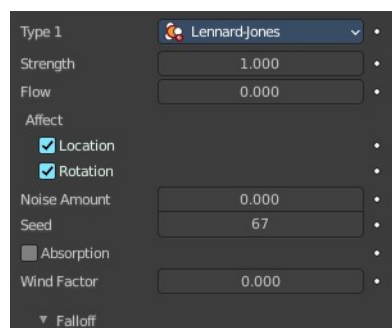

Affect

Location

Affect the location of the particles.

Rotation

Affect the rotation of the particles.

Noise Amount

Amount of noise for the force effect.

Seed

The random seed for the noise amount.

Absorption

Force gets absorbed by collision objects.

Wind Factor

How much the force is reduced when acting parallel to a surface. Like a cloth.

Texture

Force field based on a texture. There is no way to add a texture here though.

Strength

The strength of the force.

Flow

Convert effector force into air force velocity.

Affect

Location

Affect the location of the particles.

Rotation

Affect the rotation of the particles.

Noise Amount

Amount of noise for the force effect.

Seed

The random seed for the noise amount.

Absorption

Force gets absorbed by collision objects.

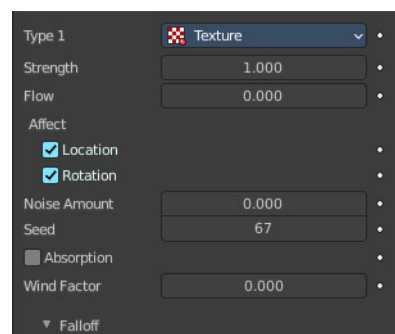

Wind Factor

How much the force is reduced when acting parallel to a surface. Like a cloth.

Curve Guide

Creates a force along a curve object. There is no way to add a curve here though.

Strength

The strength of the force.

Flow

Convert effector force into air force velocity.

Affect

Location

Affect the location of the particles.

Rotation

Affect the rotation of the particles.

Noise Amount

Amount of noise for the force effect.

Seed

The random seed for the noise amount.

Absorption

Force gets absorbed by collision objects.

Wind Factor

How much the force is reduced when acting parallel to a surface. Like a cloth.

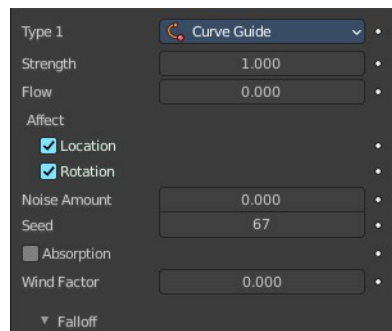

Boid

Creates a force that acts as a boid's predator or target.

Strength

The strength of the force.

Flow

Convert effector force into air force velocity.

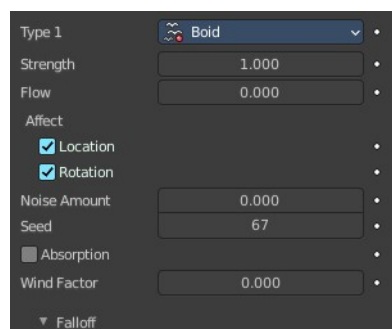

Affect

Location

Affect the location of the particles.

Rotation

Affect the rotation of the particles.

Noise Amount

Amount of noise for the force effect.

Seed

The random seed for the noise amount.

Absorption

Force gets absorbed by collision objects.

Wind Factor

How much the force is reduced when acting parallel to a surface. Like a cloth.

Turbulence

Create turbulence with a noise field.

Strength

The strength of the force.

Size

The size of the turbulence.

Flow

Convert effector force into air force velocity.

Affect

Location

Affect the location of the particles.

Rotation

Affect the rotation of the particles.

Noise Amount

Amount of noise for the force effect.

Seed

The random seed for the noise amount.

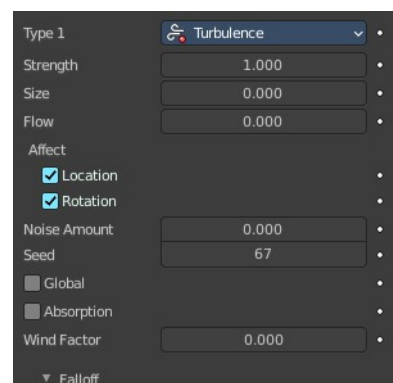

Global

Use global coordinates for the turbulence.

Absorption

Force gets absorbed by collision objects.

Wind Factor

How much the force is reduced when acting parallel to a surface. Like a cloth.

Drag

Create a force that dampens motion.

Linear

Drag component proportional to velocity.

Quadratic

Drag component proportional to square velocity.

Affect

Location

Affect the location of the particles.

Rotation

Affect the rotation of the particles.

Noise Amount

Amount of noise for the force effect.

Seed

The random seed for the noise amount.

Absorption

Force gets absorbed by collision objects.

Wind Factor

How much the force is reduced when acting parallel to a surface. Like a cloth.

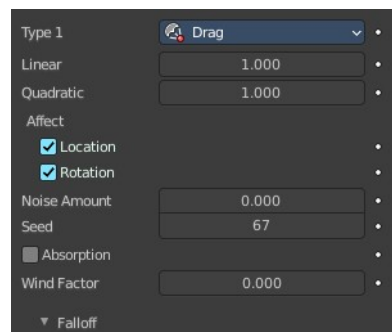

Fluid Flow

Create a force field based on fluid simulation velocities.

Strength

The strength of the force.

Flow

Convert effector force into air force velocity.

Affect

Location

Affect the location of the particles.

Rotation

Affect the rotation of the particles.

Noise Amount

Amount of noise for the force effect.

Seed

The random seed for the noise amount.

Absorption

Force gets absorbed by collision objects.

Wind Factor

How much the force is reduced when acting parallel to a surface. Like a cloth.

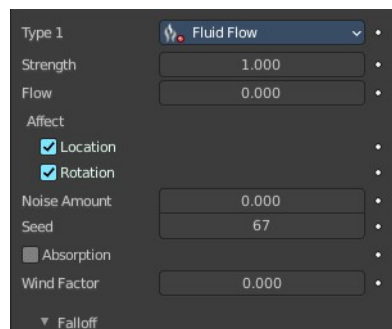

Falloff subpanel

Z Direction

Apply the effect in both directions along Z axis, or just one direction.

Power

How quickly the strength falls off with increasing distance from the force field.

Min Distance

Minimum distance for the fields falloff.

Max Distance

Maximum distance for the fields falloff.

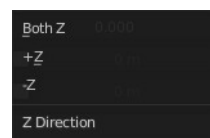
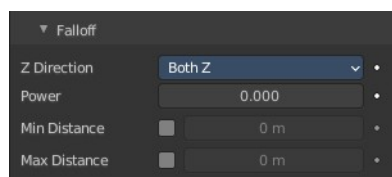



26.10.21 Editors - Properties Editor - Particle Properties Tab - Vertex Groups panel

Table of content

Vertex Groups panel.....	1
Density.....	1
Length.....	1
Clump.....	1
Kink.....	1
Roughness 1.....	1
Roughness 2.....	1
Roughness End.....	2
Twist.....	2

Vertex Groups panel

The Vertex groups panel allows you to specify vertex groups to use for several child particle settings. You can also negate the effect of each vertex group with the check boxes. You can affect the following attributes:

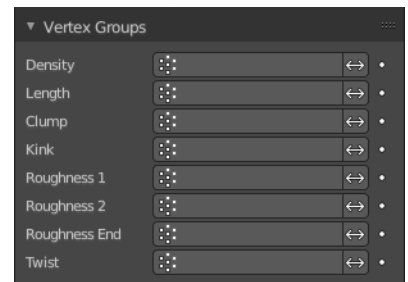

Density

Defines the density of the particle distribution.

Length

Defines the length of the hair.

Clump

Controls the amount of clumping. The weight of 1.0 gives current Clump value, weight of 0.0 completely removes effect.

Kink

Controls the frequency of the children Kink.

Roughness 1

Adjusts the Uniform roughness parameter.

Roughness 2

Adjusts the Random roughness parameter.

Roughness End

Adjusts the Endpoint roughness parameter.

Twist

Vertex group to control the children's Twist effect. Gives control over the direction of the twist, as well as the amount. The weight of 0.5 is neutral, i.e. there is no twist effect.



26.10.22 Editors - Properties Editor - Particle Properties Tab - Textures panel

Table of content

Textures panel.....	1
Texture Slot List.....	1
Move Texture Slot Up / Down.....	1
Texture Specials.....	1
Copy Texture Slot Settings.....	1
Paste Texture Slot Settings.....	1
Image slot property.....	2
Texture Browser.....	2
New.....	2
Texture Edit Box.....	2
Fake User.....	2
New Texture.....	2
Remove.....	2
Change Context.....	2

Textures panel

Particles density can be controlled by textures. This panel allows you to set up the required textures. There can just be one active texture.

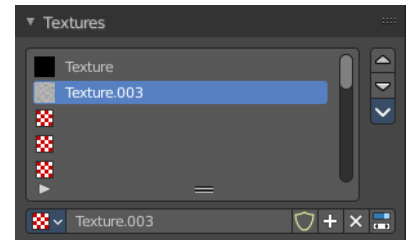

Texture Slot List

The list with the texture slots. You can rename the slots by double clicking at it.

These slots are empty when you create them. You need to fill the slots with textures. This can be done in the Textures tab.

Move Texture Slot Up / Down

Move the texture slots up or down in the list.

Texture Specials

Copy Texture Slot Settings

Copies the Texture Slot Settings.

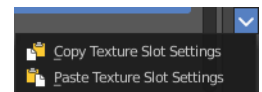

Paste Texture Slot Settings

Pastes copied Texture Slot Settings.

Image slot property

Texture Browser

A list of the textures in the scene. This list allows you to switch to other textures.

New



When nothing is loaded then you will see the New button to create a new image slot.

Texture Edit Box

The name of the currently selected texture. A double left click allows you to rename it.

Fake User

With this button you assign a fake user to this selected image.

Data, like images, that is not longer linked to anything else gets removed when you save and reload a scene. Bforartists has the concept of fake users to go around this behavior. An image with a fake user is in fact linked to something. And so it is not lost when you save and reload the scene.

New Texture

Create a new texture.

Remove

Delete the texture.

Change Context

Switch to the Texture tab where you can add and edit your texture for the texture slot.



26.10.23 Editors - Properties Editor - Particle Properties Tab - Custom Properties panel

Table of content

Custom Properties Panel.....	1
Add.....	1
Edit.....	1
Remove.....	1

Custom Properties Panel

Here you can define custom properties that can be used for scripting.

Here you might also find custom properties from addons or scripts.

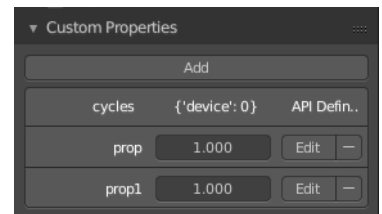

Add

Adds a new property.

Edit

Opens a panel where you can adjust the settings for the custom property.

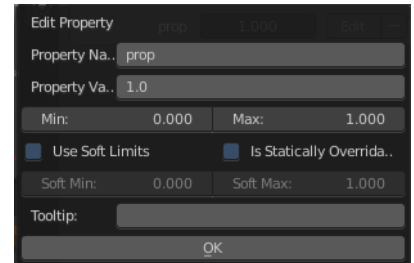

Remove

Removes the property.



26.10.3 Editors - Properties Editor - Particle Properties Tab - Emitter - Cache Panel

Table of content

Cache Panel.....	1
Hints.....	2
Caches List.....	2
Drag Handler.....	2
Search Field.....	2
Invert.....	2
Sort by Name.....	2
Add New Cache.....	3
Delete current Cache.....	3
External.....	3
Index Number.....	3
File Path.....	3
Info string.....	3
Cache Step.....	3
Info string.....	3
Disk Cache.....	3
Use Library Path.....	4
Compression.....	4
None.....	4
Light.....	4
Heavy.....	4
Bake / Delete Bake.....	4
Calculate To Frame.....	4
Current Cache to Bake.....	4
Bake All Dynamics.....	4
Free All Bakes.....	5
Update All To Frame.....	5

Cache Panel

Particle data can be cached in memory or stored on a drive. This improves real-time response and avoids unnecessary recalculation of particles. But creates also big files.

The Emitter particle system uses a unified system for caching and baking (together with Soft Body and Cloth).

Important! The file needs to be saved after baking. When the file is not saved then some options are not available.

Important! The particle settings becomes unavailable once the particle cache is baked. You need to remove the bake when you want to change the settings.

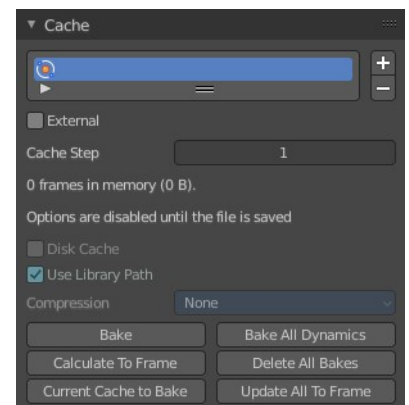

Hints

The simulation is only calculated for positive frames in between the Start and End frames of the Cache panel, whether you bake or not. So if you want a simulation that is longer than the default frame range, you have to change the End frame.

When an animation is played, each physics system writes each frame to the cache. Note that for the cache to fill up, one has to start the playback before or on the frame that the simulation starts.

The cache is cleared automatically on changes. But not on all changes, so it may be necessary to free it manually. For example if you change a force field.

The system is protected against changes after baking. If for example the mesh changes the simulation is not calculated anew.

The bake result can be cleared by clicking on the Free Bake button in the simulation cache settings.

A simulation can only be edited in Particle Edit Mode when it has been baked in memory. And cannot be edited if the Disk Cache is used.

If you are not allowed to write to the required sub directory caching will not happen. For example if your blend-file path is very long and your operating system has a limit on the path length that is supported.

Be careful with the sequence of modifiers in the modifier stack. You may have a different number of faces in the 3D Viewport and for rendering (For example when using subdivision surface). Then the rendered result may be very different from what you see in the 3D Viewport.

Caches List

The list of available caches. The caches have no name by default. Double click to add a name.



You can store and manage multiple caches at once for the same physics object. The active cache is the one that gets used.

Drag Handler

The two vertical lines at the end is a handler with which you can expand the list.

Search Field

You can expand a search field at the bottom of the list. Type in your term and hit enter to filter for your term.



Invert

Exclude the search term instead of searching for it.

Sort by Name

Sort the List by name.

Add New Cache

Add a new cache.

Delete current Cache

Deletes the selected cache.

External

Allows you to read the cache from a drive using a user-specified file path.

Note! The cache name in Caches List and the Index Number has to exactly match the external cache files name in order to work. The cache files name format is name_frame_index.bphys.

You can create such cache files when you tick Disk cache with External off, and save the blend file. Then the bphys files gets created in a folder besides the blend file.

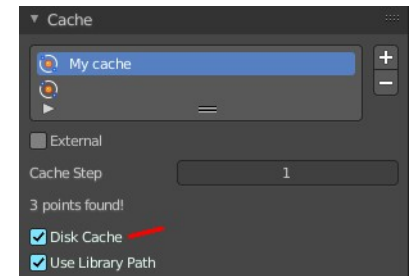
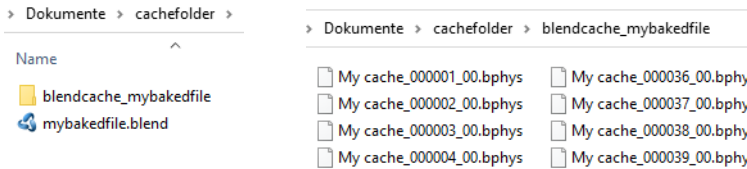

Index Number

The index number of cache files. (The last two digits of the files name.)

File Path

Select the directory path to the cache files.

Info string

An info string. Gives different messages, dependent of the status.

Cache Step

The interval for storing simulation data.

Note! Some physics systems (such as particles) allow for positions to be stored only on every nth frame, letting the positions for in-between frames be interpolated. Using a cache step greater than one will result in a smaller cache, but the result may differ from the original simulation.

Info string

An info string. Gives different messages, dependent of the status.

Disk Cache

Save the cache externally in a folder instead inside of the blend file. The cache of a baked simulation will be stored inside the blend-file when you save it. A folder named blendcache_[filename] will then be created along-

side the blend-file. The blend-file must be saved first and then again.

Use Library Path

Share the disk cache when the physics object is linked into another blend-file.

When this option is enabled, linked versions of the object will reference the same disk cache. Otherwise linked versions of the object will use independent caches.

Compression

The compression level for cached files.

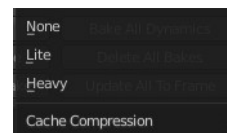

None

Do not compress the cache.

Light

Compression will optimize the speed of compressing/decompressing operations over file size.

Heavy

Compression will result in smaller cache files, but requires more CPU power to compress / decompress.

Bake / Delete Bake

Start baking. Once you have baked the cache the button turns into a Delete bake button. And allows you to remove the bake.



The baking progress can be seen in the footer. You need to be in Object Mode to bake.



Calculate To Frame

Bake only up to the current frame. Limited by End frame set in the cache settings.

Current Cache to Bake

Store any temporarily cached simulation data as a bake. Note that playing the animation will try to simulate any visible physics simulations. Depending on the physics type, this data may be temporarily cached. Normally such temporary caches are cleared when an object or setting is modified, but converting it to a bake will “save” it.

Bake All Dynamics

Bake all physics systems in the scene, even those of different types. Useful for baking complex setups involving interactions between different physics types.

Free All Bakes

Free bakes of all physics systems in the scene, even those of different types.

Update All To Frame

Bake all physics systems in the scene to the current frame.



26.10.4 Editors - Properties Editor - Particle Properties Tab - Rotation panel

Table of content

Rotation Panel.....	1
Orientation Axis.....	1
None.....	1
Normal.....	1
Normal-Tangent.....	1
Velocity.....	2
Global X, Y, Z.....	2
Object X, Y, Z.....	2
Randomize.....	2
Phase.....	2
Randomize Phase.....	2
Dynamic.....	2
Angular Velocity.....	2
Axis.....	2
Amount.....	2

Rotation Panel

Specify how the individual particles are rotated during their travel. To visualize the rotation of a particle you should choose visualization type Axis in the Visualization panel and increase the Display Size.

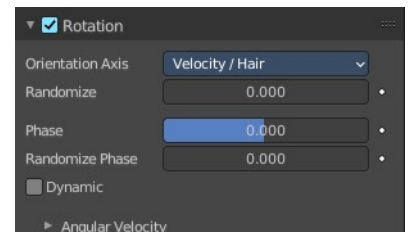

Orientation Axis

Sets the initial rotation of the particle by aligning the X axis in the direction of:

None

The global X axis.

Normal

Orient to the emitter's surface normal, the objects Y axis points outwards.

Normal-Tangent

As with normal, orient the Y axis to the surface normal. Also orient the X axis to the tangent for control over the objects rotation about the normal. requires UV coordinates, the UV rotation effects the objects orientation, currently uses the active UV map. This allow deformation without the objects rotating in relation to their surface.



Velocity

The particle's initial velocity.

Global X, Y, Z

One of the global axes.

Object X, Y, Z

One of the emitter object axes.

Randomize

Randomizes rotation.

Phase

Initial rotation phase.

Randomize Phase

Adds a random variation to the Phase.

Dynamic

If Dynamic is enabled, only initializes particles to the chosen rotation and angular velocity and let the physics simulation handle the rest. Particles then change their angular velocity if they collide with other objects (like in the real world due to friction between the colliding surfaces). Otherwise the angular velocity is predetermined at all times (i.e. set rotation to dynamic/constant).

Angular Velocity

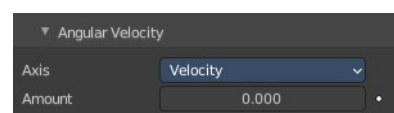

Axis

Which axis to use for the angular velocity.

Hint! If you use a Curve Guide do not turn on Dynamic. Curve Follow does also not work for particles.

Amount

The magnitude of angular velocity.

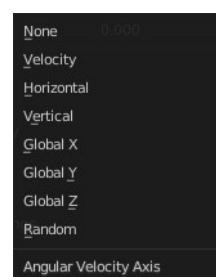



26.10.5 Editors - Properties Editor - Particle Properties Tab - Emitter - Render panel

Table of content

Render Panel.....	2
Render As.....	2
All render methods.....	2
Scale.....	2
Scale Randomness.....	2
Show Emitter.....	2
None.....	2
Halo + Line.....	2
Material.....	3
Coordinates System.....	3
Extra.....	3
Parents Particles.....	3
Unborn.....	3
Dead.....	3
Path.....	3
Material.....	3
Coordinates System.....	3
Path subpanel.....	3
B-Spline.....	3
Steps.....	3
Timing subpanel.....	4
Absolute Path Time.....	4
End.....	4
Random.....	4
Extra.....	4
Parents Particles.....	4
Unborn.....	4
Dead.....	4
Object.....	4
Object subpanel.....	4
Instance Object.....	4
Global Coordinates.....	4
Object Rotation.....	4
Object Scale.....	4
Extra.....	5
Parents Particles.....	5
Unborn.....	5
Dead.....	5
Collection.....	5
Collection subpanel.....	5
Instance Collection.....	5
Whole Collection.....	5
Pick Random.....	5
Global Coordinates.....	5
Object Rotation.....	5

Object Scale.....	5
Use Count.....	6
Dupli Object Index list.....	6
Drag Handler.....	6
Search Field.....	6
Invert.....	6
Sort by Name.....	6
Copy particle Dupliobject.....	6
Remove particle Dupliobject.....	6
Refresh Dupliobjects.....	6
Count.....	6
Extra.....	6
Parents Particles.....	6
Unborn.....	6
Dead.....	6

Render Panel

The Render Panel controls how particles appear when they are rendered.

Note! Cycles supports only Object and Collection render types. Halo Line and Path are not supported.

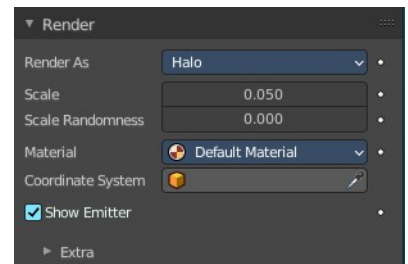

Render As

Render the particles with different methods.

All render methods

Scale

The size of the particles.

Scale Randomness

Give the particles a random size.

Show Emitter

Render the particle emitting mesh. This does not affect the viewport rendering!

None

Don't render the particles.

Halo + Line

Line renders the particles as lines. Halo are rendered as glowing dots or a lit-

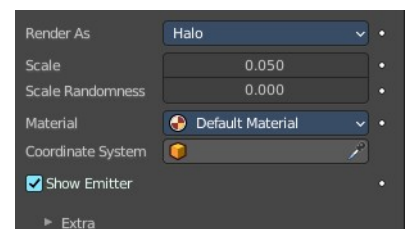
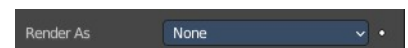
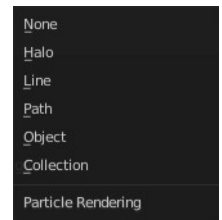

tle cloud of light. Although they are not really lights because they do not cast light into the scene like a light object. They are called Halos because you can see them, but they do not have any substance.

Material

Set which of the object's materials is used to shade the particles.

Coordinates System

Use a different object's coordinates to determine the birth of particles.

Extra

Parents Particles

Render also parent particles if child particles are used. Children have a lot of different deformation options, so the straight parents would stand between their curly children. So by default Parents are not rendered if you activate Children. See Children.

Unborn

Render particles before they are born.

Dead

Render particles after they have died. This is very useful if particles die in a collision Die on hit, so you can cover objects with particles.

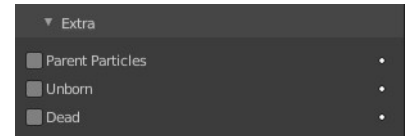
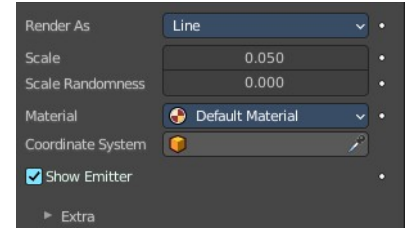

Path

The Path visualization needs a Hair particle system or Keyed particles.

Material

Set which of the object's materials is used to shade the particles.

Coordinates System

Use a different object's coordinates to determine the birth of particles.

Path subpanel

B-Spline

Interpolate hair using B-splines. This may be an option for you if you want to use low Render values. You loose a bit of control but gain smoother paths.

Steps

Set the number of subdivisions of the rendered paths (the value is a power of 2). You should set this value carefully, because if you increase the render value by two you need four times more memory to render. Also the rendering is faster if you use low render values (sometimes drastically). But how low you can go with this value depends on the waviness of the hair (the value is a power of 2). This means 0 steps give 1 subdivision, 1 give 2 subdivisions, 2 -> 4, 3 -> 8, 4 -> 16, ... n -> n².

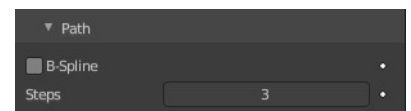
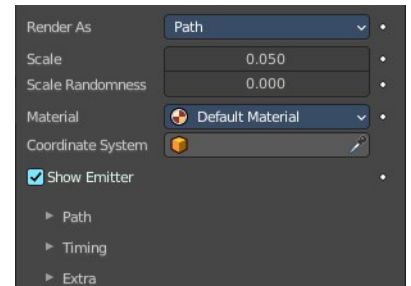

Timing subpanel

Absolute Path Time

Path timing is in absolute frames.

End

End time of the practical path.

Random

Give the path length a random variation.

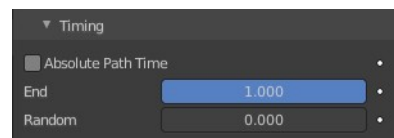

Extra

Parents Particles

Render also parent particles if child particles are used. Children have a lot of different deformation options, so the straight parents would stand between their curly children. So by default Parents are not rendered if you activate Children. See Children.

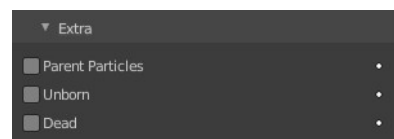

Unborn

Render particles before they are born.

Dead

Render particles after they have died. This is very useful if particles die in a collision Die on hit, so you can cover objects with particles.

Object

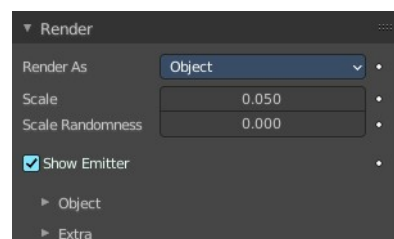

Object subpanel

Instance Object

The specified object is instanced in place of each particle.

Global Coordinates

Use object's global coordinates for instancing.

Object Rotation

Use the rotation of the object.

Object Scale

Use the size of the object.

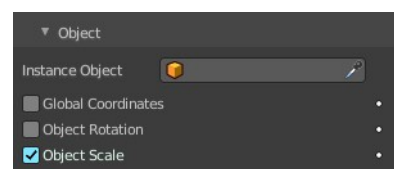

Extra

Parents Particles

Render also parent particles if child particles are used. Children have a lot of different deformation options, so the straight parents would stand between their curly children. So by default Parents are not rendered if you activate Children. See Children.

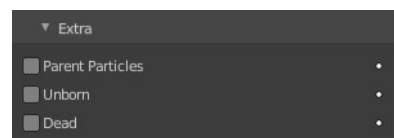

Unborn

Render particles before they are born.

Dead

Render particles after they have died. This is very useful if particles die in a collision Die on hit, so you can cover objects with particles.

Collection

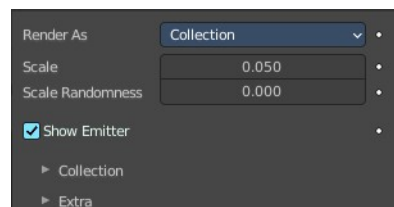

Collection subpanel

Instance Collection

The objects that belong to a collection are instanced sequentially in the place of the particles.

Whole Collection

Use the whole group at once, instead of one of its elements, the group being displayed in place of each particle.

Pick Random

The objects in the group are selected in a random order, and only one object is displayed in place of a particle. Please note that this mechanism fully replaces old Blender particles system using parentage and Instancing Verts to replace particles with actual geometry. This method is fully deprecated and does not work anymore.

Global Coordinates

Use object's global coordinates for instancing.

Object Rotation

Use the rotation of the objects.

Object Scale

Use the size of the objects.

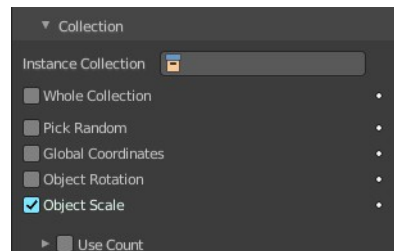

Use Count

Use objects multiple times in the same groups. Specify the order and number of times to repeat each object with the list view that appears.

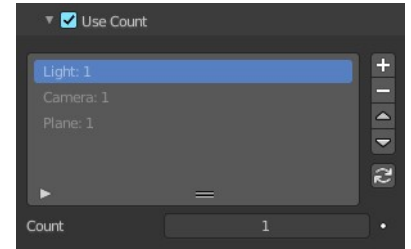

Dupli Object Index list

The list with the objects of the chosen instance collection.

Drag Handler

The two vertical lines at the end is a handler with which you can expand the list.

Search Field

You can expand a search field at the bottom of the list. Type in your term and hit enter to filter for your term.



Invert

Exclude the search term instead of searching for it.

Sort by Name

Sort the List by name.

Copy particle Dupliobject

Duplicate an object in the list.

Remove particle Dupliobject

Remove a duplicate from the list.

Refresh Dupliobjects

Refreshes the Dupli Object Index list.

Count

The number of times this object is repeated with respect to other objects.

Extra

Parents Particles

Render also parent particles if child particles are used. Children have a lot of different deformation options, so the straight parents would stand between their curly children. So by default Parents are not rendered if you activate Children. See Children.

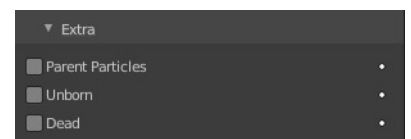

Unborn

Render particles before they are born.

Dead

Render particles after they have died. This is very useful if particles die in a collision Die on hit, so you can cover objects with particles.



26.10.6 Editors - Properties Editor - Particle Properties Tab - Emitter - Viewport Display panel

Table of content

Viewport Display.....	1
Display as.....	1
None.....	1
Rendered.....	1
Point.....	2
Circle.....	2
Cross.....	2
Axis.....	2
Color.....	2
Fade Distance.....	2
Amount.....	2
Show Emitter.....	2
Size.....	2
Strand Steps.....	3

Viewport Display

How to display the particles in the 3d viewport.

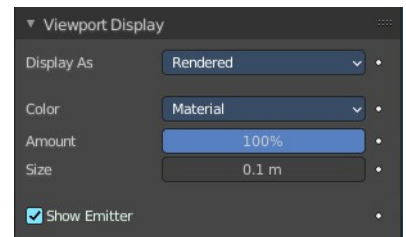

Display as

How to display the particles in the viewport.

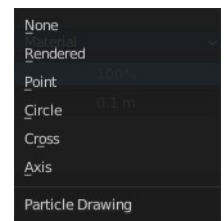

None

Don't display particles in the viewport.

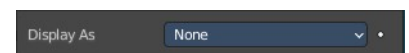

Rendered

Display the particles as rendered.

Important! These settings are dependent of the render as mode in the Render panel, and some settings just displays in the right mode.

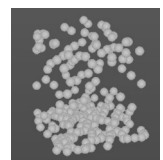

Point

Display the particles as Points.

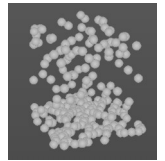

Circle

Display the particles as circles.

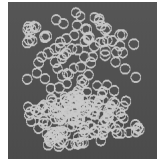

Cross

Displays each particle as a cross.

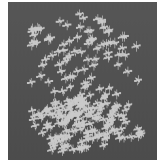

Axis

Displays each particle as an axis widget.

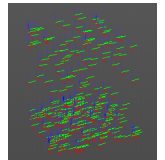

Color

What draw color to use for the particles.

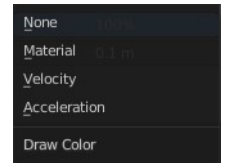

Fade Distance

With color mode Velocity and Acceleration. Maximum length of the particle color vector.

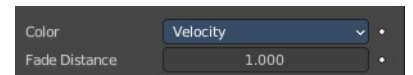

Amount

Percentage of particles to display in the 3d viewport. Choosing a display percentage lower 100 makes dynamics inaccurate without baking.

Show Emitter

Render the particle emitting mesh.

Size

Shows with render method Halo. Size of particles in viewport in Blender Units.

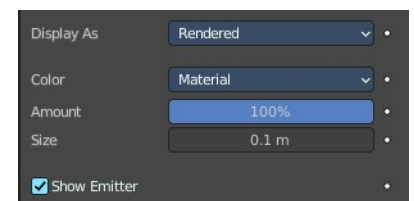
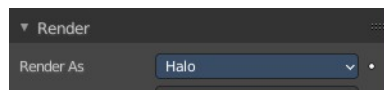

Strand Steps

Shows with render method With Path. How many steps paths are drawn with. The value needs to be a power of two.

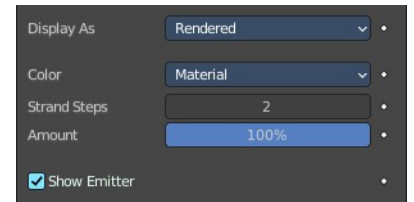
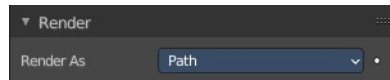



26.10.7 Editors - Properties Editor - Particle Properties Tab - Emitter - Field Weights panel

Table of content

Field weights panel.....	1
Effector Collection.....	1
Gravity.....	1
All.....	1
Force, Vortex, etc.....	1

Field weights panel

The Field Weight panel allows you to control how much influence each type of external force field, or effector, has on the particle system. Force fields are external forces that give dynamic system's motion.

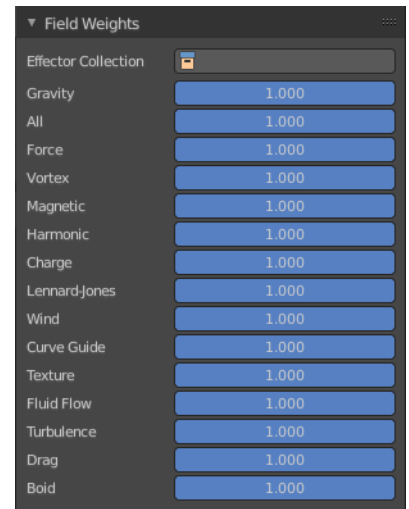

Effector Collection

Limit effectors to a specified group. Only effectors in this group will have an effect on the current system.

Gravity

Control how much the Global Gravity has an effect on the system.

All

Scale all of the effector weights.

Force, Vortex, etc.

The influence for the single corresponding effector weights.

26.10.8 Editors - Properties Editor - Particle Properties Tab - Hair

Table of content

Introduction..... 1
 Workflow example..... 1

Introduction

There are two types of particles. Emitted particles and hair. Emitted particles are used for things like fire, smoke, mist and many other animated effects. Hair is used for hair and fur effects, at characters for example.

This manual part is for particles of type Hair.

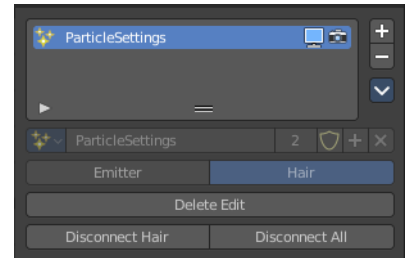

Workflow example

Create a sphere.

Add a particle system. Change it to hair.

In the Emission panel adjust the length, etc.

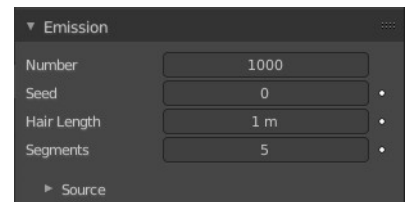

Switch to Edit mode, switch to the Object Data properties tab, and create a vertex group. Assign it to a selection.

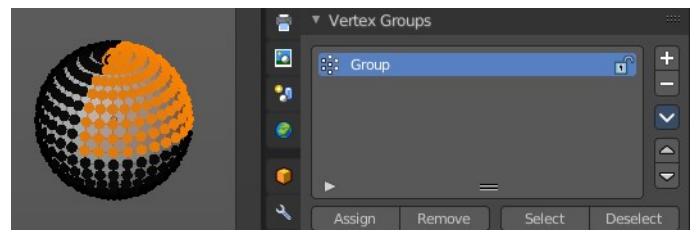

Switch back to the Particles tab. Scroll down to the Vertex Groups panel. In the Density property add the Vertex group. Now the hair should only grow at the vertex group location.

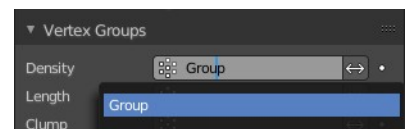

In 3D view switch to Particle Edit mode.

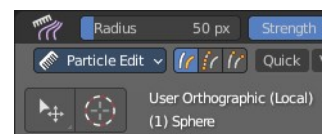

Start to comb the hair. Attention, when you modify the hair particles then some settings like the Emission settings are not longer available. They grey out. You would need to remove the edits to adjust these set-

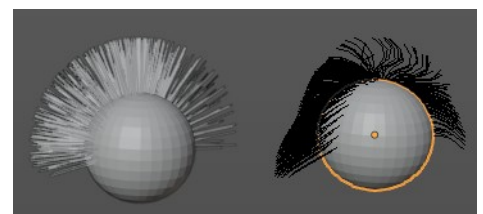

tings again.



26.9.9 Editors - Properties Editor - Particle Properties Tab - Hair - Emission Panel

Table of content

Emission Panel.....	1
Number.....	1
Seed.....	1
Hair Length.....	1
Segments.....	2
Source.....	2
Emit From.....	2
Vertices.....	2
Use Modifier Stack.....	2
Random Order.....	2
Faces & Volume.....	2
Use Modifier Stack.....	2
Distribution.....	2
Jittered.....	2
Random Order.....	2
Even Distribution.....	3
Particles/Face.....	3
Jittering Amount.....	3
Random.....	3
Random Order.....	3
Even Distribution.....	3
Grid.....	3
Invert Grid.....	3
Hexagonal Grid.....	3
Resolution.....	3
Random.....	3

Emission Panel

The buttons in the Emission panel control the way particles are emitted over time.

Number

The amount of hair strands.

Seed

Blender uses this as starting point to produce random numbers during the simulation.

Hair Length

Controls the length of the hair.

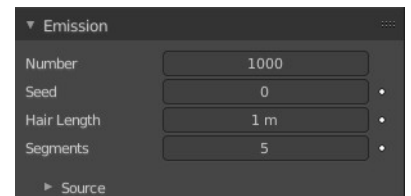

Segments

How much segments each hair should have.

Source

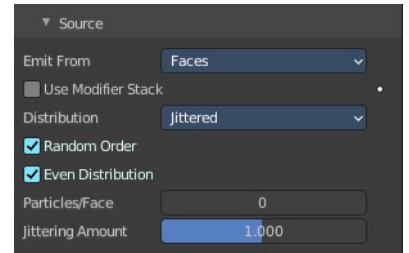

Emit From

Defines how and where the particles are emitted, giving precise control over their distribution. Defines also what content is displayed in the source sub panel.

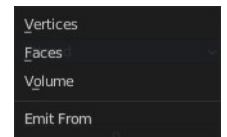

Tip! You may use vertex groups to confine the emission, that is done in the Vertex Groups panel.

Vertices

Emits particles from the vertices of a mesh.

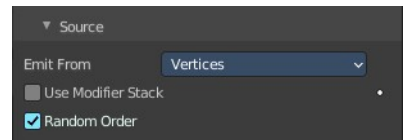

Use Modifier Stack

Take any Modifiers above the Particle Modifier in the modifier stack into account when emitting particles, else it uses the original mesh geometry.

Random Order

The emitter element indices are gone through in a random order instead of linearly (one after the other).

Faces & Volume

Faces emits particles from the surface of a mesh's faces.

Volume emits particles from the volume of an enclosed mesh. Your mesh must be manifold to emit particles from the volume. Some modifiers like the Edge Split Modifier break up the surface, in which case volume emission will not work correctly!

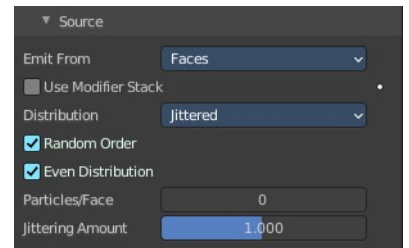

Use Modifier Stack

Take any Modifiers above the Particle Modifier in the modifier stack into account when emitting particles, else it uses the original mesh geometry.

Distribution

These settings control how the emissions of particles are distributed throughout the emission locations when emitting from either Faces or Volume.

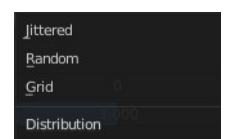

Jittered

Random Order

The emitter element indices are gone through in a random order instead of lin-

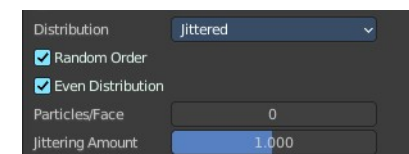

early (one after the other).

Even Distribution

Particle distribution is made even based on surface area of the elements, i.e. small elements emit less particles than large elements, so that the particle density is even.

Particles/Face

Number of emissions per face (0 = automatic).

Jittering Amount

Amount of jitter applied to the sampling.

Random

Random Order

The emitter element indices are gone through in a random order instead of linearly (one after the other).

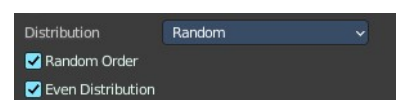

Even Distribution

Particle distribution is made even based on surface area of the elements, i.e. small elements emit less particles than large elements, so that the particle density is even.

Grid

Invert Grid

Invert what is considered the object and what is not.

Hexagonal Grid

Uses a hexagonal-shaped grid instead of a rectangular one.

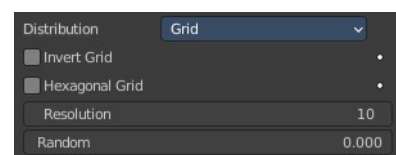

Resolution

Resolution of the grid.

Random

Add a random offset to grid locations.

26.11 Editors - Properties Editor - Visual Effects Properties Tab

Table of content

Detailed table of content.....	1
Visual Effects.....	3
General functionality.....	3
Blur.....	5
Colorize.....	6
Flip.....	6
Glow.....	7
Pixelate.....	8
Rim.....	8
Shadow.....	9
Swirl.....	10
Wave Distortion.....	10

Detailed table of content

Detailed table of content

Detailed table of content.....	1
Visual Effects.....	3
General functionality.....	3
Add.....	3
Header elements.....	3
Collapse panel.....	4
Effect Icon.....	4
Effect Name.....	4
Realtime.....	4
Render.....	4
Header menu.....	4
Duplicate.....	4
Move to first.....	4
Move to last.....	4
Remove.....	5
Change Context.....	5
Reorder.....	5
Animate Property.....	5
Blur.....	5
Samples.....	5
Use Depth of Field.....	5
Size X / Y.....	5
Rotation.....	6
Colorize.....	6
Mode.....	6
Grayscale.....	6
Sepia.....	6
Duotone.....	6
Transparent.....	6

Factor.....	6
Custom.....	6
Color.....	6
Factor.....	6
Flip.....	6
Axis.....	7
Glow.....	7
Mode.....	7
Luminance.....	7
Color.....	7
Glow Color.....	7
Blend Mode.....	7
Opacity.....	7
Size X / Y.....	7
Rotation.....	7
Samples.....	8
Glow Under.....	8
Pixelate.....	8
Size X / Y.....	8
Antialiasing.....	8
Rim.....	8
Rim Color.....	8
Mask Color.....	8
Blend Mode.....	8
Offset X / Y.....	8
Blur subpanel.....	9
Blur X / Y.....	9
Samples.....	9
Shadow.....	9
Shadow Color.....	9
Offset X / Y.....	9
Scale X / Y.....	9
Rotation.....	9
Object Pivot.....	9
Blur subpanel.....	9
Blur X / Y.....	9
Samples.....	9
Wave Effect subpanel.....	10
Orientation.....	10
Amplitude.....	10
Period.....	10
Phase.....	10
Swirl.....	10
Object.....	10
Radius.....	10
Angle.....	10
Wave Distortion.....	10
Orientation.....	10
Amplitude.....	11
Period.....	11
Phase.....	11

Visual Effects

Visual Effects are for the Grease Pencil object only.

In the viewport you can apply so called visual effects to Grease pencil strokes. Like a pixelate effect.

The effect is applied to the whole image in the viewport. But just to the grease pencil object that has the effect applied. Other grease pencil objects will not be affected.

The effects renders to file. But visual effects are mainly meant for preview purposes, to judge how the result could look like after compositing. The compositing nodes are more accurate.

Visual Effects works with all renderers. Cycles, Workbench and Eevee.

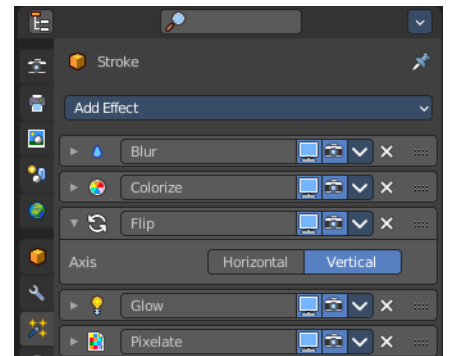

You need to be in the viewport shading mode rendered. The effect does not show in material preview mode.



The effects are dependant of zoom and orientation of the viewport camera.

General functionality

Add

To add an effect to a grease pencil object, simply open the drop down menu, and choose the type of modifier that you want to add.

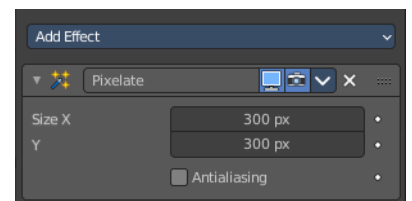

This will add the effect to the list.

Header elements

You might want to remove an effect. Or just see the effect in the final rendering. This can be adjusted in the header. The header is what you see when you collapse the effects panel.



Elements are explained from left to right.

Collapse panel

The whole modifier panel can be collapsed. Click at the arrow button up left in the header.

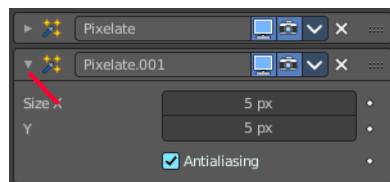

Effect Icon

This icon shows the type of the effect. And has no further functionality.

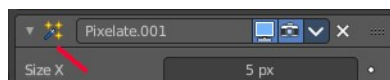

Effect Name

The name of the modifier. You can rename effects by clicking into the edit field and change the text.



Realtime

Display the modifier in the viewport.

Render

Display the modifier in the rendered result.

Header menu

Duplicate

Duplicates the modifier, and places the duplicate below the current modifier.

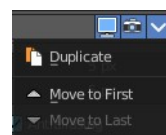

Move to first

Move the modifier to the first position in the stack.

Move to last

Move the modifier to the last position in the stack.

Remove

Removes the modifier from the stack.

Change Context

Some modifiers cannot be removed from the modifiers stack directly. Like fluid modifiers. You need to remove the fluid simulation instead, in the physics tab. With the change context button you jump to the required tab where you can now remove the simulation.

Reorder

You can have more than one modifier in the list. And sometimes the order of the modifiers is very important.

Grab the handler at the right and drag the modifier to the position where you want it to have.

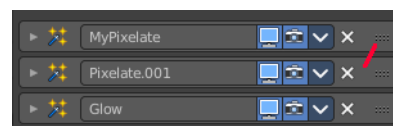

Animate Property

Some of the properties can be animated. Click at the animate property button at the right to add a keyframe.

Blur

Applies a Gaussian blur to the object.

Samples

Number of Blur samples (0 disabled the blur effect).

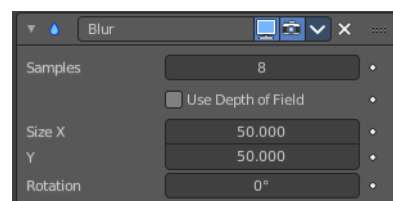

Use Depth of Field

When enabled, the blur effect uses the focal plane distance of the actual camera to simulate a depth of field effect. Only available in camera view.

Size X / Y

The blur factor in x and y direction

Rotation

Rotation of the effect.

Colorize

Applies colorizing effects to the object.

Mode

Grayscale

Converts to a grayscale image.

Sepia

Converts to a sepia tone image.

Duotone

Converts to a black and white posterize image with high contrast and brightness.

Transparent

Add color transparency.

Factor

Controls the mix value (0 fully transparent, 1 fully opaque).

Custom

Allows to define a tint custom color.

Color

Sets the tint color.

Factor

How strong the effect is applied.

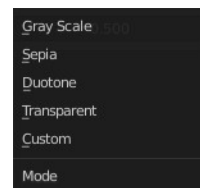
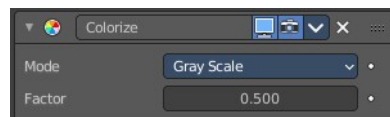

Flip

Shows the object flipped horizontally and/or vertically.

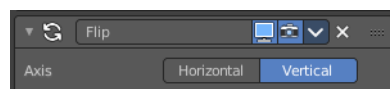

Axis

The axis to use for the flipping.

Glow

Adds a glowing rim around the object.

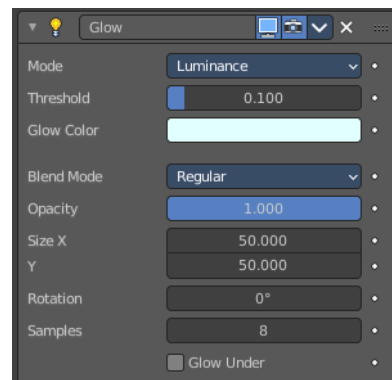

Mode

The mode of the glow effect.

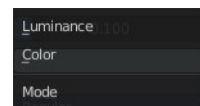

Luminance

The glow light illuminates the entire object.

Color

The glow light only affect a single color.

Glow Color

Defines the glow color.

Blend Mode

How to blend the glow with the image.

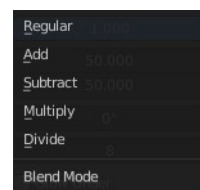

Opacity

Size X / Y

The size of the effect.

Rotation

Rotation of the effect.

Samples

Number of blur samples.

Glow Under

Glow only affects alpha areas. Does not work with the blend mode Regular.

Pixelate

Pixelates the grease pencil stroke.

Size X / Y

The size of the pixels.

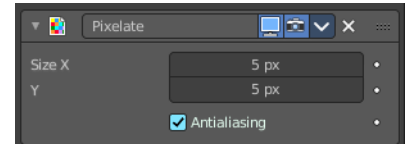

Antialiasing

Use antialiasing.

Rim

Shows a simulated rim light on the object contour.

For simulating the rim light, a masked color silhouette of the object is displaced in horizontal and/or vertical direction.

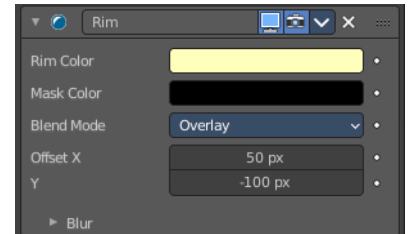

Rim Color

The color of the rim light.

Mask Color

Defines a color to keep unaltered.

Blend Mode

How to blend the rimlight with the image.

Offset X / Y

Color mask displacement in pixels along the X and Y axis.

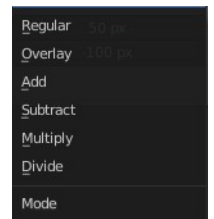

Blur subpanel

Blur X / Y

The blur scale in pixels on the X and Y axis.

Samples

Number of blur samples. A value of 0 disables the blur effect.

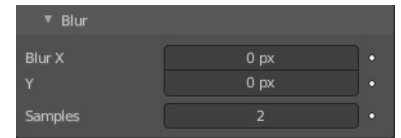

Shadow

Shows a simulated shadow casted by the object.

Shadow Color

Defines the shadow color.

Offset X / Y

The shadow displacement in pixels along the X and Z axis.

Scale X / Y

Scales the size of the shadow along the X and y axis.

Rotation

The shadow rotation around the Grease Pencil object. You can use the center of the grease pencil object. With Object Pivot enabled you can also choose the pivot of another object.

Object Pivot

Use the pivot of another object for rotation. You need to pick another object from the scene.

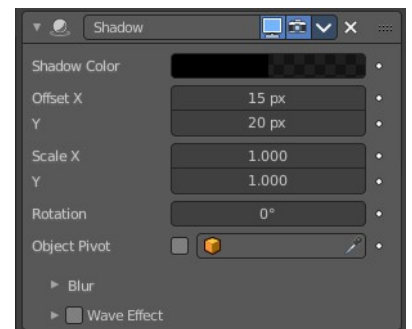

Blur subpanel

Blur X / Y

The blur scale in pixels on the X and Y axis.

Samples

Number of blur samples. A value of 0 disables the blur effect.

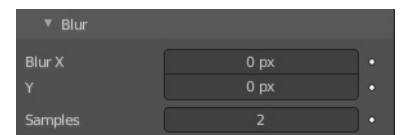

Wave Effect subpanel

Apply a wave distortion to the shadow.

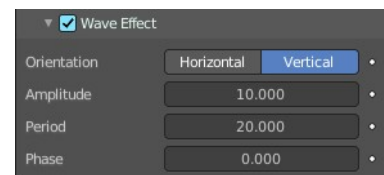

Orientation

Sets a horizontal or vertical direction for the waves.

Amplitude

Controls the strength and the depth of the wave.

Period

Controls the wave period. The time it takes to complete one cycle.

Phase

Shifts the wave pattern over the shadow.

Swirl

Applies a swirling pattern to the grease pencil object. The effect uses another object as the center of the swirl. An empty for example.

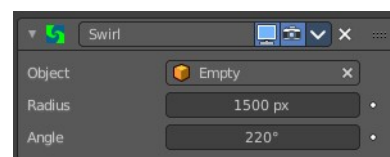

Object

Pick the object that you want to use as the center of the swirl.

Radius

External radius size of the swirl. The needed radius depends of camera zoom.

Angle

Rotation angle of the swirl. A value of 0 shows no swirl.

Wave Distortion

Adds a wave distortion to the grease pencil object.

Orientation

Sets a horizontal or vertical direction for the waves.

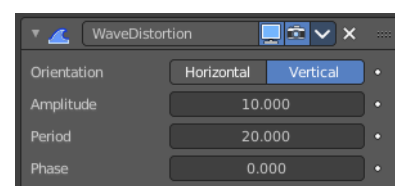

Amplitude

Controls the strength and the depth of the wave.

Period

Controls the wave period. The time it takes to complete one cycle.

Phase

Shifts the wave pattern over the grease pencil object.



26.12 Editors - Properties Editor - Physics Properties Tab

Table of content

Physics.....	1
Physics types.....	2
Force Field.....	2
Collision.....	2
Cloth.....	2
Dynamic Paint.....	2
Soft Body.....	2
Fluid.....	2
Rigid Body.....	2
Rigid Body Constraint.....	3

Physics

Gravity or collisions are real time physical effects. In the Physics tab you will find some methods to simulate such physical effects to use them in your images or movies. They allow objects to interact with each other. Like collisions. Or that wind forces bends some plant meshes. And much more.

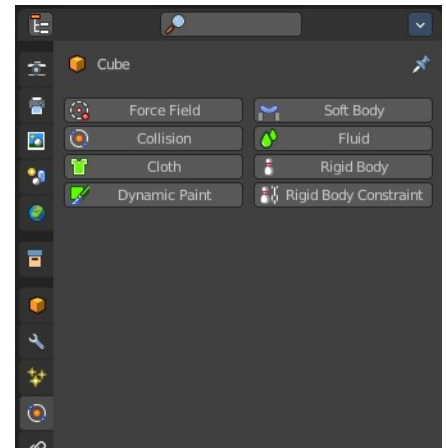

Not every object has a physics tab. And not all physics are available at the object types that has it available. A Bezier curve object for example has just Force Field, Soft Body and Rigid Body Constraints available.

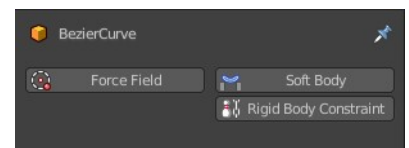

By clicking at one of the buttons you will enable the physics type. And its settings will appear.

Active buttons will have an X at the front. By clicking at it you can remove the physics effect.

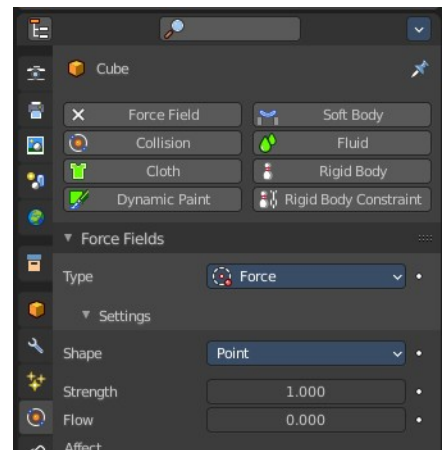

Some Physics types will add a modifier to the modifier stack. Cloth for example.

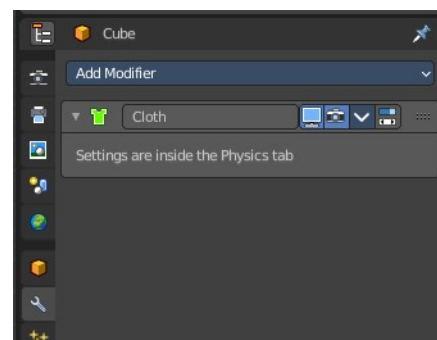

Physics types

You can add up to eight different types of physics. There can be more than one physics type at the object.

Force Field

As the name says, this physics type adds forces. Wind for example. And the forces can influence other physics types like particles, soft bodies, cloth and rigid bodies.

Collision

Collision physics is meant for collisions. Particles, Soft Bodies and Cloth objects may collide with mesh objects. Boids try to avoid Collision objects.

Cloth

Cloth is a physics effect that tries to simulate the motion and behavior of fabrics.

Dynamic Paint

Dynamic paint is a modifier and physics system that can turn objects into paint canvases and brushes. With Dynamic Paint you can create vertex colors, image sequences or displacement. This makes many effects possible like, for example footsteps in the snow, raindrops that make the ground wet, paint that sticks to walls, or objects that gradually freeze.

Soft Body

Soft body simulation is used for simulating soft deformable objects.

Fluid

Fluid physics is used to simulate liquids.

Rigid Body

Rigid bodies simulates the motion of solid objects. They can receive forces, gravity or acceleration for example. And allows collision without to deform them. Just mesh objects can have rigid bodies.

Rigid Body Constraint

Rigid body constraint is used to connect two rigid bodies. This can be the position, or the rotation or scale.



26.12.1 Editors - Properties Editor - Physics Properties Tab - Force Field Panel

Table of content

Detailed table of content.....	1
Force Fields panel.....	7
Type.....	7
Type Force.....	8
Settings subpanel.....	8
Falloff Subpanel.....	9
Type Wind.....	10
Settings Subpanel.....	10
Falloff Subpanel.....	11
Type Vortex.....	12
Settings Subpanel.....	12
Falloff Subpanel.....	13
Type Magnetic.....	14
Settings Subpanel.....	14
Falloff Subpanel.....	15
Type Harmonic.....	15
Settings Subpanel.....	16
Falloff Subpanel.....	17
Type Charge.....	17
Settings Subpanel.....	18
Falloff Subpanel.....	18
Type Lennard Jones.....	19
Settings Subpanel.....	19
Falloff Subpanel.....	20
Type Texture.....	21
Settings Subpanel.....	21
Falloff Subpanel.....	23
Type Curve Guide.....	23
Settings subpanel.....	24
Type Boid.....	25
Settings Subpanel.....	25
Falloff Subpanel.....	26
Type Turbulence.....	27
Settings Subpanel.....	27
Falloff Subpanel.....	28
Type Drag.....	29
Settings Subpanel.....	29
Falloff Subpanel.....	30
Type Fluid Flow.....	31
Settings Subpanel.....	31
Falloff Subpanel.....	32

Detailed table of content

Detailed table of content

Detailed table of content.....	1
Force Fields panel.....	7
Type.....	7
Type Force.....	8
Settings subpanel.....	8
Shape.....	8
Strength.....	8
Flow / Inflow.....	8
Affect.....	8
Location.....	8
Rotation.....	8
Noise Amount.....	8
Seed.....	8
Gravitation.....	9
Absorption.....	9
Wind Factor.....	9
Falloff Subpanel.....	9
Shape.....	9
Sphere.....	9
Tube.....	9
Cone.....	9
Z Direction.....	9
Power (Power).....	9
Min Distance.....	9
Max Distance.....	10
Type Wind.....	10
Settings Subpanel.....	10
Shape.....	10
Strength.....	10
Flow / Inflow.....	10
Affect.....	10
Location.....	10
Rotation.....	10
Noise Amount.....	10
Seed.....	10
Absorption.....	10
Wind Factor.....	11
Falloff Subpanel.....	11
Shape.....	11
Sphere.....	11
Tube.....	11
Cone.....	11
Z Direction.....	11
Power (Power).....	11
Min Distance.....	11
Max Distance.....	11
Type Vortex.....	12
Settings Subpanel.....	12
Shape.....	12
Strength.....	12
Flow / Inflow.....	12

Affect.....	12
Location.....	12
Rotation.....	12
Noise Amount.....	12
Seed.....	12
Absorption.....	12
Wind Factor.....	12
Falloff Subpanel.....	13
Shape.....	13
Sphere.....	13
Tube.....	13
Cone.....	13
Z Direction.....	13
Power (Power).....	13
Min Distance.....	13
Max Distance.....	13
Type Magnetic.....	14
Settings Subpanel.....	14
Shape.....	14
Strength.....	14
Flow.....	14
Affect.....	14
Location.....	14
Rotation.....	14
Noise Amount.....	14
Seed.....	14
Absorption.....	14
Wind Factor.....	14
Falloff Subpanel.....	15
Shape.....	15
Sphere.....	15
Tube.....	15
Cone.....	15
Z Direction.....	15
Power (Power).....	15
Min Distance.....	15
Max Distance.....	15
Type Harmonic.....	15
Settings Subpanel.....	16
Shape.....	16
Strength.....	16
Damping.....	16
Rest Length.....	16
Affect.....	16
Location.....	16
Rotation.....	16
Noise Amount.....	16
Seed.....	16
Multiple Springs.....	16
Absorption.....	16
Wind Factor.....	16
Falloff Subpanel.....	17
Shape.....	17

Sphere.....	17
Tube.....	17
Cone.....	17
Z Direction.....	17
Power (Power).....	17
Min Distance.....	17
Max Distance.....	17
Type Charge.....	17
Settings Subpanel.....	18
Shape.....	18
Strength.....	18
Flow.....	18
Affect.....	18
Location.....	18
Rotation.....	18
Noise Amount.....	18
Seed.....	18
Absorption.....	18
Wind Factor.....	18
Falloff Subpanel.....	18
Shape.....	19
Sphere.....	19
Tube.....	19
Cone.....	19
Z Direction.....	19
Power (Power).....	19
Min Distance.....	19
Max Distance.....	19
Type Lennard Jones.....	19
Settings Subpanel.....	19
Shape.....	20
Strength.....	20
Flow.....	20
Affect.....	20
Location.....	20
Rotation.....	20
Noise Amount.....	20
Seed.....	20
Absorption.....	20
Wind Factor.....	20
Falloff Subpanel.....	20
Shape.....	20
Sphere.....	20
Tube.....	20
Cone.....	21
Z Direction.....	21
Power (Power).....	21
Min Distance.....	21
Max Distance.....	21
Type Texture.....	21
Settings Subpanel.....	21
Texture mode.....	21
RGB.....	21

Gradient.....	22
Curl.....	22
Strength.....	22
Affect.....	22
Location.....	22
Nabla.....	22
Use Coordinates.....	22
2D.....	22
Texture Sub Subpanel.....	22
Texture Property.....	22
Texture Browser.....	22
Name.....	22
Fake User.....	22
New Texture.....	22
Remove.....	22
Show Texture in Texture Tab.....	23
Falloff Subpanel.....	23
Shape.....	23
Sphere.....	23
Tube.....	23
Cone.....	23
Z Direction.....	23
Power (Power).....	23
Min Distance.....	23
Max Distance.....	23
Type Curve Guide.....	23
Settings subpanel.....	24
Minimum Distance.....	24
Free.....	24
Falloff Power.....	24
Additive.....	24
Weights.....	24
Clumping Amount.....	24
Shape.....	24
Use Max.....	24
Kink sub subpanel.....	25
Type.....	25
Curl.....	25
Radial.....	25
Wave.....	25
Braid.....	25
Roll.....	25
Axis.....	25
Frequency.....	25
Shape.....	25
Amplitude.....	25
Type Boid.....	25
Settings Subpanel.....	25
Shape.....	26
Strength.....	26
Flow.....	26
Affect.....	26
Location.....	26

Rotation.....	26
Noise Amount.....	26
Seed.....	26
Absorption.....	26
Wind Factor.....	26
Falloff Subpanel.....	26
Shape.....	26
Sphere.....	26
Tube.....	27
Cone.....	27
Z Direction.....	27
Power (Power).....	27
Min Distance.....	27
Max Distance.....	27
Type Turbulence.....	27
Settings Subpanel.....	27
Shape.....	27
Strength.....	28
Size.....	28
Flow.....	28
Affect.....	28
Location.....	28
Rotation.....	28
Noise Amount.....	28
Seed.....	28
Global.....	28
Absorption.....	28
Wind Factor.....	28
Falloff Subpanel.....	28
Shape.....	28
Sphere.....	28
Tube.....	29
Cone.....	29
Z Direction.....	29
Power (Power).....	29
Min Distance.....	29
Max Distance.....	29
Type Drag.....	29
Settings Subpanel.....	29
Shape.....	29
Linear.....	29
Quadratic.....	30
Affect.....	30
Location.....	30
Rotation.....	30
Noise Amount.....	30
Seed.....	30
Absorption.....	30
Wind Factor.....	30
Falloff Subpanel.....	30
Shape.....	30
Sphere.....	30
Tube.....	30

Cone.....	30
Z Direction.....	30
Power (Power).....	31
Min Distance.....	31
Max Distance.....	31
Type Fluid Flow.....	31
Settings Subpanel.....	31
Shape.....	31
Strength.....	31
Flow.....	31
Affect.....	31
Location.....	31
Rotation.....	32
Domain Object.....	32
Apply Density.....	32
Falloff Subpanel.....	32
Shape.....	32
Sphere.....	32
Tube.....	32
Cone.....	32
Z Direction.....	32
Power (Power).....	32
Min Distance.....	32
Max Distance.....	32

Force Fields panel

Force Fields offer a way to add extra movement to dynamic systems like Particles, Soft Bodies, Rigid Bodies and Cloth objects.

Note that when you work with particles, softbody or cloth system and change one of the force fields parameters, then you need to recalculate the particles, softbody or cloth systems.

Type

There are several force field types available.

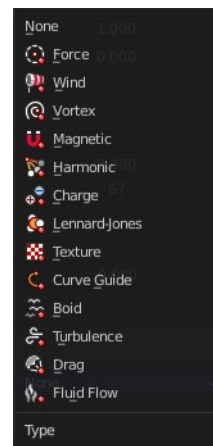

Type Force

A Force type force field gives a constant force towards (positive strength) or away from (negative strength) the object's center.

For Boids a field with positive strength can be used as a Goal. A field with negative strength can be used as Predator. Whether Boids seek or fly goals/predators depends on the Physics settings of the Boids.

Settings subpanel

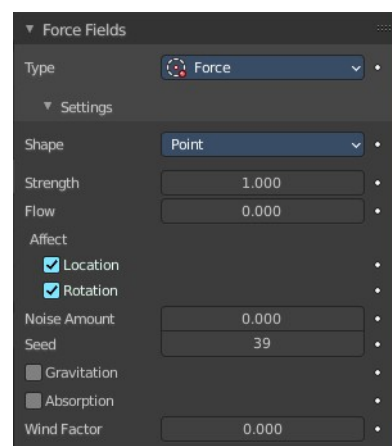

Shape

The direction that is used to calculate the effector force.

Strength

The strength of the force.

Flow / Inflow

Convert effector force into air force velocity / Inwards component of the force.

Affect

Location

Affect the location of the particles.

Rotation

Affect the rotation of the particles.

Noise Amount

Amount of noise for the force effect.

Seed

The random seed for the noise amount.



Gravitation

Multiply force by 1 divided through the distance in square.

Absorption

Force gets absorbed by collision objects.

Wind Factor

How much the force is reduced when acting parallel to a surface. Like a cloth.

Falloff Subpanel

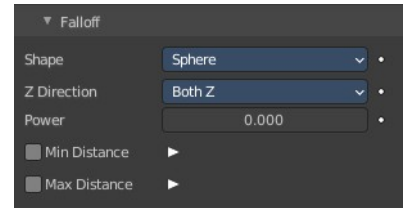

Shape

Sphere

Falloff is uniform in all directions, as in a sphere.

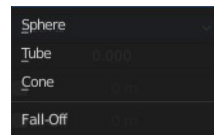

Tube

Fall off results in a tube shaped force field. The Field's Radial falloff can be adjusted, as well as the Minimum and Maximum distances of the field.

Cone

Fall off results in a cone shaped force field. Additional options are the same as those of Tube options.

Z Direction

Fall-off can be set to apply only in the direction of the positive Z Axis, negative Z Axis, or both.

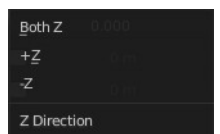

Power (Power)

How the power of the force field changes with the distance from the force field. If r is the distance from the center of the object, the force changes with $1/r^{\text{Power}}$. A Fall-off of 2 changes the force field with $1/r^2$, which is the falloff of gravitational pull.

Min Distance

The distance from the object center, up to where the force field is effective with full strength. If you have a Fall-off of 0 this parameter does nothing, because the field is effective with full strength up to Max Dist (or the infinity). Shown by an additional circle around the object.

Max Distance

Makes the force field only take effect within a specified maximum radius (shown by an additional circle around the object).

Type Wind

Constant force along the Z axis.

Settings Subpanel

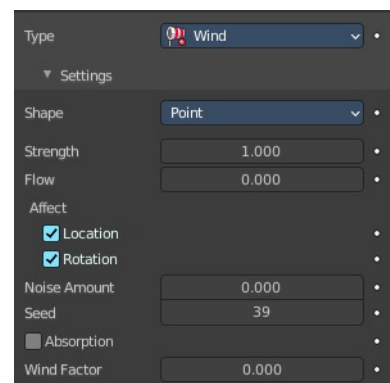

Shape

The direction that is used to calculate the effector force.

Strength

The strength of the force.

Flow / Inflow

Convert effector force into air force velocity / Inwards component of the force.

Affect

Location

Affect the location of the particles.

Rotation

Affect the rotation of the particles.

Noise Amount

Amount of noise for the force effect.

Seed

The random seed for the noise amount.

Absorption

Force gets absorbed by collision objects.

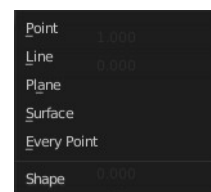

Wind Factor

How much the force is reduced when acting parallel to a surface. Like a cloth.

Falloff Subpanel

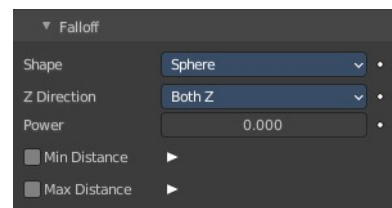

Shape

Sphere

Falloff is uniform in all directions, as in a sphere.

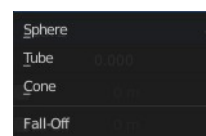

Tube

Fall off results in a tube shaped force field. The Field's Radial falloff can be adjusted, as well as the Minimum and Maximum distances of the field.

Cone

Fall off results in a cone shaped force field. Additional options are the same as those of Tube options.

Z Direction

Fall-off can be set to apply only in the direction of the positive Z Axis, negative Z Axis, or both.

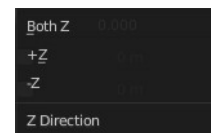

Power (Power)

How the power of the force field changes with the distance from the force field. If r is the distance from the center of the object, the force changes with $1/r^{\text{Power}}$. A Fall-off of 2 changes the force field with $1/r^2$, which is the falloff of gravitational pull.

Min Distance

The distance from the object center, up to where the force field is effective with full strength. If you have a Fall-off of 0 this parameter does nothing, because the field is effective with full strength up to Max Dist (or the infinity). Shown by an additional circle around the object.

Max Distance

Makes the force field only take effect within a specified maximum radius (shown by an additional circle around the object).

Type Vortex

Spiraling force that twists the force object's local Z axis. Use case could be a tornado for example.

Settings Subpanel

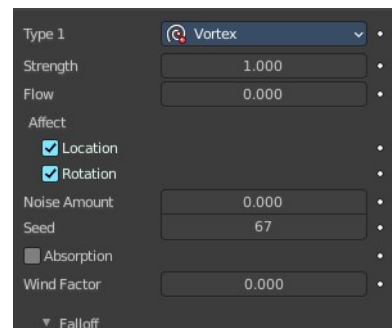

Shape

The direction that is used to calculate the effector force.

Strength

The strength of the force.

Flow / Inflow

Convert effector force into air force velocity / Inwards component of the force.

Affect

Location

Affect the location of the particles.

Rotation

Affect the rotation of the particles.

Noise Amount

Amount of noise for the force effect.

Seed

The random seed for the noise amount.

Absorption

Force gets absorbed by collision objects.

Wind Factor

How much the force is reduced when acting parallel to a surface. Like a cloth.



Falloff Subpanel

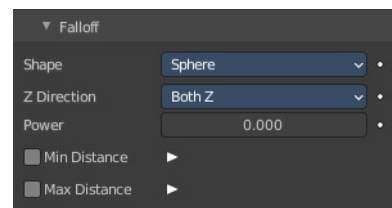

Shape

Sphere

Falloff is uniform in all directions, as in a sphere.

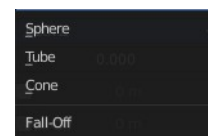

Tube

Fall off results in a tube shaped force field. The Field's Radial falloff can be adjusted, as well as the Minimum and Maximum distances of the field.

Cone

Fall off results in a cone shaped force field. Additional options are the same as those of Tube options.

Z Direction

Fall-off can be set to apply only in the direction of the positive Z Axis, negative Z Axis, or both.

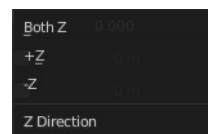

Power (Power)

How the power of the force field changes with the distance from the force field. If r is the distance from the center of the object, the force changes with $1/r^{\text{Power}}$. A Fall-off of 2 changes the force field with $1/r^2$, which is the falloff of gravitational pull.

Min Distance

The distance from the object center, up to where the force field is effective with full strength. If you have a Fall-off of 0 this parameter does nothing, because the field is effective with full strength up to Max Dist (or the infinity). Shown by an additional circle around the object.

Max Distance

Makes the force field only take effect within a specified maximum radius (shown by an additional circle around the object).

Type Magnetic

A magnetic force field simulates the force of magnetism on magnetized objects.

Settings Subpanel

Shape

The direction that is used to calculate the effector force.

Strength

The strength of the force.

Flow

Convert effector force into air force velocity.

Affect

Location

Affect the location of the particles.

Rotation

Affect the rotation of the particles.

Noise Amount

Amount of noise for the force effect.

Seed

The random seed for the noise amount.

Absorption

Force gets absorbed by collision objects.

Wind Factor

How much the force is reduced when acting parallel to a surface. Like a cloth.

Falloff Subpanel

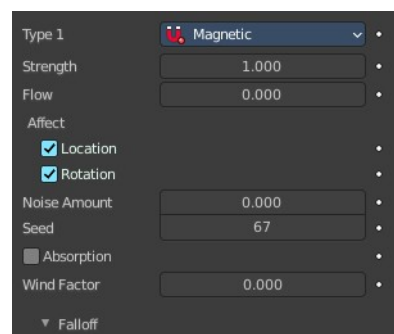

Shape

Sphere

Falloff is uniform in all directions, as in a sphere.

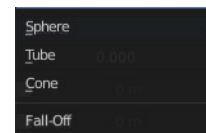

Tube

Fall off results in a tube shaped force field. The Field's Radial falloff can be adjusted, as well as the Minimum and Maximum distances of the field.

Cone

Fall off results in a cone shaped force field. Additional options are the same as those of Tube options.

Z Direction

Fall-off can be set to apply only in the direction of the positive Z Axis, negative Z Axis, or both.

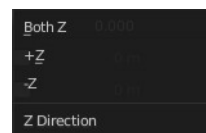

Power (Power)

How the power of the force field changes with the distance from the force field. If r is the distance from the center of the object, the force changes with $1/r^{\text{Power}}$. A Fall-off of 2 changes the force field with $1/r^2$, which is the falloff of gravitational pull.

Min Distance

The distance from the object center, up to where the force field is effective with full strength. If you have a Fall-off of 0 this parameter does nothing, because the field is effective with full strength up to Max Dist (or the infinity). Shown by an additional circle around the object.

Max Distance

Makes the force field only take effect within a specified maximum radius (shown by an additional circle around the object).

Type Harmonic

The source of this force field is the zero point of a harmonic oscillator. If you set the *Damping* parameter to 1, the movement is stopped in the moment the object is reached.

Settings Subpanel

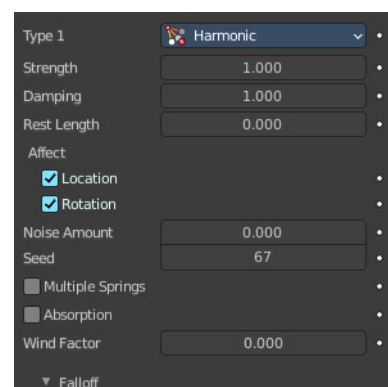

Shape

The direction that is used to calculate the effector force.



Strength

The strength of the force.

Damping

Damping of the harmonic force.

Rest Length

The rest length of the harmonic force.

Affect

Location

Affect the location of the particles.

Rotation

Affect the rotation of the particles.

Noise Amount

Amount of noise for the force effect.

Seed

The random seed for the noise amount.

Multiple Springs

Every point is effected by multiple springs.

Absorption

Force gets absorbed by collision objects.

Wind Factor

How much the force is reduced when acting parallel to a surface. Like a cloth.

Falloff Subpanel

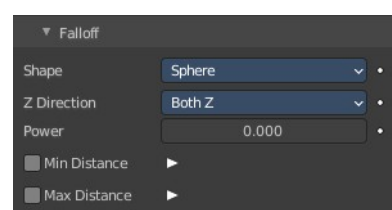

Shape

Sphere

Falloff is uniform in all directions, as in a sphere.

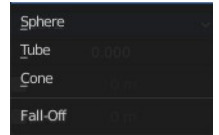

Tube

Fall off results in a tube shaped force field. The Field's Radial falloff can be adjusted, as well as the Minimum and Maximum distances of the field.

Cone

Fall off results in a cone shaped force field. Additional options are the same as those of Tube options.

Z Direction

Fall-off can be set to apply only in the direction of the positive Z Axis, negative Z Axis, or both.

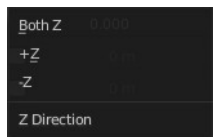

Power (Power)

How the power of the force field changes with the distance from the force field. If r is the distance from the center of the object, the force changes with $1/r^{\text{Power}}$. A Fall-off of 2 changes the force field with $1/r^2$, which is the falloff of gravitational pull.

Min Distance

The distance from the object center, up to where the force field is effective with full strength. If you have a Fall-off of 0 this parameter does nothing, because the field is effective with full strength up to Max Dist (or the infinity). Shown by an additional circle around the object.

Max Distance

Makes the force field only take effect within a specified maximum radius (shown by an additional circle around the object).

Type Charge

Special force field based on the charge of particles. Charge force fields just affects other charge force fields.

Settings Subpanel

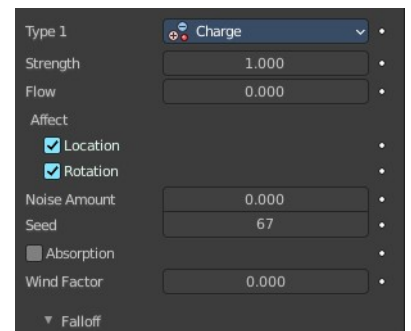

Shape

The direction that is used to calculate the effector force.

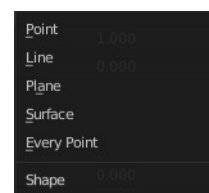

Strength

The strength of the force.

Flow

Convert effector force into air force velocity.

Affect

Location

Affect the location of the particles.

Rotation

Affect the rotation of the particles.

Noise Amount

Amount of noise for the force effect.

Seed

The random seed for the noise amount.

Absorption

Force gets absorbed by collision objects.

Wind Factor

How much the force is reduced when acting parallel to a surface. Like a cloth.

Falloff Subpanel

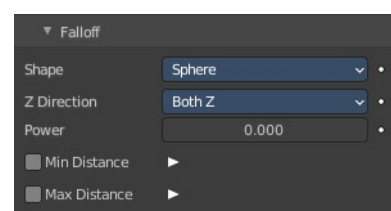

Shape

Sphere

Falloff is uniform in all directions, as in a sphere.



Tube

Fall off results in a tube shaped force field. The Field's Radial falloff can be adjusted, as well as the Minimum and Maximum distances of the field.

Cone

Fall off results in a cone shaped force field. Additional options are the same as those of Tube options.

Z Direction

Fall-off can be set to apply only in the direction of the positive Z Axis, negative Z Axis, or both.



Power (Power)

How the power of the force field changes with the distance from the force field. If r is the distance from the center of the object, the force changes with $1/r^{\text{Power}}$. A Fall-off of 2 changes the force field with $1/r^2$, which is the falloff of gravitational pull.

Min Distance

The distance from the object center, up to where the force field is effective with full strength. If you have a Fall-off of 0 this parameter does nothing, because the field is effective with full strength up to Max Dist (or the infinity). Shown by an additional circle around the object.

Max Distance

Makes the force field only take effect within a specified maximum radius (shown by an additional circle around the object).

Type Lennard Jones

Force field based on the Lennard-Jones potential. The Lennard-Jones potential describes the interactions of two neutral particles using a relatively simple mathematical model. At a distance smaller than the combined sizes the field is very repulsive and after that distance it's attractive.

Particles can have for example both a charge and a Lennard-Jones potential.

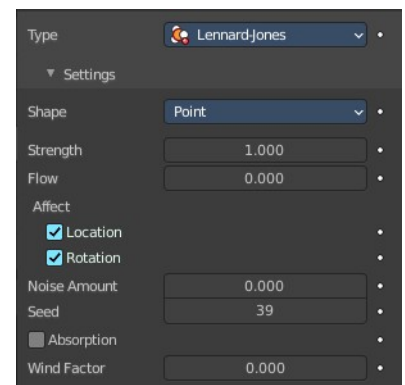

Settings Subpanel

Shape

The direction that is used to calculate the effector force.

Strength

The strength of the force.



Flow

Convert effector force into air force velocity.

Affect

Location

Affect the location of the particles.

Rotation

Affect the rotation of the particles.

Noise Amount

Amount of noise for the force effect.

Seed

The random seed for the noise amount.

Absorption

Force gets absorbed by collision objects.

Wind Factor

How much the force is reduced when acting parallel to a surface. Like a cloth.

Falloff Subpanel

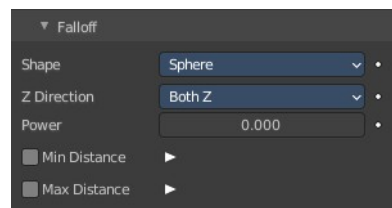

Shape

Sphere

Falloff is uniform in all directions, as in a sphere.



Tube

Fall off results in a tube shaped force field. The Field's Radial falloff can be adjusted, as well as the Minimum and Maximum distances of the field.

Cone

Fall off results in a cone shaped force field. Additional options are the same as those of Tube options.

Z Direction

Fall-off can be set to apply only in the direction of the positive Z Axis, negative Z Axis, or both.

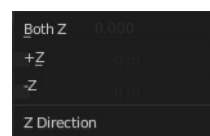

Power (Power)

How the power of the force field changes with the distance from the force field. If r is the distance from the

center of the object, the force changes with $1/r^{\text{Power}}$. A Fall-off of 2 changes the force field with $1/r^2$, which is the falloff of gravitational pull.

Min Distance

The distance from the object center, up to where the force field is effective with full strength. If you have a Fall-off of 0 this parameter does nothing, because the field is effective with full strength up to Max Dist (or the infinity). Shown by an additional circle around the object.

Max Distance

Makes the force field only take effect within a specified maximum radius (shown by an additional circle around the object).

Type Texture

Adds a force field based on a texture. The force in the 3 directions is color coded.

Red is coding for the x-axis, green for the y-axis and blue for the z-axis. A value of 0.5 means no force, a value larger than 0.5 acceleration in negative axis direction (like -Z), a value smaller than 0.5 acceleration in positive axis direction (like +Z).

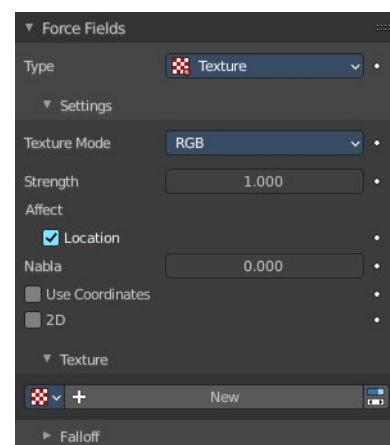

Settings Subpanel

Texture mode

This sets the way a force vector is derived from the texture.

RGB

Uses the color components directly as the force vector components in the color encoded directions. You need an RGB texture for this, e.g. an image or a color band. So a Blend texture without a color band would not suffice.

Gradient

Calculates the force vector as the 3d-gradient of the intensity (greyscale) of the texture. The gradient vector always points to the direction of increasing brightness.

Curl

Calculates the force vector from the curl of the 3d-rgb texture (rotation of rgb vectors). This also works only with a color texture. It can be used for example to create a nice looking turbulence force with a color clouds texture with Perlin noise.

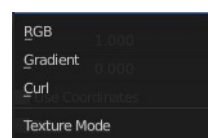

Strength

The strength of the force.

Affect

Location

Affect the location of the particles.

Nabla

It is the offset used to calculate the partial derivatives needed for Gradient and Curl texture modes.

Use Coordinates

Uses the emitter object coordinates as the texture space the particles use.

2D

Apply force only in 2D.

Texture Sub Subpanel

Texture Property

Texture Browser

A list of the available textures in the scene.

Name

The name of the currently active texture. You can rename the texture here by clicking at the edit box.

Fake User

Keep this texture in the scene even if it has no user.

New Texture

Add a new texture.

Remove

Remove the texture.

Show Texture in Texture Tab

Jumps to the texture tab where you can edit your texture.

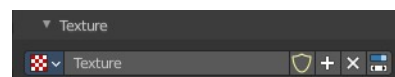

Falloff Subpanel

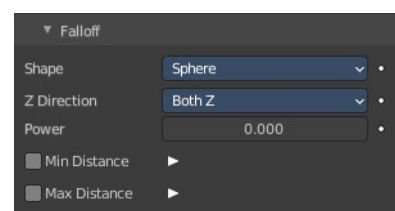

Shape

Sphere

Falloff is uniform in all directions, as in a sphere.

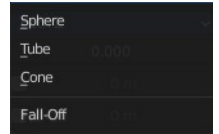

Tube

Fall off results in a tube shaped force field. The Field's Radial falloff can be adjusted, as well as the Minimum and Maximum distances of the field.

Cone

Fall off results in a cone shaped force field. Additional options are the same as those of Tube options.

Z Direction

Fall-off can be set to apply only in the direction of the positive Z Axis, negative Z Axis, or both.

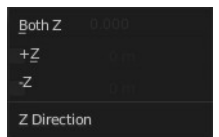

Power (Power)

How the power of the force field changes with the distance from the force field. If r is the distance from the center of the object, the force changes with $1/r^{\text{Power}}$. A Fall-off of 2 changes the force field with $1/r^2$, which is the falloff of gravitational pull.

Min Distance

The distance from the object center, up to where the force field is effective with full strength. If you have a Fall-off of 0 this parameter does nothing, because the field is effective with full strength up to Max Dist (or the infinity). Shown by an additional circle around the object.

Max Distance

Makes the force field only take effect within a specified maximum radius (shown by an additional circle around the object).

Type Curve Guide

Creates a force along a curve object.

A typical scenario would be to move a red blood cell inside a vein, or to animate the particle flow in a motor. You can use Curve Guide s also to shape certain hair strands.

Note! You can also use the Particle Mode to define a path.

The option Curve Follow does not work for particles. Instead you have to set Angular Velocity in the Physics panel of the Particle sub-context to Spin and leave the rotation constant. For example don't turn on Dynamic.

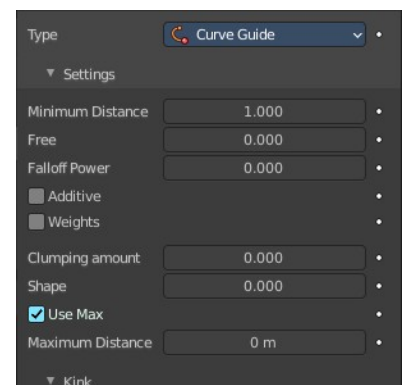

Curve Guides affect all particles on the same layer, independently from their distance to the curve. If you have several guides in a layer, their fields add up to each other (the way you may have learned it in your physics course). But you can limit their influence radius by changing their Minimum Distance (see below).

Note! The Curve Guide does not effect Softbodies.

Settings subpanel

Minimum Distance

The distance from the curve, up to where the force field is effective with full strength. If you have a Fall-off of 0 this parameter does nothing, because the field is effective with full strength up to MaxDist (or the infinity). MinDist is shown with a circle at the endpoints of the curve in the 3D window.

Free

Fraction of particle life time, that is not used for the curve.

Falloff Power

How quickly strength falls off with distance from the force field. A Fall-off of 1 means a linear progression.

Additive

If you use Additive, the speed of the particles is also evaluated depending on the Fall-off.

Weights

Use Curve weights to influence the particle influence along the curve.

Clumping Amount

The particles come together at the end of the curve (1) or they drift apart (-1).

Shape

Defines the form in which the particles come together. +0.99: the particles meet at the end of the curve. 0: linear progression along the curve. -0.99: the particles meet at the beginning of the curve.

Use Max

The maximum influence radius. Shown by an additional circle around the curve object.

The other settings govern the form of the force field along the curve.

Kink sub subpanel

Kink changes the shape that the particles can take. It adds an offset.

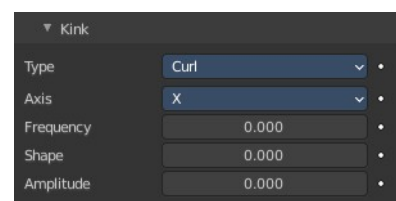

Type

Curl

The radius of the influence depends on the distance of the curve to the emitter.

Radial

A three dimensional, standing wave.

Wave

A two dimensional, standing wave.

Braid

Braid.

Roll

A one dimensional, standing wave.

Axis

Which axis to use for the offset.

Frequency

The frequency of the offset.

Shape

Adjust the offset to the beginning/end.

Amplitude

The Amplitude of the offset.

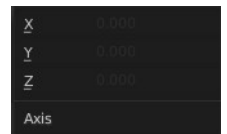
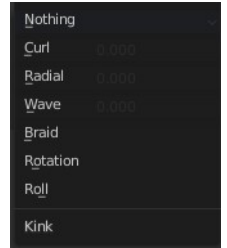

Type Boid

Creates a force that acts as a boid's predator or target. Boids simulates the flocking behavior of birds.

Settings Subpanel

Shape

The direction that is used to calculate the effector force.

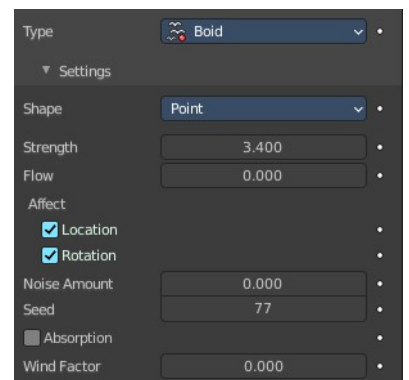

Strength

The strength of the force.

Flow

Convert effector force into air force velocity.

Affect

Location

Affect the location of the particles.

Rotation

Affect the rotation of the particles.

Noise Amount

Amount of noise for the force effect.

Seed

The random seed for the noise amount.

Absorption

Force gets absorbed by collision objects.

Wind Factor

How much the force is reduced when acting parallel to a surface. Like a cloth.

Falloff Subpanel

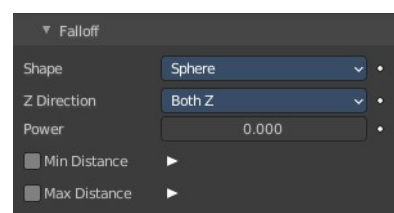

Shape

Sphere

Falloff is uniform in all directions, as in a sphere.

Tube

Fall off results in a tube shaped force field. The Field's Radial falloff can be adjusted, as well as the Minimum and Maximum distances of the field.



Cone

Fall off results in a cone shaped force field. Additional options are the same as those of Tube options.

Z Direction

Fall-off can be set to apply only in the direction of the positive Z Axis, negative Z Axis, or both.

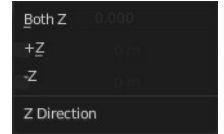

Power (Power)

How the power of the force field changes with the distance from the force field. If r is the distance from the center of the object, the force changes with $1/r^{\text{Power}}$. A Fall-off of 2 changes the force field with $1/r^2$, which is the falloff of gravitational pull.

Min Distance

The distance from the object center, up to where the force field is effective with full strength. If you have a Fall-off of 0 this parameter does nothing, because the field is effective with full strength up to Max Dist (or the infinity). Shown by an additional circle around the object.

Max Distance

Makes the force field only take effect within a specified maximum radius (shown by an additional circle around the object).

Type Turbulence

Create turbulence with a noise field. This creates a random and chaotic 3D noise effect.

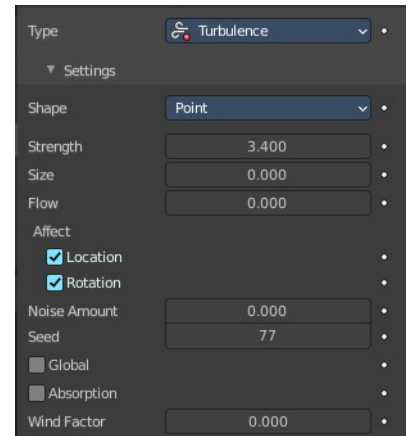

Settings Subpanel

Shape

The direction that is used to calculate the effector force.

Strength

The strength of the force.



Size

The size of the turbulence.

Flow

Convert effector force into air force velocity.

Affect

Location

Affect the location of the particles.

Rotation

Affect the rotation of the particles.

Noise Amount

Amount of noise for the force effect.

Seed

The random seed for the noise amount.

Global

Use global coordinates for the turbulence.

Absorption

Force gets absorbed by collision objects.

Wind Factor

How much the force is reduced when acting parallel to a surface. Like a cloth.

Falloff Subpanel

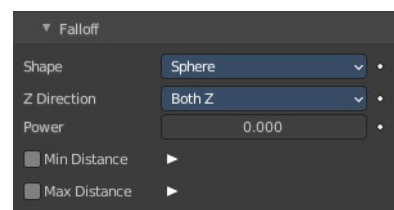

Shape

Sphere

Falloff is uniform in all directions, as in a sphere.

Tube

Fall off results in a tube shaped force field. The Field's Radial falloff can be adjusted, as well as the Minimum and Maximum distances of the field.

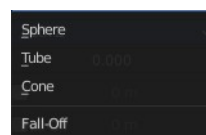

Cone

Fall off results in a cone shaped force field. Additional options are the same as those of Tube options.

Z Direction

Fall-off can be set to apply only in the direction of the positive Z Axis, negative Z Axis, or both.

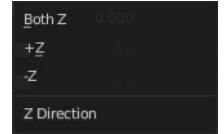

Power (Power)

How the power of the force field changes with the distance from the force field. If r is the distance from the center of the object, the force changes with $1/r^{\text{Power}}$. A Fall-off of 2 changes the force field with $1/r^2$, which is the falloff of gravitational pull.

Min Distance

The distance from the object center, up to where the force field is effective with full strength. If you have a Fall-off of 0 this parameter does nothing, because the field is effective with full strength up to Max Dist (or the infinity). Shown by an additional circle around the object.

Max Distance

Makes the force field only take effect within a specified maximum radius (shown by an additional circle around the object).

Type Drag

Create a force that dampens motion. The particles motion is slowing down.

Settings Subpanel

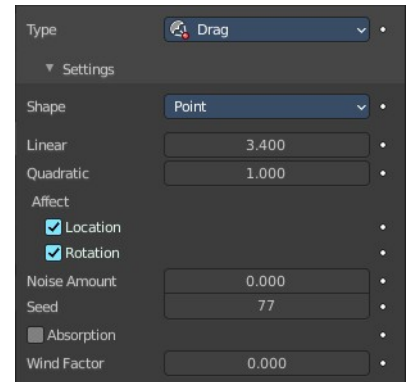

Shape

The direction that is used to calculate the effector force.



Linear

Drag component proportional to velocity.

Quadratic

Drag component proportional to square velocity.

Affect

Location

Affect the location of the particles.

Rotation

Affect the rotation of the particles.

Noise Amount

Amount of noise for the force effect.

Seed

The random seed for the noise amount.

Absorption

Force gets absorbed by collision objects.

Wind Factor

How much the force is reduced when acting parallel to a surface. Like a cloth.

Falloff Subpanel

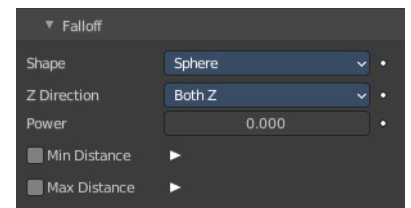

Shape

Sphere

Falloff is uniform in all directions, as in a sphere.

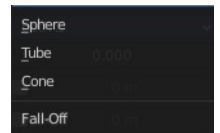

Tube

Fall off results in a tube shaped force field. The Field's Radial falloff can be adjusted, as well as the Minimum and Maximum distances of the field.

Cone

Fall off results in a cone shaped force field. Additional options are the same as those of Tube options.

Z Direction

Fall-off can be set to apply only in the direction of the positive Z Axis, negative Z Axis, or both.

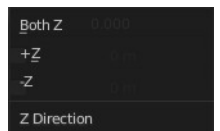

Power (Power)

How the power of the force field changes with the distance from the force field. If r is the distance from the center of the object, the force changes with $1/r^{\text{Power}}$. A Fall-off of 2 changes the force field with $1/r^2$, which is the falloff of gravitational pull.

Min Distance

The distance from the object center, up to where the force field is effective with full strength. If you have a Fall-off of 0 this parameter does nothing, because the field is effective with full strength up to Max Dist (or the infinity). Shown by an additional circle around the object.

Max Distance

Makes the force field only take effect within a specified maximum radius (shown by an additional circle around the object).

Type Fluid Flow

Create a force field based on fluid simulation velocities.

Settings Subpanel

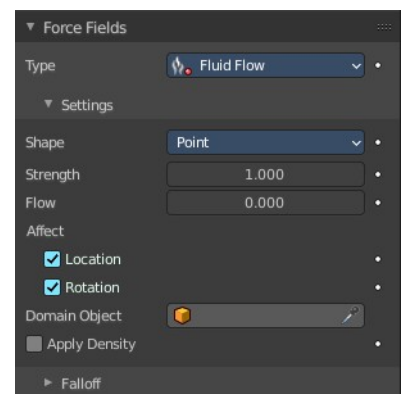

Shape

The direction that is used to calculate the effector force.

Strength

The strength of the force.

Flow

Convert effector force into air force velocity.

Affect

Location

Affect the location of the particles.

Rotation

Affect the rotation of the particles.



Domain Object

Select Domain object of the smoke simulation.

Apply Density

Adjust force strength based on smoke density.

Falloff Subpanel

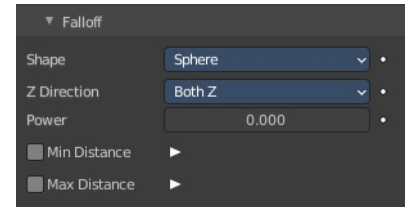

Shape

Sphere

Falloff is uniform in all directions, as in a sphere.

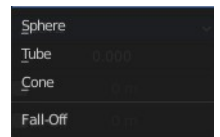

Tube

Fall off results in a tube shaped force field. The Field's Radial falloff can be adjusted, as well as the Minimum and Maximum distances of the field.

Cone

Fall off results in a cone shaped force field. Additional options are the same as those of Tube options.

Z Direction

Fall-off can be set to apply only in the direction of the positive Z Axis, negative Z Axis, or both.

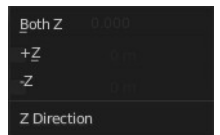

Power (Power)

How the power of the force field changes with the distance from the force field. If r is the distance from the center of the object, the force changes with $1/r^{\text{Power}}$. A Fall-off of 2 changes the force field with $1/r^2$, which is the falloff of gravitational pull.

Min Distance

The distance from the object center, up to where the force field is effective with full strength. If you have a Fall-off of 0 this parameter does nothing, because the field is effective with full strength up to Max Dist (or the infinity). Shown by an additional circle around the object.

Max Distance

Makes the force field only take effect within a specified maximum radius (shown by an additional circle around the object).



26.12.2 Editors - Properties Editor - Physics Properties Tab - Collision panel

Table of content

Collision.....	1
Hints!.....	1
Field Absorption.....	2
Particle subpanel.....	2
Permeability.....	2
Stickiness.....	2
Kill Particles.....	2
Damping.....	2
Randomize.....	2
Friction.....	2
Randomize.....	2
Soft Body and Cloth subpanel.....	2
Damping.....	3
Thickness Outer.....	3
Inner.....	3
Friction.....	3
Single Sided.....	3
Override Normals.....	3

Collision

Collision sets the mesh object as a static collider. Particles, Soft Bodies and Cloth objects may collide with mesh objects. Boids try to avoid Collision objects.

Once you add a collision to a mesh a modifier gets created in the modifier properties tab. Here you can add other modifiers that may interact with the collision. But the collision settings are just accessible from the physics tab.

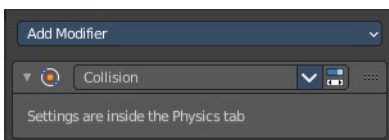
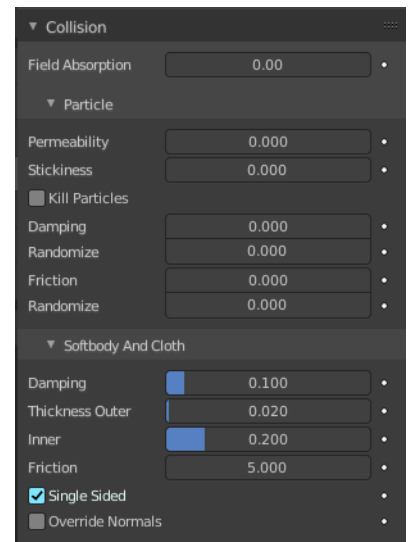

Hints!

You may limit the effect on particles to a group of objects. This can be done in the Field Weights panel in the particles tab of the object with the particles.

Make sure that the normals of the mesh surface are facing towards the particles/points for correct deflection.

Hair particles react directly to force fields, so if you use a force field with a short range you do not need necessarily collision.

Hair particles avoid their emitting mesh if you edit them in Particle Edit Mode. So you can at least model the hair with collision.

Hair particles ignore deflecting objects. But you can animate them as soft bodies which take deflection into account.

Soft body collisions can make problems if one of the objects move too fast. Then the soft body will penetrate the mesh.

If you change the deflection settings for an object you have to recalculate the particle, soft body or cloth system by Delete Bake, this is not done automatically.

Field Absorption

A deflector can also deflect effectors. You can specify some collision/deflector objects which deflect a specific portion of the effector force using the Field Absorption value. 100% absorption results in no force getting through the collision/deflector object at all. If you have three collision object behind each other with e.g. 10%, 43% and 3%, the absorption ends up at around 50% $100 \times (1-0.1) \times (1-0.43) \times (1-0.03)$.

Particle subpanel

Permeability

Fraction of particles passing through the mesh.

Stickiness

How much particles stick to the object.

Kill Particles

Deletes Particles upon impact.

Damping

Damping during a collision (independent of the velocity of the particles).

Randomize

Random variation of damping.

Friction

Friction during movements along the surface.

Randomize

Random variation of friction.

Soft Body and Cloth subpanel

It is important to note that this collision panel is used to tell all simulations that this object is to participate in

colliding/deflecting other objects on a shared layer (particles, soft bodies, and cloth).

Note! The object's shape deforms the cloth, so the cloth simulation must be inputted the "true" shape of that mesh object at that frame. This true shape is the basis shape as modified by shape keys or armatures. Therefore, the Collision Modifier must be after any of those. The image to the right shows the Modifiers panel for the Character mesh object (not the cloth object).

Damping

Damping during a collision. The amount of bounce that the surfaces will have.

0.0 - No damping, soft bodies will have a maximum bounciness.

1.0 - Maximum damping, soft bodies will not bounce at all.

Thickness Outer

Size of the outer collision zone.

Adds a padding distance to the outside of each face, to help to prevent intersections. The soft body will come to rest at this distance away from the face of the colliding object. Outside and inside is defined by the face normal.

Inner

Size of the inner collision zone (padding distance).

Adds a padding distance to the inside of each face, to help to prevent intersections. The soft body will come to rest at this distance away from the face of the colliding object. Outside and inside is defined by the face normal.

Friction

A coefficient for how slippery the cloth is when it collides with itself. For example, silk has a lower coefficient of friction than cotton.

Single Sided

When enabled, cloth collisions are only performed on the normal side of the collider plane.

Override Normals

When enabled, cloth collision impulses act in the direction of the collider normals.



26.12.3 Editors - Properties Editor - Physics Properties Tab - Cloth panel

Table of content

Cloth Simulation.....	3
Workflow.....	3
Pinning.....	4
Cloth Panel.....	5
Presets.....	5
Quality Steps.....	5
Speed multiplier.....	5
Physical Properties subpanel.....	5
Vertex Mass.....	5
Air Viscosity.....	5
Bending Model.....	5
Angular.....	6
Linear.....	6
Stiffness sub subpanel.....	6
Tension.....	6
Compression.....	6
Structural.....	6
Shear.....	6
Bending.....	6
Damping sub subpanel.....	6
Tension.....	6
Compression.....	6
Structural.....	6
Shear.....	6
Bending.....	6
Internal Springs sub subpanel.....	7
Max Spring Creation Length.....	7
Max Creation Diversion.....	7
Check Surface Normals.....	7
Tension.....	7
Compression.....	7
Vertex Group.....	7
Max Tension.....	7
Max Compression.....	7
Pressure sub subpanel.....	7
Pressure.....	7
Custom Volume.....	8
Target Volume.....	8
Factor.....	8
Vertex Group.....	8
Cache subpanel.....	8
Hints.....	8
Caches List.....	9
Drag Handler.....	9
Search Field.....	9

Invert.....	9
Sort by Name.....	9
Add New Cache.....	9
Delete current Cache.....	9
Simulation start.....	9
End.....	9
Info string.....	10
Disk Cache.....	10
Use Library Path.....	10
Compression.....	10
None.....	10
Light.....	10
Heavy.....	10
Bake / Delete Bake.....	10
Calculate To Frame.....	10
Current Cache to Bake.....	10
Bake All Dynamics.....	11
Delete All Bakes.....	11
Update All To Frame.....	11
Shape subpanel.....	11
Pin Group.....	11
Stiffness.....	11
Sewing.....	11
Sewing Force Max.....	11
Shrinking Factor.....	12
Dynamic Mesh.....	12
Collisions subpanel.....	12
Troubleshooting.....	12
Quality.....	13
Object Collisions sub subpanel.....	13
Distance.....	13
Impulse Clamping.....	13
Collision Collection.....	13
Self-Collisions sub subpanel.....	13
Friction.....	14
Distance.....	14
Impulse Clamping.....	14
Vertex Group.....	14
Property Weights subpanel.....	14
Structural Group.....	14
Max Tension.....	14
Max Compression.....	14
Shear Group.....	14
Max Shearing.....	14
Bending Group.....	15
Max Bending.....	15
Shrinking Group.....	15
Max Shrinking.....	15
Field Weights subpanel.....	15

Cloth Simulation

Cloth simulation tries to simulate the look and behaviour of fabric. For example a flag in the wind. Or a shirt.

Cloth simulation requires a mesh object. It can be closed or open. Beware of the backside of faces then. And for closed meshes you better use soft bodies.

Once you add a cloth to a mesh a modifier gets created in the modifier properties tab. Here you can add other modifiers that may interact with the cloth simulation, like an SDS modifier. And order them in the proper way. It makes a difference if the SDS modifier is added before or after the cloth modifier.

And you can apply the cloth modifier, which freezes the simulation at the current frame. But the cloth settings are just accessible from the physics tab.

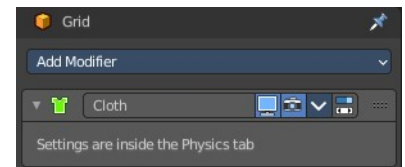
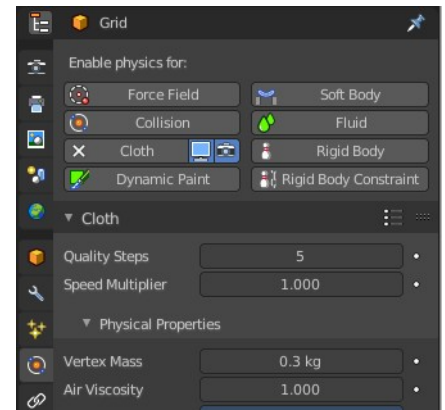

Workflow

Add a cube.

Add a grid plane. Move it up and scale it a bit bigger. So that it is above the cube.

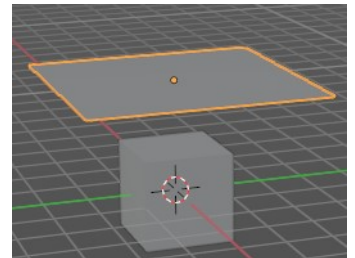

Add a collision physics to the cube. It is then set as a collider for the cloth simulation.

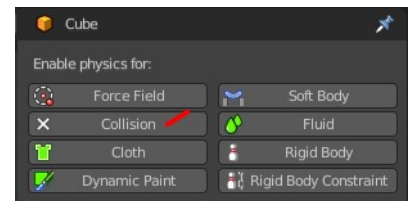

Add a cloth physics to the grid plane.

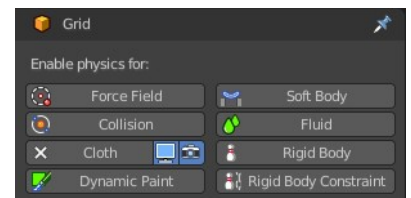

Add a subdivision surface modifier to the grid plane, and set it to simple.

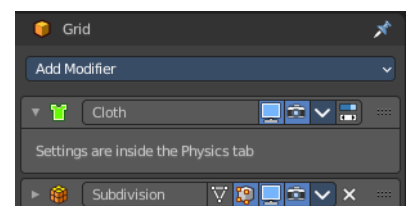

Now play the simulation. Playing it creates the simulation frames. Don't jump to frames. This will skip frames for the simulation.

The cloth will fall down now, collide with the cube, and deform like a fabric.

Adjust the cloth settings to your needs.

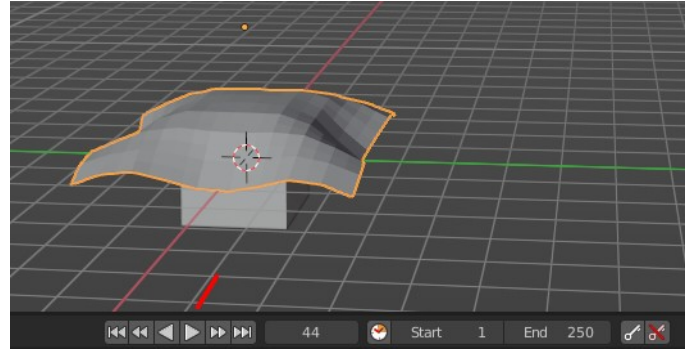

Pinning

Enter edit mode with the grid mesh. Grab one or more vertices. Add them to a vertex group. Don't forget to press Assign ...

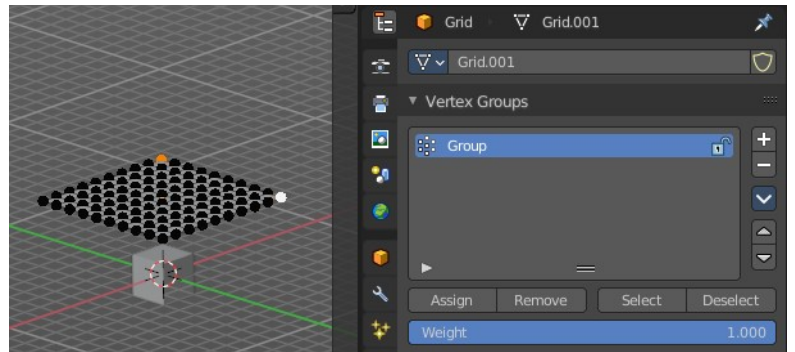

In the Shape subpanel, choose the vertex group into the Pin Group.

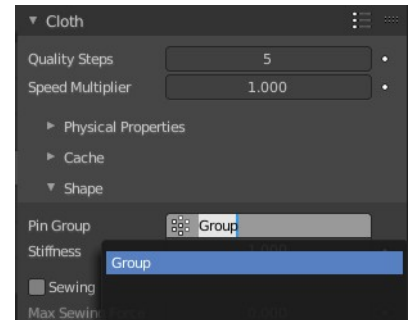

Switch to object mode. Play the animation again. You will notice that the two vertices in the vertex group are now pinned. And don't move down anymore.

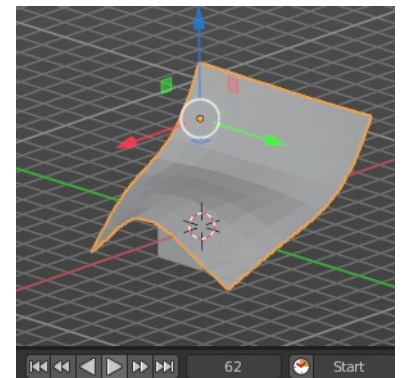

For a character you could now weight the pinned vertices to a bone. And the pinned vertices would move with the bone then.

Note

When animating or posing the character you must begin from the bind pose. Move the character to its initial pose over several frames so the physics engine can simulate the clothing moving. Very fast movements and teleport jumps can break the physics simulation.

Cloth Panel

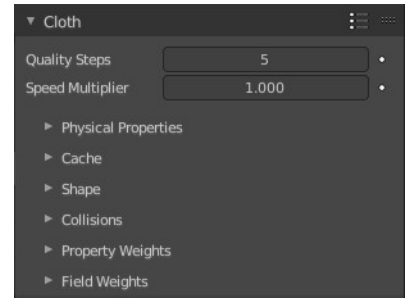

Presets

Cloth presets.

To add your own preset type in a name and click at the plus button behind the edit box. To remove a preset click at the minus button behind the preset.

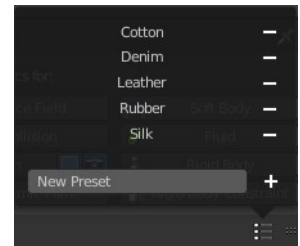

Quality Steps

Set the number of simulation steps per frame. Higher values result in better quality, but is slower.

Speed multiplier

The cloth speed is multiplied by this value.

Physical Properties subpanel

The physical settings for the cloth.

Vertex Mass

The mass of the cloth material.

Air Viscosity

Air has some thickness which slows falling things down.

Bending Model

Some settings are just available in angular bending model. Some just in linear bending model.

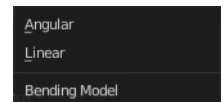
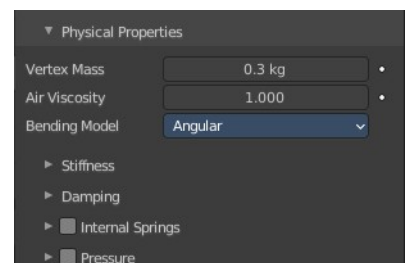

Angular

Cloth model with angular bending springs.

Linear

Cloth model with linear bending springs (old).

Stiffness sub subpanel

Tension

Angular bending. How much the material resists stretching.

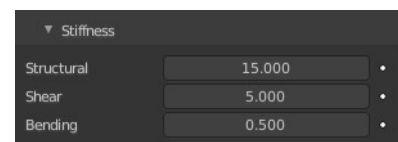
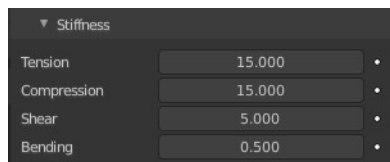

Compression

Angular Bending. How much the material resists compression.

Structural

Linear bending. Overall stiffness of the cloth.

Shear

How much the material resists shearing.

Bending

Wrinkle coefficient. Higher creates more large folds.

Damping sub subpanel

Tension

Angular bending. Amount of damping in stretching behavior.

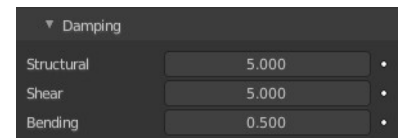
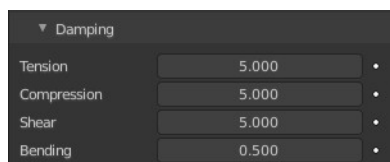

Compression

Angular bending. Amount of damping in compression behavior.

Structural

Linear bending. Amount of damping in stretching behavior (only in linear bending model).

Shear

Amount of damping in shearing behavior.

Bending

Amount of damping in bending behavior.

Internal Springs sub subpanel

Cloth physics are simulated through Springs connecting vertices on the surface of a mesh. But these springs only interact on the surface and only apply to 2D surfaces. 3D or Internal Springs can be used to make a mesh behave similarly to a Soft Body. Internal springs can be enabled by toggling the checkbox in the Internal Springs panel header.

You need to use the bending model Angular.

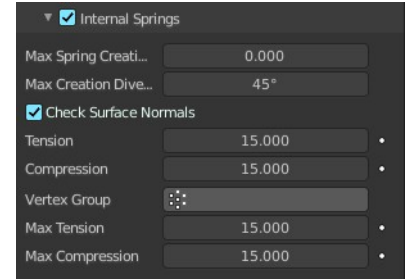

Max Spring Creation Length

The maximum length an internal spring can have during creation. If the distance between internal points is greater than this, no internal spring will be created between these points. A length of zero means that there is no length limit.

Max Creation Diversion

The maximum angle that is allowed to use to connect the internal points can diverge from the vertex normal.

Check Surface Normals

Requires the points the internal springs connect to have opposite normal directions.

Tension

How much the material resists stretching.

Compression

How much the material resists compression.

Vertex Group

The Tension and Compression of internal springs can be controlled via a Vertex Group to specify which the portions of the mesh have internal springs or the spring strength.

Max Tension

Maximum tension stiffness value.

Max Compression

Maximum Compression stiffness value.

Pressure sub subpanel

Cloth pressure allows the simulation of soft-shelled objects such as balloons or balls that are filled with some sort of fluid. Cloth pressure can be enabled by toggling the checkbox in the Pressure panel header.

Note! Non-manifold meshes will work with cloth pressure. But pressure will escape out of the mesh holes and cause drifting or propulsion forces. One way to get around this is by using the Vertex Group to exclude the non-manifold portions of the mesh.



Pressure

The uniform pressure that is constantly applied to the mesh. This value can be negative to simulate implosions or any other case where an object has outside pressure pushing inwards.

Custom Volume

Use the Target Volume parameter as the initial volume for the cloth. This avoids having to use the Pressure to first inflate the object.

Target Volume

The mesh volume where the inner/outer pressure will be the same. If set to zero the volume will not contribute to the total pressure.

Factor

Scalar control over the overall pressure.

Vertex Group

Cloth pressure can be controlled via a Vertex Group to specify which the portions of the mesh to apply pressure. Zero weight means no pressure while a weight of one means full pressure.

Note, faces with a vertex that has zero weight will be excluded from the Target Volume calculation.

Cache subpanel

The cloth simulation can be cached in memory or stored on a drive. This improves real-time response and avoids unnecessary recalculation of particles. But creates also big files.

The cloth system uses a unified system for caching and baking (together with Soft Body and Emitter particle).

Important! The file needs to be saved after baking. When the file is not saved then some options are not available.

Important! The cloth settings becomes unavailable once the particle cache is baked. You need to remove the bake when you want to change the settings.

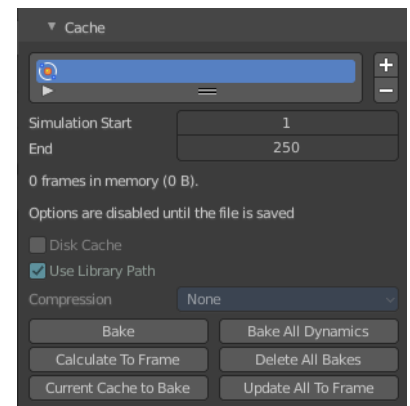

Hints

The simulation is only calculated for positive frames in between the Start and End frames of the Cache panel, whether you bake or not. So if you want a simulation that is longer than the default frame range, you have to change the End frame.

When an animation is played, each physics system writes each frame to the cache. Note that for the cache to fill up, one has to start the playback before or on the frame that the simulation starts.

The cache is cleared automatically on changes. But not on all changes, so it may be necessary to free it manually. For example if you change a force field.

The system is protected against changes after baking. If for example the mesh changes the simulation is not calculated anew.

The bake result can be cleared by clicking on the Free Bake button in the simulation cache settings.

A simulation can only be edited in Particle Edit Mode when it has been baked in memory. And cannot be edited

if the Disk Cache is used.

If you are not allowed to write to the required sub directory caching will not happen. For example if your blend-file path is very long and your operating system has a limit on the path length that is supported.

Be careful with the sequence of modifiers in the modifier stack. You may have a different number of faces in the 3D Viewport and for rendering (For example when using subdivision surface). Then the rendered result may be very different from what you see in the 3D Viewport.

Caches List

The list of available caches. The caches have no name by default. Double click to add a name.



You can store and manage multiple caches at once for the same physics object. The active cache is the one that gets used.

Drag Handler

The two vertical lines at the end is a handler with which you can expand the list.

Search Field

You can expand a search field at the bottom of the list. Type in your term and hit enter to filter for your term.



Invert

Exclude the search term instead of searching for it.

Sort by Name

Sort the List by name.

Add New Cache

Add a new cache.

Delete current Cache

Deletes the selected cache.

Simulation start

The start frame of the simulation.

End

The end frame of the simulation.

Info string

An info string. Gives different messages, dependent of the status.

Disk Cache

Save the cache externally in a folder instead inside of the blend file. The cache of a baked simulation will be stored inside the blend-file when you save it. A folder named `blendcache_[filename]` will then be created alongside the blend-file. The blend-file must be saved first and then again.

Use Library Path

Share the disk cache when the physics object is linked into another blend-file.

When this option is enabled, linked versions of the object will reference the same disk cache. Otherwise linked versions of the object will use independent caches.

Compression

The compression level for cached files.

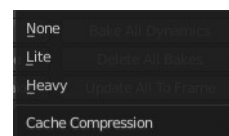

None

Do not compress the cache.

Light

Compression will optimize the speed of compressing/decompressing operations over file size.

Heavy

Compression will result in smaller cache files, but requires more CPU power to compress / decompress.

Bake / Delete Bake

Start baking. Once you have baked the cache the button turns into a Delete bake button. And allows you to remove the bake.



The baking progress can be seen in the footer. You need to be in Object Mode to bake.



Calculate To Frame

Bake only up to the current frame. Limited by End frame set in the cache settings.

Current Cache to Bake

Store any temporarily cached simulation data as a bake. Note that playing the animation will try to simulate any visible physics simulations. Depending on the physics type, this data may be temporarily cached. Normally such temporary caches are cleared when an object or setting is modified, but converting it to a bake will “save”

it.

Bake All Dynamics

Bake all physics systems in the scene, even those of different types. Useful for baking complex setups involving interactions between different physics types.

Delete All Bakes

Free bakes of all physics systems in the scene, even those of different types.

Update All To Frame

Bake all physics systems in the scene to the current frame.

Shape subpanel

Pin Group

Vertex group to use for pinning.

The shape of the cloth can be controlled by pinning cloth to a Vertex Group. There are several ways of doing this including Weight Painting areas you want to pin. The weight of each vertex in the group controls how strongly it is pinned.

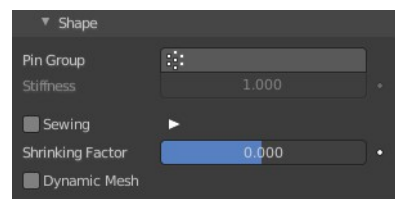

Stiffness

Target position stiffness.

Sewing



Another method of restraining cloth similar to pinning is sewing springs.

Sewing springs are virtual springs that pull vertices in one part of a cloth mesh toward vertices in another part of the cloth mesh. This is different from pinning which binds vertices of the cloth mesh in place or to another object. A clasp on a cloak could be created with a sewing spring. The spring could pull two corners of a cloak about a character's neck. This could result in a more realistic simulation than pinning the cloak to the character's neck since the cloak would be free to slide about the character's neck and shoulders.

Sewing springs are created by adding extra edges to a cloth mesh that are not included in any faces. They should connect vertices in the mesh that should be pulled together. For example the corners of a cloak.

Sewing Force Max

Maximum force that can be applied by sewing springs. Zero means unbounded, but it is not recommended to leave the field at zero in most cases, as it can cause instability due to extreme forces in the initial frames where the ends of the sewing springs are far apart.

Shrinking Factor

Factor by which to shrink the cloth, specifying a negative value controls the amount for the cloth to grow.

Dynamic Mesh

Allows animating the rest shape of cloth using shape keys or modifiers (e.g. an Armature modifier or any deformation modifier) placed above the Cloth modifier. When it is enabled, the rest shape is recalculated every frame, allowing unpinned cloth to squash and stretch following the character with the help of shape keys or modifiers, but otherwise move freely under control of the physics simulation.

Normally cloth uses the state of the object in the first frame to compute the natural rest shape of the cloth, and keeps that constant throughout the simulation. This is reasonable for fully realistic scenes, but does not quite work for clothing on cartoon style characters that use a lot of squash and stretch.

Collisions subpanel

In most cases, a piece of cloth collides with other objects in the environment. To ensure proper simulation, there are several items that have to be set up and working together.

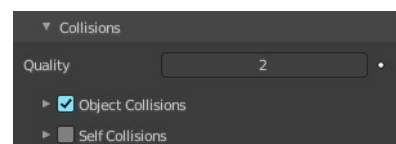

- The Cloth object must be told to participate in collisions.
- Optionally (but recommended) tell the cloth to collide with itself.
- Other objects must be visible to the Cloth object via shared layers.
- The other objects must be mesh objects.
- The other objects may move or be themselves deformed by other objects (like an armature or shape key).
- The other mesh objects must be told to deflect the cloth object.
- The blend-file must be saved in a directory so that simulation results can be saved.
- You then Bake the simulation. The simulator computes the shape of the cloth for a frame range.
- You can then edit the simulation results, or make adjustments to the cloth mesh, at specific frames.
- You can make adjustments to the environment or deforming objects, and then re-run the cloth simulation from the current frame forward.

Troubleshooting

If you encounter some problems with collision detection, there are a few ways to fix them:

The fastest solution is to increase the Distance for Object/Self Collisions. This will be the fastest way to fix the

clipping; however, it will be less accurate and will not look as good. Using this method tends to make it look like the cloth is resting on air, and gives it a very rounded look.

A second method is to increase the Quality (in the Cloth panel). This results in smaller steps for the simulator and therefore to a higher probability that fast-moving collisions get caught. You can also increase the Collisions Quality to perform more iterations to get collisions solved.

If none of the methods help, you can easily edit the cached/baked result in Edit Mode afterwards.

If the Cloth is torn by the deforming mesh; increase the stiffness settings.

Quality

A general quality setting. Higher numbers take more time but ensure less tears and penetrations through the cloth.

Object Collisions sub subpanel

If the cloth object needs to be deflected by some other object. To deflect a cloth, the object must be enabled as an object that collides with the cloth object. To enable objects to collide with cloth objects enable collision physics for the collider object (not on the cloth object).

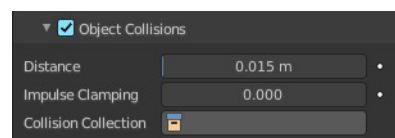

Note! If your colliding object is not a mesh object, such as a NURBS surface, or a text object, you must convert it to a mesh object first.

Distance

The distance another object must get to the cloth for the simulation to repel the cloth out of the way. Smaller values might give errors but gives some speed-up while larger will give unrealistic results if too large and can be slow. It is best to find a good in between value.

Impulse Clamping

Prevents explosions in tight and complicated collision situations by restricting the amount of movement after a collision.

Collision Collection

Only objects that are a part of this Collection can collide with the cloth. Note that these objects must also have Collision physics enabled.

Self-Collisions sub subpanel

Real cloth cannot penetrate itself, so you normally want the cloth to self-collide. Enable this to tell the cloth object that it should not penetrate itself. This adds to the simulation's compute time, but provides more realistic results.

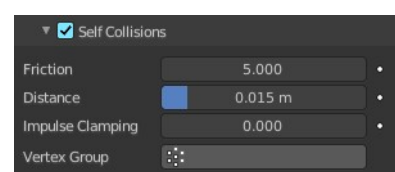

Tip! A flag, viewed from a distance does not need this enabled, but a close-up of a cape or blouse on a character should have this enabled.

Friction

A coefficient for how slippery the cloth is when it collides with itself. For example, silk has a lower coefficient of friction than cotton.

Distance

As cloth at this distance begins to repel away from itself. Smaller values might give errors but gives some speed-up while larger will give unrealistic results if too large and can be slow. It is best to find a good in between value.

Impulse Clamping

Prevents explosions in tight and complicated collision situations by restricting the amount of movement after a collision.

Vertex Group

Only vertices that are a part of this Vertex Group can collide with each other.

Property Weights subpanel

This panel is used to constrain certain cloth properties to a certain vertex group. The properties that they control can be found in a combination of the Physical Properties and Shape panels.

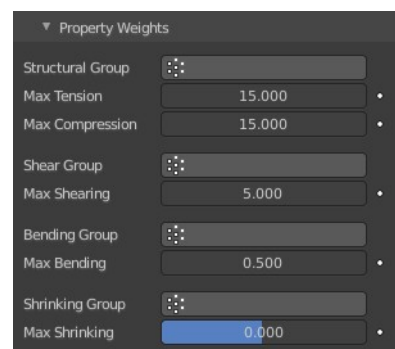

Structural Group

Defines a vertex group to control over structural stiffness.

Max Tension

Maximum tension stiffness value.

Max Compression

Maximum Compression stiffness value.

Shear Group

Vertex group for fine control over shear stiffness.

Max Shearing

Maximum shear scaling value.

Bending Group

Vertex group for fine control over bending stiffness.

Max Bending

Maximum bending stiffness value.

Shrinking Group

Vertex group for shrinking cloth.

Max Shrinking

Max amount to shrink cloth by, specifying a negative value controls the max amount for the cloth to grow.

Field Weights subpanel

Cloth simulation is also influenced by external force effectors. This panel allows you to adjust these forces.

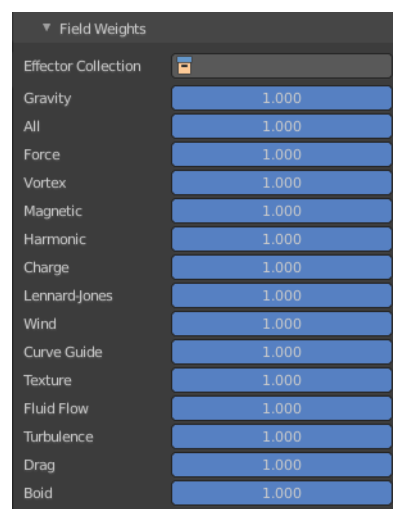



26.12.4 Editors - Properties Editor - Physics Properties Tab - Dynamic Paint panel

Table of content

Detailed table of content.....	1
Dynamic Paint.....	4
Type.....	4
Workflow.....	5
Workflow Paint simulation.....	5
Workflow Displace simulation.....	6
Workflow Weight simulation.....	6
Workflow Ocean simulation.....	8
Canvas - Settings subpanel.....	8
Add Canvas / Remove Canvas.....	8
Active Point Cache Index.....	8
Add Surface Slot.....	9
Remove Surface Slot.....	9
Format.....	9
Anti-Aliasing.....	9
Canvas - Surface subpanel.....	10
Surface Type.....	10
Canvas - Cache subpanel.....	13
Hints.....	14
Caches List.....	14
Add New Cache.....	15
Delete current Cache.....	15
Info string.....	15
Bake / Delete Bake.....	15
Calculate To Frame.....	15
Current Cache to Bake.....	15
Bake All Dynamics.....	15
Delete All Bakes.....	15
Update All To Frame.....	15
Canvas - Effects subpanel.....	16
Spread.....	16
Drip.....	16
Shrink.....	17
Canvas - Initial color subpanel.....	17
None.....	17
Color.....	17
UV Texture.....	17
Vertex Color.....	17
Canvas - Output subpanel.....	18
With Vertex Format.....	18
With Image Sequence format.....	18

Detailed table of content

Detailed table of content

Detailed table of content.....	1
Dynamic Paint.....	4
Type.....	4
Workflow.....	5
Workflow Paint simulation.....	5
Workflow Displace simulation.....	6
Workflow Weight simulation.....	6
Workflow Ocean simulation.....	8
Canvas - Settings subpanel.....	8
Add Canvas / Remove Canvas.....	8
Active Point Cache Index.....	8
Drag Handler.....	9
Search Field.....	9
Invert.....	9
Sort by Name.....	9
Add Surface Slot.....	9
Remove Surface Slot.....	9
Format.....	9
Vertex.....	9
Image Sequences.....	9
Resolution.....	9
Anti-Aliasing.....	9
Frame Start.....	9
End.....	10
Sub-steps.....	10
Canvas - Surface subpanel.....	10
Surface Type.....	10
Paint.....	10
Brush Collection.....	10
Scale Influence.....	10
Radius.....	10
Dissolve.....	10
Time.....	10
Slow.....	10
Dry.....	10
Time.....	11
Color.....	11
Slow.....	11
Displace.....	11
Max Displace.....	11
Displace Factor.....	11
Incremental.....	11
Brush Collection.....	11
Scale Influence.....	11
Radius.....	11
Dissolve.....	11
Time.....	12
Slow.....	12
Weight.....	12
Brush Collection.....	12
Scale Influence.....	12

Radius.....	12
Dissolve.....	12
Time.....	12
Slow.....	12
Waves.....	12
Open Borders.....	12
Timescale.....	13
Speed.....	13
Damping.....	13
Spring.....	13
Smoothness.....	13
Brush Collection.....	13
Scale Influence.....	13
Radius.....	13
Canvas - Cache subpanel.....	13
Hints.....	14
Caches List.....	14
Drag Handler.....	14
Search Field.....	14
Invert.....	14
Sort by Name.....	15
Add New Cache.....	15
Delete current Cache.....	15
Info string.....	15
Bake / Delete Bake.....	15
Calculate To Frame.....	15
Current Cache to Bake.....	15
Bake All Dynamics.....	15
Delete All Bakes.....	15
Update All To Frame.....	15
Canvas - Effects subpanel.....	16
Spread.....	16
Speed.....	16
Color.....	16
Drip.....	16
Velocity.....	16
Acceleration.....	16
Weights.....	16
Shrink.....	17
Speed.....	17
Canvas - Initial color subpanel.....	17
None.....	17
Color.....	17
Color.....	17
UV Texture.....	17
Texture.....	17
UV Map.....	17
Vertex Color.....	17
Canvas - Output subpanel.....	18
With Vertex Format.....	18
With surface type Paint.....	18
With surface type Weight.....	18
With Image Sequence format.....	18

With surface type Paint.....	18
Bake Image Sequence.....	18
Cache Path.....	18
Accept.....	18
Premultiply Alpha.....	18
Paintmaps.....	18
Name.....	19
Wetmaps.....	19
Name.....	19
With surface type Displace.....	19
Bake Image Sequence.....	19
Cache Path.....	19
Accept.....	19
Premultiply Alpha.....	19
Filename.....	19
Displace Type.....	19
Max Displace.....	19
With surface type Waves.....	19
Bake Image Sequence.....	19
Cache Path.....	19
Accept.....	19
UV Map.....	20
File Format.....	20
Premultiply Alpha.....	20
Filename.....	20
Wave Clamp.....	20

Dynamic Paint

Dynamic paint is a modifier and physics system that allows to paint at the mesh surface of an object. You need an object that is set up as the canvas. And an object that is set up as the brush to create the required vertex colors, image sequences or displacement.

This combination makes many effects possible. For example footsteps in the snow, raindrops that make the ground wet, paint that sticks to walls, or objects that gradually freeze.

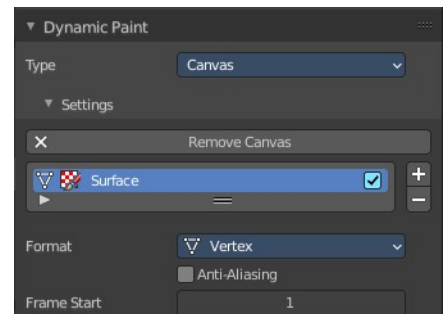

Creating a dynamic paint physics adds a modifier in the modifier tab. But the settings can just be adjusted from the physics tab.

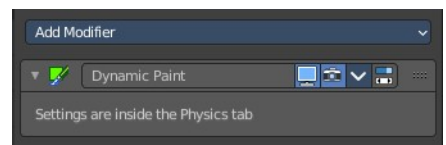

Type

The Dynamic Paint modifier has two different types Canvas and Brush. And the panel content shows either the settings for the canvas or for the brush type.

Note! You can also enable brush and canvas simultaneously by add canvas and add brush. In that case same object's "brush" does not influence its "canvas", but can still interact with other objects in the scene.

Workflow

Workflow Paint simulation

Create a grid object. Scale it a bit bigger. Add a SDS modifier with type simple.

Add a dynamic paint physics. And set the type to Canvas. In the surface section set the type to Waves.

Create a sphere.

Add a dynamic paint physics. And set the type to Brush.

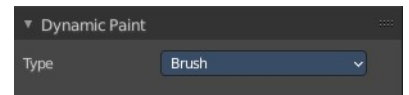
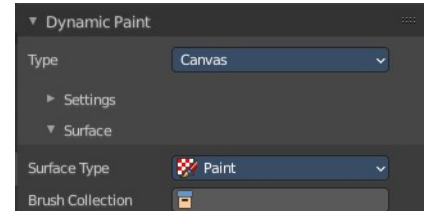

Paint is a vertex painting effect. So in the viewport shading enable vertex color to see the paint effect.

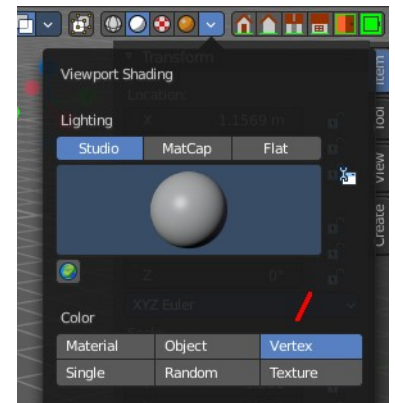

For the canvas object go to the end of the list, remove both, the paintmap layer and the wetmap layer, and add a new paintmap layer.

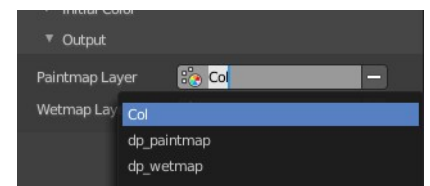

The paint effect is a dynamic and so an animated effect. And so you need to play the animation. Now, with the animation playing, move the sphere into the grid object. You will see the surface of the grid object react to the contact with the sphere.

You can of course also set keyframes to record the motion of the brush sphere.

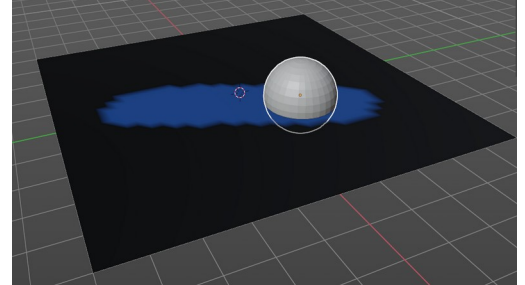

Workflow Displace simulation

Create a grid object. Scale it a bit bigger. Add a SDS modifier with type simple.

Add a dynamic paint physics. And set the type to Canvas. In the surface section set the type to Waves.

Create a sphere.

Add a dynamic paint physics. And set the type to Brush.

The paint effect is a dynamic and so an animated effect. And so you need to play the animation. Now, with the animation playing, move the sphere into the grid object. You will see the surface of the grid object react to the contact with the sphere.

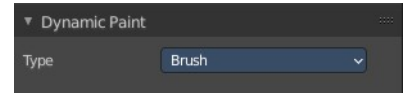
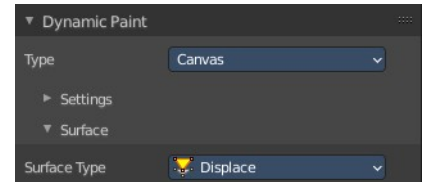

You can of course also set keyframes to record the motion of the brush sphere.

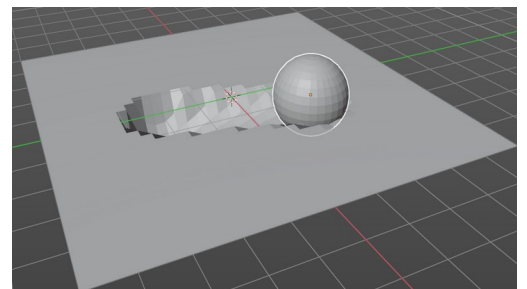

Workflow Weight simulation

The workflow is similar to the Paint workflow. But the result cannot be visualized. The image at the right shows the in between step across paint. And you need to bake the result to use it.

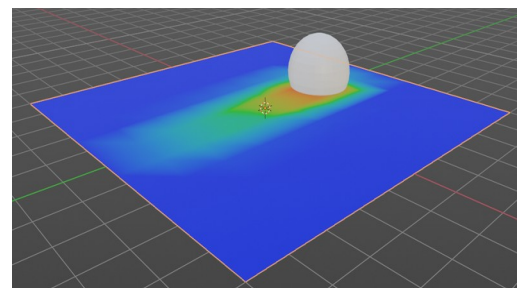

Node setup to visualize the result with the Paint method. You need to be in viewport shading method Material Preview. And in the Output of the Dynamic Paint the wetmap layer needs to be activated so that it shows up in the vertex color node.

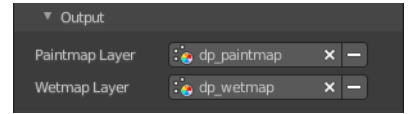

When done switch to surface type Weight.

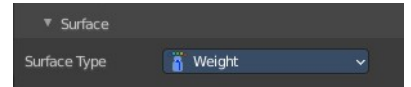

In the Output subpanel of Dynamic Paint activate the Vertex Group. This is done by clicking at the +button behind the vertex group.

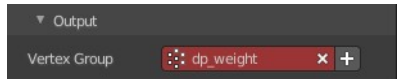

Bake the result.

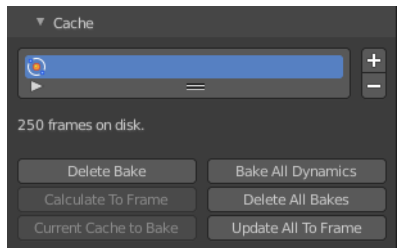
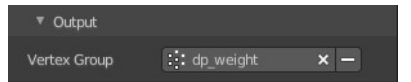

The vertex group output from dynamic paint can now be used in quick smoke for example, to determine where smoke should appear.

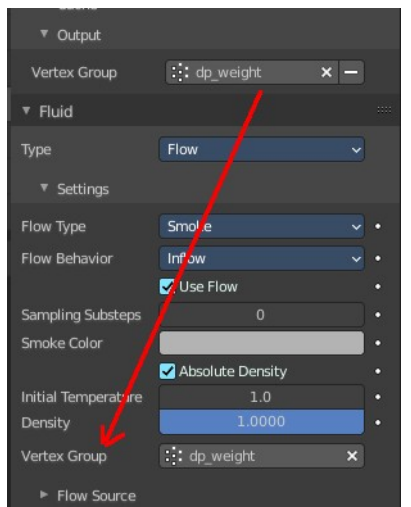

Workflow Ocean simulation

Create a grid object. Scale it a bit bigger. Add a SDS modifier with type simple.

Add a dynamic paint physics. And set the type to Canvas. In the surface section set the type to Waves.

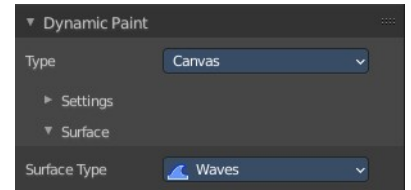

Create a sphere.

Add a dynamic paint physics. And set the type to Brush.

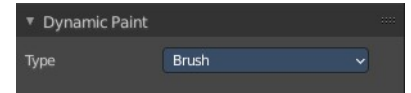

The paint effect is a dynamic and so an animated effect. And so you need to play the animation. Now, with the animation playing, move the sphere into the grid object. You will see the surface of the grid object react to the contact with the sphere.



You can of course also set keyframes to record the motion of the brush sphere.

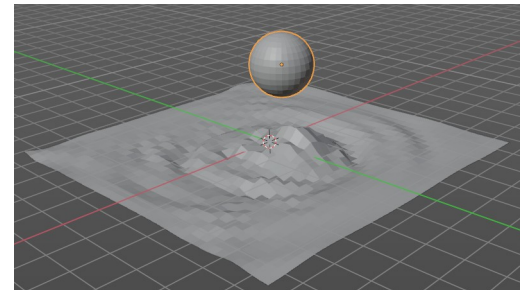

Canvas - Settings subpanel

The Canvas type makes object receive paint from Dynamic Paint brushes.

Add Canvas / Remove Canvas

Add a canvas. When a canvas is added the button turns into the remove canvas button.

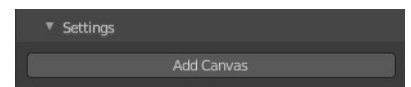

Active Point Cache Index

A list of the available point caches. You can add more than one surface here. The type of this surface can be changed in the surfaces sub tab then. But just one surface can be the active one.

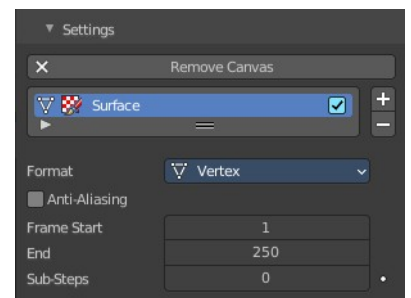

Double clicking at the name allows to rename the surface point cache.

Is Active allows you to turn off the surface point cache.

Drag Handler

The two vertical lines at the end is a handler with which you can expand the list.

Search Field

You can expand a search field at the bottom of the list. Type in your term and hit enter to filter for your term.



Invert

Exclude the search term instead of searching for it.

Sort by Name

Sort the List by name.

Add Surface Slot

Adds a surface slot

Remove Surface Slot

Removes the selected surface slot.

Format

Each surface has a certain format and type. Format determines how data is stored and outputted.

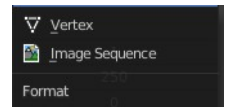

Vertex

Dynamic Paint operates directly on mesh vertex data. Results are stored by point cache and can be displayed in viewport. However, using vertex level also requires a highly subdivided mesh to work.

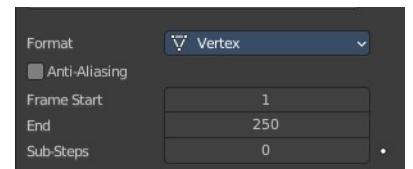
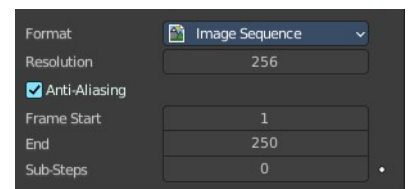

Image Sequences

Dynamic Paint generates UV wrapped image files of defined resolution as output.



Resolution

Image Sequence format. The output resolution of the single images.

Anti-Aliasing

Use Anti-Aliasing to smooth paint edges. The antialiasing is using a 5× multi sampling method.

Frame Start

The start frame of the surface processing.

End

The end frame of the surface processing.

Sub-steps

Sub-steps are extra samples between frames. They are usually required when there is a very fast brush.

Canvas - Surface subpanel

Surface Type

Each surface has a “type” that defines what surface is used for. Dependent of the chosen surface type you will see other settings.

Paint

Paint outputs color and wetness values. In case of vertex surfaces, results are outputted as vertex colors.

A wetmap is a black-and-white output that visualizes paint wetness. White being maximum wetness, black being completely dry. It is usually used as mask for rendering. Some “paint effects” affect wet paint only.

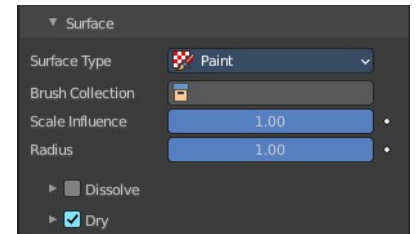

Brush Collection

Define a specific collection to pick brush objects from.

Scale Influence

The influence the brush objects have on this surface.

Radius

Adjust radius of proximity brushes or particles for this surface.

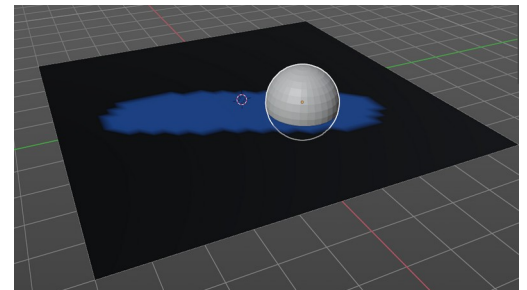

Dissolve

Make surface changes disappear over time.

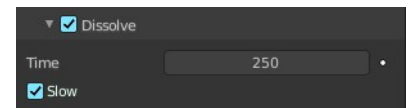

Time

Approximately in how many frames the dissolve should happen.

Slow

Use logarithmic dissolve. This makes high values to fade faster than low values.

Dry

Make surface wetness dry over time. Completely disable drying can be used

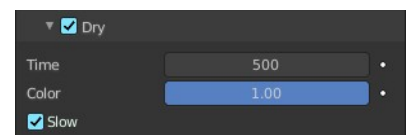

for indefinitely spreading paint.

Time

Approximately in how many frames the dry should happen.

Color

Define the wetness level when paint colors start to shift to surface “background”. Lower values can be useful to prevent spreading paint from becoming transparent as it dries, while higher values give better results in general.

Slow

Use logarithmic dissolve. This makes high values to fade faster than low values.

Displace

Outputs intersection depth from brush objects. It deforms the mesh.

Tip! If the displace output seems too rough it usually helps to add a Smooth Modifier after Dynamic Paint in the modifier stack.

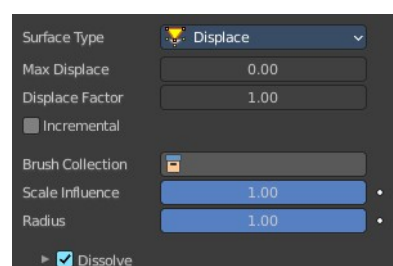

Max Displace

The maximum level of intersection depth, larger values will be clamped to this value.

Displace Factor

The multiplier for the intersection depth. You can use it to adjust final displace strength or use negative values to paint bumps.

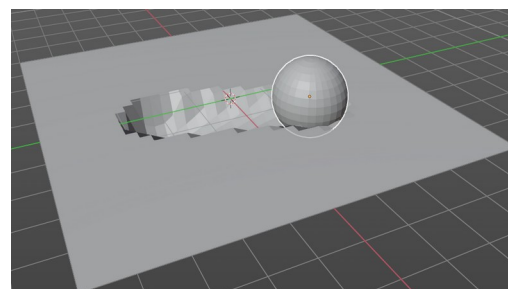

Incremental

A new displace is added cumulatively on top of an existing displace.

Brush Collection

Define a specific collection to pick brush objects from.

Scale Influence

The influence the brush objects have on this surface.

Radius

Adjust radius of proximity brushes or particles for this surface.

Dissolve

Make surface changes disappear over time.

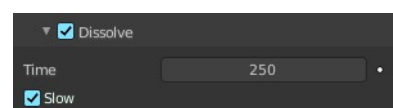

Time

Approximately in how many frames the dissolve should happen.

Slow

Use logarithmic dissolve. This makes high values to fade faster than low values.

Weight

This special surface type is only available for vertex format output. It outputs vertex weight groups that can be used by other Blender modifiers and tools.

Tip! It is usually preferred to use “proximity” based brushes for weight surfaces to allow smooth falloff between weight values.

It requires a material to display the result.

Brush Collection

Define a specific collection to pick brush objects from.

Scale Influence

The influence the brush objects have on this surface.

Radius

Adjust radius of proximity brushes or particles for this surface.

Dissolve

Make surface changes disappear over time.

Time

Approximately in how many frames the dissolve should happen.

Slow

Use logarithmic dissolve. This makes high values to fade faster than low values.

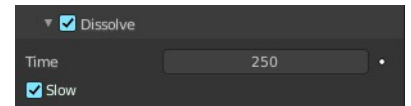
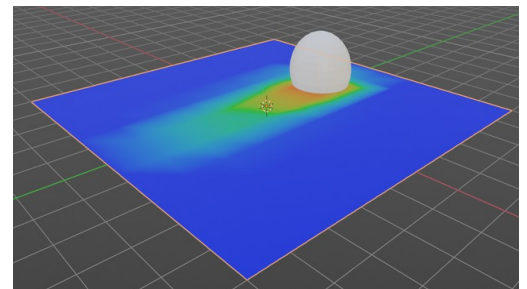
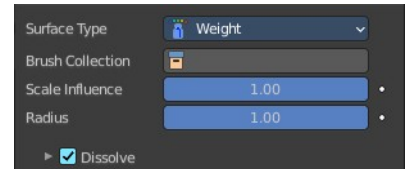

Waves

This surface type produces simulated wave motion. Like displace, wave surface also uses brush intersection depth to define brush strength.

Tip! In some cases the wave motion gets very unstable around brush. It usually helps to reduce wave speed, brush “wave factor” or even the resolution of mesh/surface.

Open Borders

Allows waves to pass through mesh “edges” instead of reflecting

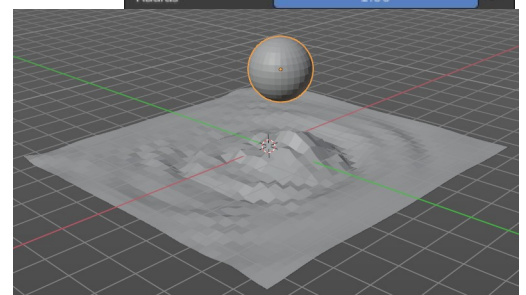
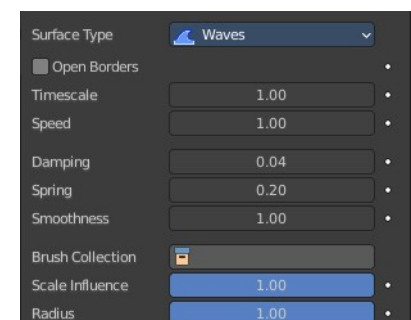

from them.

Timescale

Directly adjusts simulation speed without affecting simulation outcome. Lower values make simulation go slower and otherwise.

Speed

Affects how fast waves travel on the surface. This setting is also corresponds to the size of the simulation. Half the speed equals surface double as large.

Damping

Reduces the wave strength over time. Basically adjusts how fast wave disappears.

Spring

Adjusts the force that pulls water back to “zero level”.

Smoothness

Limit maximum steepness of wave slope between simulation points. Higher values results in smoother waves and higher calculation time.

Brush Collection

Define a specific collection to pick brush objects from.

Scale Influence

The influence the brush objects have on this surface.

Radius

Adjust radius of proximity brushes or particles for this surface.

Canvas - Cache subpanel

Vertex format only. For image sequence type the caching is done in the output panel.

The canvas simulation can be cached in memory or stored on a drive. This improves real-time response and avoids unnecessary recalculation of particles. But creates also big files.

The canvas system uses a unified system for caching and baking (together with Cloth, Soft Body and Emitter particle).

Important! The file needs to be saved after baking. When the file is not saved then some options are not

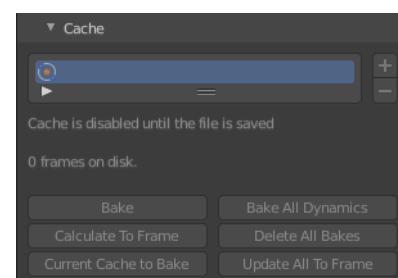

available.

Important! The canvas settings becomes unavailable once the particle cache is baked. You need to remove the bake when you want to change the settings.

Hints

The simulation is only calculated for positive frames in between the Start and End frames of the Cache panel, whether you bake or not. So if you want a simulation that is longer than the default frame range, you have to change the End frame.

When an animation is played, each physics system writes each frame to the cache. Note that for the cache to fill up, one has to start the playback before or on the frame that the simulation starts.

The cache is cleared automatically on changes. But not on all changes, so it may be necessary to free it manually. For example if you change a force field.

The system is protected against changes after baking. If for example the mesh changes the simulation is not calculated anew.

The bake result can be cleared by clicking on the Free Bake button in the simulation cache settings.

A simulation can only be edited in Particle Edit Mode when it has been baked in memory. And cannot be edited if the Disk Cache is used.

If you are not allowed to write to the required sub directory caching will not happen. For example if your blend-file path is very long and your operating system has a limit on the path length that is supported.

Be careful with the sequence of modifiers in the modifier stack. You may have a different number of faces in the 3D Viewport and for rendering (For example when using subdivision surface). Then the rendered result may be very different from what you see in the 3D Viewport.

Caches List

The list of available caches. The caches have no name by default. Double click to add a name.



You can store and manage multiple caches at once for the same physics object. The active cache is the one that gets used.

Drag Handler

The two vertical lines at the end is a handler with which you can expand the list.

Search Field

You can expand a search field at the bottom of the list. Type in your term and hit enter to filter for your term.



Invert

Exclude the search term instead of searching for it.

Sort by Name

Sort the List by name.

Add New Cache

Add a new cache.

Delete current Cache

Deletes the selected cache.

Info string

An info string. Gives different messages, dependent of the status.

Bake / Delete Bake

Start baking. Once you have baked the cache the button turns into a Delete bake button. And allows you to remove the bake.

The baking progress can be seen in the footer. You need to be in Object Mode to bake.



Calculate To Frame

Bake only up to the current frame. Limited by End frame set in the cache settings.

Current Cache to Bake

Store any temporarily cached simulation data as a bake. Note that playing the animation will try to simulate any visible physics simulations. Depending on the physics type, this data may be temporarily cached. Normally such temporary caches are cleared when an object or setting is modified, but converting it to a bake will “save” it.

Bake All Dynamics

Bake all physics systems in the scene, even those of different types. Useful for baking complex setups involving interactions between different physics types.

Delete All Bakes

Free bakes of all physics systems in the scene, even those of different types.

Update All To Frame

Bake all physics systems in the scene to the current frame.

Canvas - Effects subpanel

Surface Type Paint only. It generates animated movement on canvas surface.

For spread and drip effects, only “wet paint” is affected, so as the paint dries, movement becomes slower until it stops.

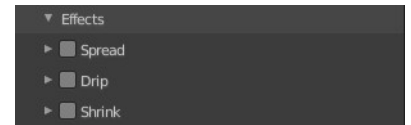

Spread

Paint slowly spreads to surrounding points eventually filling all connected areas.

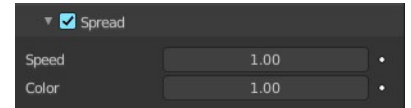

Speed

How fast the spread effect moves on the canvas surface.

Color

How fast the colors get mixed within wet paint.

Drip

Paint moves in specific direction specified by Blender force fields, gravity and velocity with user-defined influences.

Velocity

How much surface velocity affect dripping.

Acceleration

How much surface acceleration affects dripping.

Weights

The dripping is influenced by physical forces. This panel allows you to adjust the amount of the single effector forces.

Effector collection allows you to limit the forces to a collection only.

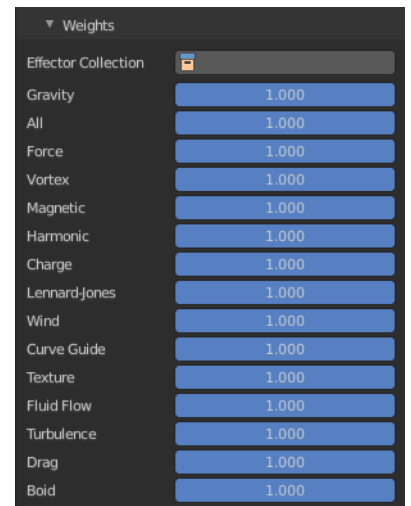

Shrink

Painted area slowly shrinks until disappears completely.



Speed

How fast shrink effects move on the canvas surface.

Canvas - Initial color subpanel

Surface Type Paint only. Allows you to define the initial color of the canvas.

None

No initial color is used.

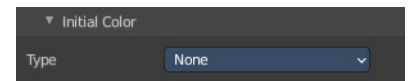

Color

Define an initial color.

Color

Clicking at the color field opens a color picker where you can choose a color.

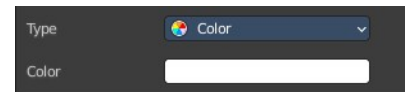

UV Texture

Use a UV texture as an initial color.

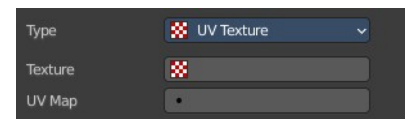

Texture

The texture to use. The texture that is meant here is not an image texture. But a created one. This can be done in the Texture tab.

UV Map

The UV map of the mesh. Usually you will just have one UV map available. But a mesh can have several ones.

Vertex Color

Set an initial vertex color. You need to have a vertex color at the mesh. Then choose it here.

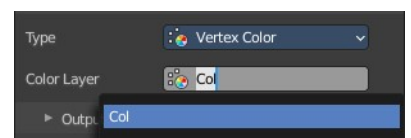

To create a vertex color layer go to the Object data properties to the Vertex color panel, and add a new one. Or simply enter the vertex paint mode and paint at least one vertice with a vertex color. Then a vertex color layer gets

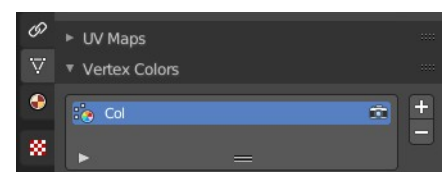

created.

Canvas - Output subpanel

With Vertex Format

With surface type Paint

The Paintmap Layer `dp_paintmap` and Wetmap Layer `dp_wetmap` map types are vertex colors.

Red means this map type is deactivated. To activate the layers click at the + button at the right.

Once activated they can be found in the Vertex colors panel in the Object Data tab.

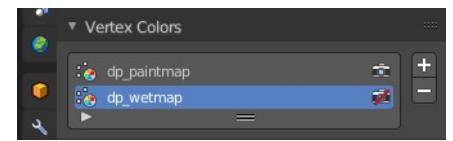
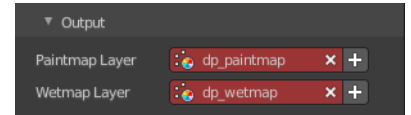

With surface type Weight

The Vertex Group `dp_dp_weight` is a vertex group.

Red means this map type is deactivated. To activate the layers click at the + button at the right.

Once activated it can be found in the Vertex Group panel in the Object Data tab.



With Image Sequence format

With surface type Paint

Bake Image Sequence

Bake the image sequence to file.

Cache Path

The path where the cache images are stored.

Accept

Open a file browser to choose another cache directory.

Premultiply Alpha

Multiply color by alpha.

Paintmaps

Use paintmaps.

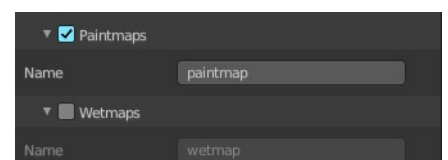
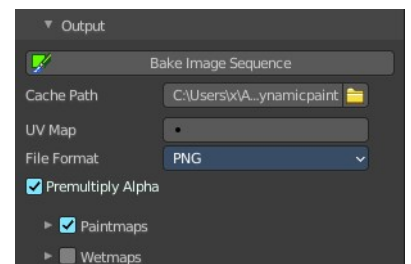

Name

The name of the paintmap to use.

Wetmaps

Use wetmaps

Name

The name of the wetmap to use.

With surface type Displace

Bake Image Sequence

Bake the image sequence to file.

Cache Path

The path where the cache images are stored.

Accept

Open a file browser to choose another cache directory.

Premultiply Alpha

Multiply color by alpha.

Filename

The name that is used to save the output from this surface.

Displace Type

What displace type to use.

Max Displace

Maximum level of depth intersection in object space. Use 0.0 to disable it.

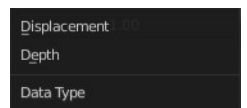
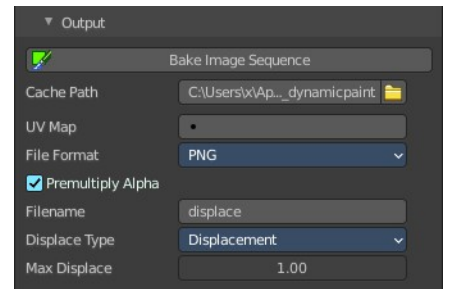

With surface type Waves

Bake Image Sequence

Bake the image sequence to file.

Cache Path

The path where the cache images are stored.

Accept

Open a file browser to choose another cache directory.

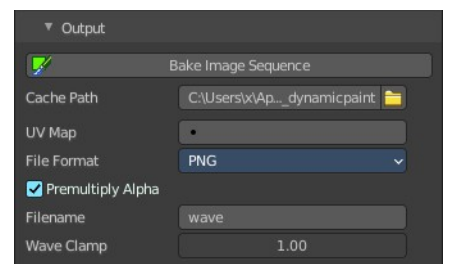

UV Map

UV map name to use. Leave empty when you don't work with UV maps.

File Format

Save the images either with Open EXR or with PNG file format.

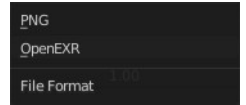

Premultiply Alpha

Multiply color by alpha.

Filename

The name that is used to save the output from this surface.

Wave Clamp

Maximum level of depth intersection in object space. Use 0.0 to disable it.



26.12.5 Editors - Properties Editor - Physics Properties Tab - Soft Body panel

Table of content

Detailed table of content.....	2
Soft Body.....	4
Tips.....	4
Soft Body panel.....	5
Collision Collection.....	5
Object subpanel.....	5
Friction.....	5
Mass.....	5
Control Point.....	5
Simulation subpanel.....	5
Speed.....	5
Cache subpanel.....	6
Hints.....	6
Caches List.....	6
Add New Cache.....	7
Delete current Cache.....	7
Simulation start.....	7
End.....	7
Cache Step.....	7
Info string.....	7
Disk Cache.....	7
Bake / Delete Bake.....	8
Calculate To Frame.....	8
Current Cache to Bake.....	8
Bake All Dynamics.....	8
Delete All Bakes.....	8
Update All To Frame.....	8
Goal subpanel.....	9
Vertex Group.....	9
Goal Settings sub subpanel.....	9
Goal Strength sub subpanel.....	9
Edges subpanel.....	9
Use Edges.....	9
Springs.....	9
Pull.....	10
Push.....	10
Damp.....	10
Plastic.....	10
Bending.....	10
Length.....	10
Collision Edge.....	10
Face.....	10
Aerodynamics sub subpanel.....	10
Stiffness sub subpanel.....	11
Self Collision subpanel.....	11

Calculation Type.....	11
Ball Size.....	12
Stiffness.....	12
Dampening.....	12
Solver subpanel.....	12
Step Size Min.....	12
Max.....	12
Auto-Step.....	12
Error Limit.....	12
Field Weights subpanel.....	13

Detailed table of content

Detailed table of content

Detailed table of content.....	2
Soft Body.....	4
Tips.....	4
Soft Body panel.....	5
Collision Collection.....	5
Object subpanel.....	5
Friction.....	5
Mass.....	5
Control Point.....	5
Simulation subpanel.....	5
Speed.....	5
Cache subpanel.....	6
Hints.....	6
Caches List.....	6
Drag Handler.....	7
Search Field.....	7
Invert.....	7
Sort by Name.....	7
Add New Cache.....	7
Delete current Cache.....	7
Simulation start.....	7
End.....	7
Cache Step.....	7
Info string.....	7
Disk Cache.....	7
Use Library Path.....	7
Compression.....	8
None.....	8
Light.....	8
Heavy.....	8
Bake / Delete Bake.....	8
Calculate To Frame.....	8
Current Cache to Bake.....	8
Bake All Dynamics.....	8
Delete All Bakes.....	8
Update All To Frame.....	8
Goal subpanel.....	9

Vertex Group.....	9
Goal Settings sub subpanel.....	9
Stiffness.....	9
Damping.....	9
Goal Strength sub subpanel.....	9
Default.....	9
Min / Max.....	9
Edges subpanel.....	9
Use Edges.....	9
Springs.....	9
Pull.....	10
Push.....	10
Damp.....	10
Plastic.....	10
Bending.....	10
Length.....	10
Collision Edge.....	10
Face.....	10
Aerodynamics sub subpanel.....	10
Type.....	11
Simple.....	11
Lift Force.....	11
Factor.....	11
Stiffness sub subpanel.....	11
Shear.....	11
Self Collision subpanel.....	11
Calculation Type.....	11
Manual.....	11
Average.....	11
Minimal / Maximal.....	11
Average Min Max.....	11
Ball Size.....	12
Stiffness.....	12
Dampening.....	12
Solver subpanel.....	12
Step Size Min.....	12
Max.....	12
Auto-Step.....	12
Error Limit.....	12
Diagnostics sub subpanel.....	13
Print Performance to Console.....	13
Estimate Matrix.....	13
Helpers sub subpanel.....	13
Choke.....	13
Fuzzy.....	13
Field Weights subpanel.....	13

Soft Body

Soft body simulation is used for simulating soft deformable objects. It was designed primarily for adding secondary motion to animation, like jiggle for body parts of a moving character.

It also works for simulating more general soft objects that bend, deform and react to forces like gravity and wind, or collide with other objects.

The soft body simulation works by combining existing animation on the object with forces acting on it. There are exterior forces like gravity or force fields and interior forces that hold the vertices together. This way you can simulate the shapes that an object would take on in reality if it had volume, was filled with something, and was acted on by real forces.

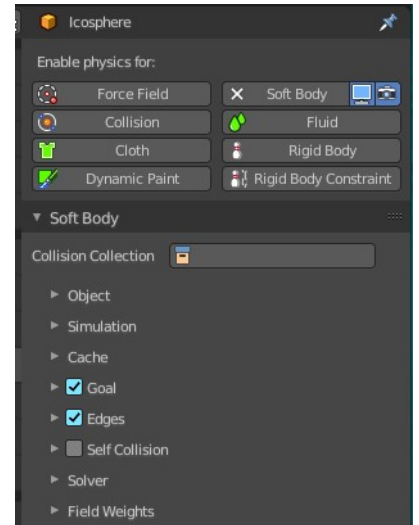

Soft bodies can interact with other objects through Collision. They can interact with themselves through Self-Collision.

The result of the soft body simulation can be converted to a static object. You can also bake edit the simulation, means edit intermediate results and run the simulation from there.

Soft bodies can be used for:

- Jiggle on moving characters.
- Elastic and deformable objects made of materials like rubber or gelatin.
- Tree branches moving in the wind, swinging ropes, and the like.
- Flags, wide sleeves, cushions or other simple fabric reacting to forces.

Soft body simulation works for all objects that have vertices or control points (meshes, curves, surfaces, and lattices).

Soft body simulation is a dynamic effect. It needs an animation.

Tips

Soft bodies work especially well if the objects have an even vertex distribution. You need enough vertices for good collisions. You change the deformation (the stiffness) if you add more vertices in a certain region.

The calculation of collisions may take a long time. If something is not visible, why calculate it?

To speed up the collision calculation it is often useful to collide with an additional, simpler, invisible, somewhat larger object.

Use soft bodies only where it makes sense. If you try to cover a body mesh with a tight piece of cloth and

animate solely with soft body, you will have no success. Self-collision of soft body hair may be activated, but that is a path that you have to wander alone. We will deal with Collisions in detail later.

Try and use a Lattice or a Curve Guide soft body instead of the object itself. This may be magnitudes faster.

Soft Body panel

Collision Collection

Limit the soft body simulation to objects in a collection

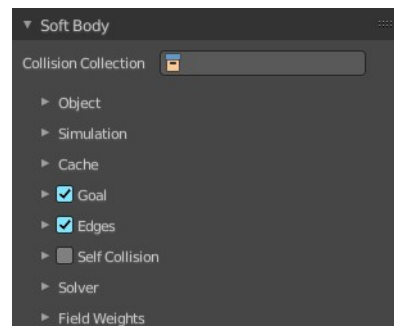

Object subpanel

Friction

The friction of the surrounding medium. Generally friction dampens a movement. The larger the friction, the more viscous is the medium. Friction always appears when a vertex moves relative to its surround medium.

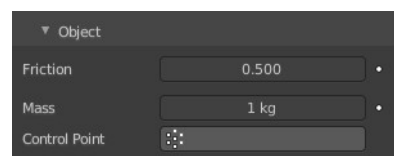

Mass

Mass value for vertices. Larger mass slows down acceleration, except for gravity where the motion is constant regardless of mass. Larger mass means larger inertia, so also braking a soft body is more difficult.

Control Point

You can paint weights and use a specified vertex group for mass values.

Simulation subpanel

Speed

You can control the internal timing of the soft body system with this value. It sets the correlation between frame rate and tempo of the simulation. A free falling body should cover a distance of about ten meters after one second. You can adjust the scale of your scene and simulation with this correlation. If you render with 25 frames per second, you will have to set Speed to 1.3.



Cache subpanel

The soft body simulation can be cached in memory or stored on a drive. This improves real-time response and avoids unnecessary recalculation of particles. But creates also big files.

The cloth system uses a unified system for caching and baking (together with cloth and Emitter particle).

Important! The file needs to be saved after baking. When the file is not saved then some options are not available.

Important! The cloth settings becomes unavailable once the particle cache is baked. You need to remove the bake when you want to change the settings.

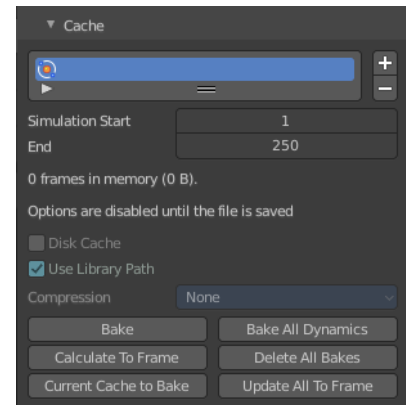

Hints

The simulation is only calculated for positive frames in between the Start and End frames of the Cache panel, whether you bake or not. So if you want a simulation that is longer than the default frame range, you have to change the End frame.

When an animation is played, each physics system writes each frame to the cache. Note that for the cache to fill up, one has to start the playback before or on the frame that the simulation starts.

The cache is cleared automatically on changes. But not on all changes, so it may be necessary to free it manually. For example if you change a force field.

The system is protected against changes after baking. If for example the mesh changes the simulation is not calculated anew.

The bake result can be cleared by clicking on the Free Bake button in the simulation cache settings.

A simulation can only be edited in Particle Edit Mode when it has been baked in memory. And cannot be edited if the Disk Cache is used.

If you are not allowed to write to the required sub directory caching will not happen. For example if your blend-file path is very long and your operating system has a limit on the path length that is supported.

Be careful with the sequence of modifiers in the modifier stack. You may have a different number of faces in the 3D Viewport and for rendering (For example when using subdivision surface). Then the rendered result may be very different from what you see in the 3D Viewport.

Caches List

The list of available caches. The caches have no name by default. Double click to add a name.



You can store and manage multiple caches at once for the same physics object. The active cache is the one that

gets used.

Drag Handler

The two vertical lines at the end is a handler with which you can expand the list.

Search Field

You can expand a search field at the bottom of the list. Type in your term and hit enter to filter for your term.



Invert

Exclude the search term instead of searching for it.

Sort by Name

Sort the List by name.

Add New Cache

Add a new cache.

Delete current Cache

Deletes the selected cache.

Simulation start

The start frame of the simulation.

End

The end frame of the simulation.

Cache Step

Number of frames between cached frames.

Info string

An info string. Gives different messages, dependent of the status.

Disk Cache

Save the cache externally in a folder instead inside of the blend file. The cache of a baked simulation will be stored inside the blend-file when you save it. A folder named `blendcache_[filename]` will then be created alongside the blend-file. The blend-file must be saved first and then again.

Use Library Path

Share the disk cache when the physics object is linked into another blend-file.

When this option is enabled, linked versions of the object will reference the same disk cache. Otherwise linked versions of the object will use independent caches.

Compression

The compression level for cached files. It becomes available when Disk Cache is ticked

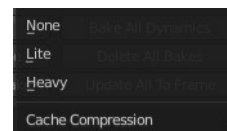

None

Do not compress the cache.

Light

Compression will optimize the speed of compressing/decompressing operations over file size.

Heavy

Compression will result in smaller cache files, but requires more CPU power to compress / decompress.

Bake / Delete Bake

Start baking. Once you have baked the cache the button turns into a Delete bake button. And allows you to remove the bake.



The baking progress can be seen in the footer. You need to be in Object Mode to bake.



Calculate To Frame

Bake only up to the current frame. Limited by End frame set in the cache settings.

Current Cache to Bake

Store any temporarily cached simulation data as a bake. Note that playing the animation will try to simulate any visible physics simulations. Depending on the physics type, this data may be temporarily cached. Normally such temporary caches are cleared when an object or setting is modified, but converting it to a bake will “save” it.

Bake All Dynamics

Bake all physics systems in the scene, even those of different types. Useful for baking complex setups involving interactions between different physics types.

Delete All Bakes

Free bakes of all physics systems in the scene, even those of different types.

Update All To Frame

Bake all physics systems in the scene to the current frame.

Goal subpanel

Use the motion from animations (F-curves, armatures, parents, lattices, etc.) in the simulation. The “goal” is the desired end position for vertices based on this animation.

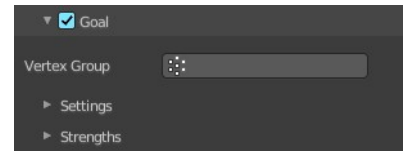

Vertex Group

Use a vertex group to allow per-vertex goal weights (multiplied by the Default goal).

Goal Settings sub subpanel

Stiffness

The spring stiffness for Goal. A low value creates very weak springs (more flexible “attachment” to the goal), a high value creates a strong spring (a stiffer “attachment” to the goal).

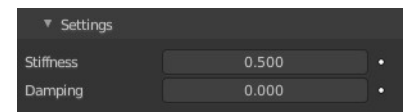

Damping

The friction coefficient for Goal. Higher values give damping of the spring effect (little jiggle), and the movement will soon come to an end.

Goal Strength sub subpanel

Default

Goal weight/strength for all vertices when no Vertex Group is assigned. If you use a vertex group the weight of a vertex defines its goal.

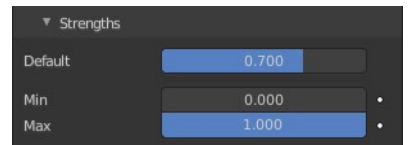

Min / Max

When you use a vertex group, you can use the Minimum and Maximum to fine-tune (clamp) the weight values. The lowest vertex weight will become Minimum, the highest value becomes Maximum.

Edges subpanel

Use Edges

Allow the edges in a mesh object to act like springs. See interior forces.

Springs

Use a specified vertex group for spring strength values.

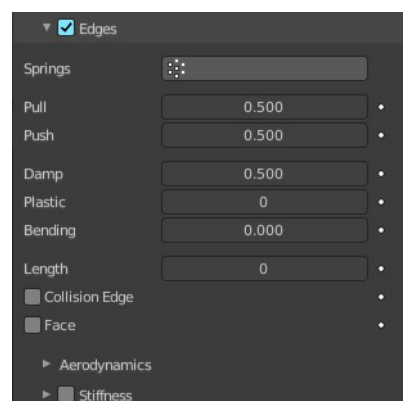

Pull

The spring stiffness for edges (how much the edges are allowed to stretch). A low value means very weak springs (a very elastic material), a high value is a strong spring (a stiffer material) that resists being pulled apart.

A value of 0.5 is latex, 0.9 is like a sweater, 0.999 is a highly-starched napkin or leather. The soft body simulation tends to get unstable if you use a value of 0.999, so you should lower this value a bit if that happens.

Push

How much the soft body resists being scrunched together, like a compression spring. Low values for fabric, high values for inflated objects and stiff material.

Damp

The friction for edge springs. High values (max of 50) dampen the Push/Pull effect and calm down the cloth.

Plastic

Permanent deformation of the object after a collision. The vertices take a new position without applying the modifier.

Bending

This option creates virtual connections between a vertex and the vertices connected to its neighbors. This includes diagonal edges. Damping also applies to these connections.

Length

The edges can shrink or be blown up. This value is given in percent, 0 disables this function. 100% means no change, the body keeps 100% of its size.

Collision Edge

Checks for edges of the soft body mesh colliding.

Face

Checks for any portion of the face of the soft body mesh colliding (computationally intensive!). While Face enabled is great, and solves lots of collision errors, there does not seem to be any dampening settings for it, so parts of the soft body object near a collision mesh tend to “jitter” as they bounce off and fall back, even when there is no motion of any meshes. Edge collision has dampening, so that can be controlled, but Deflection dampening value on a collision object does not seem to affect the face collision.

Aerodynamics sub subpanel

Force from surrounding media. See exterior forces for details.

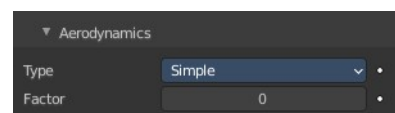

Type

Simple

Edges receive a drag force from the surrounding media.

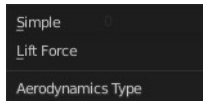

Lift Force

Edges receive a lift force when passing through the surrounding media.

Factor

How much aerodynamic force to use. Try a value of 30 at first.

Stiffness sub subpanel

Add diagonal springs at quad faces. This stops quad faces to collapse completely on collisions.

Shear

Stiffness of the virtual springs created for quad faces.

Self Collision subpanel

Note! Self-Collision needs Edges enabled!

Allow self collision and avoid self intersection. Every vertex is surrounded with an elastic virtual ball. Vertices may not penetrate the balls of other vertices. If you want a good result you may have to adjust the size of these balls.

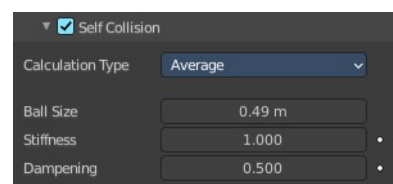

Calculation Type

Manual

The Ball Size directly sets the ball size.

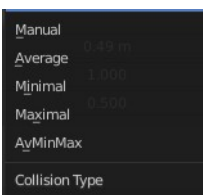

Average

The average length of all edges attached to the vertex is calculated and then multiplied with the Ball Size setting. Works well with evenly distributed vertices.

Minimal / Maximal

The ball size is as large as the smallest/largest spring length of the vertex multiplied with the Ball Size.

Average Min Max

Size = ((Min + Max)/2) × Ball Size.

Ball Size

Fraction of the length of attached edges. The edge length is computed based on the chosen algorithm. This setting is the factor that is multiplied by the spring length. It is a spherical distance (radius) within which, if another vertex of the same mesh enters, the vertex starts to deflect in order to avoid a self-collision. Set this value to the fractional distance between vertices that you want them to have their own “space”. Too high of a value will include too many vertices all the time and slow down the calculation. Too low of a level will let other vertices get too close and thus possibly intersect because there will not be enough time to slow them down.

Stiffness

How elastic that ball of personal space is. A high stiffness means that the vertex reacts immediately to another vertex enters their space.

Dampening

How the vertex reacts. A low value just slows down the vertex as it gets too close. A high value repulses it.

Collisions with other objects are set in the (other) Collision panel. To collide with another object they have to share at least one common layer.

Solver subpanel

The settings in the Soft Body Solver panel determine the accuracy of the simulation.

Step Size Min

Minimum simulation steps per frame. Increase this value, if the soft body misses fast-moving collision objects.

Max

Maximum simulation steps per frame. Normally the number of simulation steps is set dynamically (with the Error Limit) but you have probably a good reason to change it.

Auto-Step

Use velocities for automatic step sizes. Helps the Solver figure out how much work it needs to do based on how fast things are moving.

Error Limit

Rules the overall quality of the solution delivered. Default 0.1. The most critical setting that defines how precise the solver should check for collisions. Start with a value that is half the average edge length. If there are visible errors, jitter, or over-exaggerated responses, decrease the value. The solver keeps track of how “bad” it

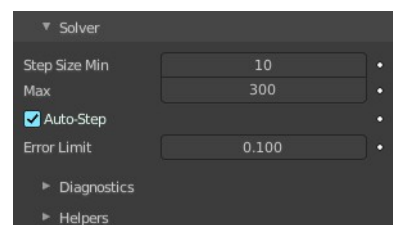

is doing and the Error Limit causes the solver to do some “adaptive step sizing”.

Diagnostics sub subpanel

Print Performance to Console

Prints on the console how the solver is doing.

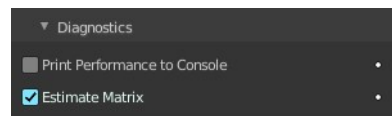

Estimate Matrix

Estimate matrix, split to COM, ROT, SCALE.

Helpers sub subpanel

These settings allow you to control how Blender will react (deform) the soft body once it either gets close to or actually intersects (cuts into) another collision object on the same layer.

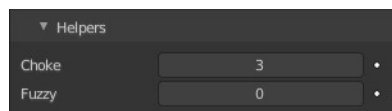

Choke

Calms down (reduces the exit velocity of) a vertex or edge once it penetrates a collision mesh.

Fuzzy

Fuzziness while on collision, high values make collision handling faster but less stable. Simulation is faster, but less accurate.

Field Weights subpanel

Adjust how strong other forces influences the soft body simulation.

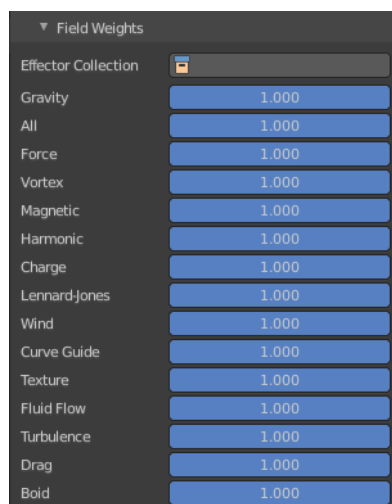



26.12.6 Editors - Properties Editor - Physics Properties Tab - Fluid panel

Table of content

Detailed table of content.....	2
Fluid Simulation.....	9
Workflow Liquid.....	9
Fluid Tab.....	10
Type.....	10
Domain - Settings subpanel.....	11
Domain type.....	11
Resolution Divisions.....	11
Time Scale.....	11
CFL Number.....	12
Use Adaptive Time Steps.....	12
Timesteps Maximum.....	12
Using Scene Gravity X, Y , Z.....	12
Empty Space.....	12
Delete In Obstacle.....	12
Border Collisions subpanel.....	13
Adaptive Domain.....	13
Domain - Gas subpanel.....	13
Buoyancy Density.....	13
Buoyancy Heat.....	13
Vorticity.....	14
Dissolve subpanel.....	14
Domain - Liquid subpanel.....	14
Simulation Method.....	14
FLIP Ratio.....	14
Particle Radius.....	14
Sampling.....	14
Randomness.....	15
Particles Maximum.....	15
Minimum.....	15
Narrow Band Width.....	15
Fractional Obstacles.....	15
Diffusion subpanel.....	16
Particles sub tab.....	16
Mesh Sub tab.....	18
Domain - Guides subpanel.....	19
Weight.....	19
Size.....	19
Velocity Factor.....	20
Velocity Source.....	20
Domain - Collections subpanel.....	20
Flow.....	20
Effector.....	21
Domain - Cache subpanel.....	21
Cache Directory.....	21

Frame Start.....	21
End.....	21
Offset.....	21
Type.....	21
Is Resumable.....	22
Format Volumes.....	22
Meshes.....	22
Bake All, Free All.....	22
Advanced.....	23
Export Mantaflow Script.....	23
Domain - Field Weights subpanel.....	24
Domain - Viewport Display subpanel.....	24
Thickness.....	24
Interpolation.....	24
Slice per Voxel.....	24
Slice subpanel.....	24
Grid display subpanel.....	25
Vector display subpanel.....	28
Advanced subpanel.....	28
Flow - Settings subpanel.....	29
Flow Type.....	29
Flow - Settings subpanel - Flow Type Smoke.....	29
Flow Behavior.....	29
Flow - Settings subpanel - Flow Type Fire and Smoke.....	31
Flow Behavior.....	31
Flow - Settings subpanel - Flow Type Fire.....	33
Flow Behavior.....	33
Flow - Settings subpanel - Flow Type Liquid.....	35
Flow Behavior.....	36
Flow - Settings subpanel - Flow Source.....	37
Flow Source.....	37
Flow - Settings subpanel - Initial Velocity.....	38
Source.....	38
Normal.....	38
Initial X, Y, Z.....	38
Flow - Settings subpanel - Texture.....	38
Texture.....	38
Mapping.....	38
Offset.....	39
Effector - Settings Subpanel.....	39
Effector Type.....	39

Detailed table of content

Detailed table of content

Detailed table of content.....	2
Fluid Simulation.....	9
Workflow Liquid.....	9
Fluid Tab.....	10
Type.....	10
None.....	11

Domain.....	11
Flow.....	11
Effector.....	11
Domain - Settings subpanel.....	11
Domain type.....	11
Resolution Divisions.....	11
Time Scale.....	11
CFL Number.....	12
Use Adaptive Time Steps.....	12
Timesteps Maximum.....	12
Minimum.....	12
Using Scene Gravity X, Y , Z.....	12
Empty Space.....	12
Delete In Obstacle.....	12
Border Collisions subpanel.....	13
Adaptive Domain.....	13
Add Resolution.....	13
Margin.....	13
Threshold.....	13
Domain - Gas subpanel.....	13
Buoyancy Density.....	13
Buoyancy Heat.....	13
Vorticity.....	14
Dissolve subpanel.....	14
Domain - Liquid subpanel.....	14
Simulation Method.....	14
FLIP Ratio.....	14
Particle Radius.....	14
Sampling.....	14
Randomness.....	15
Particles Maximum.....	15
Minimum.....	15
Narrow Band Width.....	15
Fractional Obstacles.....	15
Obstacle Distance.....	15
Threshold.....	15
Diffusion subpanel.....	16
Presets.....	16
Base.....	16
Exponent.....	16
Surface Tension.....	16
Particles sub tab.....	16
Spray.....	16
Foam.....	16
Bubbles.....	16
Combined Export.....	17
Upres Factor.....	17
Wave Crest Potential Maximum.....	17
Wave Crest Potential Minimum.....	17
Trapped Air Potential Maximum.....	17
Trapped Air Potential Minimum.....	17
Kinetic Energy Potential Maximum.....	17
Kinetic Energy Potential Minimum.....	17

Potential Radius.....	17
Particle Update Radius.....	17
Wave Crest Particle Sampling.....	17
Trapper Air Particle Sampling.....	18
Particle Life Maximum.....	18
Particle Life Minimum.....	18
Bubble Buoyancy.....	18
Bubble Drag.....	18
Particles in Boundary.....	18
Delete.....	18
Push Out.....	18
Mesh Sub tab.....	18
Upres Factor.....	18
Particle Radius.....	18
Use Speed Vectors.....	18
Mesh Generator.....	19
Smoothing Positive.....	19
Negative.....	19
Concavity Upper.....	19
Concavity Lower.....	19
Domain - Guides subpanel.....	19
Weight.....	19
Size.....	19
Velocity Factor.....	20
Velocity Source.....	20
Effector.....	20
Bake Guides, Free Guides.....	20
Domain.....	20
Guide Parent.....	20
Domain - Collections subpanel.....	20
Flow.....	20
Effector.....	21
Domain - Cache subpanel.....	21
Cache Directory.....	21
Accept.....	21
Frame Start.....	21
End.....	21
Offset.....	21
Type.....	21
Replay.....	22
Modular.....	22
All.....	22
Is Resumable.....	22
Format Volumes.....	22
Uni Cache.....	22
OpenVDB.....	22
Meshes.....	22
Binary Object.....	22
Object.....	22
Bake All, Free All.....	22
Advanced.....	23
Compression Volumes.....	23
None.....	23

Zip.....	23
Blosc.....	23
Precision Volumes.....	23
Float (Full).....	23
Float (Half).....	23
Export Mantaflow Script.....	23
Domain - Field Weights subpanel.....	24
Domain - Viewport Display subpanel.....	24
Thickness.....	24
Interpolation.....	24
Slice per Voxel.....	24
Slice subpanel.....	24
Axis.....	24
Position.....	24
Gridlines.....	25
Color Gridlines.....	25
Lower Bound.....	25
Upper Bound.....	25
Color.....	25
Cell Type.....	25
Grid display subpanel.....	25
Domaintype Liquid.....	26
Field.....	26
Scale.....	26
Domaintype Gas.....	26
Field.....	26
Scale.....	26
Color ramp.....	26
Controls.....	26
+.....	26
-.....	26
Tools menu.....	26
Flip Color Ramp.....	26
Distribute Stops from Left.....	27
Distribute Stops Evenly.....	27
Eyedropper (pipette icon) E.....	27
Reset Color Ramp.....	27
Color Mode.....	27
RGB.....	27
HSV/HSL.....	27
Interpolation.....	27
Ease.....	27
Cardinal.....	27
Linear.....	27
B-Spline.....	27
Constant.....	27
Color Ramp.....	27
Active Color Stop elements.....	27
Choose active color stop.....	27
Pos.....	27
Vector display subpanel.....	28
Display as.....	28
Magnitude.....	28

MAC Grid X Y Z.....	28
Field.....	28
Scale.....	28
Advanced subpanel.....	28
Color Gridlines.....	28
Lower Bound.....	28
Upper Bound.....	28
Color.....	28
Cell Type.....	29
Flow - Settings subpanel.....	29
Flow Type.....	29
Flow - Settings subpanel - Flow Type Smoke.....	29
Flow Behavior.....	29
Inflow.....	29
Use Flow.....	29
Sampling Substeps.....	30
Smoke Color.....	30
Absolute Density.....	30
Initial Temperature.....	30
Density.....	30
Vertex Group.....	30
Outflow.....	30
Use Flow.....	30
Sampling Substeps.....	30
Geometry.....	30
Sampling Substeps.....	31
Smoke Color.....	31
Absolute Density.....	31
Initial Temperature.....	31
Density.....	31
Vertex Group.....	31
Flow - Settings subpanel - Flow Type Fire and Smoke.....	31
Flow Behavior.....	31
Inflow.....	31
Use Flow.....	31
Sampling Substeps.....	32
Smoke Color.....	32
Absolute Density.....	32
Initial Temperature.....	32
Density.....	32
Fuel.....	32
Vertex Group.....	32
Outflow.....	32
Use Flow.....	32
Sampling Substeps.....	32
Geometry.....	33
Sampling Substeps.....	33
Smoke Color.....	33
Absolute Density.....	33
Initial Temperature.....	33
Density.....	33
Fuel.....	33
Vertex Group.....	33

Flow - Settings subpanel - Flow Type Fire.....	33
Flow Behavior.....	33
Inflow.....	34
Use Flow.....	34
Sampling Substeps.....	34
Smoke Color.....	34
Absolute Density.....	34
Initial Temperature.....	34
Density.....	34
Fuel.....	34
Vertex Group.....	34
Outflow.....	34
Use Flow.....	35
Sampling Substeps.....	35
Geometry.....	35
Sampling Substeps.....	35
Smoke Color.....	35
Absolute Density.....	35
Initial Temperature.....	35
Density.....	35
Fuel.....	35
Vertex Group.....	35
Flow - Settings subpanel - Flow Type Liquid.....	35
Flow Behavior.....	36
Inflow.....	36
Use Flow.....	36
Sampling Substeps.....	36
Outflow.....	36
Use Flow.....	36
Sampling Substeps.....	36
Geometry.....	36
Sampling Substeps.....	37
Flow - Settings subpanel - Flow Source.....	37
Flow Source.....	37
Mesh.....	37
Is Planar.....	37
Surface Emission.....	37
Volume Emission.....	37
Particle System.....	37
Particle System.....	37
Set Size.....	38
Size.....	38
Flow - Settings subpanel - Initial Velocity.....	38
Source.....	38
Normal.....	38
Initial X, Y, Z.....	38
Flow - Settings subpanel - Texture.....	38
Texture.....	38
Mapping.....	38
Generated.....	39
Size.....	39
UV.....	39
UV Map.....	39

Offset.....	39
Effector - Settings Subpanel.....	39
Effector Type.....	39
Collision.....	39
Guide.....	39
Sampling Substeps.....	39
Surface Thickness.....	40
Use Effector.....	40
Is Planar.....	40
Velocity Factor.....	40
Guide Mode.....	40
Maximize.....	40
Minimize.....	40
Override.....	40
Averaged.....	40

Fluid Simulation

Fluid physics are used to simulate physical properties of liquids. Gas or smoke simulations are a subset of the fluids system.

A fluid system is made of at least two objects. The domain object defines the space in which the simulation happens. And the flow object defines the fluid simulation. There is a third object type called effector. This is a collider object for the simulation.

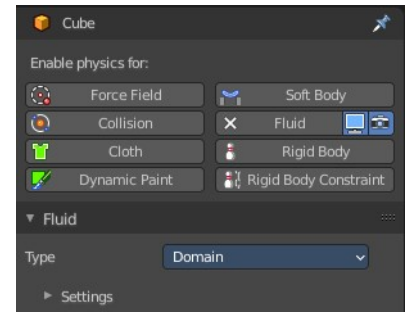

The smoke movement is controlled by airflow inside the domain, which can be influenced by Effector objects. Smoke will also be affected by the scene's gravity and force fields. Airflow inside the domain can affect other physics simulations via the Smoke Flow force field.

Note that you can create quick smoke and liquid effects in the Object menu in the Quick Effects sub menu. They come with the correct setup already.



Workflow Liquid

At least a Domain object and one Flow object are required to create a fluid simulation.

First create the flow object. Add a cube. Set the flow type to Liquid.

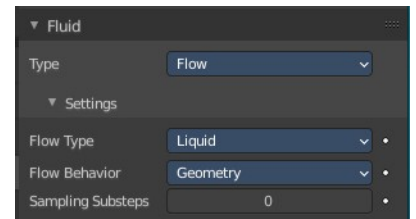

Now create a second cube. This will be our Domain object that defines the bounds of the simulation volume. Scale it a bit bigger. You should also set the render type to wire frame. So that you can see the fluid simulation. Object properties, Viewport Display, Display as ...

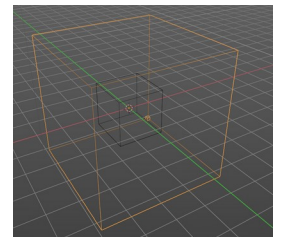

In the Fluid tab set the domain type to Liquid.

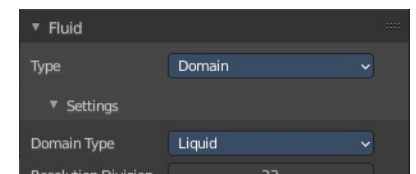

Add Effector objects. Effector objects are objects at which the fluid will collide.

Assign a material to the domain object. Glass for example.

Save the blend-file.

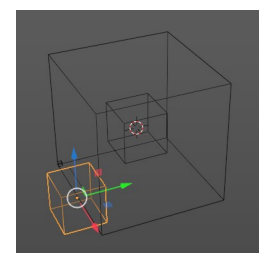

Bake the Cache for the simulation by hitting play. There is no bake data button with the default cache settings. It happens by playing the animation.

The liquid animation may not appear immediately. You need to play the animation through for at least one time. That's how the simulation gets calculated.

In case it does not show, let it play through a few more times until it does. It may also help to save the file and reload it. In case it still doesn't show you should check your setup.

Note, when you add effectors afterwards, then the effectors are not calculated. You need to update the cache. This can for example be done by changing cache settings for a moment. Ticking and unticking is resumable does the trick. You need to play the animation through again then.

Note! There are Quick Liquid and Quick Smoke tools which will automatically create a domain object with a basic liquid or smoke and fire material.

To render the fluid animation you need to activate Mesh in the Liquid tab. The Flip particles will not render.

You may also want to add some environment content like a hdri to have something to reflect in the water.

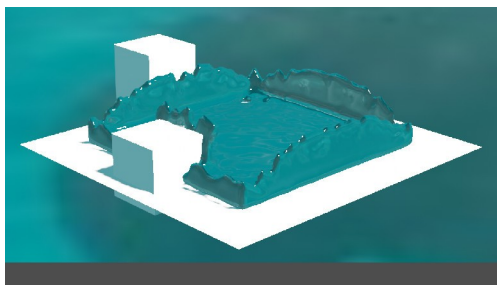
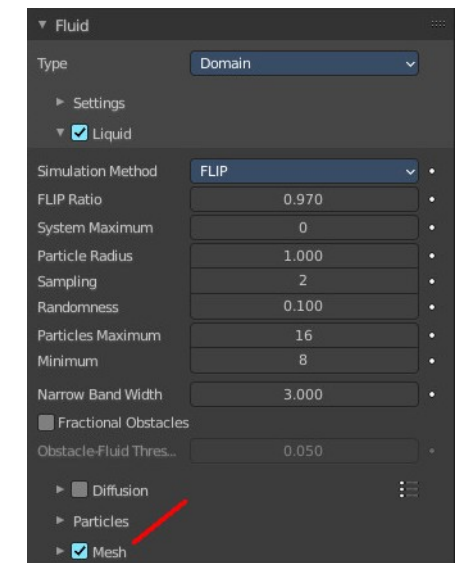
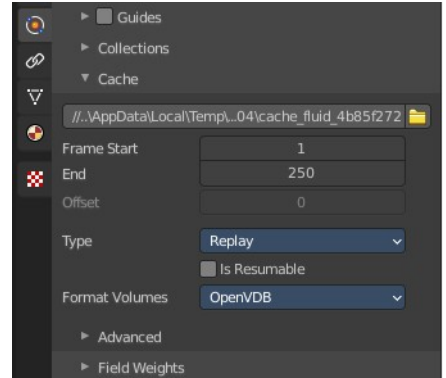

Fluid Tab

Type

Fluid simulation is made of three object types. Two are needed to get the simulation going. Domain and Flow. Effectors are additional collider objects.

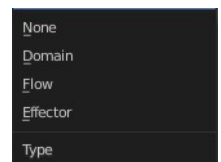

None

No fluid type defined.

Domain

The domain object contains the entire simulation. Fluid simulations cannot leave the domain, it will either collide with the edge or disappear, depending on the domain's settings.

Flow

Fluid Flow types are used to add or remove fluid to a domain object. Flow objects should be contained within the domain's bounding box in order to work.

Effector

Effector objects are used as colliders and to influence the fluid flow.

Domain - Settings subpanel

Domain type

A fluid domain can control either liquid or gas flows. Liquid domains take all liquid flow objects that intersect with the domain into consideration. Gas domains consider all intersecting Smoke, Fire, and Smoke + Fire flow objects. It is not possible to change the domain type dynamically.

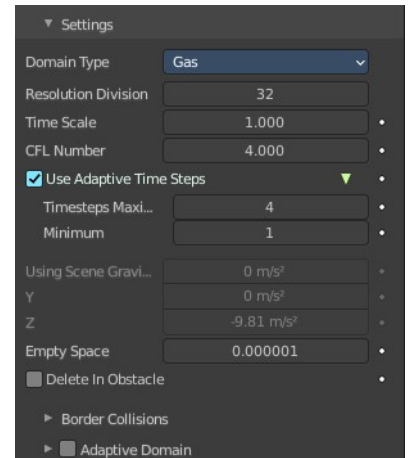
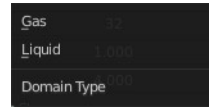

Resolution Divisions

The fluid domain is subdivided into many “cells” called voxels which make up “pixels” of fluid. This setting controls the number of subdivisions in the domain. Higher numbers of subdivisions are one way of creating higher resolution fluids.

Since the resolution is defined in terms of “subdivisions”, larger domains will need more divisions to get an equivalent resolution to a small domain. For example, a one meter cube with 64 Resolution Divisions will need 128 divisions to match a 2 meter cube. The dimension used as the base division is the longest dimension of the objects bounding box. To help visualize the voxel size, the Resolution Divisions can be previewed with a small cube shown in the 3D Viewport, to show the size of these divisions.

Time Scale

Controls the speed of the simulation. Low values result in a “slow motion” simulation, while higher values can be used to advance the simulation faster. Which is good for generating fluids to be used in still renders.

CFL Number

Determines the maximum velocity per grid cell and is measured in grid cells per time step. Fluid is only allowed to move up to this velocity in one time step. If this threshold is exceeded the solver will subdivide the simulation step.

In general, greater CFL (Courant–Friedrichs–Lewy) numbers will minimize the number of simulation steps and the computation time. Yet it will yield less physically accurate behavior for fast fluid flows. Smaller CFL numbers result in more simulation steps per frame, longer simulation times but more accurate behavior at high velocities (e.g. fast fluid flow colliding with obstacle).

Note! When lowering the CFL number it is recommended to increase the maximum number of time steps. Similarly, when increasing the CFL number the minimum number of time steps should be adjusted.

Use Adaptive Time Steps

Lets the solver automatically decide when to perform multiple simulation steps per frame. It takes into account the maximum and minimum number of time steps, the current Frame Rate, and the Time Scale.

Timesteps Maximum

Maximum number of allowed time steps per frame. If needed, the solver will divide a simulation step up to this number of sub-steps.

Minimum

Minimum number of allowed time steps per frame. The solver will always perform at least this number of simulation steps per frame.

Using Scene Gravity X, Y , Z

By default the fluid solver will use the global scene gravity. This behavior can be disabled in the scene settings. Disabling the global gravity will enable the fluid gravity options. And then this props becomes enabled.

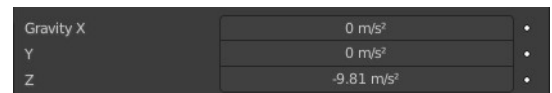
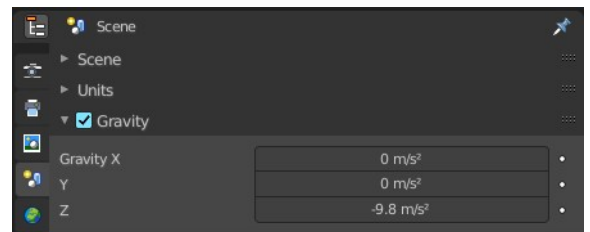

Empty Space

Gas Only! Value under which voxels are considered empty space to optimize rendering.

Delete In Obstacle

Remover any volume of fluid that intersects with an obstacle inside the domain.

Border Collisions subpanel

Enable collisions with the following domain sides.

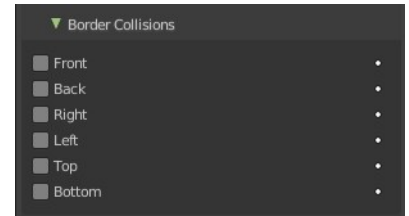

Adaptive Domain

Gas only! The domain will adaptively shrink to best fit the gas, saving computation time by leaving voxels without gas out of the simulation. Unless the Add Resolution is used, the adaptive domain will not exceed the bounds of the original domain.

Add Resolution

Number of voxels to add around the outside of the domain.

Margin

Amount of extra space to leave around gas, measured in voxels. With very fast-moving gas larger margins may be required to prevent the gas from being cut off by the adaptive boundary, but note this will increase the number of voxels which need to be computed.

Threshold

Smallest amount of gas a voxel can contain before it is considered empty and the adaptive domain is allowed to cut it out of the simulation.

Domain - Gas subpanel

Domain type Gas only!

Buoyancy Density

Buoyant force based on smoke density.

Values above 0 will cause the smoke to rise (simulating smoke which is lighter than ambient air).

Values below 0 will cause smoke to sink (simulating smoke which is heavier than ambient air).

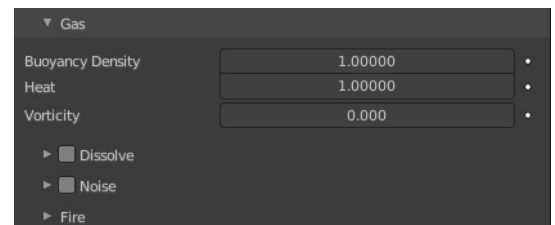

Buoyancy Heat

Controls how much smoke is affected by temperature. The effect this setting has on smoke depends on the per flow object Initial Temperature:

Values above 0 will result in the smoke rising when the flow object Initial Temperature is set to a positive value, and smoke sinking when the flow object Initial Temperature is set to a negative value.

Values below 0 will result in the opposite of positive values, i.e. smoke emitted from flow objects with a positive Initial Temperature will sink, and smoke from flow objects with a negative Initial Temperature will rise.

Note that smoke from multiple flow objects with different temperatures will mix and warm up or cool down until an equilibrium is reached.

Vorticity

Controls the amount of turbulence in the smoke. Higher values will make lots of small swirls, while lower values make smoother shapes.

Dissolve subpanel

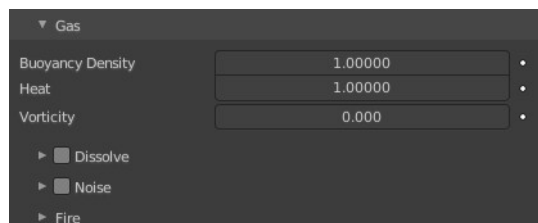

Domain - Liquid subpanel

Domain type Liquid only!

Simulation Method

Determines the particle simulation method. Currently, FLIP is the only option to choose from.

FLIP Ratio

How much FLIP velocity to use when updating liquid particle velocities. A value of 1.0 will result in a completely FLIP based simulation. Completely FLIP based simulations produce more chaotic splashes and are preferable when simulating greater quantities of liquid. When using smaller values the behavior will be less turbulent and splashes are more subtle. This is optimal when simulating scenes where the liquid is supposed to be on a small scale.

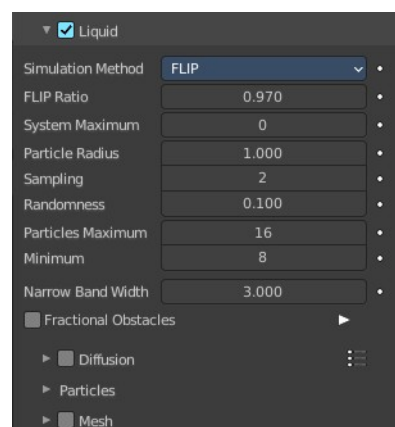

Particle Radius

The radius of one liquid particle in grid cells units. This value describes how much area is covered by a particle and thus determines how much area around it can be considered as liquid. A greater radius will let particles cover more area. This will result in more grids cell being tagged as liquid instead of just being empty.

Whenever the simulation appears to leak or gain volume in an undesired, non physically accurate way it is a good idea to adjust this value. That is, when liquid seems to disappear this value needs to be increased. The inverse applies when too much liquid is being produced.

Sampling

Factor that is used when sampling particles. A higher value will sample more particles. Note that particle resampling occurs at every single simulation step.

Randomness

New particles are sampled with some randomness attached to their position which can be controlled by this field. Higher values will sample the liquid particles more randomly in inflow regions. With a value of 0.0 all new particles will be sampled uniformly inside their corresponding grid cells.

When trying to create a laminar inflow (with little randomness) or more turbulent flows (with greater randomness) this value can be useful.

Particles Maximum

The maximum number of liquid particles per grid cell. During a simulation the number of liquid particles in a cell can fluctuate: Particles can flow into other cells or can get deleted if they move outside the narrow band. Resampling will add new particles considering this maximum.

This value sets the upper threshold of particles per cell. It is also a good way to estimate how many particles there can be in your simulation (one needs to take grid resolution into account too). This can be useful before baking and when planning a simulation.

Minimum

The minimum number of liquid particles per grid cell. Similarly to the maximum particle threshold, this value ensures that there are at least a certain amount of particles per cell.

Narrow Band Width

Controls the width in grid cell units of the narrow band that liquid particles are allowed to flow in. A high value will result in a thicker band and can result in an inflow region completely filled with particles. Unless the goal of the simulation is to visualize the liquid particles it is recommended to not increase the band width significantly as more particles slow down the simulation.

In some situations increasing this value can help create volume when the simulation appears to leak. In all other cases it is best to keep the narrow band as thin as possible since the liquid surface contains most details and simulating particles inside the liquid is not an optimal use of computing resources.

Fractional Obstacles

Enables finer resolution in fluid / obstacle regions (second order obstacles).

This option reduces the “stepping effect” that results when an obstacles lies inclined inside the domain. It also makes liquid flow more smoothly over an obstacle.

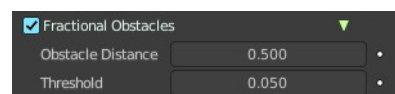

Obstacle Distance

How far apart fluid and obstacle are.

Threshold

How much fluid is allowed in an obstacle cell

Diffusion subpanel

Liquid diffusion defines the physical properties of a liquid and in turn define how a liquid interacts with its environment. The main factors of diffusion are the Viscosity and Surface Tension. These properties can be adjusted to create virtual liquids that behave like water, oil, honey, or any other liquid.



Warning! The simulator is not suitable for non-fluids, such as materials that do not “flow”. Simply setting the viscosity to very large values will not result in rigid body behavior, but might cause instabilities.

Presets

Diffusion presets. To add a preset type in a name and click at the plus button. To remove a preset click at the minus button

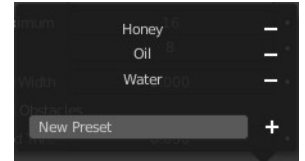

Base

The base of the viscosity value.

Exponent

The exponent of the viscosity value.

Surface Tension

Surface tension in grid units. Higher value will produce liquids with greater surface tension.

Particles sub tab

Spray

Create spray particles during the secondary particle simulation. Spray particles are those that appear to fly through the air above the liquid surface when there is a bigger splash.

Foam

Create foam particles during the secondary particle simulation. Foam particles are those that solely move on the liquid surface.

Bubbles

Create bubble particles during the secondary particle simulation. Bubble particles are those that move below the liquid surface.

Note! Enabling a secondary particle type will also create a particle system for that type of particles. Disabling a particle type will delete this particle system including its settings.

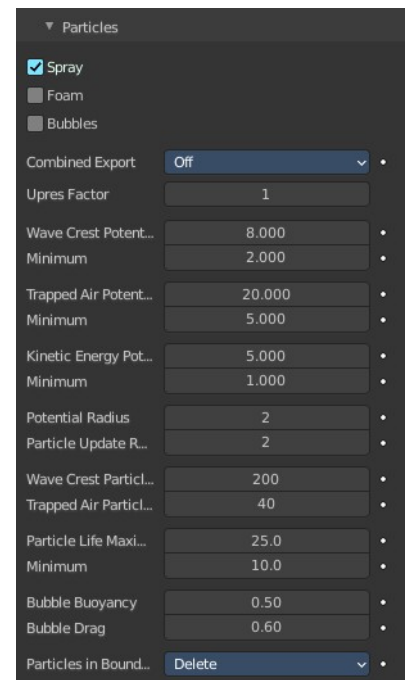

Combined Export

Select particle types that should go into the same particle system. This option has no effect on the outcome of the simulation. It only changes the way particle systems are allocated in the particle settings.



Upres Factor

Factor by which to enhance the resolution of the particle simulation. The scaling factor is coupled to the Resolution Divisions (i.e. the particle simulation is this times bigger than the base simulation).

Wave Crest Potential Maximum

Upper clamping threshold for marking fluid cells as wave crests. A higher value results in less marked cells.

Wave Crest Potential Minimum

Lower clamping threshold for marking fluid cells as wave crests. A lower value results in more marked cells.

Trapped Air Potential Maximum

Upper clamping threshold for marking fluid cells where air is trapped. A higher value results in less marked cells.

Trapped Air Potential Minimum

Lower clamping threshold for marking fluid cells where air is trapped. A lower value results in more marked cells.

Kinetic Energy Potential Maximum

Upper clamping threshold for marking fluid cells where air is trapped. A higher value results in less marked cells.

Kinetic Energy Potential Minimum

Lower clamping threshold that indicates the fluid speed where cells start to emit particles. A lower values result in generally more particles.

Potential Radius

Radius to compute potential for each cell. Higher values are slower but create smoother potential grids.

Particle Update Radius

Radius to compute position update for each particle. Higher values are slower but particles move less chaotic.

Wave Crest Particle Sampling

Maximum number of particles generated per wave crest cell per frame.

Trapper Air Particle Sampling

Maximum number of particles generated per trapped air cell per frame.

Particle Life Maximum

Highest possible particle lifetime.

Particle Life Minimum

Lowest possible particle lifetime.

Bubble Buoyancy

Amount of buoyancy force that rises bubbles. A high value results in bubble movement mainly upwards.

Bubble Drag

Amount of drag force that moves bubbles along with the fluid. A high value results in bubble movement mainly along with the fluid.

Particles in Boundary

Delete

Delete secondary particles that are inside obstacles or left the domain.

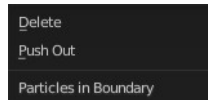

Push Out

Push secondary particles that left the domain back into the domain.

Mesh Sub tab

Enables the display for the fluid as a mesh. When you want to render a liquid simulation then you need to convert it to a mesh object.

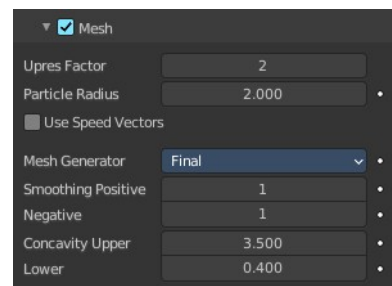

Upres Factor

Factor by which to enhance the resolution of the mesh. The scaling factor is coupled to the Resolution Divisions (i.e. the mesh is this times bigger than the base simulation).

Particle Radius

The radius of one liquid particle in grid cells units. This value describes how much area is covered by a particle and thus determines how much area around it can be considered as liquid. A greater radius will let particles cover more area. This will result in meshes covering more volume around liquid particles.

Use Speed Vectors

Store speed vectors on drive.

Mesh Generator

The mesh generator method determines the accuracy of the mesh.

The Final option produces a higher quality mesh and provides more configuration option.

The Preview option is faster. But not as smooth. And has no settings.

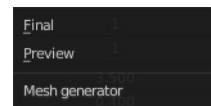

Smoothing Positive

Positive mesh smoothing iterations. Higher values will make the mesh outline increasingly smooth. Yet higher values can prevent small details (e.g. smaller liquid drops) from getting meshed.

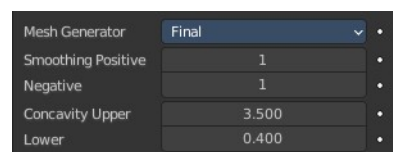

Negative

Negative mesh smoothing iterations. Higher values will make the mesh outline sharper. High values will preserve details, however, the mesh outline will become more ragged. A single mesh particle will become less rounded and have more flat sides.

Concavity Upper

Upper mesh concavity bound. High values tend to smoothen and fill out concave regions.

Concavity Lower

Lower mesh concavity bound. High values tend to smoothen and fill out concave regions.

Using a lower concavity which is greater the upper concavity can result in distorted, non-manifold meshes.

Domain - Guides subpanel

Fluid guides are used to apply forces onto the simulation. They are like simple external forces but also seek to preserve the physically accurate flow of the fluid. The Guides panel allows you to adjust guiding forces globally, for the entire domain. Enabling the guides hints the fluid solver to use the more accurate, but also computationally more expensive pressure solving step.

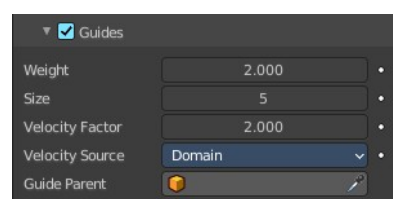

Even when there are no guiding objects baked or there is no guiding domain attached, the fluid solver will still perform the more expensive pressure guiding algorithm if guiding is enabled. It is therefore recommended to only enable Guides when there is a clear intention to use guiding in the simulation.

Weight

The guiding weight.

Size

This setting determines the size of the vertices that the guiding produces. A greater guiding size (also known as

the blur radius or “beta” guiding value) results in larger vertices.

Velocity Factor

All guiding velocities are multiplied by this factor. That is, every cell of the guiding grid, which has the same size as the domain object, is multiplied by this factor.

Velocity Source

The velocity guiding source. Guiding velocities can either come from objects that move inside the domain or from other fluid domains.



Effector

All effector objects inside the domain will be considered for the global guiding velocity grid. Once effector objects have been baked it is not possible to change the fluid domain resolution anymore.

Bake Guides, Free Guides

This option is only available when using the Modular cache type and when using Effector as the Velocity Source. Bake Guides writes vertex velocities of effector objects to drive. It is meant to be used before baking the fluid simulation.

The progress will be displayed in the status bar. Pressing Esc will pause the simulation.

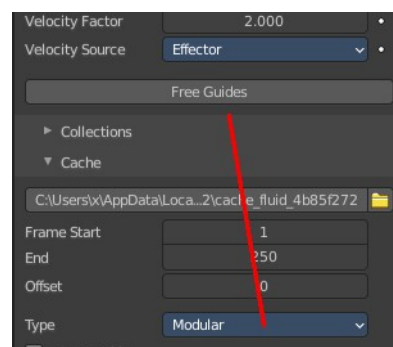

Once the simulation has been baked, the cache can be deleted by pressing Free Guides. It is possible to pause or resume a Bake Guides process.

Domain

When using another fluid domain as the guiding velocity source this domain may have a different resolution and may also be of a different type (e.g. the guiding domain is of type Gas while the actual domain with the guiding effect in it is of type Liquid).

In order to use a domain as the velocity source, this domain needs to be baked already.

Guide Parent

Pick the guiding domain object when using Domain as the velocity source.

Domain - Collections subpanel

Flow

If set, only objects in the specified Collection will be allowed to act as Flow objects in this domain.

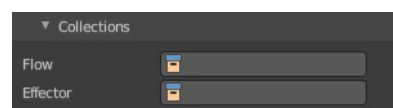

Effector

If set, only objects in the specified Collection will be allowed to act as Effector objects in this domain.

Domain - Cache subpanel

The Cache panel is used to Bake the fluid simulation and stores the outcome of a simulation so it does not need to be recalculated.

If the mesh has modifiers, the rendering settings are used for exporting the mesh to the fluid solver. Depending on the setting, calculation times and memory use might exponentially increase. For example, when using a moving mesh with Subdivision Surface as an obstacle, it might help to decrease simulation time by switching it off, or to a low subdivision level.

When the setup/rig is correct, you can always increase settings to yield a more realistic result.

Note! Fluid simulations use their own cache. All other physics simulations make use of the General Baking operators.

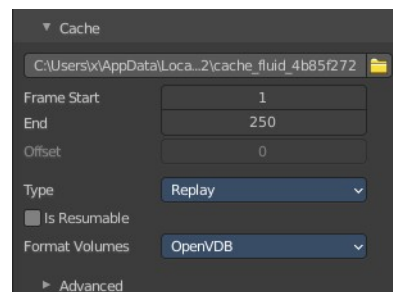

Cache Directory

Directory to store baked simulation files in. Inside this directory each simulation type (i.e. mesh, particles, noise) will have its own directory containing the simulation data.

Accept

Open a file browser to set a directory.

Frame Start

Frame on which to start the simulation. This is the first frame that will be baked.

End

Frame on which to stop the simulation. This is the last frame that will be baked.

Note! The simulation is only calculated for positive frames between the Start and End frames of the Cache panel. So if you want a simulation that is longer than the default frame range you have to change the End frame.

Offset

Type Modular and All. Frame offset that is used when loading the simulation from the cache. It is not considered when baking the simulation, only when loading it.

Type

The type of the cache determines how the cache can be baked.

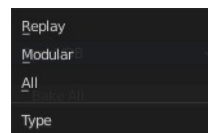

Replay

The cache will be baked as the simulation is being played in the viewport.

Modular

The cache will be baked step by step: The bake operators for this type are spread across various panels within the domain settings (e.g. the bake tool for the mesh can be found in the Mesh panel).

All

The cache will be baked with a single tool. All selected settings will be considered during this bake. The bake tool for this type can be found in the Cache panel.

Is Resumable

Extra data will be saved so that you can resumed baking after pausing. Since more data will be written to drive it is recommended to avoid enabling this option when baking at high resolutions.

Format Volumes

File format for volume based simulation data (i.e. grids and particles).

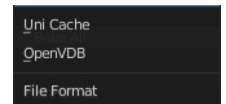

Uni Cache

Blender's own caching format with some compression. Each simulation object is stored in its own .uni cache file.

OpenVDB

Advanced and efficient storage format. All simulation objects (i.e. grids and particles) are stored in a single .vdb file per frame.

Meshes

With Mesh activated.

File format for the mesh cache files.

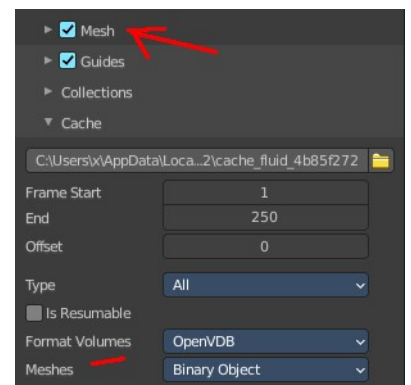
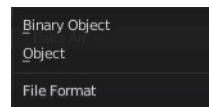

Binary Object

Mesh data files with some compression.

Object

Simple, standard data format for mesh data.

Bake All, Free All

This option is only available when using the All cache type. Bake All will run the simulation considering all parameters from the settings.

The progress will be displayed in the status bar. Pressing Esc will abort the

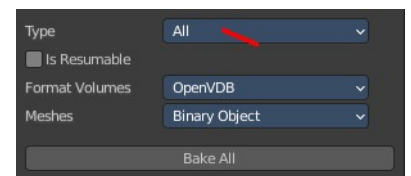

simulation.

Once the simulation has been baked, the cache can be deleted by pressing Free All. It is not possible to pause or resume a Bake All process as only the most essential cache files are stored on drive.

Advanced

Shows with Format Volumes OpenVDB.

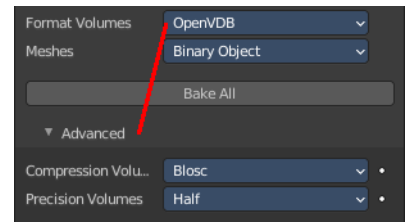

Compression Volumes

Compression format that is used when writing OpenVDB cache files.

None

Cache files will be written without any compression.

Zip

Cache files will be written with Zip compression. Effective but slower than Blosc.

Blosc

Cache files will be written with Blosc compression. Multi-threaded compression, similar in size and quality to Zip compression.

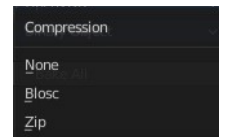

Precision Volumes

Precision level that is used when writing OpenVDB cache files.

Float (Full)

Volumetric data (e.g. grid values, particle positions) will be written with full precision (32 bit).

Float (Half)

Volumetric data (e.g. grid values, particle positions) will be written with half precision (16 bit).

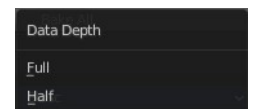

Export Mantaflow Script

Hidden debug feature!

Export the simulation as a standalone Mantaflow script when baking the scene (exported on « Bake Data »). Usually, only developers and advanced users who know how to use the Mantaflow GUI will make use of this functionality. Use a Debug Value of 3001 to enable. The debug menu can be found in the Text editor in the File menu.

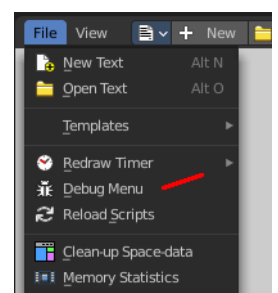
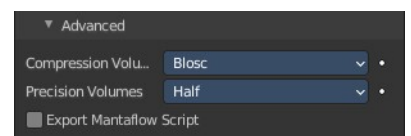

Domain - Field Weights subpanel

This panel allows you to adjust the single forces that affects the fluid simulation.

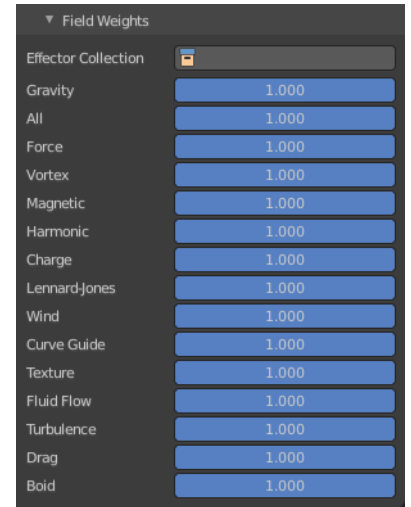

Domain - Viewport Display subpanel

How to display the domain in the viewport.

Thickness

Thickness of smoke drawing in the viewport.

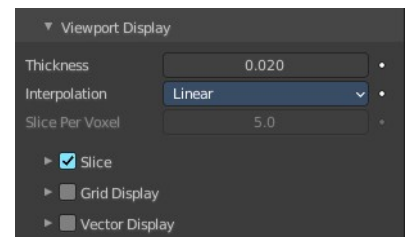

Interpolation

The interpolation method to use for smoke or fire volumes in solid mode.

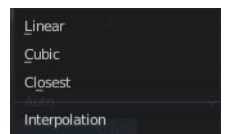

Slice per Voxel

How many slices per voxel should be generated. This prop is just active with domain type gas and Slice off.

Slice subpanel

Use manual slicing. Slice per Voxel will deactivate.

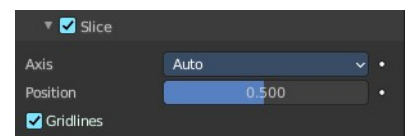

Axis

What axis to use. Auto uses the viewport orientation. The orientation will change when you rotate the view. X Y and Z uses the world axis.

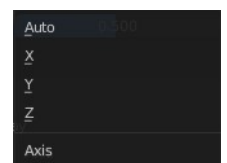

Position

The position of the slice.

Gridlines

Displays a grid inside the domain. This feature requires the Interpolation to be at Closest. It is inactive with the other two methods.

Activating grid lines reveals further content where you can tweak this grid further.

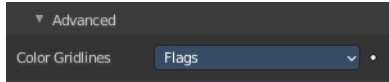
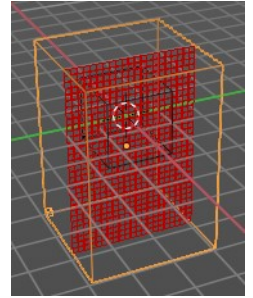
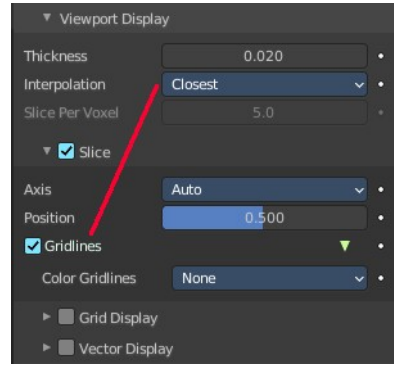

Color Gridlines

The simulation field to color map onto grid lines.

None and Flags have no further settings. The following settings belongs to Highlight Range. You need to have Grid Display ticked to get the settings for Highlight Range.

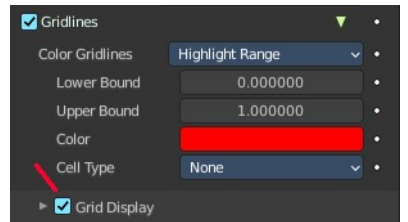
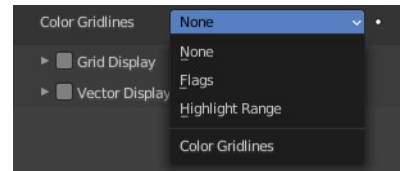

Lower Bound

The lower bound of the highlight range.

Upper Bound

The upper bound of the highlight range.

Color

The color to highlight the range

Cell Type

The cell type to be highlighted.

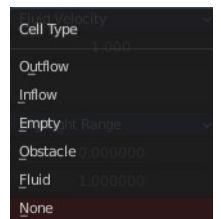

Grid display subpanel

Render a simulation field while mapping its voxel values to the color of a ramp or using a predefined color code.

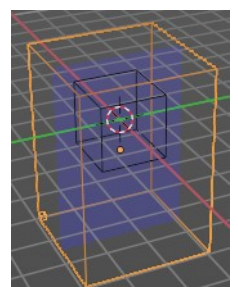

Domain type Liquid

Field

Choose the levelset representation of the fluid.

Scale

The multiplier to scale the selected field to color map.

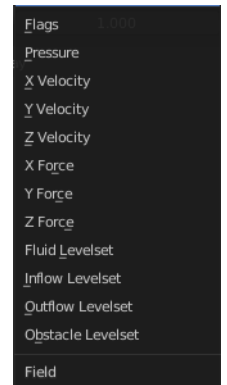
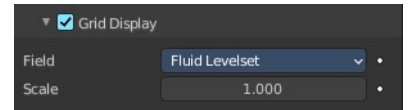

Domain type Gas

Field

Choose the levelset representation of the fluid.

Scale

The multiplier to scale the selected field to color map.

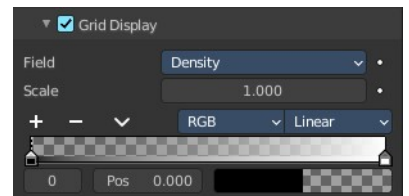

Color ramp

Define the colors of the color ramp.

Controls

+

Add a stop to your color ramp. The stop will be added after the selected one, in the middle to the next one.

-

Deletes the selected color stop from the list.

Tools menu

Flip Color Ramp

Flips the gradient, inverting the values of the color ramp.

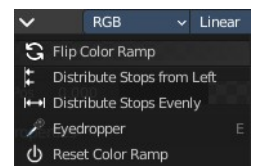

Distribute Stops from Left

Rearrange the stops so that every step has the same space to the right.

Distribute Stops Evenly

Space between all neighboring stops becomes equal.

Eyedropper (pipette icon) E

An Eyedropper to sample a color or gradient from the interface to be used in the color ramp.

Reset Color Ramp

Resets the color ramp to its default state.

Color Mode

RGB

Blends color by mixing each color channel and combining.

HSV/HSL

Blends colors by first converting to HSV or HSL, mixing, then combining again. This has the advantage of maintaining saturation between different hues, where RGB would de-saturate, this allows for a richer gradient.

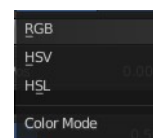

Interpolation

Ease

Uses an Ease Interpolation for the color stops.

Cardinal

Uses a Cardinal Interpolation for the color stops.

Linear

Uses a Linear Interpolation for the color stops.

B-Spline

Uses a B-Spline Interpolation for the color stops.

Constant

Uses a Constant Interpolation for the color stops.

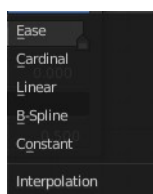

Color Ramp

The color band. A click at one of the color stops makes it the active one. You can move the color stops by clicking at them and dragging them around.



Active Color Stop elements

Adjust the active color stop.

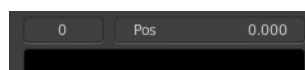

Choose active color stop

Choose the color stop by index.

Pos

The position of the active color stop. The range goes from 0.000 to 1.000

Vector display subpanel

Display as

Display the vectors as Needles, Streamlines or MAC Grid.

Magnitude

Needles and Streamlines. Scale the vectors with their magnitudes.

MAC Grid X Y Z

Show the x y or z component of the grid.

Field

The vector field to be represented by the display vectors

Scale

The multiplier for scaling the vectors.

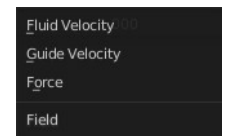
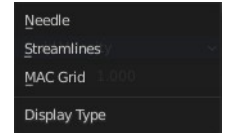
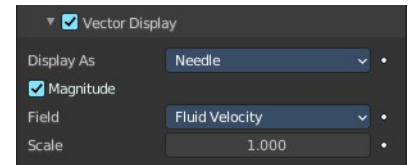

Advanced subpanel

This panel is connected to the Gridlines in the Slice panel. It just shows when Gridlines is activated. And it is just active when Slice is activated.

Color Gridlines

The simulation field to color map onto grid lines.

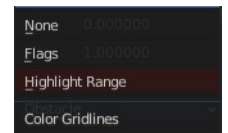
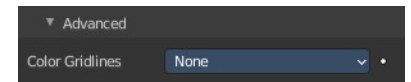

None and Flags have no further settings. The following settings belongs to Highlight Range.

Lower Bound

The lower bound of the highlight range.

Upper Bound

The upper bound of the highlight range.

Color

The color to highlight the range

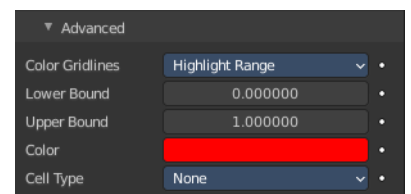

Cell Type

The cell type to be highlighted.

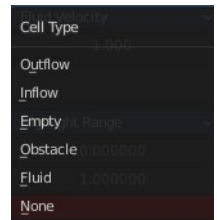

Flow - Settings subpanel

Flow Type

The type of the fluid in the simulation.

Fluid Flow types are used to add or remove fluid to a domain object. Flow objects should be contained within the domain's bounding box in order to work.

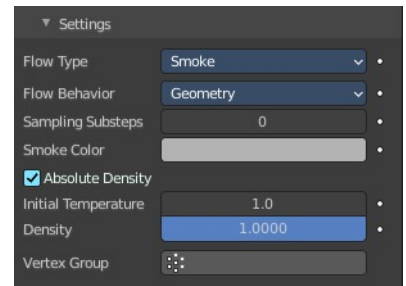

Flow - Settings subpanel - Flow Type Smoke

Emit only smoke.

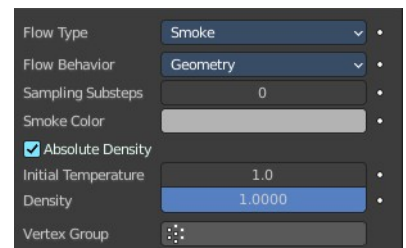

Flow Behavior

Controls if the Flow object either adds (Inflow), removes (Outflow), or turns the mesh itself into fluid (Geometry).

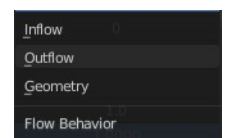

Inflow

This object will emit fluid into the simulation, like a water tap or base of a fire.

Use Flow

Enables or disables the flow of fluid, this property is useful for animations to selectively enable and disable when fluid is being added to or removed from the domain.

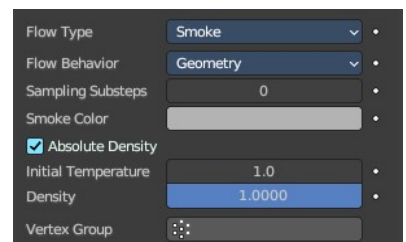

Sampling Substeps

Number of sub-steps used to reduce gaps in emission of fluid from fast-moving sources.

Smoke Color

The color of emitted smoke. When smoke of different colors are mixed they will blend together, eventually settling into a new combined color.

Absolute Density

If this checkbox is enabled, the emitter will only produce more smoke or fire if there is space for it in the emitter region. Otherwise smoke or fire will always be produced and add up.

Initial Temperature

Difference between the temperature of emitted smoke and the domain's ambient temperature. This setting's effect on smoke depends on the domain's Heat Buoyancy.

Density

Amount of smoke to emit at once. Larger values result in more density being produced.

Vertex Group

When set, use the specified Vertex Group to control where smoke is emitted.

Outflow

Any fluid that enters the bounding box of this object will be removed from the domain (think of a drain or a black hole). This can be useful in combination with an inflow to prevent the whole domain from filling up. Outflow objects can be animated and the area where the fluid disappears will follow the object as it moves around.

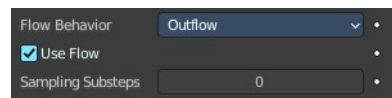

Use Flow

Enables or disables the flow of fluid, this property is useful for animations to selectively enable and disable when fluid is being added to or removed from the domain.

Sampling Substeps

Number of sub-steps used to reduce gaps in emission of fluid from fast-moving sources.

Geometry

All regions of this object that are inside the domain bounding box will be used as actual fluid in the simulation. You can place more than one fluid object inside the domain. Also make sure that the surface normals are pointing outwards or else they will not simulate properly. In contrast to domain objects, the actual mesh geometry is used for fluid objects.

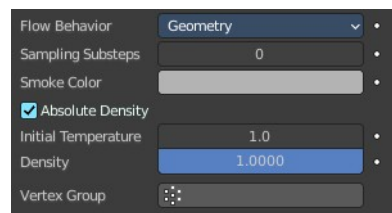

Sampling Substeps

Number of sub-steps used to reduce gaps in emission of fluid from fast-moving sources.

Smoke Color

The color of emitted smoke. When smoke of different colors are mixed they will blend together, eventually settling into a new combined color.

Absolute Density

If this checkbox is enabled, the emitter will only produce more smoke or fire if there is space for it in the emitter region. Otherwise smoke or fire will always be produced and add up.

Initial Temperature

Difference between the temperature of emitted smoke and the domain's ambient temperature. This setting's effect on smoke depends on the domain's Heat Buoyancy.

Density

Amount of smoke to emit at once. Larger values result in more density being produced.

Vertex Group

When set, use the specified Vertex Group to control where smoke is emitted.

Flow - Settings subpanel - Flow Type Fire and Smoke

Emit fire and smoke.

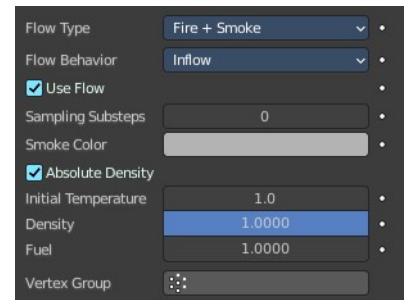

Flow Behavior

Controls if the Flow object either adds (Inflow), removes (Outflow), or turns the mesh itself into fluid (Geometry).

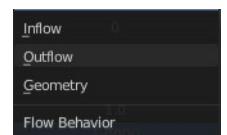

Inflow

This object will emit fluid into the simulation, like a water tap or base of a fire.

Use Flow

Enables or disables the flow of fluid, this property is useful for animations to

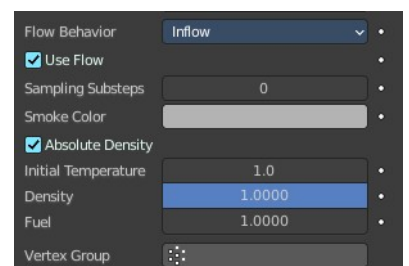

selectively enable and disable when fluid is being added to or removed from the domain.

Sampling Substeps

Number of sub-steps used to reduce gaps in emission of fluid from fast-moving sources.

Smoke Color

The color of emitted smoke. When smoke of different colors are mixed they will blend together, eventually settling into a new combined color.

Absolute Density

If this checkbox is enabled, the emitter will only produce more smoke or fire if there is space for it in the emitter region. Otherwise smoke or fire will always be produced and add up.

Initial Temperature

Difference between the temperature of emitted smoke and the domain's ambient temperature. This setting's effect on smoke depends on the domain's Heat Buoyancy.

Density

Amount of smoke to emit at once. Larger values result in more density being produced.

Fuel

Amount of "fuel" being burned per second. Larger values result in larger flames, smaller values result in smaller flames.

Vertex Group

When set, use the specified Vertex Group to control where smoke is emitted.

Outflow

Any fluid that enters the bounding box of this object will be removed from the domain (think of a drain or a black hole). This can be useful in

combination with an inflow to prevent the whole domain from filling up. Outflow objects can be animated and the area where the fluid disappears will follow the object as it moves around.



Use Flow

Enables or disables the flow of fluid, this property is useful for animations to selectively enable and disable when fluid is being added to or removed from the domain.

Sampling Substeps

Number of sub-steps used to reduce gaps in emission of fluid from fast-moving sources.

Geometry

All regions of this object that are inside the domain bounding box will be used as actual fluid in the simulation. You can place more than one fluid object inside the domain. Also make sure that the surface normals are pointing outwards or else they will not simulate properly. In contrast to domain objects, the actual mesh geometry is used for fluid objects.

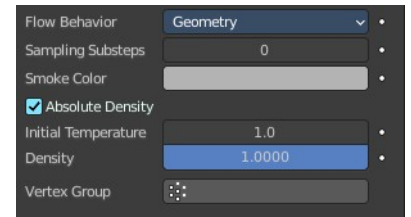

Sampling Substeps

Number of sub-steps used to reduce gaps in emission of fluid from fast-moving sources.

Smoke Color

The color of emitted smoke. When smoke of different colors are mixed they will blend together, eventually settling into a new combined color.

Absolute Density

If this checkbox is enabled, the emitter will only produce more smoke or fire if there is space for it in the emitter region. Otherwise smoke or fire will always be produced and add up.

Initial Temperature

Difference between the temperature of emitted smoke and the domain's ambient temperature. This setting's effect on smoke depends on the domain's Heat Buoyancy.

Density

Amount of smoke to emit at once. Larger values result in more density being produced.

Fuel

Amount of "fuel" being burned per second. Larger values result in larger flames, smaller values result in smaller flames.

Vertex Group

When set, use the specified Vertex Group to control where smoke is emitted.

Flow - Settings subpanel - Flow Type Fire

Emit only fire. Note that the domain will automatically create some smoke to simulate smoke left by burnt fuel.

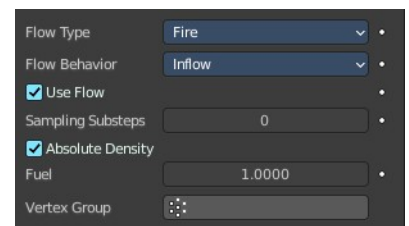

Flow Behavior

Controls if the Flow object either adds (Inflow), removes (Outflow), or turns the mesh itself into fluid (Geometry).

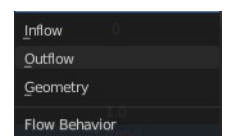

Inflow

This object will emit fluid into the simulation, like a water tap or base of a fire.

Use Flow

Enables or disables the flow of fluid, this property is useful for animations to selectively enable and disable when fluid is being added to or removed from the domain.

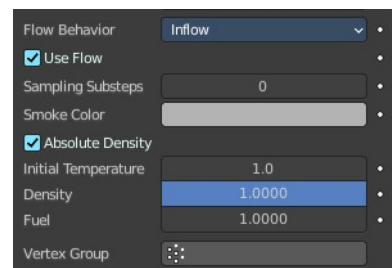

Sampling Substeps

Number of sub-steps used to reduce gaps in emission of fluid from fast-moving sources.

Smoke Color

The color of emitted smoke. When smoke of different colors are mixed they will blend together, eventually settling into a new combined color.

Absolute Density

If this checkbox is enabled, the emitter will only produce more smoke or fire if there is space for it in the emitter region. Otherwise smoke or fire will always be produced and add up.

Initial Temperature

Difference between the temperature of emitted smoke and the domain's ambient temperature. This setting's effect on smoke depends on the domain's Heat Buoyancy.

Density

Amount of smoke to emit at once. Larger values result in more density being produced.

Fuel

Amount of "fuel" being burned per second. Larger values result in larger flames, smaller values result in smaller flames.

Vertex Group

When set, use the specified Vertex Group to control where smoke is emitted.

Outflow

Any fluid that enters the bounding box of this object will be removed from the domain (think of a drain or a black hole). This can be useful in combination with an inflow to prevent the whole domain from filling up. Outflow objects can be animated and the area where the fluid disappears will follow the object as it moves around.

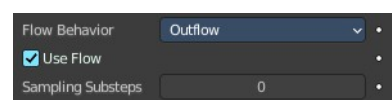

Use Flow

Enables or disables the flow of fluid, this property is useful for animations to selectively enable and disable when fluid is being added to or removed from the domain.

Sampling Substeps

Number of sub-steps used to reduce gaps in emission of fluid from fast-moving sources.

Geometry

All regions of this object that are inside the domain bounding box will be used as actual fluid in the simulation. You can place more than one fluid object inside the domain. Also make sure that the surface normals are pointing outwards or else they will not simulate properly. In contrast to domain objects, the actual mesh geometry is used for fluid objects.

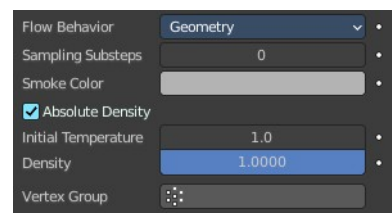

Sampling Substeps

Number of sub-steps used to reduce gaps in emission of fluid from fast-moving sources.

Smoke Color

The color of emitted smoke. When smoke of different colors are mixed they will blend together, eventually settling into a new combined color.

Absolute Density

If this checkbox is enabled, the emitter will only produce more smoke or fire if there is space for it in the emitter region. Otherwise smoke or fire will always be produced and add up.

Initial Temperature

Difference between the temperature of emitted smoke and the domain's ambient temperature. This setting's effect on smoke depends on the domain's Heat Buoyancy.

Density

Amount of smoke to emit at once. Larger values result in more density being produced.

Fuel

Amount of "fuel" being burned per second. Larger values result in larger flames, smaller values result in smaller flames.

Vertex Group

When set, use the specified Vertex Group to control where smoke is emitted.

Flow - Settings subpanel - Flow Type Liquid

Emit liquid.



Flow Behavior

Controls if the Flow object either adds (Inflow), removes (Outflow), or turns the mesh itself into fluid (Geometry).

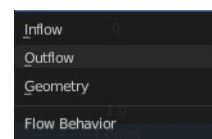

Inflow

This object will emit fluid into the simulation, like a water tap or base of a fire.



Use Flow

Enables or disables the flow of fluid, this property is useful for animations to selectively enable and disable when fluid is being added to or removed from the domain.

Sampling Substeps

Number of sub-steps used to reduce gaps in emission of fluid from fast-moving sources.

Outflow

Any fluid that enters the bounding box of this object will be removed from the domain (think of a drain or a black hole). This can be useful in combination with an inflow to prevent the whole domain from filling up.

Outflow objects can be animated and the area where the fluid disappears will follow the object as it moves around.

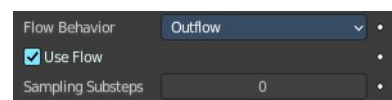

Use Flow

Enables or disables the flow of fluid, this property is useful for animations to selectively enable and disable when fluid is being added to or removed from the domain.

Sampling Substeps

Number of sub-steps used to reduce gaps in emission of fluid from fast-moving sources.

Geometry

All regions of this object that are inside the domain bounding box will be used as actual fluid in the simulation. You can place more than one fluid object inside the domain. Also make sure that the surface normals are pointing outwards or else they will not simulate properly. In contrast to domain objects, the actual mesh geometry is used for fluid objects.

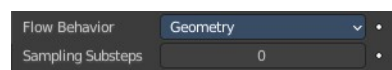

Sampling Substeps

Number of sub-steps used to reduce gaps in emission of fluid from fast-moving sources.

Flow - Settings subpanel - Flow Source

This setting defines the method used to emit fluid.

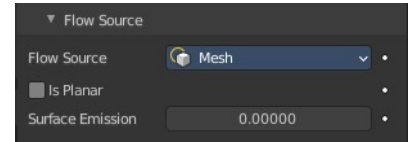

Flow Source

How fluid is emitted. By a mesh or a particle system. Flow Type Fluid does just show the option mesh.



Mesh

Emit fluid directly from the object's mesh.

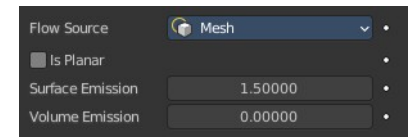

Is Planar

Defines the effector as either a single dimension object i.e. a plane or the mesh is non-manifold. This ensures that the fluid simulator will give the most accurate results for these types of meshes.

Surface Emission

Maximum distance in voxels from the surface of the mesh in which fluid is emitted. Since this setting uses voxels to determine the distance, results will vary depending on the domain's resolution.

Volume Emission

Fire or Smoke Only. Amount of fluid to emit inside the emitter mesh, where 0 is none and 1 is the full amount. Note that emitting fluid based on volume can have unpredictable results if your mesh is non-manifold.

Particle System

Not for Flow Type Fluid. Create smoke or fire from a particle system on the flow object. which can be select with a Data ID.

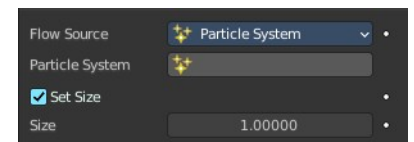

Note that only Emitter type particle systems can add smoke. See Particles for information on how to create a particle system.

Particle System

Pick the particle system to use. It must be at the same mesh.

Set Size

Define the maximum distance in voxels at which particles can emit smoke, similar to the Surface Emission setting for mesh sources.

When disabled, particles will fill the nearest voxel with smoke.

Size

Particle size in simulation cells.

Flow - Settings subpanel - Initial Velocity

Note that with Flow Source Type Particles just the Source slider is showing.

Source

Factor for the inherited velocity. A value of 1 will emit fluid moving at the same speed as the source.

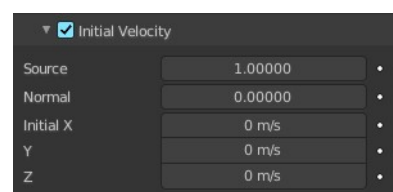

Normal

This option controls how much velocity fluid is given along a face normal. Note that, initial velocities will always be applied along all face normals. Thus with a closed flow source mesh, fluid will always be emitted in more than one direction. To set initial velocities along only one direction all normals need to point in the same direction. This is can be achieved when using a plane as the flow object.

Initial X, Y, Z

Initial velocity along X, Y, Z coordinates in world space. This can be used in addition to the initial velocity along the Normal.

Flow - Settings subpanel - Texture

Use a specified texture and settings to control where on the mesh smoke or fire can be emitted from. These settings have no effect on Outflow Flow Behavior.

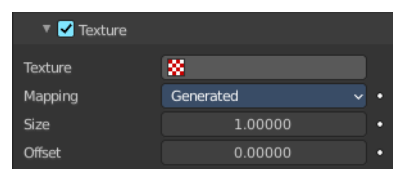

Texture

Choose the Texture. It must be created in the textures tab first.

Mapping

Controls whether to use Generated UV's or manual UV mapping.

Generated

Generated UV coordinates centered to flow object.

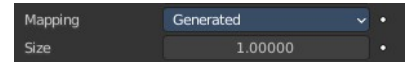

Size

Overall texture scale.

UV

Use an UV map of the flow object.

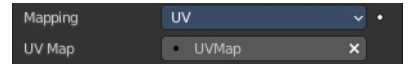

UV Map

Choose the UV map.

Offset

Translates the texture along the Z axis.

Effector - Settings Subpanel

Effector objects are used to deflect fluids and influence the fluid flow. They can act as colliders or guides.

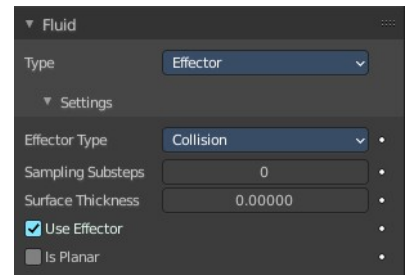

Effector Type

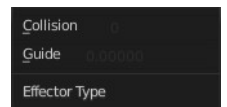

Collision

Objects of this type will collide with fluid.

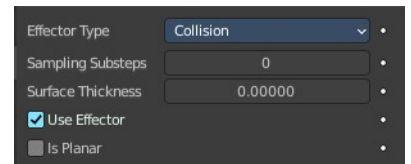

Guide

The velocity of objects of this type will be used when baking the guiding. So fluid guiding objects should move and have some velocity.

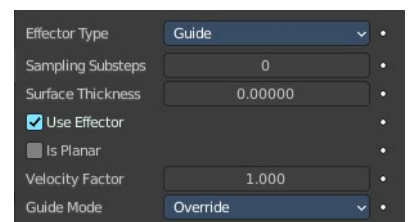

Sampling Substeps

Number of substeps used to reduce gaps in collision of fluid from fast-moving effectors.

Surface Thickness

Additional area around the effector that will be considered as an effector.

Use Effector

Enables or disables the effector object effect on the fluid, this property is useful for animations to selectively enable and disable when the effector affects the fluid.

Is Planar

Defines the effector as either a single dimension object i.e. a plane or the mesh is non-manifold. This ensures that the fluid simulator will give the most accurate results for these types of meshes.

A manifold mesh can also be declared as planar. The fluid solver will then ignore the volume inside the mesh and just emit fluid from the mesh sides.

Velocity Factor

Effector type Guide only. Multiply the guiding object velocities by this factor. This is useful when working with multiple guiding objects and some of them should have higher or smaller velocities.

Guide Mode

Effector type Guide only. The mode describes how guiding velocities should be written into the global guiding velocity field of the domain.

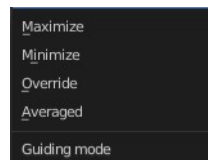

Maximize

The guiding object will compare the existing velocity in the global velocity field with its own velocity. If its absolute value is greater than the absolute value in the velocity field the guiding velocity will be kept.

Minimize

A guiding object will compare the existing velocity in the global velocity field with its own velocity. If its absolute value is smaller than the absolute value in the velocity field the guiding velocity will be kept.

Override

The most intuitive option. A guiding object will always write its own current velocity into the global guiding velocity field. Values in the velocity field from a previous frame or guiding object will be overridden.

Averaged

A guiding object will write the average of its own current velocity and the existing guiding velocity at that cell into the global guiding velocity field.



26.12.7 Editors - Properties Editor - Physics Properties Tab - Rigid Body panel

Table of content

Rigid Body.....	2
Tips.....	2
Animation.....	2
Simulation Stability.....	3
Combining Rigid Bodies with Other Simulations.....	3
Scaling Rigid Bodies.....	3
Rigid Body Panel.....	3
Type.....	3
Active.....	3
Passive.....	4
Settings subpanel.....	4
Type Active.....	4
Type Passive.....	4
Mass.....	4
Dynamic.....	4
Animated.....	4
Collisions subpanel.....	4
Shape.....	4
Box, Sphere, Capsule, Cylinder, Cone.....	4
Convex Hull.....	5
Source.....	5
Base.....	5
Deform.....	5
Final.....	5
Mesh.....	5
Source.....	5
Base.....	5
Deform.....	5
Final.....	5
Deforming.....	5
Compound Parent.....	5
Surface Response subpanel.....	5
Friction.....	5
Bounciness.....	6
Sensitivity subpanel.....	6
Collision Margin.....	6
Margin.....	6
Collections subpanel.....	6
Dynamics subpanel.....	6
Damping Translation.....	6
Rotation.....	6
Deactivation subpanel.....	7
Start Deactivated.....	7
Velocity Linear.....	7
Angular.....	7

Rigid Body

The rigid body simulation can be used to simulate the motion of solid objects. It affects the position and orientation of objects and does not deform them.

Unlike the other simulations, the rigid body sim works closer with the animation system. This means that rigid bodies can be used like regular objects and be part of parent-child relationships, animation constraints and drivers.

Rigid body physics requires a mesh object.

There are two types of rigid body: active and passive. Both types can be driven by the animation system.

Active bodies are dynamically simulated, while passive bodies remain static. It is in this regards similar to the collision physics.

The scale of the rigid body object also influences the simulation, but is always controlled by the animation system.

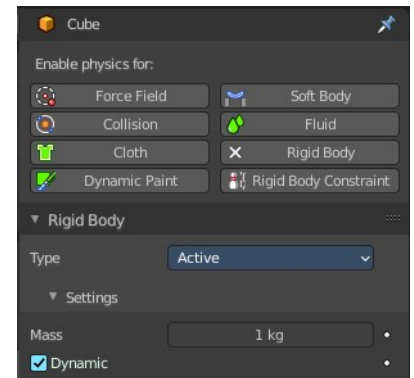

Tips

As with all physics-enabled objects, pay close attention to the Animated check box in the Rigid Body panel of the Physics context in the Properties window. A common mistake is to use keyframe animation on a Passive physics object without checking the Animated box. The object will move, but the physics engine will behave as if the Passive is still in its starting place, leading to disappointment.

Animation

The most common trick is to keyframe animate the location or rotation of an Active physics object as well as the Animated checkbox. When the curve on the Animated property switches to disabled, the physics engine takes over using the object's last known location, rotation and velocities.

Animating the strengths of various other parameters (a Motor's Target Velocity, a Hinge's limits, etc) can be used to accomplish a wide variety of interesting results.

Enabling a constraint during the physics simulation often has dramatic results as the physics engine tries to bring into alignment two objects which are often dramatically out of alignment. It is very common for the affected objects to build up enough kinetic energy to bounce themselves out of camera (and into orbit, although the physics engine is not yet capable of simulating a planet's gravity well, so scratch that).

Rigid Body dynamics can be baking to normal keyframes with Bake To Keyframes button in the Physics tab of the Tool Shelf.

Simulation Stability

The simplest way of improving simulation stability is to increase the steps per second. However, care has to be taken since making too many steps can cause problems and make the simulation even less stable (if you need more than 1000 steps, you should look at other ways to improve stability).

Increasing the number of solver iterations helps making constraints stronger and also improves object stacking stability.

It's best to avoid small objects, as they're currently unstable. Ideally, objects should be at least 20 cm in diameter. If it's still necessary, setting the collision margin to 0, while generally not recommended, can help making small object behave more naturally.

When objects are small and/or move very fast, they can pass through each other. Besides what's mentioned above it's also good to avoid using mesh shapes in this case. Mesh shapes consist of individual triangles and therefore don't really have any thickness, so objects can pass through more easily. You can give them some thickness by increasing the collision margin.

Combining Rigid Bodies with Other Simulations

Since the rigid body simulation is part of the animation system, it can influence other simulations just like the animation system can.

In order for this to work, the rigid body object needs to have a collision modifier. Simply click on Collision in the Physics context.

Scaling Rigid Bodies

Rigid body objects can be scaled, also during the simulation. This work well in most cases, but can sometimes cause problems.

If dynamic scaling is not needed, rigid body objects should have the scale applied by using the Apply Scale command

Rigid Body Panel

Type

Role of the rigid body in the simulation. Active objects can be simulated dynamically, passive object remain static.

Active

Object is directly controlled by simulation results. The possibility to select this type also available with Add Active button in the Physics tab of the Tool Shelf.

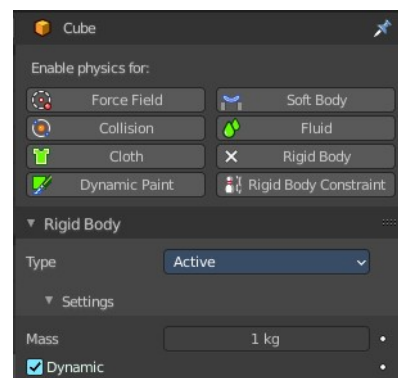

Passive

Object is directly controlled by animation system. Thus, this type is not available for Rigid Body Dynamics. The possibility to select this type also available with Add Passive button in the Physics tab of the Tool Shelf.

Settings subpanel

Type Active

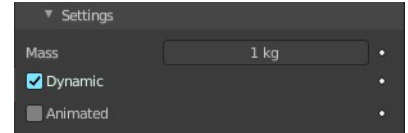

Type Passive



The passive type does not have a mass or dynamic checkbox.

Mass

Specifies how heavy the object is and “weights” irrespective of gravity. There are predefined mass preset available with the Calculate Mass button in the Physics tab of the Toolbar.

Dynamic

Enables/disables rigid body simulation for object.

Animated

Allows the rigid body additionally to be controlled by the animation system.

Collisions subpanel

Settings around the collision behavior.

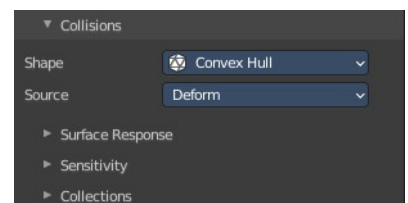

Shape

The shape of the collider mesh.

Box, Sphere, Capsule, Cylinder, Cone

Use this primitive shapes as a collider.

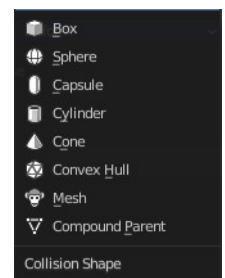

Convex Hull

Creates a convex hull around the rigid body mesh. Concave gaps gets closed.

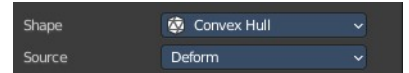

Source

What shape to use for the calculation of the convex hull.



Base

The base mesh of the object.

Deform

Includes any deformations added to the mesh (shape keys, deform modifiers). Mesh shapes can deform during simulation.

Final

Includes all deformations and modifiers.

Mesh

Uses the mesh of the rigid body for collision calculation.

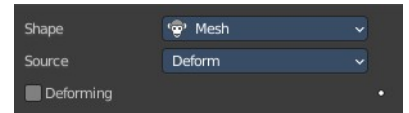

Source

What shape to use for the calculation of the convex hull.

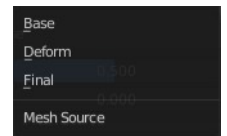

Base

The base mesh of the object.

Deform

Includes any deformations added to the mesh (shape keys, deform modifiers). Mesh shapes can deform during simulation.

Final

Includes all deformations and modifiers.

Deforming

Mesh shapes can deform during simulation.

Compound Parent

Combines all rigid bodies of child objects into one rigid body.

You need to have at least one child object with a rigid body attached.

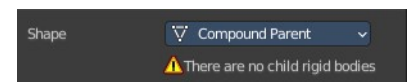

Surface Response subpanel

Friction

Resistance of object to movement. Specifies how much velocity is lost when

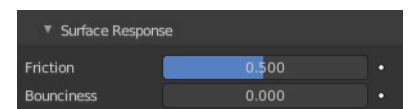

objects collide with each other.

Bounciness

Tendency of object to bounce after colliding with another (0 to 1) (rigid to perfectly elastic). Specifies how much objects can bounce after collisions.

Sensitivity subpanel

Collision Margin

Use custom collision marging.



The collision margin is used to improve the performance and stability of rigid bodies. Depending on the shape, it behaves differently: some shapes embed it, while others have a visible gap around them.

The margin is embedded for the following shapes. Sphere, Box, Capsule, Cylinder. The margin is not embedded for the Cone and mesh object.

Convex Hull only allows for uniform scale when embedded.

Margin

Threshold of distance near surface where collisions are still considered (best results when non-zero).

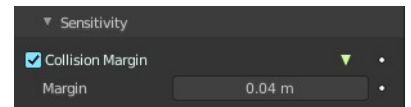

Collections subpanel

Allows rigid body collisions allocate on different groups (maximum 20). Just the rigid bodies at the same group will collide with each other.



Holding down shift allows to add the rigid body to more than one group.

Dynamics subpanel

Rigid body type Active only. Dynamics is used to control the physics of the rigid body simulation.

Damping Translation

Amount of linear velocity that is lost over time.

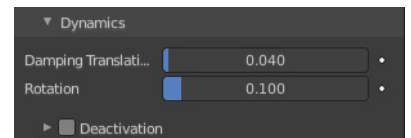

Rotation

Amount of angular velocity that is lost over time.

Deactivation subpanel

Allows resting rigid bodies to become deactivated.

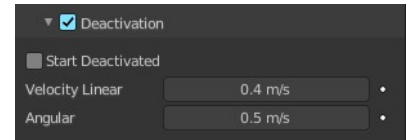

Start Deactivated

Starts objects deactivated. They are activated on collision with other objects.

Velocity Linear

Specifies the linear deactivation velocity below which the rigid body is deactivated and simulation stops simulating object.

Angular

Specifies the angular deactivation velocity below which the rigid body is deactivated and simulation stops simulating object.

26.12.8 Editors - Properties Editor - Physics Properties Tab - Rigid Body Constraint panel

Table of content

Rigid Body Constraints.....	2
Workflow.....	2
Connect rigid bodies.....	3
Tips.....	3
Animation.....	3
Simulation Stability.....	4
Combining Rigid Bodies with Other Simulations.....	4
Scaling Rigid Bodies.....	4
Rigid Body Constraint panel.....	4
Type.....	4
Fixed.....	4
Point.....	5
Hinge.....	5
Slider.....	5
Piston.....	5
Generic.....	5
Generic Spring.....	5
Motor.....	6
Rigid Body Constraint panel - Settings subpanel.....	6
Enabled.....	6
Disable Collisions.....	6
Breakable.....	6
Threshold.....	6
Rigid Body Constraint panel - Limits subpanel.....	6
Hinge.....	6
Angular.....	6
Z Angle.....	6
Slider.....	7
Linear.....	7
X Axis.....	7
X Lower.....	7
Upper.....	7
Piston.....	7
Angular.....	7
X Angle.....	7
X Lower.....	7
Upper.....	7
Linear.....	7
X Axis.....	7
X Lower.....	7
Upper.....	7
Generic + Generic Spring.....	7
Angular.....	7
X Axis/Y Axis/Z axis.....	7
Lower.....	8

Upper.....	8
Linear.....	8
X Angle/Y Angle/Z Angle.....	8
Lower.....	8
Upper.....	8
Rigid Body Constraint panel - Motor subpanel.....	8
Angular.....	8
Target Velocity.....	8
Max Impulse.....	8
Linear.....	8
Max Impulse.....	8
Rigid Body Constraint panel - Objects subpanel.....	8
Rigid Body Constraint panel - Override Iterations subpanel.....	9
Iterations.....	9
Rigid Body Constraint panel - Springs subpanel.....	9
Generic Spring.....	9
Type.....	9
Angular.....	9
X/Y/Z Axis.....	9
Stiffness.....	9
Damping.....	9
Linear.....	9
X/Y/Z Angle.....	9
Stiffness.....	9
Damping.....	9

Rigid Body Constraints

Rigid body constraints connects two rigid bodies with each other. A use case is for example to animate a chain.

Note! You need a rigid body world in the scene. This is usually created automatically in the moment when you add a rigid body.

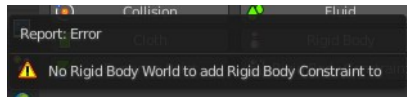

But when you create a primitive and try to add a rigid body constraint in a new scene then you will get a warning about the missing rigid body world.

Create a rigid body first before you create a rigid body constraint.

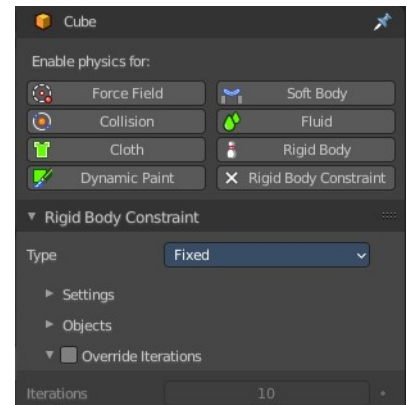

Workflow

Create two objects with active rigid bodies.

Create a plane with a passive rigid body. This will be our ground.

Play the animation. The cubes will fall down independent from each other.

Now create an Empty.

You can also use one of the cubes to add the constraint. Then this cube becomes the center of the constraint.

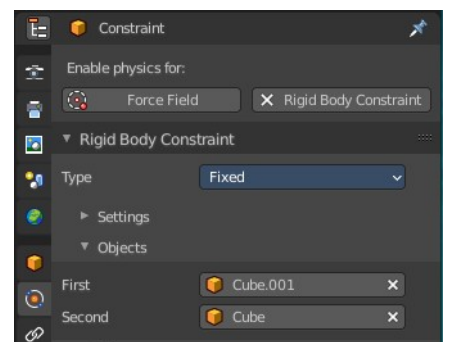

Add a Rigid body constraint to it. And add both objects in the Object subpanel. The order does not matter in this example.

When you play the animation, then the objects will not fall independent anymore. But as one object.

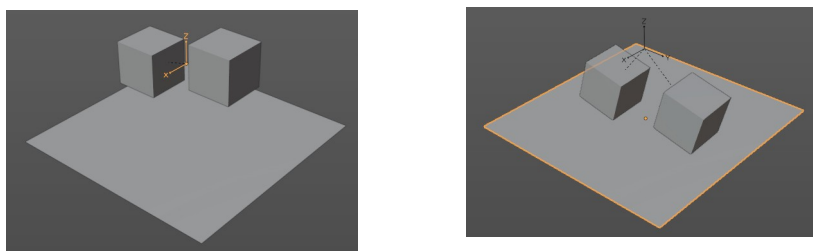

Play around with the different constraint types.

Connect rigid bodies

The normal way goes across the Objects sub tab in the Constraint panel by adding the two objects that you want to connect. But there is a quick way to connect two rigid bodies with a constraint in the 3D view in the Object menu.

Select the first rigid body object, hold down shift, select the second rigid body object. So that both are selected. In the Object menu choose the Rigid Body menu, and here Connect at the end of the menu.

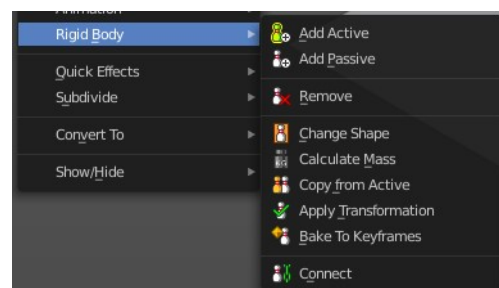

Tips

As with all physics-enabled objects, pay close attention to the Animated checkbox in the Rigid Body panel of the Physics tab in the Properties editor. A common mistake is to use keyframe animation on a Passive physics object without checking the Animated box. The object will move, but the physics engine will behave as if the Passive is still in its starting place, leading to disappointment.

Animation

The most common trick is to keyframe animate the location or rotation of an Active physics object as well as the Animated checkbox. When the curve on the Animated property switches to disabled, the physics engine takes over using the object's last known location, rotation and velocities.

Animating the strengths of various other parameters (a Motor's Target Velocity, a Hinge's limits, etc.) can be used to accomplish a wide variety of interesting results.

Enabling a constraint during the physics simulation often has dramatic results as the physics engine tries to bring into alignment two objects which are often dramatically out of alignment. It is very common for the affected objects to build up enough kinetic energy to bounce themselves out of camera (and into orbit, although the physics engine is not yet capable of simulating a planet's gravity well, so scratch that).

Rigid body dynamics can be baking to normal keyframes with Bake To Keyframes button in the Physics tab of

the Toolbar.

Simulation Stability

The simplest way of improving simulation stability is to increase the steps per second. However, care has to be taken since making too many steps can cause problems and make the simulation even less stable (if you need more than 1000 steps, you should look at other ways to improve stability).

Increasing the number of solver iterations helps making constraints stronger and also improves object stacking stability.

It is best to avoid small objects, as they are currently unstable. Ideally, objects should be at least 20 cm in diameter. If it is still necessary, setting the collision margin to 0, while generally not recommended, can help making small object behave more naturally.

When objects are small and/or move very fast, they can pass through each other. Besides what is mentioned above it's also good to avoid using mesh shapes in this case. Mesh shapes consist of individual triangles and therefore do not really have any thickness, so objects can pass through more easily. You can give them some thickness by increasing the collision margin.

Combining Rigid Bodies with Other Simulations

Since the rigid body simulation is part of the animation system, it can influence other simulations just like the animation system can.

In order for this to work, the rigid body object needs to have a Collision Modifier. Simply click on Collision in the Physics tab.

Scaling Rigid Bodies

Rigid body objects can be scaled, also during the simulation. This work well in most cases, but can sometimes cause problems.

If dynamic scaling is not needed, rigid body objects should have the scale applied.

Rigid Body Constraint panel

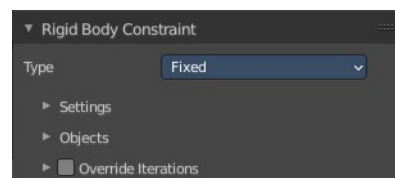

Type

The type of the constraint. Each type has some different settings.

Fixed

This constraint cause the two involved objects to move as one. Since the physics system

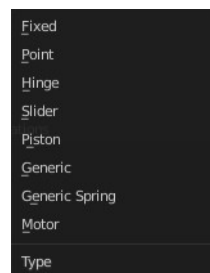

does have a tiny bit of slop in it, the objects do not move as rigidly as they would if they were part of the same mesh.

Point

The objects are linked by a point bearing allowing any kind of rotation around the location of the constraint object, but no relative translation is permitted. The physics engine will do its best to make sure that the two points designated by the constraint object on the two constrained objects are coincident.

Hinge

The hinge permits one degree of freedom between two objects. Translation is completely constrained. Rotation is permitted about the Z axis of the object hosting the Physics constraint (usually an empty, distinct from the two objects that are being linked). Adjusting the position and rotation of the object hosting the constraint allows you to control the anchor and axis of the hinge.

The Hinge is the only single-axis rotational constraint that uses the Z axis instead of the X axis. If something is wrong with your hinge, check your other constraints to see if this might be the problem.

Slider

The Slider constraint allows relative translation along the X axis of the constraint object, but permits no relative rotation, or relative translation along other axes.

Piston

A piston constraint permits translation along the X axis of the constraint object. It also allows rotation around the X axis of the constraint object. It is like a combination of the freedoms of a slider with the freedoms of a hinge.

Generic

The X, Y, and Z axis constraints can be used to limit the amount of translation between the objects. Clamping the min/max to zero has the same effect as the Point constraint.

Clamping the relative rotation to zero keeps the objects in alignment. Combining an absolute rotation and translation clamp would behave much like the Fixed constraint.

Using a non-zero spread on any parameter allows it to rattle around in that range throughout the course of the simulation.

Generic Spring

The generic spring constraint adds some spring parameters for the X/Y/Z axes to all the options available on the Generic constraint. Using the spring alone allows the objects to bounce around as if attached with a spring anchored at the constraint object. This is usually a little too much freedom, so most applications will benefit from enabling translation or rotation constraints.

If the damping on the springs is set to 1, then the spring forces are prevented from realigning the anchor points, leading to strange behavior. If your springs are acting weird, check the damping.

Motor

The motor constraint causes translation and/or rotation between two entities. It can drive two objects apart or together. It can drive simple rotation, or rotation and translation (although it will not be constrained like a screw since the translation can be blocked by other physics without preventing rotation).

The rotation axis is the X axis of the object hosting the constraint. This is in contrast with the Hinge which uses the Z axis. Since the Motor is vulnerable to confusing perturbations without a matching Hinge constraint, special care must be taken to align the axes. Without proper alignment, the motor will appear to have no effect (because the hinge is preventing the motion of the motor).

Rigid Body Constraint panel - Settings subpanel

Enabled

Specifies whether the constraint is active during the simulation.

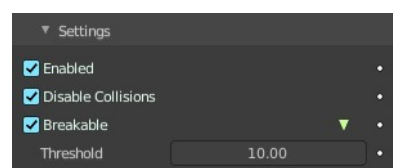

Disable Collisions

Allows constrained objects to pass through one another.

Breakable

Allows constraint to break during simulation. Disabled for the Motor constraint. This can be used to simulate destruction.

Threshold

Impulse strength that needs to be reached before constraint breaks.

Rigid Body Constraint panel - Limits subpanel

Hinge

Angular

Z Angle

Limit rotation around Z axis.

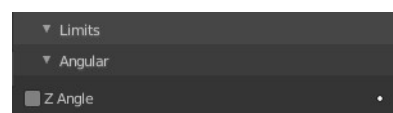

Slider

Linear

X Axis

Enables/disables limit translation around X axis.

X Lower

Lower limit of X axis translation.

Upper

Upper limit of X axis translation.

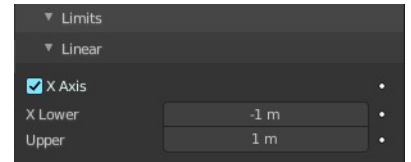

Piston

Angular

X Angle

Enables/disables limit rotation around X axis.

X Lower

Lower limit of X axis rotation.

Upper

Upper limit of X axis rotation.

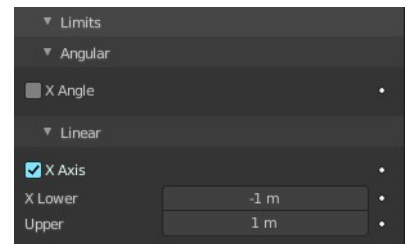

Linear

X Axis

Enables/disables limit translation around X axis.

X Lower

Lower limit of X axis translation.

Upper

Upper limit of X axis translation.

Generic + Generic Spring

Angular

X Axis/Y Axis/Z axis

Enables/disables limit translation on X, Y or Z axis respectively.

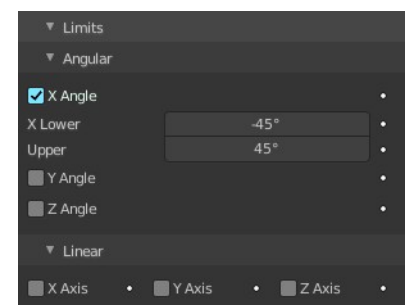

Lower

Lower limit of translation for X, Y or Z axis respectively.

Upper

Upper limit of translation for X, Y or Z axis respectively.

Linear

X Angle/Y Angle/Z Angle

Enables/disables limit rotation around X, Y or Z axis respectively.

Lower

Lower limit of rotation for X, Y or Z axis respectively.

Upper

Upper limit of rotation for X, Y or Z axis respectively.

Rigid Body Constraint panel - Motor subpanel

Angular

Target Velocity

Target angular motor velocity.

Max Impulse

Maximum angular motor impulse.

Linear

Target Velocity

Target linear motor velocity.

Max Impulse

Maximum linear motor impulse.

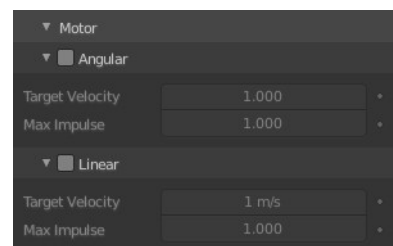

Rigid Body Constraint panel - Objects subpanel

Pick the two objects that you want to constraint together.



Rigid Body Constraint panel - Override Iterations subpanel

Override the default number of iterations. Allows to make constraints stronger (more iterations) or weaker (less iterations) than specified in the rigid body world.

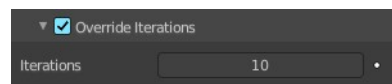

Iterations

Number of constraint solver iterations made per simulation step for this constraint.

Rigid Body Constraint panel - Springs subpanel

Generic Spring

The type generic spring allows you to limit the springs.

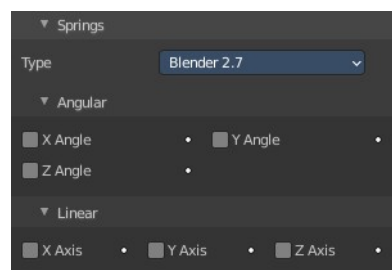

Type

Which type of implementation to use.

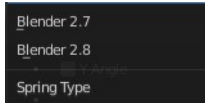

Angular

X/Y/Z Axis

Enables/disables springs translation on X, Y or Z axis respectively.

Stiffness

Spring Stiffness of the translation on X, Y or Z axis respectively. Specifies how “bendy” the spring is.

Damping

Spring Damping of the translation on X, Y or Z axis respectively. Amount of damping the spring has.

Linear

X/Y/Z Angle

Enables/disables springs rotation around the X, Y or Z axis respectively.

Stiffness

Spring Stiffness of the rotation around the X, Y or Z axis respectively. Specifies how “bendy” the spring is.

Damping

Spring Damping of the rotation around the X, Y or Z axis respectively. Amount of damping the spring has.



26.13 Editors - Properties Editor - Object Constraints Properties Tab

Table of content

Detailed Table of content.....	2
Object Constraints.....	7
General functionality.....	8
Add.....	8
Enable / Disable.....	8
Apply.....	8
Dropdown menu.....	9
Remove.....	9
Collapse panel.....	9
Reorder.....	9
Animate Property.....	9
Object specific constraints.....	9
Motion Tracking Constraints.....	10
Camera Solver.....	10
Follow Track.....	10
Object Solver.....	11
Transform Constraints.....	12
Copy Location.....	12
Copy Rotation.....	13
Copy Scale.....	14
Copy Transforms.....	15
Limit Distance.....	16
Limit Location.....	17
Limit Rotation.....	18
Order.....	18
Limit Scale.....	18
Maintain Volume.....	19
Volume.....	19
Transformation.....	19
Transform cache.....	22
Tracking Constraints.....	24
Clamp To.....	24
Damped Track.....	25
Locked Track.....	25
Stretch To.....	26
Track To.....	27
Relationship Constraints.....	28
Action.....	28
Example:.....	28
Armature.....	31
Child Of.....	32
Floor.....	33
Follow Path.....	34
Shrinkwrap.....	36

Detailed Table of content

3.8.7- Editors - Properties Editor - Object Constraints Tab

Detailed Table of content.....	2
Object Constraints.....	7
General functionality.....	8
Add.....	8
Enable / Disable.....	8
Apply.....	8
Dropdown menu.....	9
Apply.....	9
Duplicate.....	9
Copy to Selected.....	9
Move to First.....	9
Move to Last.....	9
Remove.....	9
Collapse panel.....	9
Reorder.....	9
Animate Property.....	9
Object specific constraints.....	9
Motion Tracking Constraints.....	10
Camera Solver.....	10
Active Clip.....	10
Constraint to F-Curve.....	10
Influence.....	10
Follow Track.....	10
Active Clip.....	10
3D Position.....	11
Undistorted.....	11
Frame Method.....	11
Camera.....	11
Depth Object.....	11
Constraint to F-Curve.....	11
Influence.....	11
Object Solver.....	11
Active Clip.....	11
Camera.....	11
Set Inverse / Clear Inverse.....	12
Constraint to F-Curve.....	12
Influence.....	12
Transform Constraints.....	12
Copy Location.....	12
Target.....	12
Bone.....	13
Head/Tail.....	13
Vertex Group.....	13
X, Y, Z.....	13
Invert.....	13
Offset.....	13
Target Space for Target and Owner.....	13
Influence.....	13

Copy Rotation.....	13
Target.....	13
Vertex Group.....	13
Bone.....	14
X, Y, Z.....	14
Invert.....	14
Offset.....	14
Target Space for Target and Owner.....	14
Influence.....	14
Copy Scale.....	14
Target.....	14
Vertex Group.....	14
Bone.....	14
X, Y, Z.....	15
Offset.....	15
Additive.....	15
Target Space for Target and Owner.....	15
Influence.....	15
Copy Transforms.....	15
Target.....	15
Vertex Group.....	15
Bone.....	15
Head/Tail.....	15
Remove Target Shear.....	16
Mix.....	16
Target Space for Target and Owner.....	16
Influence.....	16
Limit Distance.....	16
Target.....	16
Vertex Group.....	16
Bone.....	16
Head/Tail.....	16
Distance.....	16
Reset Distance.....	17
Clamp Region.....	17
Inside.....	17
Outside.....	17
Surface.....	17
Target Space for Target and Owner.....	17
Influence.....	17
Limit Location.....	17
Minimum X Y Z.....	17
Maximum X Y Z.....	17
For Transform.....	18
Convert.....	18
Influence.....	18
Limit Rotation.....	18
Limit X Y Z.....	18
Order.....	18
Affect Transform.....	18
Owner Space.....	18
Influence.....	18
Limit Scale.....	18

Minimum X Y Z.....	19
Maximum X Y Z.....	19
For Transform.....	19
Convert.....	19
Influence.....	19
Maintain Volume.....	19
Free X / Y / Z.....	19
Volume.....	19
Owner Space.....	19
Influence.....	19
Transformation.....	19
Target.....	20
Vertex Group.....	20
Bone.....	20
Extrapolate.....	20
Target Space.....	20
Owner Space.....	21
Influence.....	21
Map From subpanel.....	21
Location Rotation Scale.....	21
X Y Z.....	21
Map To subpanel.....	21
Location Rotation Scale.....	21
X Source Axis.....	21
Min Max.....	21
Y Source Axis.....	21
Min Max.....	21
Z Source Axis.....	21
Min Max.....	21
Mix.....	22
Transform cache.....	22
Cache File property.....	22
Dara Browser.....	22
Edit Box.....	22
Fake User.....	22
Open Cache File.....	22
Remove.....	22
File Path.....	22
Sequence.....	23
Refresh Active.....	23
Object Path.....	23
Influence.....	23
Time Subpanel.....	23
Sequence.....	23
Override Frame.....	23
Frame.....	23
Frame Offset.....	23
Render Procedural subpanel.....	23
Use Render Engine Procedural.....	23
Use Prefetch.....	23
Prefetch Cache Size.....	24
Velocity subpanel.....	24
Velocity Attribute.....	24

Velocity Unit.....	24
Tracking Constraints.....	24
Clamp To.....	24
Target.....	24
Main Axis.....	24
Cyclic.....	24
Influence.....	24
Damped Track.....	25
Target.....	25
Vertex Group.....	25
Bone.....	25
Head/Tail.....	25
To.....	25
Influence.....	25
Locked Track.....	25
Target.....	25
Vertex Group.....	25
Bone.....	26
Head/Tail.....	26
To.....	26
Lock.....	26
Influence.....	26
Stretch To.....	26
Target.....	26
Vertex Group.....	26
Bone.....	26
Head/Tail.....	26
Rest Length.....	26
Reset.....	27
Volume Min / Volume Max.....	27
Smooth.....	27
Volume.....	27
Plane.....	27
Influence.....	27
Track To.....	27
Target.....	27
Vertex Group.....	27
Bone.....	27
Head/Tail.....	27
To.....	28
Up.....	28
Target Z.....	28
Target Space for Target and Owner.....	28
Influence.....	28
Relationship Constraints.....	28
Action.....	28
Example:.....	28
Target.....	29
Vertex Group.....	29
Bone.....	29
Evaluation Time.....	29
Influence.....	29
Target subpanel.....	29

Channel.....	29
Target Space.....	29
Target Range Min / Max.....	30
Action subpanel.....	30
Action.....	30
Object Action.....	30
<i>Frame Start / End</i>	30
Notes.....	30
Armature.....	31
Preserve Volume.....	31
Use Envelopes.....	31
Add Target Bone.....	31
Normalize Weights.....	31
Influence.....	31
Bones subpanel.....	32
First Edit Box.....	32
Second Edit Box.....	32
Remove Target.....	32
Blend Weight.....	32
Child Of.....	32
Target.....	32
Vertex Group.....	32
Bone.....	32
Location, Rotation, Scale.....	32
Set Inverse / Clear Inverse.....	32
Influence.....	33
Floor.....	33
Target.....	33
Vertex Group.....	33
Bone.....	33
Sticky.....	33
Use Rotation.....	33
Offset.....	33
Min / Max.....	33
Target Space for Target and Owner.....	34
Influence.....	34
Follow Path.....	34
Target.....	34
Offset.....	34
Forward Axis.....	34
Up Axis.....	34
Fixed position.....	34
Curve Radius.....	35
Follow Curve.....	35
Forward.....	35
Up.....	35
Animate Path.....	35
Pivot.....	35
Target.....	35
Vertex Group.....	35
Bone.....	35
Head/Tail.....	35
Use Relative Offset.....	35

Pivot Offset X / Y / Z.....	36
Rotation Range.....	36
Influence.....	36
Shrinkwrap.....	36
Distance.....	36
Shrinkwrap Mode.....	36
Target Normal Project.....	36
Nearest Vertex.....	36
Project.....	37
Project Axis.....	37
Space.....	37
Distance.....	37
Project Opposite.....	37
Face Cull.....	37
Invert Cull.....	37
Nearest Surface Point.....	37
Snap Mode.....	37
Align to Normal.....	37
Influence.....	38

Object Constraints

Object Constraints allows two objects to interact with each other. You can for example set the x position to the x position of another object with the Copy Location constraint.

You can have more than one constraint at an object.

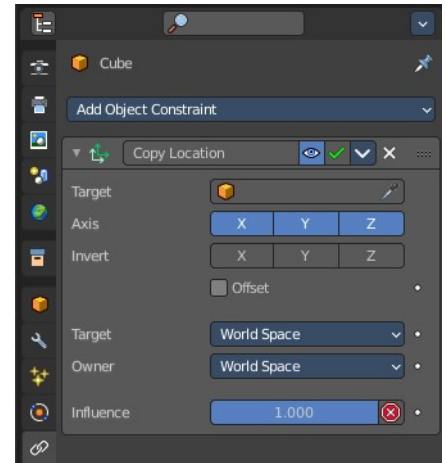

There are four groups of object constraints.

Motion Tracking constraints constraints with Motion Tracking functionality.

Transform contains constraints around everything transform related.

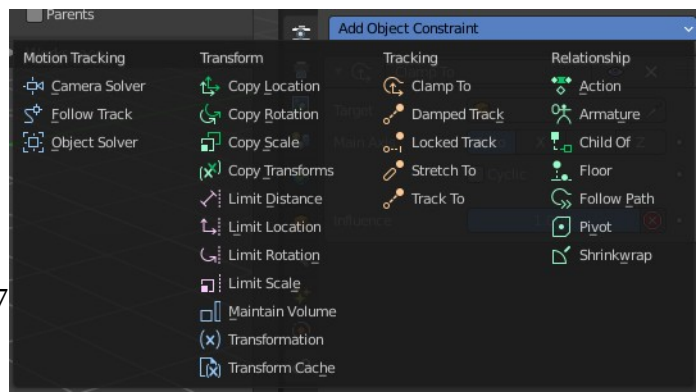

Tracking contains constraints around animation functionality.

And Relationship contains constraints around relations.

The different color has no deeper sense. It helps with navigating in the list of constraints.

General functionality

Add

To add a constraint to an object, simply open the drop down menu, and choose the type of constraint that you want to add.

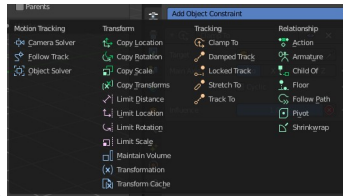

This will add the constraint to the list.

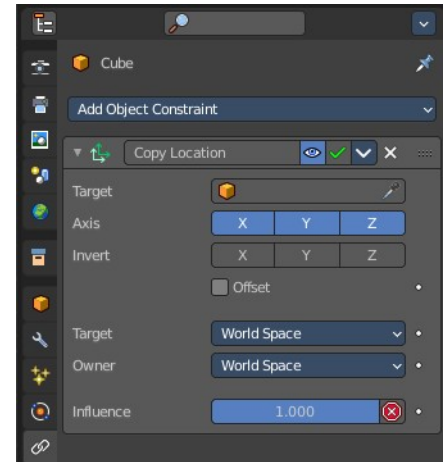

For some constraints you will also find menu items in the 3D view. The Inverse Kinematics / Add IK to Bone is such an example. It also fills in some vital information already in some cases, which you would need to choose by hand when you add the constraints in the constraint tab.

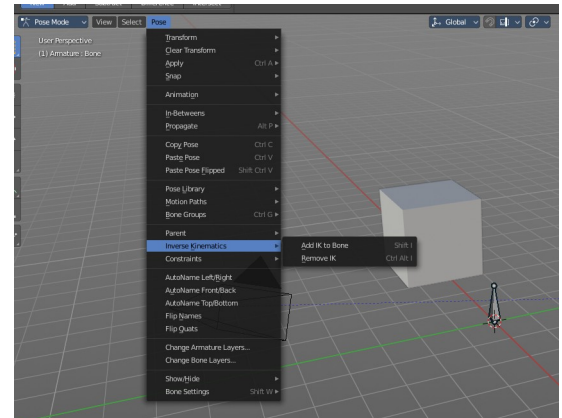

This menu entries exists to simplify the workflow. This menu entries are described in other chapters.

Enable / Disable

You might want to disable a constraint temporarily. This can be done by clicking at the button with the eye icon in the header. To enable the constraint simply click it again.

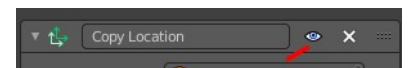

Apply

Applies the constraint. The current state becomes real. The constraint gets deleted.

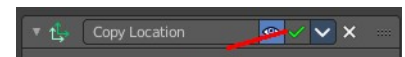

Dropdown menu

Apply

Applies the constraint.

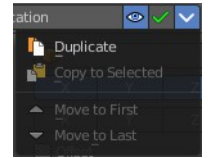

Duplicate

Duplicates the constraint.

Copy to Selected

Copies the constraint from the source to the target object. First select the source object, hold down shift and select the target object so that both are selected. Then perform Copy to Selected. The constraint will now also be at the target object.

Move to First

Moves the constraint to the first place in the constraint list.

Move to Last

Moves the constraint to the last place in the constraint list.

Remove

To remove a constraint from the object simply click the close button up right in the header.



Collapse panel

The whole constraints panel can be collapsed. Click at the arrow button up left in the header.



Reorder

You can have more than one constraint in the list. And sometimes the order of the constraints is very important.

Grab the handler at the right and drag the constraint to the position where you want it to have.

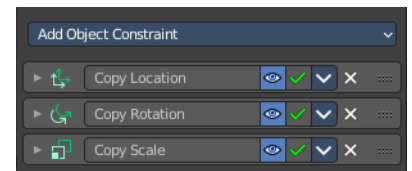

Animate Property

Some of the properties can be animated. Click at the animate property button at the right to add a keyframe.

Object specific constraints

The Object Constraints tab does not contain all constraints. Some constraints are object specific. And appears in an own tab with this object selected. Bone constraints for example appears in the Bone Constraint tab.

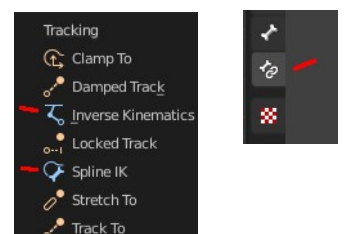

Unfortunately you will still see the whole constraint list, and have to pick the bone constraints from there.

Motion Tracking Constraints

This constraints gets used in Motion Tracking.

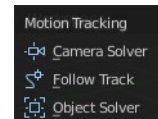

Camera Solver

The Camera Solver constraint gives the owner of this constraint, the location and rotation of the «solved camera motion».

The «solved camera motion» is where Blender reconstructs the position of the physical, real-world camera, when it filmed the video footage, relative to the thing being tracked.

Note: This constraint only works after you have set up a minimum of eight markers and pressed Solve Camera Motion. See motion tracking chapter.

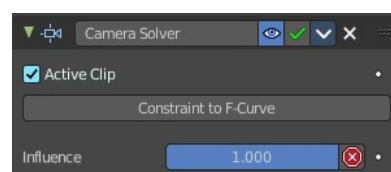

Active Clip

Receive tracking data from the active clip in the Movie Clip editor. If unchecked, an option appears to choose from the other clips.

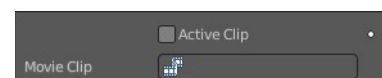

Constraint to F-Curve

Applies the constraint, and creates Keyframes for the transforms.

Influence

The influence level of this constraint.

Follow Track

This constraint makes objects have the same position at a frame as the track has. The motion of this object happens on a single plane defined by the camera and the original position of the object.

Active Clip

Receive tracking data from the active movie clip in the Movie Clip editor. If unchecked, an option appears to choose from the other available clips.

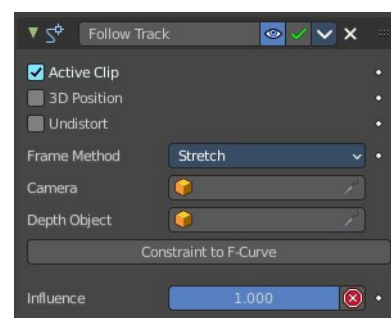

3D Position

Use the 3D position of the track to parent to.

Undistorted

Parent to the undistorted position of the 2D track.

Frame Method

Defines how the footage is fitted in the camera frame.



Camera

Select the camera to which the motion is parented to (if active an empty scene camera is used).

Depth Object

If this object is set, constrained objects will be projected onto the surface of this depth object which can be used to create facial makeup visual effects.

Constraint to F-Curve

Creates F-Curves for the object that copies the movement caused by the constraint.

Influence

The influence level of this constraints.

Object Solver

The Object Solver constraint gives the owner of this constraint, the location and rotation of the «solved object motion».

This can be used to add a mesh to video for example.

Note: This constraint only works after you have set up a minimum of eight markers and pressed Solve object Motion.

If it says Solve Camera Motion instead of Solve Object Motion then go into the Movie Clip Editor > Properties region > Objects and switch it from the camera, to an object.

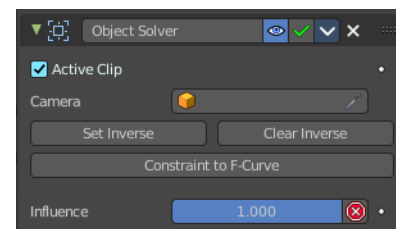

Active Clip

Receive tracking data from the active movie clip in the Movie Clip editor. If unchecked, an option appears to choose from the other available clips.

Camera

Here you can choose the camera.

Set Inverse / Clear Inverse

Set the connection for the object solver constraint inverse.

Clear the inversion.

Constraint to F-Curve

Creates F-Curves for the object that copies the movement caused by the constraint.

Influence

The influence level of this constraint.

Transform Constraints

This category contains transform constraints.



Copy Location

The *Copy Location* constraint sets the position to the position of the target object.

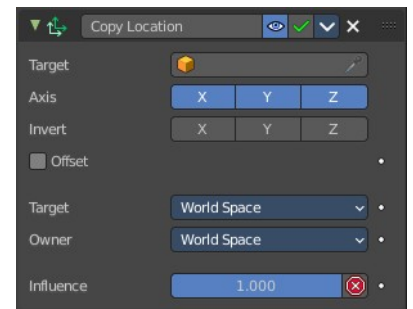

Warning

Using this constraint on a *connected* bone will have no effect. Because it is the parent's tip which controls the position of your owner bone's root.

Target

Here you can choose the target object to copy the location from.

Bone

If the *Target* is an *Armature*, then you have the optional choice to set an individual bone as *Target*.

Head/Tail

If the target is a bone, then here you can adjust where along this bone the target point lies.

Vertex Group

If the *Target* is a *Mesh*, then you have the optional choice to set a *Vertex Group* as target.

X, Y, Z

Here you can choose which axes to constraint.

Invert

Inverts the coordinate input. Positive becomes negative, and vice versa.

Offset

Add an offset from the original position to the target position.

Target Space for Target and Owner

Here you can choose the target space and its coordinate system to use for calculation. The local space uses local axis, the world space global axis. Custom space allows you to use custom data. Like a vertex group of an object.

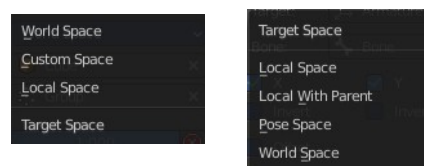

Influence

The influence level of this constraint.

Copy Rotation

The *Copy Rotation* constraint sets the rotation to the rotation of the target object.

Target

Here you can choose the target object to copy the rotation from.

Vertex Group

If the *Target* is a *Mesh*, a new field is displayed offering the optional choice to set a *Vertex Group* as target.

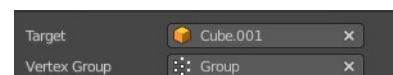
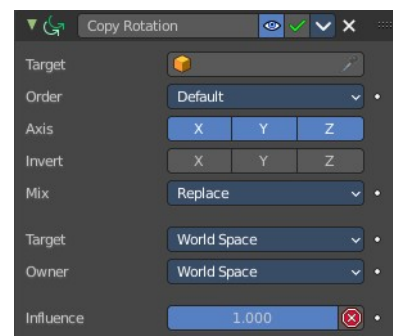
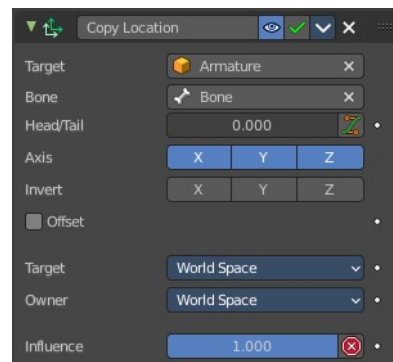

Bone

If the *Target* is an *Armature*, a new field is displayed offering the optional choice to set an individual bone as *Target*.

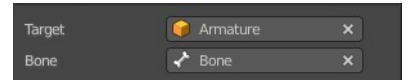

X, Y, Z

These buttons control which axes are constrained - by default, all three are on.

Invert

Inverts the coordinate input. Positive becomes negative, and vice versa.

Offset

Add an offset from the original position to the target position.

Target Space for Target and Owner

Here you can choose the target space and its coordinate system to use for calculation. The local space uses local axis, the world space global axis. Custom space allows you to use custom data. Like a vertex group of an object.

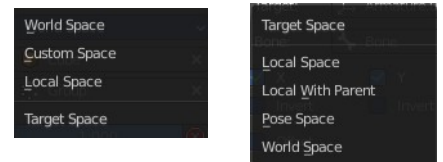

Influence

The influence level of this constraint.

Copy Scale

The *Copy Scale* constraint sets the size to the size of the target object.

Target

Here you can choose the target object to copy the size from.

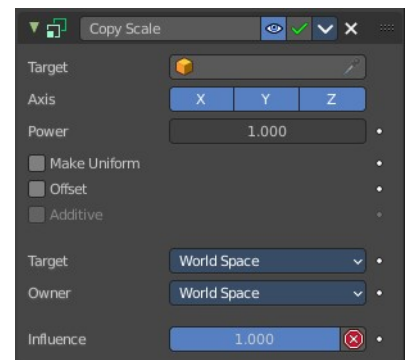

Vertex Group

If *Target* is a *Mesh*, a new field is displayed offering the optional choice to set a *Vertex Group* as target.

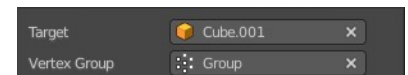

Bone

If *Target* is an *Armature*, a new field is displayed offering the optional choice to set an individual bone as *Target*.

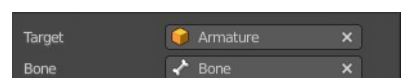

X, Y, Z

These buttons control which axes are constrained - by default, all three are on.

Offset

Add an offset from the original scale to the target scale.

Additive

Use Addition instead of Multiplication to combine scale. This is a compatibility feature to Blender 2.79 and Bforartists 1

Target Space for Target and Owner

Here you can choose the target space and its coordinate system to use for calculation. The local space uses local axis, the world space global axis. Custom space allows you to use custom data. Like a vertex group of an object.

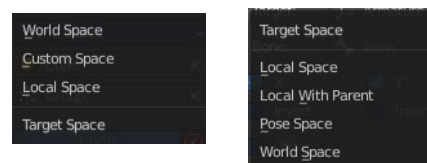

Influence

The influence level of this constraint.

Copy Transforms

The *Copy Transform* constraint copies the whole transform values from the target object. Location, Rotation and Scale.

Target

Here you can choose the target object to copy the location from.

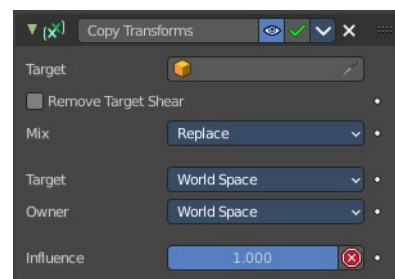

Vertex Group

If *Target* is a *Mesh*, a new field is displayed offering the optional choice to set a *Vertex Group* as target.

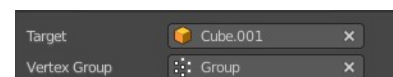

Bone

If the *Target* is an *Armature*, a new field is displayed offering the optional choice to set an individual bone as *Target*.

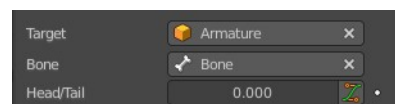

Head/Tail

If the target is a bone, then here you can adjust where along this bone the target point lies.

Remove Target Shear

Remove shear from the target transformation before combining.

Mix

The mix mode specifies how the copied and existing transformations are combined.

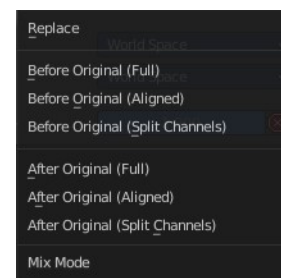

Target Space for Target and Owner

Here you can choose the target space and its coordinate system to use for calculation. The local space uses local axis, the world space global axis. Custom space allows you to use custom data. Like a vertex group of an object.

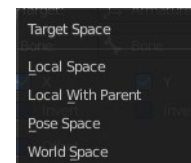
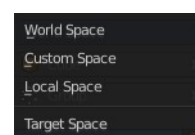

Influence

The influence level of this constraint.

Limit Distance

The *Limit Distance* constraint constraints either outside, inside, or at the surface of a sphere centered at the target object.

Target

Here you can choose the target object.

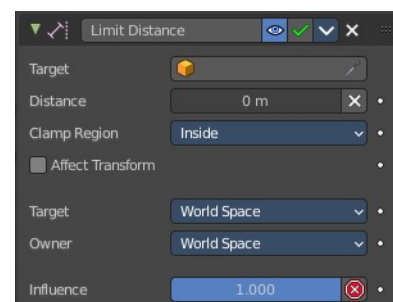

Vertex Group

If *Target* is a *Mesh*, a new field is displayed offering the optional choice to set a *Vertex Group* as target.

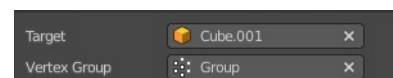

Bone

If the *Target* is an *Armature*, a new field is displayed offering the optional choice to set an individual bone as *Target*.

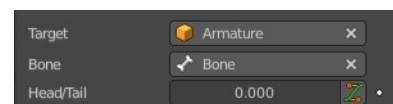

Head/Tail

If the target is a bone, then here you can adjust where along this bone the target point lies.

Distance

This numeric field sets the limit distance, i.e. the radius of the constraining sphere.

Reset Distance

When clicked, this small button will reset the *Distance* value, so that it corresponds to the actual distance between the owner and its target (i.e. the distance before this constraint is applied).

Clamp Region

The *Limit Mode* drop-down menu allows you to choose how to use the sphere defined by the *Distance* setting and target's center:

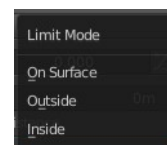

Inside

The owner is constrained *inside* the sphere.

Outside

The owner is constrained *outside* the sphere.

Surface

The owner is constrained *on the surface* of the sphere.

Target Space for Target and Owner

Here you can choose the target space and its coordinate system to use for calculation. The local space uses local axis, the world space global axis. Custom space allows you to use custom data. Like a vertex group of an object.

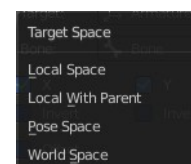
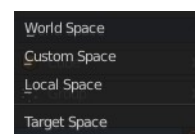

Influence

The influence level of this constraint.

Limit Location

This constraint restricts the amount of allowed translations along each axis, through lower and upper bounds.

The limits for an object are calculated from its center. The limits of a bone are calculated from its root.

Minimum X Y Z

Restrict the minimum location. You can adjust the value in the edit box below.

Maximum X Y Z

Restrict the maximum location. You can adjust the value in the edit box below.

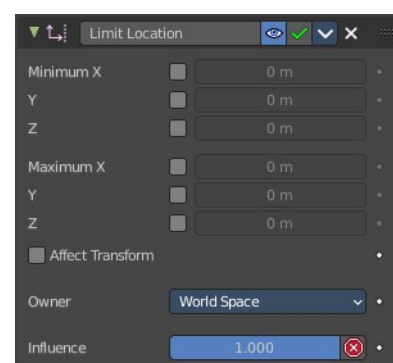

For Transform

The constraint limits the location. The values in the transform panel can still change above this limit though. With this option ticked the transform values are also clamped.

Convert

Calculate the constraint in local space or world space.

Influence

The influence level of this constraint.

Limit Rotation

This constraint restricts the amount of allowed rotation along each axis, through lower and upper bounds.

The limits for an object are calculated from its center. Te limits of a bone are calculated from its root.

Limit X Y Z

Restrict the rotation. You can adjust the minimum and maximum value in the edit boxes below.

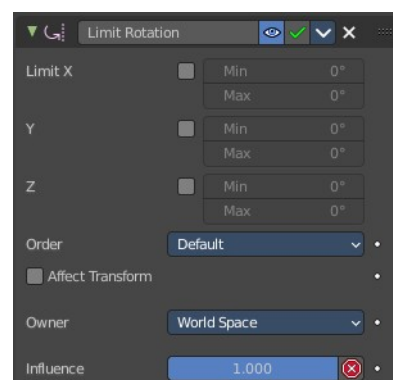

Order

Euler Order. Allows to specify the order of the euler angles.

Affect Transform

The constraint limits the rotation. The values in the transform panel can still change above this limit though. With this option ticked the transform values are also clamped.



Owner Space

Calculate the constraint in custom space, local space or world space.

Influence

The influence level of this constraint.

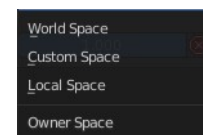

Limit Scale

This constraint restricts the amount of allowed scale along each axis, through lower and upper bounds.

The limits for an object are calculated from its center. Te limits of a bone are

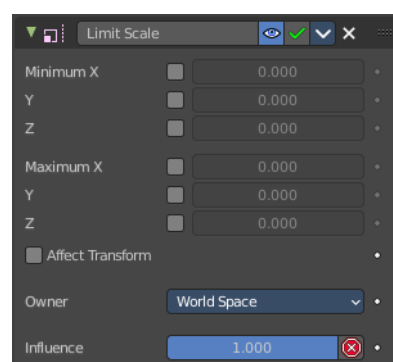

calculated from its root.

Minimum X Y Z

The minimum size. You can adjust the value in the edit boxes below.

Maximum X Y Z

The maximum size. You can adjust the value in the edit boxes below.

For Transform

The constraint limits the location. The values in the transform panel can still change above this limit though. With this option ticked the transform values are also clamped.

Convert

Calculate the constraint in local space or world space.

Influence

The influence level of this constraint.

Maintain Volume

The *Maintain Volume* constraint limits the volume of a mesh or a bone to a given ratio of its original volume.

Free X / Y / Z

The free-scaling axis of the object.

Volume

The bone's rest volume.

Owner Space

Calculate the constraint in local space or world space. Custom space allows you to use custom data. Like a vertex group of an object.

Influence

The influence level of this constraint.

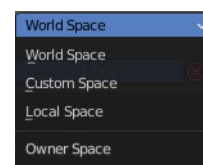
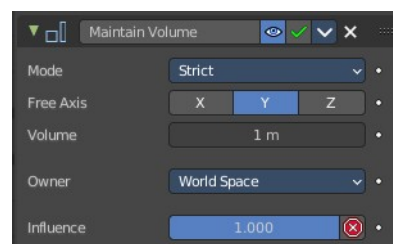

Transformation

The Transformation constraint allows you to map one type of transform

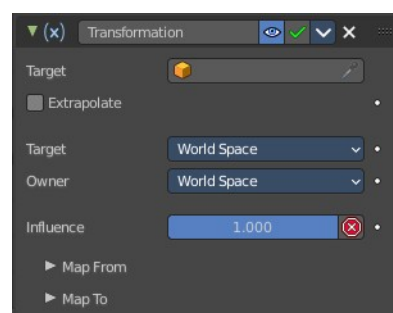

properties (i.e. location, rotation or scale) of the target, to the same or another type of transform properties of the owner, within a given range of values.

Warning

Note that:

- When mapping transform properties to location (i.e. *Loc*, *Destination* button is enabled), the owner's existing location is added to the result of evaluating this constraint (exactly like when the *Offset* button of the *Copy Location constraint* is enabled...).
- Conversely, when mapping transform properties to rotation or scale, the owner's existing rotation or scale is overridden by the result of evaluating this constraint.
- When using the rotation transform properties of the target as input, whatever the real values are, the constraint will always “take them back” into the $-180, 180$ range (e.g. if the target has a rotation of 420 around its X axis, the values used as X input by the constraint will be $((420 + 180) \bmod 360) - 180 = 60 - \dots$). This is why this constraint is not really suited for gears!
- Similarly, when using the scale transform properties of the target as input, whatever the real values are, the constraint will always take their absolute values (i.e. invert negative ones).
- When a *min* value is higher than its corresponding *max* one, both are considered equal to the *max* one. This implies you cannot create “reversed” mappings...

Target

Here you can choose the target object.

Vertex Group

If the *Target* is a *Mesh*, a new field is displayed offering the optional choice to set a *Vertex Group* as target.

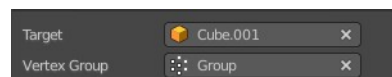

Bone

If the *Target* is an *Armature*, a new field is displayed offering the optional choice to set an individual bone as *Target*.

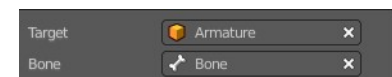

Extrapolate

With this option enabled the *min* and *max* values are no longer strict limits, but rather “markers” defining a proportional (linear) mapping between input and corresponding output values.

Target Space

Space that the target is evaluated in.

Owner Space

Calculate the constraint in local space or world space. Custom space allows you to use custom data. Like a vertex group of an object.

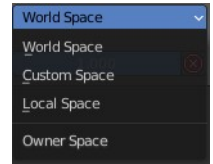

Influence

The influence level of this constraint.

Map From subpanel

Location Rotation Scale

A tab to switch between the available location, rotation and scale values.

X Y Z

The transform values. Here you can edit the minimum and maximum values for the source object.

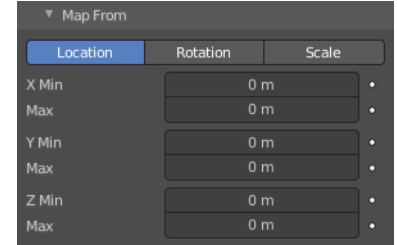

Map To subpanel

Location Rotation Scale

A tab to switch between the available location, rotation and scale values.

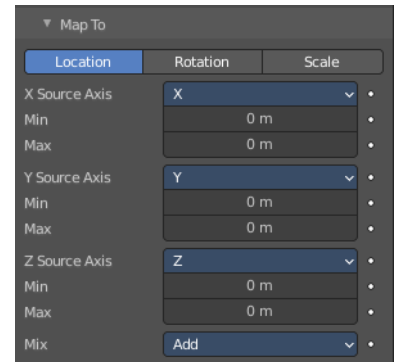

X Source Axis

What axis to use for the X Source constraint.

Min Max

Edit the minimum and maximum values for the source object.

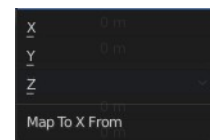

Y Source Axis

What axis to use for the Y Source constraint.

Min Max

Edit the minimum and maximum values for the source object.

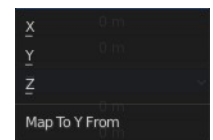

Z Source Axis

What axis to use for the Z Source constraint.

Min Max

Edit the minimum and maximum values for the source object.

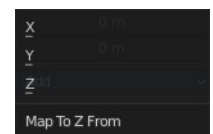

Mix

The location mix mode.

Transform cache

The Transform Cache Constraint allows you to stream animations from Alembic files. The data that is read is at transformation matrix level (for example rigid bodies, or camera movements).

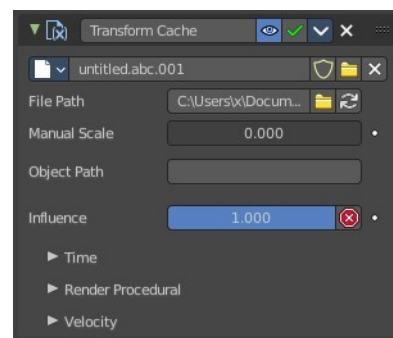
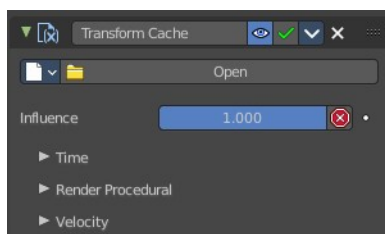

Transform Cache constraints are automatically added to objects with animated transforms.

For time-varying meshes (means deforming animations), the Mesh Sequence Cache modifier is used.

Cache File property

Load the Alembic file.

Dara Browser

A list of available alembic files that are already loaded.

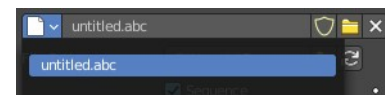

Edit Box

The name of the alembic file.

Fake User

Keep the file in the scene even when it is not used.

Open Cache File

Load an alembic file.

Remove

Remove the alembic file as the active file. The file will remain in the scene until you purge it, close and reload the scene. Given that it has no fake user assigned to keep it in the scene anyways.

File Path

The path to the Alembic file.

Sequence

Whether or not the cache is separated in a series of files.

Refresh Active

Update the files and paths.

Object Path

The path to the Alembic object inside the archive.

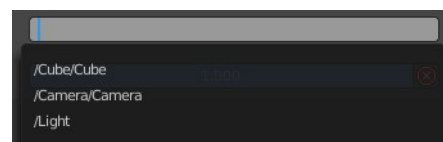

Influence

Controls the percentage of affect the constraint has on the object. See common constraint properties for more information.

Time Subpanel

Sequence

Whether or not the cache is separated in a series of files.

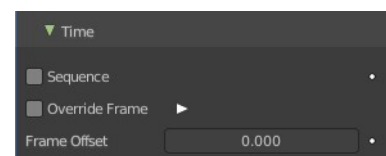

Override Frame

Whether to use a custom frame for looking up data in the cache file, instead of using the current scene frame.

Frame

The time to use for looking up the data in the cache file, or to determine which to use in a file sequence.

Frame Offset

Define a frame offset to the current frame.

Render Procedural subpanel

Use Render Engine Procedural

This feature is just available for Cycles, and just in an experimental state.

Display boxes as placeholders in the viewport.

Use Prefetch

This feature is just available for Cycles, and just in an experimental state.

When enabled, the Cycles procedural will preload animation data for faster update.

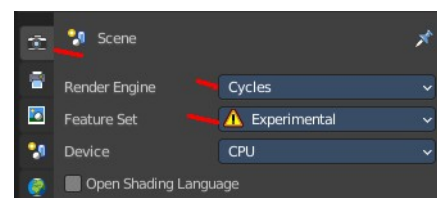
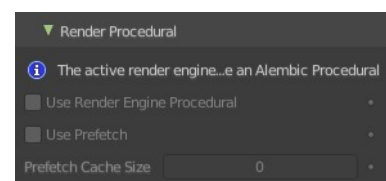

Prefetch Cache Size

This feature is just available for Cycles, and just in an experimental state.

Memory usage limit for the cache. If the data size does not fit the renderer is aborted. 0 disables the feature.

Velocity subpanel

Velocity Attribute

The name of the Alembic attribute used for generating motion blur data. By default, this is .velocities which is standard for most Alembic files.

Velocity Unit

Defines how the velocity vectors are interpreted with regard to time.

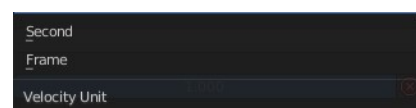

Tracking Constraints

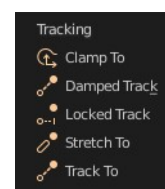

Clamp To

The *Clamp To* constraint clamps an object to a curve. So you need a curve object as the target.

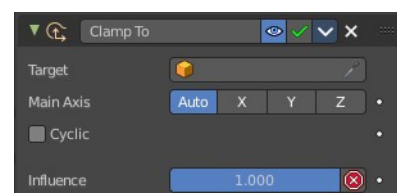

Target

Here you can choose the target object.

Main Axis

Auto clamps to all three axis. X , Y, Z maps just to one axis,.

Cyclic

With cyclic enabled the object will jump from end point to start point once it has reached the end.

Influence

The influence level of this constraint.

Damped Track

Damped track makes the object always look at the target object. For example a camera always looking at an armature

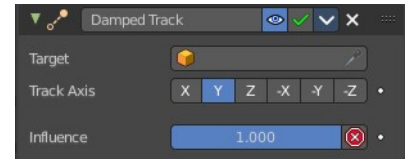

Target

Here you can choose the target object.

Vertex Group

If the *Target* is a *Mesh*, a new field is displayed offering the optional choice to set a *Vertex Group* as target.



Bone

If the *Target* is an *Armature*, a new field is displayed offering the optional choice to set an individual bone as *Target*.

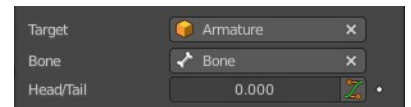

Head/Tail

If the target is a bone, then here you can adjust where along this bone the target point lies.

To

The axis to use to point towards the target object. For a camera you might want to use -Z

Influence

The influence level of this constraint.

Locked Track

Similar to Damped Track. Locked track makes the object always look at the target object. For example a camera always looking at an armature. But here you can lock single axis.

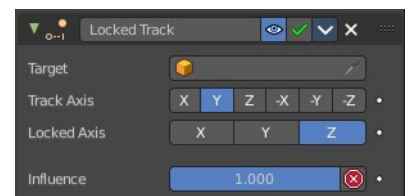

Note, you cannot lock the axis where you look at. The constraint will show the name red then.

Target

Here you can choose the target object.

Vertex Group

If the *Target* is a *Mesh*, a new field is displayed offering the optional choice to set a *Vertex Group* as target.

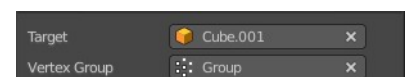

Bone

If the *Target* is an *Armature*, a new field is displayed offering the optional choice to set an individual bone as *Target*.

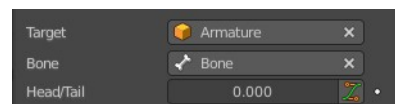

Head/Tail

If the target is a bone, then here you can adjust where along this bone the target point lies.

To

The axis to use to point towards the target object. For a camera you might want to use -Z

Lock

The axis that you want to lock.

Influence

The influence level of this constraint.

Stretch To

Stretch To makes the object always look at the target object. For example a cube always looking at another cube. And makes it stretch when the distance changes.

With bones, the “volumetric” variation scales them along their own local axes (remember that the local Y axis of a bone is aligned with it, from root to tip).



Target

Here you can choose the target object.

Vertex Group

If the *Target* is a *Mesh*, a new field is displayed offering the optional choice to set a *Vertex Group* as target.

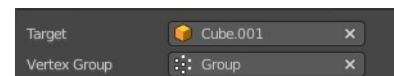

Bone

If the *Target* is an *Armature*, a new field is displayed offering the optional choice to set an individual bone as *Target*.

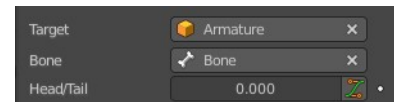

Head/Tail

If the target is a bone, then here you can adjust where along this bone the target point lies.

Rest Length

Here you can define the rest distance between the owner and its target. The rest length is the distance at which there is no deformation (stretching) of the owner.

Reset

Resets the Rest Length.

Volume Min / Volume Max

Here you can control the amount of “volume” variation proportionally to the stretching amount. Note that the 0.0 value is not allowed.



Smooth

Shows when either the volume min or volume max is ticked. Strength of volume stretching clamping.

Volume

Here you can adjust which of the X and/or Z axes should be affected to preserve the virtual volume while stretching along the Y axis. The NONE button disables the volumetric features.

Plane

Here you can control which of the X or Z axes should be as much as possible aligned with the global Z axis, while tracking the target with the Y axis.

Influence

The influence level of this constraint.

Track To

Track To makes the object always look at the target object. For example a cube always looking at another cube. Or a camera looking at a mesh.

Target

Here you can choose the target object.

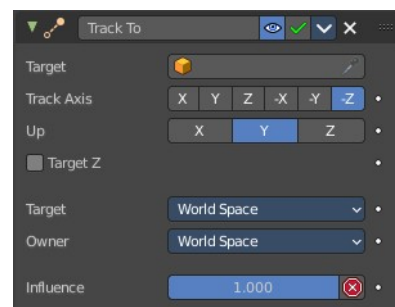

Vertex Group

If the *Target* is a *Mesh*, a new field is displayed offering the optional choice to set a *Vertex Group* as target.

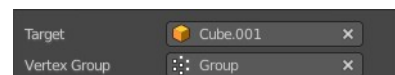

Bone

If the *Target* is an *Armature*, a new field is displayed offering the optional choice to set an individual bone as *Target*.

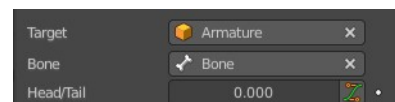

Head/Tail

If the target is a bone, then here you can adjust where along this bone the target point lies.

To

The axis to use to point towards the target object.

Up

The axis that points upwards

Target Z

Constrain the UP direction to the target's Z axis instead of the World Z Axis.

Target Space for Target and Owner

Here you can choose the target space and its coordinate system to use for calculation. The local space uses local axis, the world space global axis. Custom space allows you to use custom data. Like a vertex group of an object.

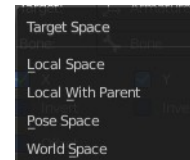
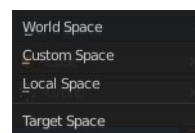

Influence

The influence level of this constraint.

Relationship Constraints

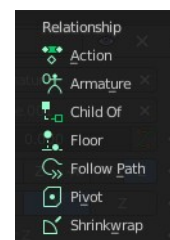

Action

The Action constraints allows you control an *Action* using the animated transformations of another object. For example move a cube when another cube moves by animation, without the need to record this movement by a keyframe. There needs to be an animation in the scene, not necessarily at the target object, which is used as the Action for the constraint.

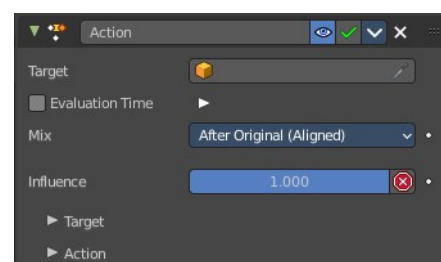

The constraint accepts the *Mesh* action type. But only the *Object*, *Pose* and *Constraint* types are really working, since constraints can only affect objects' or bones' transform properties, and not meshes' shapes.

Only the object transformation (location, rotation, scale) is affected by the action. Keyframes for other properties are ignored. The constraints does not influence them.

Example:

Create a cube. Animate it to create the needed action. Move from a to b for example. And record the keyframes.

This will create an action that is now available to the constraint.

Moving the target in the $[0.0, 2.0]$ range along its X axis maps the action content on the owner in the $[0, 100]$ frame range. This will mean that when the target's X property is 0.0 the owner will be as if in frame 0 of the linked action. With the target's X property at 1.0 the owner will be as if in frame 50 of the linked action, etc.

Target

Here you can choose the target object.

Vertex Group

If the *Target* is a *Mesh*, a new field is displayed offering the optional choice to set a *Vertex Group* as target.

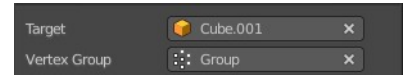

Bone

If the *Target* is an *Armature*, a new field is displayed offering the optional choice to set an individual bone as *Target*.

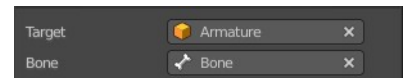

Evaluation Time

Interpolate between action start and endframe by using the slider value instead of using the target object.



Influence

The influence level of this constraint.

Target subpanel

Channel

The transform channel allows you to choose in which space to evaluate its target's transform properties.

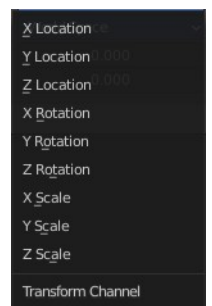
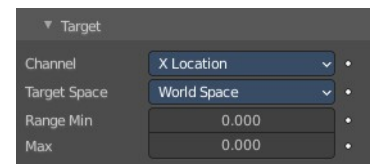

Target Space

The space in which the target is transformed in.

World space transforms in the world space.

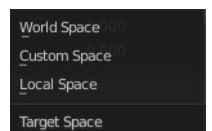

Local space transforms in the local space.

Custom space transforms in the space of the target object. You need to pick the target object.

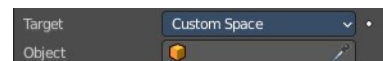

Target Range Min / Max

The lower and upper bounds of the driving transform property value. By default, both values are set to 0.0

Note:

- When using a rotation property as “driver”, these values are “mapped back” to the -180.0 , 180.0 range.
- When using a scale property as “driver”, these values are limited to null or positive values.

Action subpanel

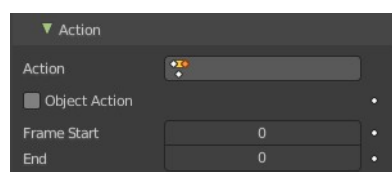

Action

Here you can choose the action that you want to use. Available actions appears in the drop down list.

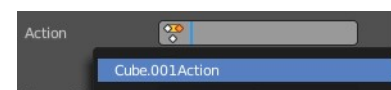

Object Action

This is for bones only. This option will make the constrained bone use the “object” part of the linked action, instead of the “same-named pose” part. This allows you to apply the action of an object to a bone.

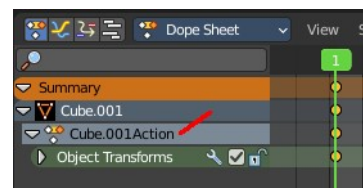

Frame Start / End

The starting and ending frames of the action to be mapped.

Note:

- These values must be strictly positive.
- By default, both values are set to 0 which disables the mapping (i.e. the owner just gets the properties defined at frame 0 of the linked action...).

Notes

- When the linked action affects some location properties, the owner’s existing location is added to the result of evaluating this constraint (exactly as when the *Offset* button of the *Copy Location constraint* is enabled...).
- When the linked action affects some scale properties, the owner’s existing scale is multiplied with the result of evaluating this constraint.
- When the linked action affects some rotation properties, the owner’s existing rotation is overridden by the result of evaluating this constraint.
- Unlike usual, you can have a *Start* value higher than the *End* one, or a *Min* one higher than a *Max* one:

this will reverse the mapping of the action (i.e. it will be “played” reversed...), unless you have both sets reversed, obviously!

- When using a *Constraint* action, it is the constraint *channel’s names* that are used to determine to which constraints of the owner apply the action. E.g. if you have a constraint channel named “trackto_empty1”, its keyed *Influence* and/or *Head/Tail* values (the only ones you can key) will be mapped to the ones of the owner’s constraint named “trackto_empty1”.
- Similarly, when using a *Pose* action (which is obviously only meaningful and working when constraining a bone!), it is the bone’s name that is used to determine which bone *channel’s names* from the action to use (e.g. if the constrained bone is named “arm”, it will use and only use the action’s bone channel named “arm”...). Unfortunately, using a *Pose* action on a whole armature object (to affect all the keyed bones in the action at once) won’t work...
- Note also that you can use the *pose library feature* to create/edit a *Pose* action data-block... just remember that in this situation, there’s one pose per frame!

Armature

Armature is the constraint version of the Armature Modifier. It reproduces the weight-blended bone transformations and applies it to its owner orientation. It can be used like a variant of the Child Of constraint that can handle multiple parents at once, but requires all of them to be bones.

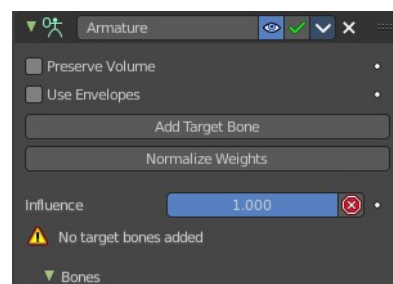

Preserve Volume

Tries to preserve the volume when deforming the mesh.

Use Envelopes

Multiply the weights by envelope for all bones instead of vertex group based blending. The specified weights are still used, and only the listed bones are considered.

Add Target Bone

Add a target bone. By clicking two edit boxes becomes available. You can add multiple armatures and bones here.

Normalize Weights

Normalize the weights of all target bones.

Influence

The influence level of this constraint.

Bones subpanel

When you add a bone with the Add Target Bone, then you create a property in this panel.

First Edit Box

Here you select the armature.

Second Edit Box

Here you select the bone.

Remove Target

Remove the target. Resets Add Target Bone.

Blend Weight

Blending Weight of this bone.

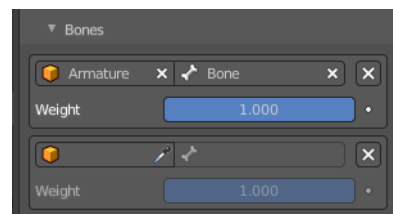

Child Of

This constraint allows you to set a parent to this object. By using more than one constraint you can have more than one parent object here, and control the influence by the Influence slider. You can also just parent the movement of a specific axis.

Target

Here you can choose the target object.

Vertex Group

If the *Target* is a *Mesh*, a new field is displayed offering the optional choice to set a *Vertex Group* as target.

Bone

If the *Target* is an *Armature*, a new field is displayed offering the optional choice to set an individual bone as *Target*.

Location, Rotation, Scale

Activate the parenting for the corresponding axis.

Set Inverse / Clear Inverse

Set the connection for the object solver constraint inverse.

Clear the inversion.

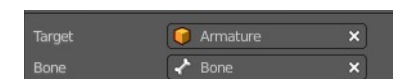
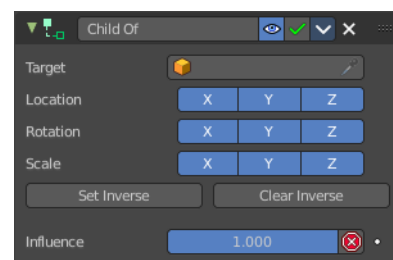

Influence

The influence level of this constraint.

Floor

The Floor constraints allows to set an object as a floor or wall that cannot be passed by the object.

Note that the center of the object is calculated as the collision point, not the surface. Means a cube with the pivot in the center can still sink half into a ground plane. This can be adjusted with the Offset value.

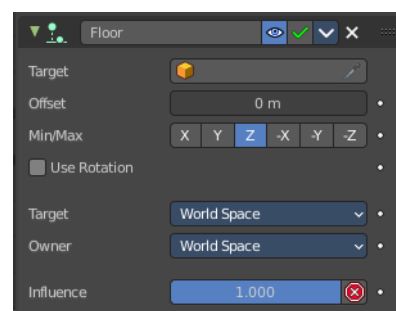

Target

Here you can choose the target object.

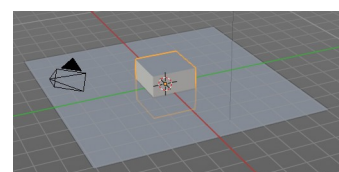

Vertex Group

If the *Target* is a *Mesh*, a new field is displayed offering the optional choice to set a *Vertex Group* as target.

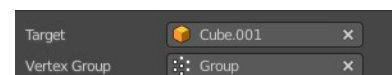

Bone

If the *Target* is an *Armature*, a new field is displayed offering the optional choice to set an individual bone as *Target*.

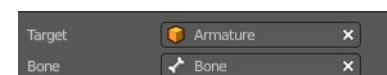

Sticky

The object sticks at its position at contact. For example, it cannot slide around on the surface of a plane any more.

Use Rotation

Take the target's rotation into account. This allows you to have a "floor" plane of any orientation you like, not just the global XY, XZ and YZ ones...

Offset

Here you can define an offset from the pivot to the ground plane object.

Min / Max

Here you define which side of the target object will be the floor.

By default, these normals are aligned with the global axes. If you enable Use Rotation (see above), they will be aligned with the local target's axes.

Target Space for Target and Owner

Here you can choose the target space and its coordinate system to use for calculation. The local space uses local axis, the world space global axis. Custom space allows you to use custom data. Like a vertex group of an object.

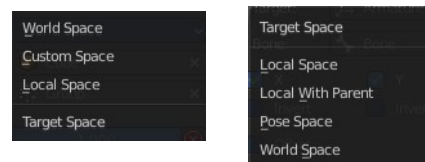

Influence

The influence level of this constraint.

Follow Path

Makes the object follow a curve path. This constraint requires a Bezier or Nurbs Curve. Follow Path is an animation only constraint.

The movement happens in the global world.

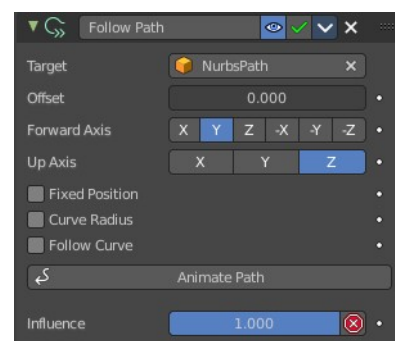

Click at Animate Path to create the animation. When you play the animation, then the object will move along the path now. The path length can be adjusted in the Path Animation panel of the curve. Here you can see that the value behind evaluation time is now green. And there is a keyframe symbol behind the edit box. Adjust the number of frames to your needs.

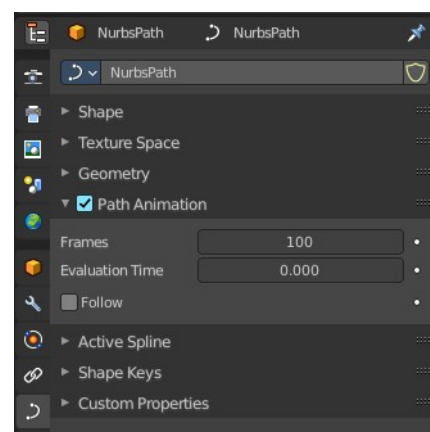

Target

Choose the target path.

Offset

The number of frames to offset from the “animation” defined by the path. It starts by default from frame 1.

Forward Axis

The axis that points forward at the path.

Up Axis

The axis that points upwards.

Fixed position

Object will stay locked to a single point somewhere along the length of the curve regardless of time.

Curve Radius

Objects scaled by the curve radius. See Curve Editing.

Follow Curve

When this option is activated, the owner's rotation is modified by:

Forward

The axis of the object that has to be aligned with the forward direction of the path (i.e. tangent to the curve at the owner's position).

Up

The axis of the object that has to be aligned (as much as possible) with the world Z axis. In fact, with this option activated, the behavior of the owner shares some properties with the one caused by a Locked Track constraint, with the path as "axle", and the world Z axis as "magnet".

Animate Path

Add a default animation for the path constraint if it is not animated already.

Pivot

The *Pivot* constraint allows the owner to rotate around a target object.

Target

Here you can choose the target object.

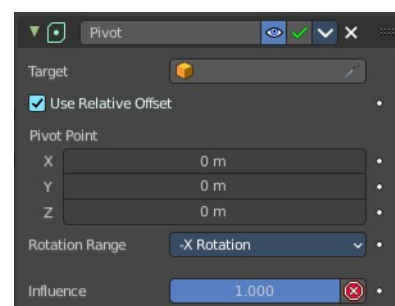

Vertex Group

If the *Target* is a *Mesh*, a new field is displayed offering the optional choice to set a *Vertex Group* as target.

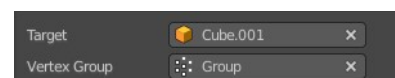

Bone

If the *Target* is an *Armature*, a new field is displayed offering the optional choice to set an individual bone as *Target*.

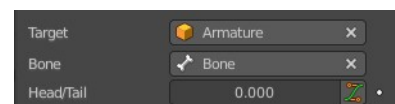

Head/Tail

If the target is a bone, then here you can adjust where along this bone the target point lies.

Use Relative Offset

Offset will be an absolute point in space instead of relative to the target.

Pivot Offset X / Y / Z

Here you can adjust an offset.

Rotation Range

Enable rotation range for specific axis.

Influence

The influence level of this constraint.

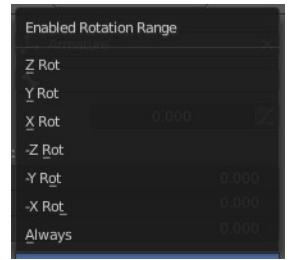

Shrinkwrap

The Shrinkwrap constraint allows you to snap objects to the surface of mesh objects. The target object has to be a Mesh object. Other object types does not work.

The snap point is the pivot point of the object.

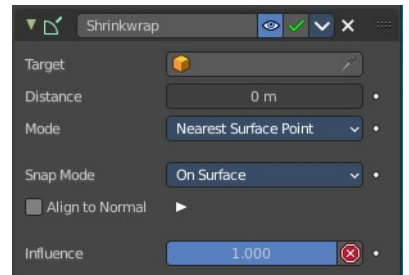

Distance

Here you can adjust an offset.

Shrinkwrap Mode

Here you can choose between different shrink-wrap methods.

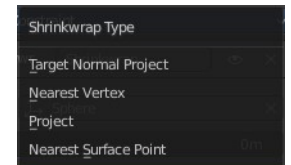

Target Normal Project

Target the nearest target surface along the interpolated vertex normals of the target.

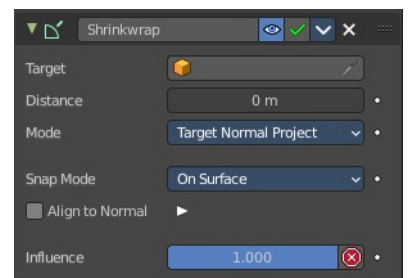

Nearest Vertex

Target the nearest vertex at the target.

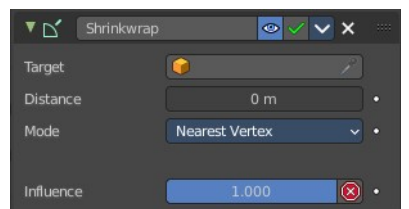

Project

Target the nearest surface point along a given axis.

Project Axis

Here you can define the axis

Space

Here you can define the space that gets used for this axis.

Distance

Limit the distance used for projection. Zero disables the Project Distance.

Project Opposite

Project in both specified and opposite directions.

Face Cull

Stop vertices from projecting to a face on the target when facing towards or away.

Invert Cull

Invert the face cull mode.

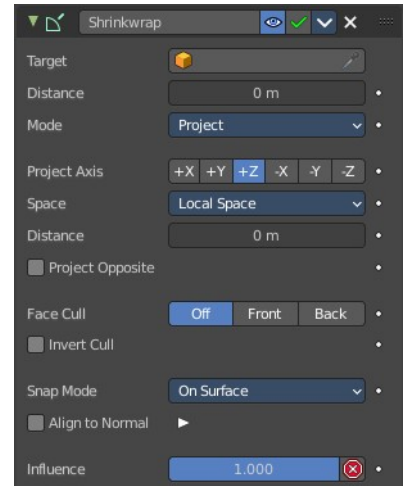

Nearest Surface Point

Target the nearest surface point.

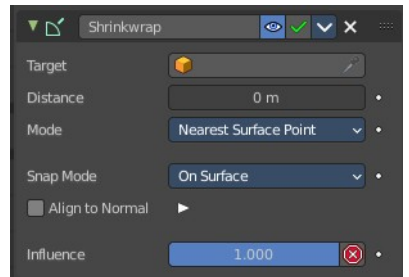

Snap Mode

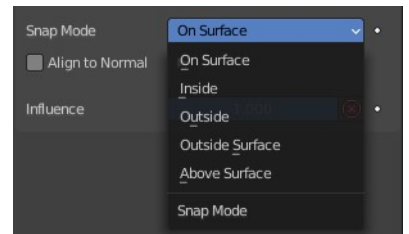

Align to Normal

Align a specified axis to the surface normal.

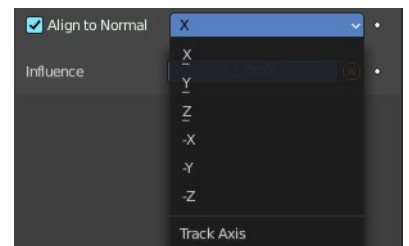

Influence

The influence level of this constraint.



26.14 Editors - Properties Editor - Object Data Properties Tab

Table of content

Properties Editor - Object Data Tab.....	1
Data Browser.....	1
Name.....	2
Fake User.....	2
Custom Properties panel.....	2
Add.....	2
Property Value.....	2
Edit.....	2
Remove.....	2

Properties Editor - Object Data Tab

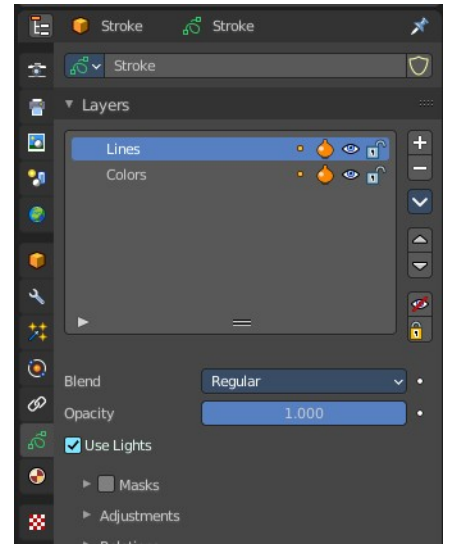
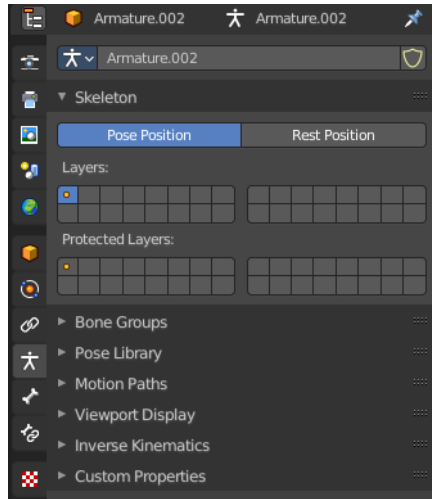
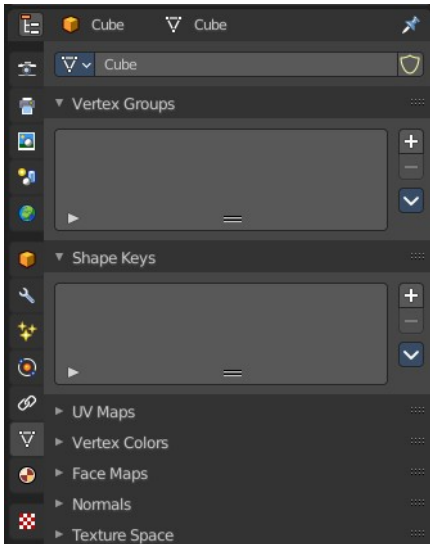

In the object data tab you will find all the object specific data settings. For a mesh object vertex groups and shape keys for example. An armature object will show armature related settings.

The icon can differ. For a mesh object you will have a vertice icon. For an armature object you will have a armature icon.

And the content of the panels can differ, dependent of the mode you are in. Some tools just shows in edit mode. Assign / Remove tools for vertex groups for example.

Data Browser

Lists the available mesh data of objects of same type. And allows to choose another mesh data of the same type.

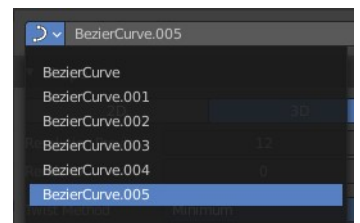

Name

The name of the **Mesh data** of the currently active object. You can also use the mesh data from other objects of the same type.

By default the name of the mesh data is the same than the object name. But it can be renamed.

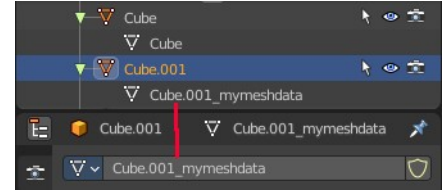

Fake User

Add a fake user to this object so that it is not deleted when it has no user in the scene.

Custom Properties panel

This panel exists for all object types in the Object Data Properties. Allows you to add custom properties that can be used in various ways then. For scripting, or to drive animation etc.

In this panel you might also find custom properties from addons or scripts.

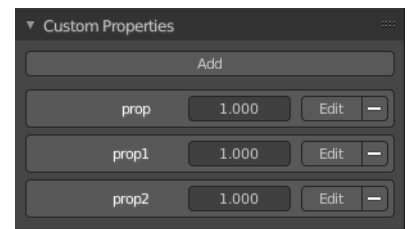

Add

Adds a new property.

Property Value

The value of the property.

Edit

Opens a panel where you can adjust the settings for the custom property. The settings should be self explaining.

Remove

Removes the property.

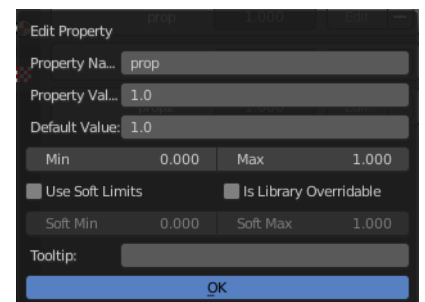



26.14.1 Editors - Properties Editor - Object Data Properties Tab - Mesh Object

Table of content

Detailed table of content.....	1
Vertex groups panel.....	4
Shape Keys panel.....	7
UV Maps panel.....	11
Color Attributes panel.....	12
Face Maps panel.....	14
Attributes panel.....	15
Normals panel.....	16
Texture Space panel.....	17
Remesh Panel.....	18
Geometry Data panel.....	19
Custom Properties Panel.....	19

Detailed table of content

Detailed table of content

Detailed table of content.....	1
Vertex groups panel.....	4
Active Vertex Group list.....	4
Group name.....	4
Lock.....	4
Drag Handler.....	4
Search Field.....	5
Invert.....	5
Sort by Name.....	5
Add +.....	5
Remove -.....	5
Specials menu.....	5
Sort by Name.....	5
Sort by Bone Hierarchy.....	5
Copy Vertex Group.....	5
Copy Vertex Groups to Linked.....	5
Copy Vertex Group to Selected.....	5
Mirror Vertex Group.....	5
Mirror Vertex Group (Topology).....	6
Remove from All Groups.....	6
Clear Active Group.....	6
Delete All Unlocked Groups.....	6
Delete All Groups.....	6
Lock All.....	6
Unlock All.....	6
Lock Invert All.....	6
Move Vertex Group Up / Down.....	6
Assign.....	6

Remove.....	6
Select.....	6
Deselect.....	7
Weight.....	7
Set Active Group.....	7
Shape Keys panel.....	7
Workflow.....	7
Active Shape Key Index.....	8
Shape Key name.....	8
Slider value.....	8
Lock.....	8
Drag Handler.....	8
Search Field.....	8
Invert.....	9
Sort by Name.....	9
Add +.....	9
Remove -.....	9
Specials menu.....	9
New Shape From Mix.....	9
Mirror Shape Key.....	9
Mirror Shape Key (Topology).....	9
Join as Shapes (Transfer Mix).....	9
Transfer Shape Key.....	9
Delete all Shape Keys.....	9
Move to Top.....	10
Move to Bottom.....	10
Move Shape Key Up / Down.....	10
Relative.....	10
Relative.....	10
Shape Key Lock (pin icon).....	10
Shape Key Edit Mode (edit mode icon).....	10
Value.....	10
Range.....	10
Vertex Group.....	10
Relative To.....	10
Absolute.....	10
Shape Key Lock (pin icon).....	10
Shape Key Edit Mode (edit mode icon).....	11
Re-Time Shape Keys (clock icon).....	11
Interpolation.....	11
Evaluation Time.....	11
UV Maps panel.....	11
UV Map.....	11
Workflow.....	11
Active UV Loop Key Index.....	11
UV Map name.....	11
Active Render.....	12
Drag Handler.....	12
Search Field.....	12
Invert.....	12
Sort by Name.....	12
Add +.....	12
Remove -.....	12

Color Attributes panel.....	12
Active Color Index.....	12
Color index name.....	12
Active Render.....	13
Drag Handler.....	13
Search Field.....	13
Invert.....	13
Sort by Name.....	13
Add +.....	13
Add Color Attribute Specials.....	13
Name.....	13
Domain.....	13
Data Type.....	13
Color.....	13
Ok.....	13
Remove -.....	14
Specials menu.....	14
Duplicate Color Attribute.....	14
Convert Color Attribute.....	14
Face Maps panel.....	14
Face Map Index.....	14
Face map name.....	14
Drag Handler.....	14
Search Field.....	14
Invert.....	14
Sort by Name.....	14
Add +.....	15
Remove -.....	15
Attributes panel.....	15
Attributes Index.....	15
Attribute name.....	15
Drag Handler.....	15
Search Field.....	15
Invert.....	15
Sort by Name.....	15
Add +.....	15
Remove -.....	16
Attribute Specials.....	16
Convert Attribute.....	16
Mode.....	16
Domain.....	16
Data Type.....	16
Normals panel.....	16
Autosmooth.....	16
Autosmooth angle.....	16
Add / Clear Custom Split Normals Data.....	17
Texture Space panel.....	17
Texture Mesh.....	17
Auto Texture Space.....	17
Location, Size.....	18
Remesh Panel.....	18
Mode.....	18
Voxel Size.....	18

Adaptivity.....	18
Fix Poles.....	18
Smooth Normals.....	18
Preserve.....	19
Volume.....	19
Paint Mask.....	19
Face Sets.....	19
Voxel Remesh / QuadriFlow Remesh.....	19
Geometry Data panel.....	19
Clear Sculpt-Mask Data.....	19
Clear Skin Data.....	19
Store Vertex Bevel Weight.....	19
Stores Edge Bevel Weight.....	19
Store Edge Crease.....	19
Custom Properties Panel.....	19
Add.....	20
Edit.....	20
Remove.....	20

Vertex groups panel

A Vertex group is a group of vertices, a selection of the mesh. It is for example used to weight a specific mesh part to a bone. Or to control the growth of hair particles.

This panel allows you to manage and edit vertex groups. Weight painting creates vertex groups automatically.

In Edit mode this panel shows some further controls.

Vertex groups exists for mesh and lattice objects.

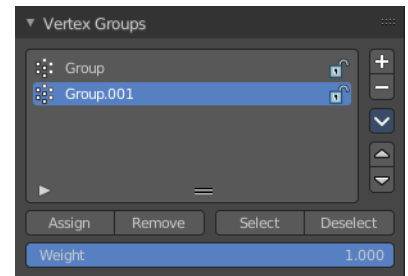

Active Vertex Group list

A List of the vertex groups for this mesh.

Group name

The name of the group. It can be renamed by double clicking at it.

Lock

The lock icon at the end of a group name locks the group from being editable.

Drag Handler

The two vertical lines at the end is a handler with which you can expand the list.

Search Field

You can expand a search field at the bottom of the list. Type in your term and hit enter to filter for your term.



Invert

Exclude the search term instead of searching for it.

Sort by Name

Sort the List by name.

Add +

Create an empty vertex group.

Remove -

Deletes the active vertex group.

Specials menu

Sort by Name

Sorts the vertex groups alphabetically by name.

Sort by Bone Hierarchy

Sorts the vertex groups by the hierarchy of the assigned bones.

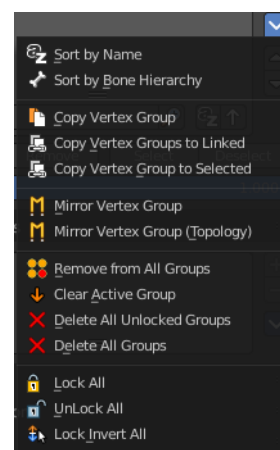

Copy Vertex Group

Add a copy of the active vertex group as a new group. The new group will be named like the original group with “_copy” appended at the end of its name. And it will contain associations to exactly the same vertices with the exact same weights as in the source vertex group.

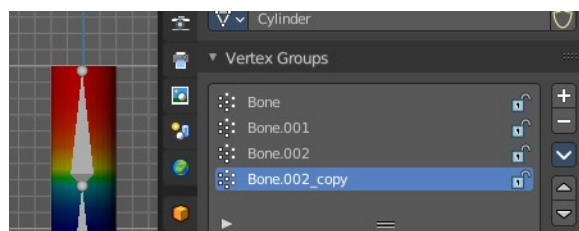

Copy Vertex Groups to Linked

Copy vertex groups of this mesh to all linked objects which use the same mesh data (all users of the data).

Copy Vertex Group to Selected

Copy all vertex groups to other selected objects provided they have matching indices (typically this is true for copies of the mesh which are only deformed and not otherwise edited).

Mirror Vertex Group

Mirrors weights and/or flips group names from one side of a symmetrical mesh to the other.

Only mirroring along local X axis is supported. Vertices that have no corresponding vertex on the other side will not be affected. Note, the weights are not transferred to the corresponding opposite bone weight group.

Mirror Vertex Group (Topology)

Performs the Mirror Vertex Group with the Topology Mirror option enabled.

Remove from All Groups

Unassigns the selected vertices from all groups. Even locked.

Clear Active Group

Remove all assigned vertices from the active group. The group is made empty. Note that the vertices may still be assigned to other vertex groups of the object. This feature does not affect locked groups.

Delete All Unlocked Groups

Remove all vertex groups from the object that are not locked.

Delete All Groups

Remove all vertex groups from the object.

Lock All

Lock all groups.

Unlock All

Unlock all groups.

Lock Invert All

Invert group locks.

Move Vertex Group Up / Down

Moves the selected vertex group up or down in the list.



Assign

Assign the selected vertices to the active vertex group.

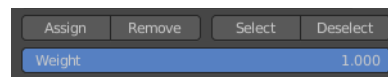

Remove

Remove the selected vertices from the active group.

Select

Select all vertices in the group.

Deselect

Deselect all vertices in the group.

Weight

The weight value that gets assigned to the selected vertices.

Set Active Group

Lets you select the group that will become the active one (menu only).

Shape Keys panel

This panel allows you to see and manage shape keys. A shape key is a vertex animation.

Shape keys are for example used for facial animations, when you don't want to use a face rig with bones. The idea is to model a shape key pose for smiling, one for laughing, one for sad, and so on. And then blend the shape key poses together as needed.

Shape keys are also called morph targets or blend shapes.

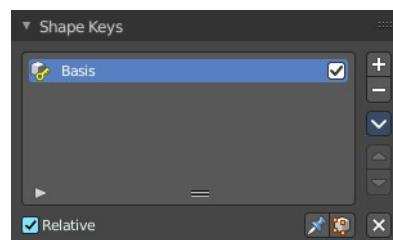

Workflow

In Object mode add a shape key. This first shape key is called Basis by default. It is the base for the vertex animation. This basis shape key is the base shape for all further shape keys. It cannot be modified or keyframed.

Now add a second shape key. This second shape key will have more controls so that you can modify it in the needed way.

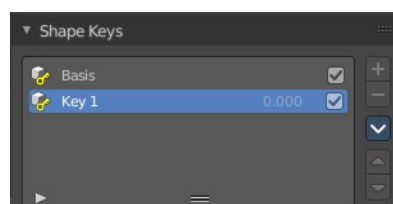

Enter edit mode with this key 1 selected.

Modify the geometry by moving some vertices around.

Switch back to Object mode.

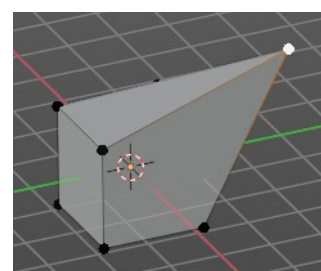

Have a look at the value slider. This slider defines how the key 1 shape key blends with the Basis shape key.

Move it from value 0 to value 1. You will notice that the vertices that you have modified in Key 1 will now start to move to a new position. Dependent of how strong the value is. With a value of 1 it will be at the position of how you modeled it.

To keyframe this shape click at the Animate property dot behind the slider. The slider will change its color. And the dot will change to a rhombus shape to indicate that there is a keyframe recorded at this frame.

Or you right click at the slider, and choose Insert Keyframe in the menu.

Move to another frame. Change the slider value, and set another keyframe.

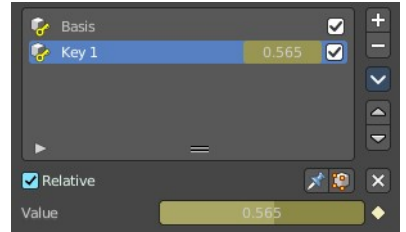
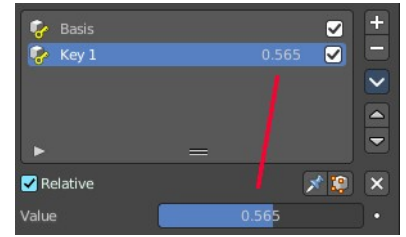

Recorded keyframes can be found and further tweaked in the Dope sheet Editor in Shape Key Editor mode. Here you can also record further keyframes under Key / Insert Keyframes. And control the slider values from the channel list.

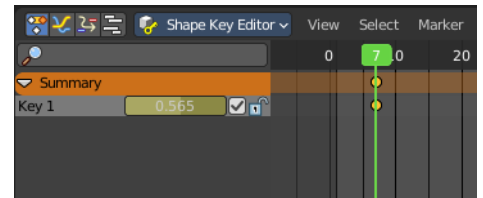

Add more shape keys and model and animate them as you need them.

Active Shape Key Index

A List of the shape keys for this mesh.

It contains two types of shape keys. Basis is the base shape. The other type relies at this shape as the base.

Shape Key name

The name of the shape key. It can be renamed by double clicking at it.



Slider value

The blend value of this shape key. The Basis shape key does not have such a slider.

Lock

The lock icon at the end of a group name locks the group from being editable.

Drag Handler

The two vertical lines at the end is a handler with which you can expand the list.

Search Field

You can expand a search field at the bottom of the list. Type in your term and hit enter to filter for your term.



Invert

Exclude the search term instead of searching for it.

Sort by Name

Sort the List by name.

Add +

Create a shape key.

Remove -

Delete the selected shape key.

Specials menu

New Shape From Mix

Add a new shape key with the current deformed shape of the object.

Mirror Shape Key

Mirror the shape keys on the X axis. This will not work if the mesh vertices is not fully symmetrical.

Mirror Shape Key (Topology)

Mirror the shape keys on the X axis. But detects the mirrored vertices based on the topology of the mesh. The mesh vertices do not have to be perfectly symmetrical for this action to work.

Join as Shapes (Transfer Mix)

Transfer the current resulting shape from a different object.

Select the object to copy, hold down Shift, then the object to copy into. Use this action and a new shape key will be added to the active object with the current mix of the first object.

Transfer Shape Key

Transfer the active shape key from a different object regardless of its current influence.

Select the object to copy, hold down Shift, then the object to copy into. Use this action and a new shape key will be added to the active object with the active shape of the first object.

Delete all Shape Keys

Delete all shape keys at this mesh.

Move to Top

Move the shape key to the top of the list. But not above the Basis shape key.

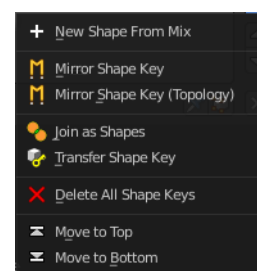

Move to Bottom

Move the shape key to the bottom of the list.

Move Shape Key Up / Down

Moves the selected shape key up or down in the list.



Relative

Set the shape keys to Relative or Absolute.

Relative

The shape is defined relative to the Basis or another specified shape key. And can be adjusted in its settings.

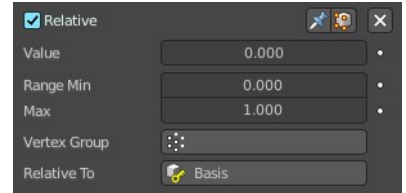

Shape Key Lock (pin icon)

Show the active shape in the 3D Viewport without blending. Shape Key Lock gets automatically enabled while the object is in Edit Mode.

Shape Key Edit Mode (edit mode icon)

If enabled, when entering Edit Mode the active shape key will not take maximum influence as is default. Instead, the current blend of shape keys will be visible and can be edited from that state.

Value

The weight of the blend between the shape key and its basis key. 0 means no influence, 1 full influence.

Range

Minimum and maximum range for the influence value of the active shape key.

Vertex Group

Limit the active shape key deformation to a vertex group.

Relative To

Select the shape key to deform from. It does not need to be the Basis shape key, but can also be another shape key.

Absolute

The shape changes over time, as defined in its settings.



Shape Key Lock (pin icon)

Show the active shape in the 3D Viewport without blending. Shape Key Lock gets automatically enabled while the object is in Edit Mode.

Shape Key Edit Mode (edit mode icon)

If enabled, when entering Edit Mode the active shape key will not take maximum influence as is default. Instead, the current blend of shape keys will be visible and can be edited from that state.

Re-Time Shape Keys (clock icon)

Absolute shape keys are timed, by order in the list, at a constant interval. This button resets the timing for the keys. Useful if keys were removed or re-ordered.

Interpolation

The interpolation method between shape keys.

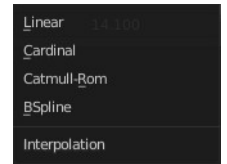

Evaluation Time

Evaluate the shape key influence over the defined time. The evaluation starts at influence 0, and reaches 1 at the end of the value of this timer.

UV Maps panel

UV Map

A mesh object can have more than one UV map. Here you can manage the UV maps.

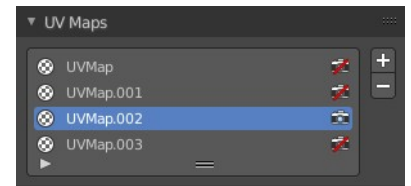

Just one UV map can be active at a time. But you can use secondary UV maps in a material.

Workflow

A UV map is simply a group of selected UV elements. So select an UV map, set it active by clicking at the Active Render symbol. And select the UV geometry that should be in this UV map.

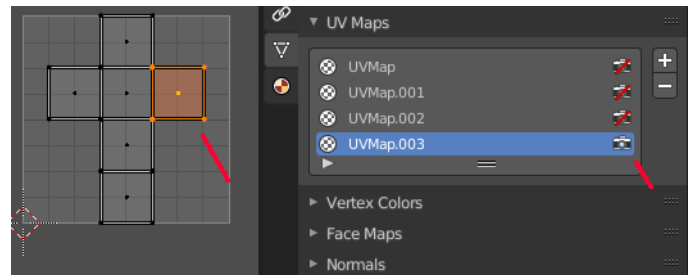

Active UV Loop Key Index

A List of the UV maps for this mesh.

It contains two types of shape keys. Basis is the base shape. The other type relies at this shape as the base.

UV Map name

The name of the shape key. It can be renamed by double clicking at it.

Active Render

Set this UV map as the one to render. Just one UV map can be active at a time. But you can use secondary UV maps in a material.

Drag Handler

The two vertical lines at the end is a handler with which you can expand the list.

Search Field

You can expand a search field at the bottom of the list. Type in your term and hit enter to filter for your term.



Invert

Exclude the search term instead of searching for it.

Sort by Name

Sort the List by name.

Add +

Create a shape key.

Remove -

Delete the selected shape key.

Color Attributes panel

In vertex paint mode and sculpt mode you can paint vertices of a mesh with a color. This will create a vertex color index. You can see and manage this vertex color indexes in the Vertex Colors panel.

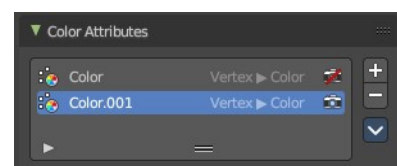

Vertex colors can for example be used to mix shaders together. Or also directly render them. In the shader editor color attributes can be used by the Attribute node.

A mesh can have more than one vertex color index and type. But just one index can be the active one.

Active Color Index

A List of the vertex color indexes for this mesh.

Color index name

The name of the vertex color index. It can be renamed by double clicking at it.

Active Render

Set this vertex color index as the one to render. Just one vertex color index can be active at a time. But you can use another vertex color index in a material.

Drag Handler

The two vertical lines at the end is a handler with which you can expand the list.

Search Field

You can expand a search field at the bottom of the list. Type in your term and hit enter to filter for your term.



Invert

Exclude the search term instead of searching for it.

Sort by Name

Sort the List by name.

Add +

Create a vertex color index.

Add Color Attribute Specials

Name

The name of the color attribute index.

Domain

The domain of the color attribute.

- **Vertex** stores the color attribute data in the vertices of the mesh data
- **Face Corner** stores the color attribute data in the face corners of the mesh data

Data Type

The the color attribute type.

- **Color** stores RGBA color 32-bit floating point values
- **Byte Color** stores RGBA color 32-bit positive integer values

Color

The Default fill colour

Ok

Confirm to apply

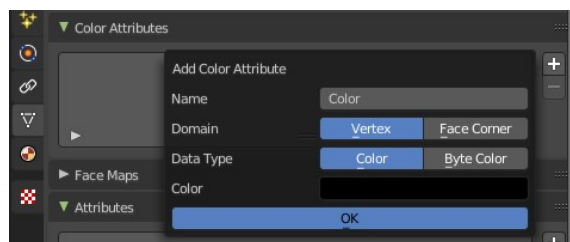

Remove -

Delete the selected vertex color index.

Specials menu

Duplicate Color Attribute

Duplicates the selected color attribute

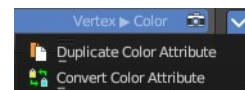

Convert Color Attribute

Convert a color attribute domain and data type. This tool calls a popup where you can choose what to convert.

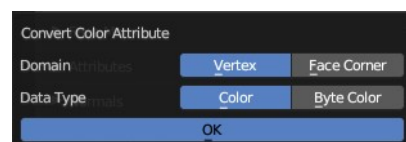

Face Maps panel

Face Maps creates custom gizmos to deform meshes by assigning faces to Face Maps. Face Maps can be used to rig in Object Mode and without making complicated rigging setups.

Face Maps is an experimental implementation. They are currently not fully implemented, and require add-ons to take full advantage of this feature.

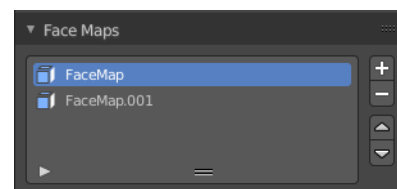

Face Map Index

A List of the face maps for this mesh.

Face map name

The name of the face maps. It can be renamed by double clicking at it.

Drag Handler

The two vertical lines at the end is a handler with which you can expand the list.

Search Field

You can expand a search field at the bottom of the list. Type in your term and hit enter to filter for your term.



Invert

Exclude the search term instead of searching for it.

Sort by Name

Sort the List by name.

Add +

Create a face map.

Remove -

Delete the selected face map.

Attributes panel

A list of the attributes at this object. Attributes can be used to identify an object in the shader editor or the geometry nodes editor

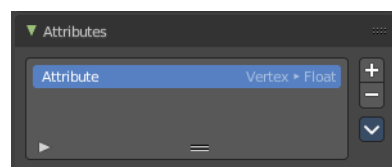

Attributes Index

A List of the attributes for this mesh.

Attribute name

The name of the attributes. It can be renamed by double clicking at it.

Drag Handler

The two vertical lines at the end is a handler with which you can expand the list.

Search Field

You can expand a search field at the bottom of the list. Type in your term and hit enter to filter for your term.



Invert

Exclude the search term instead of searching for it.

Sort by Name

Sort the List by name.

Add +

Create a new attribute.

Remove -

Delete the selected attribute.

Attribute Specials

Convert Attribute

Change how the selected attribute is stored.

This operator opens a popup menu where you can change the settings of the attribute.

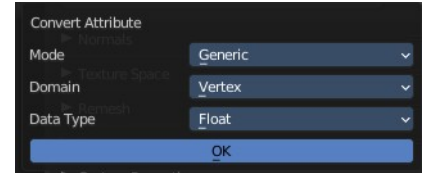

Mode

What kind of attribute the attribute is.

Just the type generic has further settings.

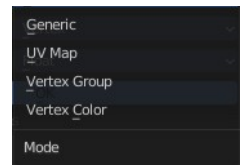

Domain

Just generic. What generic mesh element to affect with the attribute.

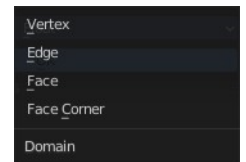

Data Type

Just Generic. What data type to use for the attribute calculation.

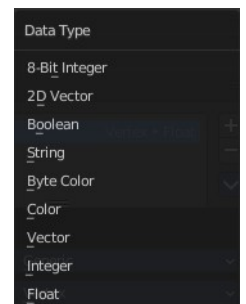

Normals panel

Auto smooth setting. An edge can either be displayed as smooth or sharp. Here you can adjust a threshold value. Below this value an edge will be drawn as sharp. Above this value an edge will be drawn as smooth. This feature requires smooth shading at the mesh.

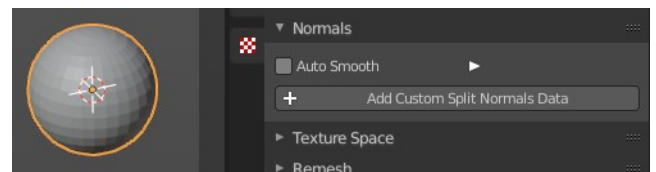

Autosmooth

Activate Autosmooth.

Autosmooth angle

The threshold angle. This angle is just available when there is no custom normals at the mesh.

When your mesh has custom normals then the option is greyed out. And an info text appears why it is greyed out. This can already happen when you import a mesh with normals.

Note that you can still tick and untick the checkbox. It just has no effect anymore.

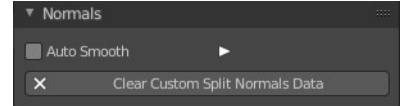
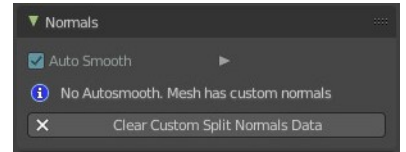

Add / Clear Custom Split Normals Data

Adds a custom split normals data layer, if none exists yet. In case custom normals exists at the mesh, for example because you have marked an edge sharp, then you can remove it here.

Texture Space panel

UV mapping can be generated. A procedural brick texture uses generated UV space for example to define the mapping.

In this panel you can adjust settings of the texture space used by generated texture mapping.

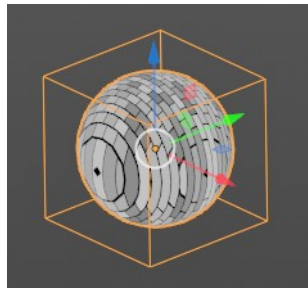
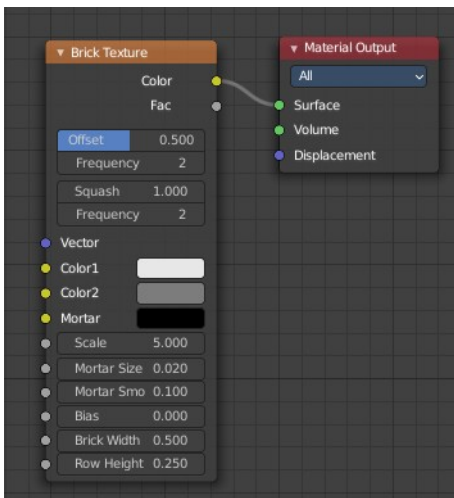
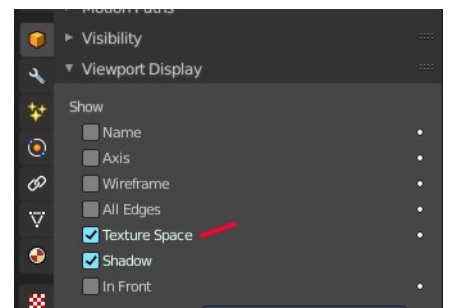
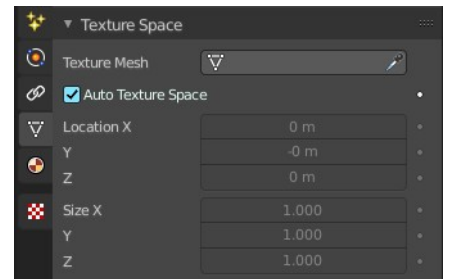

The display of the texture space cage can be activated in the Viewport Display in the Object properties.

Texture Mesh

Use another mesh for texture indices. The vertex of the two objects must be perfectly aligned. Otherwise the UV map will be distorted. Note that, this is only for mesh objects.

Auto Texture Space

Adjusts the active object's texture space automatically when transforming the object.

Location, Size

Adjust the location and size of the texture space manually if Auto Texture Space is off.

The texture space can also be adjusted in the 3D Viewport. See Object Menu / Transform / Move and Scale Texture Space

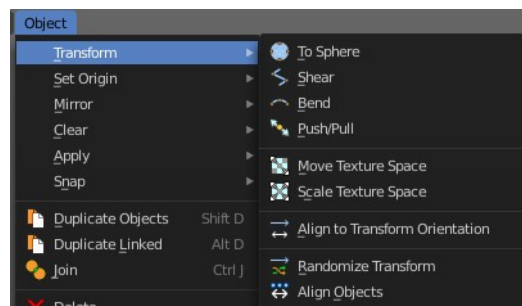

Remesh Panel

You may create a sculpt mesh that has ways too many polygons. Or too many polygons at one area, and not enough polygons at another area. Remeshing recreates the mesh geometry, with a more uniform topology.

You need to turn off Dyntopo to activate the feature.

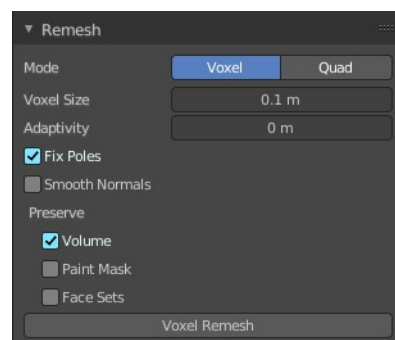

Mode

Use Voxel or Quad Remesher. The Quad remesher has no settings. The following settings are all for the voxel remesher.

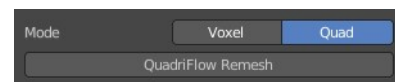

Voxel Size

Adjust the density of the new created geometry.

Adaptivity

Reduces the final face count by simplifying geometry where detail is not needed. This method uses tris. A value greater than 0 disables the Fix Poles feature.

Fix Poles

Produce less poles and a better topology flow.

Smooth Normals

Smooths the normals of the result.

Preserve

Volume

Tries to preserve the volume of the original mesh.

Paint Mask

Keep existing paint masks at the new mesh.

Face Sets

Keep the current face sets at the new created mesh.

Voxel Remesh / QuadriFlow Remesh

Starts the remesher in the chosen method.

Geometry Data panel

Mesh objects can have different types of custom data attached to them. This data is mostly used internally and can be exported by some exporters like Collada or Alembic.

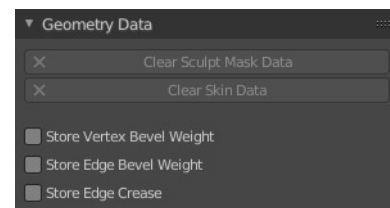

Clear Sculpt-Mask Data

Removes the sculpting mask data layer. It has no big impact, but this can speed up sculpting if the mask is not longer used.

Clear Skin Data

Used to manage the skin data layer which is used by the Skin Modifier. This operator can be needed in case a Skin modifier is created but no skin data exist.

Store Vertex Bevel Weight

Stores the vertex bevel weight so that it is not overwritten by other operations.

Stores Edge Bevel Weight

Stores the Edge bevel weight so that it is not overwritten by other operations.

Store Edge Crease

Stores the Edge Crease so that it is not overwritten by other operations.

Custom Properties Panel

Here you can define custom properties that can be used for scripting.

Here you might also find custom properties from addons or scripts.

Add

Adds a new property.

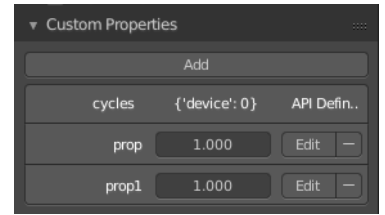

Edit

Opens a panel where you can adjust the settings for the custom property.

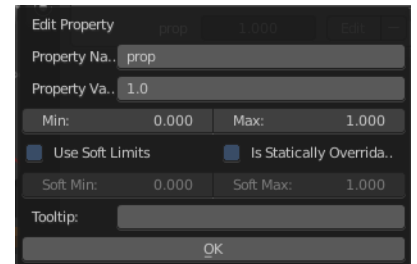

Remove

Removes the property.

26.14.10 Editors - Properties Editor - Object Data Properties Tab - Empty&Image Object

Table of content

Detailed table of content.....	1
Empty panel.....	2
Display As.....	2
Image panel.....	4
Image property.....	4
Source.....	4
Custom Properties Panel.....	7
Add.....	8
Edit.....	8
Remove.....	8

Detailed table of content

Detailed table of content

Detailed table of content.....	1
Empty panel.....	2
Display As.....	2
Size.....	2
Image.....	3
Offset X, Y.....	3
Depth.....	3
Default.....	3
Front.....	3
Back.....	3
Side.....	3
Both.....	3
Front.....	3
Back.....	3
Show in.....	3
Orthographic.....	3
Perspective.....	3
Only Axis Aligned.....	3
Transparency.....	3
Opacity.....	4
Image panel.....	4
Image property.....	4
Image Browser.....	4
Open.....	4
Name.....	4
Fake User.....	4
Open Image.....	4
Source.....	4
Source Type Single Image.....	4
Path edit box.....	4

Pack.....	4
Path edit box.....	5
Open.....	5
Refresh.....	5
Color Space.....	5
Source Type Movie + Image Sequence.....	5
Path edit box.....	5
Pack.....	5
Path edit box.....	5
Open.....	5
Refresh.....	5
Info string.....	6
Frames.....	6
Start.....	6
Offset.....	6
Cyclic.....	6
Auto Refresh.....	6
Color Space.....	6
Source Type Generated.....	6
X / Y.....	6
Float Buffer.....	6
Generated Type Blank.....	6
Color.....	7
Generated Type UV Grid.....	7
Generated Type Color Grid.....	7
Color Space.....	7
Source Type Udim.....	7
Custom Properties Panel.....	7
Add.....	8
Edit.....	8
Remove.....	8

Empty panel

Empties are objects without additional geometry. They do not render. A use case is that you use empties as handlers for a rigged character.

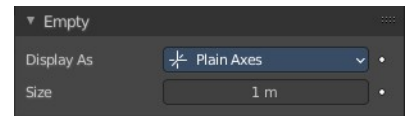

Display As

Empties have graphical elements to display the location. In this drop down list you can choose the shape of this graphical element.

Further display settings can be found in the Object Properties tab in the Viewport Display panel.

Size

The size of the graphical element.

Image

Empties can display images. This images can be used to create reference images to model along. The image is always displayed, independent of the 3D display mode.

Offset X, Y

Offset the image origin. 1.0 represents the width/height of the image.

Depth

Default

Use normal depth behavior.

Front

Always display on top of other objects.

Back

Always display behind of other objects.

Side

Both

Display both the front and back of the empty.

Front

Only display the front of the image.

Back

Only display the back of the image.

Show in

Orthographic

Show in orthographic view.

Perspective

Show in perspective view.

Only Axis Aligned

Only displays the image contents when the view is aligned with the object's local axis.

Transparency

Use alpha blending instead of alpha-test. The image then blends with the background but can have depth sorting artifacts.

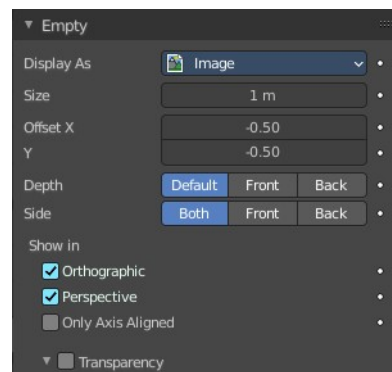

Opacity

The opacity.

Image panel

When you choose an empty of type Image then this panel with further settings appears.

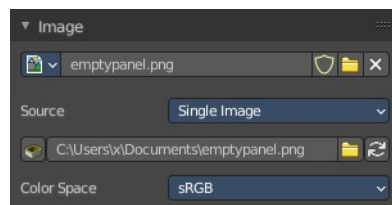
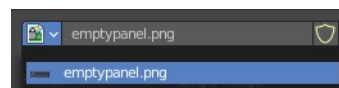

Image property

Image Browser

A list of available images in the scene.



Open

When no image is loaded the open button is displayed. Open an image opens the file browser to load an image.

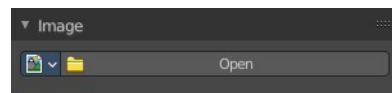

Name

The name of the currently active image.



Fake User

Keep this image in the scene even if it has no user.

Open Image

Open image opens the file browser to load an image.

Source

What image type to choose.

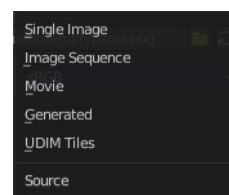

Source Type Single Image

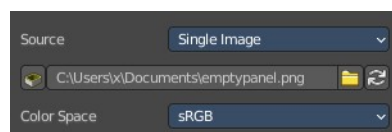

Path edit box

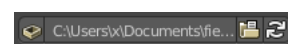

Pack

With this button you can pack the movie or the image sequence into the blend file. It gets packed when you

save the blend file the next time.

Path edit box

See and edit the path to your movie or image sequence files.

Open

Open a new movie or image sequence files. A file dialog will appear.

Refresh

Reread the movie or image sequence files.

Color Space

Choose the color space type for the movie or image sequence files.

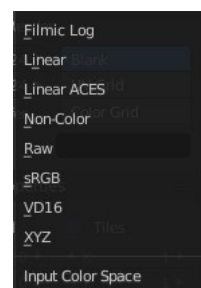

Source Type Movie + Image Sequence

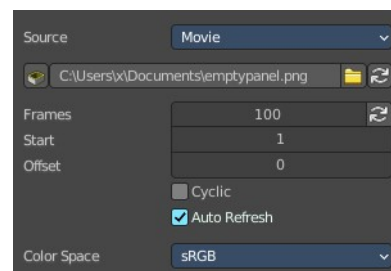
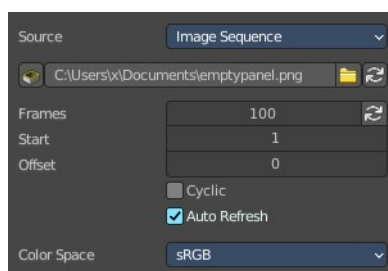

Path edit box



Pack

With this button you can pack the movie or the image sequence into the blend file. It gets packed when you save the blend file the next time.

Path edit box

See and edit the path to your movie or image sequence files.

Open

Open a new movie or image sequence files. A file dialog will appear.

Refresh

Reread the movie or image sequence files.

Info string

Some information about the currently loaded movie. Frames, resolution and color space.

Frames

The number of frames of the movie or image sequence.

Start

The start frame of the movie or image sequence

Offset

Offset the number of the frame to use in the animation. -1 means off.

Cyclic

Cycle the images in the movie.

Auto Refresh

Always refresh image on frame changes.

Color Space

Choose the color space type for the movie or image sequence files.

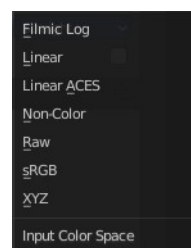

Source Type Generated

X / Y

The image width and height.

Float Buffer

Use a floating point buffer. 8 Bit images uses integers. 32 Bit works with floats.

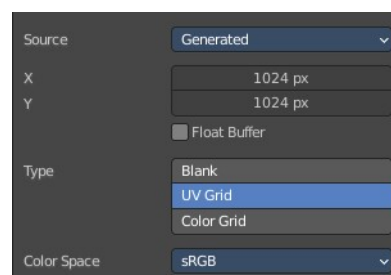

Generated Type Blank

This type displays an image with one blank color.

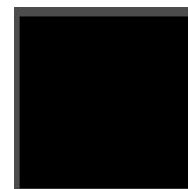

Color

The color of the blank image.

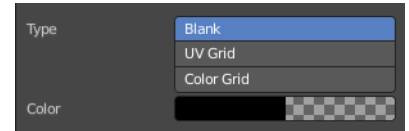

Generated Type UV Grid

This type displays a with a black and white checker texture but colored dots.

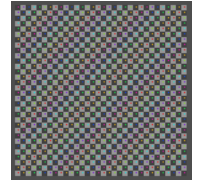

Generated Type Color Grid

This type displays a with a colored checker texture with numbers.



Color Space

Choose the color space type for the image.

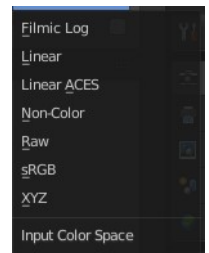

Source Type Udim

UDIM is an enhancement to the UV mapping and texturing workflow. And does not belong here. But in the UV Editor. It is just in the list because it shares the same menus with the UV Editor.



You can load a UDIM file. But it will just display the first tile of the UDIM image. And there is no way to adjust the UDIM settings since they are in the UV Editor, in Edit mode. And Empties have no Edit mode.

Custom Properties Panel

Here you can define custom properties that can be used for scripting.

Here you might also find custom properties from addons or scripts.

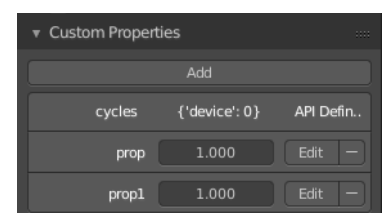

Add

Adds a new property.

Edit

Opens a panel where you can adjust the settings for the custom property.

Remove

Removes the property.

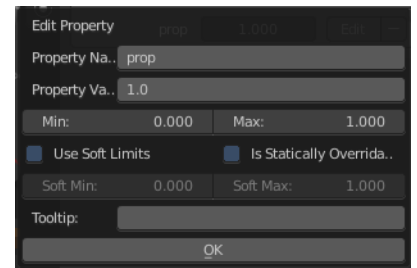

26.14.11 Editors - Properties Editor - Object Data Properties Tab - Sound Object

Table of content

Sound panel.....	1
Sound property.....	1
Data Browser.....	1
Open.....	1
Name.....	2
Fake User.....	2
Open Sound Mono.....	2
Import settings.....	2
Relative Path.....	2
Cache.....	2
Mono.....	2
Remove.....	2
Mute.....	2
Volume.....	2
Pitch.....	2
Distance panel.....	2
Volume Min.....	3
Max.....	3
Attenuation.....	3
Max Distance.....	3
Distance Reference.....	3
Cone panel.....	3
Angle Outer.....	3
Inner.....	3
Outer Cone Volume.....	3
Custom Properties Panel.....	4
Add.....	4
Edit.....	4
Remove.....	4

Sound panel

Sound property

Note that sound files just loads as Mono files.

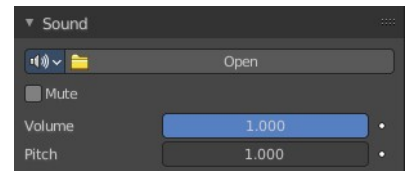

Data Browser

A list of available sounds in the scene.

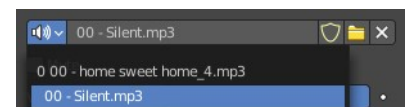

Open

When no sound is loaded the open button is displayed. Open opens the file browser to load an audio file.

Name

The name of the currently active image.

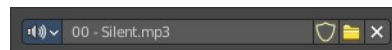

Fake User

Keep this image in the scene even if it has no user.

Open Sound Mono

Open a sound file as mono. You can load stereo files too when you untick Mono in the import settings.

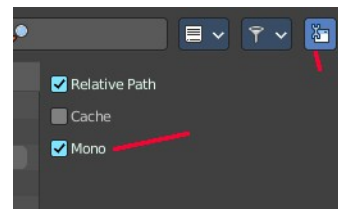

Import settings

Relative Path

Load the file with a relative path.

Cache

The whole sound will be decoded and the raw audio data will be buffered in memory.

Mono

For any 3D audio or panning effects the sound source has to be single channel, otherwise it's assumed that the 3D audio and panning information is already present in the multichannel file. Enable this if you want to use those effects for a file with multiple channels.

Remove

Remove the sound file. Note that the file is not deleted, but removed as the active sound file.

Mute

Toggles whether or not the sound can be heard.

Volume

Adjust the loudness of the sound.

Pitch

Can be used to bend the pitch of the sound to be either deeper or higher. This basically changes the playback speed of the sound which also results in a pitch change.

Distance panel

Distance relevant settings.

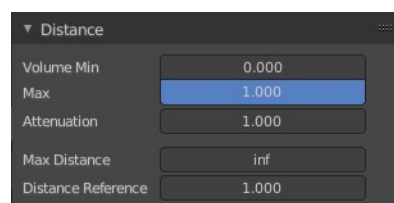

Volume Min

The minimum volume for the farthest distance.

Max

The maximum volume for the closest distance.

Attenuation

How strong the distance affects the volume. This value is dependent of the chosen Distance model in the Scene properties in the Audio panel.

Max Distance

The distance maximum.

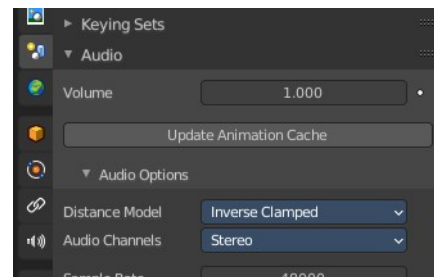

Distance Reference

The distance at which the volume is 100%.

Cone panel

Directionality relevant settings.

There are two cones for an audio source that defines the direction of the sound. An inner and an outer cone. The angles represent their opening angles.

360° mean the cone is fully open and there's no directionality anymore. Inside the inner cone the volume is 100% (1.0), outside the outer cone the volume is, whatever one sets for the outer cone volume and the volume between those two cones, linearly interpolated between this two volumes.

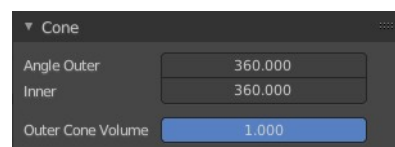

Angle Outer

Angle of the outer cone in degrees. Outside this cone, the volume is equal to the Outer volume.

Inner

Angle of the inner cone in degrees. Inside the cone, the volume is 100%.

Outer Cone Volume

Volume outside the outer cone.

Custom Properties Panel

Here you can define custom properties that can be used for scripting.

Here you might also find custom properties from addons or scripts.

Add

Adds a new property.

Edit

Opens a panel where you can adjust the settings for the custom property.

Remove

Removes the property.

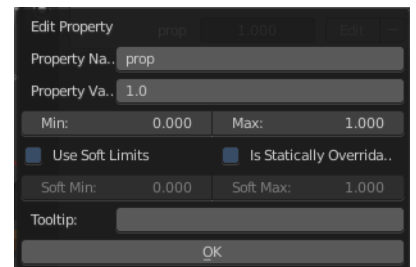
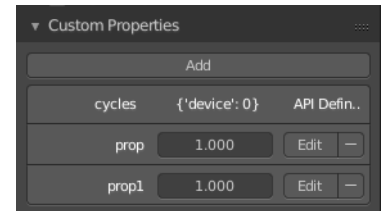

26.14.12 Editors - Properties Editor - Object Data Properties Tab - Camera Object

Table of content

Detailed table of content.....	1
Lens panel.....	5
Type.....	5
Depth of Field panel.....	6
Focus on Object.....	6
Aperture.....	7
Camera panel.....	7
Presets.....	7
Sensor Fit.....	7
Save Areas panel.....	8
Presets.....	9
Title Safe Margins X/Y.....	9
Action Safe Margins X/Y.....	9
Center-Cut Safe Areas.....	9
Background Images panel.....	9
Background Image panel.....	10
Viewport Display panel.....	14
Size.....	14
Show.....	15
Custom Properties Panel.....	17
Add.....	17
Edit.....	17
Remove.....	17

Detailed table of content

Detailed table of content

Detailed table of content.....	1
Lens panel.....	5
Type.....	5
Perspective.....	5
Lens Unit.....	5
Focal Length.....	5
Field of View.....	5
Orthographic.....	5
Orthographic Scale.....	5
Panoramic.....	5
Lens Unit.....	6
Focal Length.....	6
Field of View.....	6
Shift X / Y.....	6
Clip Near and Far.....	6
Depth of Field panel.....	6
Focus on Object.....	6

Focus Distance.....	7
Eyedropper Depth.....	7
Aperture.....	7
F-Stop.....	7
Blades.....	7
Rotation.....	7
Ratio.....	7
Camera panel.....	7
Presets.....	7
Sensor Fit.....	7
Auto.....	8
Size.....	8
Horizontal.....	8
Width.....	8
Vertical.....	8
Height.....	8
Save Areas panel.....	8
Presets.....	9
Title Safe Margins X/Y.....	9
Action Safe Margins X/Y.....	9
Center-Cut Safe Areas.....	9
Center Title Safe Margins X/Y.....	9
Center Action Safe Margins X/Y.....	9
Background Images panel.....	9
Background Image panel.....	10
Header.....	10
Triangle button.....	10
Image / Movie name.....	10
Show Background Image.....	10
Remove Background Image.....	10
Background Source.....	10
Image.....	10
Image Property.....	10
Image Browser.....	10
Image name.....	10
Number of Users.....	10
Fake User.....	10
Open Image.....	10
Remove.....	10
Source Type Single Image.....	11
Path edit box.....	11
Pack.....	11
Path edit box.....	11
Open.....	11
Refresh.....	11
Source Type Movie + Image Sequence.....	11
Path edit box.....	11
Pack.....	11
Path edit box.....	11
Open.....	11
Refresh.....	11
Frames.....	11
Start.....	12

Offset.....	12
Cyclic.....	12
Auto Refresh.....	12
Source Type Generated.....	12
X / Y.....	12
Float Buffer.....	12
Generated Type Blank.....	12
Color.....	12
Generated Type UV Grid.....	12
Generated Type Color Grid.....	12
Source Type UDIM Tile.....	13
Path edit box.....	13
Pack.....	13
Path edit box.....	13
Open.....	13
Refresh.....	13
Movie.....	13
Active Clip.....	13
File Path.....	13
Path edit box.....	13
Open.....	13
Refresh.....	13
Render Undistorted.....	13
Proxy Size.....	13
Color Space.....	14
Opacity.....	14
Depth.....	14
Frame Method.....	14
Stretch.....	14
Offset X/Y.....	14
Rotation.....	14
Scale.....	14
Flip X.....	14
Y.....	14
Viewport Display panel.....	14
Size.....	14
Show.....	15
Limits.....	15
Mist.....	15
Sensor.....	15
Name.....	15
Passepartout.....	15
Alpha.....	15
Composition Guides.....	15
Thirds.....	15
Center.....	16
Center.....	16
Diagonal.....	16
Golden.....	16
Ratio.....	16
Triangle A.....	16
Triangle B.....	16
Harmonious.....	16

Triangle A.....	16
Triangle B.....	16
Custom Properties Panel.....	17
Add.....	17
Edit.....	17
Remove.....	17

Lens panel

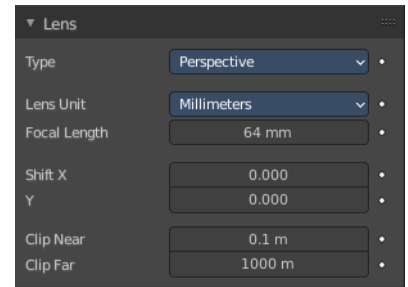

Type

How to display the content in the camera view.

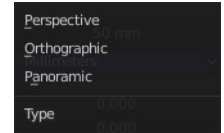

Perspective

Displays the content with perspective distortions.

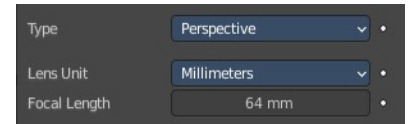

Lens Unit

What lens unit to use. Millimeters or Field of View as an angle.



Focal Length

With Lens Unit Millimeters. The focal length controls the amount of zoom, i.e. the amount of the scene which is visible all at once. Longer focal lengths result in a smaller Field of View (more zoom), while short focal lengths allow you to see more of the scene at once (larger Field of View, less zoom). Focal length is adjusted in millimeters like in a real camera.

Field of View

With Lens Unit Field of View. Field of View is adjusted in degrees. But has the same purpose than Focal Length. Smaller angle means small field of view more zoom. Higher angle means larger field of view and less zoom.

Orthographic

Displays the content in parallel projection.

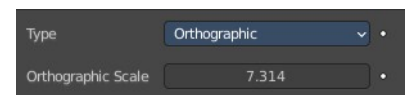

Orthographic Scale

The camera lens angle influences the zoom factor.

Panoramic

Panoramic cameras just works with Cycles. Panoramic allows you to render equirectangular, fish eye and mirror ball images. Note that the result is not displayed in the viewport.



Lens Unit

What lens unit to use. Millimeters or Field of View as an angle.

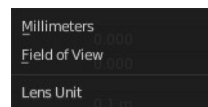

Focal Length

With Lens Unit Millimeters. The focal length controls the amount of zoom, i.e. the amount of the scene which is visible all at once. Longer focal lengths result in a smaller Field of View (more zoom), while short focal lengths allow you to see more of the scene at once (larger Field of View, less zoom). Focal length is adjusted in millimeters like in a real camera.

Field of View

With Lens Unit Field of View. Field of View is adjusted in degrees. But has the same purpose than Focal Length. Smaller angle means small field of view more zoom. Higher angle means larger field of view and less zoom.

Shift X / Y

Allows the adjustment of vanishing points. Vanishing points refer to the positions to which parallel lines converge.

Note! Using lens shift is equivalent to rendering an image with a larger FOV and cropping it off-center.

Clip Near and Far

The closest and farthest distance in which the scene geometry gets displayed. Any objects outside this range still influence the image indirectly. Further light bounces are not clipped. But they are not displayed directly.

Note! For viewport rendering, setting clipping distances to limited values is important to ensure sufficient rasterization precision. Ray tracing renders do not suffer from this issue so much, and as such more extreme values can safely be set.

Tip! When Limits in the Viewport Display panel is enabled, the clip bounds will be visible as two yellow connected dots on the camera's line of sight

Depth of Field panel

Depth of Field is the distance between the nearest and farthest objects that are in an acceptable sharp focus in an image. Objects behind and in front of the focus point are blurred.

The area in focus is called the focal point. It can be set by a value, or by choosing an object, and using the distance between the camera and the object.

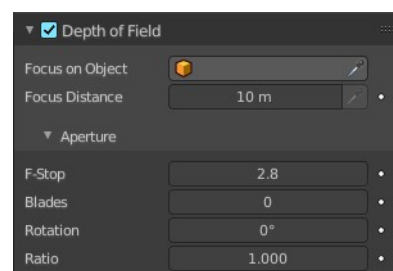

Focus on Object

Pick a focus object.



Focus Distance

The distance to the focal point when no Focus Object is specified.

To display the distance by a yellow cross turn on Limits in the Viewport Display panel.

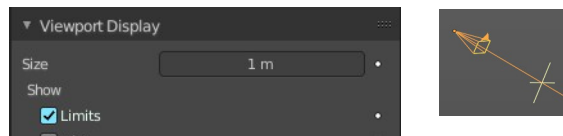

Eyedropper Depth

Attention, crazy design! The Eyedropper Depth button is greyed out and remains not clickable, even when it highlights when you hover over the Focus Distance slider. It is just implemented to show the hotkey and how to call the eyedropper.

You can call a Depth picker by hovering with the mouse over the Focus Distance property and pressing hotkey E. Then click on a point in the 3D Viewport to sample the distance from that point to the camera.

Aperture

F-Stop

Defines the amount of blurring. Lower values give a strong depth of field effect.

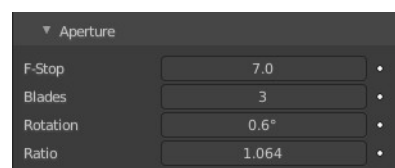

Blades

Total number of polygonal blades used to alter the shape of the blurred objects in the render, and render preview. As with the viewport, the minimum amount of blades to enable the bokeh effect is 3, resulting in a triangular-shaped blur.

Rotation

Rotate the polygonal blades along the facing axis, and will rotate in a clockwise, and counter-clockwise fashion.

Ratio

Change the amount of distortion to simulate the anamorphic bokeh effect. A setting of 1.0 shows no distortion, where a number below 1.0 will cause a horizontal distortion, and a higher number will cause a vertical distortion.

Camera panel

Presets

Camera presets. To add a new preset enter a name and click the + button. To remove a preset click at the minus button besides the name.

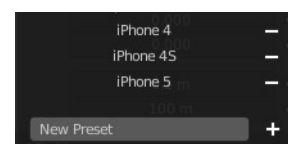
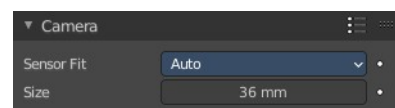

Sensor Fit

The method to fit image and field of view angle inside the sensor.

Auto

Fit to the sensor width or height depending on image resolution.

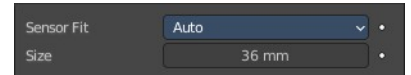

Size

The focal length.

Horizontal

Fit to the sensor width. Height cannot be modified.

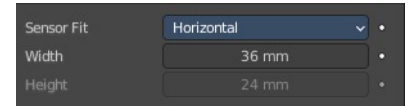

Width

The focal width.

Vertical

Fit to the sensor height. Width cannot be modified.

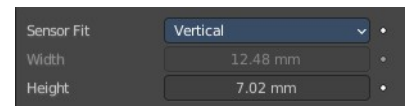

Height

The focal height.

Save Areas panel

Modern LCD or plasma monitors usually doesn't have over scan areas anymore. But especially older TV screens still may have varying amounts of over scan. And cuts quite a bit content away at the border. And so not all content is shown at all monitors. Safe areas is the area that is always visible at all hardware.

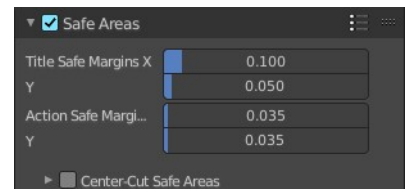

Safe areas are guides to ensure that the most important parts of the content can be seen across all screens. The lines are unfortunately a bit hard to see when you are in camera view. They mark the safe areas.

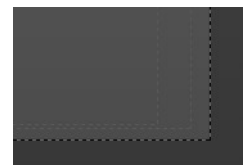

Safe areas can be set from the Camera and Sequencer views.

Tip! Each country sets a legal standard for broadcasting. These include also specific values for safe areas. Bforartists defaults for safe areas follow the EBU (European Union) standard. Make sure you are using the correct values when working for broadcast to avoid any trouble.

Presets

Safe areas presets. To add a preset enter a name and click at the plus button. To remove a preset click at the minus button besides the preset name.



Title Safe Margins X/Y

Also known as Graphics Safe. Information (graphics or text) inside this area can be seen by the majority of viewers.

Action Safe Margins X/Y

An extra “margin” for the screen, which can be used to keep elements from piling up against the edges.

Center-Cut Safe Areas

Center-cuts are a second set of safe areas to ensure content is seen correctly on screens with a different aspect ratio. Old TV sets receiving 16:9 or 21:9 video will cut off the sides. Position content inside the center-cut areas to make sure the most important elements of your composition can still be visible in these screens.



Center Title Safe Margins X/Y

Information (graphics or text) inside this area can be seen by the majority of viewers.

Center Action Safe Margins X/Y

An extra “margin” for the screen, which can be used to keep elements from piling up against the edges.

Background Images panel

Add a background image or movie to the camera.

You can add more than one image or movie. The content can be offset and the opacity can be changed.

Note that an image that is added here does not render. It just displays in the viewport background.

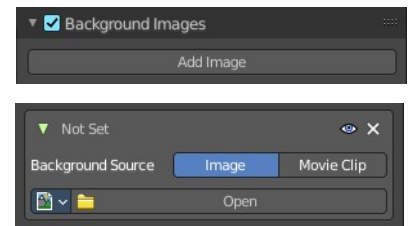

To render the background image too you need to add it in a compositing step. Or in the Shading tab add the image in the World shader. Use Window as the mapping vector.

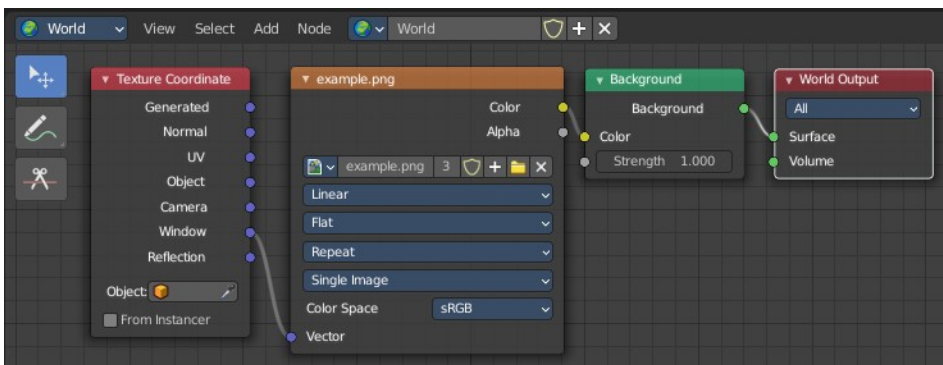

Background Image panel

Header

Triangle button

Expand or collapse the panel.

Image / Movie name

The name of the loaded movie or image. When there is no image loaded then the text is Not Set.

Show Background Image

Display the image in the viewport when you are in camera view.

Remove Background Image

Remove the background image.

Background Source

What type to display. Image or Movie.

Image

Image Property

Image Browser

Browse the available images.

Image name

The name of the image.

Number of Users

The number of users for this image.

Fake User

Keep this image in the scene even if it has no users.

Open Image

Opens a file browser where you can load an image.

Remove

Removes this image as the active image. Note that the image is still available in the image browser.

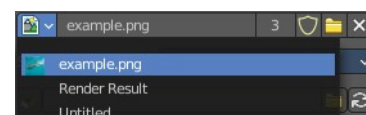
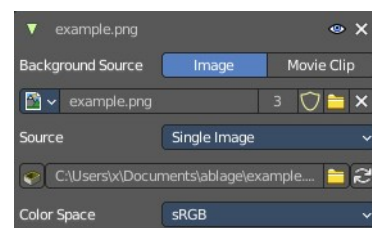

Source Type Single Image

Path edit box

Pack

With this button you can pack the movie or the image sequence into the blend file. It gets packed when you save the blend file the next time.

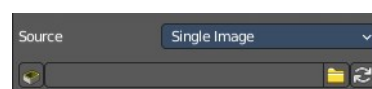

Path edit box

See and edit the path to your movie or image sequence files.

Open

Open a new movie or image sequence files. A file dialog will appear.

Refresh

Reread the movie or image sequence files.

Source Type Movie + Image Sequence

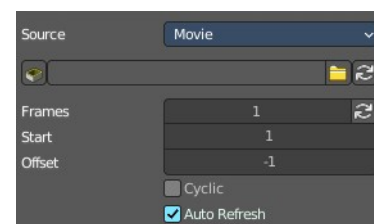
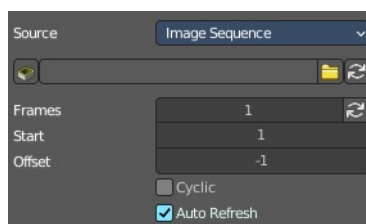

Path edit box



Pack

With this button you can pack the movie or the image sequence into the blend file. It gets packed when you save the blend file the next time.

Path edit box

See and edit the path to your movie or image sequence files.

Open

Open a new movie or image sequence files. A file dialog will appear.

Refresh

Reread the movie or image sequence files.

Frames

The number of frames of the movie or image sequence.

Start

The start frame of the movie or image sequence

Offset

Offset the number of the frame to use in the animation. -1 means off.

Cyclic

Cycle the images in the movie.

Auto Refresh

Always refresh image on frame changes.

Source Type Generated

X / Y

The image width and height.

Float Buffer

Use a floating point buffer. 8 Bit images uses integers. 32 Bit works with floats.

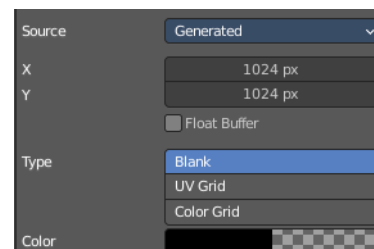

Generated Type Blank

This type displays an image with one blank color

Color

The color of the blank image.

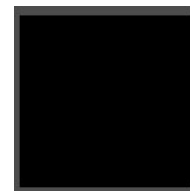

Generated Type UV Grid

This type displays a with a black and white checker texture but colored dots.



Generated Type Color Grid

This type displays a with a colored checker texture with numbers.

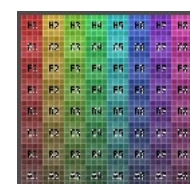

Source Type UDIM Tile

UDIM tiles is a way to deal with several textures in different resolution as one texture. Other software like Substance Painter also works with UDIM textures.

Note that you need to have a fitting numbers of UDIM tiles in the UDIM tiles

panel. Or not all UDIM textures will be loaded. Which is impossible to set up from here. UDIM setup happens in UV Editor in Edit mode. It will just load the first tile of the Udim texture.



Path edit box

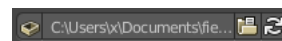

Pack

With this button you can pack the movie or the image sequence into the blend file. It gets packed when you save the blend file the next time.

Path edit box

See and edit the path to your movie or image sequence files.

Open

Open a new movie or image sequence files. A file dialog will appear.

Refresh

Reread the file.

Movie

Active Clip

Use the movie clip from the active camera instead of a loaded one.

File Path

Path edit box

See and edit the path to your movie or image sequence files.

Open

Open a new movie or image sequence files. A file dialog will appear.

Refresh

Reread the movie or image sequence files.

Render Undistorted

Render Preview using undistorted proxy material.

Proxy Size

This setting defines which proxy image resolution is used for display in the viewport. If there is no generated proxies, then the render size is set to "No proxy, full render"

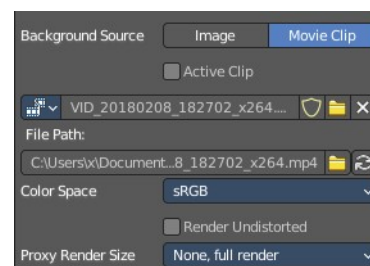

Color Space

Choose the color space type for the movie or image sequence files.

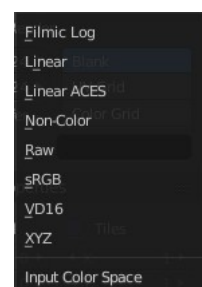

Opacity

The transparency of the background image or movie.

Depth

Choose whether the image is shown behind all objects, or in front of everything.

Frame Method

Controls how the image is placed in the camera view.

Stretch

Forces the image dimensions to match the camera bounds (may alter the aspect ratio).

Offset X/Y

Positions the background image using these offsets.

In orthographic views the values are measured in the normal scene units. In the camera view the values are measured relative to the camera bounds (0.1 will offset it by 10% of the view width/height).

Rotation

Rotates the image around its center.

Scale

Scales the image up or down from its center.

Flip X

Swaps the image around, such that the left side is now on the right, and the right now on the left.

Y

Swaps the image around, such that the top side is now on the bottom, and the bottom now on the top.

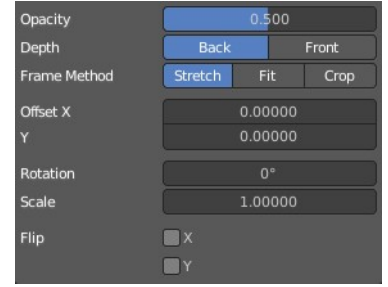

Viewport Display panel

Viewport display settings.

Size

Size of the camera visualization in the 3D Viewport. This setting has no effect on the render output of a camera.

Show

Limits

Shows a line which indicates Start and End Clipping values. Displays also the depth of field focus point.

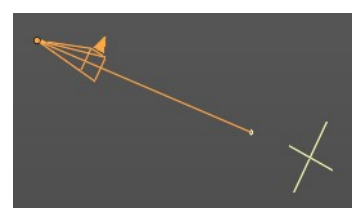
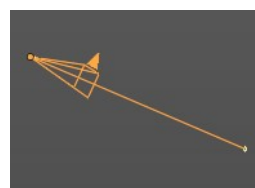
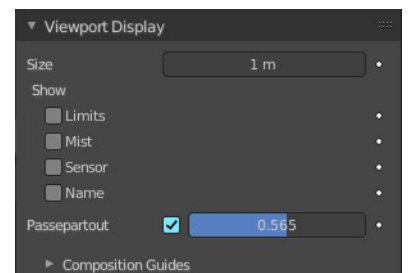

Mist

Toggles viewing of the mist limits on and off. The limits are shown as two connected white dots on the camera line of sight. The mist limits and other options are set in the World panel, in the Mist section.

To activate the Mist panel you first have to activate the Mist pass in the View layer properties.

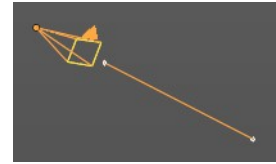
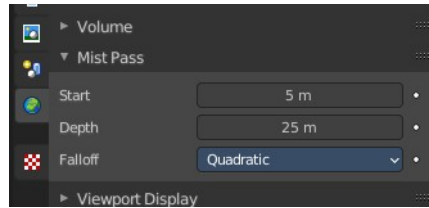
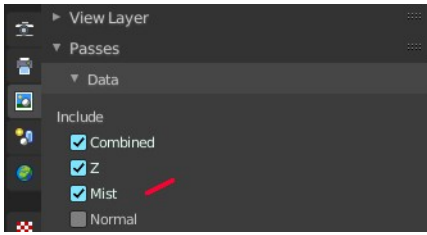

Sensor

Displays a dotted frame for the sensor size (film gate) in the camera view. The sensor size can be adjusted in the camera panel. It is fixed for the method Auto.

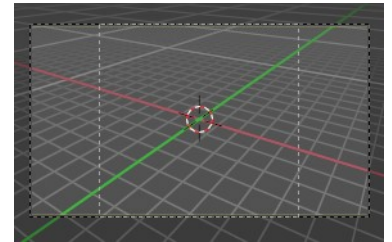
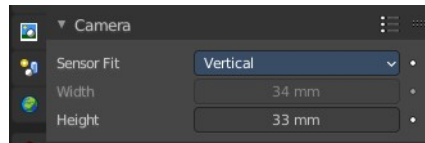

Name

Display the name of the camera down left in the passepout.

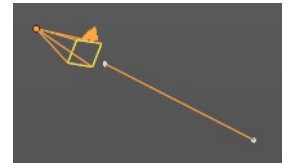

Passepartout

This option darkens the area outside of the camera's field of view.

Alpha

Controls the transparency of the passepout mask.

Composition Guides

Composition Guides enable overlays onto the camera display that can help when framing a shot.

Thirds

Adds lines dividing the frame in thirds vertically and horizontally.

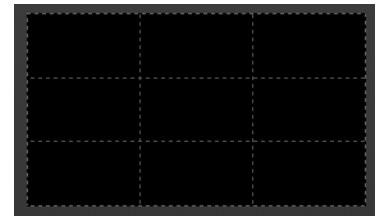

Center

Adds lines dividing the frame in half vertically and horizontally.

Center



Diagonal

Adds lines connecting opposite corners.

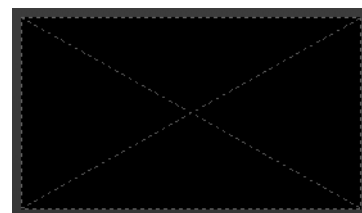

Golden

Ratio

Divides the width and height into Golden proportions (about 0.618 of the size from all sides of the frame).

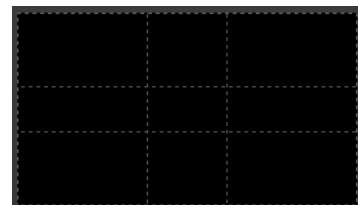

Triangle A

Displays a diagonal line from the lower left to upper right corners, then adds perpendicular lines that pass through the top left and bottom right corners.

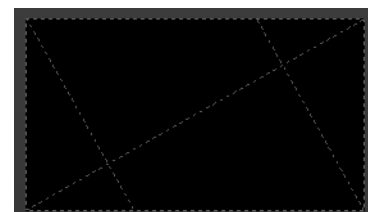

Triangle B

Same as A, but with the opposite corners.

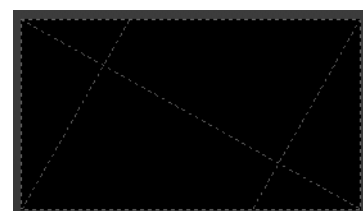

Harmonious

Triangle A

Displays a diagonal line from the lower left to upper right corners, then lines from the top left and bottom right corners to 0.618 the lengths of the opposite side.

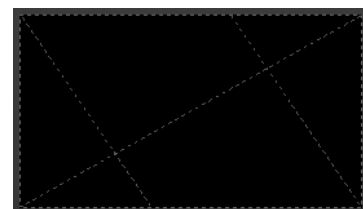

Triangle B

Same as A, but with the opposite corners.

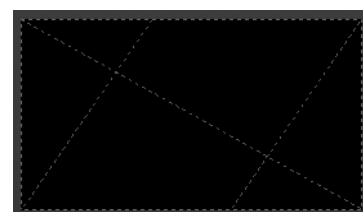

Custom Properties Panel

Here you can define custom properties that can be used for scripting.

Here you might also find custom properties from addons or scripts.

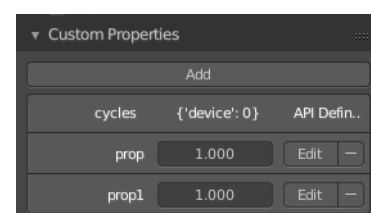

Add

Adds a new property.

Edit

Opens a panel where you can adjust the settings for the custom property.

Remove

Removes the property.

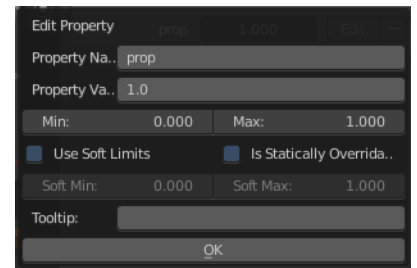



26.14.13 Editors - Properties Editor - Object Data Properties Tab - Light Object

Table of content

Preview panel.....	3
Light panel.....	3
Point Light Eevee.....	3
Color.....	3
Power.....	3
Diffuse.....	3
Specular.....	3
Volume.....	4
Radius.....	4
Custom Distance.....	4
Distance.....	4
Point Light Cycles.....	4
Color.....	4
Power.....	4
Radius.....	4
Max Bounces.....	4
Cast Shadow.....	4
Multiple Importance.....	4
Sun Light Eevee.....	5
Color.....	5
Strength.....	5
Diffuse.....	5
Specular.....	5
Volume.....	5
Angle.....	5
Sun Light Cycles.....	5
Color.....	5
Strength.....	5
Angle.....	5
Max Bounces.....	5
Cast Shadow.....	5
Multiple Importance.....	6
Spot Light Eevee.....	6
Color.....	6
Power.....	6
Diffuse.....	6
Specular.....	6
Volume.....	6
Radius.....	6
Custom Distance.....	6
Distance.....	6
Spot shape.....	6
Size.....	6
Blend.....	7
Show cone.....	7

Spot Light Cycles.....	7
Color.....	7
Power.....	7
Radius.....	7
Max Bounces.....	7
Cast Shadow.....	7
Multiple Importance.....	7
Beam shape.....	7
Size.....	7
Blend.....	8
Show cone.....	8
Area Light Eevee.....	8
Color.....	8
Power.....	8
Diffuse.....	8
Specular.....	8
Volume.....	8
Shape.....	8
Size.....	8
Custom Distance.....	8
Distance.....	9
Area Light Cycles.....	9
Color.....	9
Power.....	9
Shape.....	9
Size.....	9
Max Bounces.....	9
Custom Distance.....	9
Distance.....	9
Cast Shadow.....	9
Multiple Importance.....	9
Portal.....	10
Beam Shape Subpanel.....	10
Spread.....	10
Light panel.....	10
Clip Start.....	10
Bias.....	10
Cascaded Shadow Map.....	10
Count.....	10
Fade.....	10
Max Distance.....	11
Distribution.....	11
Contact Shadows.....	11
Distance.....	11
Bias.....	11
Thickness.....	11
Light panel - Spot Shape subpanel.....	11
Size.....	11
Blend.....	11
Show cone.....	11
Nodes panel.....	12
Use Nodes.....	12
Custom Properties Panel.....	12

Add.....12
 Edit.....12
 Remove.....12

Preview panel

Provides a preview window for the light.

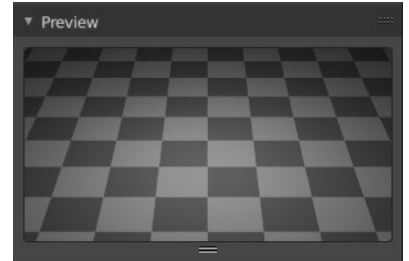

Light panel

The light panel contains the settings for the different light types. Color, strength, and so on.

The content differs, depend and of the chosen renderer. Workbench has no settings here. So we just cover the panel content with Eevee and Cycles.

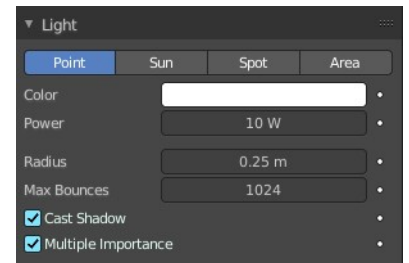
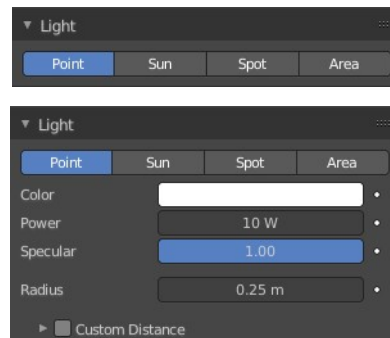

Some props can be animated by setting a keyframe with the Animate Property button behind.

Point Light Eevee

The light emits from a point, and has falloff.

Color

The color of the light. Clicking at the color field will open a color picker.

Power

Power of the light in Watts. Higher values increase the intensity of the light. Negative values can be set, but should be avoided for predictable and physically based result.

Diffuse

Diffuse Reflection multiplier.

Specular

Specular Light intensity multiplier.

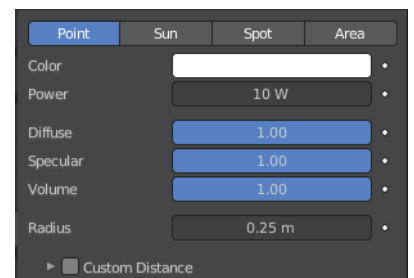

Volume

Volume Light multiplier.

Radius

When larger than zero, light will be emitted from a spherical surfaces with the specified radius. Lights with larger size have softer shadows and specular highlights.

Custom Distance

Eevee Renderer. If enabled uses Distance as the custom attenuation distance instead of global light threshold. In order to avoid long setup times, this distance is first computed automatically based on a light threshold. The distance is computed at the light origin and using the inverse square falloff.

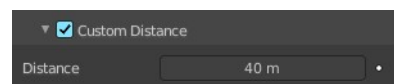

Distance

The distance where light influence will be set to 0.

Point Light Cycles

The light emits from a point, and has falloff.

Color

The color of the light. Clicking at the color field will open a color picker.

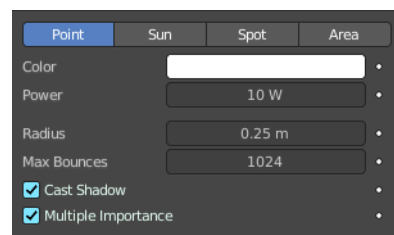

Power

Power of the light in Watts. Higher values increase the intensity of the light. Negative values can be set, but should be avoided for predictable and physically based result.

Radius

When larger than zero, light will be emitted from a spherical surfaces with the specified radius. Lights with larger size have softer shadows and specular highlights.

Max Bounces

Cycles renderer. Maximum number of times light from the light is allowed to bounce. Limited by scene-wide bounce settings.

Cast Shadow

Light casts shadow.

Multiple Importance

Multiple importance sampling reduces noise for area lights and sharp glossy materials.

Sun Light Eevee

The light has no falloff, and goes into one direction.

Color

The color of the light. Clicking at the color field will open a color picker.

Strength

Strength of the light in Watts per square meter.

Diffuse

Diffuse Reflection multiplier.

Specular

Specular Light intensity multiplier.

Volume

Volume Light multiplier.

Angle

The size of the sun light according to its angular diameter as seen from earth.

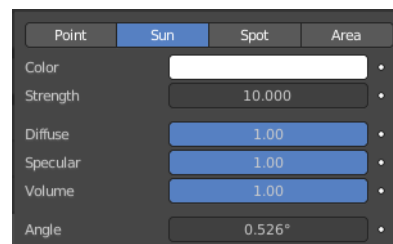

Sun Light Cycles

The light has no falloff, and goes into one direction.

Color

The color of the light. Clicking at the color field will open a color picker.

Strength

Strength of the light in Watts per square meter.

Angle

The size of the sun light according to its angular diameter as seen from earth.

Max Bounces

Cycles renderer. Maximum number of times light from the light is allowed to bounce. Limited by scene-wide bounce settings.

Cast Shadow

Light casts shadow.

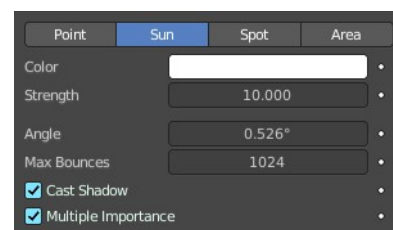

Multiple Importance

Multiple importance sampling reduces noise for area lights and sharp glossy materials.

Spot Light Eevee

The light has falloff. And gets distributed in a cone shape.

Color

The color of the light. Clicking at the color field will open a color picker.

Power

Strength of the light in Watts per square meter.

Diffuse

Diffuse Reflection multiplier.

Specular

Specular Light intensity multiplier.

Volume

Volume Light multiplier.

Radius

When larger than zero, light will be emitted from a spherical surfaces with the specified radius. Lights with larger size have softer shadows and specular highlights.

Custom Distance

Eevee Renderer. If enabled uses Distance as the custom attenuation distance instead of global light threshold. In order to avoid long setup times, this distance is first computed automatically based on a light threshold. The distance is computed at the light origin and using the inverse square falloff.

Distance

The distance where light influence will be set to 0.

Spot shape

Eevee renderer.

Size

The size of the outer cone of a spot.

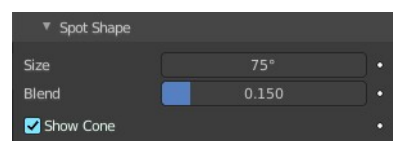
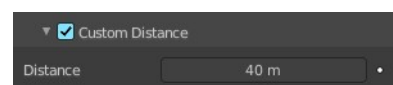
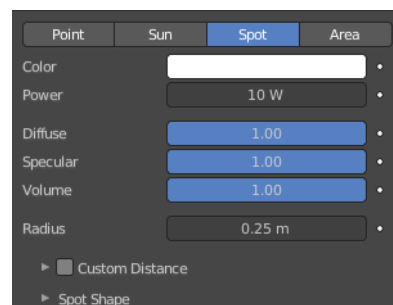

Blend

Blending to the inner cone of a spot. The inner cone boundary line indicates the point at which light from the Spot will start to blur/soften.

Show cone

Shows the cone opaque in the 3D view

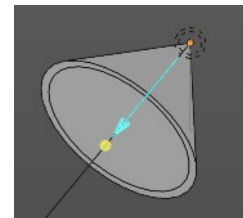

Spot Light Cycles

The light has falloff. And gets distributed in a cone shape.

Color

The color of the light. Clicking at the color field will open a color picker.

Power

Strength of the light in Watts per square meter.

Radius

When larger than zero, light will be emitted from a spherical surfaces with the specified radius. Lights with larger size have softer shadows and specular highlights.

Max Bounces

Maximum number of times light from the light is allowed to bounce. Limited by scene-wide bounce settings.

Cast Shadow

Light casts shadow.

Multiple Importance

Multiple importance sampling reduces noise for area lights and sharp glossy materials.

Beam shape

Eevee renderer.

Size

The size of the outer cone of a spot.

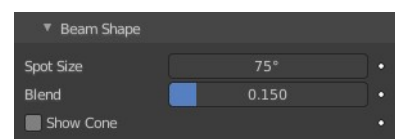
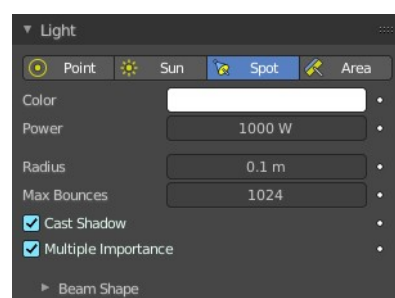

Blend

Blending to the inner cone of a spot. The inner cone boundary line indicates the point at which light from the Spot will start to blur/soften.

Show cone

Shows the cone opaque in the 3D view

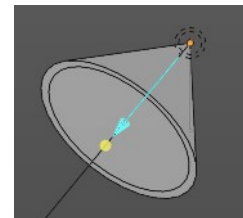

Area Light Eevee

The light emits from a surface, and has falloff.

Color

The color of the light. Clicking at the color field will open a color picker.

Power

Power of the light in Watts. Higher values increase the intensity of the light.

Negative values can be set, but should be avoided for predictable and physically based result.

Diffuse

Diffuse Reflection multiplier.

Specular

Specular Light intensity multiplier.

Volume

Volume Light multiplier.

Shape

The shape of the light emitting surface.

Size

The size of the light emitting surface.

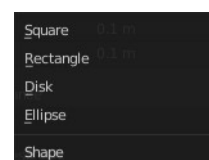
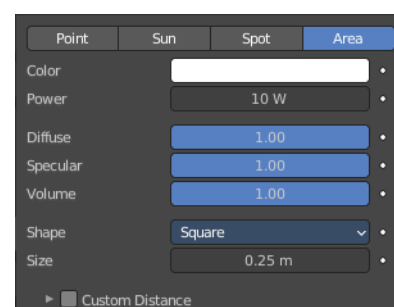

Custom Distance

Eevee Renderer. If enabled uses Distance as the custom attenuation distance instead of global light threshold. In order to avoid long setup times, this distance is first computed automatically based on a light threshold. The

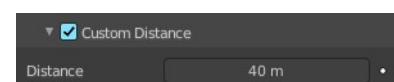

distance is computed at the light origin and using the inverse square falloff.

Distance

The distance where light influence will be set to 0.

Area Light Cycles

The light emits from a surface, and has falloff.

Color

The color of the light. Clicking at the color field will open a color picker.

Power

Power of the light in Watts. Higher values increase the intensity of the light. Negative values can be set, but should be avoided for predictable and physically based result.

Shape

The shape of the light emitting surface.

Size

The size of the light emitting surface.

Max Bounces

Cycles renderer. Maximum number of times light from the light is allowed to bounce. Limited by scene-wide bounce settings.

Custom Distance

Eevee Renderer. If enabled uses Distance as the custom attenuation distance instead of global light threshold. In order to avoid long setup times, this distance is first computed automatically based on a light threshold. The distance is computed at the light origin and using the inverse square falloff.

Distance

The distance where light influence will be set to 0.

Cast Shadow

Cycles renderer. The light source casts a shadow.

Multiple Importance

Cycles renderer. By default lights use only direct light sampling. Which can be noisy with sharp glossy

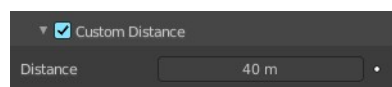
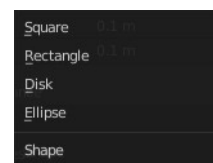
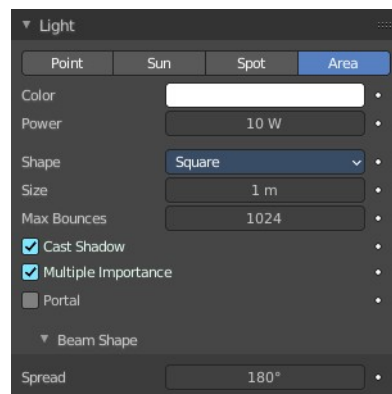

reflections. Multiple Importance activates Indirect light sampling to reduce noise.

Portal

With Cycles Area lights can also function as light portals to help sample the environment light. This can significantly reduce noise in interior scenes. Light portals are not helpful for outdoor scenes. Since outdoor the light bounces just fly off into the sky.

Using the light as portal hides it.

Beam Shape Subpanel

Spread

How widely the emitted light fans out.



Light panel

Eevee renderer shadow settings. Eevee is a realtime renderer. And in Eevee shadows are done with shadow maps.

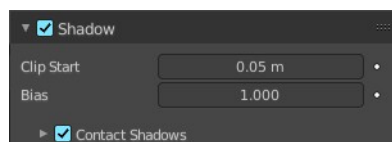

Clip Start

Shadow clip start distance. A distance below will not generate a shadow.

Bias

The bias to reduce self shadowing.

Cascaded Shadow Map

Sun light only. Shadow large scenes by distributing multiple shadow maps over the frustum range. Each cascade covers a different portion of the view frustum. Note that cascade shadow maps are always updated because they are view dependent.

Note! In orthographic view the cascades cover the whole depth range of the camera with an evenly distributed shadow precision.

Count

Number of cascades to use. More cascades means better precision but a lower update rate.

Fade

Fade transition area between two cascades. Higher values means less overall resolution because cascades need to overlap.

Max Distance

Distance away from the view origin (or camera origin if in camera view) to cover by the cascade. If the view far clip distance is lower than Max Distance, the view far clip distance will be used. Only works in perspective view.

Distribution

Puts more resolution towards the near clip plane. Only works in perspective view.

Contact Shadows

Contact shadows exists to fix light leaking caused by bias or shadow map undersampling. The same limitations applies like for screen space reflections. Unknown object thickness and effect disappearing at screen edges.

Tip! Keep the distance of contact shadows small. They are not accurate enough to shadow the entire scene.

Distance

World space distance in which to search for screen space occluder.

Bias

Bias applied to the ray tracing to reduce self-shadowing artifacts.

Thickness

Pixel thickness used to detect occlusion, treating any potential occluder as this thick.

Light panel - Spot Shape subpanel

Size

The size of the outer cone of a spot.

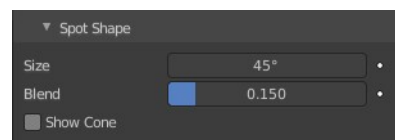

Blend

Blending to the inner cone of a spot. The inner cone boundary line indicates the point at which light from the Spot will start to blur/soften.

Show cone

Shows the cone opaque in the 3D view.

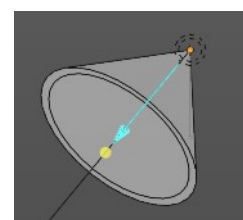

Nodes panel

Use Nodes

Use nodes for the light setup. Creates the standard nodes for an emission light. Which can be found in the Node editor then. Once activated the Nodes panel shows the content of the emission node.

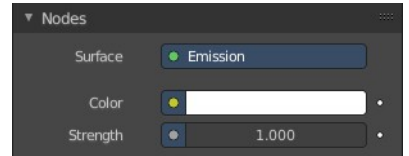
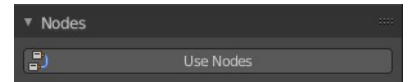
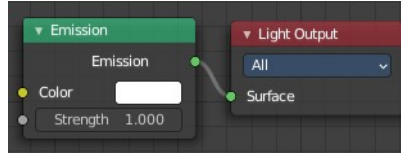

To revert, and not to use nodes, untick the Use Nodes checkbox in the node editor.

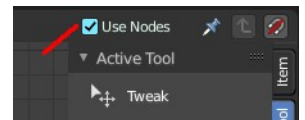

Custom Properties Panel

Here you can define custom properties that can be used for scripting.

Here you might also find custom properties from addons or scripts.

Add

Adds a new property.

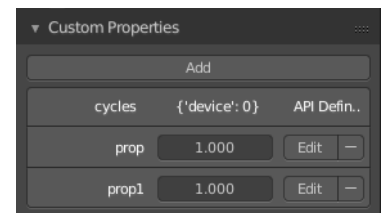

Edit

Opens a panel where you can adjust the settings for the custom property.

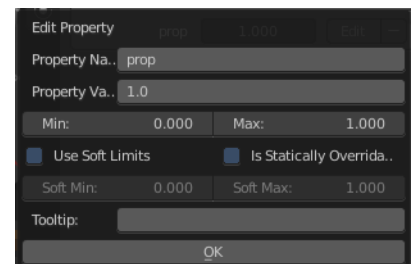

Remove

Removes the property.

26.14.14 Editors - Properties Editor - Object Data Properties Tab - Light Probe Object

Table of content

Light Probes.....	2
Reflection Cubemap.....	2
Reflection Plane.....	2
Irradiance Volume.....	2
Probe panel.....	2
Reflection Cubemap.....	2
Type.....	2
Radius.....	2
Falloff.....	3
Intensity.....	3
Clipping Start / End.....	3
Visibility.....	3
Visibility Collection.....	3
Reflection Plane.....	3
Distance.....	3
Falloff.....	3
Visibility.....	3
Visibility Collection.....	3
Irradiance Volume.....	4
Distance.....	4
Falloff.....	4
Intensity.....	4
Resolution X / Y / Z.....	4
Clipping Start / End.....	4
Visibility.....	4
Bias.....	5
Bleed Bias.....	5
Blur.....	5
Visibility Collection.....	5
Custom Parallax panel.....	5
Type.....	5
Radius.....	5
Viewport Display panel.....	5
Reflection Cubemap.....	6
Influence.....	6
Clipping.....	6
Parallax.....	6
Reflection Plane.....	6
Arrow Size.....	6
Influence.....	6
Show Preview Plane.....	6
Irradiance Volume.....	6
Influence.....	6
Clipping.....	6
Custom Properties Panel.....	6

Add.....	7
Edit.....	7
Remove.....	7

Light Probes

Probe objects are just useful for Eevee. Working with Light probes is a real time render technique. The light gets precalculated into a light probe object. And then used to light the scene indirectly.

There are three different probe types. Reflection Cubemap and Reflection plane is meant for specular lighting. Irradiance Volume for diffuse lighting.

To work with the light probes you need to bake them. Baking lightprobes happens in the render properties tab in the indirect lighting panel.

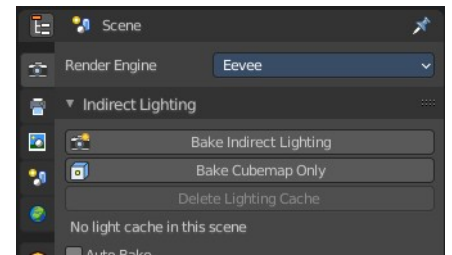

Reflection Cubemap

Adds a reflective light probe in cubemap shape.

Reflection Plane

Adds a reflective light probe in plane shape.

Irradiance Volume

Adds a volumetric array light probe.

Probe panel

Reflection Cubemap

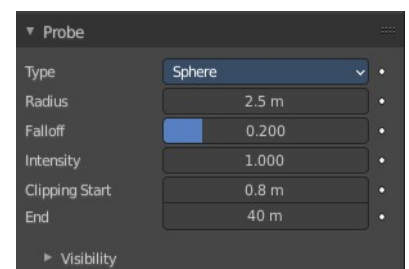

Type

The type of the influence volume.



Radius

A probe object only influences the lighting of nearby surfaces. This influence zone is defined by the Distance parameter and object scaling. The influence distance varies a bit, depending on the probe type.

For Reflection Cubemaps the influence volume can either be a box or a sphere centered on the probe's origin.

Falloff

Percentage of the influence distance during which the influence of a probe fades linearly.

Intensity

Intensity factor of the recorded lighting. Making this parameter anything other than 1.0 is not physically correct. Use it for tweaking or artistic purposes.

Clipping Start / End

Define the near and far clip distances when capturing the scene.

Visibility

Visibility Collection

Sometimes, it is useful to limit which objects appear in the light probe's captured lighting. For instance, an object that is too close to a capture point might be better excluded. This is what the visibility collection does. Only objects that are in this collection will be visible when this probe will capture the scene.

There is also an option to invert this behavior and effectively hide the objects inside this collection.

Note! This is only a filtering option. That means if an object is not visible at render time it won't be visible during the probe render.



Reflection Plane

Distance

A probe object only influences the lighting of nearby surfaces. This influence zone is defined by the Distance parameter and object scaling. The influence distance varies a bit, depending on the probe type.

For Reflection Planes the influence distance is the distance from the plane. Only surfaces whose normals are aligned with the Reflection Plane will receive the captured reflection.

Falloff

Percentage of the influence distance during which the influence of a probe fades linearly. Also defines how much shading normals needs to be aligned with the plane to receive reflections.

Clipping Offset

Define how much below the plane the near clip is when capturing the scene. Increasing this can fix reflection contact problems.

Visibility

Visibility Collection

In some cases, it is useful to limit which objects appear in the light probe's captured lighting. For instance, an

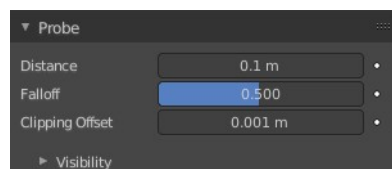

object that is too close to a capture point might be better excluded. This is what the visibility collection does. Only objects that are in this collection will be visible when this probe will capture the scene.

There is also an option to invert this behavior and effectively hide the objects inside this collection.

Note! This is only a filtering option. That means that if an object is not visible at render time it won't be visible during the probe render.

Note! Due to a limitation, dupli-objects cannot be hidden by using this option.

Irradiance Volume

Distance

A probe object only influences the lighting of nearby surfaces. This influence zone is defined by the Distance parameter and object scaling. The influence distance varies a bit, depending on the probe type.

For Irradiance Volumes, the influence inside the volume is always 100%. The influence decays only outside of the volume until the distance to the volume reaches the Distance parameter value (in local space).

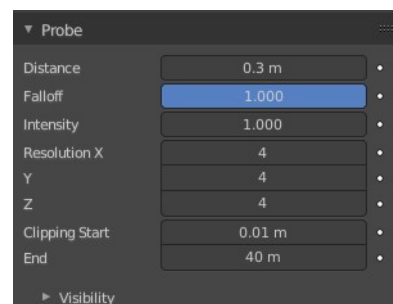

Falloff

Percentage of the influence distance during which the influence of a probe fades linearly.

Intensity

Intensity factor of the recorded lighting. Making this parameter anything other than 1.0 is not physically correct. Use it for tweaking or artistic purposes.

Resolution X / Y / Z

Spatial resolution for Irradiance Volumes is determined per probe. The local volume is divided into a regular grid of the specified dimensions. One irradiance sample will be computed for each cell in this grid.

Clipping Start / End

Defines the near and far clip distances when capturing the scene.

Warning! Clipping distances are applied at the samples positions and not at the grid origin.

Visibility

For every grid point a small Variance Shadow Map is rendered. This visibility cubemap is used to reduce light leaking behind occluders. You can tweak the size of this map inside the render settings and tweak the bias and blur factors per grid inside the Probe Properties tab.

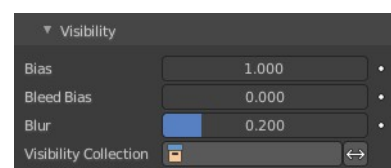

Bias

Reduces self-shadowing.

Bleed Bias

Increases the “contrast” of the depth test result.

Blur

Amount of blur to apply when filtering the visibility shadow map. Does not increase runtime cost but has a small effect on baking time.

Visibility Collection

In some cases, it is useful to limit which objects appear in the light probe’s captured lighting. For instance, an object that is too close to a capture point might be better excluded. This is what the visibility collection does. Only objects that are in this collection will be visible when this probes captures the scene.

There is also an option to invert this behavior and effectively hide the objects in this collection.

Note! This is only a filtering option. That means that if an object is not visible at render time it won’t be visible during the probe render.

Custom Parallax panel

Reflection Cubemap only.

By default, the influence volume is also the parallax volume. The parallax volume is a volume on which is projected the recorded lighting. It should roughly fit it surrounding area. In some cases it may be better to adjust the parallax volume without touching the influence parameters. In this case, just enable the Custom Parallax and change the shape and distance of the parallax volume independently.



Type

The type of parallax volume.

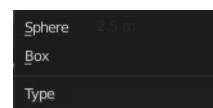

Radius

The radius of the parallax volume. Measured by the lowest corner of the parallax bounding box.

Viewport Display panel

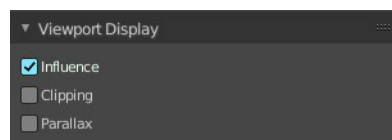

Reflection Cubemap

Influence

Show the influence bounds in the 3D Viewport. The inner sphere is where the falloff starts.

Clipping

Show the clipping distance in the 3D Viewport.

Parallax

Show the Custom Parallax shape in the 3D Viewport.

Reflection Plane

Arrow Size

Size of the arrow showing the reflection plane normal.

Influence

Show the influence bounds in the 3D Viewport.

Show Preview Plane

Show the captured reflected image onto a fully reflective plane in the 3D Viewport.

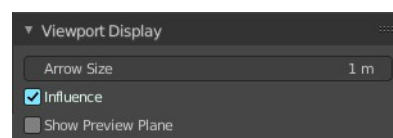

Irradiance Volume

Influence

Show the influence bounds in the 3D Viewport. The inner sphere is where the falloff starts.

Clipping

Show the clipping distance in the 3D Viewport.

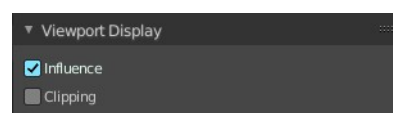

Custom Properties Panel

Here you can define custom properties that can be used for scripting.

Here you might also find custom properties from addons or scripts.

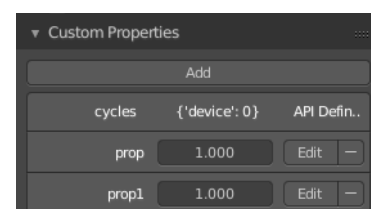

Add

Adds a new property.

Edit

Opens a panel where you can adjust the settings for the custom property.

Remove

Removes the property.

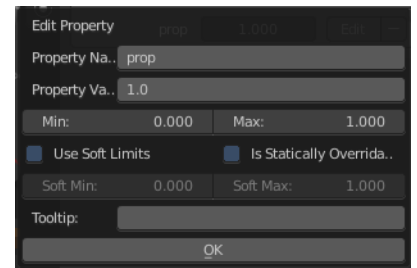



26.14.15 Editors - Properties Editor - Object Data Properties Tab - Force Field Object

Table of content

Force field of type Curve Guide.....	2
Empty panel.....	2
Display As.....	2
Size.....	2
Image.....	2
Offset X, Y.....	3
Depth.....	3
Default.....	3
Front.....	3
Back.....	3
Side.....	3
Both.....	3
Front.....	3
Back.....	3
Show in.....	3
Orthographic.....	3
Perspective.....	3
Only Axis Aligned.....	3
Transparency.....	3
Opacity.....	3
Image panel.....	4
Image property.....	4
Image Browser.....	4
Open.....	4
Name.....	4
Fake User.....	4
Open Image.....	4
Source.....	4
Source Type Single Image.....	4
Path edit box.....	4
Pack.....	4
Path edit box.....	4
Open.....	5
Refresh.....	5
Color Space.....	5
Source Type Movie + Image Sequence.....	5
Path edit box.....	5
Pack.....	5
Path edit box.....	5
Open.....	5
Refresh.....	5
Info string.....	5
Frames.....	6
Start.....	6
Offset.....	6

Cyclic.....	6
Auto Refresh.....	6
Color Space.....	6
Source Type Generated.....	6
X / Y.....	6
Float Buffer.....	6
Generated Type Blank.....	6
Color.....	6
Generated Type UV Grid.....	7
Generated Type Color Grid.....	7
Color Space.....	7
Source Type Udim.....	7
Custom Properties Panel.....	7
Add.....	7
Edit.....	8
Remove.....	8

Force field of type Curve Guide

The curve guide is a curve style object. And so it has the same settings and panels than a curve object.

To keep the redundancies in the manual at a minimum, please have a look at the chapter for the object data properties for a curve object.

25.12.2 Editors - Properties Editor - Object Data Tab - Curve Object

Empty panel

Most of the force field types are displayed as an empty. And so you will see the same empty display settings as for a regular empty.

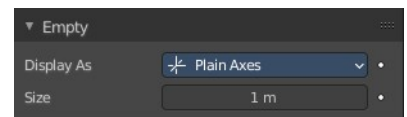

Empties are objects without additional geometry. They do not render. A use case is that you use empties as handlers for a rigged character.

Display As

Empties have graphical elements to display the location. In this drop down list you can choose the shape of this graphical element.

Further display settings can be found in the Object Properties tab in the Viewport Display panel.

Size

The size of the graphical element.

Image

Empties can display images. This images can be used to create reference images to model along. The image is always displayed, independent of the 3D

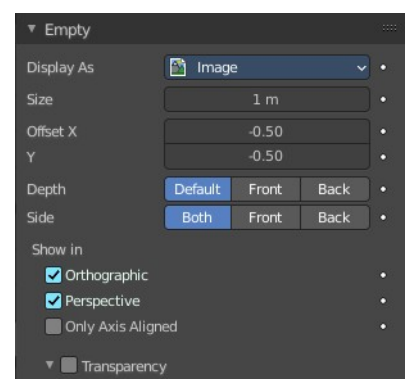

display mode.

Offset X, Y

Offset the image origin. 1.0 represents the width/height of the image.

Depth

Default

Use normal depth behavior.

Front

Always display on top of other objects.

Back

Always display behind of other objects.

Side

Both

Display both the front and back of the empty.

Front

Only display the front of the image.

Back

Only display the back of the image.

Show in

Orthographic

Show in orthographic view.

Perspective

Show in perspective view.

Only Axis Aligned

Only displays the image contents when the view is aligned with the object's local axis.

Transparency

Use alpha blending instead of alpha-test. The image then blends with the background but can have depth sorting artifacts.

Opacity

The opacity.

Image panel

When you choose an empty of type Image then this panel with further settings appears.

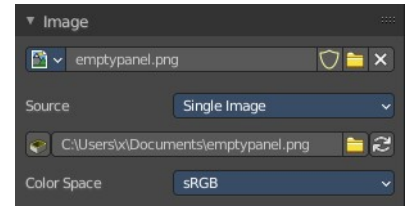
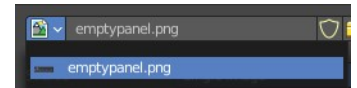

Image property

Image Browser

A list of available images in the scene.



Open

When no image is loaded the open button is displayed. Open an image opens the file browser to load an image.

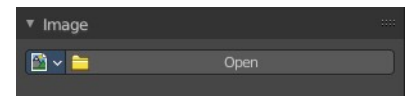

Name

The name of the currently active image.

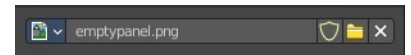

Fake User

Keep this image in the scene even if it has no user.

Open Image

Open image opens the file browser to load an image.

Source

What image type to choose.

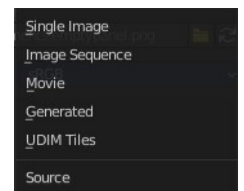

Source Type Single Image

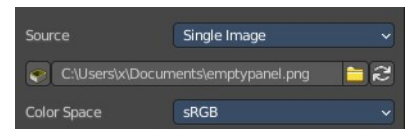

Path edit box

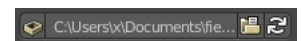

Pack

With this button you can pack the movie or the image sequence into the blend file. It gets packed when you save the blend file the next time.

Path edit box

See and edit the path to your movie or image sequence files.

Open

Open a new movie or image sequence files. A file dialog will appear.

Refresh

Reread the movie or image sequence files.

Color Space

Choose the color space type for the movie or image sequence files.

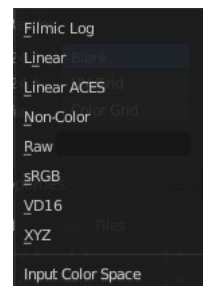

Source Type Movie + Image Sequence

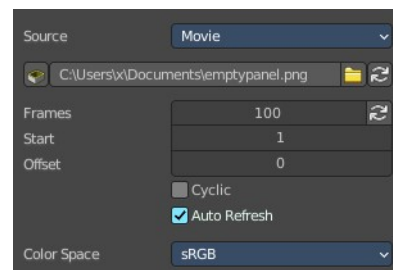
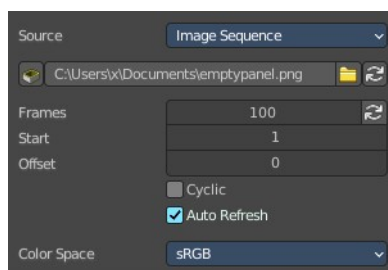

Path edit box



Pack

With this button you can pack the movie or the image sequence into the blend file. It gets packed when you save the blend file the next time.

Path edit box

See and edit the path to your movie or image sequence files.

Open

Open a new movie or image sequence files. A file dialog will appear.

Refresh

Reread the movie or image sequence files.

Info string

Some information about the currently loaded movie. Frames, resolution and color space.

Frames

The number of frames of the movie or image sequence.

Start

The start frame of the movie or image sequence

Offset

Offset the number of the frame to use in the animation. -1 means off.

Cyclic

Cycle the images in the movie.

Auto Refresh

Always refresh image on frame changes.

Color Space

Choose the color space type for the movie or image sequence files.

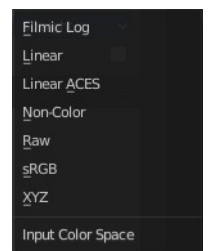

Source Type Generated

X / Y

The image width and height.

Float Buffer

Use a floating point buffer. 8 Bit images uses integers. 32 Bit works with floats.

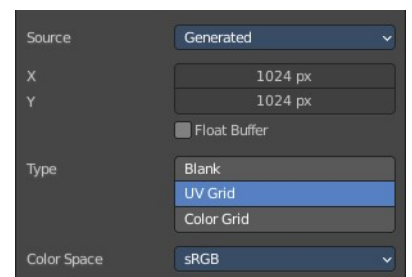

Generated Type Blank

This type displays an image with one blank color.

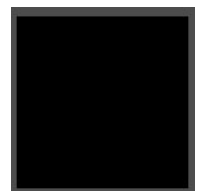

Color

The color of the blank image.

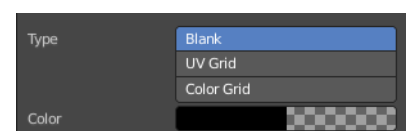

Generated Type UV Grid

This type displays a with a black and white checker texture but colored dots.

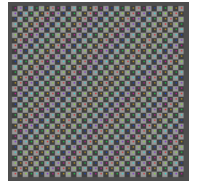

Generated Type Color Grid

This type displays a with a colored checker texture with numbers.



Color Space

Choose the color space type for the image.

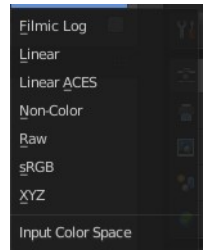

Source Type Udim

UDIM is an enhancement to the UV mapping and texturing workflow. And does not belong here. But in the UV Editor. It is just in the list because it shares the same menus with the UV Editor.



You can load a UDIM file. But it will just display the first tile of the UDIM image. And there is no way to adjust the UDIM settings since they are in the UV Editor, in Edit mode. And Empties have no Edit mode.

Custom Properties Panel

Here you can define custom properties that can be used for scripting.

Here you might also find custom properties from addons or scripts.

Add

Adds a new property.

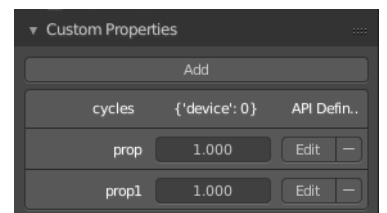

Edit

Opens a panel where you can adjust the settings for the custom property.

Remove

Removes the property.

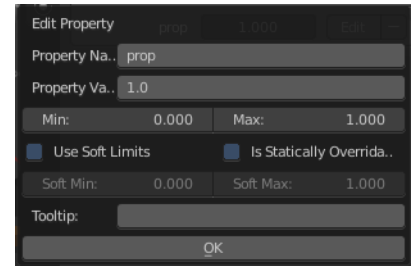

26.14.16 Editors - Properties Editor - Object Data Properties Tab - Point Cloud Object

Table of content

Point Cloud.....	1
Attributes panel.....	1
List View.....	1
Position Attribute.....	2
Search Field.....	2
Add Attribute menu.....	2
Radius.....	2
Color.....	2
Particle ID.....	2
Velocity.....	2
Custom.....	2
Name.....	2
Data Type.....	2
Float.....	2
Integer.....	2
Vector.....	2
Float Color.....	3
Byte Color.....	3
String.....	3
Domain.....	3
Remove Geometry Attribute.....	3
Custom Properties Panel.....	3
Add.....	3
Edit.....	3
Remove.....	3

Point Cloud

Point clouds can represent 3D scans. It is also planned to represent particles in the future. Each point can store data in a set of Attributes. These attributes can be managed here.

Attributes panel

The Attributes panel contains different point cloud characteristics such as the position and size of points. This data can then for example be used in the shader editor or in the compositor editor.

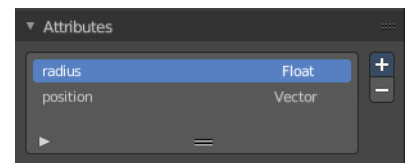

List View

A list of the attributes.

Position Attribute

The position of the point in 3D space. Type Vector. Not in the menu. This attribute exists from the beginning. And can't be added or removed.

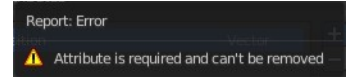

Search Field

You can expand a search field at the bottom of the list. Type in your term and hit enter to filter for your term.



Add Attribute menu

Radius

The radius of each point. Type Float.

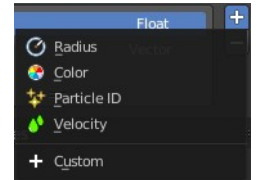

Color

The color of each point. Type Float Color.

Particle ID

A unique identifier given to each particle. Type Integer.

Velocity

The speed and direction that the particle is traveling. Type Vector.

Custom

Custom attribute can be given to particles to hold a custom characteristic. Clicking this menu item will open a popup where you can adjust the custom properties.

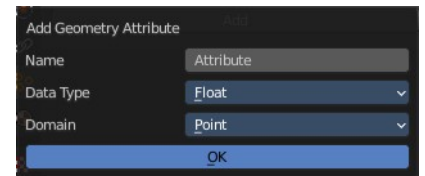

Name

The name of the attribute.

Data Type

The type of data to store in the attribute.

Float

Floating point value.

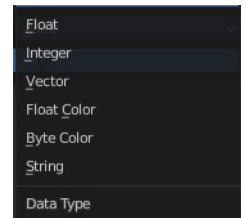

Integer

32-bit integer.

Vector

3D vector with floating point values.

Float Color

RGBA color with floating point precision.

Byte Color

RGBA color with 8-bit precision.

String

Text string.

Domain

The type of element the attribute is stored in. Currently, attributes can only be stored per Point.

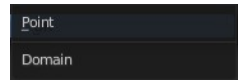

Remove Geometry Attribute

Remove the attribute from the list.

Custom Properties Panel

Here you can define custom properties that can be used for scripting.

Here you might also find custom properties from addons or scripts.

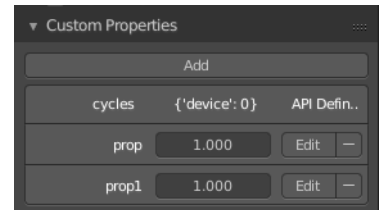

Add

Adds a new property.

Edit

Opens a panel where you can adjust the settings for the custom property.

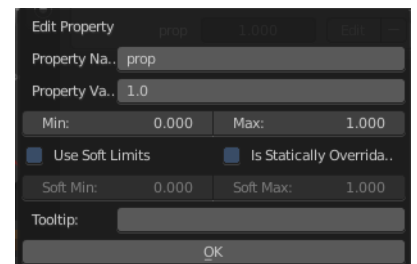

Remove

Removes the property.



26.14.2 Editors - Properties Editor - Object Data Properties Tab - Curve Object

Table of content

Detailed table of content.....	2
Shape panel.....	5
Dimensions.....	5
Resolution Preview U / Render U.....	5
Twist Method.....	5
Smooth.....	5
Fill Mode.....	5
Fill Deformed.....	5
Radius.....	5
Stretch.....	5
Bounds Clamp.....	6
Texture Space panel.....	6
Texture Mesh.....	6
Auto Texture Space.....	6
Location, Size.....	6
Match Texture Space.....	7
Geometry panel.....	7
Offset.....	7
Extrude.....	7
Taper Object.....	7
Bevel.....	8
Path Animation panel.....	10
Workflow.....	11
Frames.....	11
Evaluation Time.....	11
Clamp.....	11
Follow.....	11
Active Spline panel.....	11
Bezier curve.....	12
Nurbs curve.....	12
Poly curve.....	13
Shape Keys panel.....	13
Workflow.....	13
Active Shape Key Index.....	14
Add +.....	15
Remove -.....	15
Specials menu.....	15
Relative.....	16
Empty Hair object - Attributes Panel.....	17
List of Attributes.....	17
Add Attributes menu.....	17
Empty Hair object - Surface Panel.....	18
Surface.....	18
UV Map.....	18
Custom Properties Panel.....	18

Add.....	18
Edit.....	18
Remove.....	18

Detailed table of content

Detailed table of content

Detailed table of content.....	2
Shape panel.....	5
Dimensions.....	5
Resolution Preview U / Render U.....	5
Twist Method.....	5
Smooth.....	5
Fill Mode.....	5
Fill Deformed.....	5
Radius.....	5
Stretch.....	5
Bounds Clamp.....	6
Texture Space panel.....	6
Texture Mesh.....	6
Auto Texture Space.....	6
Location, Size.....	6
Match Texture Space.....	7
Geometry panel.....	7
Offset.....	7
Extrude.....	7
Taper Object.....	7
Taper Radius.....	8
Map Taper.....	8
Bevel.....	8
Depth.....	8
Resolution.....	8
Object.....	9
Fill Caps.....	9
Preset.....	9
Navigation elements.....	9
Zoom in / out.....	9
Tools menu.....	9
Reset View.....	9
Reset Curve.....	9
Reverse path.....	9
Toggle Profile Clipping.....	9
Curve Window.....	9
Curve point menu elements.....	9
Handle types.....	9
X / Y.....	9
Delete points.....	10
Sample straight edges.....	10
Sample even lengths.....	10
Start & End Mapping.....	10
Bevel Start/End.....	10

Bevel Mapping Start/End.....	10
Resolution.....	10
Segments.....	10
Spline.....	10
Path Animation panel.....	10
Workflow.....	11
Frames.....	11
Evaluation Time.....	11
Clamp.....	11
Follow.....	11
Active Spline panel.....	11
Bezier curve.....	12
Cyclic U.....	12
Resolution U.....	12
Interpolation Tilt.....	12
Radius.....	12
Smooth.....	12
Nurbs curve.....	12
Cyclic U.....	12
Bezier.....	12
Endpoint U.....	12
Order U.....	12
Resolution U.....	13
Smooth.....	13
Poly curve.....	13
Cyclic U.....	13
Smooth.....	13
Shape Keys panel.....	13
Workflow.....	13
Active Shape Key Index.....	14
Shape Key name.....	14
Slider value.....	14
Lock.....	14
Drag Handler.....	15
Search Field.....	15
Invert.....	15
Sort by Name.....	15
Add +.....	15
Remove -.....	15
Specials menu.....	15
New Shape From Mix.....	15
Mirror Shape Key.....	15
Mirror Shape Key (Topology).....	15
Join as Shapes (Transfer Mix).....	15
Transfer Shape Key.....	15
Delete all Shape Keys.....	16
Move to Top.....	16
Move to Bottom.....	16
Move Shape Key Up / Down.....	16
Relative.....	16
Relative.....	16
Shape Key Lock (pin icon).....	16
Shape Key Edit Mode (edit mode icon).....	16

Value.....	16
Range.....	16
Vertex Group.....	16
Relative To.....	16
Absolute.....	17
Shape Key Lock (pin icon).....	17
Shape Key Edit Mode (edit mode icon).....	17
Re-Time Shape Keys (clock icon).....	17
Interpolation.....	17
Evaluation Time.....	17
Empty Hair object - Attributes Panel.....	17
List of Attributes.....	17
Add Attributes menu.....	17
radius.....	17
color.....	17
Custom.....	18
Empty Hair object - Surface Panel.....	18
Surface.....	18
UV Map.....	18
Custom Properties Panel.....	18
Add.....	18
Edit.....	18
Remove.....	18

Shape panel

Curve shape related settings.

Dimensions

By default, new curves are set to be 3D, which means that control points can be placed anywhere in 3D space. Curves can also be set to 2D which constrain the control points to the curve's local XY axis.

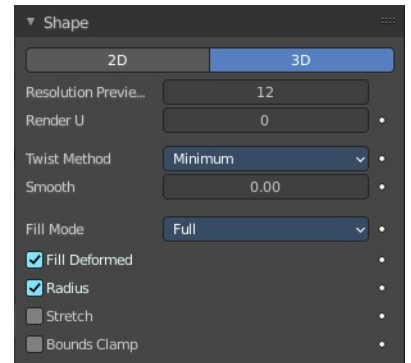

Resolution Preview U / Render U

Defines the number of points between control points. Control points are the points with the handles.

The Preview U setting defines the resolution in the 3D Viewport while the Render U setting defines the render resolution of the curve. If Render U is set to zero (0), then the Preview U setting is used for both the 3D Viewport and render resolution.

Twist Method

A 3D curve has control points that are not located on the curve's local XY plane. This gives the curve a twist which can affect the curve normals. The three available methods to calculate this twist is Minimum, Tangent and Z-Up.

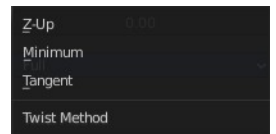

Smooth

Interactively removes twists from the curve by smoothing tangents.

Fill Mode

Fill mode defines the way a curve is displayed when it is beveled.

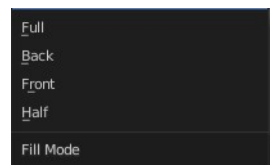

Fill Deformed

Fills the curve after applying all modification that might deform the curve. Shape keys and modifiers for example.

Radius

Causes the deformed object to be scaled by the set curve radius. Utilized when using a curve as a path or when using the Curve Modifier.

Stretch

The Stretch curve option allows you to let the mesh object stretch, or squeeze, over the entire curve. To get the expected result, use this together with the Bounds Clamp option. Utilized when using the Curve Modifier.

Bounds Clamp

When this option is enabled, the object and mesh offset along the deformation axis is ignored. This can be useful with the Stretch option or when using a negative axis. Utilized when using the Curve Modifier.

Texture Space panel

UV mapping can be generated. A procedural brick texture uses generated UV space for example to define the mapping.

In this panel you can adjust settings of the texture space used by generated texture mapping.

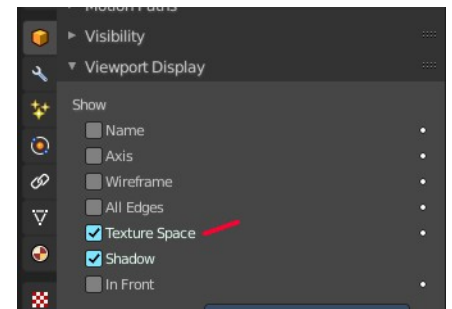
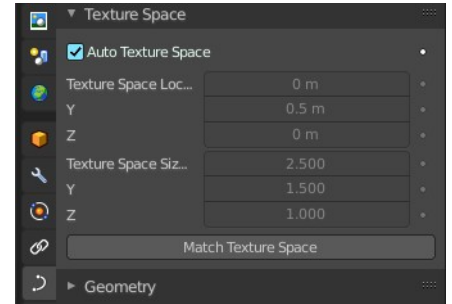
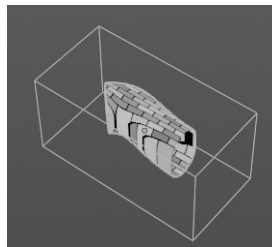
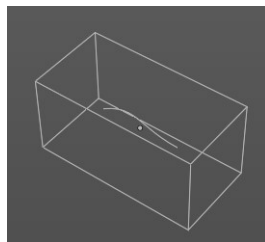
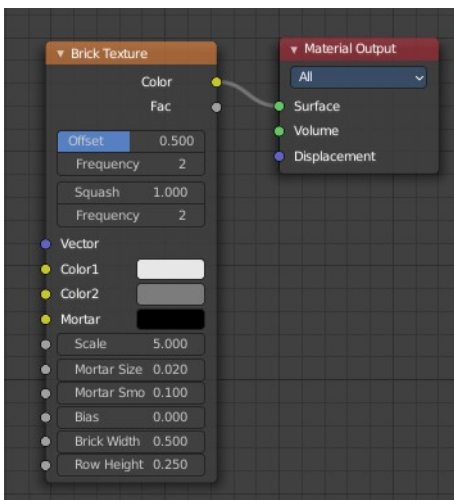

The display of the texture space cage can be activated in the Viewport Display in the Object properties.

Texture Mesh

Use another curve for texture indices. The vertex of the two objects must be perfectly aligned. Otherwise the UV map will be distorted. Note that, this is only for mesh objects.

Auto Texture Space

Adjusts the active object's texture space automatically when transforming the object.

Location, Size

Adjust the location and size of the texture space manually if Auto Texture Space is off.

The texture space can also be adjusted in the 3D Viewport. See Object Menu / Transform / Move and Scale Texture Space

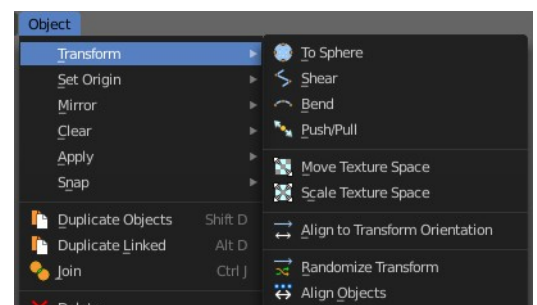

Match Texture Space

Match the texture space to the bounding box of the mesh part of the surface object, not the cage.

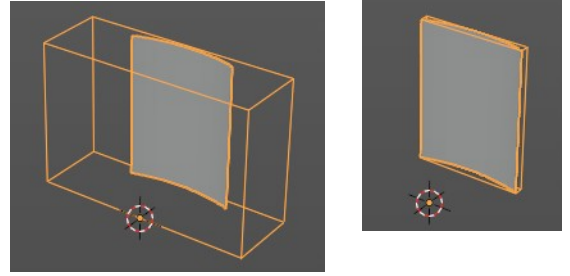

Geometry panel

A curve is a spline. And has by default no geometry. But it can have extruded or beveled geometry. This panel allows you to adjust the geometry.

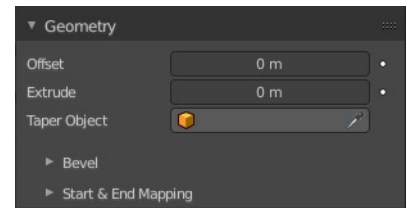

Offset

Moves the extrusion parallel to the curve normals. Needs extruded geometry first.

Extrude

Extrude the curve along the positive and negative local Z axes to create a surface. The extrusion direction follows the curve normals.



Taper Object

Tapers the extruded geometry by using another curve. The taper shape is defined by the Z value of the curve points of the taper object curve. Which you need to manipulate in edit mode.

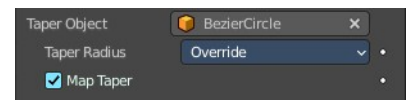

You might want to rotate the taper object curve by x around 90 degrees to see the shape of the curve in the same view than at the extruded geometry.

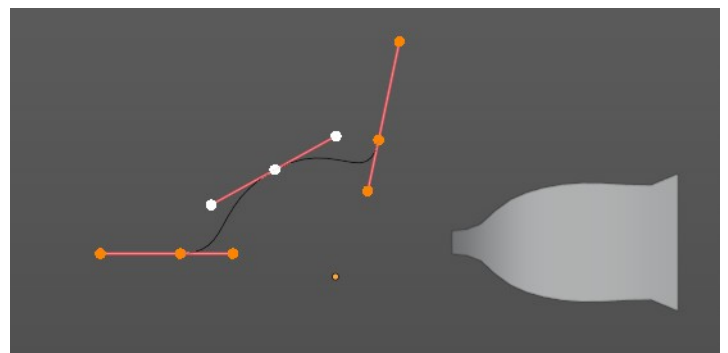

The taper object curve:

- Must be an open curve.
- The taper is applied independently to all curves of the extruded object.
- Only the first curve in a Taper Object is evaluated, even if you have several separated segments.
- The scaling starts at the first control point on the left and moves along the curve to the last control point on the right.

- Negative scaling, (e.g. negative local Y on the taper curve) is possible as well. However, rendering artifacts may appear.
- Might need to increase the curve resolution to see more detail of the taper.

With closed curves, the taper curve in Taper Object acts along the whole curve (perimeter of the object), not just the length of the object, and varies the extrusion depth. In these cases, you want the relative height of the Taper Object Taper curve at both ends to be the same, so that the cyclic point (the place where the endpoint of the curve connects to the beginning) is a smooth transition.

Taper Radius

How the radius of the spline point is computed.

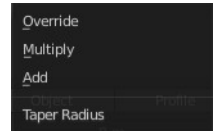

Map Taper

For curves using a Taper Object and with modifications to the Start/End Bevel Factor. The Map Taper option will then apply the taper to the beveled part of the curve, and not the whole curve.

Bevel

A curve can not only be extruded, but the extruded geometry can also be beveled to give it a thickness.

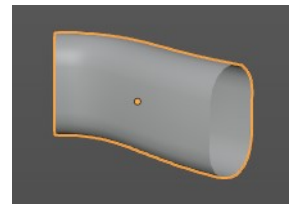

There are three bevel methods available. Round adds a rounded bevel. Object adds a bevel in the shape of a chosen object. Profile adds a bevel in the shape of the adjusted curve.

The curve settings becomes active when you have a depth value higher than 0.

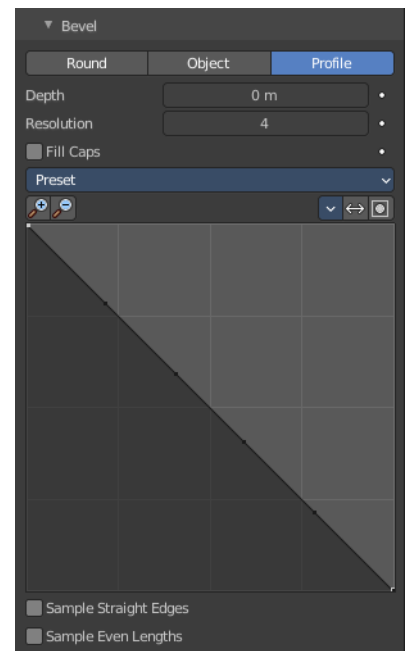
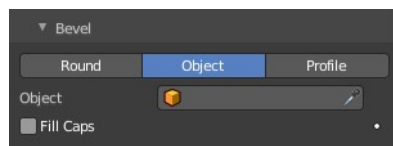
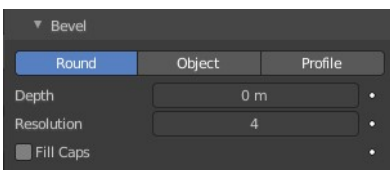

Depth

The size of the bevel.

Resolution

The subdivision of the bevel.

Object

Use another curve object to define the shape of the bevel. This curve can be closed, a Bezier circle for example. Or open. Which creates an open bevel shape then.

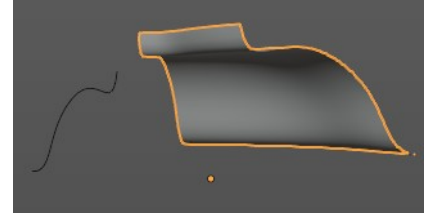
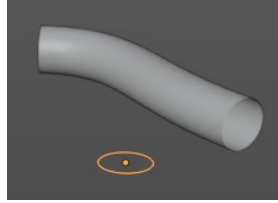

Fill Caps

Fills the ends of a beveled curve created by another curve object. And creates a solid object.

Preset

Type Profile. Curve presets.

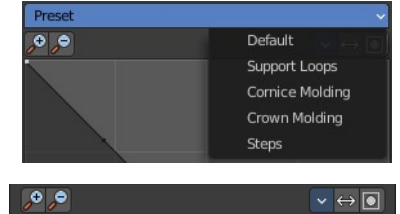

Navigation elements

Zoom in / out

Zooms in or out in the curve view.

Tools menu

Reset View

Zooms to 100%.

Reset Curve

Resets the curve.

Reverse path

Reverses the path.

Toggle Profile Clipping

Clamp the values for a curve point between 0 and 1.

Curve Window

Allows you to modify the curve by dragging the existing curve points and adding new curve points. Adding a curve point can be done by clicking left at the curve. Selected curve points reveals further functionality below the curve window.

Curve point menu elements

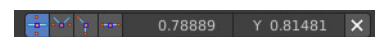

Handle types

Adjust the handle type of the current active curve point.

X / Y

The current position of the active curve point.

Delete points

Delete this curve point.

Sample straight edges

Sample edges with vector handles.

Sample even lengths

Sample edges with even lengths.

Start & End Mapping

Bevel Start/End

Where to start and to end the bevel relative to the curve. Allows to make a beveled curve which is not fully covered with a bevel.

Increasing the Start Bevel Factor to 0.5 will start beveling the curve 50% of the distance from the start of the curve (in effect shortening the curve). Decreasing the End Bevel Factor by 0.25 will start beveling the curve 25% of the distance from the end of the curve (again, shortening the curve).

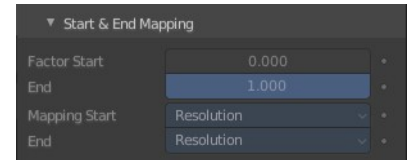

Bevel Mapping Start/End

Allows to control the relation between bevel factors (number between 0 and 1) and the rendered start and end point of a beveled spline. Map the bevel factor to:

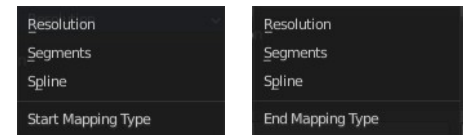

Resolution

To the number of subdivisions of a spline (U resolution).

Segments

To the length of its segments. Mapping to segments treats the subdivisions in each segment of a curve as if they would have all the same length.

Spline

The length of a spline.

Path Animation panel

Move child objects along a path.

Note! This feature is deprecated, but still available. A more future-proof method is the Follow Path Constraint.

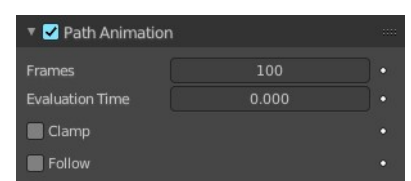

Workflow

Create a curve. Create an object that you want to move along the path.

Select the object, hold down shift, and parent the object to the curve with the method Follow Path. When you press play then the object will just rotate around itself.

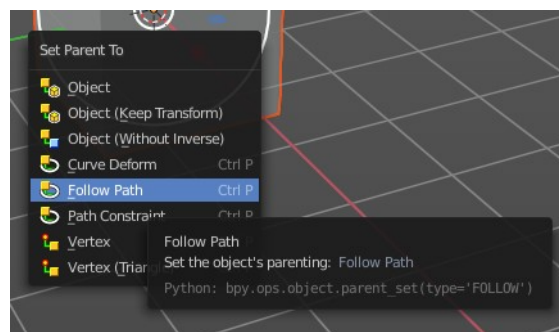
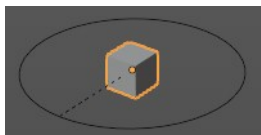

Next select the object, and clear the origin. This will set the object to the start point of the curve. And when you play the animation, then the cube will now move along the curve.

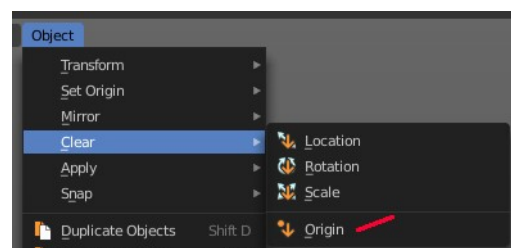
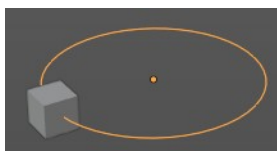

Frames

The number of frames that are needed to move along the path.

Evaluation Time

The current frame position. The position is calculated by dividing the frames through the path length.

Clamp

Clamp the curve path children so that they can't travel past the start and end point of the curve.

Follow

Make the child object rotate along the curvature of the path.

Active Spline panel

The Active Spline panel is used in Edit Mode to control properties of the currently selected spline. The tool set for Nurbs curves, Bezier curves and Poly curves differs.

Poly curves can be created by converting mesh geometry to a curve. U stands for the curve direction.

Bezier curve

Cyclic U

Closes the active spline.

Resolution U

Alters the resolution of each segment by changing the number of subdivisions.

Interpolation Tilt

How the tilt of a segment is calculated.

Radius

Alters how the radius of a beveled curve is calculated. The effects are easier to see after increasing the radius.

Smooth

Use Smooth Shading for any 3D geometry.

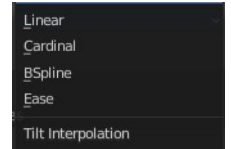
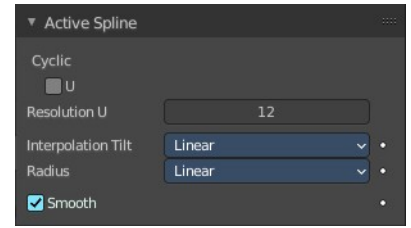

Nurbs curve

Cyclic U

Closes the active spline by connecting the end with the start point.

Bezier

Make the nurbs curve or surface act like a Bezier spline in the U direction. Order U must be 3 or 4, and Cyclic U must be disabled.

Endpoint U

Make the end points of the curve meet the end points of the handlers.

Order U

The area of influence of the control points over the curve. Higher order values means that a single control point has a greater influence over a greater relative proportion of the curve. The valid range of Order values is 2-6, depending on the number of control points present in the curve.

Two, three, four ...

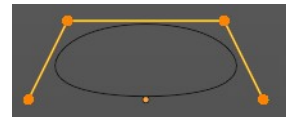
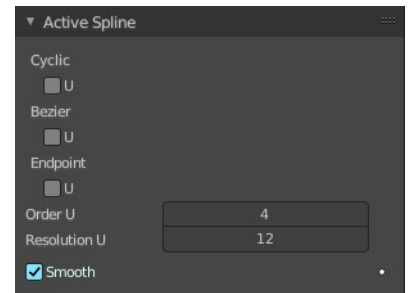

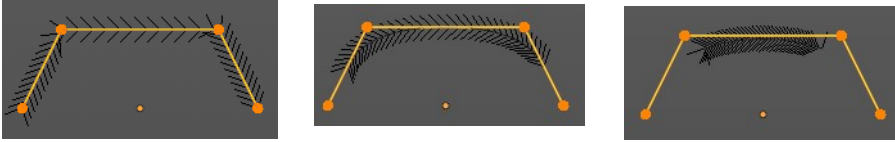

Resolution U

Alters the resolution of each segment by changing the number of subdivisions.

Smooth

Use Smooth Shading for any 3D geometry.

Poly curve

To see this content you need to be in edit mode, and draw a curve with type poly.



Cyclic U

Closes the active spline.

Smooth

Use Smooth Shading for any 3D geometry.

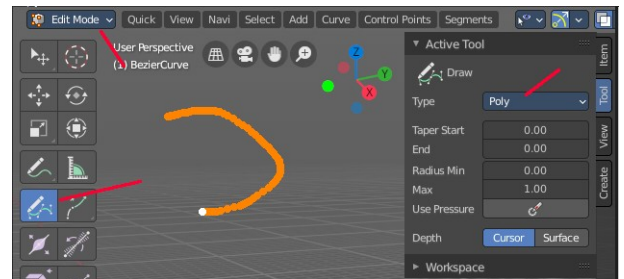

Shape Keys panel

This panel allows you to see and manage shape keys. A shape key is a vertex animation.

Shape keys are for example used for facial animations, when you don't want to use a face rig with bones. The idea is to model a shape key pose for smiling, one for laughing, one for sad, and so on. And then blend the shape key poses together as needed.

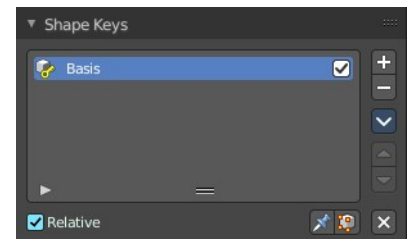

Shape keys are also called morph targets or blend shapes.

Workflow

In Object mode add a shape key. This first shape key is called Basis by default. It is the base for the vertex animation. This basis shape key is the base shape for all further shape keys. It cannot be modified or keyframed.

Now add a second shape key. This second shape key will have more controls so that you can modify it in the needed way.

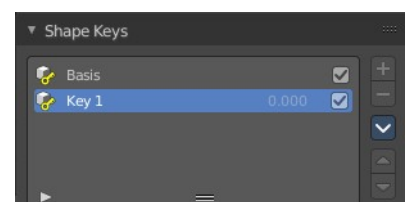

Enter edit mode with this key 1 selected.

Modify the geometry by moving some vertices around. Shot is from a mesh, but works the same with curves.

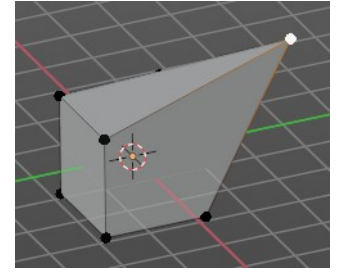

Switch back to Object mode.

Have a look at the value slider. This slider defines how the key 1 shape key blends with the Basis shape key.

Move it from value 0 to value 1. You will notice that the vertices that you have modified in Key 1 will now start to move to a new position. Dependent of how strong the value is. With a value of 1 it will be at the position of how you modeled it.

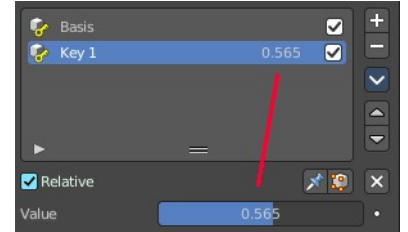

To keyframe this shape click at the Animate property dot behind the slider. The slider will change its color. And the dot will change to a rhombus shape to indicate that there is a keyframe recorded at this frame.

Or you right click at the slider, and choose Insert Keyframe in the menu.

Move to another frame. Change the slider value, and set another keyframe.

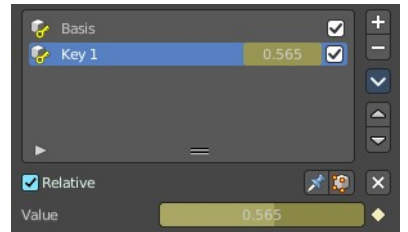

Recorded keyframes can be found and further tweaked in the Dope sheet Editor in Shape Key Editor mode. Here you can also record further keyframes under Key / Insert Keyframes. And control the slider values from the channel list.

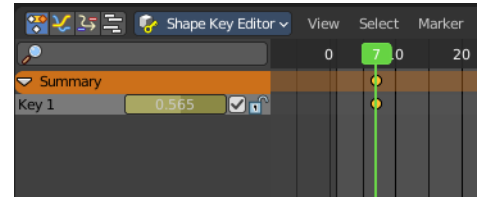

Add more shape keys and model and animate them as you need them.

Active Shape Key Index

A List of the shape keys for this mesh.

It contains two types of shape keys. Basis is the base shape. The other type relies at this shape as the base.

Shape Key name

The name of the shape key. It can be renamed by double clicking at it.

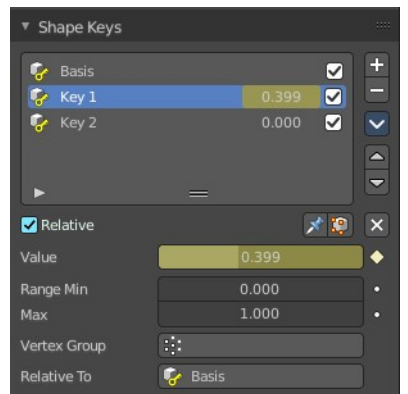

Slider value

The blend value of this shape key. The Basis shape key does not have such a slider.

Lock

The lock icon at the end of a group name locks the group from being editable.

Drag Handler

The two vertical lines at the end is a handler with which you can expand the list.

Search Field

You can expand a search field at the bottom of the list. Type in your term and hit enter to filter for your term.



Invert

Exclude the search term instead of searching for it.

Sort by Name

Sort the List by name.

Add +

Create a shape key.

Remove -

Delete the selected shape key.

Specials menu

New Shape From Mix

Add a new shape key with the current deformed shape of the object.

Mirror Shape Key

Mirror the shape keys on the X axis. This will not work if the mesh vertices is not fully symmetrical.

Mirror Shape Key (Topology)

Mirror the shape keys on the X axis. But detects the mirrored vertices based on the topology of the mesh. The mesh vertices do not have to be perfectly symmetrical for this action to work.

Join as Shapes (Transfer Mix)

Transfer the current resulting shape from a different object.

Select the object to copy, hold down Shift, then the object to copy into. Use this action and a new shape key will be added to the active object with the current mix of the first object.

Transfer Shape Key

Transfer the active shape key from a different object regardless of its current influence.

Select the object to copy, hold down Shift, then the object to copy into. Use this action and a new shape key will be added to the active object with the active shape of the first object.

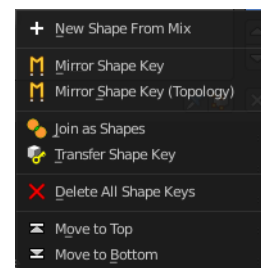

Delete all Shape Keys

Delete all shape keys at this mesh.

Move to Top

Move the shape key to the top of the list. But not above the Basis shape key.

Move to Bottom

Move the shape key to the bottom of the list.

Move Shape Key Up / Down

Moves the selected shape key up or down in the list.



Relative

Set the shape keys to Relative or Absolute.

Relative

The shape is defined relative to the Basis or another specified shape key. And can be adjusted in its settings.

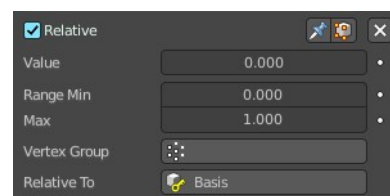

Shape Key Lock (pin icon)

Show the active shape in the 3D Viewport without blending. Shape Key Lock gets automatically enabled while the object is in Edit Mode.

Shape Key Edit Mode (edit mode icon)

If enabled, when entering Edit Mode the active shape key will not take maximum influence as is default. Instead, the current blend of shape keys will be visible and can be edited from that state.

Value

The weight of the blend between the shape key and its basis key. 0 means no influence, 1 full influence.

Range

Minimum and maximum range for the influence value of the active shape key.

Vertex Group

Limit the active shape key deformation to a vertex group.

Relative To

Select the shape key to deform from. It does not need to be the Basis shape key, but can also be another shape key.

Absolute

The shape changes over time, as defined in its settings.

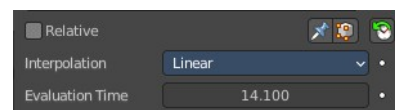

Shape Key Lock (pin icon)

Show the active shape in the 3D Viewport without blending. Shape Key Lock gets automatically enabled while the object is in Edit Mode.

Shape Key Edit Mode (edit mode icon)

If enabled, when entering Edit Mode the active shape key will not take maximum influence as is default. Instead, the current blend of shape keys will be visible and can be edited from that state.

Re-Time Shape Keys (clock icon)

Absolute shape keys are timed, by order in the list, at a constant interval. This button resets the timing for the keys. Useful if keys were removed or re-ordered.

Interpolation

The interpolation method between shape keys.

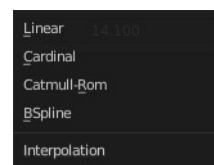

Evaluation Time

Evaluate the shape key influence over the defined time. The evaluation starts at influence 0, and reaches 1 at the end of the value of this timer.

Empty Hair object - Attributes Panel

The empty hair object is a special curves object. You control it by geometry nodes.

The Attributes panel allows you to define Attributes for this purpose, which can then be used in the geometry nodes. By default just the position attribute is added.

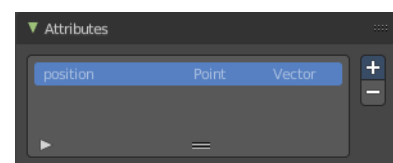

List of Attributes

The list of available attributes.

Add Attributes menu

radius

Add a radius attribute.

color

Add a color attribute.

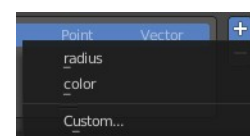

Custom

Add a custom attribute.

This opens a dialog where you can adjust the parameters of this custom attribute.

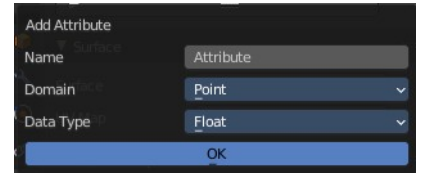

Empty Hair object - Surface Panel

The empty hair object is a special curves object. You control it by geometry nodes.

Define the object that is used as the parent object for the hairs.

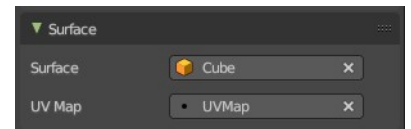

Surface

Which object to use.

UV Map

Which UV map of the object to use.

Custom Properties Panel

Here you can define custom properties that can be used for scripting.

Here you might also find custom properties from addons or scripts.

Add

Adds a new property.

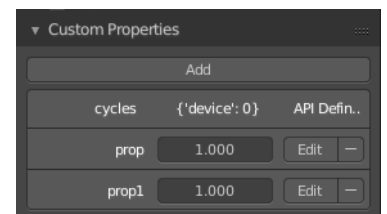

Edit

Opens a panel where you can adjust the settings for the custom property.

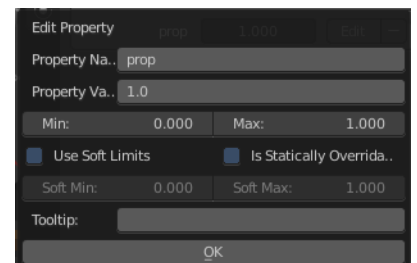

Remove

Removes the property.



26.14.3 Editors - Properties Editor - Object Data Properties Tab - Surface Object

Inhaltsverzeichnis

Shape panel.....	2
Resolution Viewport U / V.....	2
Render U / V.....	2
Texture Space panel.....	2
Texture Mesh.....	3
Auto Texture Space.....	3
Location and Size X / Y / Z.....	3
Match Texture Space.....	3
Active Spline panel.....	3
Cyclic U / V.....	4
Bezier U / V.....	4
Endpoint U / V.....	4
Order U / V.....	4
Resolution U / V.....	4
Smooth.....	4
Shape Keys panel.....	4
Workflow.....	4
Active Shape Key Index.....	5
Shape Key name.....	6
Slider value.....	6
Lock.....	6
Drag Handler.....	6
Search Field.....	6
Invert.....	6
Sort by Name.....	6
Add +.....	6
Remove -.....	6
Specials menu.....	6
New Shape From Mix.....	6
Mirror Shape Key.....	6
Mirror Shape Key (Topology).....	6
Join as Shapes (Transfer Mix).....	7
Transfer Shape Key.....	7
Delete all Shape Keys.....	7
Move to Top.....	7
Move to Bottom.....	7
Move Shape Key Up / Down.....	7
Relative.....	7
Relative.....	7
Shape Key Lock (pin icon).....	7
Shape Key Edit Mode (edit mode icon).....	7
Value.....	7
Range.....	8
Vertex Group.....	8
Relative To.....	8

Absolute.....	8
Shape Key Lock (pin icon).....	8
Shape Key Edit Mode (edit mode icon).....	8
Re-Time Shape Keys (clock icon).....	8
Interpolation.....	8
Evaluation Time.....	8
Custom Properties Panel.....	8
Add.....	8
Edit.....	9
Remove.....	9

Shape panel

Resolution Viewport U / V

The 3D Viewport resolution of the generated mesh. The lower the higher the resolution.

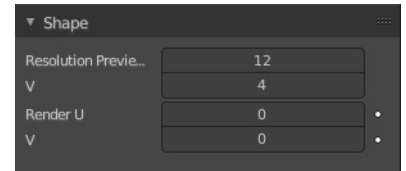

Render U / V

The rendered resolution of the generated mesh. The lower the higher the resolution.

Texture Space panel

UV mapping can be generated. A procedural brick texture uses generated UV space for example to define the mapping.

In this panel you can adjust settings of the texture space used by generated texture mapping.

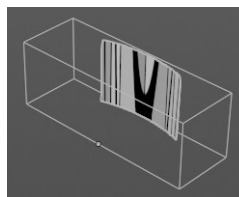
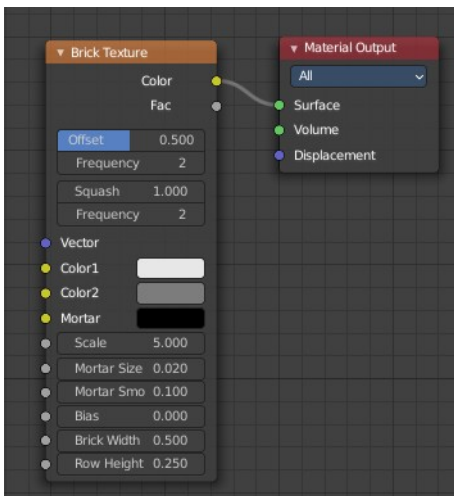
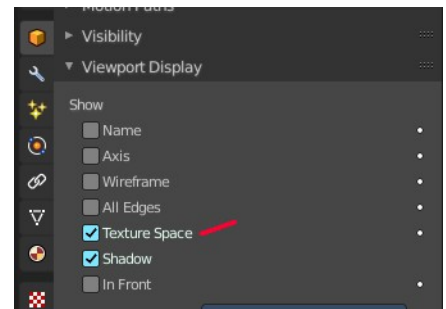
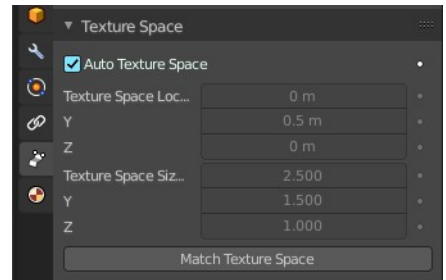

The display of the texture space cage can be activated in the Viewport Display in the Object properties.

Texture Mesh

Use another curve for texture indices. The vertex of the two objects must be perfectly aligned. Otherwise the UV map will be distorted. Note that, this is only for mesh objects.

Auto Texture Space

Adjusts the active object's texture space automatically when transforming the object.

Location and Size X / Y / Z

Adjust the location and size of the texture space manually if Auto Texture Space is off.

The texture space can also be adjusted in the 3D Viewport. See Object Menu / Transform / Move and Scale Texture Space

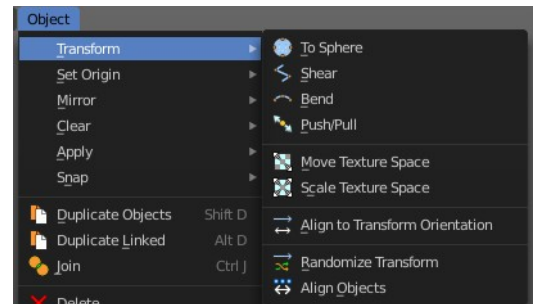

Match Texture Space

Match the texture space to the bounding box of the mesh part of the surface object, not the cage.

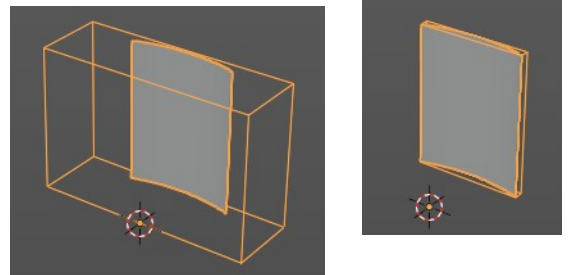

Active Spline panel

The Active Spline panel is used in Edit Mode to control properties of the currently selected spline.

U and V stands for the surface direction. U goes along the spline. V is the extruding direction.

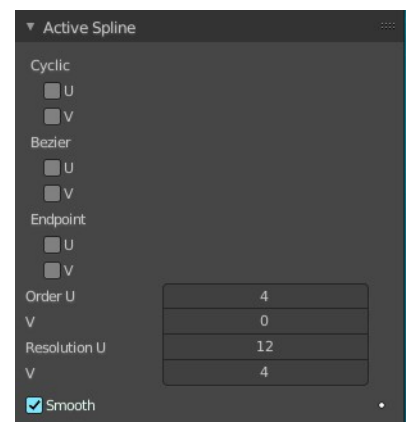

Cyclic U / V

Closes the active spline by connecting the end with the start point.

Bezier U / V

Make the nurbs curve or surface act like a Bezier spline in the U direction. Order U must be 3 or 4, and Cyclic U must be disabled.

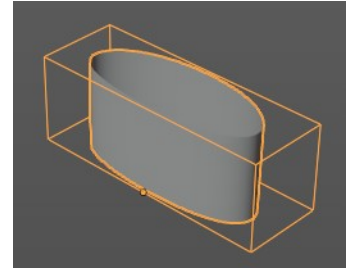

Endpoint U / V

Make the end points of the curve meet the end points of the handlers.

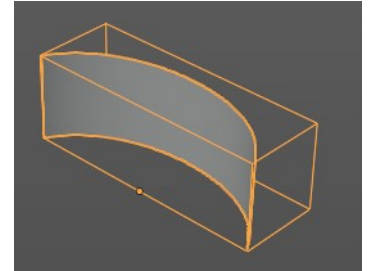

Order U / V

The area of influence of the control points over the curve. Higher order values means that a single control point has a greater influence over a greater relative proportion of the curve. The valid range of Order values is 2-6, depending on the number of control points present in the curve.

Two, three, four ...

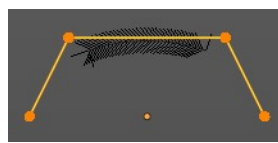
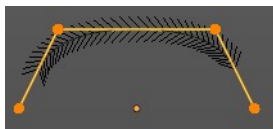
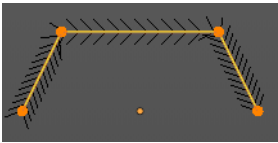

Resolution U / V

Alters the resolution of each segment by changing the number of subdivisions.

Smooth

Use Smooth Shading for any 3D geometry.

Shape Keys panel

This panel allows you to see and manage shape keys. A shape key is a vertex animation.

Shape keys are for example used for facial animations, when you don't want to use a face rig with bones. The idea is to model a shape key pose for smiling, one for laughing, one for sad, and so on. And then blend the shape key poses together as needed.

Shape keys are also called morph targets or blend shapes.

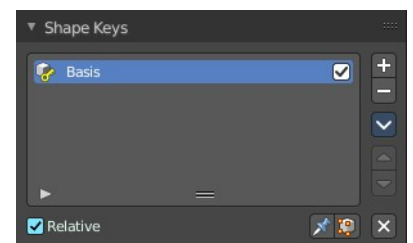

Workflow

In Object mode add a shape key. This first shape key is called Basis by default. It is the base for the vertex animation. This basis shape key is the base shape for all further shape keys. It cannot be modified or keyframed.

Now add a second shape key. This second shape key will have more controls so that you can modify it in the needed way.

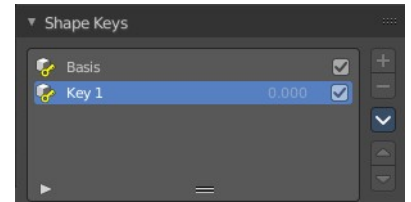

Enter edit mode with this key 1 selected.

Modify the geometry by moving some vertices around. Shot is from a mesh, but works the same with curves.

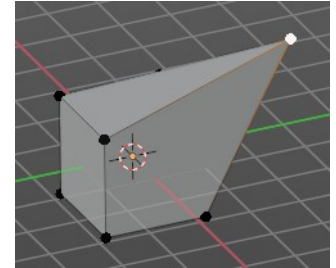

Switch back to Object mode.

Have a look at the value slider. This slider defines how the key 1 shape key blends with the Basis shape key.

Move it from value 0 to value 1. You will notice that the vertices that you have modified in Key 1 will now start to move to a new position. Dependent of how strong the value is. With a value of 1 it will be at the position of how you modeled it.

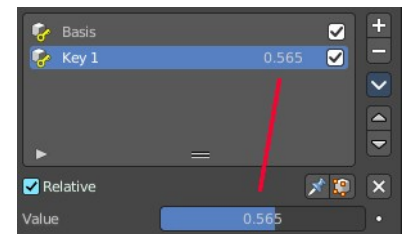

To keyframe this shape click at the Animate property dot behind the slider. The slider will change its color. And the dot will change to a rhombus shape to indicate that there is a keyframe recorded at this frame.

Or you right click at the slider, and choose Insert Keyframe in the menu.

Move to another frame. Change the slider value, and set another keyframe.

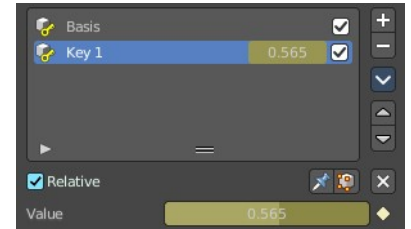

Recorded keyframes can be found and further tweaked in the Dope sheet Editor in Shape Key Editor mode. Here you can also record further keyframes under Key / Insert Keyframes. And control the slider values from the channel list.

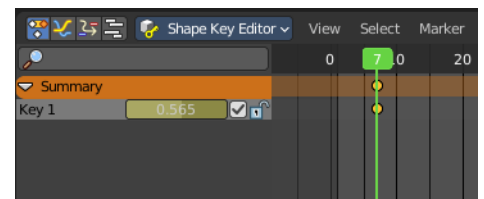

Add more shape keys and model and animate them as you need them.

Active Shape Key Index

A List of the shape keys for this mesh.

It contains two types of shape keys. Basis is the base shape. The other type relies at this shape as the base.



Shape Key name

The name of the shape key. It can be renamed by double clicking at it.

Slider value

The blend value of this shape key. The Basis shape key does not have such a slider.

Lock

The lock icon at the end of a group name locks the group from being editable.

Drag Handler

The two vertical lines at the end is a handler with which you can expand the list.

Search Field

You can expand a search field at the bottom of the list. Type in your term and hit enter to filter for your term.



Invert

Exclude the search term instead of searching for it.

Sort by Name

Sort the List by name.

Add +

Create a shape key.

Remove -

Delete the selected shape key.

Specials menu

New Shape From Mix

Add a new shape key with the current deformed shape of the object.

Mirror Shape Key

Mirror the shape keys on the X axis. This will not work if the mesh vertices is not fully symmetrical.

Mirror Shape Key (Topology)

Mirror the shape keys on the X axis. But detects the mirrored vertices based on the topology of the mesh. The mesh vertices do not have to be perfectly symmetrical for this action to work.

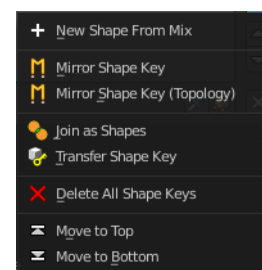

Join as Shapes (Transfer Mix)

Transfer the current resulting shape from a different object.

Select the object to copy, hold down Shift, then the object to copy into. Use this action and a new shape key will be added to the active object with the current mix of the first object.

Transfer Shape Key

Transfer the active shape key from a different object regardless of its current influence.

Select the object to copy, hold down Shift, then the object to copy into. Use this action and a new shape key will be added to the active object with the active shape of the first object.

Delete all Shape Keys

Delete all shape keys at this mesh.

Move to Top

Move the shape key to the top of the list. But not above the Basis shape key.

Move to Bottom

Move the shape key to the bottom of the list.

Move Shape Key Up / Down

Moves the selected shape key up or down in the list.



Relative

Set the shape keys to Relative or Absolute.

Relative

The shape is defined relative to the Basis or another specified shape key. And can be adjusted in its settings.

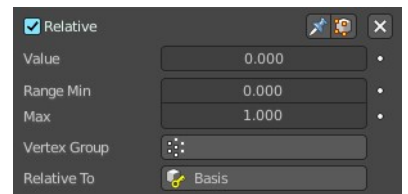

Shape Key Lock (pin icon)

Show the active shape in the 3D Viewport without blending. Shape Key Lock gets automatically enabled while the object is in Edit Mode.

Shape Key Edit Mode (edit mode icon)

If enabled, when entering Edit Mode the active shape key will not take maximum influence as is default. Instead, the current blend of shape keys will be visible and can be edited from that state.

Value

The weight of the blend between the shape key and its basis key. 0 means no influence, 1 full influence.

Range

Minimum and maximum range for the influence value of the active shape key.

Vertex Group

Limit the active shape key deformation to a vertex group.

Relative To

Select the shape key to deform from. It does not need to be the Basis shape key, but can also be another shape key.

Absolute

The shape changes over time, as defined in its settings.



Shape Key Lock (pin icon)

Show the active shape in the 3D Viewport without blending. Shape Key Lock gets automatically enabled while the object is in Edit Mode.

Shape Key Edit Mode (edit mode icon)

If enabled, when entering Edit Mode the active shape key will not take maximum influence as is default. Instead, the current blend of shape keys will be visible and can be edited from that state.

Re-Time Shape Keys (clock icon)

Absolute shape keys are timed, by order in the list, at a constant interval. This button resets the timing for the keys. Useful if keys were removed or re-ordered.

Interpolation

The interpolation method between shape keys.

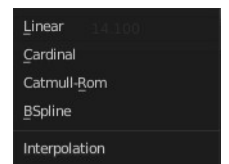

Evaluation Time

Evaluate the shape key influence over the defined time. The evaluation starts at influence 0, and reaches 1 at the end of the value of this timer.

Custom Properties Panel

Here you can define custom properties that can be used for scripting.

Here you might also find custom properties from addons or scripts.

Add

Adds a new property.

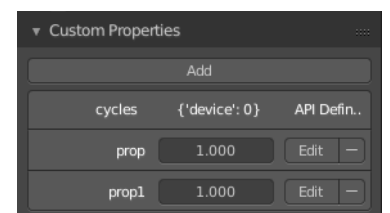

Edit

Opens a panel where you can adjust the settings for the custom property.

Remove

Removes the property.

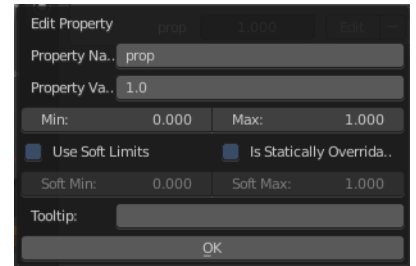

26.14.4 Editors - Properties Editor - Object Data Properties Tab - Metaball Object

Table of content

Metaball panel.....	1
Resolution Viewport.....	1
Render.....	1
Influence Threshold.....	1
Update on Edit.....	2
Always.....	2
Half.....	2
Fast.....	2
Never.....	2
Texture Space panel.....	2
Texture Mesh.....	2
Auto Texture Space.....	3
Location, Size.....	3
Custom Properties Panel.....	3
Add.....	3
Edit.....	3
Remove.....	3

Metaball panel

Resolution Viewport

The 3D Viewport resolution of the generated mesh. The lower the higher the resolution.

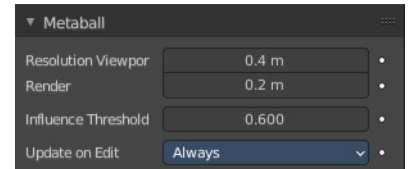

Render

The rendered resolution of the generated mesh. The lower the higher the resolution.

Influence Threshold

How much the surface of a meta object influences the surface of other meta objects. The lower the value the higher the influence, and the bigger the meta element of the meta object.

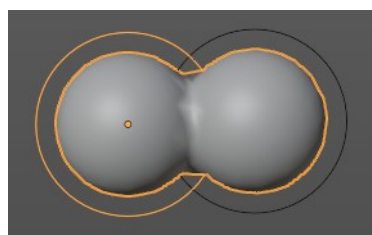
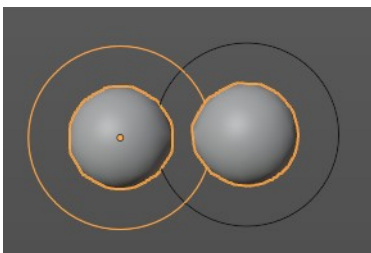

Update on Edit

Define how the metas updates on editing.

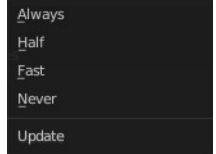

Always

Fully display the meta during transformations.

Half

During transformations, display the meta at half its Wire size resolution.

Fast

Do not display meta during transformations.

Never

Never show meta mesh at editing. It is just shown while rendering then.

Texture Space panel

UV mapping can be generated. A procedural brick texture uses generated UV space for example to define the mapping.

In this panel you can adjust settings of the texture space used by generated texture mapping.

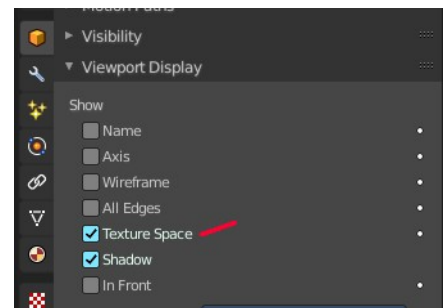
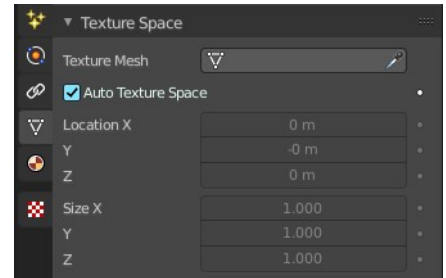
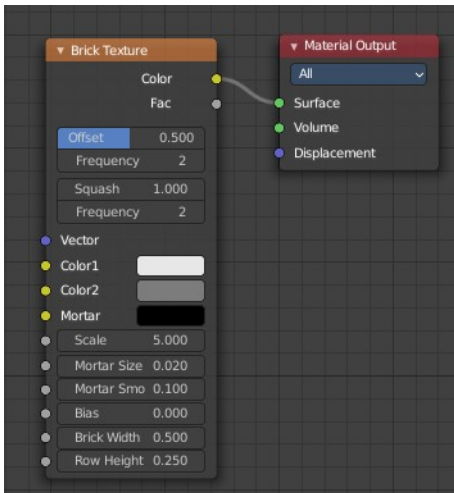

The display of the texture space cage can be activated in the Viewport Display in the Object properties.

Texture Mesh

Use another curve for texture indices. The vertex of the two objects must be perfectly aligned. Otherwise the

UV map will be distorted. Note that, this is only for mesh objects.

Auto Texture Space

Adjusts the active object's texture space automatically when transforming the object.

Location, Size

Adjust the location and size of the texture space manually if Auto Texture Space is off.

The texture space can also be adjusted in the 3D Viewport. See [Object Menu / Transform / Move and Scale Texture Space](#)

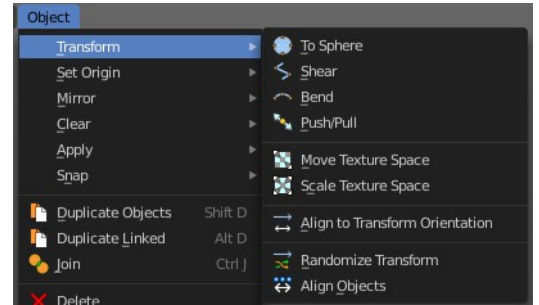

Custom Properties Panel

Here you can define custom properties that can be used for scripting.

Here you might also find custom properties from addons or scripts.

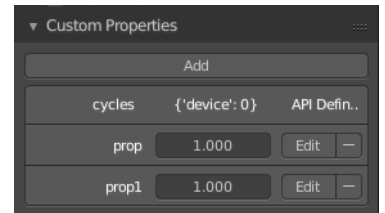

Add

Adds a new property.

Edit

Opens a panel where you can adjust the settings for the custom property.

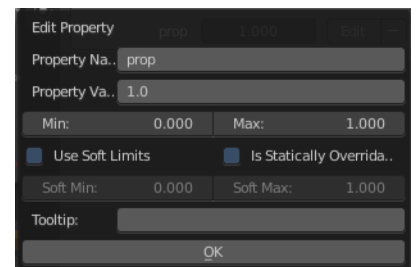

Remove

Removes the property.

26.14.5 Editors - Properties Editor - Object Data Properties Tab - Text Object

Table of content

Detailed table of content.....	1
Shape panel.....	3
Resolution Preview U.....	3
Render U.....	3
Fast Editing.....	3
Fill Mode.....	3
Fill Deformed.....	3
Texture Space panel.....	4
Texture Mesh.....	4
Auto Texture Space.....	4
Location, Size.....	4
Match Texture Space.....	5
Geometry panel.....	5
Offset.....	5
Extrude.....	5
Taper Object.....	5
Map Taper.....	6
Bevel.....	6
Font panel.....	6
Regular, Bold, Italic, Bold& Italic.....	6
Style.....	7
Transform.....	7
Paragraph panel.....	8
Alignment sub tab.....	8
Spacing sub tab.....	10
Text Boxes panel.....	10
Add Text box.....	11
Overflow.....	11
Text box.....	11
Custom Properties Panel.....	11
Add.....	11
Edit.....	11
Remove.....	12

Detailed table of content

Detailed table of content

Detailed table of content.....	1
Shape panel.....	3
Resolution Preview U.....	3
Render U.....	3
Fast Editing.....	3
Fill Mode.....	3
Fill Deformed.....	3

Texture Space panel.....	3
Texture Mesh.....	4
Auto Texture Space.....	4
Location, Size.....	4
Match Texture Space.....	5
Geometry panel.....	5
Offset.....	5
Extrude.....	5
Taper Object.....	5
Map Taper.....	6
Bevel.....	6
Depth.....	6
Resolution.....	6
Object.....	6
Fill Caps.....	6
Font panel.....	6
Regular, Bold, Italic, Bold& Italic.....	6
Data Browser.....	6
Name.....	7
Number of Users.....	7
Fake User.....	7
Open Font.....	7
Location of Fonts in Windows.....	7
Location of Fonts on Unix.....	7
Remove font.....	7
Style.....	7
Transform.....	7
Size.....	7
Shear.....	7
Object Font.....	7
How to.....	8
Text on Curve.....	8
Underline Position.....	8
Underline Thickness.....	8
Small Caps Scale.....	8
Paragraph panel.....	8
Alignment sub tab.....	8
Horizontal Alignment.....	8
Left.....	9
Center.....	9
Right.....	9
Justify.....	9
Flush.....	9
Vertical Alignment.....	9
Top Base-Line.....	9
Top.....	9
Center.....	9
Bottom.....	9
Bottom Base-Line.....	10
Spacing sub tab.....	10
Character Spacing.....	10
Word Spacing.....	10
Line Spacing.....	10

Offset X/Y.....	10
Text Boxes panel.....	10
Add Text box.....	10
Overflow.....	11
Overflow.....	11
Scale to Fit.....	11
Truncate.....	11
Text box.....	11
Delete X.....	11
Size X/Y.....	11
Offset X/Y.....	11
Custom Properties Panel.....	11
Add.....	11
Edit.....	11
Remove.....	11

Shape panel

Resolution Preview U

The resolution of the text curve geometry in the viewport.



Render U

The resolution of the text curve geometry when rendering. If Render U is set to zero (0), then the Preview U setting is used for both the 3D Viewport and render resolution.

Fast Editing

Do not fill the letters in Edit Mode, only show their outline. Object mode display is not affected

Fill Mode

How to fill the letters. Note that you need to activate Backface culling for back and front in the Viewport Shading to see an effect.

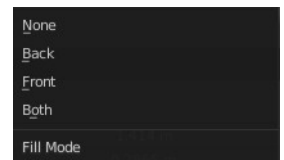

Fill Deformed

Fill the curve after shape keys and after applying all modifiers.

Texture Space panel

UV mapping can be generated. A procedural brick texture uses generated UV space for example to define the mapping.

In this panel you can adjust settings of the texture space used by generated texture mapping.

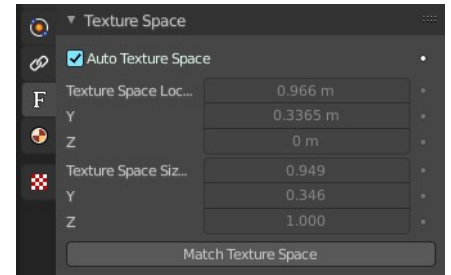
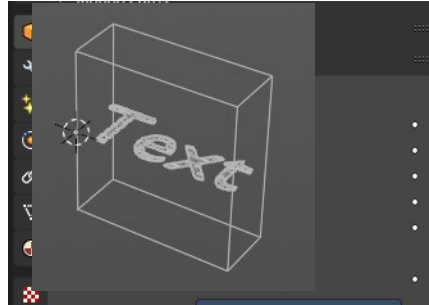
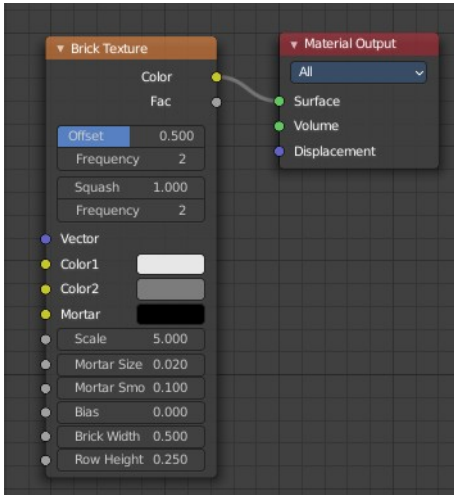

The display of the texture space cage can be activated in the Viewport Display in the Object properties.

Texture Mesh

Use another curve for texture indices. The vertex of the two objects must be perfectly aligned. Otherwise the UV map will be distorted. Note that, this is only for mesh objects.

Auto Texture Space

Adjusts the active object's texture space automatically when transforming the object.

Location, Size

Adjust the location and size of the texture space manually if Auto Texture Space is off.

The texture space can also be adjusted in the 3D Viewport. See Object Menu / Transform / Move and Scale Texture Space

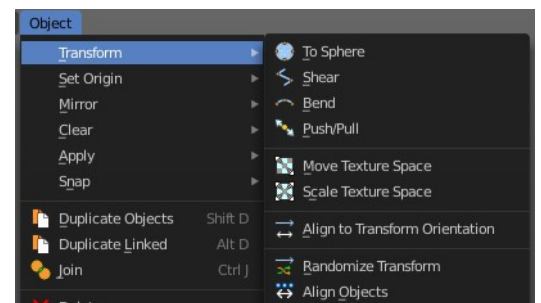

Match Texture Space

Match the texture space to the bounding box of the mesh part of the surface object, not the cage.

Geometry panel

A curve is a spline. And has by default no geometry. The text object differs a bit here since the face is filled. But it has no height. You can have extruded or beveled geometry to add height. This panel allows you to adjust the geometry.



Offset

Moves the extrusion parallel to the curve normals. Needs extruded geometry first.

Extrude

Extrude the curve along the positive and negative local Z axes to create a surface. The extrusion direction follows the curve normals.

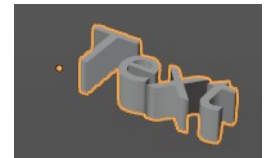

Taper Object

Tapers the extruded geometry by using another curve. The taper shape is defined by the Z value of the curve points of the taper object curve. Which you need to manipulate in edit mode.

You might want to rotate the taper object curve by x around 90 degrees to see the shape of the curve in the same view than at the extruded geometry.

The taper object curve:

- Must be an open curve.
- The taper is applied independently to all curves of the extruded object.
- Only the first curve in a Taper Object is evaluated, even if you have several separated segments.
- The scaling starts at the first control point on the left and moves along the curve to the last control point on the right.
- Negative scaling, (e.g. negative local Y on the taper curve) is possible as well. However, rendering artifacts may appear.
- Might need to increase the curve resolution to see more detail of the taper.

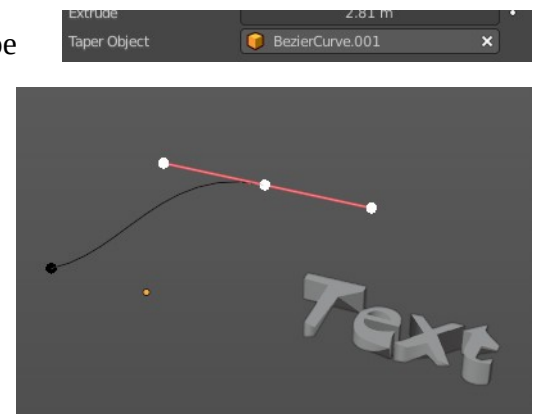

With closed curves, the taper curve in Taper Object acts along the whole curve (perimeter of the object), not just the length of the object, and varies the extrusion depth. In these cases, you want the relative height of the Taper Object Taper curve at both ends to be the same, so that the cyclic point (the place where the endpoint of the curve connects to the beginning) is a smooth transition.

Map Taper

For curves using a Taper Object and with modifications to the Start/End Bevel Factor. The Map Taper option will then apply the taper to the beveled part of the curve, and not the whole curve.

Bevel

A curve can not only be extruded, but the extruded geometry can also be beveled.

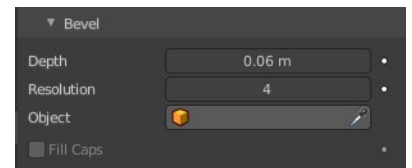
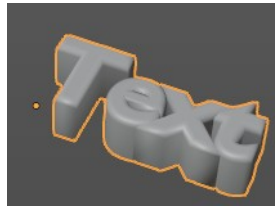

Depth

The size of the bevel.

Resolution

The subdivision of the bevel.

Object

Use another curve object to define the shape of the bevel. This curve can be closed, a Bezier circle for example. Or open. Which creates an open bevel shape then. Be careful with using this at a text object.

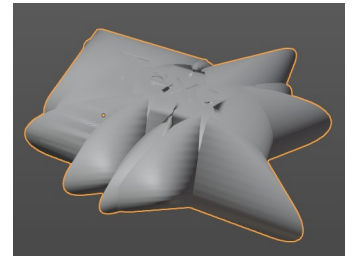

Fill Caps

Fills the ends of a beveled curve created by another curve object. And creates a solid object. Note that this makes for a text object no sense since an n extruded Text object is already a closed object.

Font panel

Manage the fonts that gets used for the Text object. By default the internal Bfont is used.

You need to load the file for each style separately.

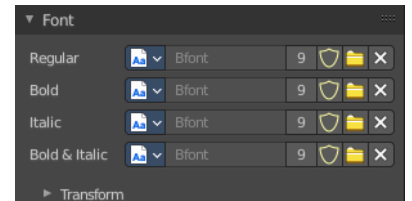

Regular, Bold, Italic, Bold& Italic

The fonts.

Data Browser

A list of the available fonts in the scene.

Name

The name of the active font.

Number of Users

The number of users for this font.

Fake User

Keep this font in the scene even if it has no fake user. Note that the builtin Bfont does not require a fake user to stay available.

Open Font

Load a font.

Location of Fonts in Windows

C:\Windows\Fonts

Location of Fonts on Unix

Fonts are typically located under /usr/lib/fonts, or some variant like /usr/lib/X11/fonts, but not always. They may be in other locations as well, such as /usr/share/local or /usr/local/share, and possibly related sub-trees.

Remove font

Removes the font as the active font. It is still in the list though.

Style

Edit mode only. Choose what style to use to write the text.

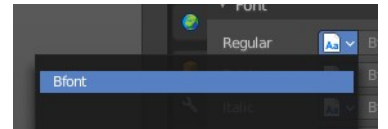

Transform

Size

Controls the size of the text.

Shear

Shears the text.

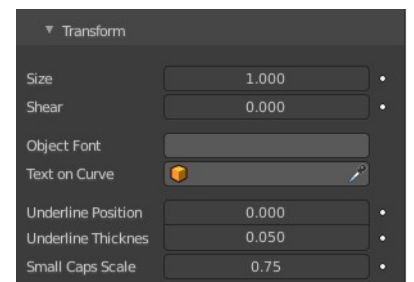
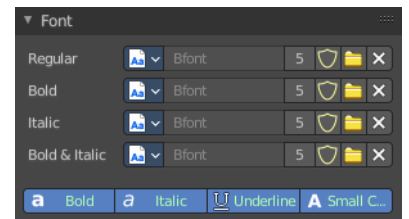

Object Font

Allows individual objects to be used to render fonts.

How to

Create the font characters. Each character can be any object type (mesh, curve, etc.). They must all have a name following the naming schema: “common prefix” followed by the “character name” (“myfont.a”, “myfont.b”, etc.).

For the text object, enable Instancing Vertices.

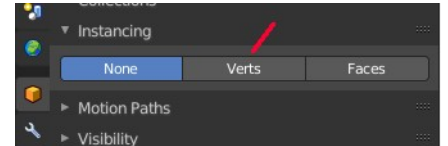

In the Font tab, fill the Object Font field with the “common prefix” of your “font” objects. Now, each time a character in your text matches the suffix part of a “font” object’s name, this object is duplicated on this character.

Note! The objects are duplicated so that their center is positioned at the lower right corner of the corresponding characters.

Text on Curve

Show the text aligned at a curve.

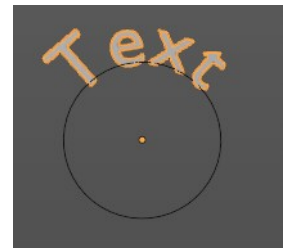

Underline Position

Shift vertically the position of the underline.

Underline Thickness

This controls the thickness of the underline.

Small Caps Scale

The scaling applied to capital letters to turn them into small caps.

Paragraph panel

Alignment sub tab

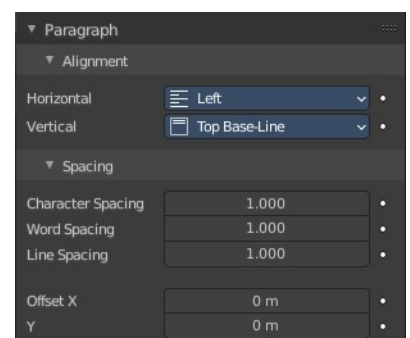

Horizontal Alignment

How to align the text horizontally.

Left

Aligns text to the left of the frames when using them, else uses the origin of the text object as the starting point of the text (which grows to the right).

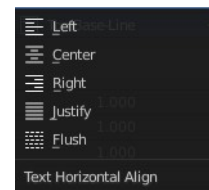

Center

Centers text in the frames when using them, else uses the origin of the text object as the mid-point of the text (which grows equally to the left and right).

Right

Aligns text to the right of the frames when using them, else uses the origin of the text object as the ending point of the text (which grows to the left).

Justify

Only flushes a line when it is terminated by a word-wrap (not by a newline), and uses white-space instead of character spacing (kerning) to fill lines.

Flush

Always flushes the line, even when it is still being typed-in. It uses character spacing (kerning) to fill lines.

Note! Both Justify and Flush only work within frames.

Vertical Alignment

How to align the text vertically.

Top Base-Line

With text boxes, aligns the 'top' base-line of the text to the top of the frames.

With no text box, aligns the actual base-line of the text to the origin of the object, and grows to the bottom.

Note! That difference of reference point in the first line depending on usage of boxes or not is indeed confusing.

Top

With text boxes, aligns the top of the text to the top of the frames.

With no text box, aligns the top of the text to the origin of the object, and grows to the bottom.

Center

With text boxes, centers the text in the frames.

With no text box, centers the text on the origin of the object, and grows in both top and bottom directions equally.

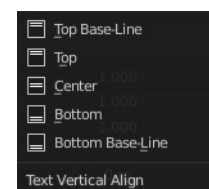

Bottom

With text boxes, align the bottom of the text to the bottom of the frames.

With no text box, align the bottom of the text to the origin of the object, and grows to the top.

Bottom Base-Line

With text boxes, aligns the base-line of the text to the bottom of the frames.

With no text box, aligns the base-line of the text to the origin of the object, and grows to the top.

Spacing sub tab

Character Spacing

A factor by which space between each character (kerning) is scaled in width.

In Edit Mode in the 3D View, you can also control individual kerning at text cursor position by pressing Alt-Left / Alt-Right to decrease/increase it.

Word Spacing

A factor by which white-space between words is scaled in width.

Line Spacing

A factor by which the vertical space between lines is scaled.

Offset X/Y

These settings control the X and Y offset of the text position within the object. This applies relatively to the object's origin, either to the whole text or, when using text boxes, to each frame.

Text Boxes panel

Text boxes (or frames) allow you to distribute the text among rectangular areas within a single text object. You can use more than one box.

The text flows continuously from the lowest-numbered frame to the highest-numbered frame with text inside each frame word-wrapped. It flows between frames when a lower-numbered frame cannot fit any more text.

By increasing size X and Y the text box becomes visible in the viewport by orange lines. A size of 0 means no text box is used.

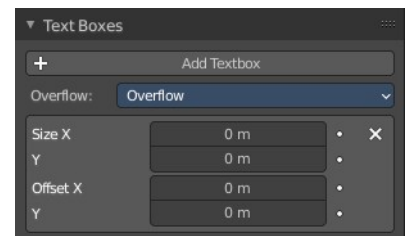

Add Text box

Inserts a new frame, just after the current one (in text flow order). The new frame will have the same size and position as the selected one.

Overflow

How to handle text overflowing available space in the defined boxes.

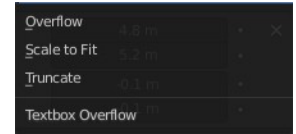

Overflow

Just keep text running out of the last box.

Scale to Fit

Scale text to fit into the available space.

Truncate

Hide the end of the text that does not fit into the available space.

Note! It will only truncate in Object Mode, in Edit Mode the whole text remains visible (and overflows as needed).

Text box

Delete X

Delete the current text box frame.



Size X/Y

Specifies the width and height of the text box, if set to zero no word-wrap happens (it is ignored, and the whole text box system is disabled if all are set to a null size).

Offset X/Y

Controls the X and Y offset of the frame, i.e. its position.

Custom Properties Panel

Here you can define custom properties that can be used for scripting.

Here you might also find custom properties from addons or scripts.

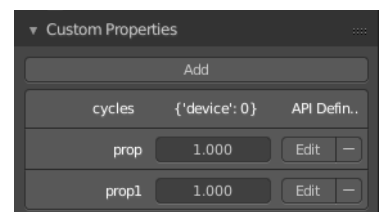

Add

Adds a new property.

Edit

Opens a panel where you can adjust the settings for the custom property.

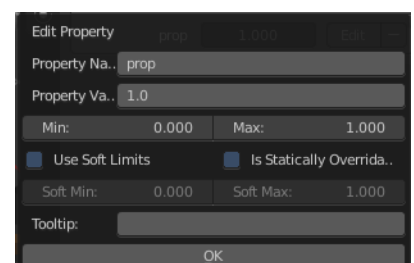

Remove

Removes the property.



26.14.6 Editors - Properties Editor - Object Data Properties Tab - Volume Object

Table of content

Grids panel.....	2
List.....	2
Drag Handler.....	2
Search Field.....	2
Invert.....	2
Sort by Name.....	2
OpenVDB File panel.....	2
File Path.....	2
Load File.....	2
Sequence.....	2
Frames.....	2
Start.....	2
Offset.....	2
Sequence Mode.....	3
Clip.....	3
Extend.....	3
Repeat.....	3
Ping-Pong.....	3
Viewport Display panel.....	3
Wireframe.....	3
None.....	3
Bounds.....	3
Boxes.....	3
Points.....	3
Detail.....	3
Course.....	4
Fine.....	4
Density.....	4
Interpolation.....	4
Slice subpanel.....	4
Axis.....	4
Position.....	4
Render panel.....	4
Space.....	4
Object.....	4
World.....	4
Step Size.....	4
Clipping.....	5
Custom Properties Panel.....	5
Add.....	5
Edit.....	5
Remove.....	5

Grids panel

List

OpenVDB can contain multiple grids which represent different “layers” of volume. The List Views shows all the grids in the OpenVDB-file along with its name and data type. It is read only.



Drag Handler

The two vertical lines at the end is a handler with which you can expand the list.

Search Field

You can expand a search field at the bottom of the list. Type in your term and hit enter to filter for your term.



Invert

Exclude the search term instead of searching for it.

Sort by Name

Sort the List by name.

OpenVDB File panel

File Path

The file path to the vdb file.

Load File

Load an vdb file.

Sequence

Load the OpenVDB-file as an animation loading separate files for individual frames. Ticking this checkbox reveals further functionality.

Frames

Number of frames of the sequence to use.

Start

Global starting frame of the sequence, assuming the first frame has a 1 in the file name.

Offset

Offset the number of the frame to use in the animation.

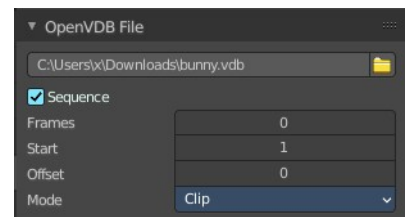
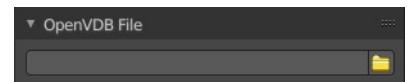

Sequence Mode

Animation setting of the volume sequence before the start frame and after the end frame.

Clip

Hides frames outside the specified frame range.

Extend

Repeats the start frame before, and the end frame after the frame range.

Repeat

Cycles the frames in the sequence; restarting at frame one.

Ping-Pong

Repeats the frames, reversing the playback direction on every other cycle.

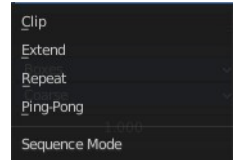

Viewport Display panel

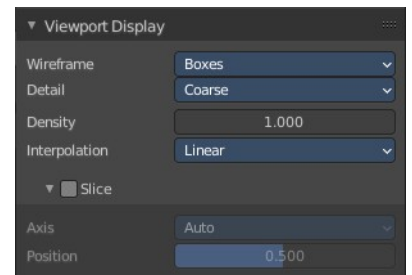

Wireframe

Method used to represent volumes in wire frame shading mode. For heavy volume data sets, it can be useful to set the object to always display as wire frame. This way the 3D Viewport remains responsive but the volume still appears in the final render.

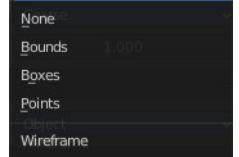

None

The volume is not displayed in wire frame mode.

Bounds

Displays the volume as bounding box for the entire volume grid.

Boxes

Displays a bounding boxes for nodes in the volume tree.

Points

Displays points for nodes in the volume tree.

Detail

The amount of detail to display for Boxes or Points wire frame mode.

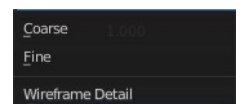

Course

Display one box or point for each intermediate tree node.

Fine

Display a box or point for each leaf node containing 8×8 voxels.

Density

Thickness of the volume in the 3D Viewport. The density of the volume in the render is adjusted via Volume Shading.

Interpolation

The interpolation method to use for the volumes in solid mode.

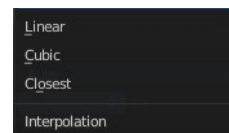

Slice subpanel

Slice the domain object along a single axis.

Axis

Auto slices the domain object along the view direction. X Y and Z along the world axis.

Position

The position of the slice.

Render panel

Space

Specifies how volume density and step size are computed relative either to the object or world.

Object

Keeps volume Density and Detail the same regardless of object scale.

World

Specify Step Size and Density in world space.

Step Size

Cycles Only.

Distance between volume samples. Lower values render more detail at the cost of performance. If set to zero, the step size is automatically determined based on voxel size.

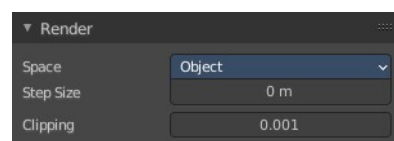
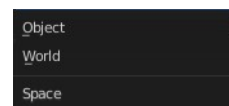
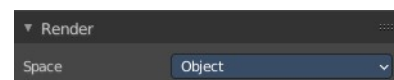

Clipping

Cycles Only.

Value under which voxels are considered empty space to optimize rendering.

Custom Properties Panel

Here you can define custom properties that can be used for scripting.

Here you might also find custom properties from addons or scripts.

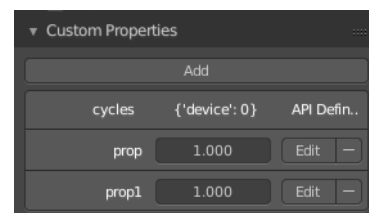

Add

Adds a new property.

Edit

Opens a panel where you can adjust the settings for the custom property.

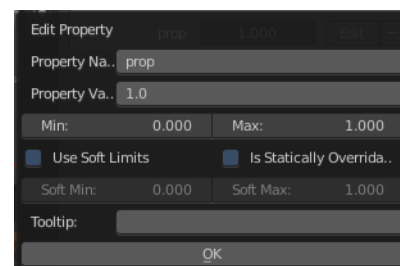

Remove

Removes the property.



26.14.7 Editors - Properties Editor - Object Data Properties Tab - Grease Pencil Object

Table of content

Detailed table of content.....	2
Layers panel.....	5
Layer list.....	5
Add new layer.....	5
Remove layer.....	5
Layer Specials.....	6
Move Grease Pencil Layer up or down.....	6
Isolate Layer.....	6
Isolate Layer.....	6
Blend.....	7
Opacity.....	7
Use Lights.....	7
Autolock inactive layer.....	7
Disallow Locked Materials Editing.....	7
Layers panel - Masks subpanel.....	7
List view.....	7
Add.....	7
Subtract.....	8
Move Up / Down.....	8
Layers panel - Transform subpanel.....	8
Layers panel - Adjustment subpanel.....	8
Tint Color.....	8
Stroke Thickness.....	8
Layers panel - Relations subpanel.....	8
Parent.....	8
Type.....	9
Bone.....	9
Pass Index.....	9
View Layer.....	9
Layers panel - Display subpanel.....	9
Custom Channel Color.....	9
Show Only On Keyframed.....	9
Onion Skinning Panel.....	9
Mode.....	10
Opacity.....	10
Filter By Type.....	10
Keyframes Before/After.....	10
Custom Colors.....	10
Display.....	10
Vertex groups panel.....	11
Active Vertex Group list.....	11
Add +.....	11
Remove -.....	12
Move Vertex Group Up.....	12
Move Vertex Group Down.....	12

Assign.....	12
Remove.....	12
Select.....	12
Deselect.....	12
Weight.....	12
Strokes panel.....	12
Stroke Depth Order.....	12
Stroke Thickness.....	13
Thickness Scale.....	13
Curve Resolution.....	13
Viewport Display panel.....	13
Edit Line Color.....	13
Canvas.....	13
Custom Properties Panel.....	14
Add.....	14
Edit.....	14
Remove.....	14

Detailed table of content

Detailed table of content

Detailed table of content.....	2
Layers panel.....	5
Layer list.....	5
Layer name.....	5
Mask Layer.....	5
Onion Skinning.....	5
Viewport/Render Visibility.....	5
Lock.....	5
Search Field.....	5
Add new layer.....	5
Remove layer.....	5
Layer Specials.....	6
Duplicate Layer.....	6
Show All.....	6
Hide Others.....	6
Lock All.....	6
Unlock All.....	6
Merge Down.....	6
Merge All.....	6
Copy Layer to Selected.....	6
Copy all Layers to Selected.....	6
Move Grease Pencil Layer up or down.....	6
Isolate Layer.....	6
Isolate Layer.....	6
Blend.....	7
Opacity.....	7
Use Lights.....	7
Autolock inactive layer.....	7
Disallow Locked Materials Editing.....	7
Layers panel - Masks subpanel.....	7

List view.....	7
Name of the grease pencil layer.....	7
Invert.....	7
Hide.....	7
Search Field.....	7
Add.....	7
Subtract.....	8
Move Up / Down.....	8
Layers panel - Transform subpanel.....	8
Layers panel - Adjustment subpanel.....	8
Tint Color.....	8
Factor.....	8
Stroke Thickness.....	8
Layers panel - Relations subpanel.....	8
Parent.....	8
Type.....	9
Bone.....	9
Pass Index.....	9
View Layer.....	9
Use Masks in Render.....	9
Layers panel - Display subpanel.....	9
Custom Channel Color.....	9
Show Only On Keyframed.....	9
Onion Skinning Panel.....	9
Mode.....	10
Frames.....	10
Keyframes.....	10
Selected.....	10
Opacity.....	10
Filter By Type.....	10
Keyframes Before/After.....	10
Custom Colors.....	10
Display.....	10
View in render.....	10
Fade.....	10
Loop.....	11
Vertex groups panel.....	11
Active Vertex Group list.....	11
Group name.....	11
Lock.....	11
Drag Handler.....	11
Search Field.....	11
Invert.....	11
Sort by Name.....	11
Add +.....	11
Remove -.....	12
Move Vertex Group Up.....	12
Move Vertex Group Down.....	12
Assign.....	12
Remove.....	12
Select.....	12
Deselect.....	12
Weight.....	12

Strokes panel.....	12
Stroke Depth Order.....	12
2D Layers.....	12
3D Location.....	12
Stroke Thickness.....	13
World Space.....	13
Screen Space.....	13
Thickness Scale.....	13
Curve Resolution.....	13
Viewport Display panel.....	13
Edit Line Color.....	13
Canvas.....	13
Color.....	13
Scale X/Y.....	13
Offset X/Y.....	13
Subdivisions.....	14
Custom Properties Panel.....	14
Add.....	14
Edit.....	14
Remove.....	14

Layers panel

Grease Pencil objects each have a list of 2D layers for grouping and arranging strokes in a List view. Any stroke can only belong to a single 2D layer. There is always only one active layer in the list (the selected one). When you draw, the new strokes are added to the active layer. By default the view order of the layers in the viewport is top to bottom.

Every layer correspond to a channel in the Dope Sheet editor (in Grease Pencil mode). Layers can also be used together with Modifiers to only affects part of your drawing.

Layer list

Layer name

The name of the layer.

Mask Layer

Toggle the Masks visibility in the layer.

Onion Skinning

Toggle the use the layer for Onion Skinning.

Viewport/Render Visibility

Toggle layer visibility in the viewport and in render.

Lock

Toggle layer from being editable.

Search Field

You can expand a search field at the bottom of the list. Type in your term and hit enter to filter for your term.

Add new layer

Adds a new layer.

Remove layer

Removes the selected layer.

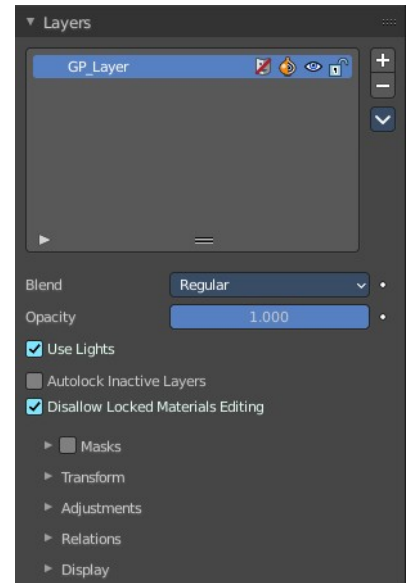

Layer Specials

Duplicate Layer

Makes an exact copy of the selected layer appending a number to differentiate its name.

Show All

Turns on the visibility of every layer in the list.

Hide Others

Turns off the visibility of every layer in the list except the active one.

Lock All

Locks edition of all the layers in the list

Unlock All

Unlocks edition of all the layers in the list.

Merge Down

Merge the selected layer with the layer below. The new layer keeps the name of the lower layer.

Merge All

Merge the selected layer with all layers. The new layer keeps the name of the active layer.

Copy Layer to Selected

Appends the active layer to the selected object.

Copy all Layers to Selected

Appends all layers to the selected object.

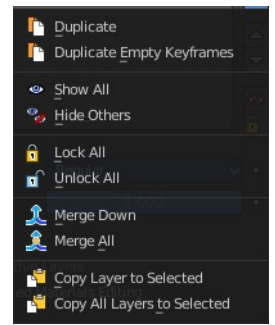

Move Grease Pencil Layer up or down

Move Grease Pencil Layer up or down

Isolate Layer

Hide and lock the layer.

Isolate Layer

Lock the layer.

Blend

The layer blending operation to perform. See Color Blend Modes.

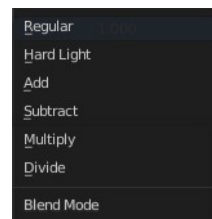

Opacity

Used to set the opacity of the layer.

Use Lights

When enabled, the layer is affected by lights.

Autolock inactive layer

Locks automatically the edition of every layer in the list except the active one. This way you avoid to make unwanted changes in other layers without the need to lock them every time.

Disallow Locked Materials Editing

Disallow the editing of locked materials.

Layers panel - Masks subpanel

Use another grease pencil layer as a mask.

List view

Name of the grease pencil layer

The name of the layer.

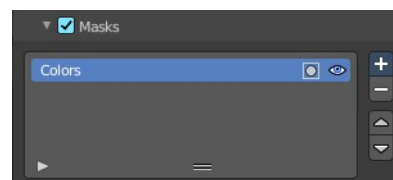

Invert

Invert the mask.

Hide

Set mask layer visible or invisible.

Search Field

You can expand a search field at the bottom of the list. Type in your term and hit enter to filter for your term.



Add

Add a grease pencil layer as a mask layer. The layer must already exist.

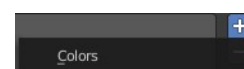

Subtract

Remove the grease pencil layer from the list.

Move Up / Down

Move the selected grease pencil mask one up or one down.

Layers panel - Transform subpanel

Allows to transform the current grease pencil layer in the 3d view.



Layers panel - Adjustment subpanel

Tint Color

Color that tint any material colors used in the layer.

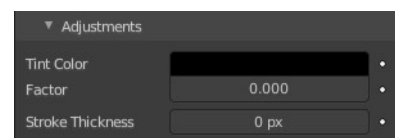

Factor

The Factor controls the amount of tint color to apply.

Stroke Thickness

Thickness value that override the strokes thickness in the layer.

Layers panel - Relations subpanel

Select a Parent object and Type to manipulate the layer. The layer will inherit the transformations of the parent.

This can be used for rigging for cut-out animation.

Parent

The Parent object.

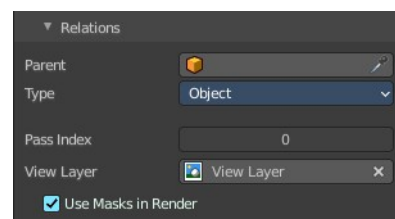

Type

What type of object. When the parent is an armature, then you can choose between object, armature or bone.

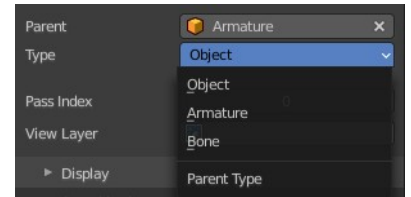

Bone

When the type is a bone, then choose which bone of the armature.

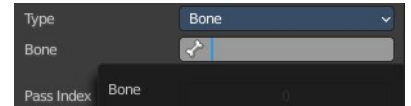

Pass Index

The layer index number. It can be used with some modifiers to restrict changes to only certain areas.

View Layer

Defines the View Layer to use for the Grease Pencil layer. If empty, the layer will be included in all View Layers. This is useful to separate drawings parts for compositing.

Use Masks in Render

Include the mask layer when you render the view layer. You need to have a view layer selected to reveal this option.

Layers panel - Display subpanel

Custom Channel Color

Sets the color to use in the channel region of the Dope Sheet.

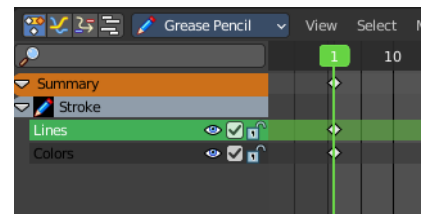
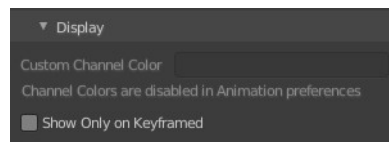

Show Only On Keyframed

The layer is just visible in the viewport if it has a keyframe in the actual frame.



Onion Skinning Panel

Onion Skinning show ghosts of the keyframes before and after the current frame. This allows animators to judge and pose in between two frames.

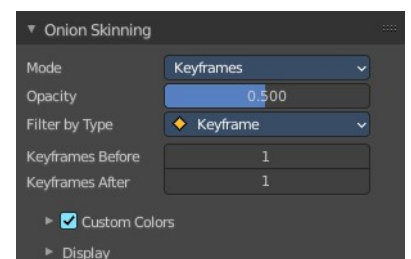

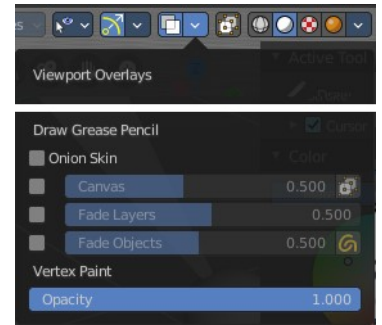

Mode

Frames

Shows Frames in the range determined by the Before/After settings.

Keyframes

Shows Keyframes in the range determined by the Before/After settings.

Selected

Shows only on the manually selected keyframes in the Dope Sheet.

Opacity

Control the opacity of the ghost frames.

Filter By Type

Filters what type of frames to show in the Onion Skinning range.

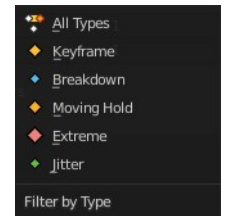
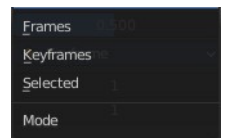

Keyframes Before/After

Sets how many frames or keyframes, depending on the Mode, to show before and after the current frame.

Custom Colors

Before/After

Custom color of the ghost frames before and after the current frame.

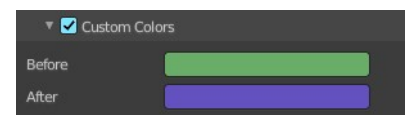

Display

View in render

Show the onion skinning in final render image e.g. for a motion blur effect.

Fade

Opacity of the ghosts frames decrease the further away from the current frame.

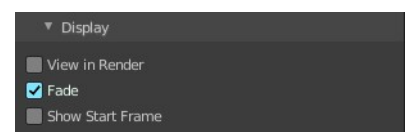

Loop

Help working on loop animations showing the first keyframe/frame as ghost when you are on the last frame of your animation.

Vertex groups panel

A Vertex group is a group of vertices, a selection of the mesh. It is for example used to weight a specific mesh part to a bone. Or to control the growth of hair particles.

This panel allows you to manage and edit vertex groups. Weight painting creates vertex groups automatically.

In Edit mode this panel shows the inactive controls active.

Vertex groups exists for mesh and lattice objects.

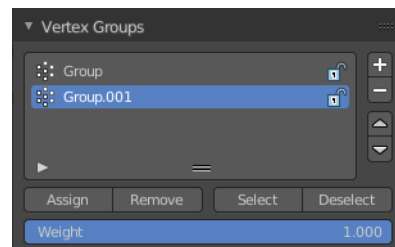

Active Vertex Group list

A List of the vertex groups for this mesh.

Group name

The name of the group. It can be renamed by double clicking at it.

Lock

The lock icon at the end of a group name locks the group from being editable.

Drag Handler

The two vertical lines at the end is a handler with which you can expand the list.

Search Field

You can expand a search field at the bottom of the list. Type in your term and hit enter to filter for your term.



Invert

Exclude the search term instead of searching for it.

Sort by Name

Sort the List by name.

Add +

Create an empty vertex group.

Remove -

Deletes the active vertex group.

Move Vertex Group Up

Moves the selected vertex group up in the list.

Move Vertex Group Down

Moves the selected vertex group down in the list.

Assign

Assign the selected vertices to the active vertex group.

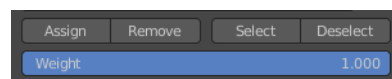

Remove

Remove the selected vertices from the active group.

Select

Select all vertices in the group.

Deselect

Deselect all vertices in the group.

Weight

The weight value that gets assigned to the selected vertices.

Strokes panel

General settings for Grease Pencil strokes.

Stroke Depth Order

2D Layers

The Strokes drawing order respect the order of the 2D layers list (top to bottom) and ignores the real position of the strokes in 3D space. See 2D Layers for more information.

3D Location

The strokes drawing order is based on the stroke location in 3D space.

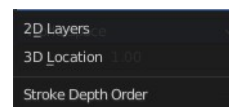
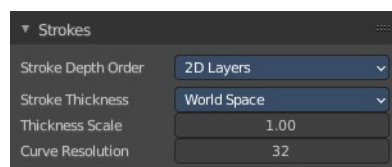

Stroke Thickness

World Space

The thickness is relative to world space. Stroke thickness change with the screen zoom factor.



Screen Space

The thickness is relative to screen space. Stroke thickness remains the same regardless of the screen zoom factor.

Thickness Scale

Sets a thickness scale factor for all strokes.

Curve Resolution

The number of segments generated between two control points when editing strokes in curve edit mode.

Viewport Display panel

Display settings for Edit Lines in Edit Mode and Sculpt Mode.

Edit Line Color

Sets the color of the Edit Lines.

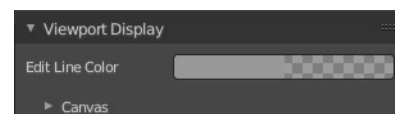

Canvas

In 3D space sometimes is difficult to assess on which plane are you drawing. The Canvas is a display overlay helper that shows a grid at the current Drawing Plane. You can enable the Canvas visualization in the Viewport Overlays.

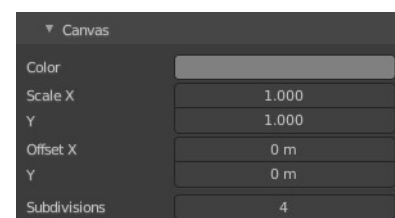

Color

Color of the Canvas grid lines.

Scale X/Y

Defines the X and Y scale of the Canvas.

Offset X/Y

Sets the Canvas position offset from the object's origin.

Subdivisions

Specifies the number of subdivisions to use for the grid.

Custom Properties Panel

Here you can define custom properties that can be used for scripting.

Here you might also find custom properties from addons or scripts.

Add

Adds a new property.

Edit

Opens a panel where you can adjust the settings for the custom property.

Remove

Removes the property.

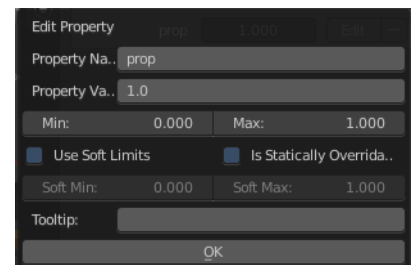
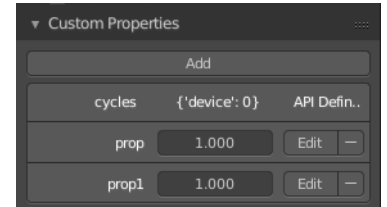



26.14.8 Editors - Properties Editor - Object Data Properties Tab - Armature Object

Table of content

Detailed table of content.....	1
Skeleton panel.....	4
Position.....	4
Layers.....	4
Protected Layers.....	4
Bone Groups panel.....	5
List View.....	5
Add / Remove.....	5
Bone Group Specials.....	5
Move Bone Group Up / Down.....	5
Color Set.....	6
Assign.....	6
Remove.....	6
Select.....	6
Deselect.....	6
Pose Library (Legacy) Panel.....	6
Motion Paths panel.....	6
Workflow.....	7
Paths Type.....	7
Frame Range Start.....	7
End.....	7
Step.....	7
Bone Cache from.....	7
To.....	8
Calculate	8
Update Paths.....	8
Update All Paths.....	8
Clear Paths.....	8
Display subpanel.....	8
Viewport Display panel.....	9
Display As.....	9
Names.....	10
Shapes.....	10
Group Colors.....	10
In Front.....	10
Axes.....	10
Inverse Kinematics panel.....	10
IK Solver.....	11
Custom Properties Panel.....	15
Add.....	15
Edit.....	15
Remove.....	15

Detailed table of content

Detailed table of content

Detailed table of content.....	1
Skeleton panel.....	4
Position.....	4
Layers.....	4
Protected Layers.....	4
Bone Groups panel.....	5
List View.....	5
Drag Handler.....	5
Search Field.....	5
Invert.....	5
Sort by Name.....	5
Add / Remove.....	5
Bone Group Specials.....	5
Sort Bone Groups.....	5
Move Bone Group Up / Down.....	5
Color Set.....	6
Bone Color Set.....	6
Assign.....	6
Remove.....	6
Select.....	6
Deselect.....	6
Pose Library (Legacy) Panel.....	6
Motion Paths panel.....	6
Workflow.....	7
Paths Type.....	7
In Range.....	7
Around Frame.....	7
Frame Range Start.....	7
End.....	7
Step.....	7
Bone Cache from.....	7
To.....	8
Calculate	8
Start.....	8
End.....	8
Bake Location.....	8
Update Paths.....	8
Update All Paths.....	8
Clear Paths.....	8
Display subpanel.....	8
Frame Numbers.....	8
Keyframes.....	8
+ Non-Grouped Keyframes.....	9
Keyframe Numbers.....	9
Lines.....	9
Thickness.....	9
Custom Color.....	9
Viewport Display panel.....	9
Display As.....	9
Octahedral.....	9
Stick.....	9

B-Bone.....	9
Envelope.....	10
Wire.....	10
Names.....	10
Shapes.....	10
Group Colors.....	10
In Front.....	10
Axes.....	10
Position.....	10
Inverse Kinematics panel.....	10
IK Solver.....	11
Standard.....	11
iTASC.....	11
Mode.....	11
Animation.....	11
Precision.....	11
Iterations.....	11
Solver.....	11
SDLS.....	11
DLS.....	12
Damping Max.....	12
Damping Epsilon.....	12
Simulation.....	12
Reiteration.....	12
Never.....	12
Initial.....	12
Always.....	12
Precision.....	13
Iterations.....	13
Solver.....	13
SDLS.....	13
Feedback.....	13
Max Velocity.....	13
DLS.....	14
Feedback.....	14
Max Velocity.....	14
Damping Max.....	14
Damping Epsilon.....	14
Auto Step.....	14
Steps.....	14
Min.....	15
Max.....	15
Custom Properties Panel.....	15
Add.....	15
Edit.....	15
Remove.....	15

Skeleton panel

This panel allows you to turn the display for bone and armature layers on and off.

Position

Switch between Pose Position and Rest Position.

Pose position shows the armature in the currently posed state.

Rest Position shows the armature in the rest position. In Rest Pose mode there is no posing possible.

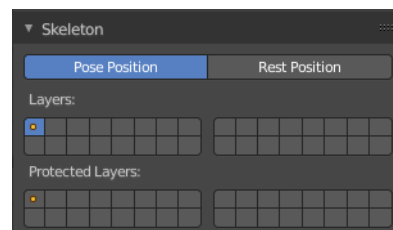

Layers

Each armature has 32 Armature layers. They allow you to organize your armature.

The orange dot means there is a bone or an armature in this layer. Blue means this layer is visible. To set a layer to visible or hidden simply click at it. To make more than one layer visible or hidden, hold down shift and click.

To move a bone or an armature to another layer go either to pose mode or to edit mode.

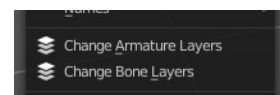

Select the bones or the armature that you want to move to another layer.

In Pose mode go to Pose menu, and choose Change Bone Layer. Or Change Armature Layer.

In Edit mode go to Armature menu, and choose Change Bone Layer. Or Change Armature Layer.

In the menu that comes up choose the slot that you want to move the bone or armature to.

Bones can be at more than one layer. Hold down shift and click to add the bone or armature to several layers.



Protected Layers

Protected layers has to do with linked blend files with armatures. You can lock a given bone layer for all proxies of your armature. This means bones in this layer will not be editable. To do so, in the Skeleton panel, Ctrl-LMB click on the relevant button, the layer lock will be enabled. And the bone will not be editable in other blend files where it is linked to.

Protected layers in proxy are restored to proxy settings on file reload and undo.

Note that this feature is deprecated. Proxies will be replaced by Library Overrides soon.

Proxies are the historical way in Blender to allow some local editing of linked data-blocks. This is mostly aimed at character animation. One of their most important restrictions is that you can only have one proxy of any linked object in a given blend-file.

Bone Groups panel

This panel allows the creation, deletion and editing of Bone Groups.

Bone Groups can be used for selection. Or to assign a color theme to a set of bones. For example to color the left parts of the rig as blue and right parts as red.

Bone groups is a Pose Mode feature. The controls will be disabled in Object and Edit mode.

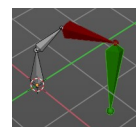
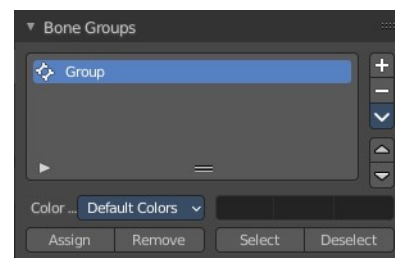

List View

The List view with the bone groups. Double clicking at the name makes it editable.

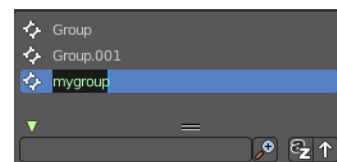

Drag Handler

The two vertical lines at the end is a handler with which you can expand the list.

Search Field

You can expand a search field at the bottom of the list. Type in your term and hit enter to filter for your term.



Invert

Exclude the search term instead of searching for it.

Sort by Name

Sort the List by name.

Add / Remove

Add or remove a bone group.

Bone Group Specials

Sort Bone Groups

Sort the bone groups by their names in ascending order.

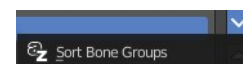

Move Bone Group Up / Down

Move the selected bone group up or down in the list.

Color Set

Use a color theme for your bone group.

Bone Color Set

A set of predefined bone color sets. Each set is made of three colors.

Normal

The first color field is the color of unselected bones.

Selected

The second color field is the outline color of selected bones.

Active

The third color field is the outline color of the active bone.

The custom color set is editable. The other color sets are fixed.

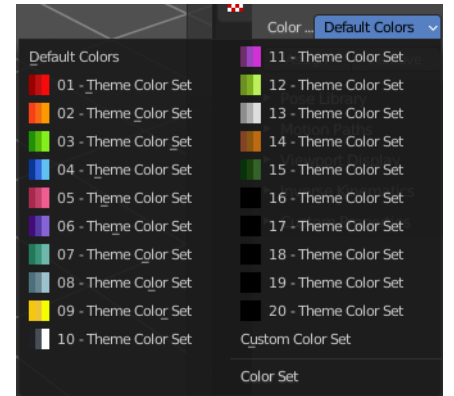

Assign

Assigns the selected bones to the active bone group. Note! A bone can only belong to one group.



Remove

Removes the selected bones from the active bone group.

Select

Selects the bones in the active bone group.

Deselect

Deselects the bones in the active bone group.

Pose Library (Legacy) Panel

This panel is deprecated and will be removed soon. Poses are now stored in the asset browser.

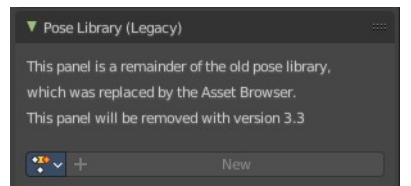

Motion Paths panel

Motion paths allows you to visualize motion paths of animated bones.

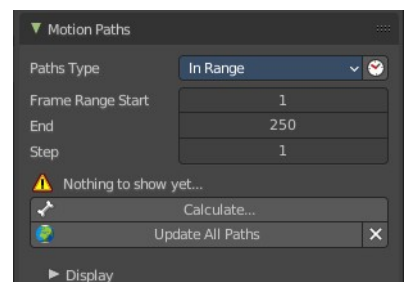

Workflow

Select the bones that you want to calculate a path for. Note that they should have an animation. No animation, no motion path.

Click at the Calculate button.

When you change the animation then you might need to update the paths.

To remove the paths, click at the X button at the Update paths button.

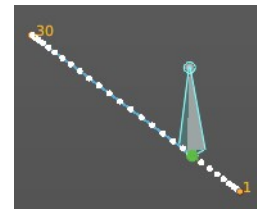

Note! Remember that only selected bones and their paths are affected by these actions!

The paths are shown in a light shade of gray for unselected points, and a slightly blueish gray for selected ones. Around the current frame a glow indicate the direction of movement: blue towards future frames and green towards the past. Each frame is displayed by a small white dot on the paths.

The paths are automatically updated when you edit your poses/keyframes, and they are also active during animation playback. Playing the animation affects the paths only when the Around Current Frame option is enabled.

Paths Type

In Range

Display paths of points within specified range.

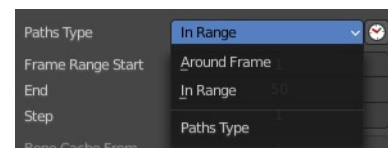

Around Frame

Display paths of points within a fixed number of frames around the current frame. When you enable this button, you get paths for a given number of frames before and after the current one (again, as with ghosts).

Frame Range Start

The start frame for the paths calculation. (not for Around Current Frame Onion-skinning method).

End

The end frame for the paths calculation. (not for Around Current Frame Onion-skinning method).

Step

Display one point for every n frames on the path.

Bone Cache from

The start frame of the range in which motion paths are shown. You cannot modify this range without deleting the motion path first.

To

The end frame of the range in which motion paths are shown. You cannot modify this range without deleting the motion path first.

Calculate ...

Calculate Paths will create a new motion path in cache. It will open a popup where you can adjust the settings.

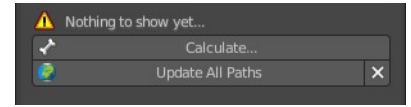

Start

The start frame of the path.

End

The end frame of the path.

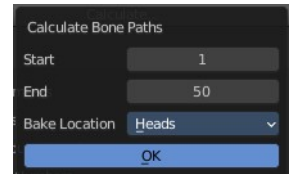

Bake Location

Where to display the path. At the heads of the bones or at the tail of the bones.

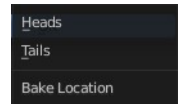

Update Paths

If a path has already been calculated, Update Paths will update the path shape to the current animation. To change the frame range of the calculated path, you need to delete the path and calculate it again.

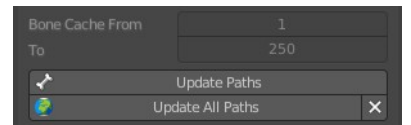

Update All Paths

Update all paths will update not just the path for the selected object, but also for all other paths in the object hierarchy.

Clear Paths

Removes all paths in the hierarchy.

Bone Calculate From and To is internal, and cannot be edited. Just ignore.

Display subpanel

Frame Numbers

Show a small number of the corresponding frame next to each frame dot on the path.

Keyframes

Show the keyframes at the path, with frame number.

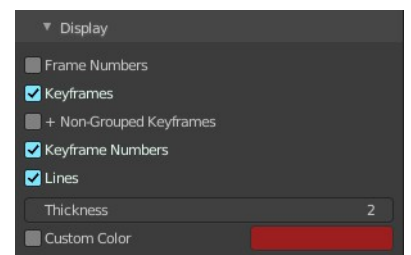

+ Non-Grouped Keyframes

For bone motion paths, it searches the whole Action for keyframes instead of in groups with matching name only (this is slower).

Keyframe Numbers

When enabled, you will see the numbers of the displayed keyframes, so this option is obviously only valid when Show Keys is enabled.

Lines

Toggles whether the lines between the points are shown.

Thickness

Customizable thickness for the lines.

Custom Color

Custom color for the lines.

Viewport Display panel

Display options for bones.

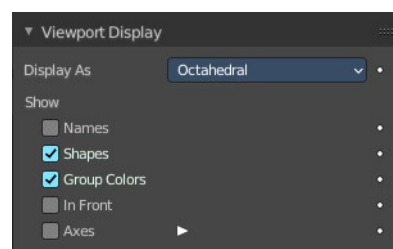

Display As

How the bones are displayed in the 3D Viewport.

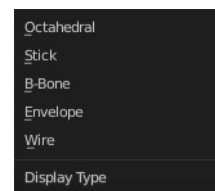

Octahedral

Bones are displayed as a octahedral. With a thick and a thin end.

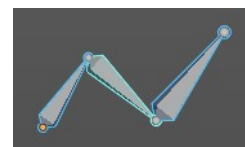

Stick

Bones are displayed as a stick.

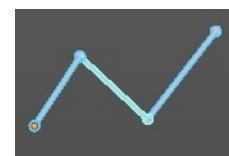

B-Bone

Bones are displayed as a cuboid. This bone display type also allows to display bendy bones subdivisions.

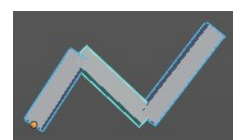

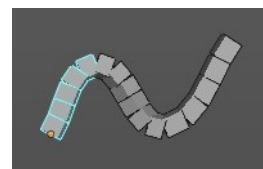
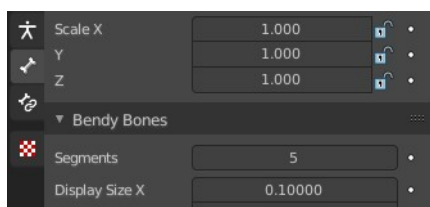

Envelope

Bones are displayed with its envelopes. The bone deformation influence areas.

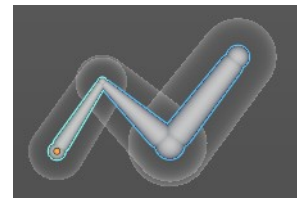

Wire

Bones are displayed as thin wire lines. This bone display type also allows to display bendy bones subdivisions.

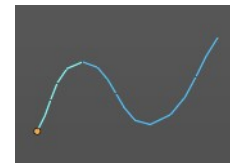
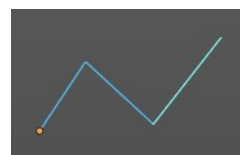

Names

Displays the name of each bone.

Shapes

When enabled, the default standard bone shape is replaced, in Object Mode and Pose Mode, by the shape of a chosen object (see Shaped Bones for details).

Group Colors

Display Bone Group colors to color the bone, if a color set is assigned in the Bone Groups panel.

In Front

Display the armature always in front of mesh objects, even when they are inside.

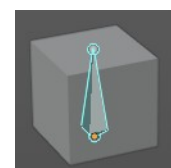

Axes

When enabled, the (local) axes of each bone are displayed (only relevant for Edit Mode and Pose Mode).



Position

You can give the axes widget an offset. Higher values moves the axes more to the tip. Lower values moves the axes more to the root.

Inverse Kinematics panel

Inverse Kinematics settings.

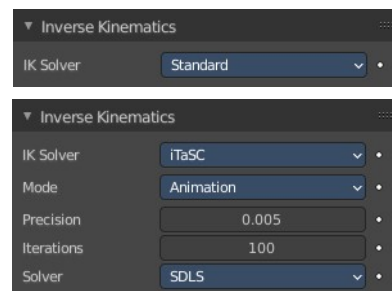

IK Solver

The available IK solver solution. Standard and iTaSC.

Standard

The standard IK solver. It has no further settings.

iTaSC

iTaSC stands for instantaneous Task Specification using Constraints. It is a generic multi-constraint IK solver. It has more settings and works a bit different than the standard IK solver.

Mode

The itasc mode. Animation or Simulation.

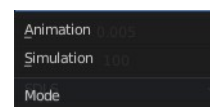

Animation

In Animation mode, iTaSC operates like an IK solver: it is stateless and uses the pose from F-curves interpolation as the start pose before the IK convergence. The target velocity is ignored and the solver converges until the given precision is obtained. Still the new solver is usually faster than the old one and provides features that are inherent to iTaSC: multiple targets per bone and multiple types of constraints.

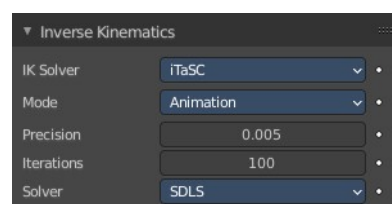

Precision

The maximum variation of the end effector between two successive iterations at which a pose is obtained that is stable enough and the solver should stop the iterations. Lower values means higher precision on the end effector position.

Iterations

The upper bound for the number of iterations.

Solver

Select the inverse Jacobian solver that iTaSC will use.

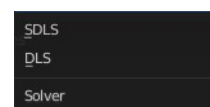

SDLS

Computes the damping automatically by estimating the level of 'cancellation' in the armature kinematics. This method works well with the Copy Pose constraint but has the drawback of damping more than necessary around the singular pose, which means slower movements. Note that this is only noticeable in Simulation

mode.

The SDLS solver does not work together with a Distance constraint. You must use the DLS solver if you are going to have a singular pose in your animation with the Distance constraint.

DLS

Computes the damping manually. Damping and Epsilon must be tuned for each armature. You should use the smallest values that preserve stability.

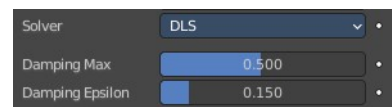

Damping Max

Maximum amount of damping. Smaller values means less damping, hence more velocity and better precision but also more risk of oscillation at singular pose. 0 means no damping at all.

Damping Epsilon

Range of the damping zone around singular pose. Smaller values means a smaller zone of control and greater risk of passing over the singular pose, which means oscillation.

Simulation

The Simulation mode estimates the target's velocity, operates in a 'true time' context, ignores rotation from keyframes (except via a joint rotation constraint) and builds up a state cache automatically.

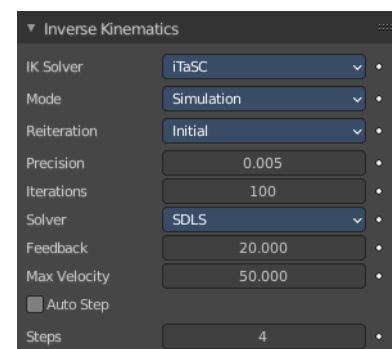

Reiteration

Never

The solver starts from the rest pose and does not reiterate (converges) even for the first frame. This means that it will take a few frames to get to the target at the start of the animation.

Never will grey out most of the options.

Initial

The solver starts from the rest pose and re-iterates until the given precision is achieved, but only on the first frame (i.e. a frame which doesn't have any previous frame in the cache). This option basically allows you to choose a different start pose than the rest pose and it is the default value. For the subsequent frames, the solver will track the target by integrating the joint velocity computed by the Jacobian solver over the time interval that the frame represents. The precision of the tracking depends on the feedback coefficient, number of substeps and velocity of the target.

Always

The solver re-iterates on each frame until the given precision is achieved. This option omits most of the iTaSC

dynamic behavior: the maximum joint velocity and the continuity between frames is not guaranteed anymore in compensation of better precision on the end effector positions. It is an intermediate mode between Animation and real-time Simulation.

Precision

The maximum variation of the end effector between two successive iterations at which a pose is obtained that is stable enough and the solver should stop the iterations. Lower values means higher precision on the end effector position.

Iterations

The upper bound for the number of iterations.

Solver

Select the inverse Jacobian solver that iTaSC will use.

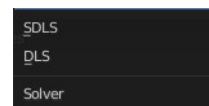

SDLS

Computes the damping automatically by estimating the level of ‘cancellation’ in the armature kinematics. This method works well with the Copy Pose constraint but has the drawback of damping more than necessary around the singular pose, which means slower movements. Note that this is only noticeable in Simulation mode.

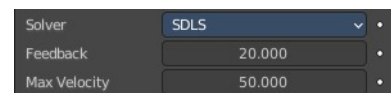

The SDLS solver does not work together with a Distance constraint. You must use the DLS solver if you are going to have a singular pose in your animation with the Distance constraint.

Feedback

Coefficient on end effector position error to set corrective joint velocity. The time constant of the error correction is the inverse of this value. However, this parameter has little effect on the dynamic of the armature since the algorithm evaluates the target velocity in any case. Setting this parameter to 0 means ‘opening the loop’: the solver tracks the velocity but not the position; the error will accumulate rapidly. Setting this value too high means an excessive amount of correction and risk of instability. The value should be in the range 20-100. Default value is 20, which means that tracking errors are corrected in a typical time of 100-200 ms. The feedback coefficient is the reason why the armature continues to move slightly in Simulation mode even if the target has stopped moving: the residual error is progressively suppressed frame after frame.

Max Velocity

Indicative maximum joint velocity in radian per second. This parameter has an important effect on the armature dynamic. Smaller value will cause the armature to move slowly and lag behind if the targets are moving rapidly. You can simulate an inertia by setting this parameter to a low value.

DLS

Computes the damping manually. Damping and Epsilon must be tuned for each armature. You should use the smallest values that preserve stability.

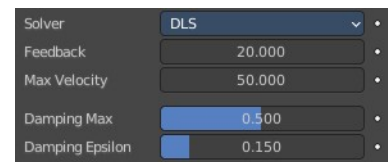

Feedback

Coefficient on end effector position error to set corrective joint velocity. The time constant of the error correction is the inverse of this value. However, this parameter has little effect on the dynamic of the armature since the algorithm evaluates the target velocity in any case. Setting this parameter to 0 means ‘opening the loop’: the solver tracks the velocity but not the position; the error will accumulate rapidly. Setting this value too high means an excessive amount of correction and risk of instability. The value should be in the range 20-100. Default value is 20, which means that tracking errors are corrected in a typical time of 100-200 ms. The feedback coefficient is the reason why the armature continues to move slightly in Simulation mode even if the target has stopped moving: the residual error is progressively suppressed frame after frame.

Max Velocity

Indicative maximum joint velocity in radian per second. This parameter has an important effect on the armature dynamic. Smaller value will cause the armature to move slowly and lag behind if the targets are moving rapidly. You can simulate an inertia by setting this parameter to a low value.

Damping Max

Maximum amount of damping. Smaller values means less damping, hence more velocity and better precision but also more risk of oscillation at singular pose. 0 means no damping at all.

Damping Epsilon

Range of the damping zone around singular pose. Smaller values means a smaller zone of control and greater risk of passing over the singular pose, which means oscillation.

Auto Step

Let the solver set how many substeps should be executed for each frame.

A sub step is a subdivision on the time between two frames for which the solver evaluates the IK equation and updates the joint position. More substeps means more processing but better precision on tracking the targets. The auto step algorithm estimates the optimal number of steps to get the best trade-off between processing and precision. It works by estimation of the non linearity of the pose and by limiting the amplitude of joint variation during a sub step. It can be configured with the min and max parameters.

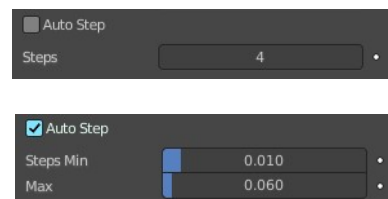

Steps

Auto Step off. Choose a fixed number of substeps with this parameter. Sub step should not be longer than 10 ms, which means the number of steps is 4 for a 25 fps animation. If the armature seems unstable (vibrates) between frames, you can improve the stability by increasing the number of steps.

Min

Auto Step on. Proposed minimum sub step duration (in second). The auto step algorithm may reduce the sub step further based on joint velocity.

Max

Auto Step on. Maximum sub step duration (in second). The auto step algorithm will not allow sub step longer than this value.

Custom Properties Panel

Here you can define custom properties that can be used for scripting.

Here you might also find custom properties from addons or scripts.

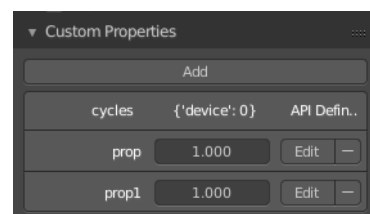

Add

Adds a new property.

Edit

Opens a panel where you can adjust the settings for the custom property.

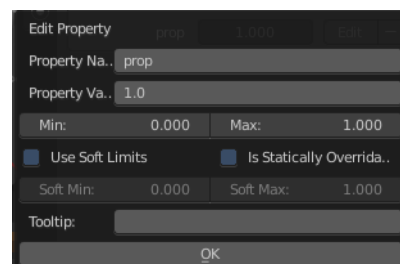

Remove

Removes the property.



26.14.9 Editors - Properties Editor - Object Data Properties Tab - Lattice Object

Table of content

Detailed table of content.....	1
Lattice panel.....	4
Workflow.....	4
Resolution U / V / W.....	4
Interpolation U / V / W.....	4
Outside.....	4
Vertex Group.....	4
Vertex groups panel.....	5
Active Vertex Group list.....	5
Add +.....	5
Remove -.....	5
Specials menu.....	6
Shape Keys panel.....	7
Workflow.....	8
Active Shape Key Index.....	9
Add +.....	9
Remove -.....	9
Specials menu.....	9
Relative.....	10
Custom Properties Panel.....	11
Add.....	12
Edit.....	12
Remove.....	12

Detailed table of content

Detailed table of content

Detailed table of content.....	1
Lattice panel.....	4
Workflow.....	4
Resolution U / V / W.....	4
Interpolation U / V / W.....	4
Outside.....	4
Vertex Group.....	4
Vertex groups panel.....	5
Active Vertex Group list.....	5
Group name.....	5
Lock.....	5
Drag Handler.....	5
Search Field.....	5
Invert.....	5
Sort by Name.....	5
Add +.....	5
Remove -.....	5

Specials menu.....	6
Sort by Name.....	6
Sort by Bone Hierarchy.....	6
Copy Vertex Group.....	6
Copy Vertex Groups to Linked.....	6
Copy Vertex Group to Selected.....	6
Mirror Vertex Group.....	6
Mirror Vertex Group (Topology).....	6
Remove from All Groups.....	6
Clear Active Group.....	6
Delete All Unlocked Groups.....	6
Delete All Groups.....	7
Lock All.....	7
Unlock All.....	7
Lock Invert All.....	7
Move Vertex Group Up / Down.....	7
Assign.....	7
Remove.....	7
Select.....	7
Deselect.....	7
Weight.....	7
Set Active Group.....	7
Shape Keys panel.....	7
Workflow.....	8
Active Shape Key Index.....	9
Shape Key name.....	9
Slider value.....	9
Lock.....	9
Drag Handler.....	9
Search Field.....	9
Invert.....	9
Sort by Name.....	9
Add +.....	9
Remove -.....	9
Specials menu.....	9
New Shape From Mix.....	9
Mirror Shape Key.....	9
Mirror Shape Key (Topology).....	10
Join as Shapes (Transfer Mix).....	10
Transfer Shape Key.....	10
Delete all Shape Keys.....	10
Move to Top.....	10
Move to Bottom.....	10
Move Shape Key Up / Down.....	10
Relative.....	10
Relative.....	10
Shape Key Lock (pin icon).....	10
Shape Key Edit Mode (edit mode icon).....	10
Value.....	11
Range.....	11
Vertex Group.....	11
Relative To.....	11
Absolute.....	11

Shape Key Lock (pin icon).....	11
Shape Key Edit Mode (edit mode icon).....	11
Re-Time Shape Keys (clock icon).....	11
Interpolation.....	11
Evaluation Time.....	11
Custom Properties Panel.....	11
Add.....	12
Edit.....	12
Remove.....	12

Lattice panel

Lattice objects can be used to deform child geometry by the cage of the lattice object.

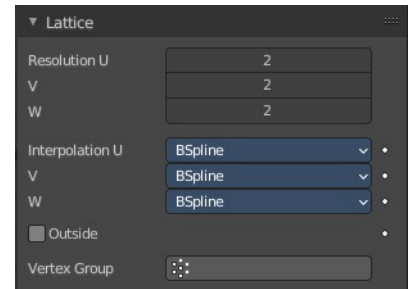

Workflow

Create a lattice. Create a mesh object like a sphere.

Parent this sphere at the lattice. With method Lattice deform.

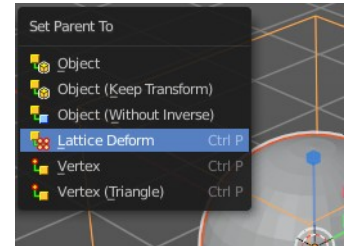

Select the lattice object and enter Edit mode.

Pull the vertices of the lattice cage. And the child geometry will deform.

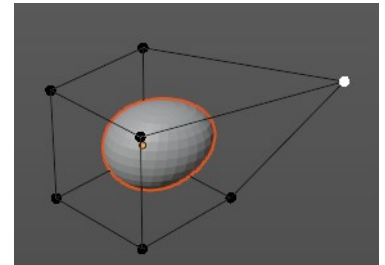

Resolution U / V / W

The subdivision resolution of the Lattice object. A resolution of 1 makes the lattice one dimensional.

Interpolation U / V / W

The interpolation selector for each axis. How the Lattice cage influences the child geometry. Each method gives a slightly different result.

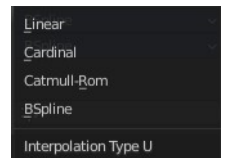

Outside

Takes only the vertices on the surface of the lattice into account.

Vertex Group

Apply the influence of the lattice to a vertex group instead of a whole mesh

Vertex groups panel

A Vertex group is a group of vertices, a selection of the mesh. It is for example used to weight a specific mesh part to a bone. Or to control the growth of hair particles.

This panel allows you to manage and edit vertex groups. Weight painting creates vertex groups automatically.

In Edit mode this panel shows some further controls.

Vertex groups exists for mesh and lattice objects.

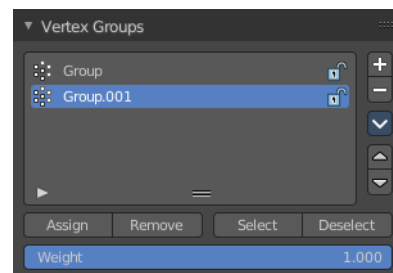

Active Vertex Group list

A List of the vertex groups for this mesh.

Group name

The name of the group. It can be renamed by double clicking at it.

Lock

The lock icon at the end of a group name locks the group from being editable.

Drag Handler

The two vertical lines at the end is a handler with which you can expand the list.

Search Field

You can expand a search field at the bottom of the list. Type in your term and hit enter to filter for your term.



Invert

Exclude the search term instead of searching for it.

Sort by Name

Sort the List by name.

Add +

Create an empty vertex group.

Remove -

Deletes the active vertex group.

Specials menu

Sort by Name

Sorts the vertex groups alphabetically by name.

Sort by Bone Hierarchy

Sorts the vertex groups by the hierarchy of the assigned bones.

Copy Vertex Group

Add a copy of the active vertex group as a new group. The new group will be named like the original group with “_copy” appended at the end of its name. And it will contain associations to exactly the same vertices with the exact same weights as in the source vertex group.

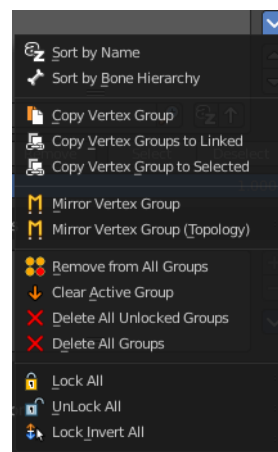

Copy Vertex Groups to Linked

Copy vertex groups of this mesh to all linked objects which use the same mesh data (all users of the data).

Copy Vertex Group to Selected

Copy all vertex groups to other selected objects provided they have matching indices (typically this is true for copies of the mesh which are only deformed and not otherwise edited).

Mirror Vertex Group

Mirrors weights and/or flips group names from one side of a symmetrical mesh to the other.

Only mirroring along local X axis is supported. Vertices that have no corresponding vertex on the other side will not be affected. Note, the weights are not transferred to the corresponding opposite bone weight group.

Mirror Vertex Group (Topology)

Performs the Mirror Vertex Group with the Topology Mirror option enabled.

Remove from All Groups

Unassigns the selected vertices from all groups. Even locked.

Clear Active Group

Remove all assigned vertices from the active group. The group is made empty. Note that the vertices may still be assigned to other vertex groups of the object. This feature does not affect locked groups.

Delete All Unlocked Groups

Remove all vertex groups from the object that are not locked.

Delete All Groups

Remove all vertex groups from the object.

Lock All

Lock all groups.

Unlock All

Unlock all groups.

Lock Invert All

Invert group locks.

Move Vertex Group Up / Down

Moves the selected vertex group up or down in the list.



Assign

Assign the selected vertices to the active vertex group.

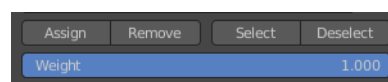

Remove

Remove the selected vertices from the active group.

Select

Select all vertices in the group.

Deselect

Deselect all vertices in the group.

Weight

The weight value that gets assigned to the selected vertices.

Set Active Group

Lets you select the group that will become the active one (menu only).

Shape Keys panel

This panel allows you to see and manage shape keys. A shape key is a vertex animation.

Shape keys are for example used for facial animations, when you don't want to use a face rig with bones. The idea is to model a shape key pose for smiling, one for laughing, one for sad, and so on. And then blend the shape key poses together as needed.

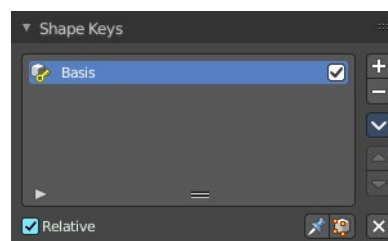

Shape keys are also called morph targets or blend shapes.

Workflow

In Object mode add a shape key. This first shape key is called Basis by default. It is the base for the vertex animation. This basis shape key is the base shape for all further shape keys. It cannot be modified or keyframed.

Now add a second shape key. This second shape key will have more controls so that you can modify it in the needed way.

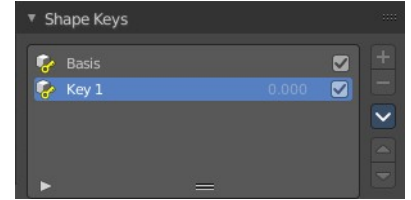

Enter edit mode with this key 1 selected.

Modify the geometry by moving some vertices around.

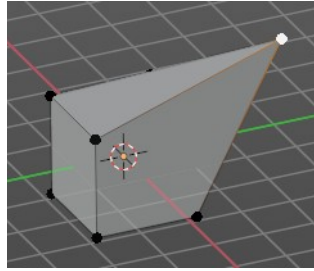

Switch back to Object mode.

Have a look at the value slider. This slider defines how the key 1 shape key blends with the Basis shape key.

Move it from value 0 to value 1. You will notice that the vertices that you have modified in Key 1 will now start to move to a new position. Dependent of how strong the value is. With a value of 1 it will be at the position of how you modeled it.

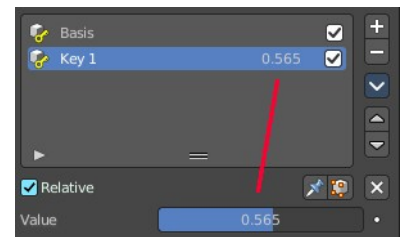

To keyframe this shape click at the Animate property dot behind the slider. The slider will change its color. And the dot will change to a rhombus shape to indicate that there is a keyframe recorded at this frame.

Or you right click at the slider, and choose Insert Keyframe in the menu.

Move to another frame. Change the slider value, and set another keyframe.

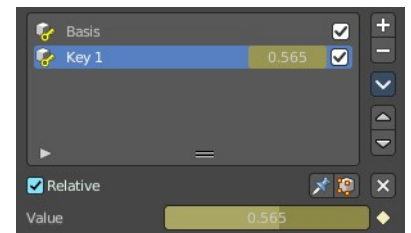

Recorded keyframes can be found and further tweaked in the Dope sheet Editor in Shape Key Editor mode. Here you can also record further keyframes under Key / Insert Keyframes. And control the slider values from the channel list.

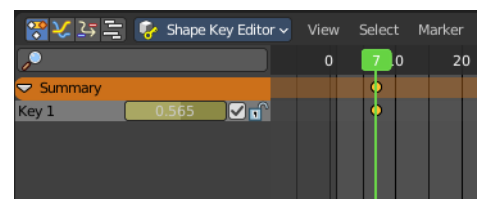

Add more shape keys and model and animate them as you need them.

Active Shape Key Index

A List of the shape keys for this mesh.

It contains two types of shape keys. Basis is the base shape. The other type relies at this shape as the base.

Shape Key name

The name of the shape key. It can be renamed by double clicking at it.

Slider value

The blend value of this shape key. The Basis shape key does not have such a slider.

Lock

The lock icon at the end of a group name locks the group from being editable.

Drag Handler

The two vertical lines at the end is a handler with which you can expand the list.

Search Field

You can expand a search field at the bottom of the list. Type in your term and hit enter to filter for your term.

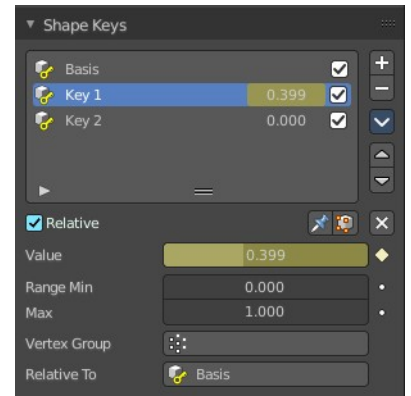

Invert

Exclude the search term instead of searching for it.

Sort by Name

Sort the List by name.

Add +

Create a shape key.

Remove -

Delete the selected shape key.

Specials menu

New Shape From Mix

Add a new shape key with the current deformed shape of the object.

Mirror Shape Key

Mirror the shape keys on the X axis. This will not work if the mesh vertices is not fully symmetrical.

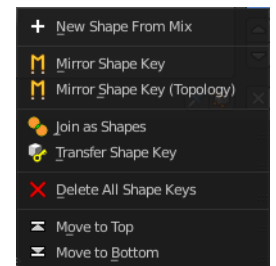

Mirror Shape Key (Topology)

Mirror the shape keys on the X axis. But detects the mirrored vertices based on the topology of the mesh. The mesh vertices do not have to be perfectly symmetrical for this action to work.

Join as Shapes (Transfer Mix)

Transfer the current resulting shape from a different object.

Select the object to copy, hold down Shift, then the object to copy into. Use this action and a new shape key will be added to the active object with the current mix of the first object.

Transfer Shape Key

Transfer the active shape key from a different object regardless of its current influence.

Select the object to copy, hold down Shift, then the object to copy into. Use this action and a new shape key will be added to the active object with the active shape of the first object.

Delete all Shape Keys

Delete all shape keys at this mesh.

Move to Top

Move the shape key to the top of the list. But not above the Basis shape key.

Move to Bottom

Move the shape key to the bottom of the list.

Move Shape Key Up / Down

Moves the selected shape key up or down in the list.



Relative

Set the shape keys to Relative or Absolute.

Relative

The shape is defined relative to the Basis or another specified shape key. And can be adjusted in its settings.

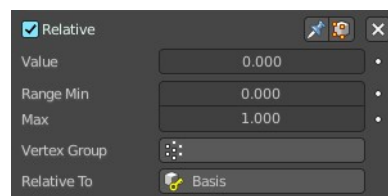

Shape Key Lock (pin icon)

Show the active shape in the 3D Viewport without blending. Shape Key Lock gets automatically enabled while the object is in Edit Mode.

Shape Key Edit Mode (edit mode icon)

If enabled, when entering Edit Mode the active shape key will not take maximum influence as is default. Instead, the current blend of shape keys will be visible and can be edited from that state.

Value

The weight of the blend between the shape key and its basis key. 0 means no influence, 1 full influence.

Range

Minimum and maximum range for the influence value of the active shape key.

Vertex Group

Limit the active shape key deformation to a vertex group.

Relative To

Select the shape key to deform from. It does not need to be the Basis shape key, but can also be another shape key.

Absolute

The shape changes over time, as defined in its settings.

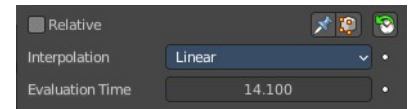

Shape Key Lock (pin icon)

Show the active shape in the 3D Viewport without blending. Shape Key Lock gets automatically enabled while the object is in Edit Mode.

Shape Key Edit Mode (edit mode icon)

If enabled, when entering Edit Mode the active shape key will not take maximum influence as is default. Instead, the current blend of shape keys will be visible and can be edited from that state.

Re-Time Shape Keys (clock icon)

Absolute shape keys are timed, by order in the list, at a constant interval. This button resets the timing for the keys. Useful if keys were removed or re-ordered.

Interpolation

The interpolation method between shape keys.

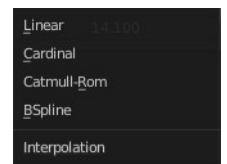

Evaluation Time

Evaluate the shape key influence over the defined time. The evaluation starts at influence 0, and reaches 1 at the end of the value of this timer.

Custom Properties Panel

Here you can define custom properties that can be used for scripting.

Here you might also find custom properties from addons or scripts.

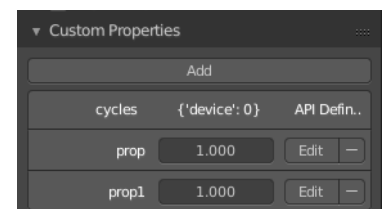

Add

Adds a new property.

Edit

Opens a panel where you can adjust the settings for the custom property.

Remove

Removes the property.

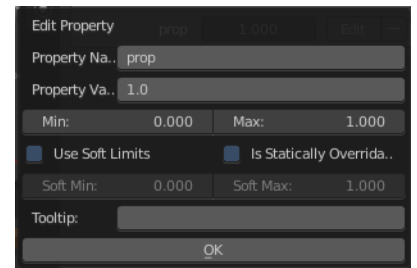



26.15 Editors - Properties Editor - Material Properties Tab

Table of content

Detailed table of content.....	1
Preface.....	6
Material header.....	6
Preview Panel.....	10
Surface Panel.....	11
Surface Panel - Grease Pencil Object.....	12
Volume Panel.....	17
Displacement Panel.....	17
Settings Panel - Eevee renderer.....	18
Settings Panel - Cycles renderer.....	19
Material Library VX.....	21
Line Art.....	23
Viewport Display.....	23
Custom Properties panel.....	25

Detailed table of content

Detailed table of content

Detailed table of content.....	1
Preface.....	6
Affected Renderer.....	6
Material header.....	6
Material List.....	7
Show in ghosts.....	7
Hide.....	7
Locked.....	7
Drag Handler.....	7
Search Field.....	7
Sort by Name.....	7
Reverse.....	7
Add Material Slot.....	7
Remove Material Slot.....	7
Materials Specials menu.....	8
With a mesh or curve or other object type.....	8
Copy Material.....	8
Copy Material to selected.....	8
Paste Material.....	8
Remove Unused Slots.....	8
With a grease pencil stroke object.....	8
Show All.....	8
Hide Others.....	8
Lock All.....	8
Unlock All.....	8
Lock Unused.....	8

Remove Unused Slots.....	8
Merge Similar.....	8
Convert Materials to Vertex Colors.....	8
Extract Palette from Vertex Color.....	9
Append Active Layer to Object.....	9
Append all Layers to Object.....	9
Material data property.....	9
Material Browser.....	9
New.....	9
Name.....	9
Fake User.....	9
New.....	9
Remove.....	9
Link.....	9
Right Click menus.....	9
Edit Mode.....	10
Workflow.....	10
Assign.....	10
Select.....	10
Deselect.....	10
Preview Panel.....	10
Flat, Sphere, Cube, etc.....	10
Preview World.....	10
Surface Panel.....	11
Use Nodes.....	11
Use Nodes unticked with Eevee.....	11
Use Nodes unticked with Cycles.....	11
Use Nodes ticked.....	11
Surface Panel - Grease Pencil Object.....	12
Presets.....	12
Stroke Subpanel.....	12
Mode Type.....	12
Mode Type Line.....	12
Style.....	12
Solid.....	12
Base Color.....	12
Texture.....	12
Base Color.....	12
Image Prop.....	12
Image browser.....	13
Search form.....	13
Image Edit Box.....	13
Number of Fake Users.....	13
Fake User.....	13
Open.....	13
Remove.....	13
Self Overlap.....	13
Holdout.....	13
Mode Type Dots + Squares.....	13
Style.....	13
Solid.....	13
Base Color.....	13
Texture.....	14

Base Color.....	14
Image Prop.....	14
Image browser.....	14
Search form.....	14
Image Edit Box.....	14
Number of Fake Users.....	14
Fake User.....	14
Open.....	14
Remove.....	14
Alignment.....	14
Path.....	14
Object.....	14
Fixed.....	14
Self Overlap.....	15
Rotation.....	15
Holdout.....	15
Fill Subpanel.....	15
Style.....	15
Solid.....	15
Base Color.....	15
Holdout.....	15
Gradient.....	15
Gradient Type.....	15
Base Color.....	15
Secondary Color.....	15
Blend.....	15
Flip Colors.....	15
Location X / Y.....	15
Rotation.....	16
Scale X / Y.....	16
Holdout.....	16
Texture.....	16
Base Color.....	16
Image Prop.....	16
Image browser.....	16
Search form.....	16
Image Edit Box.....	16
Number of Fake Users.....	16
Fake User.....	16
Open.....	17
Remove.....	17
Location X / Y.....	17
Rotation.....	17
Scale X / Y.....	17
Clip Image.....	17
Holdout.....	17
Volume Panel.....	17
Use Nodes.....	17
Displacement Panel.....	17
Use Nodes.....	17
Settings Panel - Eevee renderer.....	18
Backface Culling.....	18
Blend Mode.....	18

Opaque.....	18
Alpha Clip.....	18
Clip threshold.....	18
Alpha Hashed.....	18
Alpha Blend.....	18
Shadow Mode.....	18
None.....	18
Opaque.....	19
Alpha Clip.....	19
Clip threshold.....	19
Alpha Hashed.....	19
Show Backface.....	19
Screen Space Refraction.....	19
Refraction depth.....	19
Subsurface Translucency.....	19
Pass Index.....	19
Settings Panel - Cycles renderer.....	19
Pass Index.....	19
Surface.....	19
Multiple Importance.....	20
Transparent Shadows.....	20
Displacement.....	20
Volume.....	20
Sampling.....	20
Interpolation.....	20
Homogeneous.....	20
Step rate.....	20
Material Library VX.....	21
Library Browser.....	21
New Library.....	21
Preview Window.....	21
Apply.....	21
Preview.....	21
Materials List.....	22
Add to Library.....	22
Reload Material.....	22
Remove Preview.....	22
Remove Material.....	22
Settings.....	22
Force Import.....	22
Linked.....	22
Hide Search.....	22
Search.....	22
Category Tools:.....	22
Filter.....	22
Set Type.....	22
Add.....	23
Remove.....	23
Line Art.....	23
Material Mask.....	23
Levels.....	23
Viewport Display.....	23
Settings.....	23

Backface Culling.....	23
Blend Mode.....	23
Opaque.....	24
Alpha Clip.....	24
Clip threshold.....	24
Alpha Hashed.....	24
Alpha Blend.....	24
Shadow Mode.....	24
None.....	24
Opaque.....	24
Alpha Clip.....	24
Clip threshold.....	24
Alpha Hashed.....	24
Show Backface.....	24
Screen Space Refraction.....	24
Refraction depth.....	25
Subsurface Translucency.....	25
Pass Index.....	25
Custom Properties panel.....	25
Add.....	25
Property Value.....	25
Edit.....	25
Remove.....	25

Preface

Materials controls the appearance of meshes, curves, volumes and other objects.

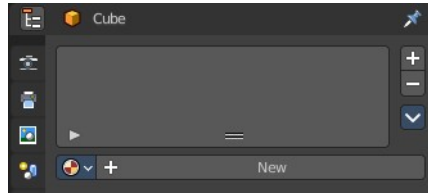

A material is the container that contains all the necessary data to define the look of an object. It is made of a code part, the shaders. They control how the surface reacts. And color data like textures. A black and white texture can also control what areas of a shader reacts in what way. Like a gloss map.

Materials can be created in either the Material properties, or in the Shader Editor. The content that is displayed is the same. But the way how it is represented is different.

Materials can be assigned to one or more objects, and different materials can be assigned to different parts of meshes.

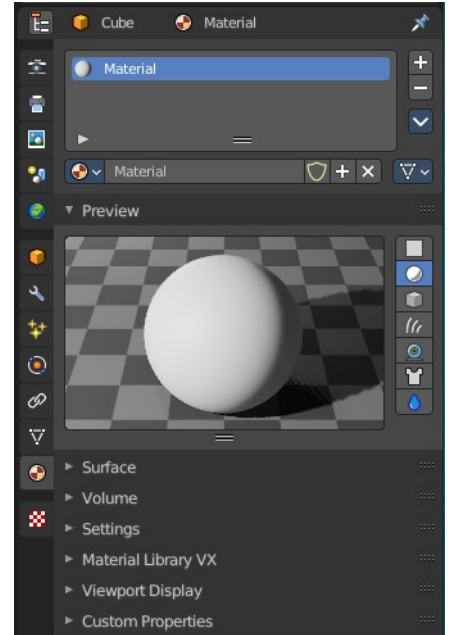

The material system is built with physically-based rendering in mind. But can also be used to create toon style materials.

Affected Renderer

The material system is for Eevee and Cycles. Workbench renderer is meant for fast preview display. It does not use materials like Eevee or Cycles. All you can choose is a color.

Eevee and Cycles have nearly the same nodes available. But some nodes differs. Eevee is a realtime renderer. Cycles is a physically based render. That's two different approaches. So you should take that into account when creating the materials.

Material header

The header area contains the list of materials and the functionality to create new materials and to remove them.

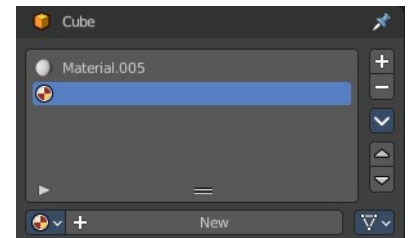
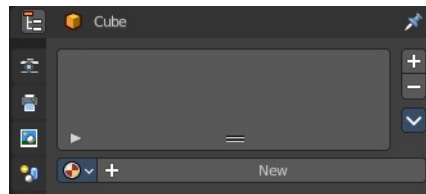

Note that a material for a grease pencil object differs from the rest. It is basically the same. But grease pencil objects have other icons in the material browser.

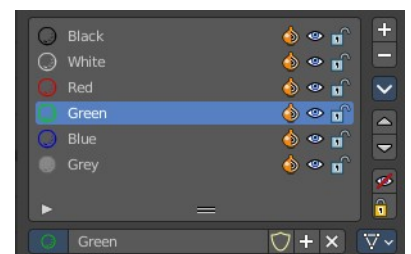

Material List

The list of assigned materials to this object. The list shows the material slots. A material slot that has the red material icon assigned has no material content yet. It is just an empty slot. You have to create it first by clicking at the New button below, in the material property.

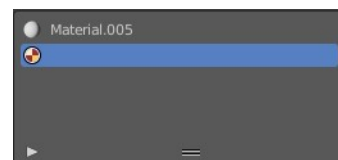

Clicking at the name allows renaming of the material.

Grease pencil materials have additional functionality in the list.

Show in ghosts

Turn on onion skinning for this material. Onion skinning displays strokes before and after the current frame.

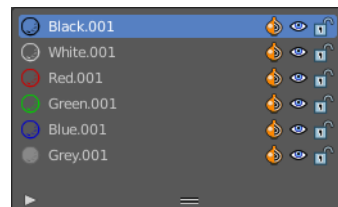

Hide

Show or hide the material.

Locked

Protect color from further editing.

Drag Handler

The two vertical lines at the end is a handler with which you can expand the list.

Search Field

You can expand a search field at the bottom of the list. Type in your term and hit enter to filter for your term.



Sort by Name

Sort the List by name.

Reverse

Exclude the search term instead of searching for it.

Add Material Slot

Add a new material slot

Remove Material Slot

Remove the selected material slot.

Materials Specials menu

With a mesh or curve or other object type

Copy Material

Copy the material settings and nodes.

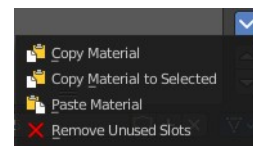

Copy Material to selected

Copy material to selected objects. First select the object without material. Hold down shift and select the object with material. Perform Copy material to selected.

Paste Material

Pastes a copied material.

Remove Unused Slots

Remove material slots that does not contain a material.

With a grease pencil stroke object

Show All

Show all materials.

Hide Others

Hide unselected materials.

Lock All

Lock all materials from editing.

Unlock All

Unlock all materials.

Lock Unused

Lock unused materials from editing.

Remove Unused Slots

Remove material slots that does not contain a material.

Merge Similar

Merge similar materials in stroke.

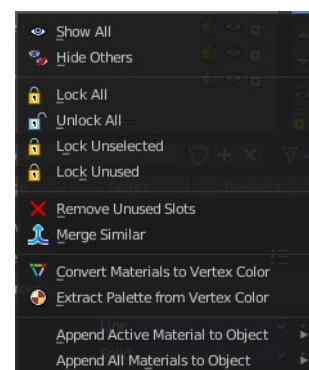

Convert Materials to Vertex Colors

Grease pencil strokes can have either vertex colors or material colors. This feature converts the selected materials to a vertex color palette.

Extract Palette from Vertex Color

Grease pencil strokes can have either vertex colors or material colors. This feature converts a vertex color palette to materials.

Append Active Layer to Object

Appends the active layer to an object.

Append all Layers to Object

Appends all layer to an object.

Material data property



Material Browser

A list of the available materials in the scene where you can choose a material from.

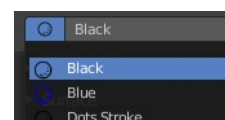

New

When the object has no material yet. Creates a new default material and adds a first material slot to the list.



Name

The name of the active material. Double clicking allows to rename it.

Fake User

Keep this data even when it has no user in the scene.

New

Creates a new default material, and assigns it to the active material slot.

Remove

Link

Specifies whether the material is to be linked to the Object or to the Object Data.

Different objects may share the same mesh data. And if the material is linked to the mesh, every object will share it. If the material is linked directly to the object data, the objects can have different materials and still share the same mesh. Default is Data.

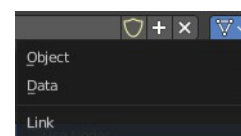

Right Click menus

When you right click at the material property then you will reveal context menus with different content, dependant of where you click. Most of the content is explained in chapter 6, the general right click menu functionality. The rest should be self explaining.

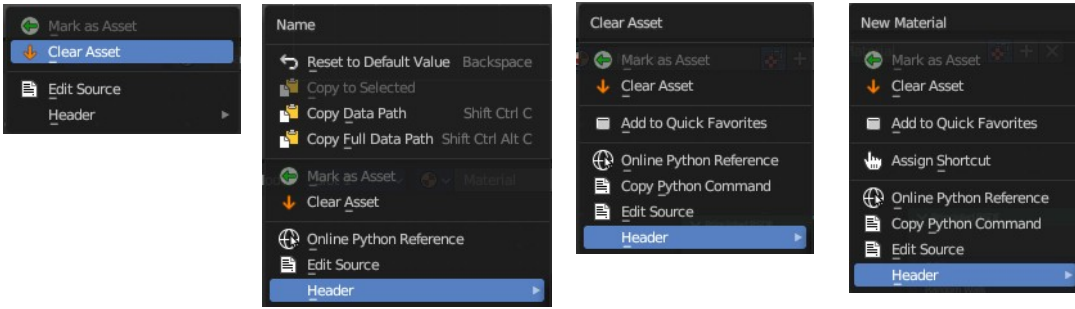

Edit Mode

In Edit mode you can assign different materials at different mesh or curve parts.

Workflow

Enter Edit Mode. Select the material that you want to assign. Select the mesh or curve part. Click at the assign button.

Assign

Assign active material slot and material to the selected faces in the mesh, strokes in a Grease Pencil, and similar for other object types.

Select

Select faces assigned to the active material slot.

Deselect

Deselect faces assigned to the active material slot.

Preview Panel

A preview window to judge the material.

Flat, Sphere, Cube, etc.

Different shaped preview objects.

Preview World

Include the world settings into the preview rendering.

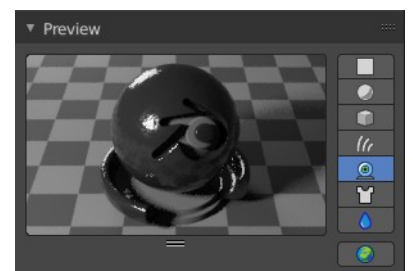

Surface Panel

This panel displays the Surface part of the material as a list. And allows you to edit its values.

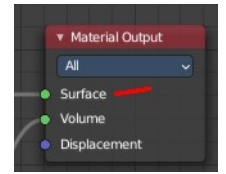

Use Nodes

Choose if you want to use nodes or not. Unticked it will use a default material with just basic values. Ticked it will use the material as defined in the shader editor in the Shading workspace. And display its values.

The values with unticked Use Nodes will not appear in the material node editor.

Use Nodes unticked with Eevee

Gives you the values for a very basic PBR realtime shader.

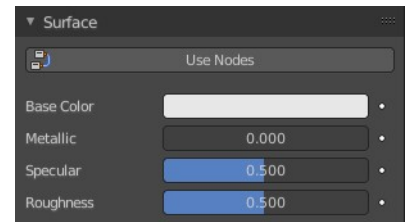

Use Nodes unticked with Cycles

Gives you a base color.

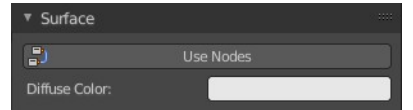

Use Nodes ticked

Displays the content of the material in the shader editor as a list.

Triangle buttons indicates that there is a node connected to this input. You can expand this triangle to access the values of the connected node.

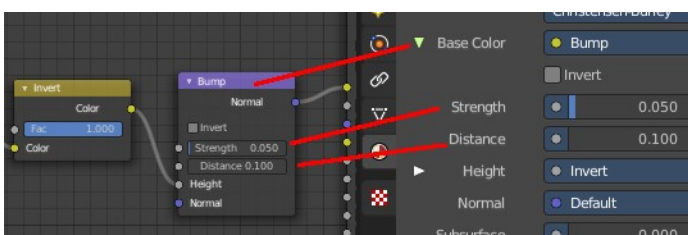
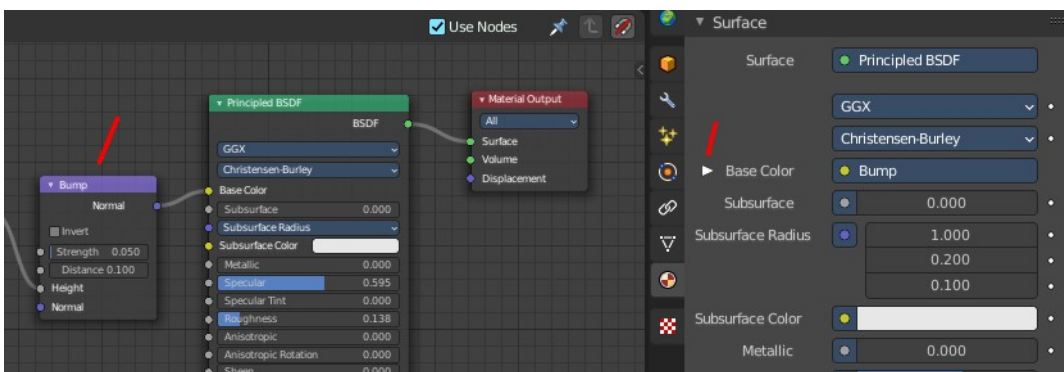

For the nodes and the values please have a look in the shader editor.

Surface Panel - Grease Pencil Object

The content of the surface panel with a grease pencil object is a bit different from other object types since Grease pencil objects uses materials for the drawing color.

Presets

The presets in the header allows you to use and store presets.

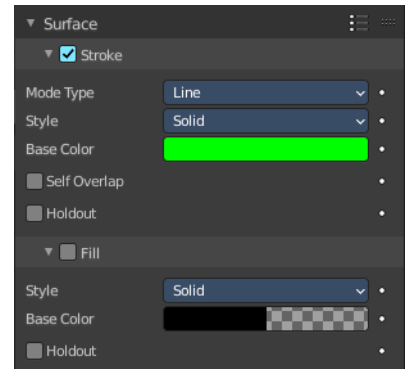

Stroke Subpanel

Stroke related settings.

Mode Type

The draw mode for the stroke. The modes should be self explaining. Most settings are the same in all modes.

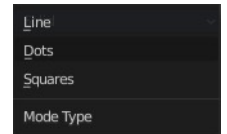

Mode Type Line

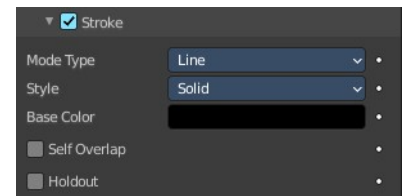

Style

The draw style.

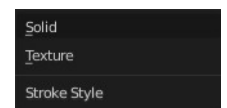

Solid

Base Color

The color of the stroke.

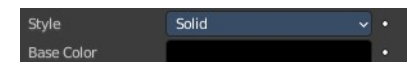

Texture

Base Color

The base color of the stroke. You can blend the texture with this color.

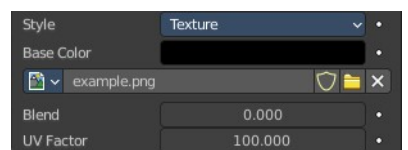
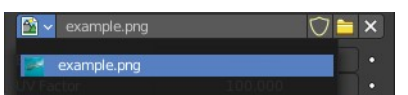

Image Prop

This property contains the list of loaded images. When no image is loaded then it displays the Open Buttons. When an image exists then it displays the name of the currently selected image.



From left to right ...

Image browser

This is a list of the images in the scene. This list allows you to switch to other images.

Search form

Search for specific images.

Image Edit Box

Read the name of the currently selected image. And you can rename the image here too.

Number of Fake Users

In case this file has a fake user assigned, then this number displays the number of fake users.

Fake User

With this button you assign a fake user to this selected image.

Data, like images, that is not longer linked to anything else gets removed when you save and reload a scene. Bforartists has the concept of fake users to go around this behavior. An image with a fake user is in fact linked to something. And so it is not lost when you save and reload the scene.

Open

Open a new image.

Remove

Removes the image.

Self Overlap

Disable stencil and allow self intersections with alpha materials.

Holdout

Remove the color from underneath this stroke by using the stroke as a mask.

Mode Type Dots + Squares

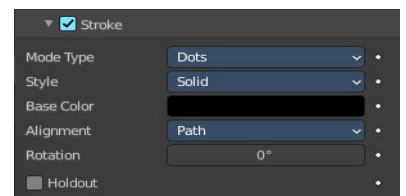
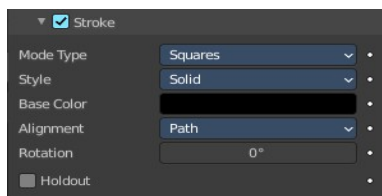

Style

The draw style.

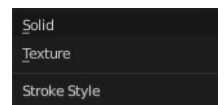

Solid

Base Color

The color of the stroke.



Texture

Base Color

The base color of the stroke. You can blend the texture with this color.

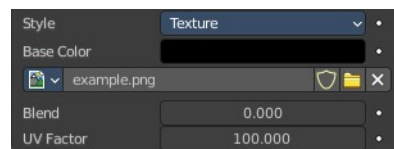
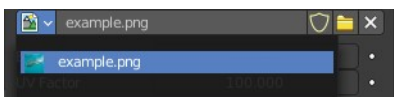

Image Prop

This property contains the list of loaded images. When no image is loaded then it displays the Open Buttons. When an image exists then it displays the name of the currently selected image.



From left to right ...

Image browser

This is a list of the images in the scene. This list allows you to switch to other images.

Search form

Search for specific images.

Image Edit Box

Read the name of the currently selected image. And you can rename the image here too.

Number of Fake Users

In case this file has a fake user assigned, then this number displays the number of fake users.

Fake User

With this button you assign a fake user to this selected image.

Data, like images, that is not longer linked to anything else gets removed when you save and reload a scene. Bforartists has the concept of fake users to go around this behavior. An image with a fake user is in fact linked to something. And so it is not lost when you save and reload the scene.

Open

Open a new image.

Remove

Removes the image.

Alignment

Dots and Squares mode.

Path

Alignment follows stroke drawing path and object rotation.

Object

Alignment follows object rotation only.

Fixed

Keeps aligned with viewport.

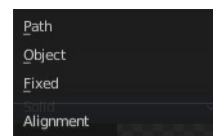

Self Overlap

Disable stencil and allow self intersections with alpha materials.

Rotation

Additional rotation applied to dot and square strokes.



Holdout

Remove the color from underneath this stroke by using the stroke as a mask.

Fill Subpanel

Fill color related settings.

Style

Solid

Base Color

The color of the stroke.



Holdout

Remove the color from underneath this stroke by using the stroke as a mask.

Gradient

Gradient Type

Draw a linear or a radial gradient.

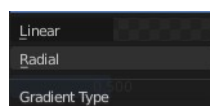

Base Color

The first color of the gradient.

Secondary Color

The second color of the gradient.

Blend

The mix factor between the first and second gradient color.

Flip Colors

Flip the filling colors.

Location X / Y

The location of the gradient.

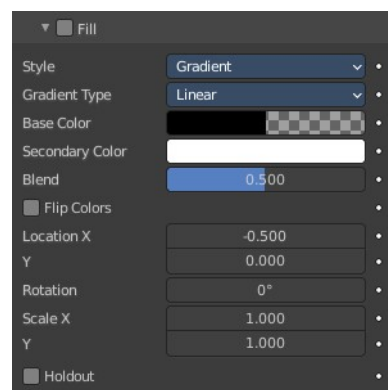

Rotation

The rotation of the gradient.

Scale X / Y

The scale of the gradient.

Holdout

Remove the color from underneath this stroke by using the stroke as a mask.

Texture

Base Color

The base color of the stroke. You can blend the texture with this color.

Image Prop

This property contains the list of loaded images. When no image is loaded then it displays the Open Buttons. When an image exists then it displays the name of the currently selected image.

From left to right ...

Image browser

This is a list of the images in the scene. This list allows you to switch to other images.

Search form

Search for specific images.

Image Edit Box

Read the name of the currently selected image. And you can rename the image here too.

Number of Fake Users

In case this file has a fake user assigned, then this number displays the number of fake users.

Fake User

With this button you assign a fake user to this selected image.

Data, like images, that is not longer linked to anything else gets removed when you save and reload a scene. Bforartists has the concept of fake users to go around this behavior. An image with a fake user is in fact linked to something. And so it is not lost when you save and reload the scene.

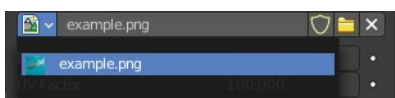
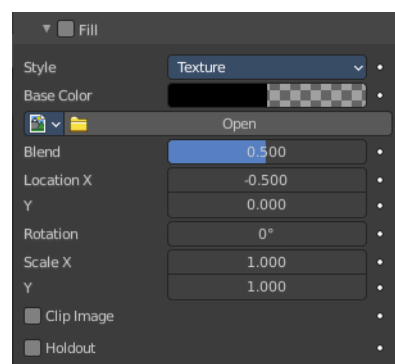

Open

Open a new image.

Remove

Removes the image.

Location X / Y

The location of the image.

Rotation

The rotation of the image.

Scale X / Y

The scale of the image.

Clip Image

Do not repeat the image, but clamp it to one instance.

Holdout

Remove the color from underneath this stroke by using the stroke as a mask.

Volume Panel

This panel displays the Volume part of the material as a list. And allows you to edit its values.

Use Nodes

Choose if you want to use a volume node or not.

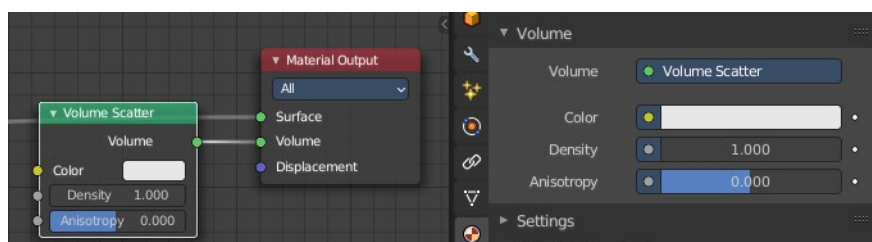
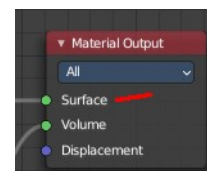

Removing the volume node in the shader editor will clear the volume panel.

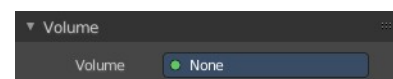

Displacement Panel

This panel displays the Displacement part of the material as a list. And allows you to edit its values.

Use Nodes

Choose if you want to use a displacement node or not.

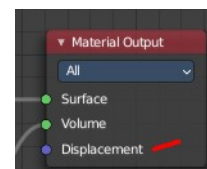

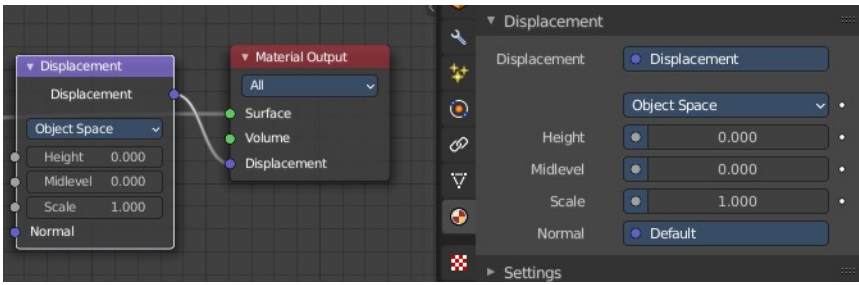

Removing the displacement node in the shader editor will clear the panel.

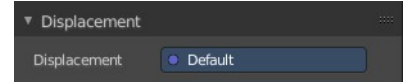

Settings Panel - Eevee renderer

Backface Culling

Use back face culling to hide the back side of faces.

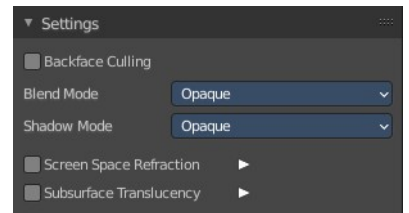

Blend Mode

The blend mode for transparent faces.

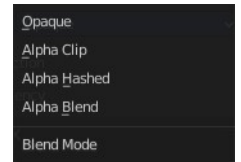

Opaque

Render surface without transparency.

Alpha Clip

Use the alpha threshold to clip the visibility. On or off.

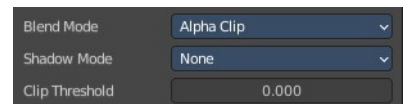

Clip threshold

A pixel is just rendered if the value is higher than this clip threshold. This threshold is the same for blend mode and shadow mode.

Alpha Hashed

Use Noise to dither the binary visibility. Works best with multi samples.

Alpha Blend

Render polygons transparent, dependent of the alpha channel of the texture.

Shadow Mode

None

Material will cast no shadow.

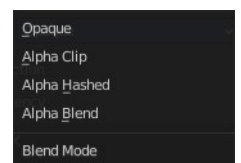

Opaque

Material will cast shadow without transparency.

Alpha Clip

Use the alpha threshold to clip the visibility. On or off.

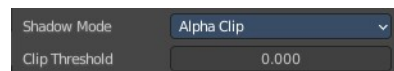

Clip threshold

A pixel is just rendered if the value is higher than this clip threshold. This threshold is the same for blend mode and shadow mode.

Alpha Hashed

Use Noise to dither the binary visibility.

Show Backface

With Blend Mode Alpha Blend. Limit the transparency to a single layer to avoid transparency layer sort problems.

Screen Space Refraction

Use ray traced screen space refraction.

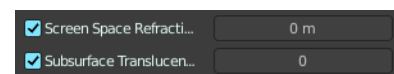

Refraction depth

The thickness of the object to compute two refraction event. 0 means disabled.

Subsurface Translucency

Add translucency effect to subsurface.

Pass Index

Index number for the material index render pass.

Settings Panel - Cycles renderer

Material settings.

Pass Index

The index number of this material. This material index can be used for masking in post processing for example.



Surface

Surface related settings.

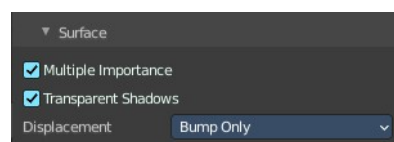

Multiple Importance

By default lights use only direct light sampling. Which can be noisy with sharp glossy reflections. Multiple Importance activates Indirect light sampling to reduce noise.

Transparent Shadows

Use transparent shadows if the material contains a transparent bsdf node.

Displacement

What method to use for displacement.

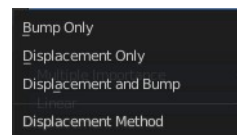

Volume

Sampling

What sampling method to use for volume rendering.

Interpolation

What interpolation method to use for volume rendering.

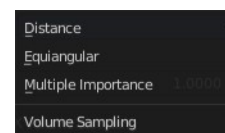
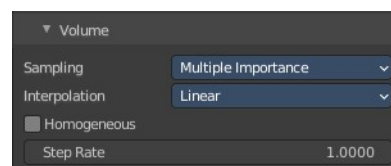

Homogeneous

Assume to have a homogeneous volume to speed up rendering.

Step rate

Scale the distance between volume shader samples when rendering the volume. Lower values increases accuracy and render time.

Step rate becomes dysfunctional when Homogeneous is activated.



Material Library VX

Materials Library VX is a Blender material library add-on. You can save, load and categorize materials that can be shared across all your projects.

It's advisable to add a Fake User to your materials and to save your blend-file before use.

Note that this add-on creates a material_preview_dummy object to allow the material preview.

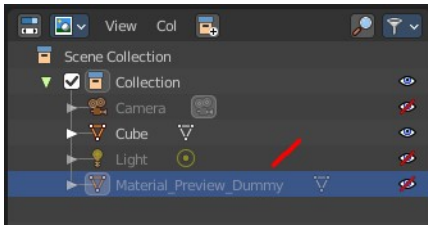

Library Browser

A list of the available libraries. Switching to another library will load it.

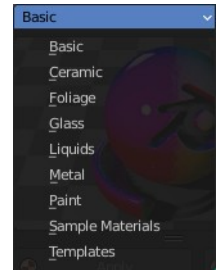

New Library

Create a new Library and name it. The new library will have one material to start.

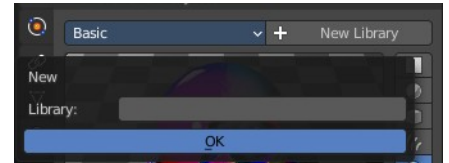

Preview Window

A material preview window.

Apply

Apply the currently selected material to the object. Note, sometimes the object gets deselected. And then you get a warning. Simply select the object, and try again.

Preview

The material can be previewed before you assign it. Preview will also refresh the material preview window. It is not updated by choosing another material.

Materials List

The list of the available materials in this library. Choose a material, click at the Preview button to preview it in the preview window. Click at the Apply button to assign the material to the selected object.

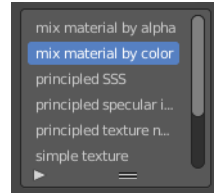

Add to Library

Add your materials to the library.

Reload Material

Restore the saved version of the material if you want to revert edits.

Remove Preview

Restore the Preview panel.

Remove Material

Delete the active material from the Matlib VX list and your library.

Settings

Options. They appear at the end.

Force Import

Use Scene Materials by default.

Linked

Link the material instead of append it.

Hide Search

Hides the search field.

Search

Search the library for a material.

Category Tools:

Here you can make sub categories.

Note, this part is simply broken. Don't even bother.

Filter

Apply the current filter.

Set Type

Apply the current selected category to the current material library.

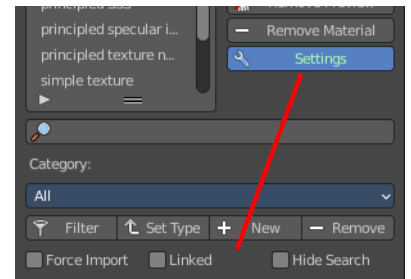

Add

Add a new category.

Remove

Remove the current selected category from the list.

Line Art

Material Mask

Use material masks to filter out occluded strokes. You can filter out up to eight mask bits. The index starts with 0.

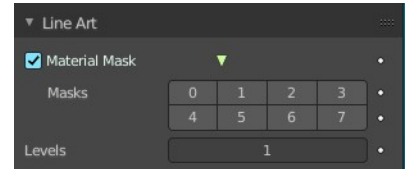

Levels

Faces with this material will behave as if it has set numbers of layers in occlusion.

Viewport Display

Display settings for viewport display mode Solid. The items should be self explaining.

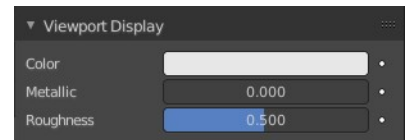

Settings

Cycles only. And with Cycles these settings are just relevant for the viewport rendering in Material Preview mode. That's why they are in the viewport display panel.

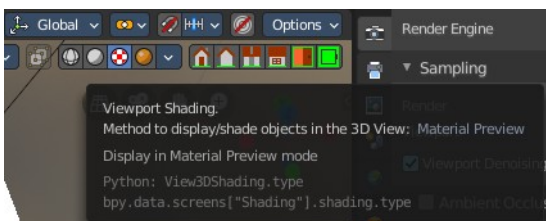
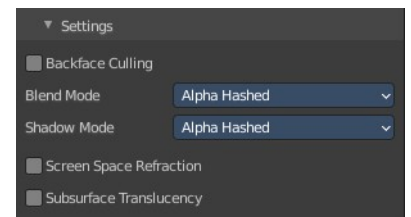

Backface Culling

Use back face culling to hide the back side of faces.

Blend Mode

The blend mode for transparent faces.

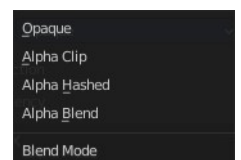

Opaque

Render surface without transparency.

Alpha Clip

Use the alpha threshold to clip the visibility. On or off.

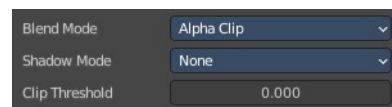

Clip threshold

A pixel is just rendered if the value is higher than this clip threshold. This threshold is the same for blend mode and shadow mode.

Alpha Hashed

Use Noise to dither the binary visibility. Works best with multi samples.

Alpha Blend

Render polygons transparent, dependent of the alpha channel of the texture.

Shadow Mode

None

Material will cast no shadow.

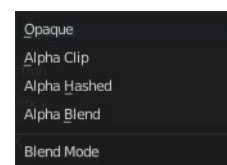

Opaque

Material will cast shadow without transparency.

Alpha Clip

Use the alpha threshold to clip the visibility. On or off.

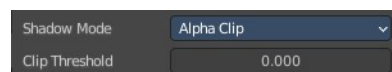

Clip threshold

A pixel is just rendered if the value is higher than this clip threshold. This threshold is the same for blend mode and shadow mode.

Alpha Hashed

Use Noise to dither the binary visibility.

Show Backface

With Blend Mode Alpha Blend. Limit the transparency to a single layer to avoid transparency layer sort problems.

Screen Space Refraction

Use ray traced screen space refraction.

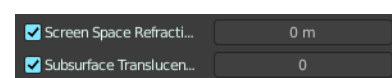

Refraction depth

The thickness of the object to compute two refraction event. 0 means disabled.

Subsurface Translucency

Add translucency effect to subsurface.

Pass Index

Index number for the material index render pass.

Custom Properties panel

This panel exists for all object types in the Object Data Properties. Allows you to add custom properties that can be used in various ways then. For scripting, or to drive animation etc.

In this panel you might also find custom properties from addons or scripts.

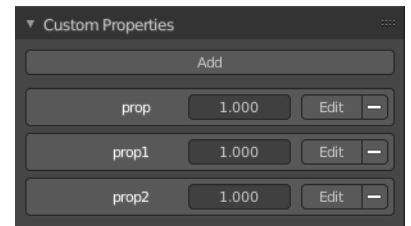

Add

Adds a new property.

Property Value

The value of the property.

Edit

Opens a panel where you can adjust the settings for the custom property. The settings should be self explaining.

Remove

Removes the property.

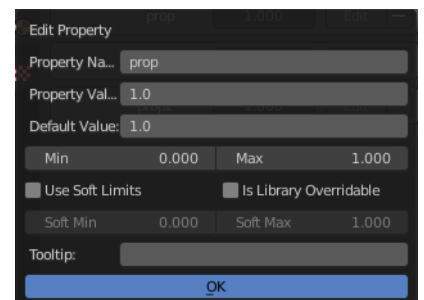



26.16 Editors - Properties Editor - Texture Properties Tab

Table of content

Detailed table of content.....	2
Properties Editor - Texture Tab.....	7
Brush drop down box.....	7
Texture property.....	7
New Texture.....	8
Remove Texture.....	8
Type.....	8
Preview panel.....	8
Blend panel.....	8
Clouds panel.....	9
Noise Basis.....	9
Type.....	9
Color.....	9
Size.....	9
Depth.....	9
Nabla.....	9
Distorted Noise panel.....	10
Noise Basis.....	10
Distortion.....	10
Amount.....	10
Size.....	10
Nabla.....	10
Image panel - Settings Subpanel.....	10
Image Property.....	11
Source.....	13
Image panel - Alpha Subpanel.....	17
Calculate.....	17
Invert.....	17
Image panel - Mapping Subpanel.....	17
Flip Axes.....	17
Extension.....	18
Crop Sub tab.....	18
Image panel - Sampling Subpanel.....	18
Interpolation.....	18
MIP Map.....	19
Fiter Type.....	19
Minimum Size.....	19
Magic panel.....	20
Depth.....	20
Turbulence.....	20
Marble panel.....	20
Noise Basis.....	20
Pattern.....	20
Second basis.....	21
Type.....	21
Size.....	21
Depth.....	21

Turbulence.....	21
Nabla.....	21
Musgrave panel.....	21
Noise Basis.....	21
Type.....	21
Size.....	22
Nabla.....	22
Dimension.....	22
Lacunarity.....	22
Octaves.....	22
Intensity.....	22
Offset.....	22
Gain.....	22
Stucci panel.....	23
Noise Basis.....	23
Pattern.....	23
Type.....	23
Size.....	23
Turbulence.....	23
Voronoi panel.....	23
Distance Metric.....	23
Coloring.....	24
Feature Weights subpanel.....	24
Wood panel.....	24
Noise Basis.....	24
Pattern.....	24
Second basis.....	25
Type.....	25
Turbulence.....	25
Nabla.....	25
Colors Panel.....	25
Clamp.....	25
Multiply R G B.....	25
Brightness.....	25
Contrast.....	25
Saturation.....	25
Color ramp subpanel.....	25
Custom Properties Panel.....	27
Add.....	27
Edit.....	27
Remove.....	27

Detailed table of content

Detailed table of content

Detailed table of content.....	2
Properties Editor - Texture Tab.....	7
Brush drop down box.....	7
Texture property.....	7
Texture browser.....	7

Edit Box.....	7
Number of users.....	7
Fake User.....	7
New Texture.....	8
Remove Texture.....	8
Type.....	8
Preview panel.....	8
Blend panel.....	8
Progression.....	8
Orientation.....	9
Clouds panel.....	9
Noise Basis.....	9
Type.....	9
Color.....	9
Grayscale.....	9
Color.....	9
Size.....	9
Depth.....	9
Nabla.....	9
Distorted Noise panel.....	10
Noise Basis.....	10
Distortion.....	10
Amount.....	10
Size.....	10
Nabla.....	10
Image panel - Settings Subpanel.....	10
Image Property.....	11
Texture browser.....	11
Edit Box.....	11
Unlink Data-Block.....	11
File selector menu.....	11
New.....	12
Name.....	12
Width.....	12
Height.....	12
Color.....	12
Alpha.....	12
Generated Type.....	12
32 Bit Float.....	12
Duplicate.....	12
Unlink Datablock.....	12
Fake User.....	12
Open Image.....	13
Unpack.....	13
User.....	13
Source.....	13
Source Type Generated.....	13
X / Y.....	13
Float Buffer.....	13
Generated Type Blank.....	13
Color.....	13
Generated Type UV Grid.....	13
Generated Type Color Grid.....	14

Color Space.....	14
View as Render.....	14
Source Type Movie + Image Sequence.....	14
Path edit box.....	14
Pack.....	14
Path edit box.....	15
Open.....	15
Refresh.....	15
Info string.....	15
Frames.....	15
Match Movie Length.....	15
Start.....	15
Offset.....	15
Cyclic.....	15
Auto Refresh.....	15
Deinterlace.....	15
Color Space.....	15
Alpha.....	16
View as Render.....	16
Source Type Single Image.....	16
Path edit box.....	16
Pack.....	16
Path edit box.....	16
Open.....	16
Refresh.....	16
Info string.....	16
Color Space.....	16
Alpha.....	16
View as Render.....	17
Source Type Udim.....	17
Image panel - Alpha Subpanel.....	17
Calculate.....	17
Invert.....	17
Image panel - Mapping Subpanel.....	17
Flip Axes.....	17
Extension.....	18
Extend.....	18
Clip.....	18
Clip Cube.....	18
Repeat.....	18
Repeat X / Y.....	18
Mirror X / Y.....	18
Checker.....	18
Distance.....	18
Tiles Even / Odd.....	18
Crop Sub tab.....	18
Crop Minimum X / Y + Crop Maximum X / Y.....	18
Image panel - Sampling Subpanel.....	18
Interpolation.....	18
MIP Map.....	19
Gaussian Filter.....	19
Fiter Type.....	19
Type Box.....	19

Size.....	19
Type EWA.....	19
Eccentricity.....	19
Size.....	19
Type FELINE.....	19
Light Probes.....	19
Size.....	19
Type Area.....	19
Eccentricity.....	19
Size.....	19
Minimum Size.....	19
Magic panel.....	20
Depth.....	20
Turbulence.....	20
Marble panel.....	20
Noise Basis.....	20
Pattern.....	20
Second basis.....	21
Type.....	21
Size.....	21
Depth.....	21
Turbulence.....	21
Nabla.....	21
Musgrave panel.....	21
Noise Basis.....	21
Type.....	21
Size.....	22
Nabla.....	22
Dimension.....	22
Lacunarity.....	22
Octaves.....	22
Intensity.....	22
Offset.....	22
Gain.....	22
Stucci panel.....	23
Noise Basis.....	23
Pattern.....	23
Type.....	23
Size.....	23
Turbulence.....	23
Voronoi panel.....	23
Distance Metric.....	23
Exponent.....	24
Coloring.....	24
Feature Weights subpanel.....	24
Wood panel.....	24
Noise Basis.....	24
Pattern.....	24
Second basis.....	25
Type.....	25
Turbulence.....	25
Nabla.....	25
Colors Panel.....	25

Clamp.....	25
Multiply R G B.....	25
Brightness.....	25
Contrast.....	25
Saturation.....	25
Color ramp subpanel.....	25
+.....	26
-.....	26
Tools menu.....	26
Flip Color Ramp.....	26
Distribute Stops from Left.....	26
Distribute Stops Evenly.....	26
Eyedropper (pipette icon) E.....	26
Reset Color Ramp.....	26
Color Mode.....	26
RGB.....	26
HSV/HSL.....	26
Interpolation.....	26
Ease.....	26
Cardinal.....	26
Linear.....	26
B-Spline.....	27
Constant.....	27
Color Ramp.....	27
Active Color Stop elements.....	27
Choose active color stop.....	27
Pos.....	27
Color.....	27
Custom Properties Panel.....	27
Add.....	27
Edit.....	27
Remove.....	27

Properties Editor - Texture Tab

In this panel you can create or load textures for the brushes in the image painting modes. Note that with the Workbench renderer you have less options.

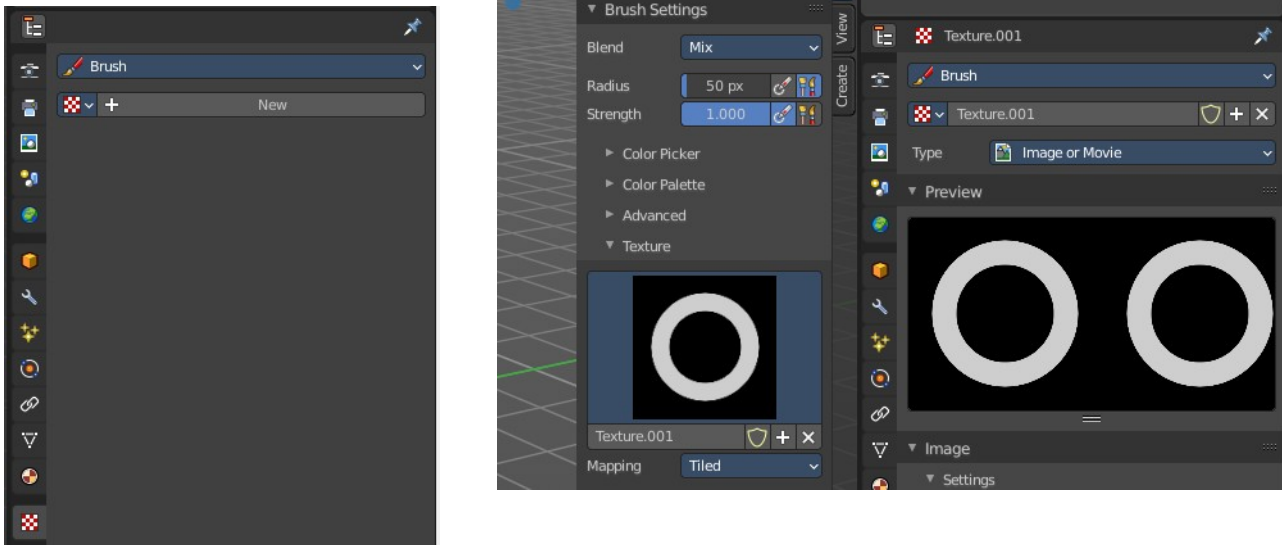

Brush drop down box

What kind of brush texture you want to create. A brush texture, or a brush mask texture. Brush textures appears in the texture panel of the brush settings. Brush mask textures appears in the texture mask panel of the brush settings.

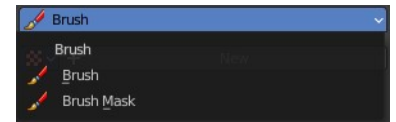

Texture property

Texture browser

A texture browser with the available textures.

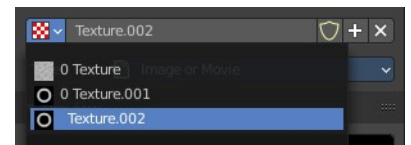

Edit Box

The name of the currently active palette. You can also rename the palette here. A click into the edit box makes the name editable.

Number of users

See how many users the palette currently has.

Fake User

Fake User sets the element to have a fake user. Data without a user is normally not saved. But sometimes you want to force the data to be kept even when the data block has no user.

New Texture

Add a new texture

Remove Texture

Removes the texture as the active texture. Note that the texture is still in the list.

Type

The image type to use. Image or Movie uses pixel based material that you have to load externally. The rest are procedural computer generated textures. Some of them are based at different noise algorithms.

Each texture type has its own settings which will be described below.

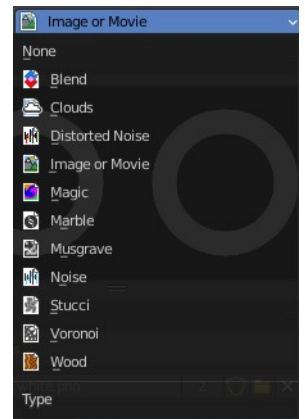

Preview panel

A preview window for the texture.

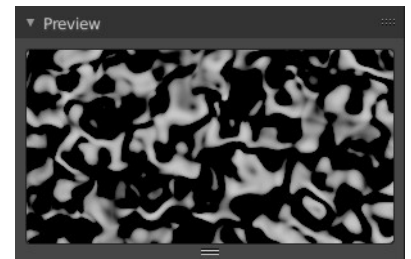

Blend panel

Image Type Blend.

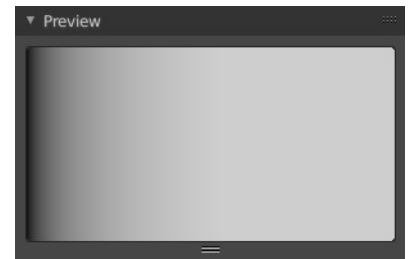
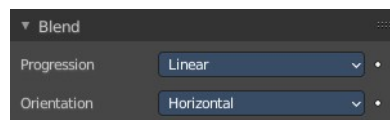

Progression

The style of the color blending.

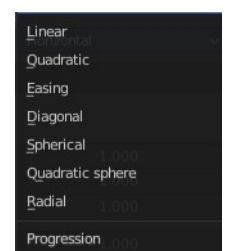

Orientation

The direction. Horizontal or vertical.

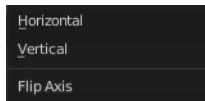

Clouds panel

Image type clouds

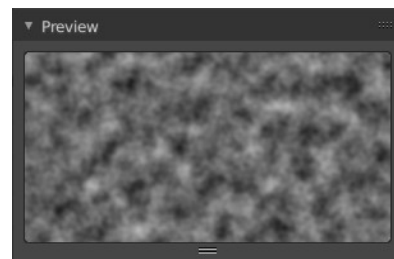
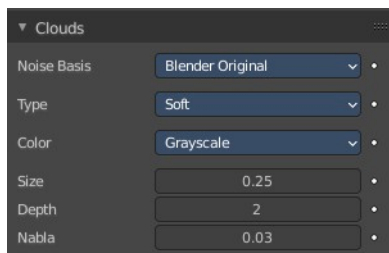

Noise Basis

What noise method to use.

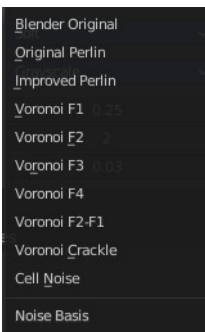

Type

Smooth transitions or sharp transitions. Changes contrast and sharpness.

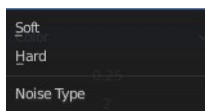

Color

Grayscale

Grayscale based noise. The value returned is greyscale 8 bit.

Color

The noise gives an RGB value. The value returned is rgb 24 bit.

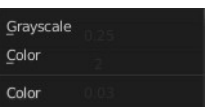

Size

The dimension of the Noise table.

Depth

The depth of the Clouds calculation. A higher number results in a long calculation time, but also in finer details.

Nabla

Size of derivate offset used for calculating normal.

In order to calculate a normal, you usually use three samples in texture space. Typically that's the current

sample location, and two other positions in texture U and V directions. This "nabla" value defines how far away these positions are.

Distorted Noise panel

Image type Distorted Noise

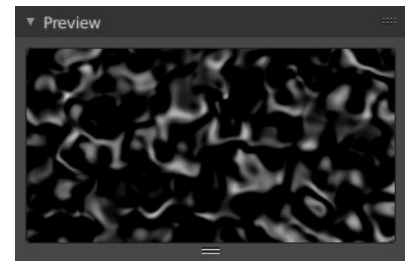
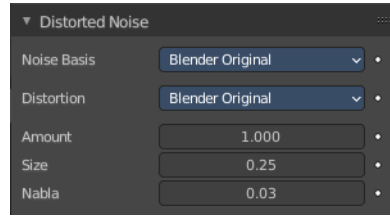

Noise Basis

What noise method to use.

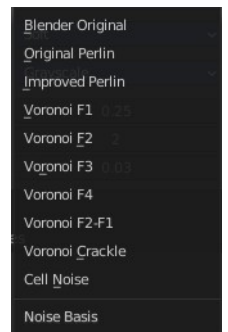

Distortion

What noise method to use for the distortion.

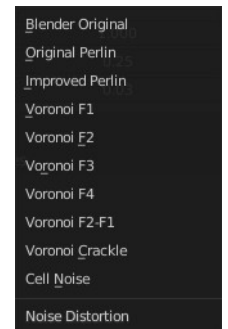

Amount

The amount of distortion.

Size

The dimension of the Noise table.

Nabla

Size of derivate offset used for calculating normal.

In order to calculate a normal, you usually use three samples in texture space. Typically that's the current sample location, and two other positions in texture U and V directions. This "nabla" value defines how far away these positions are.

Image panel - Settings Subpanel

Image type Image or Movie.

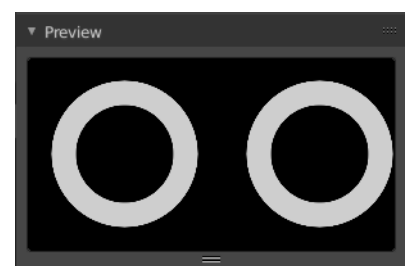
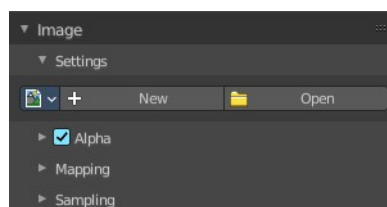
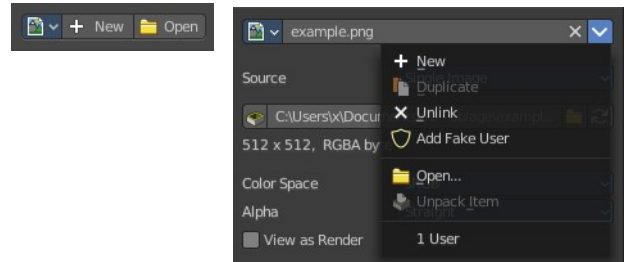

Image Property

Load an image and / or switch to other images.



Texture browser

A texture browser with the available textures.

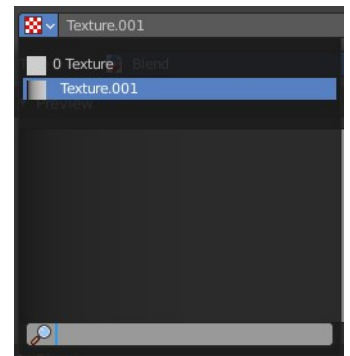

Edit Box

The name of the currently active palette. You can also rename the palette here. A click into the edit box makes the name editable.

Unlink Data-Block

Remove the texture.

File selector menu

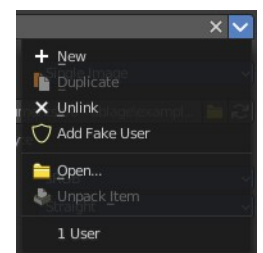

New

Create a new image.

Creates a new image. You will get a dialog where you can define settings for the new image.

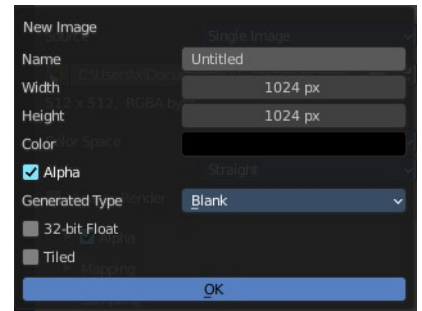

Name

The name of the new image

Width

The width of the new image.

Height

The height of the new image.

Color

Adjust the color of the new image. A click will call a color picker.

Alpha

Check this checkbox if the new image should have an alpha channel.

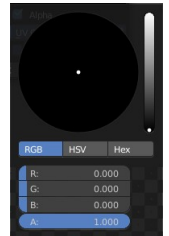

Generated Type

Here you can define what kind of texture you want to create.

Blank is one plain color.

UV Grid is a checker texture in black and white.

Color Grid is a colored checker texture.

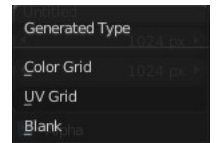

32 Bit Float

Check this checkbox if the image should be in 32 Bit floating point bit depth per channel. Else it is in 8 bit per channel.

Duplicate

Not supported here.

Unlink Datablock

This deletes the selected image. Unfortunately not immediately. You need to save the scene and to reload it.

And you need to make sure that it is not linked to anything else. A mesh or a fake user for example. Have a look if there is a number besides the F button. When this is the case then the image has still a user, and so still loads with loading the scene.

Fake User

With this button you assign a fake user to this selected image.

Data, like images, that is not longer linked to anything else gets removed when you save and reload a scene. Bforartists has the concept of fake users to go around this behavior. An image with a fake user is in fact linked to something. And so it is not lost when you save and reload the scene.

Open Image

Opens the file browser to load an image.

Unpack

Unpack packed files to a directory.

User

The number of users that uses this data. Data with a user number of 0 will be removed with closing Bforartists.

Source

Choose the image type. This type gets usually automatically set. When you create a new image, then this image is generated. When you load an image then the Source switches to Single Image.

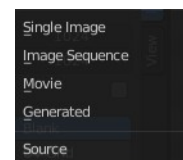

Generated images does not have a path.

Source Type Generated

X / Y

The image width and height.

Float Buffer

Use a floating point buffer. 8 Bit images uses integers. 32 Bit works with floats.

Generated Type Blank

This type displays an image with one blank color

Color

The color of the blank image.

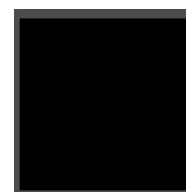

Generated Type UV Grid

This type displays a with a black and white checker texture but colored dots.

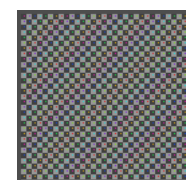

Generated Type Color Grid

This type displays a with a colored checker texture with numbers.



Color Space

Choose the color space type for the image.

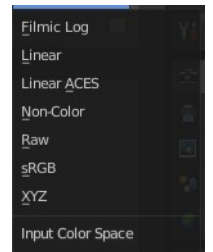

View as Render

Displays the image with the color management settings.

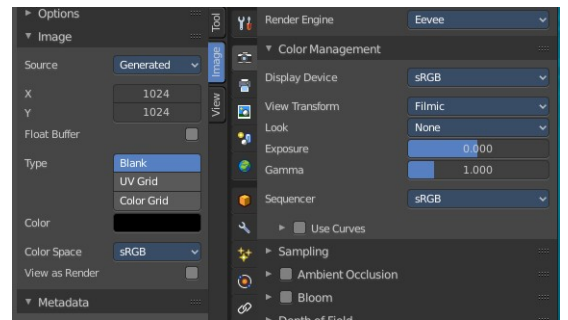

Source Type Movie + Image Sequence

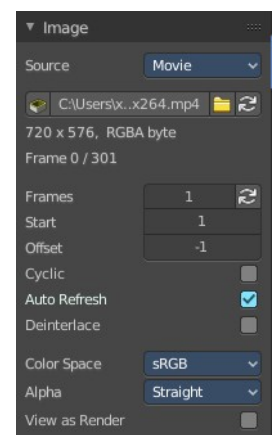
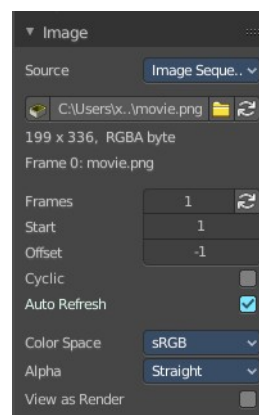

Path edit box



Pack

With this button you can pack the movie or the image sequence into the blend file. It gets packed when you

save the blend file the next time.

Path edit box

See and edit the path to your movie or image sequence files.

Open

Open a new movie or image sequence files. A file dialog will appear.

Refresh

Reread the movie or image sequence files.

Info string

Some information about the currently loaded movie. Frames, resolution and color space.

Frames

The number of frames of the movie or image sequence.

Match Movie Length

Set Users Image Length to the one of this video.

Start

The start frame of the movie or image sequence

Offset

Offset the number of the frame to use in the animation. -1 means off.

Cyclic

Cycle the images in the movie.

Auto Refresh

Always refresh image on frame changes.

Deinterlace

Deinterlace the movie file on load.

Color Space

Choose the color space type for the movie or image sequence files.

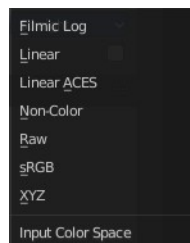

Alpha

Choose the alpha channel mode. Straight or Premultiplied.

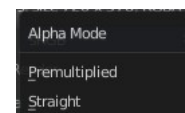

View as Render

Display the image with using the color management settings.

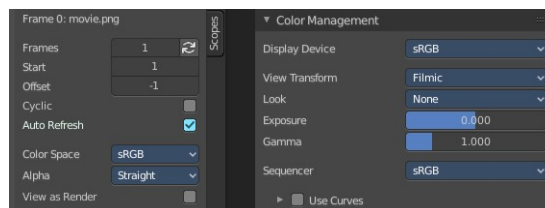

Source Type Single Image

Path edit box

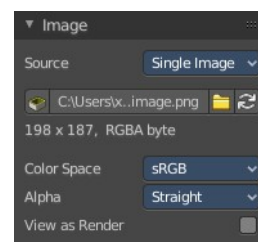
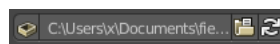

Pack

With this button you can pack the movie or the image sequence into the blend file. It gets packed when you save the blend file the next time.

Path edit box

See and edit the path to your movie or image sequence files.

Open

Open a new movie or image sequence files. A file dialog will appear.

Refresh

Reread the movie or image sequence files.

Info string

Some information about the currently loaded image. Resolution and color space.

Color Space

Choose the color space type for the movie or image sequence files.

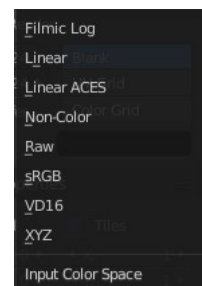

Alpha

Choose the alpha channel mode. Straight or Premultiplied.

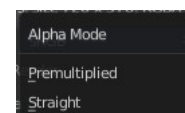

View as Render

Display the image with using the color management settings.

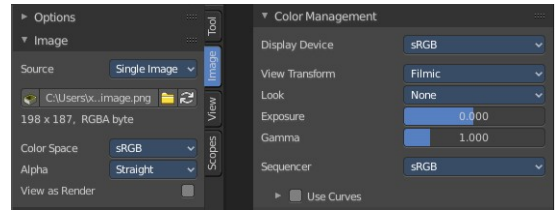

Source Type Udim

UDIM is an enhancement to the UV mapping and texturing workflow. And does not belong here. But in the UV Editor. It is just in the list because it shares the same menus with the UV Editor.



Image panel - Alpha Subpanel

Use the Alpha channel that is stored in the image.

Calculate

Calculate an alpha based on the RGB values of the Image. Black (0, 0, 0) is transparent, white (1, 1, 1) opaque.

Enable this option if the image texture is a mask. Note that mask images can use shades of gray that result in semi-transparency, like ghosts, flames, and smoke/fog.

Invert

Reverses the alpha value. Use this option if the mask image has white where you want it transparent and vice versa.



Image panel - Mapping Subpanel

Control how the image is mapped or projected onto the 3D model.

Flip Axes

Rotates the image 90 degrees counterclockwise when rendered.

Extension

Extend

Outside the image the colors of the edges are extended.

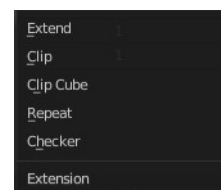
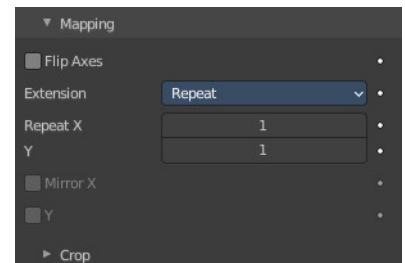

Clip

Clip to image size and set exterior pixels as transparent. Outside the image, an alpha value of 0.0 is returned. This allows you to ‘paste’ a small logo on a large object.

Clip Cube

Clips to cubic-shaped area around the images and sets exterior pixels as transparent. The same as Clip, but now the ‘Z’ coordinate is calculated as well. An alpha value of 0.0 is returned outside a cube-shaped area around the image.

Repeat

The image is repeated horizontally and vertically.

Repeat X / Y

X/Y repetition multiplier.

Mirror X / Y

Mirror on X/Y axes. These buttons allow you to map the texture as a mirror, or automatic flip of the image, in the corresponding X and/or Y direction. They become active when the Repeat value is higher than 1.

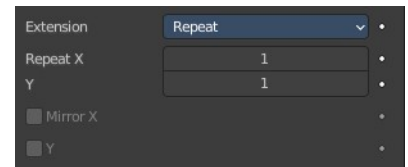

Checker

Checkerboards quickly made. You can use the option size on the Mapping panel as well to create the desired number of checkers.

Distance

Governs the distance between the checkers in parts of the texture size.

Tiles Even / Odd

Set even/odd tiles.

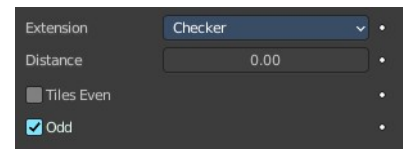

Crop Sub tab

Crop Minimum X / Y + Crop Maximum X / Y

The offset and the size of the texture in relation to the texture space. Pixels outside this space are ignored. Use these to crop, or choose a portion of a larger image to use as the texture.



Image panel - Sampling Subpanel

Interpolation

Interpolate pixels using selected filter type.

MIP Map

Use auto generated MIP maps.

Gaussian Filter

Use Gauss filter to sample down the mip map images.

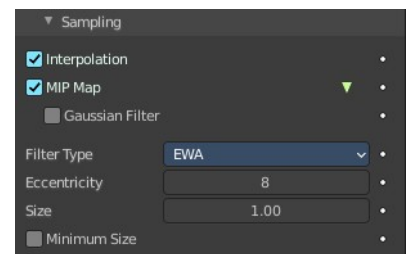

Filter Type

The texture filter to use for sampling images.

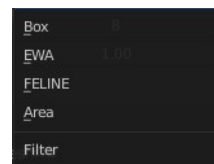

Type Box

Size

Multiply the filter size used by MIP map and interpolation.

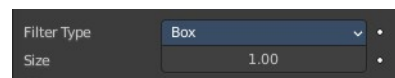

Type EWA

Eccentricity

Maximum eccentricity. Higher values gives less blur at distance angles and is slower.

Size

Multiply the filter size used by MIP map and interpolation.

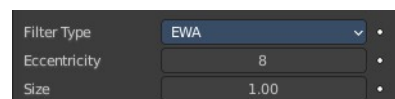

Type FELINE

Light Probes

Maximum number of samples. Higher values gives less blur at distance angles and is slower.

Size

Multiply the filter size used by MIP map and interpolation.



Type Area

Eccentricity

Maximum eccentricity. Higher values gives less blur at distance angles and is slower.

Size

Multiply the filter size used by MIP map and interpolation.

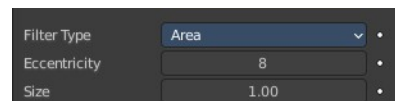

Minimum Size

Use the filter size as a minimal filter value.

Magic panel

Image type Magic.

Depth

The depth of the calculation. A higher number results in a long calculation time, but also in finer details.

Turbulence

The strength of the pattern.

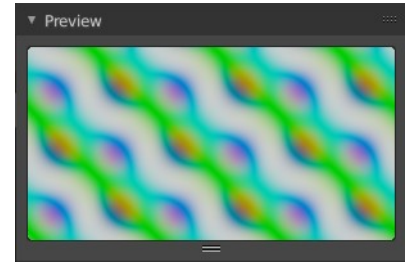
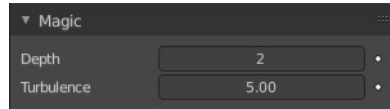

Marble panel

Image type Marble.

Noise Basis

What noise method to use.

Pattern

Settings for soft to more clearly defined Marble.

Second basis

Shape of wave to produce bands.

Type

The noise function works with two methods. Soft or hard.

Size

The dimensions of the noise table.

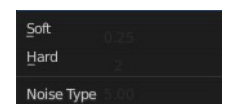
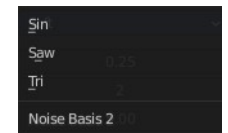
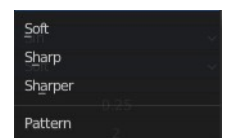
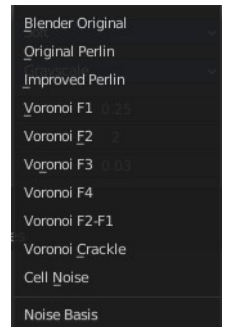
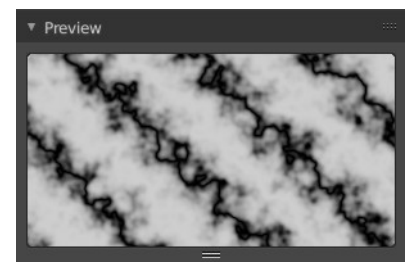
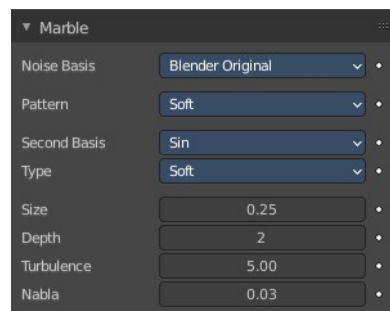

Depth

The depth of the Marble calculation. A higher value results in greater calculation time, but also in finer details.

Turbulence

The turbulence of the sine bands.

Nabla

Size of derivate offset used for calculating normal.

In order to calculate a normal, you usually use three samples in texture space. Typically that's the current sample location, and two other positions in texture U and V directions. This "nabla" value defines how far away these positions are.

Musgrave panel

Image type Musgrave.

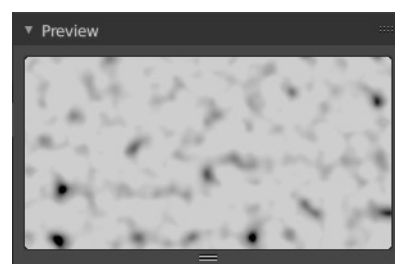
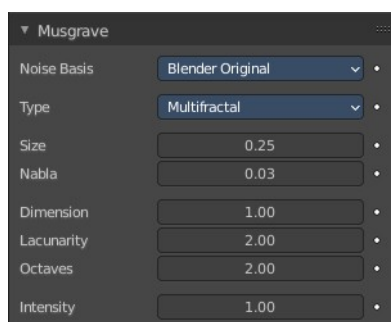

Noise Basis

What noise method to use.

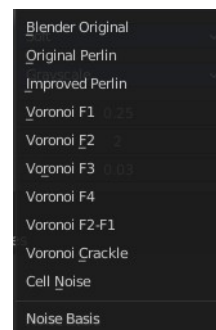

Type

What noise type to use.

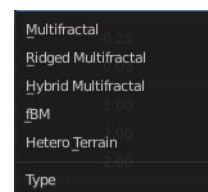

Size

The input noise scale.

Nabla

Size of derivate offset used for calculating normal.

In order to calculate a normal, you usually use three samples in texture space. Typically that's the current sample location, and two other positions in texture U and V directions. This "nabla" value defines how far away these positions are.

Dimension

Fractal dimension controls the contrast of a layer relative to the previous layer in the texture. The higher the fractal dimension, the higher the contrast between each layer, and thus the more detail shows in the texture.

Lacunarity

Lacunarity controls the scaling of each layer of the Musgrave texture, meaning that each additional layer will have a scale that is the inverse of the value which shows on the button. i.e. Lacunarity = 2 → Scale = 1/2 original.

Octaves

Octave controls the number of times the original noise pattern is overlaid on itself and scaled/contrasted with the fractal dimension and lacunarity settings.

Intensity

Light intensity. Called Offset for Hetero Terrain.

Offset

Hybrid Multifractal and Ridged Multifractal type. Both have a “Fractal Offset” button that serves as a “sea level” adjustment and indicates the base height of the resulting bump map. Bump values below this threshold will be returned as zero.

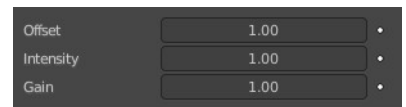

Gain

Hybrid Multifractal and Ridged Multifractal type. Setting which determines the range of values created by the function. The higher the number, the greater the range. This is a fast way to bring out additional details in a texture where extremes are normally clipped off.

Stucci panel

Image type Stucci.

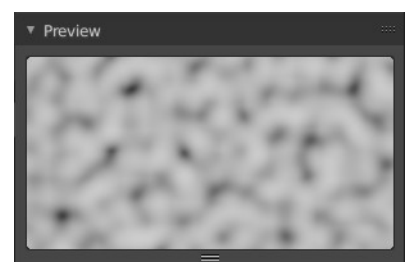
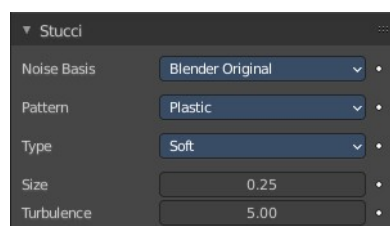

Noise Basis

What noise method to use.

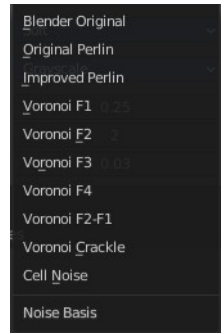

Pattern

Plastic is the standard Stucci, while the “walls” is where Stucci gets its name. This is a typical wall structure with holes or bumps.

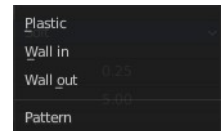

Type

There are two methods available for working with Noise. Soft or Hard.

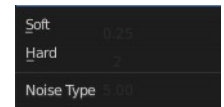

Size

Dimension of the Noise table.

Turbulence

Depth of the Stucci calculations.

Voronoi panel

Image type Voronoi.

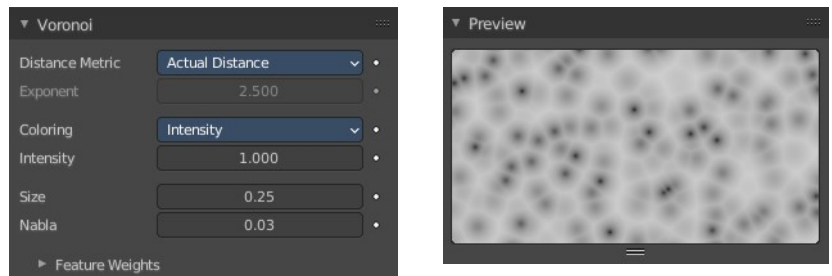

Distance Metric

This procedural texture has seven Distance Metric options. These determine the algorithm to find the distance between cells of the texture.

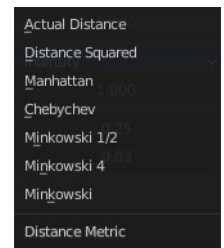

Exponent

The Minkowski setting has a user definable value (the Exponent button) which determines the Minkowski exponent e of the distance function.

$$(xe + ye + ze)^{1/e}$$

A value of one produces the Manhattan distance metric, a value less than one produces stars (at 0.5, it gives a Minkowski 1/2), and higher values produce square cells (at 4.0, it gives a Minkowski 4, at 10.0, a Chebychev). So nearly all Distance Settings are basically the same – a variation of Minkowski.

Coloring

Different ways to calculate color and intensity of the texture output.

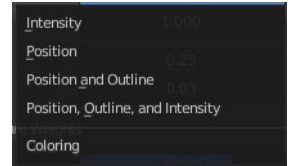

Feature Weights subpanel

These four sliders at the bottom of the Voronoi panel represent the values of the four Worley constants, which are used to calculate the distances between each cell in the texture based on the distance metric.



Wood panel

Image type Wood.

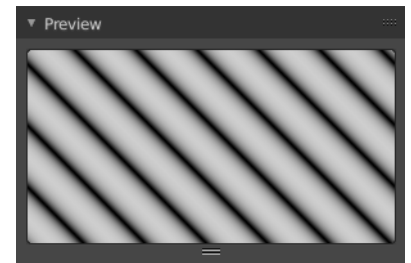

Noise Basis

What noise method to use.

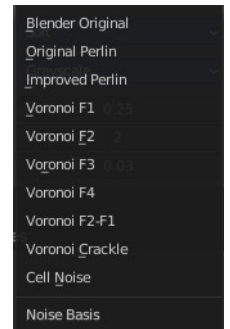

Pattern

The wood pattern.

Type, Size Turbulence and Nabla are just active with Pattern Type Band Noise and Ring Noise.

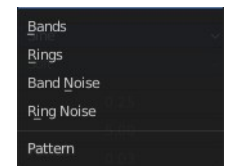

Second basis

Shape of wave to produce bands.

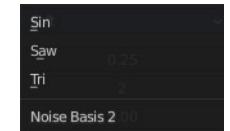

Type

Smooth transitions or sharp transitions. Changes contrast and sharpness.

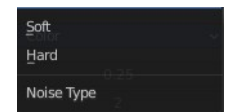

Turbulence

The turbulence of band noise and ring noise.

Nabla

Size of derivate offset used for calculating normal.

In order to calculate a normal, you usually use three samples in texture space. Typically that's the current sample location, and two other positions in texture U and V directions. This "nabla" value defines how far away these positions are.

Colors Panel

Clamp

Clamps the range by setting the negative rgb and intensity values to zero.

Multiply R G B

Multiply factor for the r g and b channel.



Brightness

The brightness of the texture.

Contrast

The contrast of the texture.

Saturation

The saturation of the texture.

Color ramp subpanel

Specify a range of colors based on color stops. The color between the color stops gets interpolated.

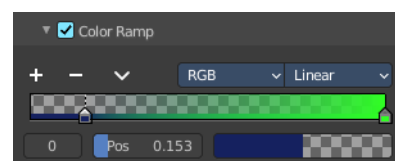

+

Add a stop to your color ramp. The stop will be added after the selected one, in the middle to the next one.

-

Deletes the selected color stop from the list.

Tools menu

Flip Color Ramp

Flips the gradient, inverting the values of the color ramp.

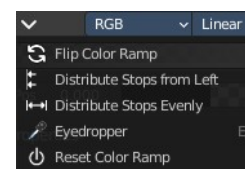

Distribute Stops from Left

Rearrange the stops so that every step has the same space to the right.

Distribute Stops Evenly

Space between all neighboring stops becomes equal.

Eyedropper (pipette icon) E

An Eyedropper to sample a color or gradient from the interface to be used in the color ramp.

Reset Color Ramp

Resets the color ramp to its default state.

Color Mode

RGB

Blends color by mixing each color channel and combining.

HSV/HSL

Blends colors by first converting to HSV or HSL, mixing, then combining again. This has the advantage of maintaining saturation between different hues, where RGB would de-saturate, this allows for a richer gradient.

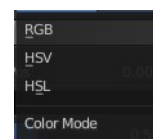

Interpolation

Ease

Uses an Ease Interpolation for the color stops.

Cardinal

Uses a Cardinal Interpolation for the color stops.

Linear

Uses a Linear Interpolation for the color stops.

B-Spline

Uses a B-Spline Interpolation for the color stops.

Constant

Uses a Constant Interpolation for the color stops.

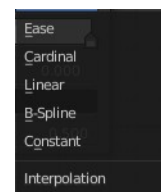

Color Ramp

The color band. A click at one of the color stops makes it the active one. You can move the color stops by clicking at them and dragging them around.



Active Color Stop elements

Adjust the active color stop.

Choose active color stop

Choose the color stop by index.



Pos

The position of the active color stop. The range goes from 0.000 to 1.000

Color

The color of the active color stop. Clicking at it opens a color picker.

Custom Properties Panel

Allows to define custom properties that can be used for scripting.

Here you might also find custom properties from addons or scripts.

Add

Adds a new property.

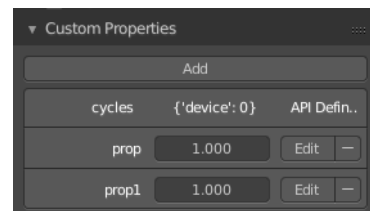

Edit

Opens a panel where you can adjust the settings for the custom property.

Remove

Removes the property.

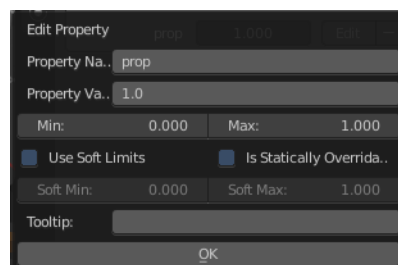



26.17 Editors - Properties Editor - Bone Properties Tab

Table of content

Editors - Properties Editor - Bone Tab.....	2
Bendy Bones panel.....	3
Segments.....	3
Curve X Y Offsets.....	3
Roll.....	3
Inherit End Roll.....	3
Scale.....	3
Ease In , Ease Out.....	4
Scale Easing.....	4
Custom Handles.....	4
Start + End Handle Type.....	4
Automatic.....	4
Absolute.....	4
Relative.....	4
Tangent.....	4
Custom Handle.....	4
Scale.....	5
Ease.....	5
Relations panel.....	5
Bone Layers.....	5
Parent.....	5
Relative Parenting.....	5
Bone Group.....	5
Connected.....	5
Local Location.....	6
Inherit Rotation.....	6
Inherit Scale.....	6
Full.....	6
Fix Shear.....	6
Aligned.....	6
Average.....	6
None.....	6
None (Legacy).....	6
Transform panel.....	7
Edit Mode.....	7
Head X, Y Z.....	7
Tail X, Y Z.....	7
Roll.....	7
Lock.....	7
Pose Mode.....	7
Location X Y Z.....	7
Rotation W X Y Z.....	7
Mode.....	7
Scale X Y Z.....	8
Deform panel.....	8
Deform.....	8
Envelope Distance.....	8

Envelope Weight.....	8
Envelope Multiply.....	8
Radius Head.....	8
Tail.....	8
Inverse Kinematics panel.....	9
IK stretch.....	9
Lock IK X Y Z.....	9
Stiffness X Y Z.....	9
Limit X.....	9
Limit Y.....	9
Limit Z.....	9
Control Rotation.....	9
IK Rotation Weight.....	9
Viewport Display panel.....	9
Hide.....	10
Custom Shape.....	10
Workflow.....	10
Custom Object.....	10
Override Transform.....	10
Scale.....	10
Translation.....	10
Rotation.....	10
Override Transform.....	10
Scale to Bone Length.....	10
Wireframe.....	10

Editors - Properties Editor - Bone Tab

The bone tab contains bone related settings. The content differs from mode to mode. Left object mode, middle edit mode, right pose mode.

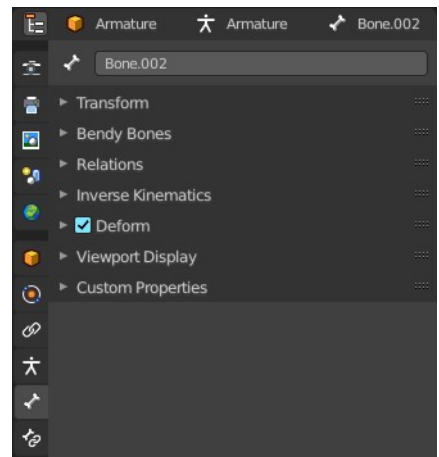
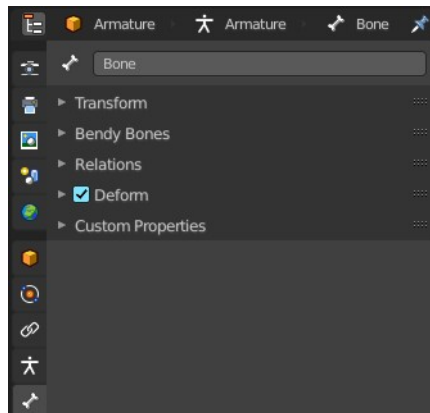
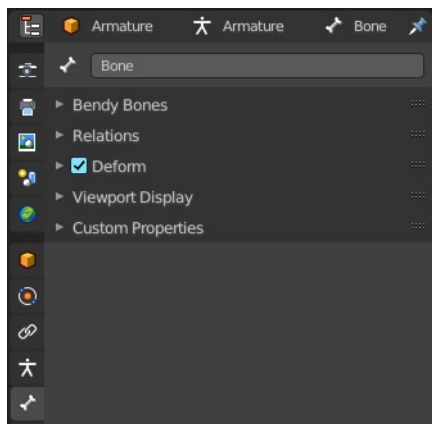

Bendy Bones panel

Settings for bendy bones. Bendy bones, also called Bbone, is a special bone mode that allows to divide bones into segments that can be bend and rotated. The “BBone Shape” Keying Set includes all Bendy Bones properties.

You have to activate Bbone in the Object data in the Viewport Display panel. Display as.

The settings becomes activated when the number of segments is higher than 1.

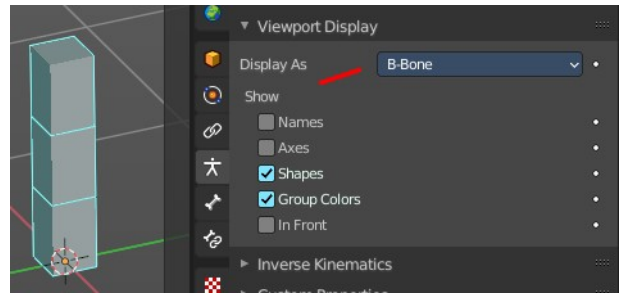

Segments

The Segments number field allows you to set the number of segments, which the given bone is subdivided into. Segments are small, rigid linked child bones that interpolate between the root and the tip. The higher this setting, the smoother “bends” the bone, but the heavier the pose calculations.

Curve X Y Offsets

Applies offsets to the curve handle positions on the plane perpendicular to the bone’s primary (Y) axis. As a result, the handle moves per axis (XY) further from its original location, causing the curve to bend.

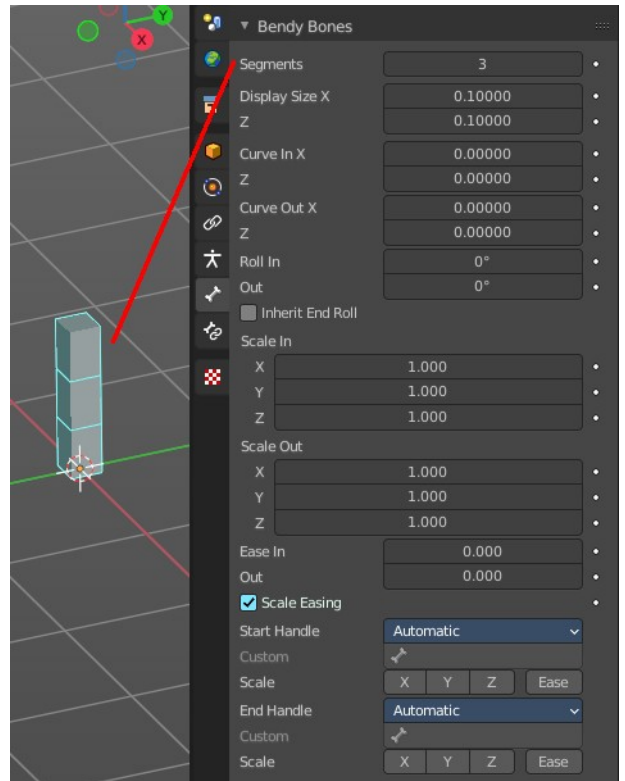

Roll

Roll In, Out

The roll value (or twisting around the main Y axis of the bone) is interpolated per segment, between the start and end roll values. It is applied as a rotational offset on top of the previous rotation.

Inherit End Roll

If enabled, the Roll Out value of the Start Handle bone (connected parent by default) will be implicitly added to the Roll In setting of the current bone.

Scale

Scale In X/Y, Scale Out X/Y

Scaling factor that adjusts the thickness of each segment for the X and Y axes only, i.e. length (Z axis) is not affected. Similar to Roll it is interpolated per segment.

Ease In , Ease Out

The Ease In/Out number fields, change the “length” of the “auto” Bezier handle to control the “root handle” and “tip handle” of the bone, respectively.

These values are proportional to the default length, which of course automatically varies depending on bone length, angle with the reference handle, and so on.

Scale Easing

Multiply the final easing values by the Scale In and Out Y value.

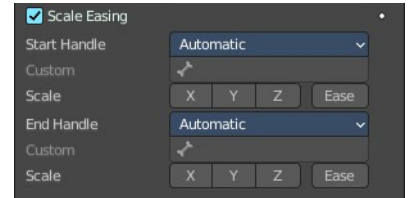

Custom Handles

B-Bones can use custom bones as their reference bone handles, instead of only using the connected parent/child bones.

Start + End Handle Type

Specifies the type of the handle from the following choices:



Automatic

The connected parent (or first connected child) of the bone is chosen as the handle. Calculations are done according to the Absolute handle type below.

Absolute

The Bezier handle is controlled by the position of the head (tail) of the handle bone relative to the head (tail) of the current bone. If the handle is also a B-Bone, additional processing is applied to further smooth the transition, assuming that the bones in effect form a chain.

Relative

The Bezier handle is controlled by the offset of the head (tail) of the handle bone from its rest pose. The use of this type is not recommended due to numerical stability issues near zero offset.

Tangent

The Bezier handle is controlled by the orientation of the handle bone, independent of its location.

Custom Handle

For types other than Automatic, a bone to use as handle has to be manually selected. Switching to a custom handle type without selecting a bone can be used to effectively disable the handle.

It is valid for two bones to refer to each other as handles – this correlation is applied in connected chains with Automatic handles.

Scale

Multiply the B Bone scale out channels by the local scale values of the start or end handle in x, y or z direction.

Ease

Use easing for the scaling, not linear.

Relations panel

Relation related settings. Note that in Edit mode relative parenting and bone group does not display.

Bone Layers

Allows you to move Bones between Layers by clicking at one of the buttons in the layer element with the needed bone(s) selected.

You can have a bone in several layers. Shift click will add the selected bone(s) to another layer without to remove it from the other layer.

You have to be in Edit Mode or Pose Mode to move bones between layers.

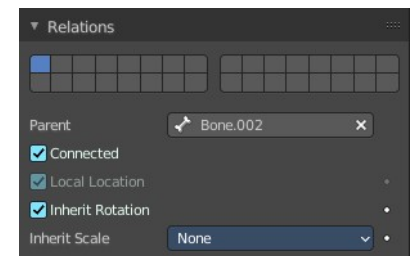
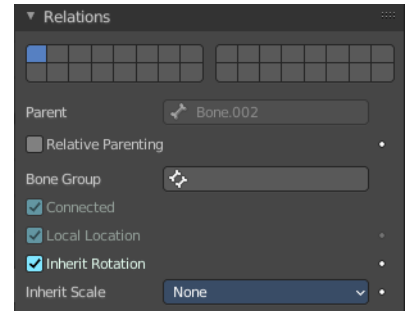

Parent

Usually bones are in a hierarchy with parent and child bones. This parent edit box displays the parent bone. The parent bone can be edited in edit mode.

Relative Parenting

Object children will use relative transform. Like deform.

Bone Group

Bones can be in a group. Bone groups are created in the Pose menu in pose mode. The drop down box also allows you to assign the selection to another existing bone group. A bone can be in more than one bone group.

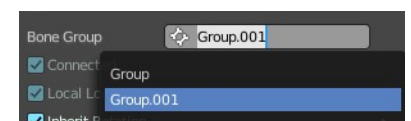

Connected

Set the head of the bone to be connected with its parent root.

Local Location

When disabled, the location transform property is evaluated in the parent bone's local space, rather than using the bone's own rest pose local space orientation.

Inherit Rotation

When disabled, this will “break” the rotation relationship to the bone’s parent. This means that the child will keep its rotation in the armature object space when its parent is rotated.

Inherit Scale

Specifies which effects of parent scaling the bone inherits.

Full

The bone inherits all effects of parent scaling and shear.

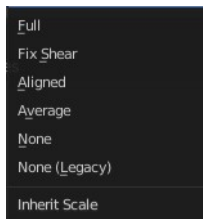

Fix Shear

Corrects the transformation inherited from the parent to remove shear caused by non-uniform parent scaling and rotation. The process preserves the bone direction, length and volume, and minimally affects roll on average.

If the inherited scale is non-uniform, this does not prevent shear from reappearing due to local rotation of the child bone, or of its children.

Aligned

Parent scaling is inherited as if the child was oriented the same as the parent, always applying parent X scale over child X scale, and so on.

This mode never causes shear and is natural for connected chains like limbs and tentacles.

Average

Inherits a uniform scaling factor that is the total change in the volume of the parent.

This effectively keeps the uniform part of the scaling of the parent, while removing squash and stretch effects. Uniform scaling never causes shear.

None

Ignores all scaling and shear of the parent.

None (Legacy)

Ignores all scaling, provided the parent is not sheared. If it is, there are no guarantees.

This choice replicates the behavior of the old Inherit Scale checkbox, and may be removed in a future release.

These inheriting behaviors propagate along the bones’ hierarchy. So when you scale down a bone, all its descendants are by default scaled down accordingly. However, if you disable one bone’s Inherit Scale or Inherit Rotation property in this “family”, this will break the scaling propagation, i.e. this bone and all its descendants will no longer be affected when you scale one of its ancestors.

Transform panel

Edit Mode

In Edit mode the bones are created and modified. A bone has a head and a tail. These positions can be adjusted.

Head X, Y Z

The position of the head of the selected bone.

Tail X, Y Z

The position of the tail of the selected bone.

Roll

The bone rotation around the head - tail axis.

Lock

Lock the whole bone, the head or the tail from further editing. This depends of what is the current active element.

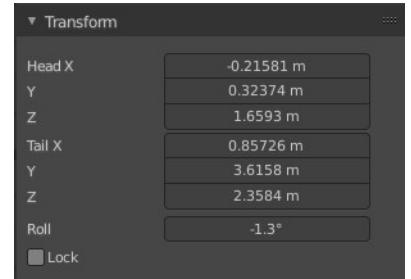

Pose Mode

Location X Y Z

The location of the root bone. Just the root bone can be re-positioned. For all other bones in the hierarchy the edit boxes are greyed out.

Rotation W X Y Z

The rotation of the current bone. With Mode Quaternion you will have the W axis too. With euler angles you will just have X Y and Z axis.

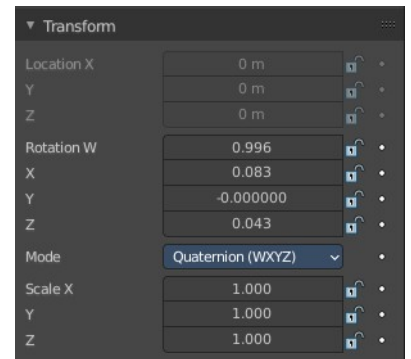

Mode

The rotation mode to use. Euler angles can run into a gimbal lock problem. This means the bone is not longer rotatable. Quaternion rotation avoids gimbal lock.

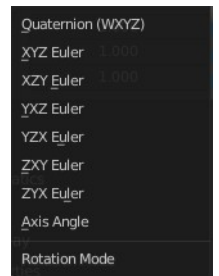

Scale X Y Z

The scale of the bone.

Deform panel

Deform

Enable the bone to deform geometry.

Toggling the checkbox in the panel header off, prevents the bone from deforming the geometry at all, overriding any weights that it might have been assigned before; It mutes its influence.

It also excludes the active bone in the automatic weight calculation when the mesh is parented to the armature using the Armature Deform tool with the “With Automatic Weights” option.

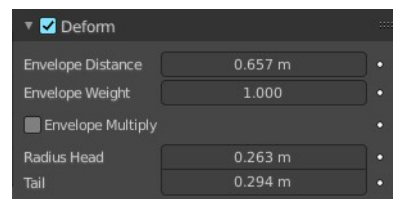

Envelope Distance

Envelope is something like a hull around the bone, which defines an influence area for weighting.

The Distance defines a volume which is the range within the bone has an influence on vertices of the deformed object. The geometry is less and less affected by the bone as it goes away by following a quadratic decay.

Envelope Weight

A bone property, that controls the global influence of the bone over the deformed object, when using the envelopes method.

It is only useful for the parts of geometry that are “shared”, influenced by more than one bone (generally, at the joints...) – a bone with a high weight will have more influence on the result than one with a low weight... Note that when set to 0.0, it has the same effect as disabling the Deform option.

Envelope Multiply

When deforming bone, multiply effects of vertex group weights with Envelope influence.

Radius Head

Set the radius for the head of envelope bones. Inside this volume, the geometry is fully affected by the bone.

Tail

Set the radius for the tail of envelope bones. Inside this volume, the geometry is fully affected by the bone.

Inverse Kinematics panel

Settings for inverse kinematics. Pose mode only.

IK stretch

Allow scaling of the bone for IK.

Lock IK X Y Z

Lock the single axis for IK.

Stiffness X Y Z

Add a stiffness around the axis.

Limit X

Limit movement around the X axis.

Limit Y

Limit movement around the X axis.

Limit Z

Limit movement around the X axis.

Control Rotation

When you use Inverse Kinematics with the iTaSC solver in the object data properties in the Inverse Kinematics panel, then you will reveal this checkbox.

Apply channel rotation as IK constraint.

IK Rotation Weight

Weight of rotation constraint for IK.

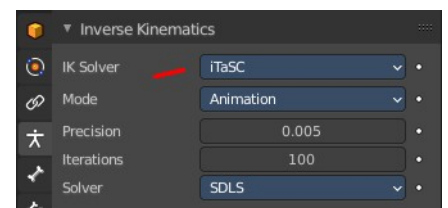
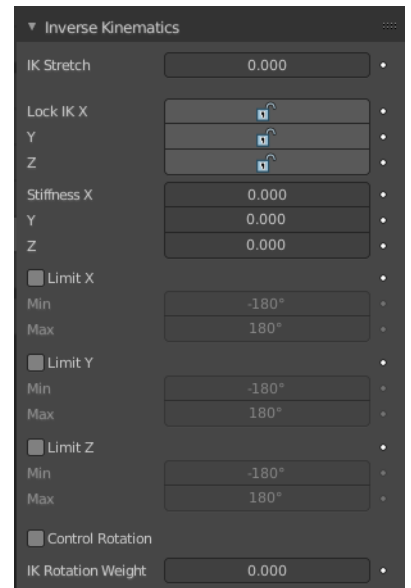

Viewport Display panel

Hide

Hides the selected bone in the viewport.

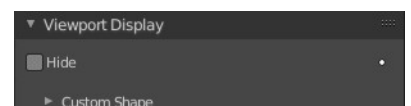

Custom Shape

Use a custom object to be displayed as the bone in Object and Pose mode.

Workflow

Switch to Pose Mode.

Select the relevant bone by clicking on it.

Go to the Display panel Custom Shape field and select an object in the scene that you want to use as a display object.

Custom Object

The object that defines the custom shape of the selected bone.

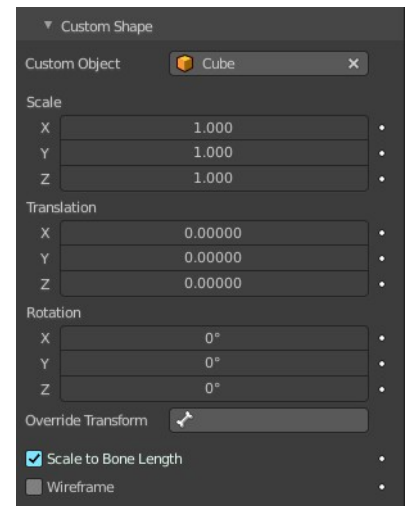

Override Transform

Bone that defines the display transform of the custom shape.

Scale

Scale the custom object.

Translation

Position the custom object.

Rotation

Rotate the custom object. This happens in Euler angles.

Override Transform

The bone that defines the display transform of this custom shape.

Scale to Bone Length

Option not to use bones length, so that changes in Edit Mode don't resize the custom shape.

Wireframe

Display bone in wire frame mode regardless of the viewport display mode.



26.18 Editors - Properties Editor - Bone Constraint Properties

Table of content

Bone Constraints.....	2
What is Inverse Kinematics?.....	2
Quick Setup.....	3
Adding a bone as an IK handler.....	3
Adding an Object as an IK handler.....	4
IK Constraint.....	5
Target.....	5
Bone.....	5
Pole Target.....	5
Bone.....	5
Pole Angle.....	5
Iterations.....	5
Chain Length.....	5
Use Tail.....	6
Stretch.....	6
Weight.....	6
Position.....	6
Rotation.....	6
Influence.....	6
Spine IK Constraint.....	6
Target.....	6
Influence.....	6
Fitting subpanel.....	6
Chain Length.....	6
Even Division.....	7
Chain Offset.....	7
Chain Scaling subpanel.....	7
Use Curve Radius.....	7
Y scale mode.....	7
None.....	7
Fit Curve.....	7
Bone Original.....	7
XZ Scale Mode:.....	7
None.....	7
Bone Original.....	7
Inverse Scale.....	8
Use Original Scale.....	8
Volume Preservation.....	8
Use Original Scale.....	8
Volume Variation.....	8
Volume Min / Volume Max.....	8
Smooth.....	8

Bone Constraints

Constraints allows two objects to interact with each other. You can for example set the x position to the x position of another object with the Copy Location constraint. Bone constraints is a special constraints chapter just dedicated to bones. And just shows when you have an armature or a bone selected.

Bones behave like objects in Pose Mode. And so they can also be constrained.

The Bone Constraints tab shows in Object Mode and Pose mode.

In Object mode you can edit existing constraints. But you can't add constraints in Object mode. Bone Constraints can only be added in Pose Mode.

The constraints drop down menu shows the same constraints than the Object Constraints tab. You can add any of the other object constraints here. Like a Limit Rotation from the Transform category, to limit the rotation of an elbow for example.

Most of the other constraints works with all object types, and are explained in the Object Constraints chapter. But there are two constraints that just works for and with bones. And can just be added from the Bone Constraints drop down menu. The IK constraint and the Spline IK constraint. Both are covered in this chapter.

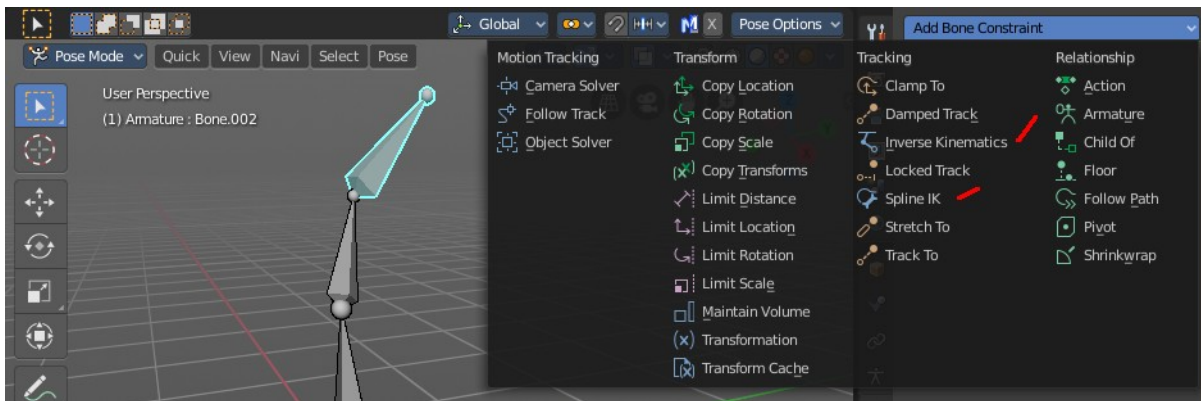
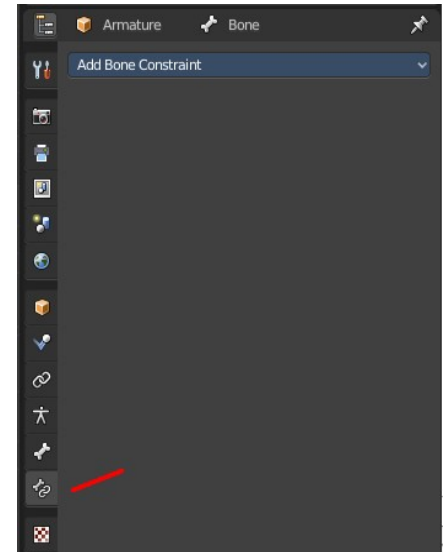

What is Inverse Kinematics?

You can pose a skeleton in two ways. With Forward Kinematics. And with Inverse Kinematics.

Forward kinematics means, you bend a bone, and the bones downwards the hierarchy follows this motion. For example you pull the elbow, and the hand with its fingers follows. You don't need a constraint for that. This is native behavior of an armature.

The other technique is called inverse kinematics. Here the motion gets calculated upwards the hierarchy. For example you pull at the hand, and the arm follows. That's where you need the IK Constraint.

Quick Setup

You can add the Inverse Kinematics from the 3D View. Or directly in the Bone Constraints panel. In Pose Mode select the bone, and either choose the Add IK to Bone in the Pose menu. Or add the constraint directly in the Bone Constraint tab.

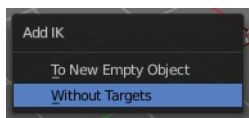
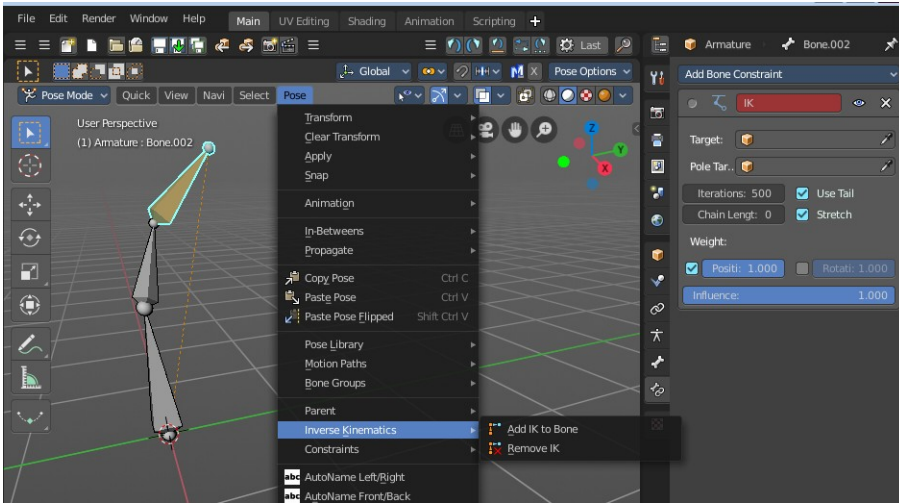

The Add IK to Bone menu item brings up a sub item. Without targets means that it just creates the constraint. It misses the handler to pose it then. And so you have to pull at the bone with the IK solution to pose your armature. The title of the constraint is red when the target is missing. Which usually means that the constraint is dysfunctional since it misses some vital information. But you can nevertheless use this constraint in Pose Mode as is.

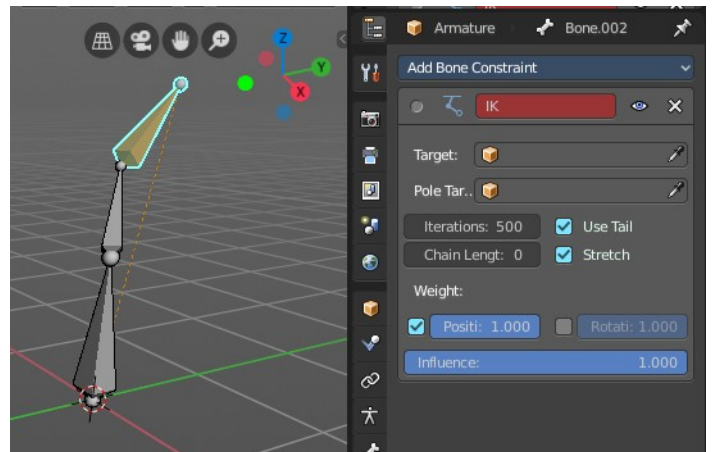

A common method is to use an unconnected Bone inside of the same armature to be the target or the pole target. But then you can still just pose this armature in Pose mode.

Adding a bone as an IK handler

In Edit Mode create a loose bone in your armature. Turn off Connected and clear Parent in the Relations panel. Untick Deform. We use this bone as a handler, not as a bone.

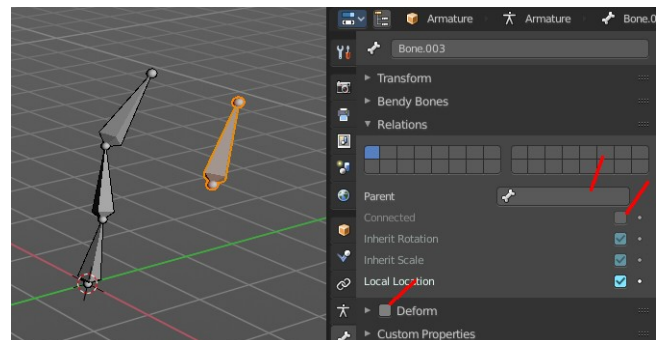

Go to Pose mode. Select the IK bone. Hold down Shift and select the bone where you want to add the IK to.

Then in the Pose menu choose Constraints, Add (With Targets), and choose the IK constraint in the upcoming menu.

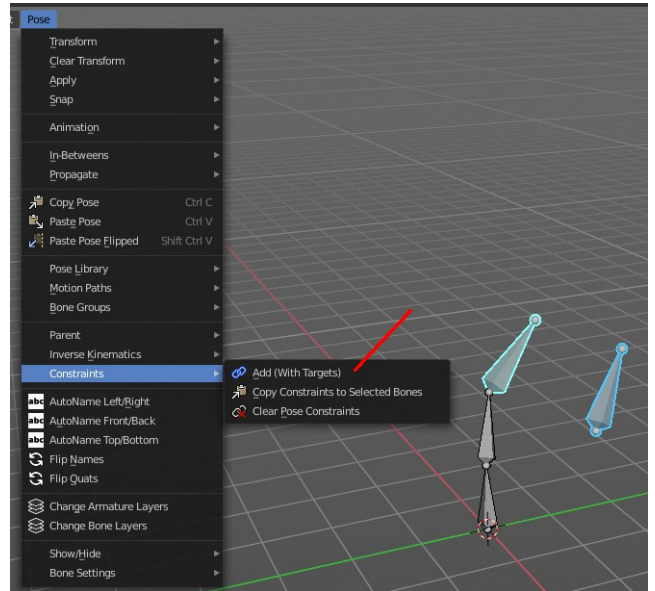
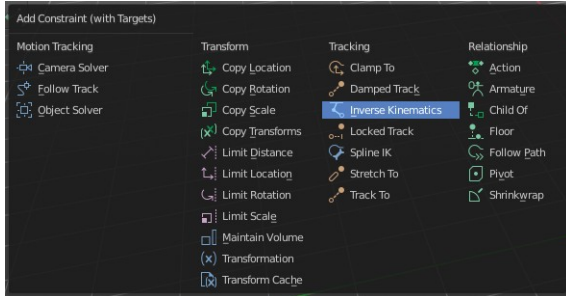

This creates the IK constraint, and will add our prepared bone to be the target. And now you can pull at this bone in Pose Mode, and the IK solution will follow this bone.

Needless to say that you might be faster to add the IK constraint manually in the Bone IK tab here. You have to adjust it anyways ...

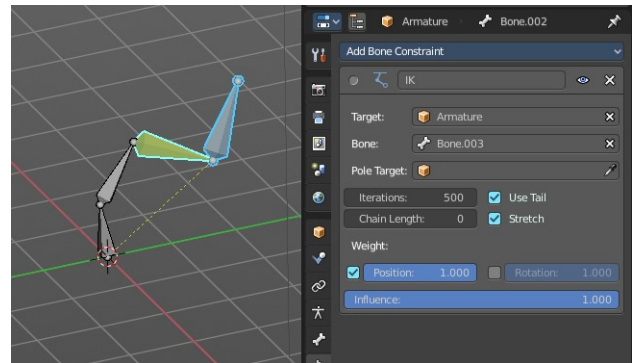

Adding an Object as an IK handler

You might want to animate a character together with other objects. They are usually animated in Object Mode. And so you need a solution to pose your character in Object mode, and not in Pose mode. For that you can simply add any object in the scene to be the IK handler instead of a bone in the same armature.

First go to the Pose menu again. Choose Inverse Kinematics / Add IK to Bone. Then choose To New Empty Object

This adds the IK constraint, and creates an empty as the Target. This empty can then be used as a handler to pose the IK solution in Object Mode. The IK solution will follow this Target.

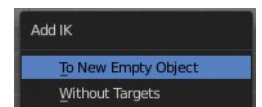
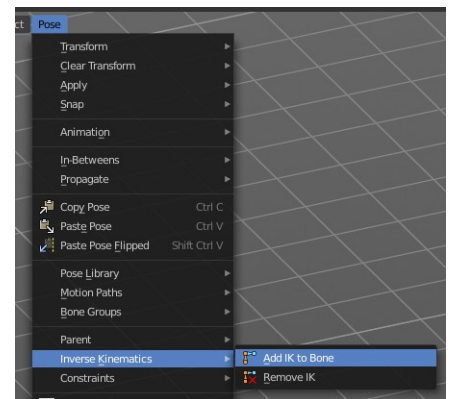

You can add any other object in the scene as a Target. It does not need to be an empty. Simply replace it in the IK constraint in the Target edit box.

The further functionality of the IK constraint gets explained below.

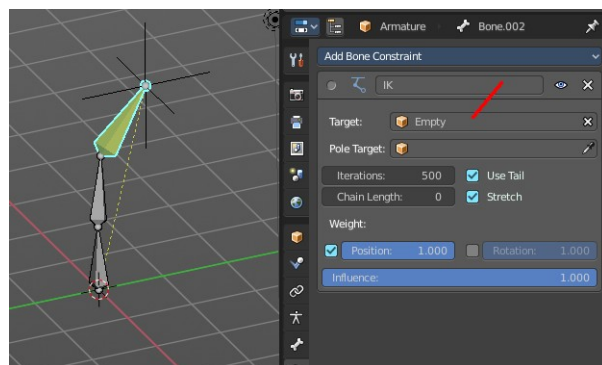

IK Constraint

Target

Add an object as an IK handler object.

Bone

If the target is an armature, then you can choose the bone here that you want to use as an IK handler.

Pole Target

Add an object to be the Pole target.

Pole target is a secondary IK target. An object that lets the IK solution point into a defined direction, towards this object.

Think of a knee here for example. Without a Pole target the knee might dance around when you try to pose the leg. And it will point in all directions but the one in that it should bend. With a Pole target you can let the IK solution point towards this target object.

Bone

If the target is an armature, then you can choose the bone here that you want to use as a Pole Target.

Pole Angle

The IK solution might not point correctly into the direction of the Pole target. Or you might need some offset. This property allows you define an offset for the pole angle.

Iterations

The maximum number of iterations to calculate the IK solution

Chain Length

How many bones are included into this IK solution. A value of 0 uses all bones.

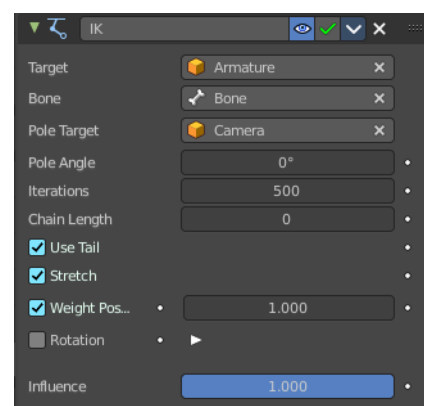

Use Tail

Include the Bone's tail as the last element in chain.

Stretch

Enable IK stretching.

Weight

Position

For Tree IK (multiple IK targets): Weight of Position Control for this target.

Rotation

For Tree IK (multiple IK targets): Weight of Orientation Control for this target.

Influence

The influence level of this constraints.

Spine IK Constraint

The *Spline IK* constraint aligns a chain of bones along a curve. This constraint requires to have a curve object in the scene as the target object. So you should create one beforehand.

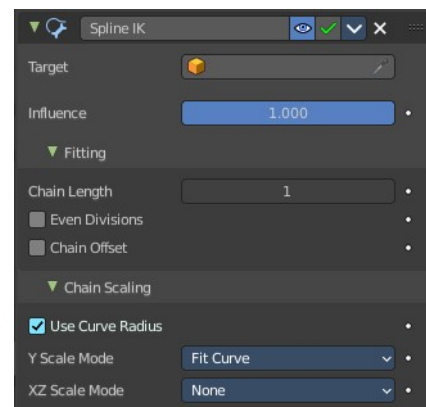
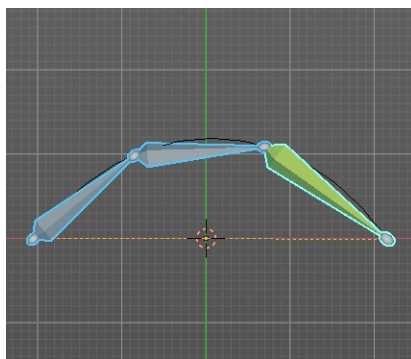

Target

Choose the target curve.

Influence

The influence level of this constraints.

Fitting subpanel

Chain Length

How many bones are included in the chain. Set it to 0 to influence the whole chain.

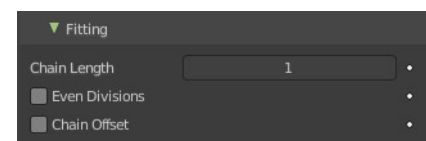

Even Division

Ignore the relative length of the bones when fitting to the curve. Every bone in the chain will be equal long.

Chain Offset

Offset the entire chain relative to the root joint. Else just the bones in reach of the chain length gets aligned.

Note: The calculation happens relative to the curve. When this curve is rotated in world space, then the bones still uses the unrotated state of the curve.

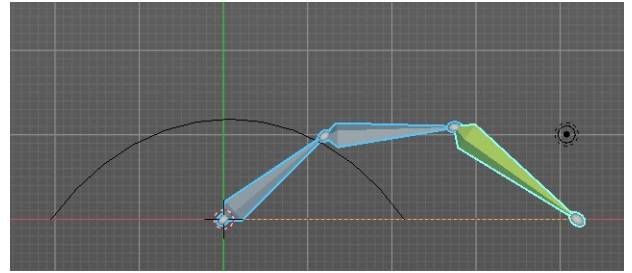

Chain Scaling subpanel

Use Curve Radius

Average radius of the endpoints is used to tweak the X and Z scaling of the bones, on top of the X and Z scale mode.

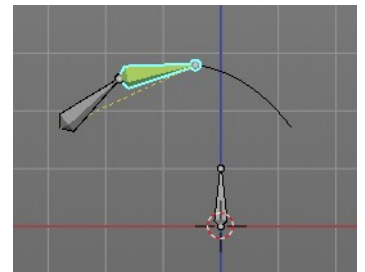
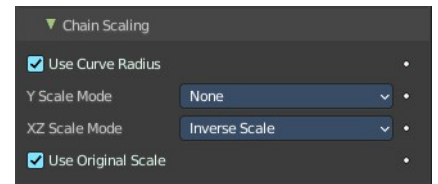

Y scale mode

Choose how the bone length should fit into the curve length.

None

Don't scale the X and Z axes.

Fit Curve

Fit the bone chain length into the length of the curve.

Bone Original

Use the original scaling of the bones.



XZ Scale Mode:

None

Don't scale the X and Z axes.

Bone Original

Use the original scaling of the bones.

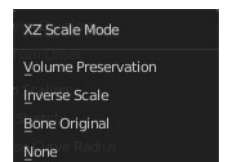

Inverse Scale

Scale of the Z and X axis is the inverse of the Y axis.



Use Original Scale

Apply volume preservation over the original scaling.

Volume Preservation

Scale of the X and Z axes is the inverse of the Y scale. With enabling Volume Preservation you will reveal some further options for this method.

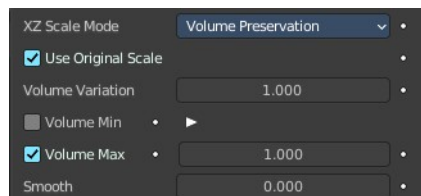

Use Original Scale

Apply volume preservation over the original scaling.

Volume Variation

Factor between volume variation and stretching.

Volume Min / Volume Max

Minimum and maximum volume stretching factor.

Smooth

You need to have either Volume min or Volume max set to active to show this setting. Adjust the factor between volume variation and stretching.



26.2 Editors - Properties Editor - Render Properties Tab

Table of content

Detailed Table of content.....	1
Render Tab.....	10
Color Management panel - All Renderers.....	11
Cycles and Eevee - Freestyle panel.....	15
Cycles - Sampling panel.....	16
Cycles - Light Paths panel.....	20
Cycles - Volumes panel.....	23
Cycles - Curves panel.....	23
Cycles - Simplify panel.....	24
Cycles - Motion Blur panel.....	26
Cycles - Film panel.....	28
Cycles - Performance panel.....	28
Cycles - Bake panel.....	30
Workbench - Lighting panel.....	34
Workbench - Color panel.....	35
Workbench - Options panel.....	36
Eevee - Sampling panel.....	38
Eevee - Ambient Occlusion panel.....	38
Eevee - Bloom panel.....	39
Eevee - Depth of Field panel.....	39
Eevee - Subsurface Scattering panel.....	40
Eevee - Screen Space reflections panel.....	40
Eevee - Motion Blur panel.....	41
Eevee - Volumetric panel.....	42
Eevee - Curves panel.....	43
Eevee - Shadows panel.....	43
Eevee - Indirect Lighting panel.....	44
Eevee - Film panel.....	45
Eevee + Workbench - Simplify panel.....	45

Detailed Table of content

Detailed table of content

Detailed Table of content.....	1
Render Tab.....	10
Cycles Feature Set.....	10
Cycles Device.....	11
Open Shading Language.....	11
Color Management panel - All Renderers.....	11
Display Device.....	11
View Transform.....	11
Standard.....	11
Filmic.....	12
Filmic Log.....	12

Raw.....	12
False Color.....	12
Look.....	12
Exposure.....	12
Gamma.....	12
Sequencer Color Space.....	12
Use Curves.....	13
Navigation elements.....	13
Zoom in and out.....	13
Tools.....	13
Reset View.....	13
Vector Handle.....	13
Auto Handle.....	13
Auto Clamped Handle.....	13
Extend Horizontal.....	13
Extend Extrapolated.....	13
Reset Curve.....	13
Use Clipping.....	13
Delete Points.....	13
Black Level.....	14
White Level.....	14
Hotkeys for Black and White Level.....	14
Reset.....	14
Cycles and Eevee - Freestyle panel.....	15
What is FreeStyle?.....	15
Enable.....	15
Line Thickness Mode.....	15
Absolute.....	15
Relative.....	15
Line Thickness.....	16
Cycles - Sampling panel.....	16
Viewport subpanel.....	16
Presets.....	16
Adaptive Sampling.....	16
Adaptive sampling threshold.....	16
Max Samples.....	16
Min Samples.....	16
Samples.....	16
Denoise Sub Subpanel.....	16
Use Denoising Checkbox.....	17
Denoiser.....	17
Automatic.....	17
OptiX.....	17
OpenImageDenoiser.....	17
Passes.....	17
Start Sample.....	17
Render subpanel.....	17
Presets.....	17
Adaptive sampling threshold.....	17
Max Samples.....	17
Min Samples.....	17
Samples.....	18
Time Limit.....	18

Denoise Sub Subpanel.....	18
Use Denoising Checkbox.....	18
Denoiser.....	18
Automatic.....	18
OptiX.....	18
OpenImageDenoiser.....	18
Passes.....	18
Start Sample.....	18
Path Guiding subpanel.....	18
Training Samples.....	18
Surface.....	19
Volume.....	19
Lights subpanel.....	19
Light Tree.....	19
Light Threshold.....	19
Advanced subpanel.....	19
Seed.....	19
Animate Seed.....	19
Pattern.....	19
Sobol.....	19
Progressive Multi-Jitter.....	19
Sample Offset.....	19
Scrambling Distance.....	20
Adaptive.....	20
Viewport.....	20
Min Light Bounces.....	20
Min Transparent Bounces.....	20
Light Threshold.....	20
Cycles - Light Paths panel.....	20
Presets.....	20
Max Bounces.....	21
Total.....	21
Diffuse.....	21
Glossy.....	21
Transmission Bounces.....	21
Volume.....	21
Transparent.....	21
Clamping.....	21
Direct Light.....	21
Indirect Light.....	21
Caustics.....	21
Filter Glossy.....	22
Reflective Caustics.....	22
Refractive Caustics.....	22
Fast GI approximation subpanel.....	22
Fast GI Approximation checkbox.....	22
Method.....	22
Replace.....	22
AO Factor.....	22
AO Distance.....	22
Viewport Bounces.....	23
Render Bounces.....	23
Add.....	23

AO Factor.....	23
AO Distance.....	23
Cycles - Volumes panel.....	23
Step Rate Render.....	23
Step Rate Viewport.....	23
Max Steps.....	23
Cycles - Curves panel.....	23
Shape.....	24
Curve Subdivisions.....	24
Viewport Display subpanel.....	24
Shape.....	24
Additional Subdiv.....	24
Cycles - Simplify panel.....	24
Enable.....	24
Viewport.....	24
Max Subdivisions.....	24
Child Particles.....	24
Texture Limit.....	25
AO Bounces.....	25
Volume Resolution.....	25
Render.....	25
Max Subdivisions.....	25
Child Particles.....	25
Texture Limit.....	25
Culling.....	25
Use Camera Cull.....	25
Camera cull margin.....	25
Use Distance Cull.....	25
Distance.....	25
Grease Pencil.....	26
Playback Only.....	26
Fill.....	26
Modifiers.....	26
Shader Effects.....	26
Layers Tinting.....	26
Antialiasing.....	26
Cycles - Motion Blur panel.....	26
Enable.....	26
Position.....	26
Shutter.....	26
Rolling Shutter.....	27
Duration.....	27
Shutter Curve.....	27
Navigation elements.....	27
Zoom in and out.....	27
Tools.....	27
Reset View.....	27
Vector Handle.....	27
Auto Handle.....	27
Auto Clamped Handle.....	27
Extend Horizontal.....	27
Extend Extrapolated.....	27
Reset Curve.....	27

Use Clipping.....	28
Delete Points.....	28
X and Y values.....	28
Presets.....	28
Cycles - Film panel.....	28
Exposure.....	28
Pixel Filter.....	28
Type.....	28
Width.....	28
Cycles - Performance panel.....	28
Presets.....	28
Default.....	29
Faster Rendering.....	29
Lower Memory.....	29
Threads.....	29
Mode.....	29
Auto-detect.....	29
Fixed.....	29
Threads.....	29
Memory.....	29
Auto Tiles.....	29
Tile Size.....	29
Acceleration Structure.....	29
Use Spatial Splits.....	29
With CPU rendering:.....	30
Use compact BVH.....	30
With GPU rendering:.....	30
BVH Time Steps.....	30
Use Hair BVH.....	30
Final Render.....	30
Persistent Data.....	30
Viewport.....	30
Pixel Size.....	30
Cycles - Bake panel.....	30
Settings for all Texture types.....	31
Bake Button.....	31
Bake from Multires.....	31
Bake Type.....	31
Combined.....	31
Ambient Occlusion.....	31
Shadow.....	31
Position.....	31
Normal.....	32
UV.....	32
Roughness.....	32
Emit.....	32
Environment.....	32
Diffuse.....	32
Glossy.....	32
Transmission.....	32
Influence Sub panel.....	32
Glossy, Diffuse.....	32
Direct.....	32

Indirect.....	32
Color.....	32
Normal.....	33
Space.....	33
Swizzle.....	33
Combined.....	33
Direct.....	33
Indirect.....	33
Diffuse.....	33
Glossy.....	33
Transmission.....	33
Subsurface.....	33
AO.....	33
Emit.....	33
Selected to Active.....	33
Extrusion.....	33
Cage.....	34
Cage Object.....	34
Ray Distance.....	34
Output Sub panel.....	34
Target.....	34
Clear Image.....	34
Margin sub subpanel.....	34
Type.....	34
Adjacent Faces.....	34
Extend.....	34
Size.....	34
Workbench - Lighting panel.....	34
Flat.....	35
Studio.....	35
Light library browser.....	35
Rotation.....	35
User Preferences.....	35
Matcap.....	35
User Preferences.....	35
Flip Matcap.....	35
Workbench - Color panel.....	35
Material.....	36
Object.....	36
Vertex.....	36
Single.....	36
Random.....	36
Texture.....	36
Workbench - Options panel.....	36
X Ray.....	36
Backface Culling.....	36
Show X-Ray.....	36
X-Ray Alpha.....	36
Shadow.....	37
Shadow Intensity.....	37
Shading Shadow Options.....	37
Cavity.....	37
World.....	37

World Space / Ridge Valley.....	37
Shading Options.....	37
Screen.....	37
Screen Space / Ridge Valley.....	37
Both.....	37
Outline.....	37
Outline Color.....	37
Specular Lighting.....	38
Eevee - Sampling panel.....	38
Viewport Samples.....	38
Render Samples.....	38
Viewport Denoising.....	38
Eevee - Ambient Occlusion panel.....	38
Enable.....	38
Distance.....	38
Factor.....	38
Trace Precision.....	38
Bent Normals.....	38
Bounces Approximation.....	38
Eevee - Bloom panel.....	39
Enable.....	39
Threshold.....	39
Knee.....	39
Radius.....	39
Color.....	39
Intensity.....	39
Clamp.....	39
Eevee - Depth of Field panel.....	39
Max Size.....	39
Sprite Threshold.....	39
Neighbor Rejection.....	39
Denoise Amount.....	39
High Quality Slight Defocus.....	40
Jitter Camera.....	40
Overblur.....	40
Eevee - Subsurface Scattering panel.....	40
Enable.....	40
Samples.....	40
Jitter Threshold.....	40
Separate Albedo.....	40
Eevee - Screen Space reflections panel.....	40
Enable.....	40
Refraction.....	40
Half Res Trace.....	41
Trace Precision.....	41
Max Roughness.....	41
Thickness.....	41
Edge Fading.....	41
Clamp.....	41
Eevee - Motion Blur panel.....	41
Enable.....	41
Position.....	41
Shutter.....	41

Background Separation.....	41
Max Blur.....	42
Steps.....	42
Eevee - Volumetric panel.....	42
Start.....	42
End.....	42
Tile Size.....	42
Samples.....	42
Distribution.....	42
Viewport Volumetric Blending.....	42
Volumetric Lighting.....	42
Enable.....	42
Light Clamping.....	42
Volumetric Shadows.....	43
Enable.....	43
Samples.....	43
Eevee - Curves panel.....	43
Shape.....	43
Additional Subdiv.....	43
Eevee - Shadows panel.....	43
Method.....	43
Cube Size.....	43
Cascade Size.....	43
High Bit depth.....	43
Soft Shadows.....	43
Eevee - Indirect Lighting panel.....	44
Bake Indirect Lighting.....	44
Bake Cubemap Only.....	44
Delete Lighting Cache.....	44
Auto Bake.....	44
Diffuse Bounces.....	44
Cubemap Size.....	44
Diffuse Occlusion.....	44
Irradiance Smoothing.....	44
Clamp Glossy.....	44
Filter Quality.....	44
Display.....	45
Cubemap Size.....	45
Irradiance Size.....	45
Eevee - Film panel.....	45
Filter Size.....	45
Animate Property.....	45
Overscan.....	45
Overscan Size.....	45
Eevee + Workbench - Simplify panel.....	45
Enable.....	45
Viewport.....	45
Max Subdivisions.....	46
Child Particles.....	46
Volume Resolution.....	46
Animate Property.....	46
Render.....	46
Max Subdivisions.....	46

Child Particles.....	46
Animate Property.....	46
Grease Pencil.....	46
Playback Only.....	46
Fill.....	46
Modifiers.....	46
Shader Effects.....	46
Layers Tinting.....	47
Antialiasing.....	47

Render Tab

Rendering is the process of calculating a 2D image (or video) from your 3D scene. For this you use a so called render engine.

The Render tab contains the functionality and settings around the available render engines in Bforartists. And Choose the renderer with which you render your still or animation with.

There are three different render engines available. Workbench, Eevee and Cycles.

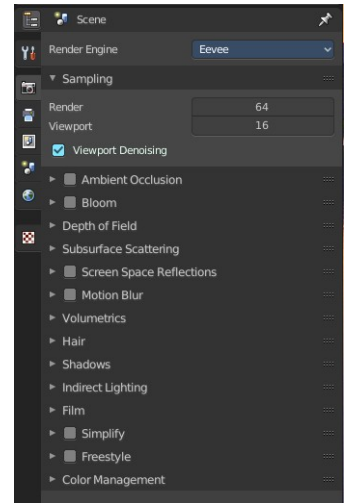
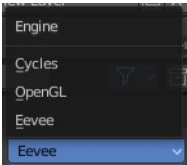

Cycles is a so called offline renderer. It is an unbiased physically correct renderer with some biased adjustments to make it usable for animations.

Cycles can render at the CPU or the GPU.

Eevee and Workbench are both so called Realtime Renderers. They both render at the GPU. Workbench relies at the OpenGL render features of the graphics card. Eevee is a full independent realtime render engine.

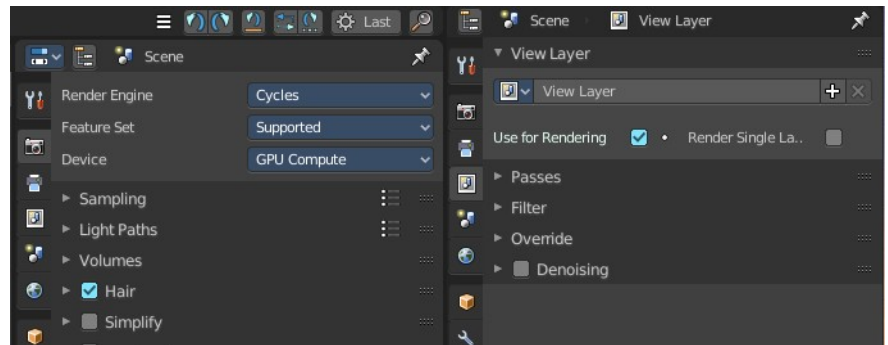

All three renderers have different settings. And the choice of the renderer influences the tab and panel content of the whole Scene section.

This content will be covered in the chapters for the other tabs.

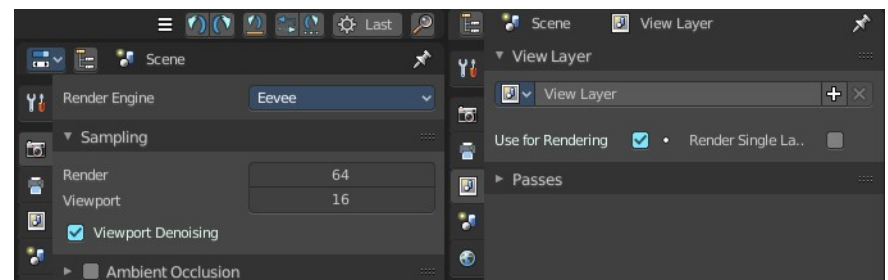

Cycles Feature Set

When you choose Cycles then you will see a new drop down box called Feature set. Cycles has two feature set settings. Supported and Experimental.

Supported means you have all common Cycles settings available.

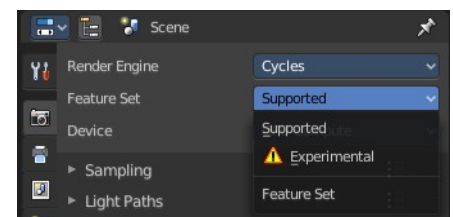

Experimental means that you have access to some further experimental features of Cycles, which are somehow functional, but are still experimental features. Like Adaptive subdivision. Those features may or may not work proper. Use at own risk!

Cycles Device

When you turn on Cuda in the User Preferences then you will get a Device drop down box to choose if you want to render with the CPU or the GPU.

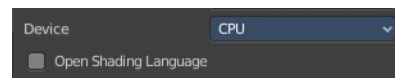

Open Shading Language

When you render with Cycles at the CPU, then you can choose to use the Open Shading Language.

Color Management panel - All Renderers

Color management is important to create renders and assets that are physically accurate and look great on multiple display devices. It is used both to ensure all parts of the pipeline interpret colors correctly, and to make artistic changes like exposure and color grading.

Bforartists color management is based on the OpenColorIO library. By using the same OpenColorIO configuration in multiple applications, the same color spaces and transforms will be available for consistent results.

In the Color Management panel you will find the settings around color management. It allows an artist to make sure that an image stays the same from rendering, to saving, to post-processing. Color management also allows an artist to tweak things like exposure, gamma, or the overall color grade.

The Color Management panel is the same for all render engines.

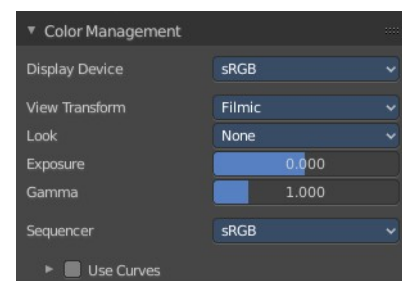

Display Device

The device that the image is being viewed on. Your monitor.

Most computer monitors are configured for the sRGB color space.

Note: Color management can also be disabled by setting the device to None.

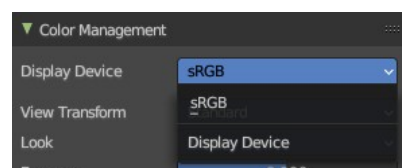

View Transform

Choose between different ways to view the image on the same monitor.

Standard

Does no extra conversion besides the conversion for the display device.

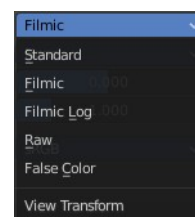

Filmic

For more photo realistic results and better handling of high dynamic range. The contrast can be adjusted by changing the *Look* option for the Filmic view transform.

Filmic Log

Converts to Filmic log color space. This can be used for export to color grading applications, or to inspect the image by flattening out very dark and light areas.

Raw

Intended for inspecting the image but not for final export. Raw gives the image without any color space conversion.

False Color

Shows a heat map of image intensities, to visualize the dynamic range.

Look

Adjust the contrast.

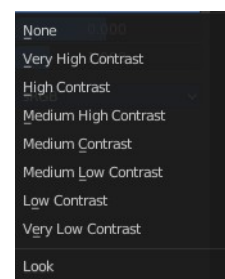

Exposure

Used to control the image brightness (in stops) applied before color space conversion. The calculation is: $output_value = render_value \times 2^{(exposure)}$

Gamma

Extra gamma correction applied after color space conversion. Note that the default sRGB or Rec709 color space conversions already include a gamma correction of approximately 2.2 (except the *Raw* and *Log* views), so this would be applied in addition to that.

Sequencer Color Space

The color space that the sequencer operates in. By default, the sequencer operates in sRGB space, but it can also be set to work in Linear space like the Compositing nodes, or another color space. Different color spaces will give different results for color correction, cross fades, and other operations.

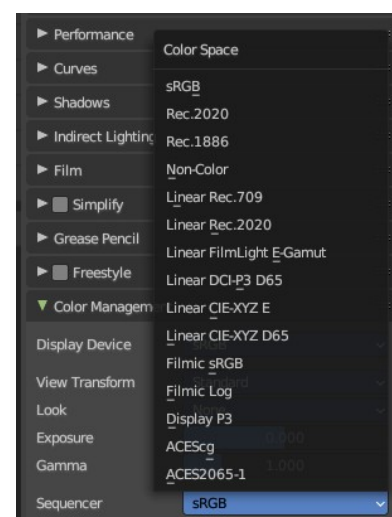

Use Curves

Adjust RGB Curves to control image colors before color space conversion.

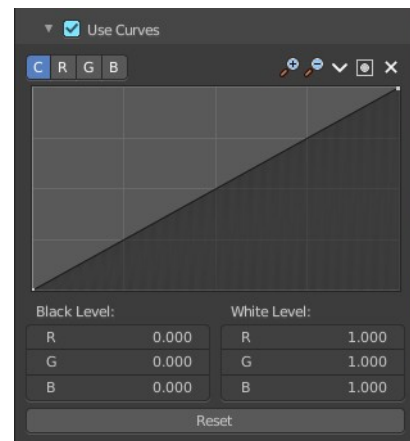

Navigation elements

The navigation elements at the top are described from left to right.



Zoom in and out

The two buttons with the magnifying glass at it zooms in and out in the curve window.

Tools

Tools is a menu that contains some curve related tools.

Reset View

Resets the curve windows zoom.

Vector Handle

Set handle type to Vector.

Auto Handle

Set handle type to Auto.

Auto Clamped Handle

Set handle type to Auto Clamped.

Extend Horizontal

Causes the curve to stay horizontal before the first point and after the last point.

Extend Extrapolated

Causes the curve to extrapolate before the first point and after the last point, based on the shape of the curve.

Reset Curve

Resets the curve to the initial shape.

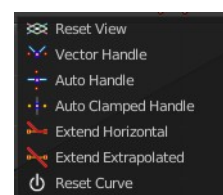

Use Clipping

Clipping options. Set up clipping for the stroke.

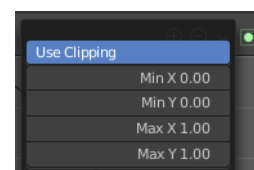

Delete Points

Deletes selected curve points.

Black Level

The color that Black is mapped to.

White Level

The color that White is mapped to.

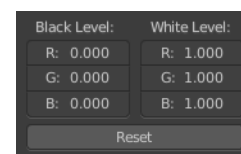

Hotkeys for Black and White Level

You may want to sample the black and white level colors directly in the image by clicking at an area. There are hotkeys for that.

Ctrl + Left Mouse click in the image sets the Black level value from that position.

Shift + Left Mouse click in the image sets the White Level value from that position.

To see the result you need to tick the View as Render button.

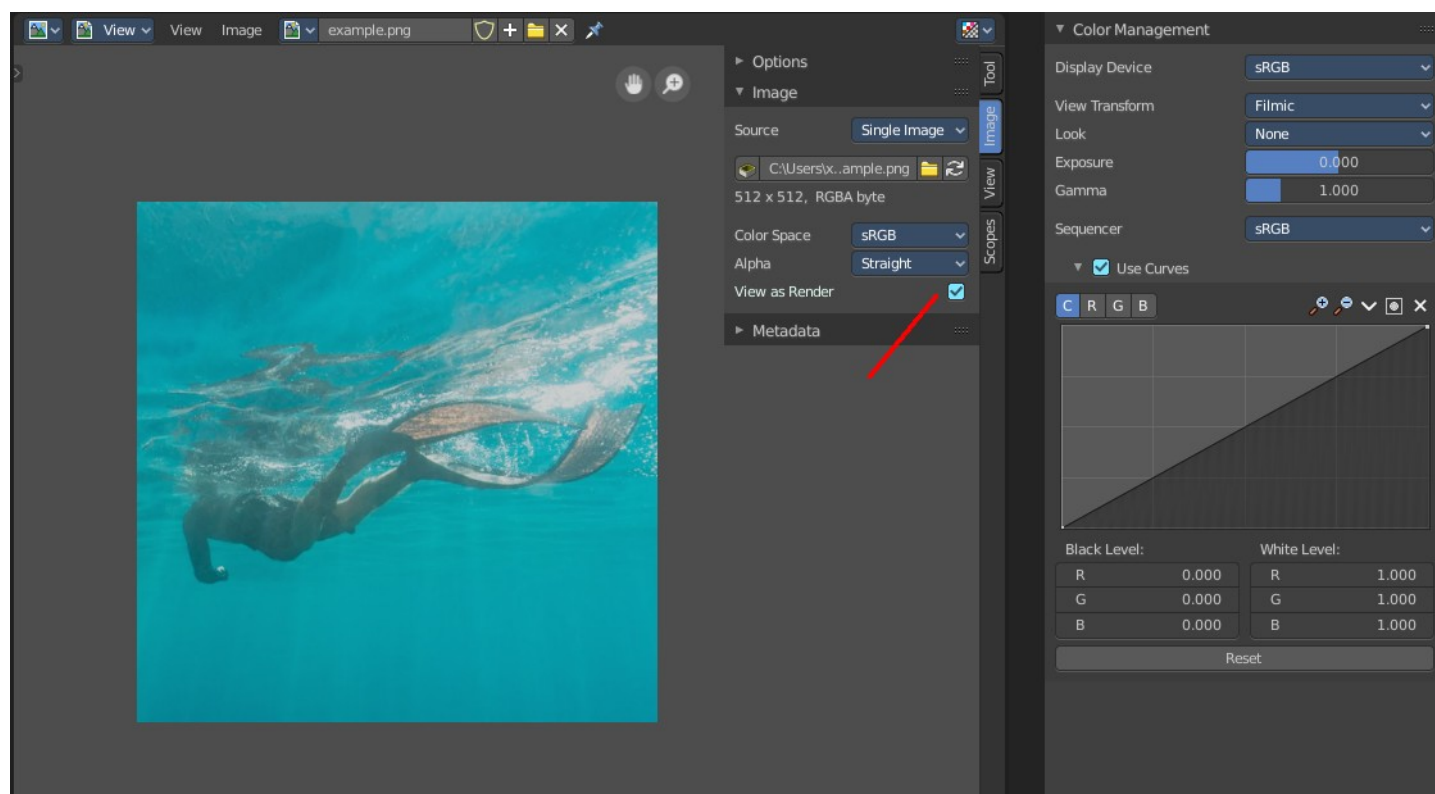

Reset

Resets the Curve and the Black and White Level values to the default values.

Cycles and Eevee - Freestyle panel

What is FreeStyle?

Freestyle is an edge- and line-based non-photorealistic (NPR) rendering engine that works on top of Cycles. It relies on mesh data and z-depth information to draw lines on selected edge types. Various line styles can be added to produce artistic or technical looks.

The two operating modes - *Python Scripting* and *Parameter Editor* - allow a diversity of line styles and results. Line styles such as Japanese big brush, cartoon, blueprint, thickness-with-depth are already pre-scripted in Python. The Parameter Editor mode allows intuitive editing of features such as dotted lines and easy setup of multiple line types and edge definitions.

There are more Freestyle settings in the View Layer tab wAdjust and define various parameters.

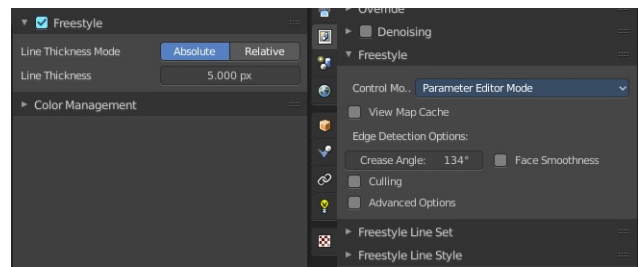
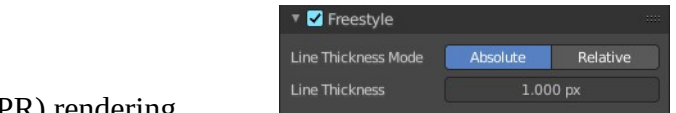
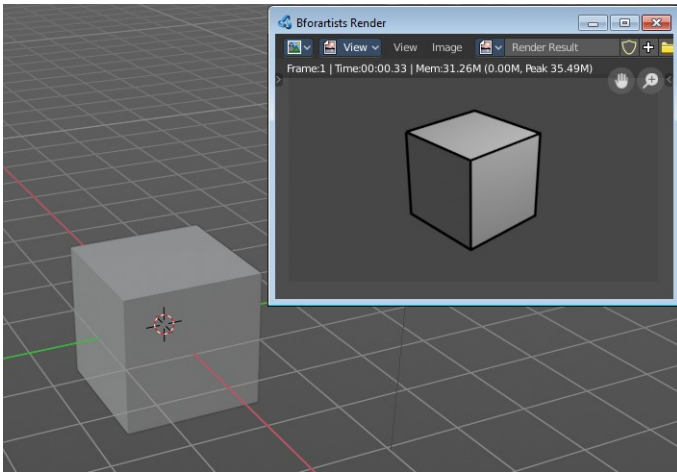

Enable

In the header is a checkbox where you can enable the Freestyle renderer.

Enabling the checkbox reveals the Freestyle Settings in the View Layer Properties.

Line Thickness Mode

Absolute

The line thickness is given by a user-specified number of pixels. The default value is **1.0**.

Relative

The unit line thickness is scaled by the proportion of the present vertical image resolution to **480** pixels. For instance, the unit line thickness is **1.0** with the image height set to **480**, **1.5** with **720**, and **2.0** with **960**.

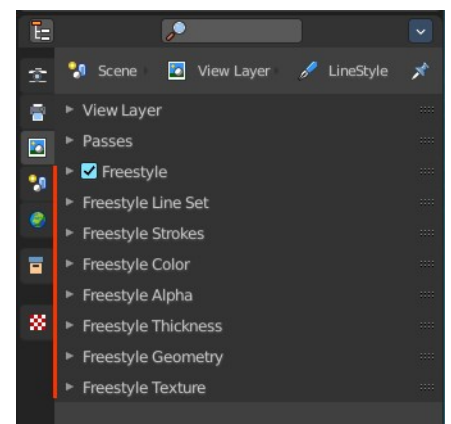

Line Thickness

Line Thickness is only available for *Absolute* line thickness. The base line thickness in pixels.

Cycles - Sampling panel

Adjust the samples for Cycles. And enable denoising.

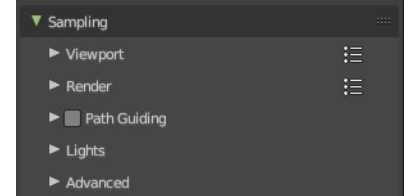

Viewport subpanel

Sampling settings for the Viewport rendering.

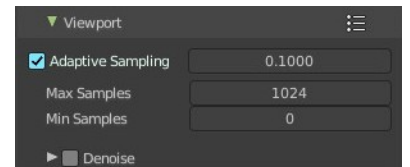

Presets

In the header you will find a Presets menu to choose between presets and define your own presets.

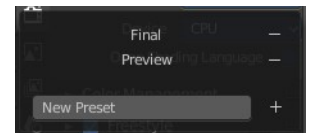

Adaptive Sampling

Automatically reduce the number of samples per pixel, based on estimated noise level.

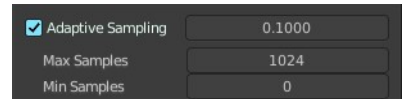

Adaptive sampling threshold

The noise level step to stop sampling at. Lower values reduce noise at the cost of render time. A value of zero means to use the automatic setting based on number of AA samples.

Max Samples

Maximum samples for adaptive sampling.

Min Samples

Minimum samples for adaptive sampling. A value of zero means to use the automatic setting based on number of AA samples.

Samples

When Noise Threshold is off then you will see the Samples edit box. Number of samples to render.



Denoise Sub Subpanel

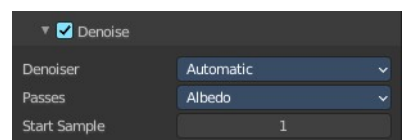

Use Denoising Checkbox

Activate Denoising.

Denoiser

Automatic

Use the fastest denoiser that is available. If OptiX is available then OptiX. Otherwise OpenImageDenoiser.

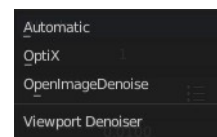

OptiX

Use the OptiX Denoiser.

OpenImageDenoiser

Use the OpenImageDenoiser.

Passes

What input passes to use.

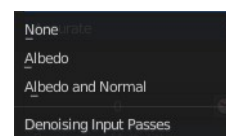

Start Sample

The sample to start denoising at.

Render subpanel

Sampling settings for the final rendering.

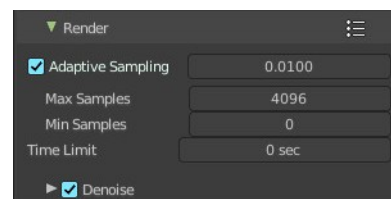

Presets

In the header you will find a Presets menu to choose between presets and define your own presets.

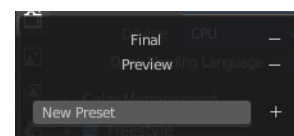

Adaptive Sampling

Automatically reduce the number of samples per pixel, based on estimated noise level.

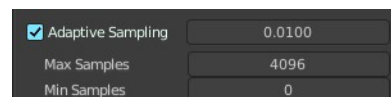

Adaptive sampling threshold

The noise level step to stop sampling at. Lower values reduces noise at the cost of render time. A value of zero means to use the automatic setting based on number of AA samples.

Max Samples

Maximum samples for adaptive sampling.

Min Samples

Minimum samples for adaptive sampling. A value of zero means to use the automatic setting based on number

of AA samples.

Samples

When Noise Threshold is off then you will see the Samples edit box. Number of samples to render.

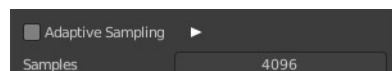

Time Limit

When Noise Threshold is off then you will see the Time Limit edit box. Limit the render time. This ends the rendering process after the given time. A value of zero disables the limit.

Denoise Sub Subpanel

Use Denoising Checkbox

Activate Denoising.

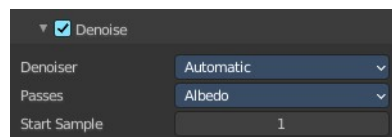

Denoiser

Automatic

Use the fastest denoiser that is available. If OptiX is available then OptiX. Otherwise OpenImageDenoiser.

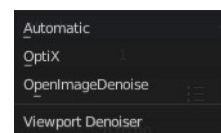

OptiX

Use the OptiX Denoiser.

OpenImageDenoiser

Use the OpenImageDenoiser.

Passes

What input passes to use.

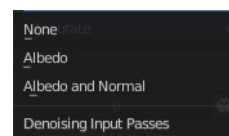

Start Sample

The sample to start denoising at.

Path Guiding subpanel

Use path guiding for sampling paths. Path guiding incrementally learns the light distribution of the scene. And guides path into directions with high direct and indirect light contributions.

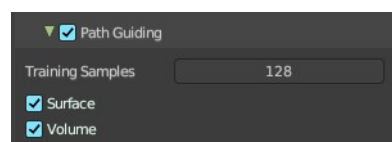

Training Samples

The maximum number of samples used for training path guiding. Higher values results in more accurate guiding at the cost of speed. A value of 0 will continue the training until the last sample.

Surface

Use guiding at surfaces.

Volume

Use guiding inside volumes.

Lights subpanel



Light Tree

When ticked use existing light tree. This will sample multiple lights more efficiently.

Light Threshold

When Light Tree is unticked Light Threshold becomes available. Terminate light samples below this value. This speeds up the rendering at the cost of noise. A value of zero will disable the test. Then all light value will be calculated.

Advanced subpanel

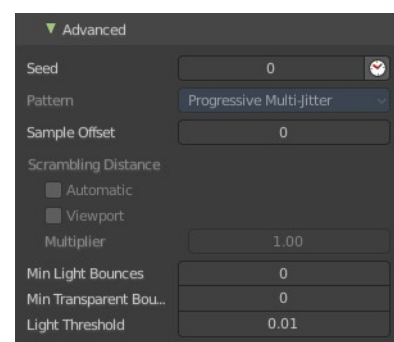

Seed

Seed value for integrator to get different noise patterns.

Animate Seed

The clock icon besides the Seed value. Enable it to get different seed values for animation. Without animated seed you will get visible patterns in animations.

Pattern

Random sampling pattern used by the integrator. You need to turn off Noise Threshold in the Render panel to activate and use the Sampling Pattern.



Sobol

Uses a Sobol pattern to decide the random sampling pattern used by the integrator.

Progressive Multi-Jitter

Uses a progressive Multi-Jitter pattern to decide the random sampling pattern used by the integrator.

Sample Offset

Number of samples to skip when starting the render.

Scrambling Distance

Speeds up the rendering times at the gpu at cost of possible artifacts. You need to turn off Adaptive Sampling in the Render or Viewport panel to activate and use the Scrambling Distance.

Adaptive

Instead of a fixed scrambling distance you can use this adaptive method. It is based on the sample count.

Viewport

Also use the scrambling distance in the viewport.

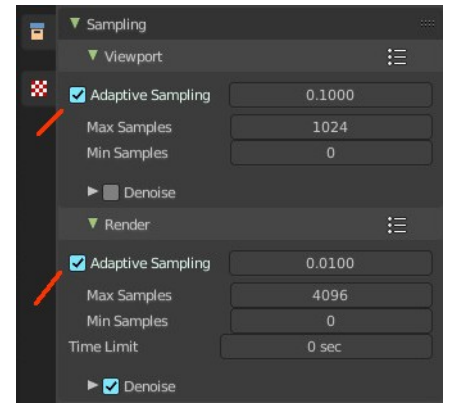

Min Light Bounces

The minimum bounces of light rays.

Min Transparent Bounces

The minimum number of transparent bounces.

Light Threshold

Terminates light samples when the light contribution is below this value. This gives more noise, but renders faster. Type in 0 to disable this feature.

Cycles - Light Paths panel

Here you will find all settings regarding light paths.

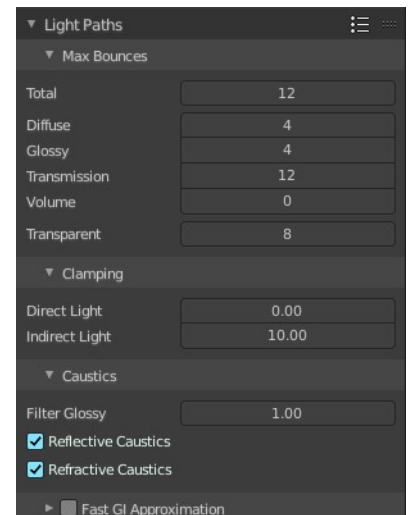

Presets

In the header you will find a Presets menu to choose between presets and define your

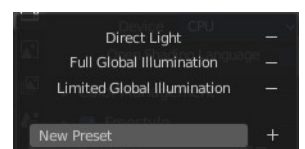

own presets.

Max Bounces

A sub menu with the Maximum Bounces settings.

Total

Total maximum number of bounces.

Diffuse

Maximum number of diffuse bounces.

Glossy

Maximum number of glossy bounces.

Transmission Bounces

Maximum number of transmission bounces.

Volume

Maximum number of volume scattering bounces.

Transparent

Maximum number of transparency bounces.

Clamping

A sub menu with the Clamping settings. Clamping will reduce noise at the cost of accuracy.



Direct Light

The maximum value for a direct sample. Zero means disabled.

Indirect Light

The maximum value for an indirect sample. Zero means disabled.

Caustics

A sub menu with caustics and filter glossy settings.

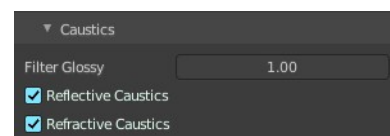

Filter Glossy

When using a value higher than 0.0, this will blur glossy reflections after blurry bounces, to reduce noise at the cost of accuracy. 1.0 is a good starting value to tweak.

Some light paths have a low probability of being found while contributing much light to the pixel. As a result these light paths will be found in some pixels and not in others, causing fireflies. An example of such a difficult path might be a small light that is causing a small specular highlight on a sharp glossy material, which we are seeing through a rough glossy material. In fact in such a case we practically have a caustic.

With path tracing it is difficult to find the specular highlight, but if we increase the roughness on the material, the highlight gets bigger and softer, and so easier to find. Often this blurring will hardly be noticeable, because we are seeing it through a blurry material anyway, but there are also cases where this will lead to a loss of detail in lighting.

Reflective Caustics

Disable reflective caustics. Path tracing supports rendering of caustics with a sufficient number of samples. But in practice it may be inefficient to the point that there is just too much noise.

Refractive Caustics

Disable refractive caustics. Path tracing supports rendering of caustics with a sufficient number of samples. But in practice it may be inefficient to the point that there is just too much noise.

Fast GI approximation subpanel

Approximate diffuse indirect light with background tinted ambient occlusion.

This method provides a fast alternative to full global illumination, for interactive viewport rendering or final renderers with lower quality.

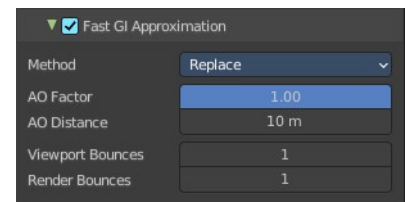

Fast GI Approximation checkbox

The checkbox in the header activates the Fast GI Approximation.

Method

The fast gi method.

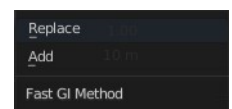

Replace

Replace global illumination with ambient occlusion after a specified number of bounces.

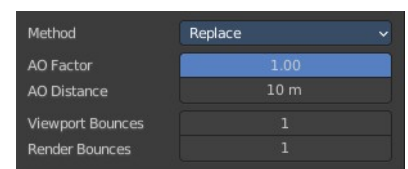

AO Factor

Factor of ambient occlusion blending.

AO Distance

The length of the rays that are used for Ambient Occlusion. Defines how far any other faces gives the occlusion effect.

Viewport Bounces

Use approximate global illumination after this number of light bounces in the viewport. A value of 0 deactivates the feature.

Render Bounces

Use approximate global illumination after this number of light bounces in the rendering. A value of 0 deactivates the feature.

Add

Add ambient occlusion to diffuse surfaces

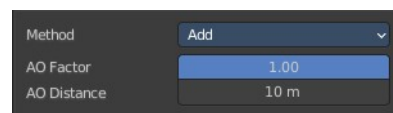

AO Factor

Factor of ambient occlusion blending.

AO Distance

The length of the rays that are used for Ambient Occlusion. Defines how far any other faces gives the occlusion effect.

Cycles - Volumes panel

Adjust the volume sampling.

Step Rate Render

Globally adjust detail for volume rendering for the final rendering. Lower values give more accurate and detailed results but also increased render time.

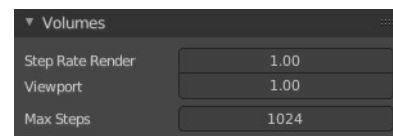

Step Rate Viewport

Globally adjust detail for volume rendering for the viewport rendering. Lower values give more accurate and detailed results but also increased render time.

Max Steps

Maximum number of steps through the volume before giving up, to protect from extremely long render times with big objects or small step sizes.

Cycles - Curves panel

Adjust the settings for Hair particles.

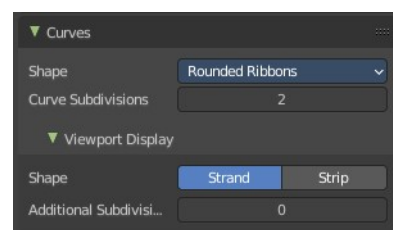

Shape

Choose between the shape 3D Curves and Rounded Ribbon.



Curve Subdivisions

Rounded Ribbons, the number of subdivisions at the curves.

Viewport Display subpanel

How to display the hairs in the viewport.

Shape

The hair shape type. Stand or Strip.

Additional Subdiv

Additional subdivision along the hair.

Cycles - Simplify panel

Sometimes you want to simplify the rendering without to loose the already tweaked settings and adjustments. For test renderings for example. Simplify allows you to set global limits on subdivision, shadow samples and more.

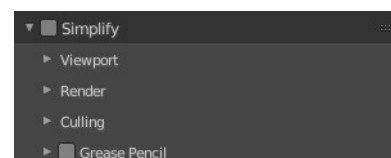

Enable

In the header is a checkbox to enable Simplify.

Viewport

This section affects the rendering with cycles in the Viewport.

Max Subdivisions

Limit the number of maximum subdivisions.

Child Particles

Limit the number of child particles.

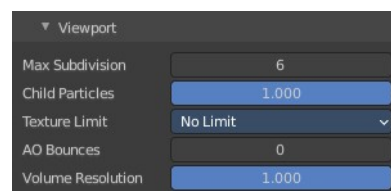

Texture Limit

Automatically scales down textures to the chosen value.

AO Bounces

Limit the number of Ambient Occlusion Bounces.

Volume Resolution

Simplify volumes by adjusting volume percentage of volume objects in viewport.

Render

This section affects the final rendering.

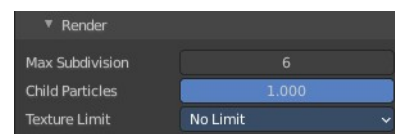

Max Subdivisions

Limit the number of maximum subdivisions.

Child Particles

Limit the number of child particles

Texture Limit

Automatically scales down textures to the chosen value.

Culling

Contains Culling settings. Culling means that the affected geometry is excluded from calculation.

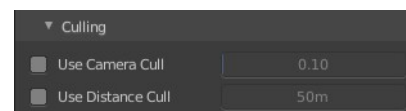

Use Camera Cull

Allow objects to be culled based on the Camera Frustum. Frustum is the region of the 3D space that gets displayed by the camera, the field of view.

Camera cull margin

The margin for the camera space culling.

Use Distance Cull

Allow objects to be culled based on the distance to the camera.

Distance

The distance after which the objects gets culled away.

Grease Pencil

Playback Only

Simplify the grease pencil strokes only during playback.

Fill

Display Fill strokes in viewport.

Modifiers

Display Modifiers.

Shader Effects

Display Shader effects.

Layers Tinting

Display layer tint.

Antialiasing

Use antialiasing to smooth stroke edges.

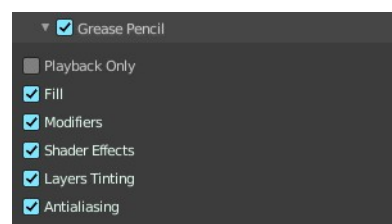

Cycles - Motion Blur panel

Enable Motion Blur and adjust the settings.

Each object has also its own settings to control motion blur. These options can be found in the corresponding Object tab of the Properties editor.

Enable

In the header is a checkbox to enable Simplify.

Position

Controls at what point the shutter opens in relation to the frame.

Shutter

Time between frames over which motion blur is computed. Shutter time 1.0 blurs over the length of 1 frame, 2.0 over the length of two frames, from the previous to the next.

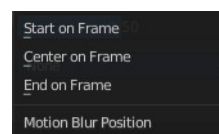
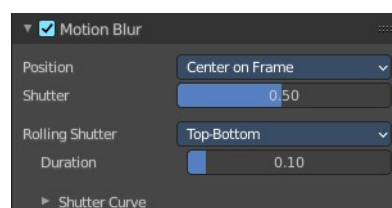

Rolling Shutter

Enable Rolling Shutter.

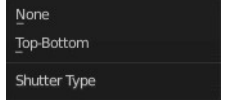

Duration

With method Top - Bottom only. Controls balance between pure rolling shutter effect and pure motion blur effect. With zero being no rolling shutter and one being all rolling shutter.

Shutter Curve

Sutter curve is a sub menu wAdjust a curve for the shutter effect.

Navigation elements

The navigation elements at the top are described from left to right.

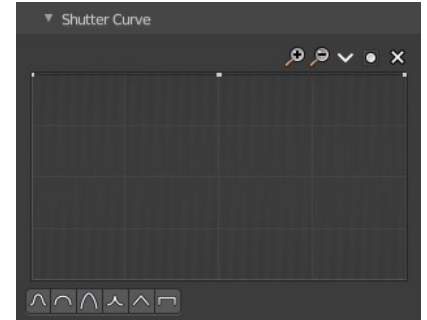

Zoom in and out

The two buttons with the magnifying glass at it zooms in and out in the curve window.

Tools

Tools is a menu that contains some curve related tools.



Reset View

Resets the curve windows zoom.

Vector Handle

Set handle type to Vector.

Auto Handle

Set handle type to Auto.

Auto Clamped Handle

Set handle type to Auto Clamped.

Extend Horizontal

Causes the curve to stay horizontal before the first point and after the last point.

Extend Extrapolated

Causes the curve to extrapolate before the first point and after the last point, based on the shape of the curve.

Reset Curve

Resets the curve to the initial shape.

Use Clipping

Clipping options. Set up clipping for the stroke.

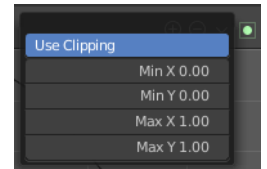

Delete Points

Deletes selected curve points.

X and Y values

The coordinates of the currently selected curve point.

Presets

At the bottom you can find some curve presets.



Cycles - Film panel

Exposure

Exposure can be used to change the brightness of an image. Different than the Exposure option found in the Color management panel this exposure option works is on the data while the Color management exposure is on the view.

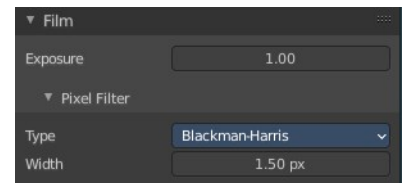

Pixel Filter

The Pixel Filter randomly changes the coordinates of every sample with the given distribution. For example: When the Sobol Sampling Pattern samples near the edge of the pixel, the neighboring pixel might be lit instead with a rather high probability. Pixel filter is used to get rid of aliasing on the sharp edge of very bright objects, like mesh lights.

Type

Choose the pixel filter type.

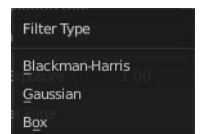

Width

Adjust the pixel filter width.

Cycles - Performance panel

Settings to influence the render performance.

Presets

Performance presets can be applied to quickly configure Cycles.

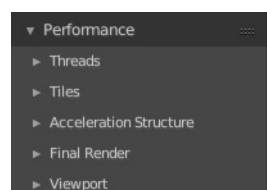

Default

This preset are the default cycles settings.

Faster Rendering

This preset is dedicated to speed with higher memory usage. This may be more unstable due to hardware limits.

Lower Memory

This preset is dedicated to lower memory. This may cause longer renders.

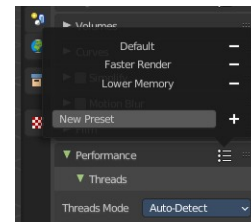

Threads

With threads, you are able to to assign as many cores as you need from your CPU as dedicated resources. Default is Auto-Detect.

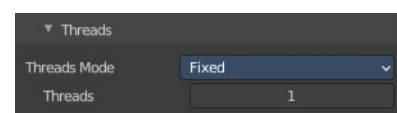

Mode

Auto-detect

Automatically chooses the amount threads to match the number of logical processors on your computer.

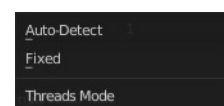

Fixed

Manually choose the amount threads to use for rendering.

Threads

Just active when you choose Fixed. Number of threads that you want to use.

Memory

Auto Tiles

Automatically render high resolution images in tiles to reduce memory usage. Tiles are cached to disk while rendering, to save memory.

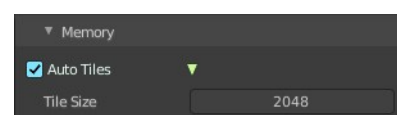

Tile Size

The tile size for the tiles.

Acceleration Structure

Use Spatial Splits

Spatial splits improve rendering performance in scenes with a mix of large and small polygons. The downsides are longer BVH build times and slightly increased memory usage.



With CPU rendering:

Use compact BVH

Use a compact BVH code structure that uses less ram. This option renders slower.

With GPU rendering:

BVH Time Steps

Is just active when Spatial Splits is off. Split BVH Primitives by this number of time steps. This speeds up rendering, but requires more memory.

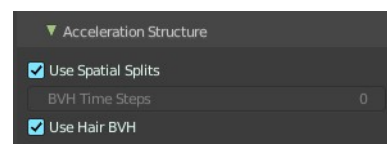

Use Hair BVH

Use a special type of BVH for rendering hair. The bounding boxes are not axis aligned allowing a spatially closer fit to the hair geometry. Disabling this option will reduce memory, at the cost of increasing hair render time.

Final Render



Persistent Data

Keep image data in memory after rendering, for faster re-renders at the cost of extra memory usage when performing other tasks in Blender.

Viewport

This settings is for rendering in the Viewport.

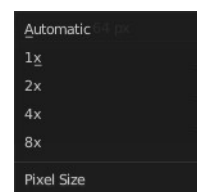
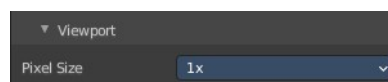

Pixel Size

Pixel Size for Viewport Rendering.

Cycles - Bake panel

Texture baking is the process to bake specific informations from one object into the texture or the vertex colors of another object. Ambient Occlusion. Or a Normal Map for example.

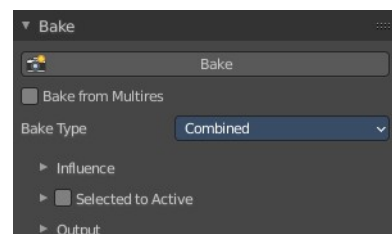

NOTE

Baking into textures requires to have a working UV mapping and a

texture at the target object!

How to use: Select the source object where you want to bake from, hold down Shift, select the target object where you want to bake to, so that both objects are selected. Adjust the settings to your needs. Then hit the Bake button.

NOTE

The Bake panel is visible in all Modes. But you have to bake in Object Mode.

Settings for all Texture types

Most settings in the Bake panel are available for all texture types.

Bake Button

Start the bake process.

Bake from Multires

Bake directly from multi resolution object.

Bake Type

Bake Mode is a drop-down box to choose what type of information you want to bake from the source object into the texture or the vertex colors of the target object.

You can bake Subsurface, Transmission, Glossy, Diffuse, Environment, Emit, UV, Normal, Shadow, Ambient Occlusion and Combined.

Combined

Bakes the full rendering, means materials, textures, lightning, into the texture of the target object. Except Specularity.

Ambient Occlusion

Bakes ambient occlusion as specified in the World panels. Ignores all lights in the scene.

Shadow

Bakes the Shadow into the texture of the target object.

Position

Bake out a position map. Position maps stores the distance from the floor. Which allows to add a dirtmap above some ground for example.

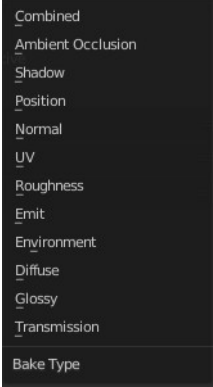

Combined
_Ambient Occlusion
_Shadow
_Position
_Normal
_UV
_Roughness
_Emit
_Environment
_Diffuse
_Glossy
_Transmission
Bake Type

Normal

Creates a Normal map by using the normals of the source object, and baking them as colors into the texture of the target object.

UV

Bakes colors of materials and textures only, without shading.

Roughness

Bakes the Roughness of a material into the texture of the target object.

Emit

Bakes the Emission or the glow color of a material into the texture of the target object.

Environment

Bakes the Environment texture into the texture of the target object. As seen from the center of the object.

Diffuse

Bake the diffuse texture of the source object into the texture of the target object.

Glossy

Bakes the Glossy Passes of a material into the texture of the target object.

Transmission

Bakes the transmission Passes of a material into the texture of the target object.

Influence Sub panel

Adjust what data contributes to the bake process. The items are self explaining.

The content changes, dependent of what type you want to bake.

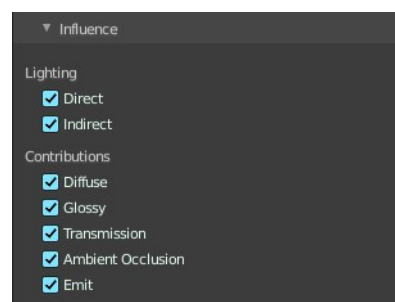

Glossy, Diffuse

Direct

Add direct Light.

Indirect

Add indirect Light.

Color

Add Color.

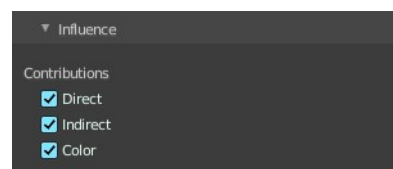

Normal

Space

A drop-down box to chooses the Normal Space to use.

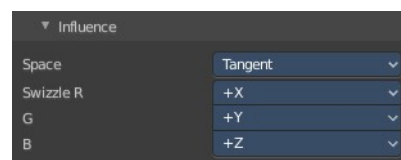

Swizzle

Axis to bake in red, green and blue channels.

Combined

Direct

Bake directly from Multires mesh.

Indirect

Normalizes without using material settings.

Diffuse

Bake with Diffuse.

Glossy

Bake with Glossy.

Transmission

Bake with Transmission.

Subsurface

Bake with Subsurface.

AO

Bake with Ambient Occlusion.

Emit

Bake with Emit.

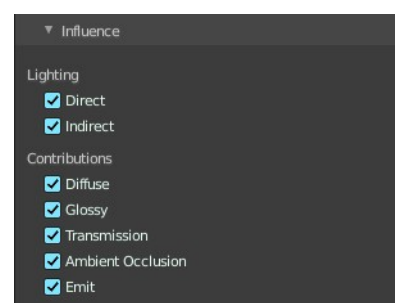

Selected to Active

The usual way to bake is first select the Source Object, where you want to bake from, hold down Shift, select the target object where you want to bake to, so that both objects are selected. Then hit the Bake button. That's Selected to Active.

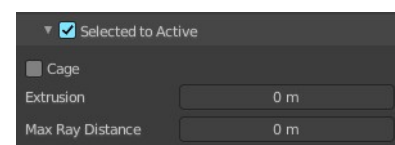

Extrusion

Inflate the active object by the specified distance for baking.

Cage

Cast Rays to active object from a cage. A value of zero means unlimited ray length.

Cage Object

Pick an object to use as a cage. Usually you create this cage object by duplicating the original object, and extrude out the faces along their normals until they fully include the original object.

Ray Distance

Distance to use for the inward ray cast when using Selected to Active.

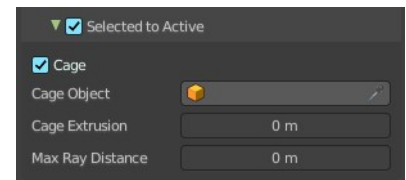

Output Sub panel

Target

To what target to bake. You can bake to images or you can bake to the vertex colors of the mesh. Note that baking to vertex colors has no further options.

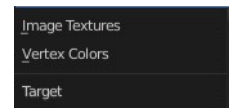
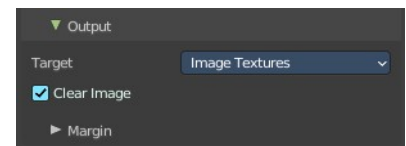

Clear Image

Clear clears the target image before baking.

Margin sub subpanel

Adjust the margin width.

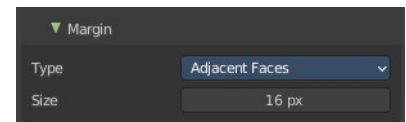

Type

The margin type.

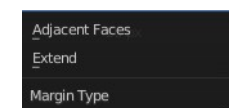

Adjacent Faces

Use pixels from adjacent faces across UV seams to create the margin.

Extend

Use the pixels at the inside of the border UV seams, and extend from there to create the margin.

Size

The size of the margin around the UV patches.

Workbench - Lighting panel

The Workbench renderer uses Open GL. OpenGL rendering is not influenced by the lights that you place in the workspace. But by a special OpenGL light setup. It can be tweaked in the Lighting panel and the User Preferences.

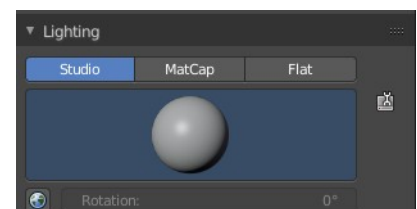

Flat

Use a flat lighting.

Studio

Use a Studio light setup.

Light library browser

Choose a predefined studio light setup.

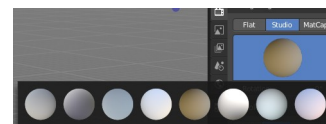

Rotation

Rotate the studio light setup.

User Preferences

A click at this button opens up the user preferences where you can add and manage the OpenGL Lights.

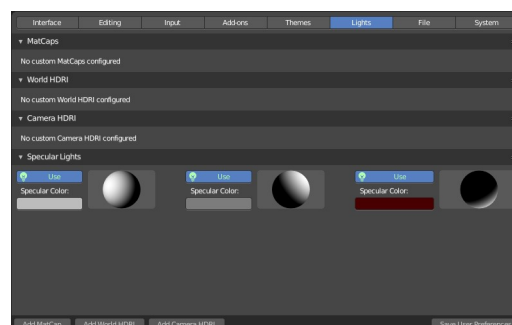

Matcap

Use Matcaps to render the scene.

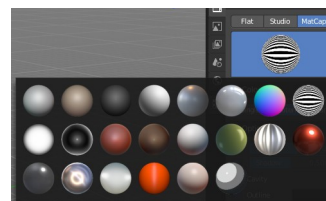

User Preferences

A click at this button opens up the user preferences where you can add and manage the Matcaps.

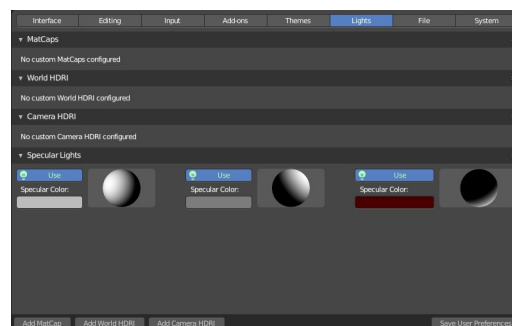

Flip Matcap

Flips the matcap.

Workbench - Color panel

Workbench renderer is meant for fast preview display. It does not use materials like Eevee or Cycles. You choose a color instead.

This panel allows you to define the color of the surface of the object. This settings are also dependent of the chosen lighting.

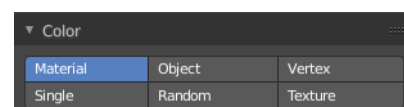

Material

Uses the material including textures for the mesh.

Object

Uses the Object color.

Vertex

Uses the Vertex color.

Single

Uses a single color for the selected mesh.

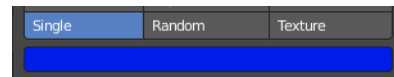

Random

Uses a random color for the mesh.

Texture

Renders the texture, and ignores the material settings.

Workbench - Options panel

X Ray

Render the faces transparent.

Backface Culling

Don't calculate back faces.

Show X-Ray

Set X-Ray active, and adjust the amount of alpha that is used for the x-ray effect.

Note that you can have either X-Ray or Shadow and Cavity active. Not both at the same time.

X-Ray Alpha

This slider shows up when you tick Show X Ray. Adjust the intensity.

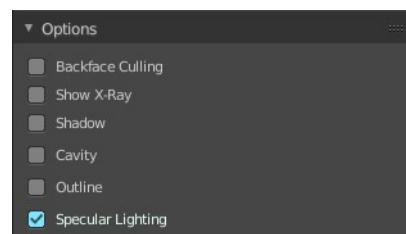

Shadow

Render Shadow.

Shadow Intensity

This slider shows up when you tick Shadow. Adjust the intensity.



Shading Shadow Options

Adjust a shadow shift relative to the light source.

Cavity

Show Cavity. Cavity highlights ridges and valleys in the scene geometry. Once activated Cavity shows some further settings.

World

Draw the cavity shading in world space.

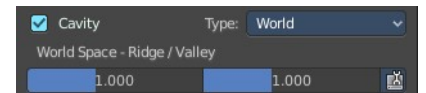

World Space / Ridge Valley

Factor for the cavity ridges and valleys.

Shading Options

Adjust samples, distance and attenuation for the cavity ridges and valleys.

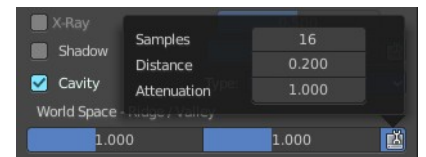

Screen

Draw the cavity shading in Screen space.

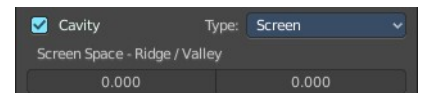

Screen Space / Ridge Valley

Factor for the curvature ridges and valleys.

Both

Draw the cavity shading in both, World Space and Screen space.

Settings see above.

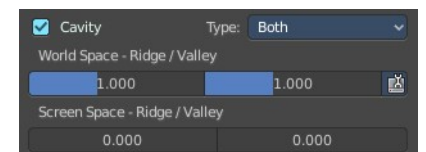

Outline

Show the not selected objects with an outline.

Outline Color

Define the color of the outline for not selected objects.

Specular Lighting

Render specular highlights.

Eevee - Sampling panel

Viewport Samples

The number of samples when rendering in the viewport.

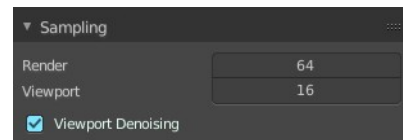

Render Samples

The number of samples when rendering to file.

Viewport Denoising

Denoise Image. The temporal re-projection can cause some ghosting.

Eevee - Ambient Occlusion panel

Ambient occlusion is a self shadowing effect.

Enable

In the header you will find a checkbox to enable the Ambient Occlusion.

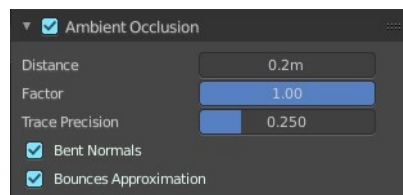

Distance

The distance of the object to contribute to the ambient occlusion.

Factor

The blend factor

Trace Precision

Precision of the horizon search

Bent Normals

Compute the main non occluded direction to sample the environment

Bounces Approximation

An approximation to simulate light bounces gives less occlusion on brighter objects.

Eevee - Bloom panel

Enable

In the header you will find a checkbox to enable the Bloom.

Threshold

Filters out pixel that are below this level of brightness.

Knee

Makes transition between under / over threshold gradual.

Radius

Bloom spread distance.

Color

The color of the bloom effect.

Intensity

Blend Factor.

Clamp

Maximum intensity a bloom pixel can have.

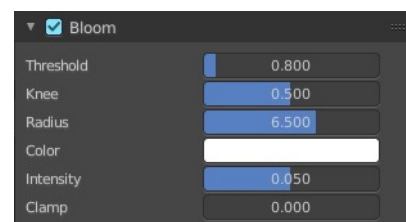

Eevee - Depth of Field panel

Max Size

The maximum size of the bokeh shape for Depth of Field. Lower is faster.

Sprite Threshold

Brightness threshold for using sprite base depth of field.

Neighbor Rejection

The maximum brightness to consider when rejecting bokeh sprites based on neighborhood. Lower is faster.

Denoise Amount

Amount of flicker remove applied to bokeh highlights.



High Quality Slight Defocus

Sample all pixels in almost in-focus regions to eliminate noise.

Jitter Camera

Jitter the camera to create accurate blurring by using render samples.

Overblur

Apply blur to each jittered sample to reduce undersampling artifacts.

Eevee - Subsurface Scattering panel

Subsurface scattering is a mechanism of light transport through the object. It penetrates the surface of a translucent object, is scattered by interacting with the material, and exits the surface at a different point.

Enable

In the header you will find a checkbox to enable the Subsurface Scattering.

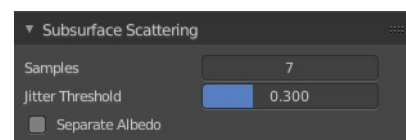

Samples

Number of samples to compute the scattering effect.

Jitter Threshold

Rotate samples that are below this value.

Separate Albedo

Avoid albedo being blurred by the subsurface scattering. This feature uses more memory.

Eevee - Screen Space reflections panel

Contains settings around the Screen Space reflections.

Screen Space Reflections is a common technique in games. It reuses the information that is already on screen for reflections. It doesn't reflect geometry outside of the camera though.

Enable

In the header you will find a checkbox to enable the Subsurface Scattering.

Refraction

Enable Screen Space refraction.



Half Res Trace

Ray trace at a lower resolution.

Trace Precision

The precision of the screen space ray-tracing.

Max Roughness

Do not ray-trace reflections that are above this value.

Thickness

Pixel thickness used to detect intersections.

Edge Fading

Screen percentage used to fade the Screen Space Reflection.

Clamp

Clamp Pixel intensity to remove noise.

Eevee - Motion Blur panel

Contains settings for motion blur.

Enable

In the header you will find a checkbox to enable the Subsurface Scattering.

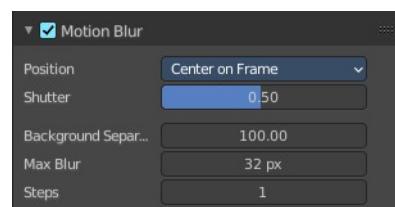

Position

Offset for the shutters time interval. This allows to change the motion blur trails.

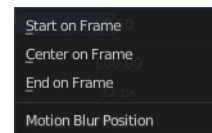

Shutter

Time taken in frames between shutter open and close.

Background Separation

Separate background elements from foreground elements. Lower values will reduce background bleeding onto foreground elements

Max Blur

The maximum blur distance a pixel can spread over.

Steps

The accuracy of motion blur. Higher values results in higher accuracy and higher render times.

Eevee - Volumetric panel

Contains volumetrics settings.

Start

The start distance for volumetrics.

End

The end distance for volumetrics.

Tile Size

The quality of the volumetrics effect. The lower the size the higher the quality and ram usage.

Samples

Number of samples to compute for the volumetrics effect.

Distribution

Distribute more samples closer to the camera.

Viewport Volumetric Blending

Enable volumetrics blending with previous frame in viewport. Attention, this setting is just for the viewport. The final rendering is not affected.

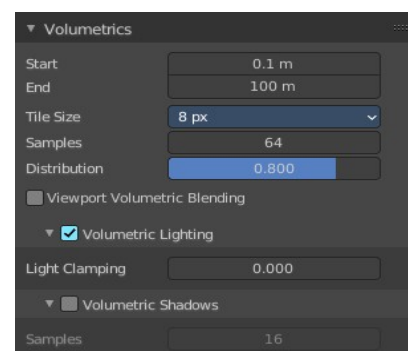

Volumetric Lighting

Enable

In the header you will find a checkbox to enable Volumetric Lighting.

Light Clamping

The maximum light contribution.

Volumetric Shadows

Enable

In the header you will find a checkbox to enable Volumetric Shadows.

Samples

Number of samples to compute volumetric shadowing.

Eevee - Curves panel

Shape

Choose if the hair is displayed as strand or as strip.

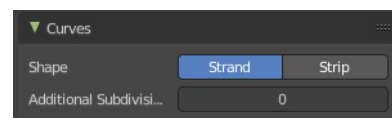

Additional Subdiv

Additional subdivision along the hair.

Eevee - Shadows panel

Contains settings regarding shadows.

Method

Choose between ESM and VSM method for the shadow. ESM stands for exponential shadow mapping. VSM stands for Variance shadow mapping.



Cube Size

The cube shadows resolution.

Cascade Size

Directional shadows resolution.

High Bit depth

Use 32 bit shadows. Low bit depth uses 8 bit.

Soft Shadows

Create soft shadows.

Eevee - Indirect Lighting panel

Indirect lighting can be baked to speed up the rendering process.

Eevee uses irradiance probes to calculate indirect lighting.

Bake Indirect Lighting

Bake both, the irradiance grids and reflection cube maps.

Bake Cubemap Only

Bakes only the reflection cube maps.

Delete Lighting Cache

Delete baked informations from cache.

Auto Bake

Auto bake indirect lighting when editing probes.

Diffuse Bounces

Number of times the light is reinjected inside light grids. 0 will disable indirect diffuse light.

Cubemap Size

The size of the cube maps.

Diffuse Occlusion

The size of the shadow map applied to each irradiance sample.

Irradiance Smoothing

Smooth the irradiance lightning. But this might introduce light bleeding.

Clamp Glossy

Clamp Pixel intensity to reduce noise inside glossy reflections from reflection cube maps. A value of 0 disables the clamping.

Filter Quality

Take more samples during cubemap filtering to remove artifacts.

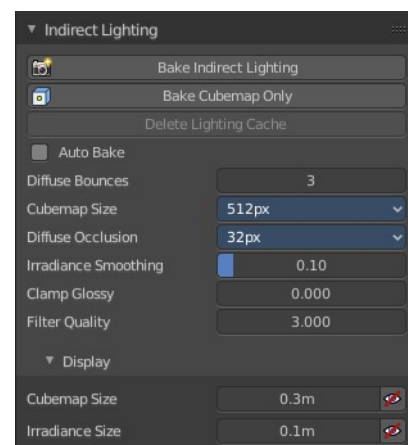

Display

Cubemap Size

Size of cubemap spheres to debug captured light.

Irradiance Size

Size of the irradiance sample spheres to debug captured light.

Eevee - Film panel

Filter Size

The width over which the reconstruction filter combines samples.

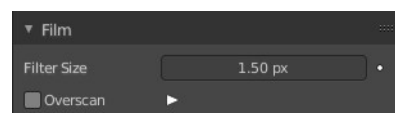

Animate Property

This property can be animated. Activating this button sets a keyframe.

Overscan

Internally render past the image borders to avoid screen space effects disappearing.



Overscan Size

How much bigger the image should be internally rendered.

Eevee + Workbench - Simplify panel

Sometimes you want to simplify the rendering without to loose the already tweaked settings and adjustments. For test renderings for example. Simplify allows you to simplify the rendering.

Enable

In the header is a checkbox to enable Simplify.

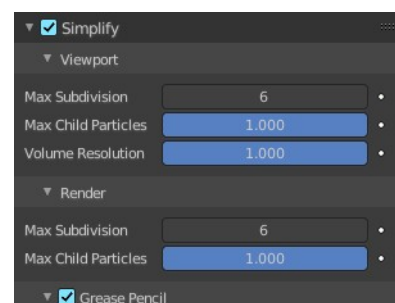

Viewport

This section affects the rendering with Eevee in the Viewport.

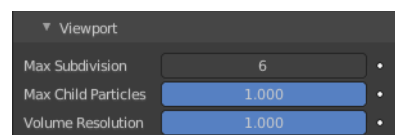

Max Subdivisions

Limit the number of maximum subdivisions.

Child Particles

Limit the number of child particles.

Volume Resolution

Simplify volumes by setting the resolution percentage of volume objects in viewport

Animate Property

This properties can be animated. Activating this button sets a keyframe.

Render

This section affects the rendering with Eevee to file.

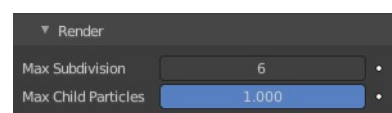

Max Subdivisions

Limit the number of maximum subdivisions.

Child Particles

Limit the number of child particles.

Animate Property

This properties can be animated. Activating this button sets a keyframe.

Grease Pencil

This section affects Grease Pencil drawings.

Playback Only

Simplify Grease Pencil only during animation playback.

Fill

Display Fill strokes in the Viewport.

Modifiers

Apply modifiers in the viewport.

Shader Effects

display shader effects.

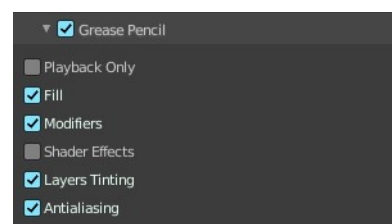

Layers Tinting

Display layers tint.

Antialiasing

Use antialiasing to smooth stroke edges.



26.3 Editors - Properties Editor - Output Properties Tab

Table of content

Detailed table of content.....	1
Output Properties Tab.....	4
Dimensions Panel.....	5
Presets.....	5
Resolution X / Y.....	5
Aspect X / Y.....	5
Render Region.....	5
Frame Start / End.....	6
Frame Step.....	6
Frame Rate.....	6
Time Remapping.....	6
Stereoscopy Panel.....	6
Workflow.....	7
Stereo 3D / Multiview.....	8
List of Cameras.....	8
Add / Remove / Rename.....	9
Suffix.....	9
Output Views Subpanel.....	9
Output Panel.....	11
File Path.....	11
Load File.....	11
File Format.....	12
Transparent.....	15
Options subpanel.....	15
Color management subpanel.....	15
Transparent subpanel.....	19
Metadata Panel.....	19
Metadata Input.....	19
Include.....	19
Note.....	19
Burn into Image.....	19
Post Processing Panel.....	20
Pipeline.....	20
Dither.....	20

Detailed table of content

Detailed table of content

Detailed table of content.....	1
Output Properties Tab.....	4
Dimensions Panel.....	5
Presets.....	5
Resolution X / Y.....	5
Aspect X / Y.....	5

Render Region.....	5
Crop to Render Region.....	6
Frame Start / End.....	6
Frame Step.....	6
Frame Rate.....	6
FPS.....	6
Base.....	6
Time Remapping.....	6
Old.....	6
New.....	6
Stereoscopy Panel.....	6
Workflow.....	7
Stereo 3D / Multiview.....	8
List of Cameras.....	8
Resize handler.....	8
Search field.....	8
Add / Remove / Rename.....	9
Suffix.....	9
Output Views Subpanel.....	9
Individual.....	9
Stereo 3D.....	9
Stereo Mode.....	9
Stereo Mode Type Anaglyph.....	9
Anaglyph Type.....	10
Stereo Mode Type Interlace.....	10
Interlace Type.....	10
Swap Left/Right.....	10
Stereo Mode Type Side by Side.....	10
Cross Eyed.....	10
Squeezed Frame.....	10
Stereo Mode Type Top Bottom.....	11
Squeezed Frame.....	11
Output Panel.....	11
File Path.....	11
Load File.....	11
File Format.....	12
Image file formats.....	12
BMP.....	12
Color.....	12
Iris.....	12
Color.....	12
PNG.....	12
Color.....	12
Color Depth.....	12
Compression.....	12
JPEG.....	12
Color.....	12
Quality.....	12
JPEG 2000.....	12
Color.....	12
Color Depth.....	12
Quality.....	12
Codec.....	13

Cinema.....	13
Cinema (48).....	13
YCC.....	13
Targa.....	13
Color.....	13
Targa Raw.....	13
Cineon.....	13
Color.....	13
DPX.....	13
Color.....	13
Color Depth.....	13
Log.....	13
Open EXR Multilayer.....	13
Color.....	13
Color Depth.....	13
Codec.....	13
Preview.....	14
Open EXR.....	14
Color.....	14
Color Depth.....	14
Codec.....	14
Z Buffer.....	14
Preview.....	14
Radiance HDR.....	14
Color.....	14
TIFF.....	14
Color.....	14
Color Depth.....	14
Compression.....	14
Movie file formats.....	14
AVI Jpeg.....	14
Color.....	14
Quality.....	14
AVI Raw.....	15
Color.....	15
FFmpeg video.....	15
Color.....	15
Transparent.....	15
Options subpanel.....	15
Saving.....	15
File Extensions.....	15
Cache Result.....	15
Image Sequence.....	15
Overwrite.....	15
Placeholders.....	15
Color management subpanel.....	15
Color management settings.....	15
Follow scene.....	15
Override.....	16
Display Device.....	16
View Transform.....	16
Standard.....	16
Filmic.....	16

Filmic Log.....	16
Raw.....	16
False Color.....	16
Look.....	16
Exposure.....	16
Gamma.....	17
Use Curves.....	17
Navigation elements.....	17
Zoom in and out.....	17
Tools.....	17
Reset View.....	17
Vector Handle.....	17
Auto Handle.....	17
Auto Clamped Handle.....	17
Extend Horizontal.....	17
Extend Extrapolated.....	17
Reset Curve.....	17
Use Clipping.....	17
Delete Points.....	18
Black Level.....	18
White Level.....	18
Hotkeys for Black and White Level.....	18
Reset.....	18
Transparent subpanel.....	19
Transparent Glass.....	19
Roughness Threshold.....	19
Metadata Panel.....	19
Metadata Input.....	19
Include.....	19
Note.....	19
Burn into Image.....	19
Font Size.....	20
Text Color.....	20
Background.....	20
Include Labels.....	20
Post Processing Panel.....	20
Pipeline.....	20
Compositing.....	20
Sequencer.....	20
Dither.....	20

Output Properties Tab

The Output properties contains all the settings to render the final image or movie. Most of the settings are the same for all three available render engines.

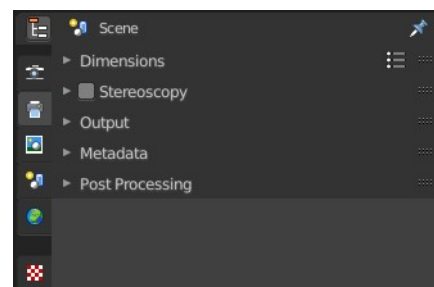

Dimensions Panel

This panel contains the dimension settings.

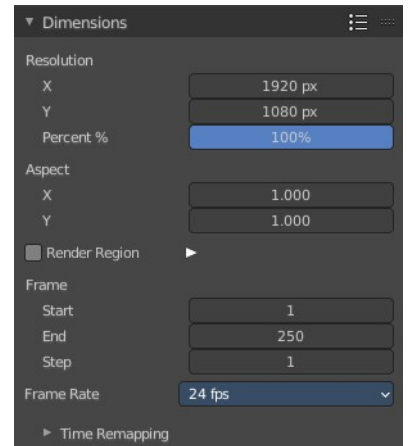

Presets

A list of dimension presets with the most common settings.

To add a new preset type in a new preset name into the edit box at the end of the list, and click at the + sign.

To remove a preset click at the - sign behind the name.

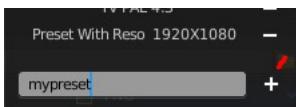

Resolution X / Y

The dimensions of the image in pixels.

%

Render the image in per cent of the original image. You can for example render in 200% of the resolution values. Or in 50%.

Aspect X / Y

The image aspect ratio. For anamorphic or non square pixel output.

Render Region



Activate render region for the output image.

There is a render region feature in the 3D view and in the Image editor where you can render a portion of the screen for preview purposes. Normally the output will always render the full image then, regardless of the render region. When you activate Render Region then the output will also render the render region only, and not the full image.

Crop to Render Region

Crop the output image to the size of the render region.

Frame Start / End

The start and end frame for an animation.

Frame Step

Number of frames to skip forward while playing the animation. With a value of 2 every second frame gets skipped.

Frame Rate

The output frame rate. When you choose custom then two more properties appears.

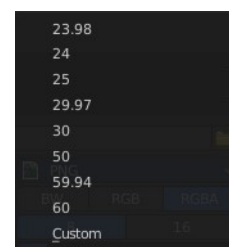

FPS

The custom frame per seconds value.

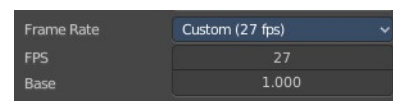

Base

Frame rate base. A multiplier that makes it for example possible to set up 29,97 Frames instead of 30 for NTSC.

Time Remapping

Remap the length of an animation.

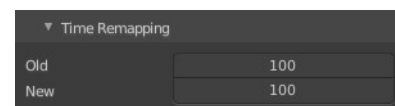

Old

The old length.

New

The new length.

Stereoscopy Panel

Allows you to render out stereoscopic images from the active camera. For the anaglyph images you need special stereoscopy glasses to see the 3D effect. And in case of the interlace method a 3d ready monitor and shutter glasses.

The anaglyph method is to create stereo images. The interlace method is mostly used in movies.

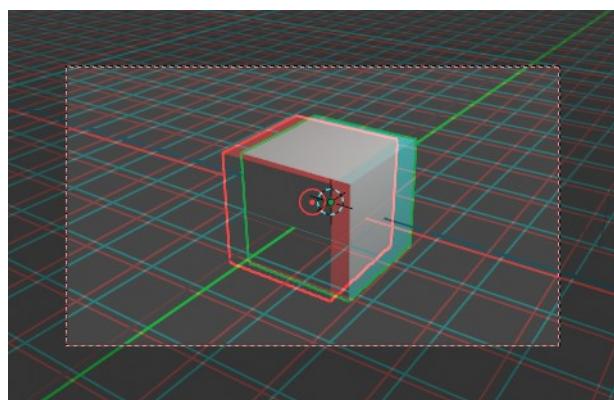

Workflow

Turn on Stereoscopy.

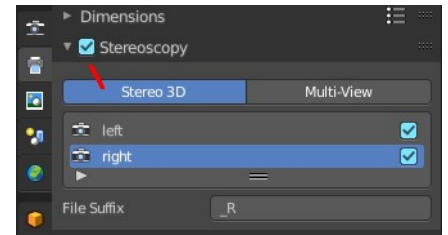

Select the Camera in the Outliner. In the Properties Editor choose the Object Data Properties tab (which should show a camera icon at this point), and open the Stereoscopy panel.

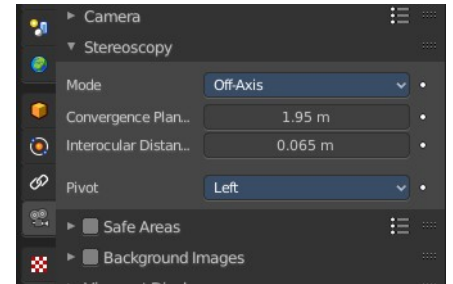

Change the Convergence Plane Distance to your needs. This can also be done in the 3D view with the handlers when you are in Camera view.

Interocular distance is the distance between the left and the right camera.

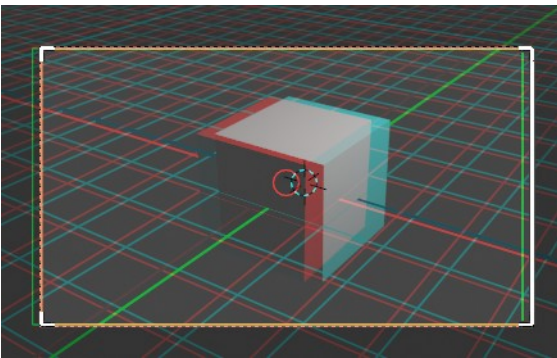

Outside of the camera view you will see this plane in front of the camera.

Adjust the plane to your needs. The plane is the reference point. Everything behind appears behind the focus. Everything before the plane appears before the focus.

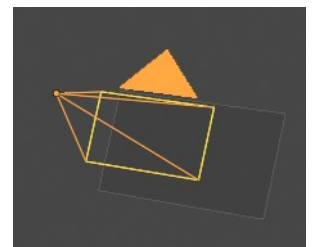

In the sidebar in the 3D view you will find further settings.

Turn on volume to see if the objects are inside of the volume.

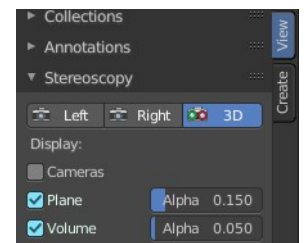

Do a preview rendering, and adjust the settings if required.

Go back to the Output tab to the Output panel. By activating stereoscopy here is a new section called Views. Here you can find further export settings.

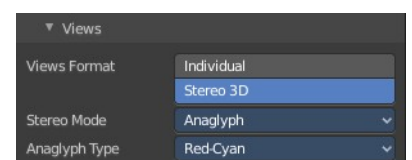

Stereo 3D / Multiview

The stereoscopy method. Stereo 3D uses two predefined virtual cameras. The camera settings gets inherited from the main camera.

Multiview allows you to set up several cameras manually. You need to create every camera by hand. And you need to follow name conventions to get this to work. In the outliner give the cameras the suffix that you want to use in the list. Here three cameras with a suffix.

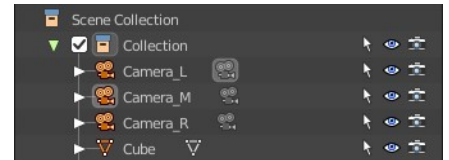

Now do the same in the list of cameras. Give every camera the same suffix than in the outliner. The camera name is not important. Important is the suffix. This is the identifier.

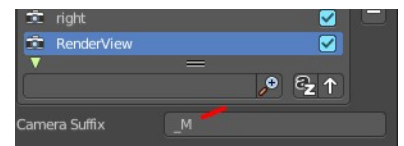

And in the render window you have now the render result of your three cameras.

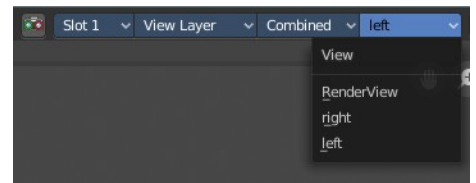

Note that for stereoscopy just two cameras gets used for rendering the anaglyph or interlaced result. Usually the ones with suffix _L and _R. So our third camera does not influence the stereoscopic image here.

List of Cameras

The list of cameras. Note that with method Stereo 3D these cameras does not exist in the outliner. They are virtually created as child objects to the main camera that you use for rendering.

In this list you can choose the cameras to change the suffix.

The checkbox allows you to disable the cameras. Both options are just of interest for the multi-view setup. Normal stereoscopy setup does not require any further setup.

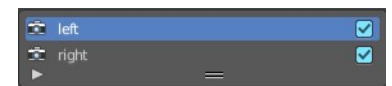

Resize handler

The resize handler allows you to resize the list.



Search field

The triangle button down left allows you to open a search field.

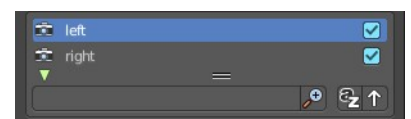

Add / Remove / Rename

Add adds a custom camera. Remove removes a custom camera. And custom cameras can be renamed by clicking at the name.

The camera names left and right can't be renamed, and you can't remove them from the list. Individual cameras can be renamed and removed.

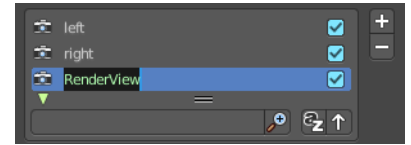

Suffix

The camera identifier. The suffix gets appended at the end of the single images of the camera. The left camera has the suffix `_L`, and the right camera has the suffix `_R`



Output Views Subpanel

This subpanel just shows with Stereoscopy enabled!

Adjust the stereoscopy export settings. Note that this settings does not adjust what you view in the image editor. This settings influences what you save from the image editor then.

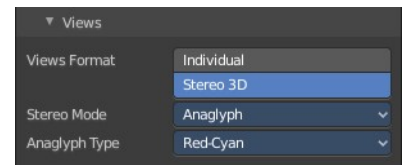

Individual

Save out single images from each camera when you save the result from the image editor. So for a stereoscopic image two images for the two cameras.

Stereo 3D

Save out the stereoscopic image as a single image when you save the result from the image editor.

Stereo Mode

How to export the stereoscopic image with save as in the image editor. There are four methods available.

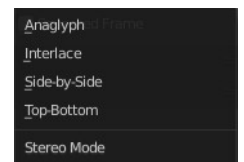

Stereo Mode Type Anaglyph

Render Views for left and right eyes as two differently filtered colors in a single image. You need anaglyph glasses to see the 3d effect.

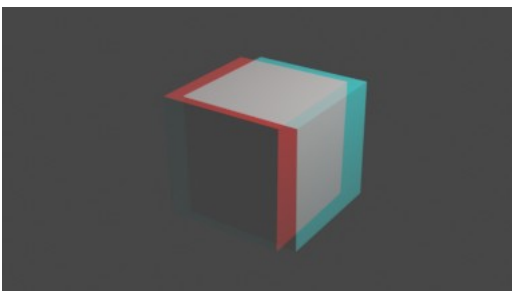

Anaglyph Type

The color model to display the graphics.

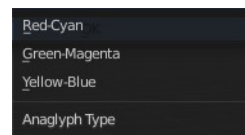

Stereo Mode Type Interlace

Render Views from left and right eyes interlaced into a single image. You need a 3D Ready monitor to see the stereo effect.

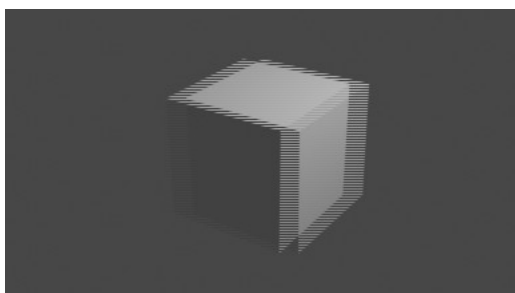

Interlace Type

The interlace type that you can choose.

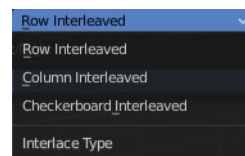

Swap Left/Right

Swaps left and right camera view.

Stereo Mode Type Side by Side

Renders images of the two cameras side by side.

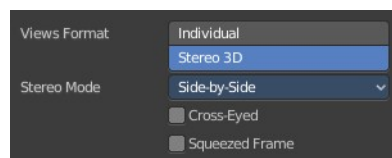

Cross Eyed

Swaps left and right camera view.

Squeezed Frame

Combine both views in a squeezed image.



Stereo Mode Type Top Bottom

Renders images of the two cameras side by side.

Squeezed Frame

Combine both views in a squeezed image.

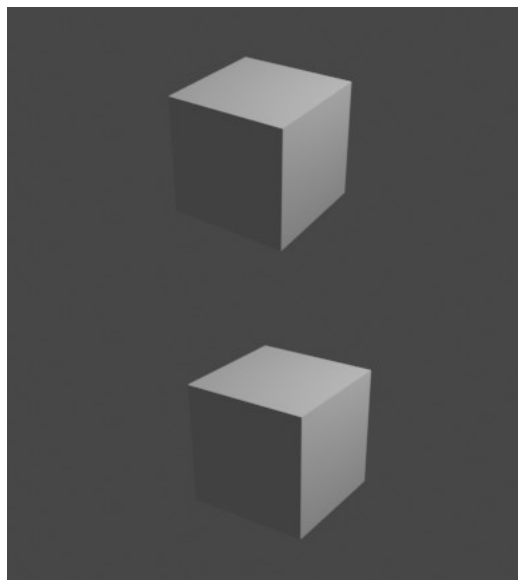
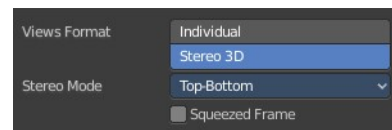

Output Panel

The file output settings.

File Path

The location to save rendered frames. Here you will find rendered animation sequences. For single images you can save out the result in the image editor.

When rendering an animation, the frame number is appended at the end of the file name with four padded zeros (e.g. `image0001.png`). You can set a custom padding size by adding the appropriate number of # anywhere in the file name (e.g. `image_##_test.png` translates to `image_01_test.png`).

This setting expands relative paths where a `//` prefix represents the directory of the current blend-file.

Load File

Here you can load an existing file to overwrite it. Or you can use it to load a file in a directory and rename it then to your destination file name.

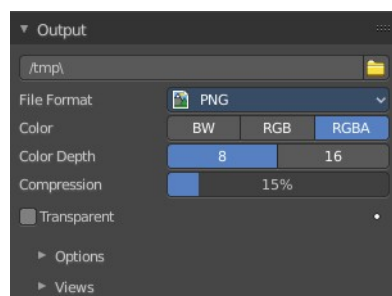

File Format

The output file format.

Each file format has some own settings.

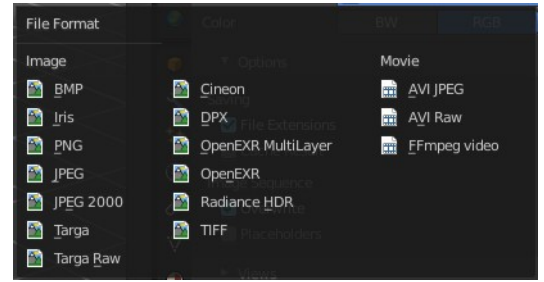
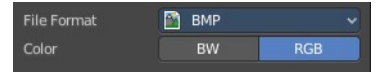

Image file formats

BMP

Color

The output color format. Black and white or rgb.



Iris

Color

The output color format. Black and white, rgb or rgba.

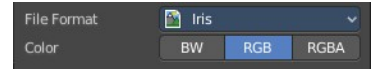

PNG

Color

The output color format. Black and white, rgb or rgba.

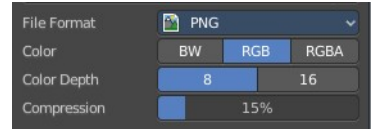

Color Depth

8 or 16 colors per channel.

Compression

The compression level.

JPEG

Color

The output color format. Black and white, or rgb.

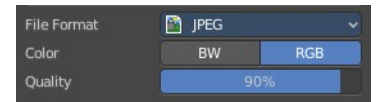

Quality

The jpeg quality.

JPEG 2000

Color

The output color format. Black and white, rgb or rgba.

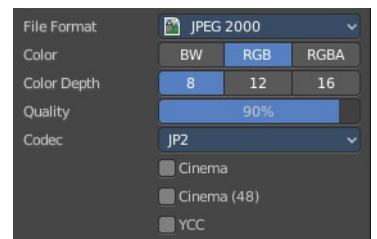

Color Depth

8, 12 or 16 colors per channel.

Quality

The jpeg quality.

Codec

Which jpeg 2000 codec to use.

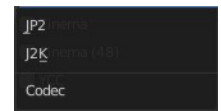

Cinema

Use OpenJpeg Cinema preset.

Cinema (48)

Use OpenJpeg Cinema (48) preset.

YCC

Save luminance / chrominance / chrominance channels instead of rgb channels.

Targa

Color

The output color format. Black and white, rgb or rgba.

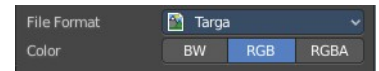

Targa Raw

Cineon

Color

The output color format. Black and white, or rgb.

Gamma of 1.7 and Non-Linear is hard coded.

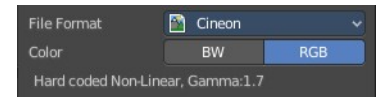

DPX

Color

The output color format. Black and white, rgb, or RGBA.

Color Depth

8, 10, 12 or 16 colors per channel.

Log

Convert to logarithmic color space.

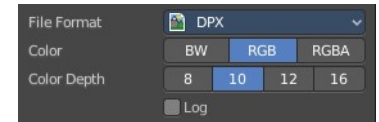

Open EXR Multilayer

Color

The output color format. Black and white, rgb, or RGBA.

Color Depth

Float half values or Float full values per channel.

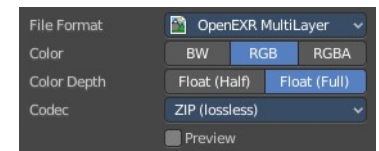

Codec

What codec to use.

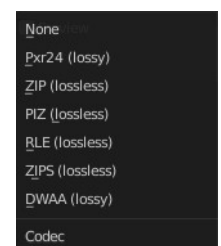

Preview

When rendering animations, save Jpeg preview images into the same directory.

Open EXR

Color

The output color format. Black and white, rgb, or RGBA.

Color Depth

Float half values or Float full values per channel.

Codec

What codec to use.

Z Buffer

Save the Z Depth per pixel. 32 Bit unsigned int Z Buffer.

Preview

When rendering animations, save Jpeg preview images into the same directory.

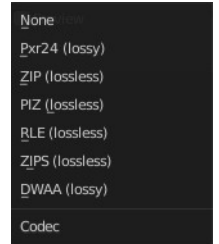

Radiance HDR

Color

The output color format. Black and white, or rgb.

TIFF

Color

The output color format. Black and white, rgb, or RGBA.

Color Depth

8 or 16 bit per channel.

Compression

The compression method.

Movie file formats

AVI Jpeg

Color

The output color format. Black and white, or rgb.

Quality

The jpeg quality.

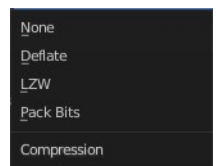
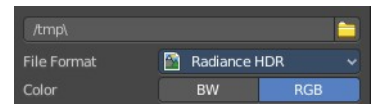

AVI Raw

Color

The output color format. Black and white, or rgb.



FFmpeg video

Color

The output color format. Black and white, or rgb.



Transparent

Eevee and Workbench renderer. Render and export the result with transparent background.



Options subpanel

Not all options are available for all file formats.

Saving

File Extensions

Adds the correct file extensions per file type to the output files.

Cache Result

Saves the rendered image and passes to a Multilayer EXR-file in temporary location on your hard drive. This allows the compositor to read these to improve performance, especially for heavy compositing.

Image Sequence

Overwrite

Overwrite existing files when rendering.

Placeholders

Create empty placeholder frames while rendering.

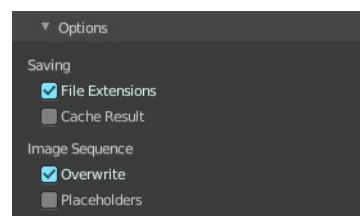

Color management subpanel

Color management settings

Follow scene

Uses the color management from the scene.

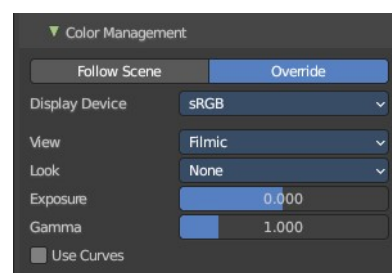

Override

Uses the color management settings that is defined below instead of the color management from the scene.

This settings is in most parts equal to the color management settings in the render properties. But has no settings for the Sequencer.

Display Device

The device that the image is being viewed on. Your monitor.

Most computer monitors are configured for the sRGB color space.

Color management can also be disabled by setting the device to None.



View Transform

Choose between different ways to view the image on the same monitor.

Standard

Does no extra conversion besides the conversion for the display device.

Filmic

For more photo realistic results and better handling of high dynamic range. The contrast can be adjusted by changing the *Look* option for the Filmic view transform.

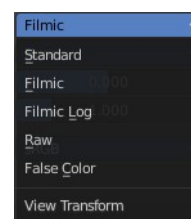

Filmic Log

Converts to Filmic log color space. This can be used for export to color grading applications, or to inspect the image by flattening out very dark and light areas.

Raw

Intended for inspecting the image but not for final export. Raw gives the image without any color space conversion.

False Color

Shows a heat map of image intensities, to visualize the dynamic range.

Look

Adjust the contrast.

Exposure

Used to control the image brightness (in stops) applied before color space conversion. The calculation is: $output_value = render_value \times 2^{(exposure)}$

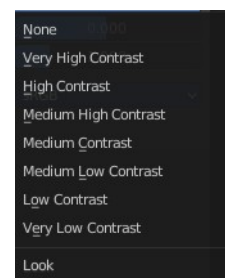

Gamma

Extra gamma correction applied after color space conversion. Note that the default sRGB or Rec709 color space conversions already include a gamma correction of approximately 2.2 (except the *Raw* and *Log* views), so this would be applied in addition to that.

Use Curves

Adjust RGB Curves to control image colors before color space conversion.

Navigation elements

The navigation elements at the top are described from left to right.

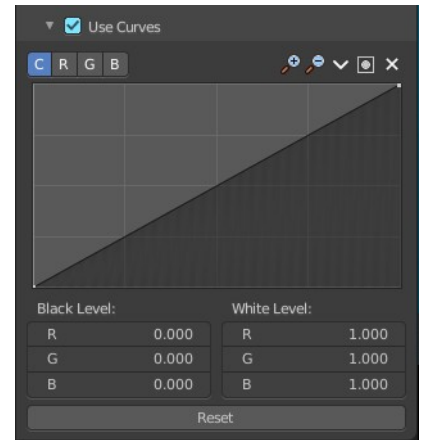

Zoom in and out

The two buttons with the magnifying glass at it zooms in and out in the curve window.

Tools

Tools is a menu that contains some cuve related tools.

Reset View

Resets the curve windows zoom.

Vector Handle

Set handle type to Vector.

Auto Handle

Set handle type to Auto.

Auto Clamped Handle

Set handle type to Auto Clamped.

Extend Horizontal

Causes the curve to stay horizontal before the first point and after the last point.

Extend Extrapolated

Causes the curve to extrapolate before the first point and after the last point, based on the shape of the curve.

Reset Curve

Resets the curve to the initial shape.



Use Clipping

Clipping options. Set up clipping for the stroke.

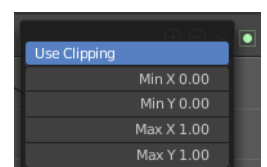

Delete Points

Deletes selected curve points.

Black Level

The color that Black is mapped to.

White Level

The color that White is mapped to.

Hotkeys for Black and White Level

You may want to sample the black and white level colors directly in the image by clicking at an area. There are hotkeys for that.

Ctrl + Left Mouse click in the image sets the Black level value from that position.

Shift + Left Mouse click in the image sets the White Level value from that position.

To see the result you need to tick the View as Render button.

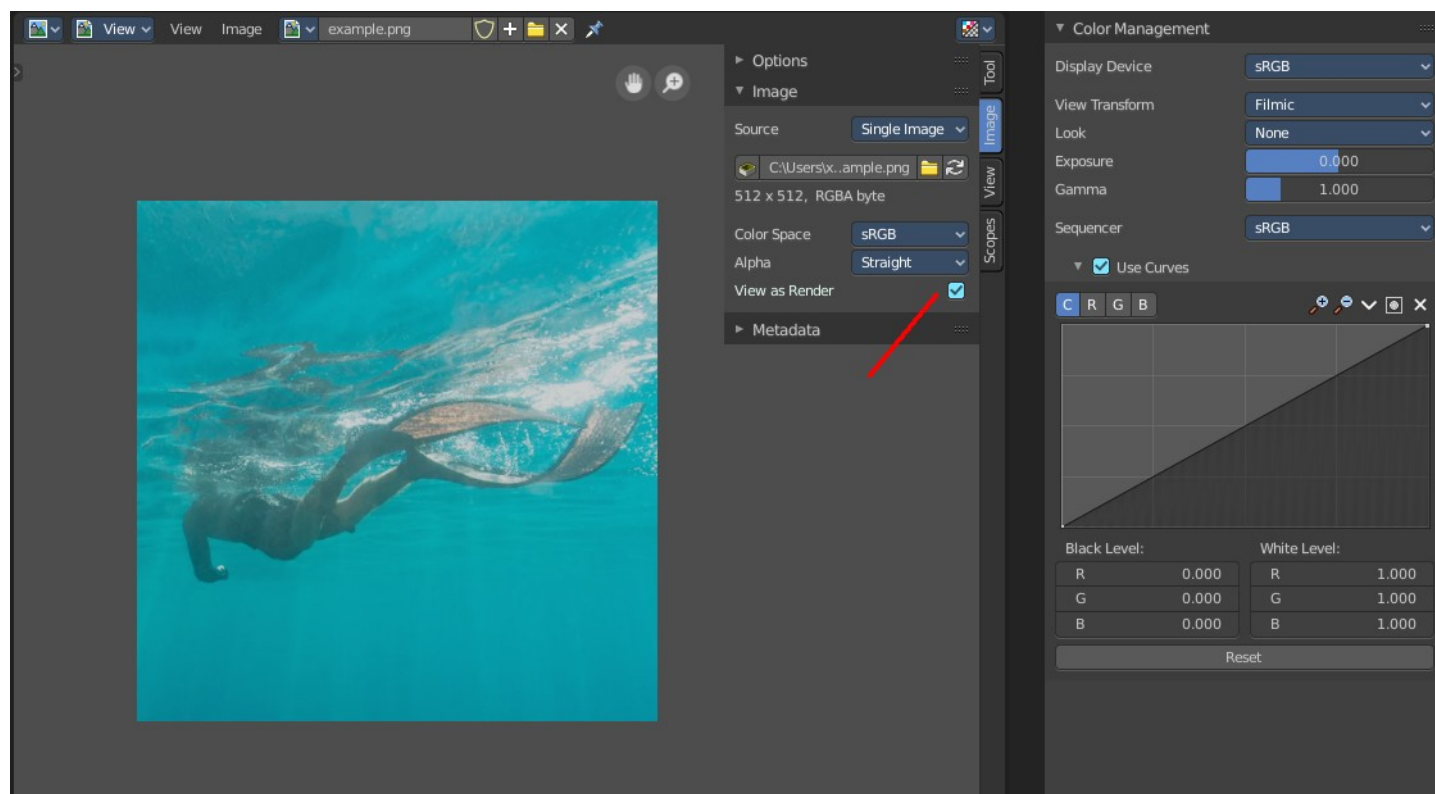

Reset

Resets the Curve and the Black and White Level values to the default values.

Transparent subpanel

Cycles only. Enable the rendering of transparent background.

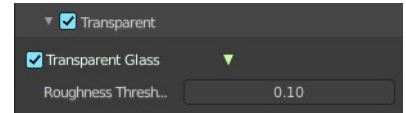

Transparent Glass

Render glass with transparent background.

Roughness Threshold

For transparent transmission. Keep surfaces with roughness above the threshold opaque.

Metadata Panel

What metadata to include into the image or movie.

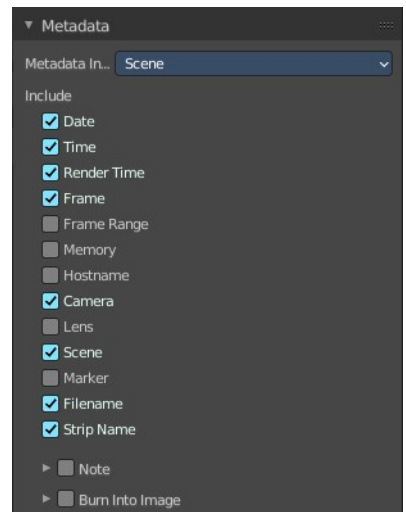

Metadata Input

Where to get the Metadata from.

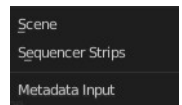

Include

What Metadata to include.

Note

Include a custom comment.

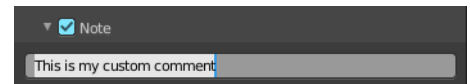

Burn into Image

Render the stamp info text into the image. The information is cluttered across the rendered image. Parts of it appears up left in the rendering. Parts down left, and parts down right.

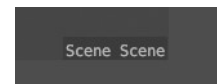
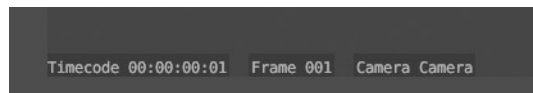
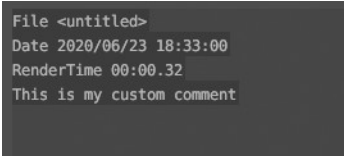
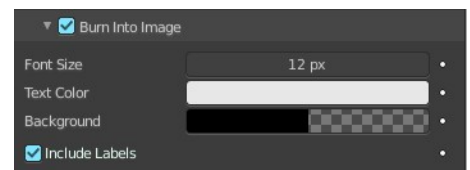

The props have decorators. This means this information can be keyframed. The font itself is the system font, and cannot be changed.

Font Size

The font size.

Text Color

The text color.

Background

The background color of the text.

Include Labels

Display stamp labels like "Camera" in front of camera name, etc.

Post Processing Panel

Enable Post Processing.

Pipeline

Compositing

Process the pipeline through the compositing in case compositing nodes are enabled.

Sequencer

Process the pipeline (and composited result) through the video sequence pipeline in case Sequencer strips exists.

Dither

Amount of dithering noise added to the rendered image to break up banding.

This prop has a decorator, and can be keyframe animated.

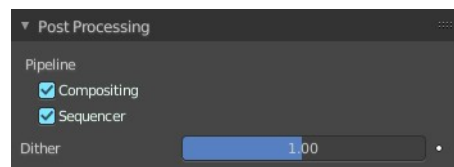



26.4 Editors - Properties Editor - View Layer Properties Tab

Table of content

Detailed table of content.....	1
View Layer.....	11
View Layer Panel - All Renderers.....	11
Eevee - Passes panel.....	12
Cycles - Passes Panel.....	15
Cycles - Filter Panel.....	20
Cycles - Override Panel.....	21
Freestyle Panel.....	22
Freestyle Line Set Panel.....	23
Freestyle Strokes Panel.....	27
Freestyle Modifiers.....	29
Freestyle Color panel.....	32
Freestyle Color modifiers.....	32
Freestyle Alpha panel.....	36
Freestyle Alpha modifiers.....	36
Freestyle Thickness panel.....	41
Freestyle Thickness modifiers.....	42
Freestyle Geometry.....	47
Freestyle Geometry Modifiers.....	47
Freestyle Texture.....	52
Custom Properties Panel.....	52

Detailed table of content

Detailed table of content

Detailed table of content.....	1
View Layer.....	11
View Layer Panel - All Renderers.....	11
View Layer Prop.....	11
View Layer list.....	11
View Layer edit box.....	11
Add View Layer.....	11
New.....	12
Copy Settings.....	12
Blank.....	12
Remove View Layer.....	12
Use for Rendering.....	12
Animate Property.....	12
Render Single Layer.....	12
Eevee - Passes panel.....	12
Data subpanel.....	12
Combined.....	12
Z.....	12
Mist.....	12

Normal.....	13
Mist subpanel.....	13
Start.....	13
Depth.....	13
Falloff.....	13
Light subpanel.....	13
Diffuse.....	13
Light.....	13
Color.....	13
Specular.....	13
Light.....	13
Color.....	13
Volume.....	13
Light.....	13
Scatter.....	14
Other.....	14
Emission.....	14
Environment.....	14
Shadow.....	14
Ambient Occlusion.....	14
Effects subpanel.....	14
Cryptomatte subpanel.....	14
Include.....	14
Object.....	14
Materials.....	14
Asset.....	14
Include Settings.....	14
Levels.....	15
Accurate Mode.....	15
Shader AOV subpanel.....	15
List of AOV.....	15
Name.....	15
Data Type.....	15
Add AOV.....	15
Remove AOV.....	15
Cycles - Passes Panel.....	15
Data subpanel.....	16
Include.....	16
Combined.....	16
Z.....	16
Mist.....	16
Normal.....	16
Vector.....	16
UV.....	16
Denoising Data.....	16
Indexes.....	16
Object Index.....	16
Material Index.....	16
Debug.....	16
Sample Count.....	16
Alpha Threshold.....	16
Mist subpanel.....	17
Start.....	17

Depth.....	17
Falloff.....	17
Light subpanel.....	17
Diffuse.....	17
Direct.....	17
Indirect.....	17
Color.....	17
Glossy.....	17
Direct.....	17
Indirect.....	17
Color.....	17
Transmission.....	18
Direct.....	18
Indirect.....	18
Color.....	18
Volume.....	18
Direct.....	18
Indirect.....	18
Color.....	18
Other.....	18
Emission.....	18
Environment.....	18
Shadow.....	18
Ambient Occlusion.....	18
Cryptomatte subpanel.....	19
Include.....	19
Object.....	19
Materials.....	19
Asset.....	19
Include Settings.....	19
Levels.....	19
Accurate Mode.....	19
Shader AOV subpanel.....	19
List of AOV.....	19
Name.....	19
Data Type.....	19
Add AOV.....	20
Remove AOV.....	20
Light Groups subpanel.....	20
Add Light Group.....	20
Remove Light Group.....	20
Lightgroup Sync menu.....	20
Add used Light groups.....	20
Remove unused light groups.....	20
Cycles - Filter Panel.....	20
Include.....	20
Environment.....	20
Ambient Occlusion.....	21
Surfaces.....	21
Curves.....	21
Volume.....	21
Use.....	21
Motion Blur.....	21

Denoising.....	21
Cycles - Override Panel.....	21
Material Override.....	22
Samples.....	22
Freestyle Panel.....	22
Enable.....	22
Control Mode.....	22
View Map Cache.....	22
As Render Pass.....	22
Edge detection subpanel.....	23
Crease Angle.....	23
Culling.....	23
Face Smoothness.....	23
Material Boundaries.....	23
Ridges and Valleys.....	23
Suggestive Contours.....	23
Sphere Radius.....	23
Kr Derivate Epsilon.....	23
Style Module subpanel.....	23
Freestyle Line Set Panel.....	23
List of Line Sets.....	24
Drag Handler.....	24
Search field.....	24
Edit Box.....	24
Invert.....	24
Sort by Name.....	24
Reverse.....	24
Add Line Set.....	24
Remove Line Set.....	24
Lineset Specials menu.....	24
Copy Line Set.....	24
Paste Line Set.....	24
Move Line Set up or down.....	24
Line style data property.....	25
Data Browser.....	25
Edit Box.....	25
Fake User.....	25
Add new LineStyle.....	25
Remove LineStyle.....	25
Select by Image Border.....	25
Visibility Subpanel.....	25
Type.....	25
Visible.....	25
Hidden.....	25
Quantitative invisibility.....	25
Start.....	26
End.....	26
Edge Type subpanel.....	26
Selection by Edge Types.....	26
Negation.....	26
Inclusive.....	26
Exclusive.....	26
Combination.....	26

Logical Or.....	26
Logical And.....	26
Type.....	26
Face Masks Subpanel.....	26
Selection by Face Marks.....	26
Negation.....	26
Condition.....	26
Collection Subpanel.....	27
Selection by Collection.....	27
Line Set Collection.....	27
Negation.....	27
Freestyle Strokes Panel.....	27
Caps.....	27
Chaining Subpanel.....	27
Chaining.....	27
Method.....	27
Plain.....	27
Sketchy.....	27
Rounds.....	28
Splitting subpanel.....	28
Min 2D Angle.....	28
Max 2D Angle.....	28
2D Length.....	28
Material Boundary.....	28
Split Pattern sub subpanel.....	28
Use Split Pattern.....	28
Dash 1, 2, 3.....	28
Gap 1, 2, 3.....	28
Sorting subpanel.....	28
Sort Key.....	28
Integration Type.....	29
Sort order.....	29
Selection Subpanel.....	29
Min 2D Length.....	29
Max 2D Length.....	29
Chain Count.....	29
Dashed Line subpanel.....	29
Dashed Line.....	29
Dash 1, 2, 3.....	29
Gap 1, 2, 3.....	29
Freestyle Modifiers.....	29
Header.....	30
Triangle button.....	30
Edit Box.....	30
Use.....	30
Copy Modifier.....	30
Move Modifier.....	30
Remove Modifier.....	30
Color Ramp.....	30
Controls.....	30
+.....	30
-.....	30
Tools menu.....	31

Flip Color Ramp.....	31
Distribute Stops from Left.....	31
Distribute Stops Evenly.....	31
Eyedropper (pipette icon) E.....	31
Reset Color Ramp.....	31
Color Mode.....	31
RGB.....	31
HSV/HSL.....	31
Interpolation.....	31
Ease.....	31
Cardinal.....	31
Linear.....	31
B-Spline.....	31
Constant.....	31
Color Ramp.....	31
Active Color Stop elements.....	31
Choose active color stop.....	32
Number of Stop.....	32
Pos.....	32
Freestyle Color panel.....	32
Base Color.....	32
Freestyle Color modifiers.....	32
Along Stroke.....	32
Blend Mode.....	32
Influence.....	32
Crease Angle.....	32
Blend Mode.....	32
Influence.....	33
Angle Min / Max.....	33
Curvature 3D.....	33
Blend Mode.....	33
Influence.....	33
Curvature Min and Max.....	33
Distance from Camera.....	33
Blend Mode.....	33
Influence.....	33
Range Min and Range Max.....	33
Fill Range by Selection.....	34
Distance from Object.....	34
Blend Mode.....	34
Influence.....	34
Target.....	34
Range Min and Range Max.....	34
Fill Range by Selection.....	34
Material.....	34
Blend Mode.....	34
Influence.....	34
Material Attribute.....	35
Ramp.....	35
Noise.....	35
Blend Mode.....	35
Influence.....	35
Amplitude.....	35

Period.....	35
Seed.....	35
Asymmetric.....	35
Tangent.....	36
Blend Mode.....	36
Influence.....	36
Freestyle Alpha panel.....	36
Base Transparency.....	36
Freestyle Alpha modifiers.....	36
Along Stroke.....	36
Blend Mode.....	36
Influence.....	36
Mapping.....	36
Invert.....	36
Crease Angle.....	37
Blend Mode.....	37
Influence.....	37
Angle Min / Max.....	37
Mapping.....	37
Invert.....	37
Curvature 3D.....	37
Blend Mode.....	37
Influence.....	37
Mapping.....	37
Invert.....	38
Curvature Min and Max.....	38
Distance from Camera.....	38
Blend Mode.....	38
Influence.....	38
Mapping.....	38
Invert.....	38
Range Min and Range Max.....	38
Fill Range by Selection.....	38
Distance from Object.....	38
Blend Mode.....	38
Influence.....	38
Target.....	39
Mapping.....	39
Invert.....	39
Range Min and Range Max.....	39
Fill Range by Selection.....	39
Material.....	39
Blend Mode.....	39
Influence.....	39
Material Attribute.....	39
Mapping.....	39
Invert.....	40
Noise.....	40
Blend Mode.....	40
Influence.....	40
Amplitude.....	40
Period.....	40
Seed.....	40

Mapping.....	40
Invert.....	40
Tangent.....	40
Blend Mode.....	40
Influence.....	41
Mapping.....	41
Invert.....	41
Freestyle Thickness panel.....	41
Base Thickness.....	41
Thickness Position.....	41
Center.....	41
Inside.....	41
Outside.....	41
Relative.....	41
Thickness Ratio.....	41
Freestyle Thickness modifiers.....	42
Along Stroke.....	42
Blend Mode.....	42
Influence.....	42
Mapping.....	42
Invert.....	42
Value Min / Max.....	42
Calligraphy.....	42
Blend Mode.....	42
Influence.....	42
Orientation.....	42
Thickness Min / Max.....	42
Crease Angle.....	43
Blend Mode.....	43
Influence.....	43
Thickness Min / Max.....	43
Angle Min / Max.....	43
Mapping.....	43
Invert.....	43
Curvature 3D.....	43
Blend Mode.....	43
Influence.....	43
Thickness Min / Max.....	44
Curvature Min and Max.....	44
Mapping.....	44
Invert.....	44
Distance from Camera.....	44
Blend Mode.....	44
Influence.....	44
Mapping.....	44
Invert.....	44
Range Min and Range Max.....	44
Value Min and Value Max.....	44
Distance from Object.....	45
Blend Mode.....	45
Influence.....	45
Target.....	45
Mapping.....	45

Invert.....	45
Range Min and Range Max.....	45
Value Min and Value Max.....	45
Material.....	45
Blend Mode.....	45
Influence.....	45
Material Attribute.....	46
Mapping.....	46
Invert.....	46
Value Min and Value Max.....	46
Noise.....	46
Blend Mode.....	46
Influence.....	46
Amplitude.....	46
Period.....	46
Seed.....	46
Asymetric.....	47
Tangent.....	47
Blend Mode.....	47
Influence.....	47
Thickness Min / Max.....	47
Mapping.....	47
Invert.....	47
Freestyle Geometry.....	47
Freestyle Geometry Modifiers.....	47
2D Offset.....	47
Start / End.....	47
X / Y.....	48
2D Transform.....	48
Pivot.....	48
Scale X / Y.....	48
Rotation Angle.....	48
Backbone Stretcher.....	48
Backbone Length.....	48
Bezier Curve.....	48
Error.....	48
Blueprint.....	48
Shape.....	48
Rounds.....	49
Random Radius.....	49
Center.....	49
Guiding Lines.....	49
Offset.....	49
Perlin Noise 1D.....	49
Frequency.....	49
Amplitude.....	49
Seed.....	49
Octaves.....	49
Angle.....	49
Perlin Noise 2D.....	50
Frequency.....	50
Amplitude.....	50
Seed.....	50

Octaves.....	50
Angle.....	50
Polygonization.....	50
Error.....	50
Sampling.....	50
Sampling.....	50
Simplification.....	50
Tolerance.....	51
Sinus Displacement.....	51
Wavelength.....	51
Amplitude.....	51
Phase.....	51
Spatial Noise.....	51
Amplitude.....	51
Scale.....	51
Octaves.....	51
Smooth.....	51
Pure Random.....	51
Tip remover.....	52
Tip Length.....	52
Freestyle Texture.....	52
Use Nodes.....	52
Spacing along Stroke.....	52
Go to Linestyle Texture Properties.....	52
Custom Properties Panel.....	52
Add.....	52
Edit.....	53
Remove.....	53

View Layer

View Layers reference to Scene collections. They allow to set their visibility, selectability and other options. Each View Layer can use any collection you wish, and multiple View Layers can use the same collections or different collections.

Usually you have just one View layer for the whole scene. But you can create more View layers in the header, and rename them there.

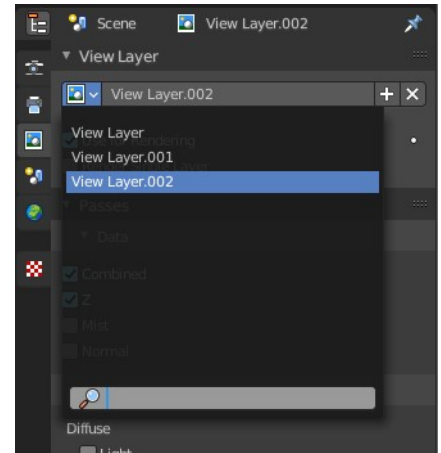

View layers are by default active for all collections. You can exclude them for specific layers in the Outliner. Select the view layer, and turn off the collections that you don't want to have active in this view layer.

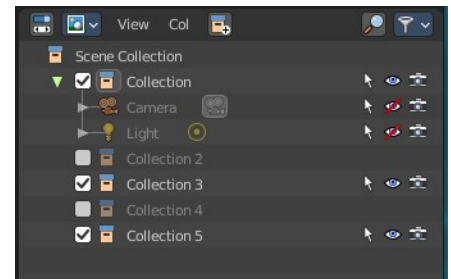

Note. The different render engines uses different view layer functionality. And so the panels and available options differs.

View Layer Panel - All Renderers

View Layer Prop

View Layer list

The list of available view layers

View Layer edit box

Set the active view layer, and view and edit the name of the current active view layer. Click into the edit box to edit the name.

Add View Layer

Adds a new view layer.

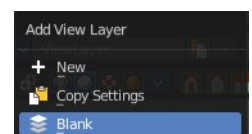
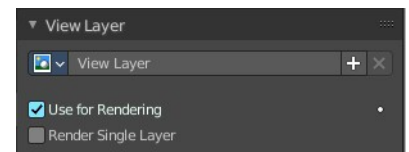

New

Adds a new view layer with the default content.

Copy Settings

Adds a new view layer with the content of the current active layer.

Blank

Adds a new view layer and deactivates all collections.

Remove View Layer

Removes the selected view layer.

Use for Rendering

Disable or enable the render layer.

Animate Property

This property can be animated. Activating this button sets a keyframe at the current frame.

Render Single Layer

Only render the active layer. This just works for rendering from the interface. Rendering from command line ignores this setting.

Eevee - Passes panel

Here you enable or disable passes for single features.

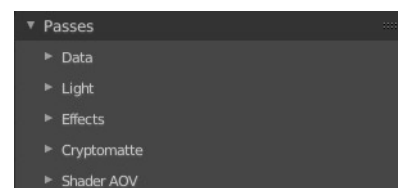

Data subpanel

Combined

Deliver full combined RGBA Buffer.

Z

Deliver Z Value pass.

Mist

Deliver Mist factor pass. 0.0 to 1.0

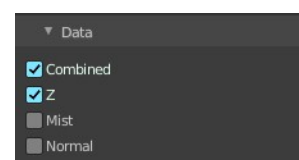

Normal

Deliver Normal pass.

Light subpanel

Diffuse

Light

Deliver diffuse direct pass.

Color

Deliver diffuse color pass.

Specular

Light

Deliver specular direct pass.

Color

Deliver specular color pass.

Volume

Light

Deliver volume direct light pass.

Scatter

Deliver volume scattering pass.

Other

Emission

Deliver emission pass.

Environment

Deliver environment lighting pass.

Shadow

Deliver shadow pass.

Ambient Occlusion

Deliver Ambient Occlusion pass. Ambient Occlusion needs to be enabled in the Render Properties.

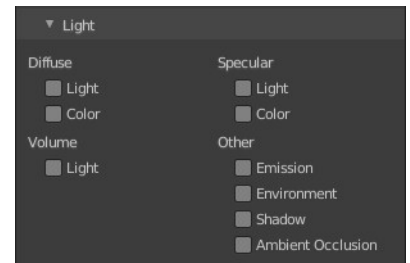

Effects subpanel

Bloom

Deliver Bloom pass. Bloom must be enabled in the Render Properties.



Transparent

Deliver alpha blended surfaces in a separate pass.

Cryptomatte subpanel

Cryptomatte passes can be used to isolate objects or materials or assets in compositing.

Include

Object

Render Cryptomatte Object Pass.

Materials

Render Cryptomatte Materials Pass.

Asset

Render Cryptomatte Asset Pass.

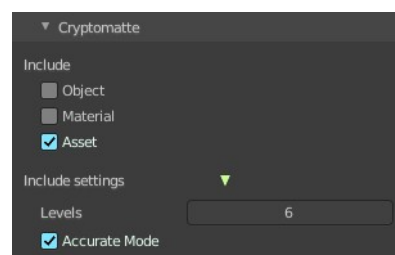

Include Settings

These settings appears when you tick one of the above includes.

Levels

How many unique objects can be distinguished per pixel.

Accurate Mode

Generate a more accurate cryptomatte pass. This feature renders at the CPU only, and consumes more memory.

Shader AOV subpanel

AOV stands for Arbitrary Output Variables. Here you can add custom render passes for arbitrary shader node components. These values can then be used in the post processing in the node editor.

To use Shader AOVs create the pass in the Shader AOV panel then reference

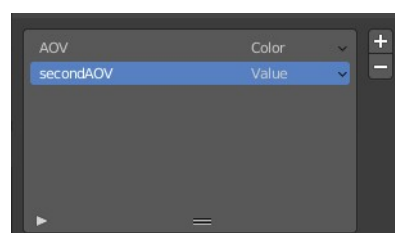

this pass with the AOV Output shading node. Each AOV in the list consists of a Name and Data Type.

List of AOV

Name

The name of the render pass. This is the Name that is referenced in the AOV Output node. You can name it as you like as long as the name does not conflict with enabled built-in passes.

Data Type

Right clicking at the black triangle at the end will reveal the type menu.

Shader AOVs can either express a Color or a Value variable. The Color variable as the name suggest can be used for a color but also a normal value. A Value variable can be used for any single numerical value.

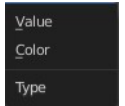

Add AOV

Adds an AOV to the list.

Remove AOV

Removes the selected AOV from the list.

Cycles - Passes Panel

Here you enable or disable render passes for single features.

Data subpanel

Include

Combined

Deliver full combined RGBA Buffer.

Z

Deliver Z Value pass.

Mist

Deliver Mist factor pass. 0.0 - 1.0.

Normal

Deliver Normal pass.

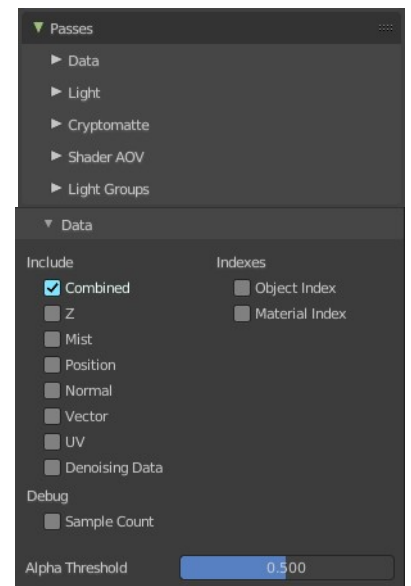

Vector

Deliver Speed Vector pass.

UV

Deliver UV pass.

Denoising Data

Store the denoising feature passes and the noisy image.

Indexes

Object Index

Deliver Object Index pass.

Material Index

Deliver Material Index pass.

Debug

Sample Count

Number of samples/camera rays per pixel.

Alpha Threshold

Z, Index, Normal, UV and Vector passes are just affected by surfaces with alpha transparency equal or higher this threshold.

Mist subpanel

When you activate Mist pass, then the Mist Pass subpanel shows.

Start

The starting distance of the mist, measured from the camera.

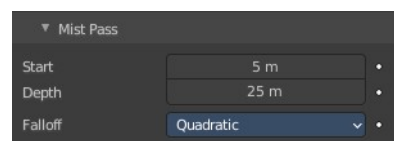

Depth

The distance over which the mist effect fades in.

Falloff

The falloff progression of the mist.

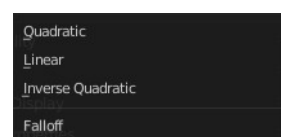

Light subpanel

Diffuse

Direct

Deliver direct pass.

Indirect

Deliver indirect pass.

Color

Deliver color pass.

Glossy

Direct

Deliver direct pass.

Indirect

Deliver indirect pass.

Color

Deliver color pass.

Transmission

Direct

Deliver direct pass.

Indirect

Deliver indirect pass.

Color

Deliver color pass.

Volume

Direct

Deliver direct pass.

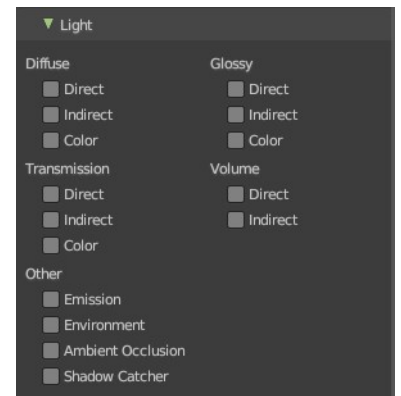

Indirect

Deliver indirect pass.

Color

Deliver color pass.

Other

Emission

Deliver Emission pass.

Environment

Deliver Environment pass.

Ambient Occlusion

Deliver Ambient Occlusion pass.

Shadow Catcher

Pass containing light and shadows that you want to multiply into the background image.

Cryptomatte subpanel

Cryptomatte passes can be used to isolate objects or materials or assets in compositing.

Include

Object

Render Cryptomatte Object Pass.

Materials

Render Cryptomatte Materials Pass.

Asset

Render Cryptomatte Asset Pass.

Include Settings

These settings appears when you tick one of the above includes.

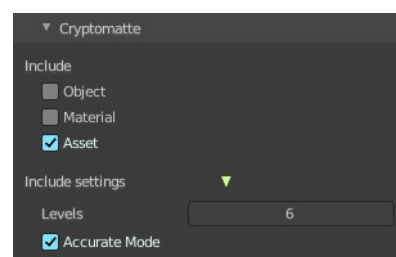

Levels

How many unique objects can be distinguished per pixel.

Accurate Mode

Generate a more accurate cryptomatte pass. This feature renders at the CPU only, and consumes more memory.

Shader AOV subpanel

AOV stands for Arbitrary Output Variables. Here you can add custom render passes for arbitrary shader node components. These values can then be used in the post processing in the node editor.

To use Shader AOVs create the pass in the Shader AOV panel then reference this pass with the AOV Output shading node. Each AOV in the list consists of a Name and Data Type.

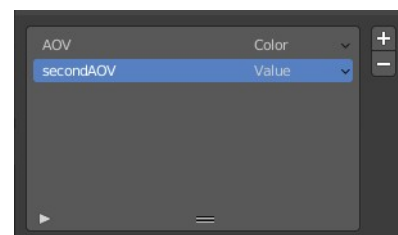

List of AOV

Name

The name of the render pass. This is the Name that is referenced in the AOV Output node. You can name it as you like as long as the name does not conflict with enabled built-in passes.

Data Type

Right clicking at the black triangle at the end will reveal the type menu.

Shader AOVs can either express a Color or a Value variable. The Color variable as the name suggest can be used for a color but also a normal value. A Value variable can be used for any single numerical value.

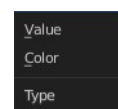

Add AOV

Adds an AOV to the list.

Remove AOV

Removes the selected AOV from the list.

Light Groups subpanel

Light groups are a type of pass that only contains lighting from a subset of light sources. They are created in the View layer. And any light source (lamps, objects with emissive materials and/or the environment) can be assigned to such a group.

This can be done in the object properties in the shading panel.

Note that Light groups are identified by their name - therefore, the name of

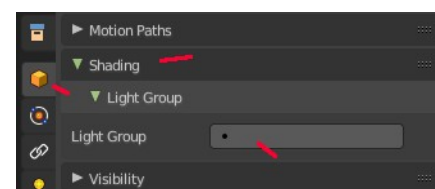
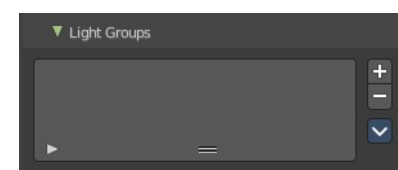

the Lightgroup in the View Layer and the name that's set in an object's settings must match for it to be included.

Add Light Group

Adds a new light group to the list.

Remove Light Group

Removes the selected lightgroup from the list.

Lightgroup Sync menu

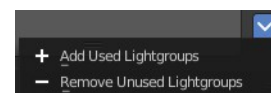

Add used Light groups

Add all used light groups to the list. It can be that there is an object attached to a light group which is not in the list yet. From an appended file for example.

Remove unused light groups

Removes all light groups from the list that has no user.

Cycles - Filter Panel

Include

Environment

Render Sky in this layer.

Ambient Occlusion

Render Ambient Occlusion in this layer.

Surfaces

Render solid surfaces in this layer.

Curves

Render Hair in this layer.

Volume

Render volumes in this layer.

Use

Motion Blur

Render Motion Blur, if enabled in the scene.

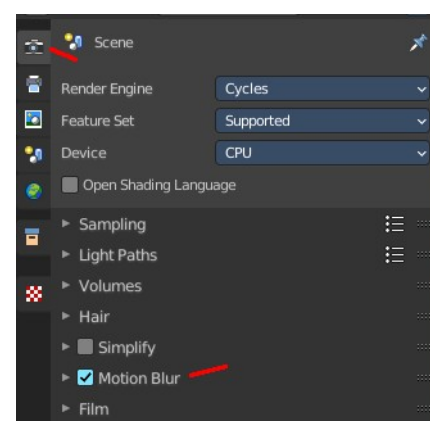
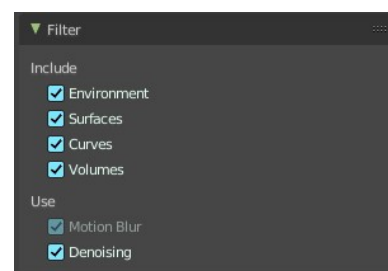

Denoising

Use Denoising, if enabled in the scene.

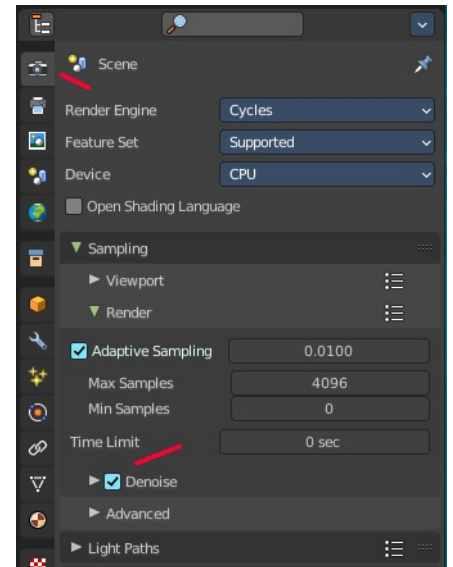

Cycles - Override Panel

Here you can add a material that overrides all other materials in this layer. This allows clay renderings.



Material Override

Pick a material in the scene that should override all other materials.

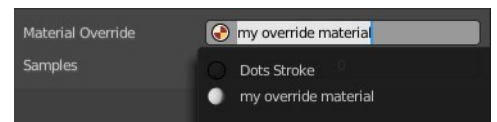

Samples

Override number of render samples for this view layer. A value of 0 will use the scene setting values.

Freestyle Panel

This panel and all further freestyle panels just shows when you have Freestyle activated in the Render Properties!

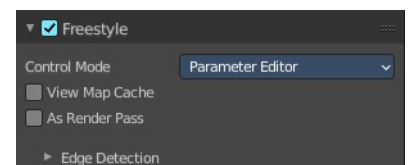

Enable

Enables or disables the freestyle layer in the current view layer.

Control Mode

You can either control the freestyle shapes by the settings in the panels. Or you can use a python script to define all the shapes. In this case the panels vanishes, and you can add your style script below.

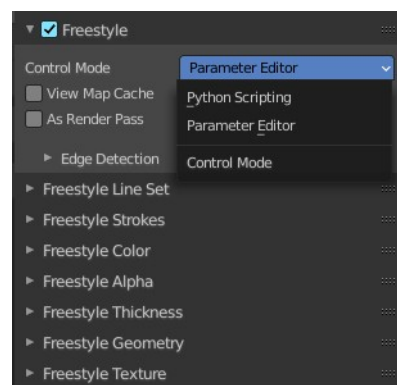
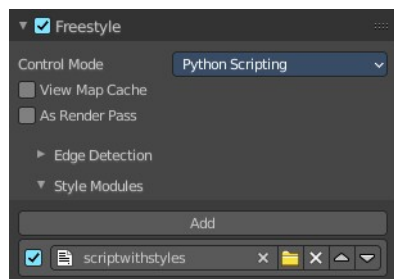

View Map Cache

Keep the computed Key Map. And avoid recalculation if mesh geometry is unchanged.

As Render Pass

Renders the freestyle pass as a separate pass instead of adding it as an overlay to the Combined pass.

Edge detection subpanel

How the edge detection happens.

Crease Angle

Angular Threshold for detecting crease angles.

Culling

Ignore edges that are out of view.

Face Smoothness

Take the face smoothness into account for the view map calculation.

Material Boundaries

Use Material Boundaries.

Ridges and Valleys

Use ridges and valleys for the view map calculation.

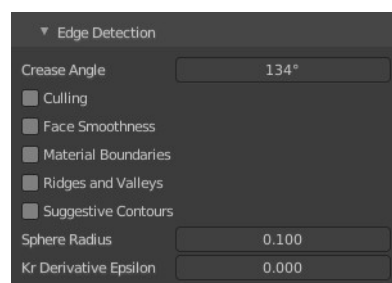

Suggestive Contours

Use suggestive contours.

Sphere Radius

The sphere radius for calculating curvatures

Kr Derivate Epsilon

The Ki Derivate Epsilon radius for calculating suggestive contours.

Style Module subpanel

This panel appears with Control Mode Python Scripting. Add a python script that defines the style.

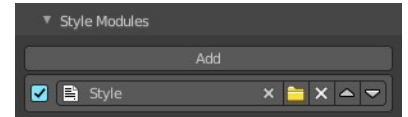

The structure of such a style is not defined nor described. Please ask the Blender developers.

Freestyle Line Set Panel

The line set settings.

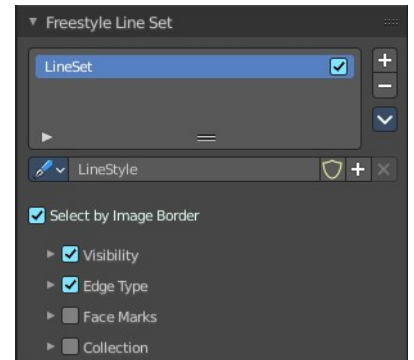

List of Line Sets

A line set holds the line style. You can have more than one line set. But just one LineStyle per set.

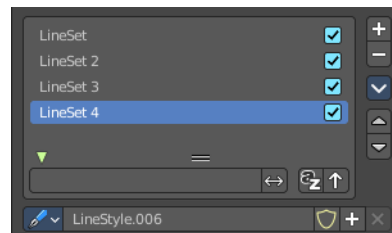

The line sets can be activated or deactivated with the checkbox at the end.

Drag Handler

Allows to resize the list.

Search field

When you click at the triangle button then you can reveal a search field.

Edit Box

Type in the search term and hit enter.

Invert

Inverts the search.

Sort by Name

Sorts the list by name

Reverse

Reverts the list content.

Add Line Set

Adds a new line set. Adding a new line set also adds a new LineStyle.

Remove Line Set

Removes the selected line set.

Lineset Specials menu

Copy Line Set

Copies the currently selected line set and all its settings.

Paste Line Set

Pastes the copied line set and all its settings into the currently selected line set.



Move Line Set up or down

Moves the selected up or down in the list.

Line style data property

Data Browser

A list of available LineStyles.

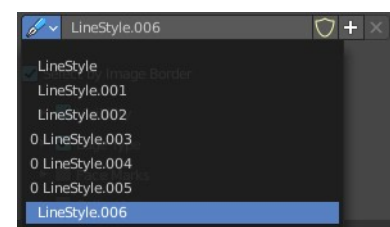

Edit Box

Displays the name of the currently active LineStyle. It also allows you to rename the LineStyle. Click into the edit box, change the name, hit enter.

Fake User

Save this LineStyle with the scene even when it has no user. Fake User is an old Blender concept to keep data in the scene that has no user. Data without an user gets usually deleted with saving the scene.

Add new LineStyle

Adds a new LineStyle.

Remove LineStyle

This button is dysfunctional and permanently greyed out. Once added LineStyles are permanent by Blender design since every line set needs at least one linestyle. You can only remove unused linestyles by purging unused Data in the outliner.

Select by Image Border

Select feature edges by image border.

Visibility Subpanel

Determine how to use visibility for feature edge detection.

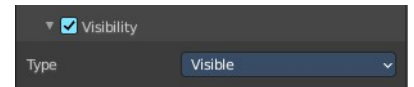

Type

Visible

Select visible feature edges.



Hidden

Select hidden feature edges.

Quantitative invisibility

Select feature edges within a range of quantitative invisibility values. The value is called QI.

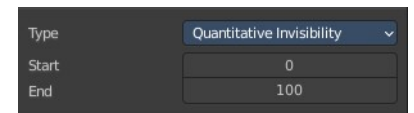

Start

The first value.

End

The last value.

Edge Type subpanel

Selection by Edge Types

The checkbox in the header activates or deactivates the feature. Select feature edges based on Edge Types.

Negation

Inclusive

Select edges by satisfying the selected options.

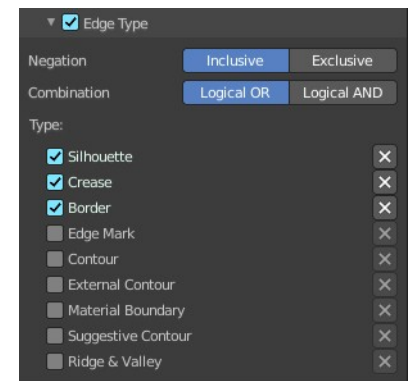

Exclusive

Select edges by satisfying the exact opposite of the selected options.

Combination

Logical Or

Select edges by satisfying at least of the selected options.

Logical And

Select edges by satisfying all of the selected options.

Type

What type to use. The names should be self explaining. The X Button at the end is to exclude this type instead of including it.

Face Masks Subpanel

Selection by Face Marks

Select Feature Edges by Face Marks.



Negation

Include or exclude the edges selected by face marks.

Condition

Select a feature edge if one face is marked. Or select a feature edge if the two adjacent faces are marked.

Collection Subpanel

Selection by Collection

Select feature edges based on a collection of objects.

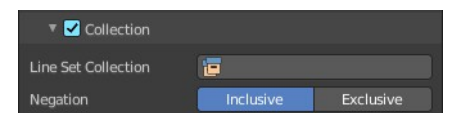

Line Set Collection

Pick the collection that you want to use.

Negation

Select feature edges by including or excluding the selected collection.

Freestyle Strokes Panel

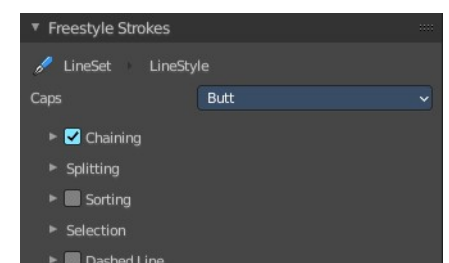

Caps

Select the shape of both ends of the stroke. Butt, Round or Square.

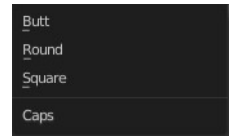

Chaining Subpanel

Chaining

Enable chaining of feature edges.



Method

How feature edges are jointed to form chains.

Plain

Feature edges are jointed plain.

Sketchy

Feature edges are jointed sketchy.



Rounds

Number of rounds in a sketchy multiple touch.

Splitting subpanel

Min 2D Angle

Minimum 2d angle for splitting chains.

Max 2D Angle

Maximum 2d angle for splitting chains.

2D Length

Curvilinear length for 2d splitting

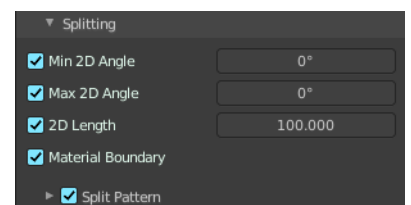

Material Boundary

Split chains of feature edges at material boundaries.

Split Pattern sub subpanel

Use Split Pattern

Enable chain splitting by dashed line patterns.

Dash 1, 2, 3

Length of the dashes for splitting.

Gap 1, 2, 3

Length of the gaps for splitting.



Sorting subpanel

Sort Key

How to determine the stacking order of chains.

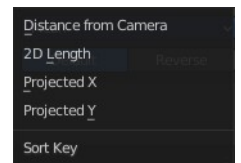
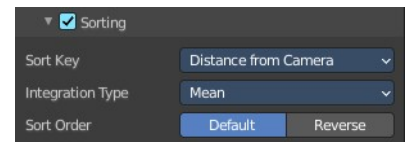

Integration Type

How the sort key is computed for each chain.

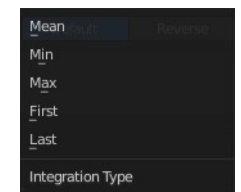

Sort order

Sort by default or inverse.

Selection Subpanel

Min 2D Length

The selection of chains by a minimum 2D length.

Max 2D Length

The selection of chains by a maximum 2D length.

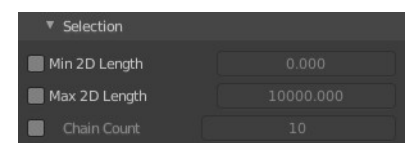

Chain Count

Select first N chains. N stands for a variable, and is defined in the edit box.

Dashed Line subpanel

Dashed Line

Enable dashed line. A line is then displayed as dashes.



Dash 1, 2, 3

Length of the dash for the dashed lines.

Gap 1, 2, 3

Length of the gap for the dashed lines.

Freestyle Modifiers

The Freestyle panels Freestyle Color, Freestyle Alpha, Freestyle Thickness and Freestyle Geometry allows you to use so called modifiers. Modifiers allows you to modify these settings in several aspects.

Some modifier, like the along stroke modifier, does have the same name. But has here and there different functionality.

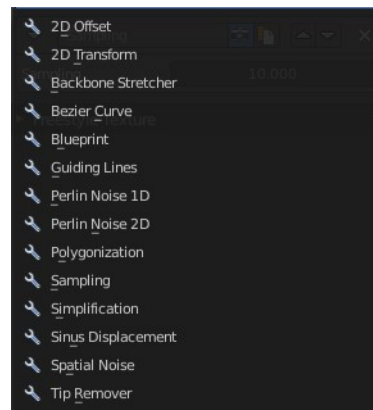
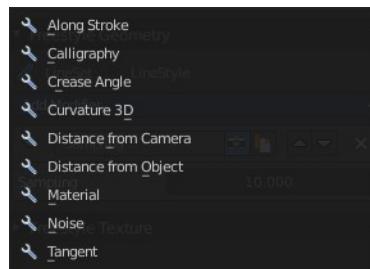
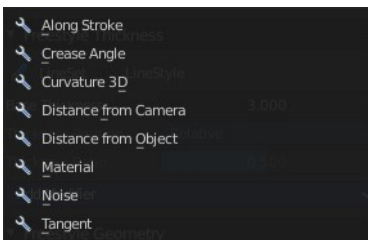

Color, Alpha and Thickness Modifier

Header

From left to right.



Triangle button

Open or close the modifier panel.

Edit Box

Displays the name of the modifier. You can also rename it. Click into the edit box, change name and hit enter.

Use

Enable the modifier.

Copy Modifier

Copies the Modifier.

Move Modifier

Moves the modifier up or down the list.

Remove Modifier

Removes the modifier from the list.

Color Ramp

The color, alpha and thickness modifiers all have a color ramp.

Controls

+

Add a stop to your color ramp. The stop will be added after the selected one, in the middle to the next one.

-

Deletes the selected color stop from the list.

Tools menu

Flip Color Ramp

Flips the gradient, inverting the values of the color ramp.

Distribute Stops from Left

Rearrange the stops so that every step has the same space to the right.

Distribute Stops Evenly

Space between all neighboring stops becomes equal.

Eyedropper (pipette icon) E

An Eyedropper to sample a color or gradient from the interface to be used in the color ramp.

Reset Color Ramp

Resets the color ramp to its default state.

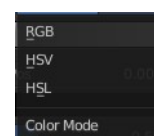
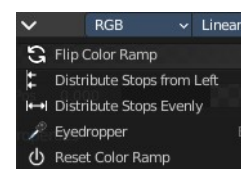

Color Mode

RGB

Blends color by mixing each color channel and combining.

HSV/HSL

Blends colors by first converting to HSV or HSL, mixing, then combining again. This has the advantage of maintaining saturation between different hues, where RGB would de-saturate, this allows for a richer gradient.

Interpolation

Ease

Uses an Ease Interpolation for the color stops.

Cardinal

Uses a Cardinal Interpolation for the color stops.

Linear

Uses a Linear Interpolation for the color stops.

B-Spline

Uses a B-Spline Interpolation for the color stops.

Constant

Uses a Constant Interpolation for the color stops.

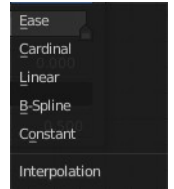

Color Ramp

The color band. A click at one of the color stops makes it the active one. You can move the color stops by clicking at them and dragging them around.



Active Color Stop elements

Adjust the active color stop.

Choose active color stop

Choose the color stop by index.

Number of Stop

The active color stop.

Pos

The position and color of the active color stop. The range goes from 0.000 to 1.000.



Freestyle Color panel

Modify the color of the stroke.

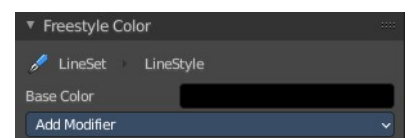

Base Color

Here you can choose the base color that needs to be modified.

Freestyle Color modifiers

Along Stroke

Add a colorband along the stroke.

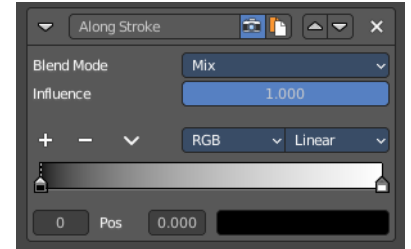

Blend Mode

The color blend mode.

Influence

The influence of the modifier.

Crease Angle

Add a color band along a crease angle. Which is the angle between two adjacent faces) If a stroke segment does not lie on a crease , then its properties are not touched by the modifier.

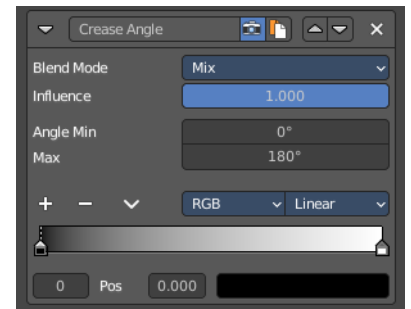

Blend Mode

The color blend mode.

Influence

The influence of the modifier.

Angle Min / Max

The minimum and maximum crease angle to modify thickness.

Curvature 3D

This modifier is based on the radial curvatures of the underlying 3D surface. The curvature of a 2D curve at a point is a measure of how quickly the curve turns at the point. The quicker the turn is, the larger the curvature is at the point. The curvature is zero if the curve is a straight line. Radial curvatures are those computed for a 2D curve that appears at the cross section between the 3D surface and a plane defined by the view point (camera location) and the normal direction of the surface at the point.

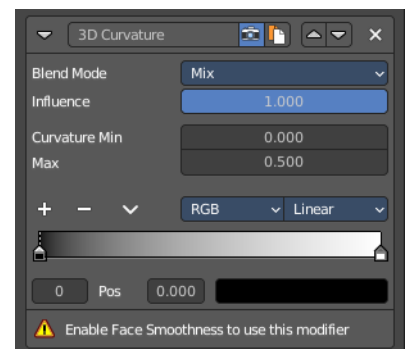

This modifier requires to have the Face Smoothness option on and the object needs to have Smooth Shading.

Blend Mode

The color blend mode.

Influence

The influence of the modifier.

Curvature Min and Max

The limits of the mapping. If the current point of the stroke is at Min Curvature or less from the target, it will take the start point of the mapping. If it is at Max Curvature or more from the target, it will take the end-point value of the mapping.

Distance from Camera

Recalculates the base property by the distance to the camera.

Blend Mode

The color blend mode.

Influence

The influence of the modifier.

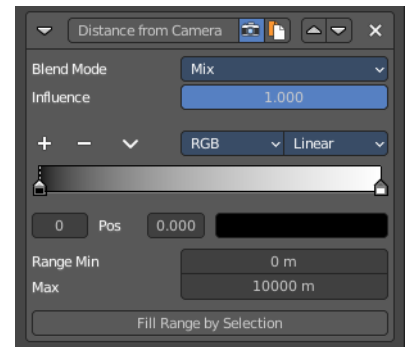

Range Min and Range Max

The minimum and maximum range. These values are in scene units.

Fill Range by Selection

Sets the minimum and maximum range values from the distances between the current selected mesh vertices and the camera or the target.

Distance from Object

Recalculates the base property by the distance to a chosen object.

Blend Mode

The color blend mode.

Influence

The influence of the modifier.

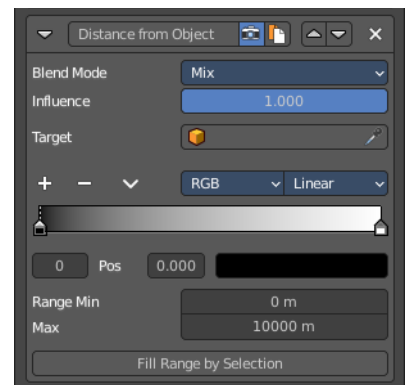

Target

Pick the target object.

Range Min and Range Max

The minimum and maximum range. These values are in scene units.

Fill Range by Selection

Sets the minimum and maximum range values from the distances between the current selected mesh vertices and the camera or the target.

Material

Alters the base property on the current material under the stroke.

Blend Mode

The color blend mode.

Influence

The influence of the modifier.

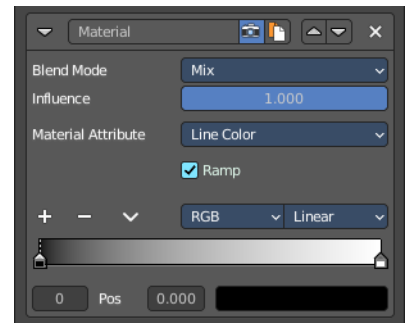

Material Attribute

What attribute of the material under the stroke to alter.

Ramp

Shows and activates the color ramp.

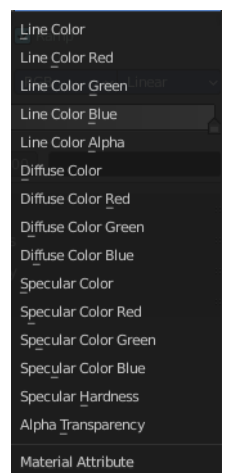

Noise

Uses a noise based pseudo random number generator to add some variation

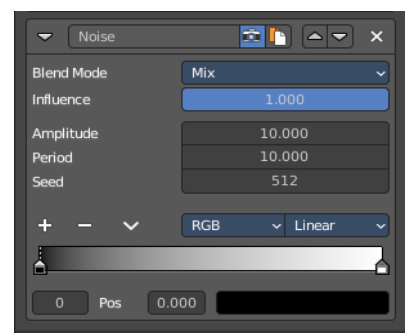

along the stroke.

Blend Mode

The color blend mode.

Influence

The influence of the modifier.

Amplitude

The maximum value of the noise. A higher amplitude means a less transparent (more solid) stroke.

Period

The period of the noise. This means how quickly the property value can change. A higher value means a more smoothly changing color along the stroke.

Seed

Seed used by the pseudo-random number generator.

Asymmetric

Thickness only – Allows the thickness to be distributed unevenly at every point.

Tangent

Modifies the base value on the traveling direction of the stroke, evaluated at the stroke's vertices.

Blend Mode

The color blend mode.

Influence

The influence of the modifier.

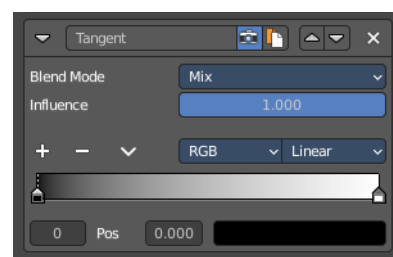

Freestyle Alpha panel

Modify the transparency of the stroke.

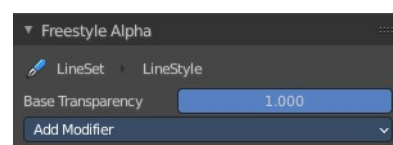

Base Transparency

The base transparency that you want to modify.

Freestyle Alpha modifiers

Along Stroke

Add a gradient along the stroke.

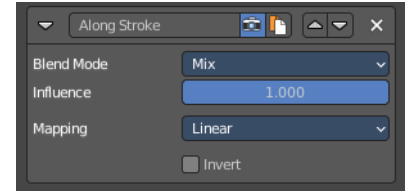

Blend Mode

The color blend mode.

Influence

The influence of the modifier.

Mapping

The mapping type. Linear or Curve.

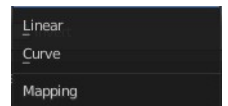

Invert

Inverts the values.

Crease Angle

Add a gradient along a crease angle. Which is the angle between two adjacent faces) If a stroke segment does not lie on a crease , then its properties are not touched by the modifier.

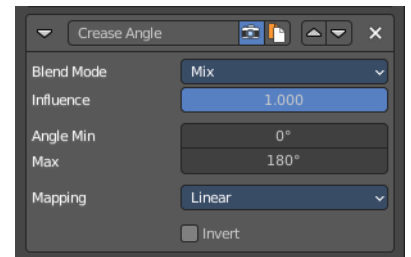

Blend Mode

The color blend mode.

Influence

The influence of the modifier.

Angle Min / Max

The minimum and maximum crease angle to modify thickness.

Mapping

The mapping type. Linear or Curve.

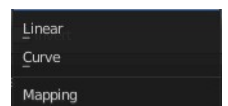

Invert

Inverts the values.

Curvature 3D

This modifier is based on the radial curvatures of the underlying 3D surface. The curvature of a 2D curve at a point is a measure of how quickly the curve turns at the point. The quicker the turn is, the larger the curvature is at the point. The curvature is zero if the curve is a straight line. Radial curvatures are those computed for a 2D curve that appears at the cross section between the 3D surface and a plane defined by the view point (camera location) and the normal direction of the surface at the point.

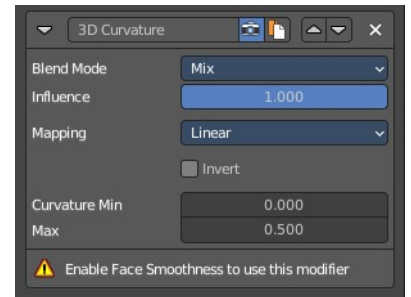

This modifier requires to have the Face Smoothness option on and the object needs to have Smooth Shading.

Blend Mode

The color blend mode.

Influence

The influence of the modifier.

Mapping

The mapping type. Linear or Curve.

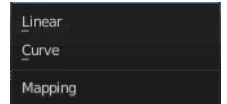

Invert

Inverts the values.

Curvature Min and Max

The limits of the mapping. If the current point of the stroke is at Min Curvature or less from the target, it will take the start point of the mapping. If it is at Max Curvature or more from the target, it will take the end-point value of the mapping.

Distance from Camera

Recalculates the base property by the distance to the camera.

Blend Mode

The color blend mode.

Influence

The influence of the modifier.

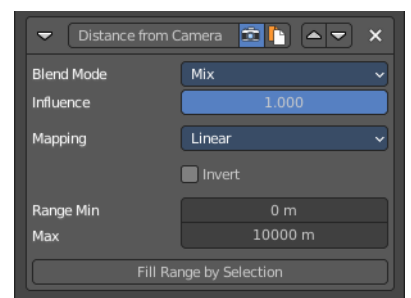

Mapping

The mapping type. Linear or Curve.

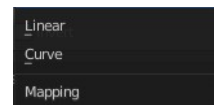

Invert

Inverts the values.

Range Min and Range Max

The minimum and maximum range. These values are in scene units.

Fill Range by Selection

Sets the minimum and maximum range values from the distances between the current selected mesh vertices and the camera or the target.

Distance from Object

Recalculates the base property by the distance to a chosen object.

Blend Mode

The color blend mode.

Influence

The influence of the modifier.

Target

Pick the target object.

Mapping

The mapping type. Linear or Curve.

Invert

Inverts the values.

Range Min and Range Max

The minimum and maximum range. These values are in scene units.

Fill Range by Selection

Sets the minimum and maximum range values from the distances between the current selected mesh vertices and the camera or the target.

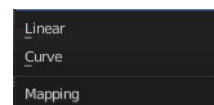
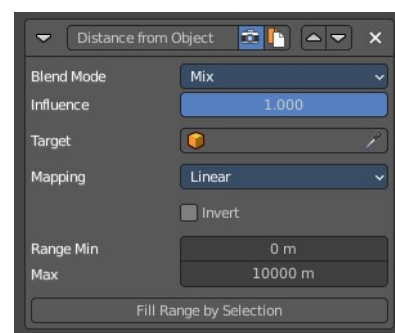

Material

Alters the base property on the current material under the stroke.

Blend Mode

The color blend mode.

Influence

The influence of the modifier.

Material Attribute

What attribute of the material under the stroke to alter.

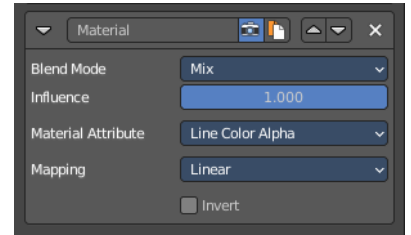

Mapping

The mapping type. Linear or Curve.

Invert

Inverts the values.

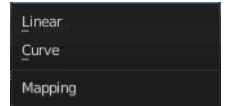
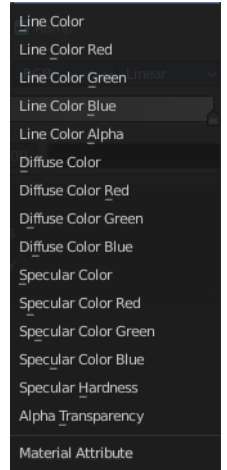

Noise

Uses a noise based pseudo random number generator to add some variation along the stroke.

Blend Mode

The color blend mode.

Influence

The influence of the modifier.

Amplitude

The maximum value of the noise. A higher amplitude means a less transparent (more solid) stroke.

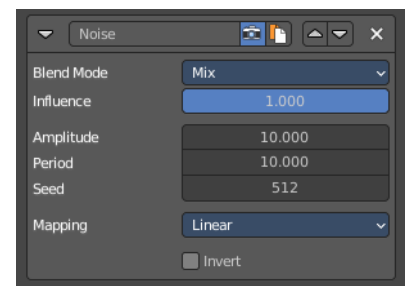

Period

The period of the noise. This means how quickly the property value can change. A higher value means a more smoothly changing color along the stroke.

Seed

Seed used by the pseudo-random number generator.

Mapping

The mapping type. Linear or Curve.

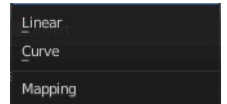

Invert

Inverts the values.

Tangent

Modifies the base value on the traveling direction of the stroke, evaluated at the stroke's vertices.

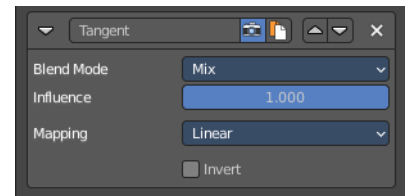

Blend Mode

The color blend mode.

Influence

The influence of the modifier.

Mapping

The mapping type. Linear or Curve.

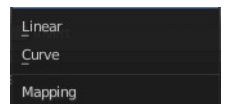

Invert

Inverts the values.

Freestyle Thickness panel

Modify the thickness of the stroke.

Base Thickness

The base thickness that you want to modify.

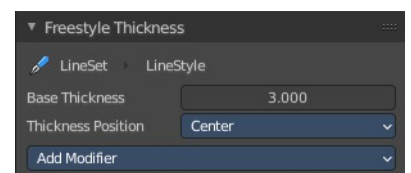

Thickness Position

The thickness position of silhouettes and border edges.

Center

Silhouettes and border edges are centered along the stroke.

Inside

Silhouettes and border edges are drawn inside of the stroke.

Outside

Silhouettes and border edges are drawn outside of the stroke.

Relative

Silhouettes and border edges are shifted by a user defined thickness ratio.

Thickness Ratio

The thickness ratio to shift the silhouettes and border edges.

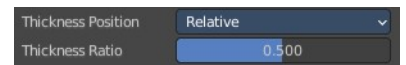
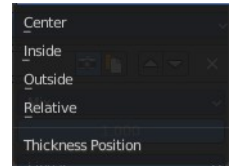

Freestyle Thickness modifiers

Along Stroke

Add a gradient along the stroke.

Blend Mode

The color blend mode.

Influence

The influence of the modifier.

Mapping

The mapping type. Linear or Curve.

Invert

Inverts the values.

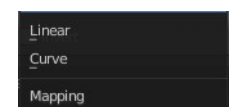
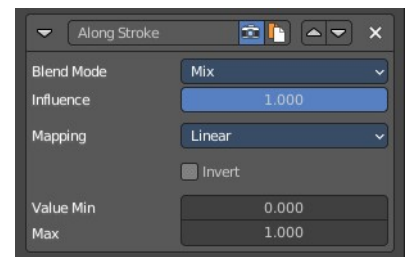

Value Min / Max

Minimum and maximum output value.

Calligraphy

Generates different thickness, based on the orientation of the stroke. The result is a stroke thickness that orients at calligraphy.

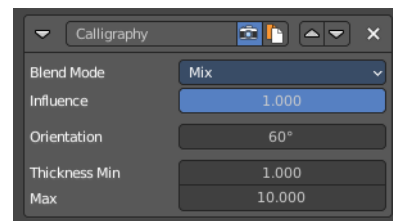

Blend Mode

The color blend mode.

Influence

The influence of the modifier.

Orientation

The angle of the virtual drawing tool, based at the vertical axis of the image. The thickest strokes will align with this angle.

Thickness Min / Max

Minimum and maximum output value.

Crease Angle

Add a gradient along a crease angle. Which is the angle between two adjacent faces) If a stroke segment does not lie on a crease , then its properties are not touched by the modifier.

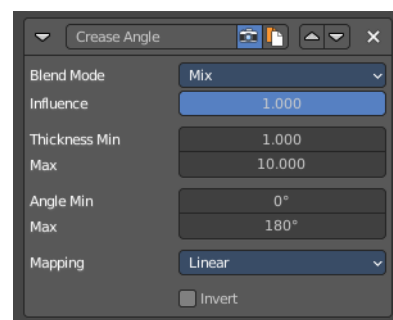

Blend Mode

The color blend mode.

Influence

The influence of the modifier.

Thickness Min / Max

The minimum and maximum thickness.

Angle Min / Max

The minimum and maximum crease angle to modify thickness.

Mapping

The mapping type. Linear or Curve.

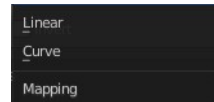

Invert

Inverts the values.

Curvature 3D

This modifier is based on the radial curvatures of the underlying 3D surface. The curvature of a 2D curve at a point is a measure of how quickly the curve turns at the point. The quicker the turn is, the larger the curvature is at the point. The curvature is zero if the curve is a straight line. Radial curvatures are those computed for a 2D curve that appears at the cross section between the 3D surface and a plane defined by the view point (camera location) and the normal direction of the surface at the point.

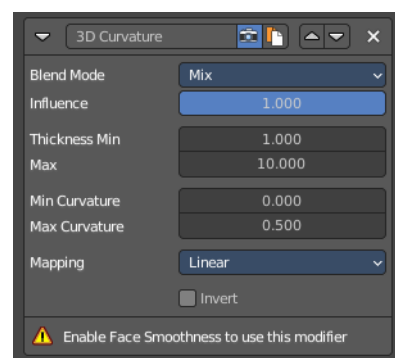

This modifier requires to have the Face Smoothness option on and the object needs to have Smooth Shading.

Blend Mode

The color blend mode.

Influence

The influence of the modifier.

Thickness Min / Max

The minimum and maximum thickness.

Curvature Min and Max

The limits of the mapping. If the current point of the stroke is at Min Curvature or less from the target, it will take the start point of the mapping. If it is at Max Curvature or more from the target, it will take the end-point value of the mapping.

Mapping

The mapping type. Linear or Curve.

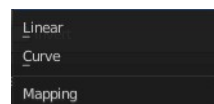

Invert

Inverts the values.

Distance from Camera

Recalculates the base property by the distance to the camera.

Blend Mode

The color blend mode.

Influence

The influence of the modifier.

Mapping

The mapping type. Linear or Curve.

Invert

Inverts the values.

Range Min and Range Max

The minimum and maximum range. These values are in scene units.

Value Min and Value Max

The minimum and maximum output value of the mapping. These values are in scene units.

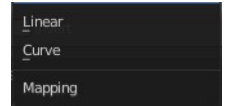
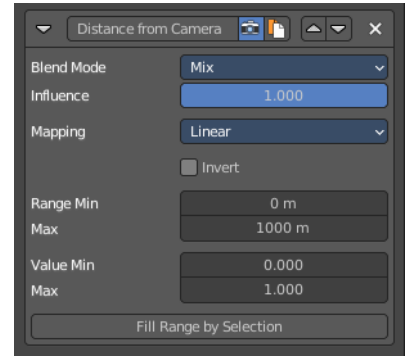

Distance from Object

Recalculates the base property by the distance to a chosen object.

Blend Mode

The color blend mode.

Influence

The influence of the modifier.

Target

Pick the target object.

Mapping

The mapping type. Linear or Curve.

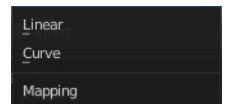
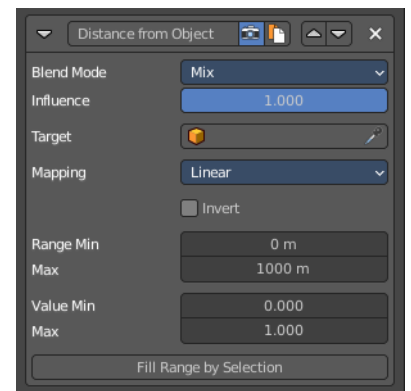

Invert

Inverts the values.

Range Min and Range Max

The minimum and maximum range. These values are in scene units.

Value Min and Value Max

The minimum and maximum output value of the mapping. These values are in scene units.

Material

Alters the thickness of the stroke based on the current material under the stroke.

Blend Mode

The color blend mode.

Influence

The influence of the modifier.

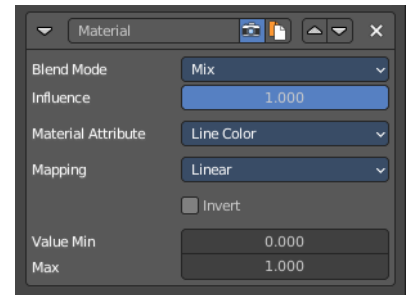

Material Attribute

What attribute of the material under the stroke to alter.

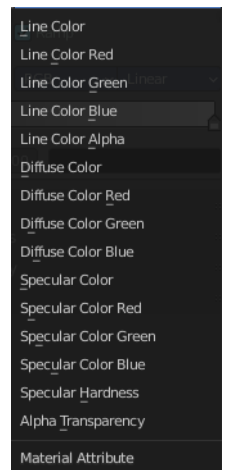

Mapping

The mapping type. Linear or Curve.

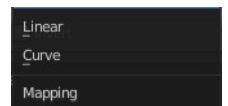

Invert

Inverts the values.

Value Min and Value Max

The minimum and maximum output value of the mapping. These values are in scene units.

Noise

Uses a noise based pseudo random number generator to add some variation along the stroke.

Blend Mode

The color blend mode.

Influence

The influence of the modifier.

Amplitude

The maximum value of the noise. A higher amplitude means a less transparent (more solid) stroke.

Period

The period of the noise. This means how quickly the property value can change. A higher value means a more smoothly changing color along the stroke.

Seed

Seed used by the pseudo-random number generator.

Asymetric

Assign the thickness asymmetrical at both sides of the stroke.

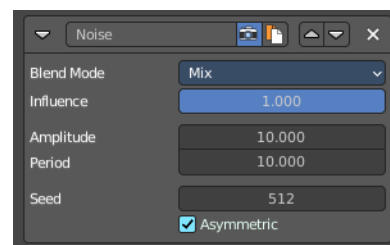

Tangent

Modifies the base value on the traveling direction of the stroke, evaluated at the stroke's vertices.

Blend Mode

The color blend mode.

Influence

The influence of the modifier.

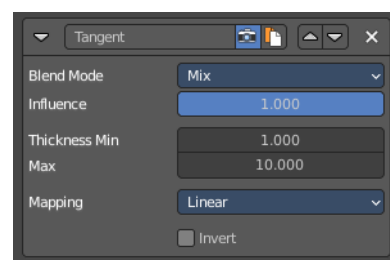

Thickness Min / Max

The minimum and maximum thickness.

Mapping

The mapping type. Linear or Curve.

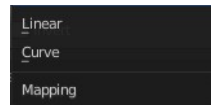

Invert

Inverts the values.

Freestyle Geometry

Modify the geometry of the freestyle strokes.

The modifier Sampling is on by default.

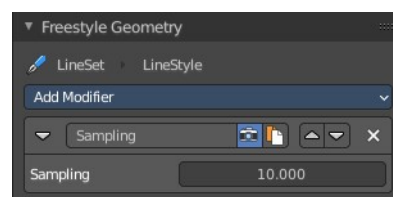

Freestyle Geometry Modifiers

2D Offset

Offset the stroke vertices from its original position.

Start / End

The start and end of the offset relative to the stroke.

X / Y

The offset amount along X and Y axis of the stroke vertices.

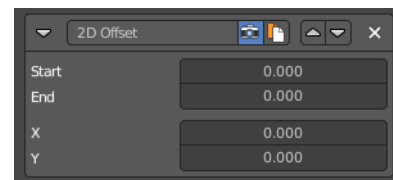

2D Transform

Scale the stroke.

Pivot

What center point to use for the scaling.

Scale X / Y

The scale amount along X and Y.

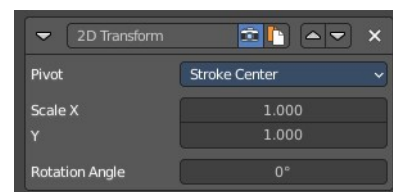

Rotation Angle

Rotate the stroke

Backbone Stretcher

Stretch the stroke.



Backbone Length

Amount of backbone stretching.

Bezier Curve

Turn the stroke into a bezier curve.

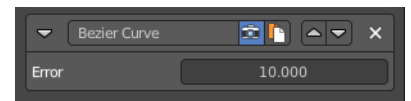

Error

The maximal allowed distance between the new bezier curve and the original backbone geometry.

Blueprint

Turn the strokes into a blueprint/cad like style stroke.

Shape

The shape of the blueprint contour strokes.

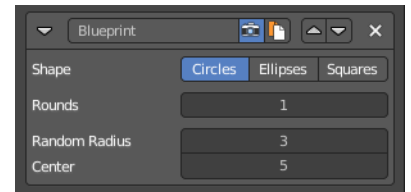

Rounds

Number of rounds in contour strokes.

Random Radius

Randomness of the radius.

Center

Randomness of the center.

Guiding Lines

Replaces a stroke by straight lines that connects both of its ends.

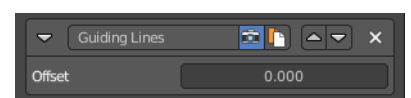

Offset

Add an offset to the the start and end points along the original stroke, before generating the new straight one.

Perlin Noise 1D

Adds one-dimensional Perlin noise to the stroke. This modifier will give an identical result for two strokes with the same length and sampling interval.

Frequency

How dense the noise is (kind of a scale factor along the stroke).

Amplitude

How much the noise distorts the stroke in the Angle direction.

Seed

The seed of the random generator (the same seed over a stroke will always give the same result).

Octaves

The “level of detail” of the noise.

Angle

In which direction the noise is applied (0.0 is fully horizontal).

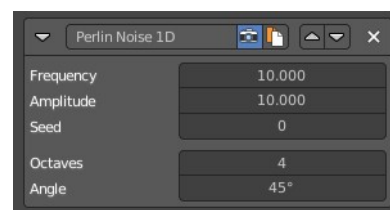

Perlin Noise 2D

Adds one-dimensional Perlin noise to the stroke. Different to the Perlin Noise 1D modifier the modifier generates noisy displacements using 2D coordinates of stroke vertices as the input of the noise generator.

Frequency

How dense the noise is (kind of a scale factor along the stroke).

Amplitude

How much the noise distorts the stroke in the Angle direction.

Seed

The seed of the random generator (the same seed over a stroke will always give the same result).

Octaves

The “level of detail” of the noise.

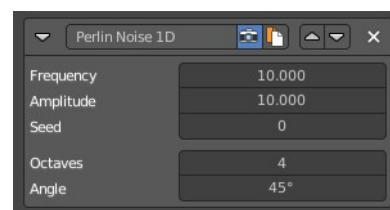

Angle

In which direction the noise is applied (0.0 is fully horizontal).

Polygonization

Simplify the stroke.

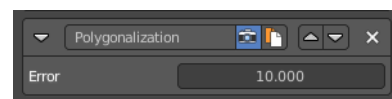

Error

The maximum distance allowed between the new simplified stroke and the original stroke.

Sampling

Changes the definition and precision of the stroke for the following modifiers.



Sampling

The smaller this value, the more precise are the strokes. The computation of smaller values needs more memory and time.

Simplification

Simplify the stroke by merging stroke vertices that are close to each other.

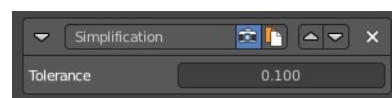

Tolerance

How close the vertices need to be to each other to be merged.

Sinus Displacement

Adds a sinusoidal displacement to the stroke.

Wavelength

How wide the undulations are along the stroke.

Amplitude

How high the undulations are across the stroke.

Phase

Allows “offsetting” (“moving”) the undulations along the stroke.

Tip! With a phase of 0 the undulations this modifier produces look exactly the same at a Phase of 0. Same goes for any positive or negative multiple of the Wavelength set on the modifier. This allows you to render short

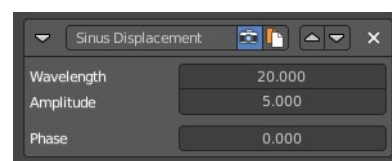

video sequences with wavy lines that can then be seamlessly looped without any visual jumps in the undulations along the line.

Spatial Noise

Adds some spatial noise to the stroke. Spatial noise displacements are added in the normal direction of each stroke vertex.

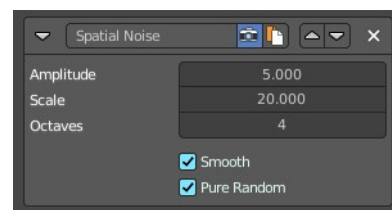

Amplitude

How much the noise distorts the stroke.

Scale

How wide the noise is along the stroke.

Octaves

The level of detail of the noise.

Smooth

When enabled, apply some smoothing over the generated noise.

Pure Random

The usual noise is not really random. Each value depends of the value before. So as a result is more a series of values. Which can lead to patterns. Pure random adds much more randomness to the strokes.

Tip remover

Removes a part of the stroke at the start and the end of a stroke

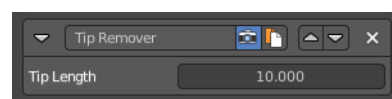

Tip Length

The length of the stroke that you want to remove.

Freestyle Texture

You can use a texture for the freestyle lines. The texture is created and managed in the texture tab. The material is created and managed in the Shader editor.

In this panel you just manage some settings for it

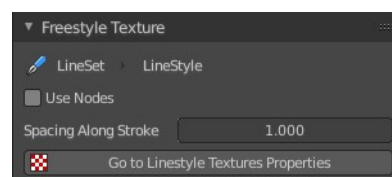

Use Nodes

Use shader nodes for the line style.

Spacing along Stroke

The spacing for textures along stroke length

Go to Linestyle Texture Properties

Switch to the Texture Properties tab to create and manage the texture.

Custom Properties Panel

Here you can define custom properties that can be used for scripting.

Here you might also find custom properties from addons or scripts.

Add

Adds a new property.

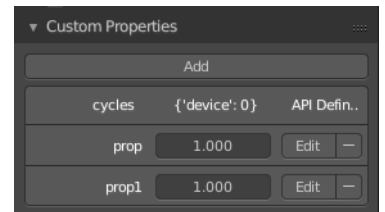

Edit

Opens a panel where you can adjust the settings for the custom property.

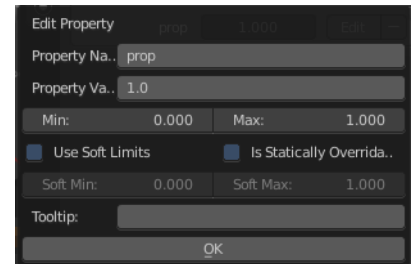

Remove

Removes the property.



26.5 Editors - Properties Editor - Scene Properties Tab

Table of content

Scene Tab.....	2
Scene Panel.....	2
Scene Data Prop.....	3
Scene Browser.....	3
Edit Box.....	3
Pin Scene to Workspace.....	3
New Scene.....	3
New.....	3
Copy Settings.....	3
Linked Copy.....	3
Full Copy.....	3
Duplicate4.....	4
Delete Scene.....	4
Camera.....	4
Background Scene.....	4
Active Movie Clip.....	4
Units Panel.....	4
Unit System.....	4
Unit Scale.....	4
Separate Units.....	5
Rotation.....	5
Length.....	5
Mass.....	5
Time.....	5
Temperature.....	5
Gravity Panel.....	5
Enable.....	5
Gravity X, Y Z.....	6
Animate Property.....	6
Keying Sets Panel.....	6
Keying Set List.....	6
Add / Remove Keying Set.....	7
Description.....	7
Export to file.....	7
Active Keying Set.....	7
Paths.....	7
Add / Remove Paths.....	7
Target ID Block.....	7
Data Path.....	8
Array all Items.....	8
FCurve Grouping.....	8
Keyframe Settings.....	8
Only Needed.....	8
Visual Keying.....	8
XYZ=RGB Colors.....	8
Audio Panel.....	8
Volume.....	9

Animate Property.....	9
Distance Model.....	9
Doppler Speed.....	9
Doppler Factor.....	9
Update Animation Cache.....	9
Rigid Body World Panel.....	9
Activate.....	9
Activate / Remove Rigid Body World.....	10
Settings.....	10
Animate Property.....	10
Collection.....	10
Constraints.....	10
Speed.....	10
Split Impulse.....	10
Steps Per Second.....	10
Solver Iterations.....	10
Cache.....	10
Simulation Start / End.....	10
Bake.....	11
Calculate to Frame.....	11
Current Cache to Bake.....	11
Bake All Dynamics.....	11
Free All Bakes.....	11
Update All To Frame.....	11
Field Weights.....	11
Custom Properties Panel.....	11
Add.....	12
Edit.....	12
Remove.....	12

Scene Tab

Scenes are a way to organize your work. Usually you work with just one scene. But each .blend file can contain multiple scenes which share other data, such as objects and materials.

The scenes can be managed in the scene drop down box up right in the header.

Appending happens through the File menu / Append.

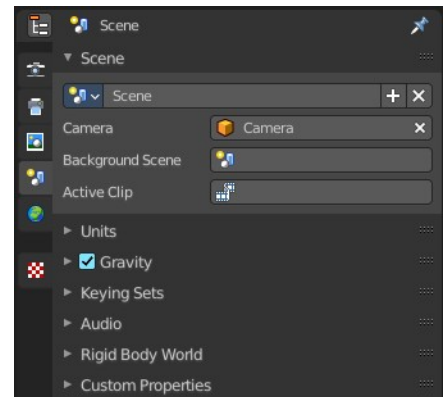

Scene Panel

Scene Data Prop

A list of the available scenes.

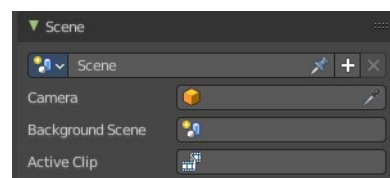

Scene Browser

A list of the available scenes.

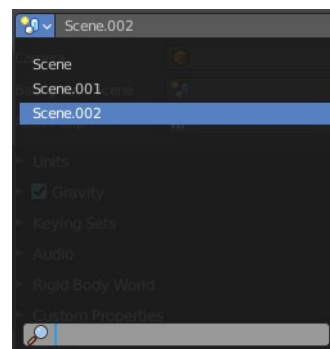

Edit Box

The name of the currently active scene.

Pin Scene to Workspace

Allows you to pin this particular scene to a workspace. So that this scene gets loaded when you enter this workspace.

New Scene

Creates a new scene. It will call a sub menu where you can choose with what settings you want to initialize the new scene.

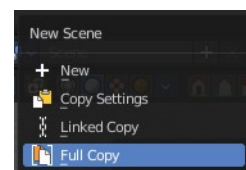

New

Creates an empty scene with default values.

Copy Settings

Creates an empty scene but also copies the settings from the active scene into the new one.

Linked Copy

This option creates a new scene with the same settings and contents as the active scene. However, instead of copying the objects, the new scene contains links to the objects in the old scene. Therefore, changes to objects in the new scene will result in the same changes to the original scene, because the objects used are literally the same. The reverse is also true.

Full Copy

Using this option, nothing is shared. This option creates a fully independent scene with copies of the active scenes contents. Every object in the original scene is duplicated, and a duplicate, private copy of its object-data is made as well.

Note

To choose between these options, it's useful to understand the difference between *Objects* and *Object Data*.

See *Duplication*.

The choices for adding a scene, therefore determine just how much of this information will be *copied from* the active scene to the new one, and how much will be *shared* (linked).

Duplicate4

Dysfunctional in this context.

Delete Scene

Deletes the currently selected scene.

Camera

Here you can define the active camera for rendering.



Background Scene

Here you can choose a background scene.

Active Movie Clip

Here you can choose an active movie clip for constraints and viewport drawing.

Units Panel

Here you define the units for the scene.

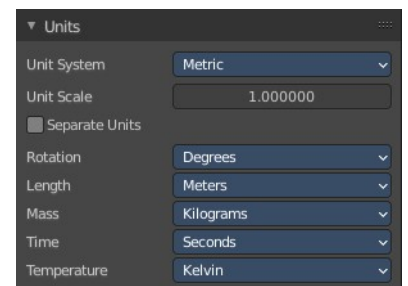

Unit System

The overall unit system that gets used.

Note that the Unit system None does just offer the Rotation option.



Unit Scale

The standard unit scale.



Separate Units

Display Units in pairs.

Rotation

Units to display on rotation. Radians or Degree.



Length

Units to display the length values.

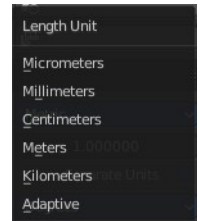

Mass

Units to display the mass values.



Time

Units to display Time values.



Temperature

Units to display temperature.

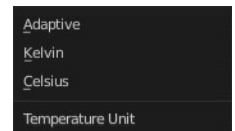

Gravity Panel

Here you can adjust the gravity settings. The default values are the standard gravity than on earth with the usual acceleration of 9.81 meters per second in Z direction.

Gravity is used for physics simulations like rigid body.

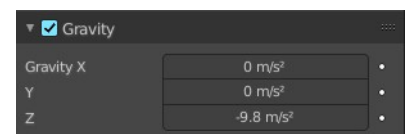

Enable

In the header is a checkbox to enable the gravity.

Gravity X, Y Z

The gravity values.

Animate Property

These properties can be animated. Activating this button sets a keyframe.

Keying Sets Panel

Keying Sets are a collection of properties. They are used to keyframe multiple properties at the same time.

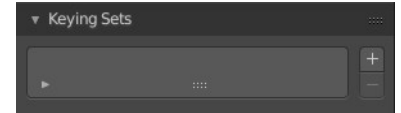

There are some built in Keying Sets, and also custom Keying Sets called *Absolute Keying Sets*.

This panel here is used to add, select and manage Absolute Keying sets.

When you add a custom keying set in the list box, then you will reveal further options.

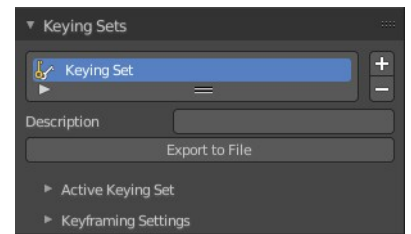

Every keying set that you add here is also available in the list of active keying sets in the header of the timeline editor.

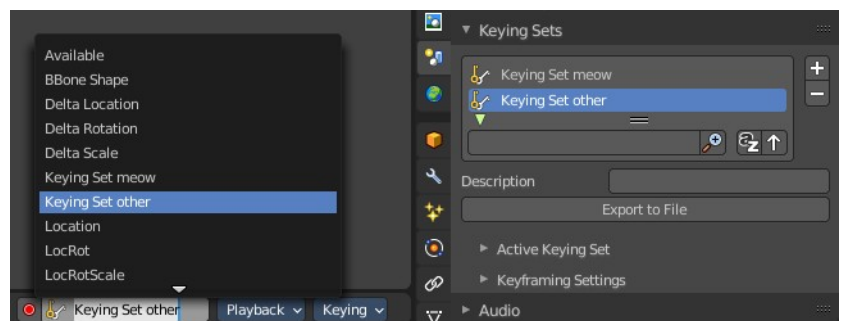

Keying Set List

Here you can see the list of your Absolute Keying Sets. The active keying set is highlighted in blue.

It has a search form below the list. Click the arrow button down left to expand the search.

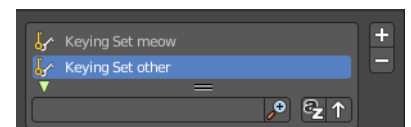

The list display can be resized by clicking at the dotted area and drag it up or down.

Add / Remove Keying Set

At the right side you can add or remove a keying set with the + and - buttons



Description

Here you can add a description to your keying set.

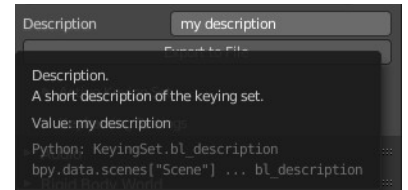

Export to file

Here you can export the keying set to a Python file.

To re add the keying set from the *File.py*, open then run the *File.py* from the Text Editor.

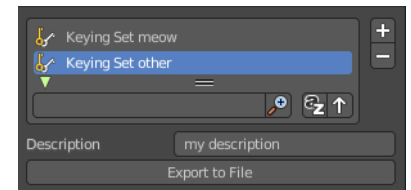

Active Keying Set

Here you can add properties to the active keying set.

Paths

A list with a collection of *Paths* each with a *Data Path* to a property to add to the active Keying Set. The active *Path* is highlighted in blue.

It has a search form below the list. Click the arrow button down left to expand the search.

The list display can be resized by clicking at the dotted area and drag it up or down.

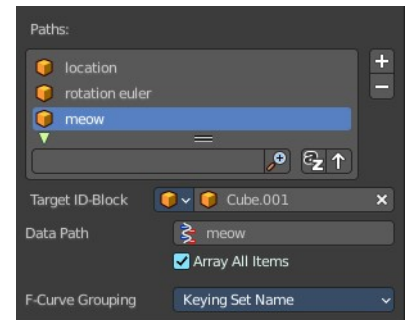

Add / Remove Paths

At the right side you can add or remove a keying set with the + and - buttons



Target ID Block

Set the *ID-Type* + *Object ID Data Path* for the property. Means pick the object or data type that you want to influence here. When it is a mesh object then you should choose mesh here.

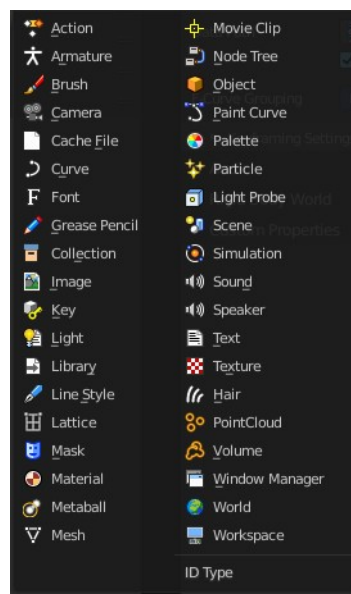

At the left you have a list of the available ID Types. At the right you have a picker as long as you haven't defined the object where you want to use this property at. Use this picker to pick up the object.

Or choose your mesh object from the list of scene objects.

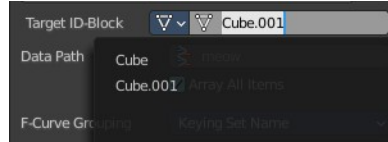

Data Path

Here you can assign a data path variable. This variable points to a python animation property that can be used for the mesh object. Location or rotation euler are valid terms for a mesh object. meow not. It will simply not work. For the available properties for the different object types please have a look in the python API.

Array all Items

For an Array / Vector type, use *All Items* from the *Data Path* or select the array index for a specific property.

FCurve Grouping

This controls what *Group* to add the *Channels* to. *Keying Set Name*, *None*, *Named Group*.

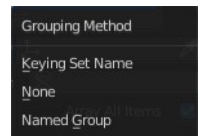

Keyframe Settings

General Override and Active Set Override have the same items each. General override works for all keying sets. Active sets just overrides the current active keying set.

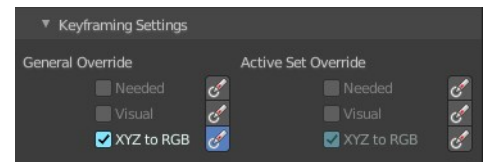

The check boxes activates the item to make it available. The buttons behind sets the item on or off.

Only Needed

Only insert keyframes where they're needed in the relevant F-Curves.

Visual Keying

Insert keyframes based on the visual transformation.

XYZ=RGB Colors

For new F-Curves, set the colors to RGB for the property set, Location XYZ for example.

Audio Panel

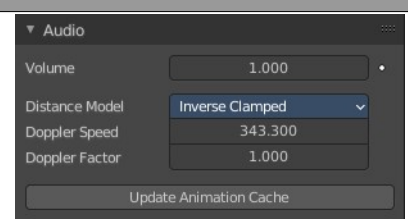

Here you can adjust the general audio settings.

Volume

The Audio Volume.

Animate Property

This property can be animated. Clicking at the button will set a keyframe at the current frame position.

Distance Model

The algorithm for attenuation calculation.

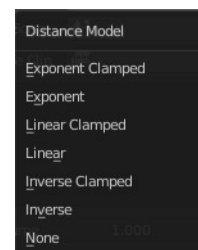

Doppler Speed

Speed of sound for Doppler effect calculation.

Doppler Factor

Pitch factor for Doppler effect calculation.

Update Animation Cache

Update the audio animation cache. Something that you might want to do after changes at the settings.

Rigid Body World Panel

The rigid body world is a group of Rigid Body objects, which holds settings that apply to all rigid bodies in this simulation.

When you add Rigid Body physics on an object, primary there is created a group of objects with default “RigidBodyWorld” name. Rigid body objects automatically are added to this group when you add Rigid Body physics for them.

You can create several Rigid Body World groups, and allocate the Rigid Body objects with Groups panel in Object context.

Rigid body objects and constraints are only taken into account by the simulation if they are in the groups specified in Group field of the Rigid Body World panel in the Scene context.

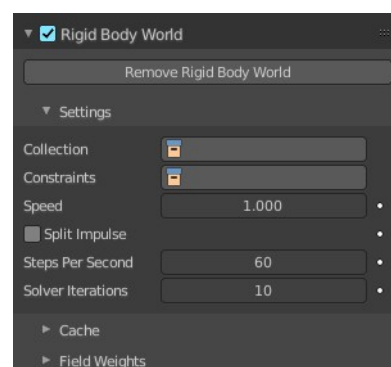

Activate

In the header is a checkbox where you can enable or disable the Rigid Body World.

Activate / Remove Rigid Body World

Activate or Remove Rigid Body simulation from the current scene.

Settings

A sub menu with further settings.

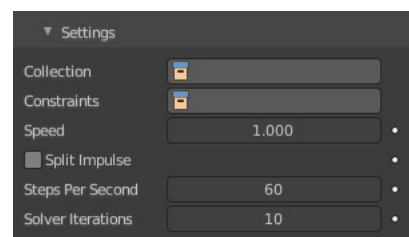

Animate Property

The properties with an animate property at the right can be animated. Clicking at the button will set a keyframe at the current frame position.

Collection

Containing rigid body objects participating in this simulation.

Constraints

Containing rigid body object constraints participating in the simulation.

Speed

Can be used to speed up/slow down the simulation.

Split Impulse

Enable/disable reducing extra velocity that can build up when objects collide (lowers simulation stability a little so use only when necessary). Limits the force with which objects are separated on collision, generally produces nicer results, but makes the simulation less stable (especially when stacking many objects).

Steps Per Second

Number of simulation steps made per second (higher values are more accurate but slower). This only influences the accuracy and not the speed of the simulation.

Solver Iterations

Amount of constraint solver iterations made per simulation step (higher values are more accurate but slower). Increasing this makes constraints and object stacking more stable.

Cache

A sub menu with cache settings. The cache is getting used for animation.

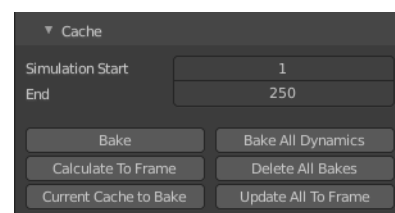

Simulation Start / End

First and last frame of the simulation.

Bake

Calculates the simulation and protects the cache. You need to be in Object mode to bake.

Calculate to Frame

Bake physics to current frame.

Current Cache to Bake

Bake from Cache.

Bake All Dynamics

Bake all physics.

Free All Bakes

Free all baked caches of all objects in the current scene.

Update All To Frame

Update cache to current frame.

If you haven't saved the blend file, the cache is created in memory, so save your file first or the cache may be lost.

Field Weights

With force fields you can influence rigid body objects in physics simulations. Every force field has its own local settings, which can be adjusted in the physics panel. Here you can adjust the general field weights for those forces.

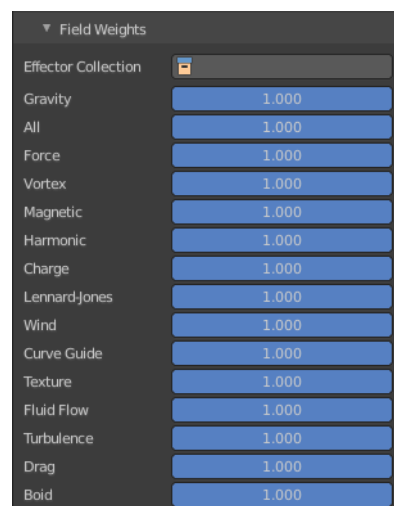

Custom Properties Panel

Here you can define custom properties that can be used for scripting.

Here you might also find custom properties from addons or scripts.

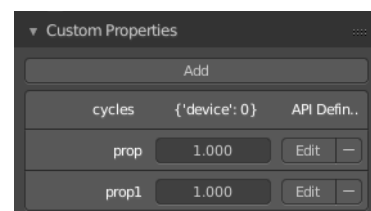

Add

Adds a new property.

Edit

Opens a panel where you can adjust the settings for the custom property.

Remove

Removes the property.

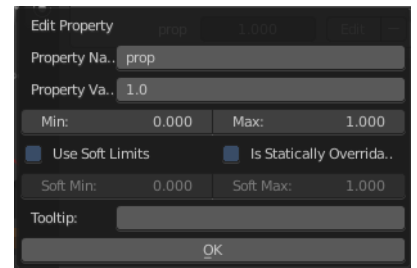



26.6 Editors - Properties Editor - World Properties Tab

Table of content

World Tab.....	2
World Data Prop.....	2
World Browser.....	2
World Edit Box.....	2
Fake User.....	2
New.....	2
Remove.....	2
Viewport Display - All Renderers.....	2
Color.....	3
Animate Property.....	3
Custom Properties Panel - All Renderers.....	3
Add.....	3
Edit.....	3
Remove.....	3
Surface Panel - Eevee and Cycles.....	3
Use Nodes.....	3
Color without nodes.....	3
Surface.....	4
Cycles - Preview Panel.....	4
Eevee and Cycles - Volume Panel.....	4
Cycles - Ambient Occlusion Panel.....	5
Enable.....	5
Factor.....	5
Distance.....	5
Cycles - Ray Visibility Panel.....	5
Camera.....	5
Diffuse.....	5
Glossy.....	5
Transmission.....	5
Volume Scatter.....	5
Cycles - Settings Panel.....	5
Surface.....	6
Sampling.....	6
Map Resolution.....	6
Max Bounces.....	6
Volume.....	6
Sampling.....	6
Interpolation.....	6
Homogeneous.....	6
Step Size.....	6

World Tab

The world tab provides you with world settings. Like Viewport Display color.

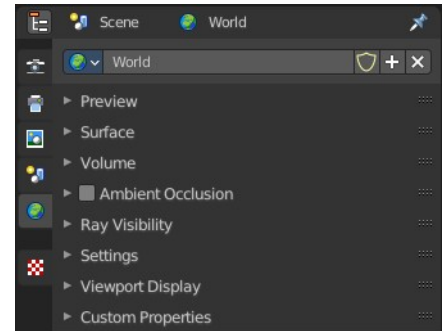
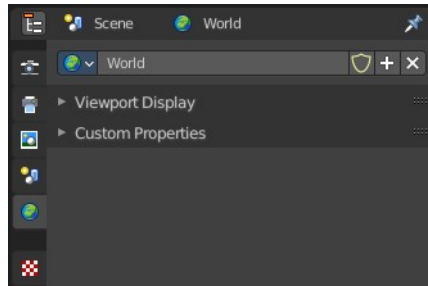
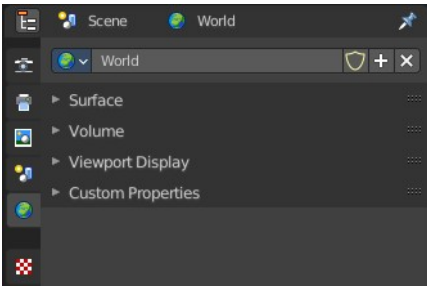

The content vary, dependent of the chosen renderer. From left to right: Eevee, OpenGL, Cycles.

World Data Prop

Here you can manage and change your world settings. There can be more than one World.

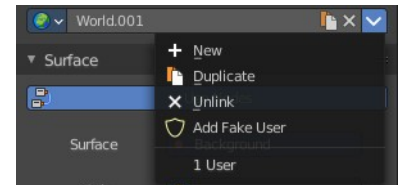

World Browser

Here you can see and choose your world files.

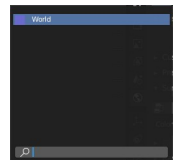

World Edit Box

Here you can see and change the name of the current world file.

Fake User

When enabled then this world file will be stored internally. And will remain in the scene.

New

Create a new world file.

Remove

Note that this just sets the World file inactive. It is still in the list. You can delete the world file when it has no user anymore by saving the scene, closing and reopening Bforartists.

Viewport Display - All Renderers

Color

The color that you can choose here is the background color for rendering the image.

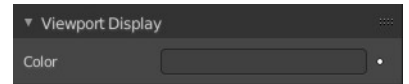
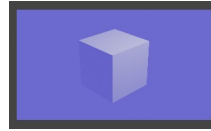

Animate Property

This property can be animated. Activating this button sets a keyframe.

Custom Properties Panel - All Renderers

Here you can define custom properties that can be used for scripting.

Here you might also find custom properties from addons or scripts.

Add

Adds a new property.

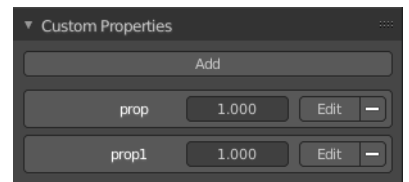

Edit

A panel where you can adjust the settings for the custom property.

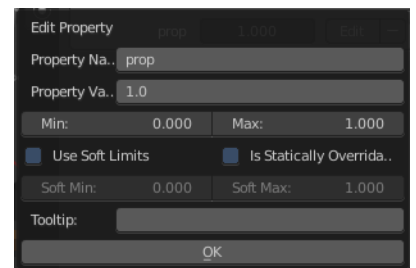

Remove

Removes the property.

Surface Panel - Eevee and Cycles

Use Nodes

Use Nodes or simple background color.

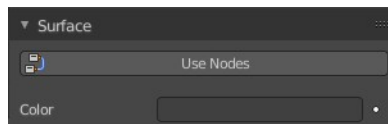

When you use Nodes then you will reveal further options.

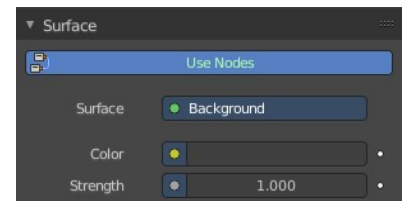

Note that Cycles misses the Use Nodes button once you have activated the nodes.

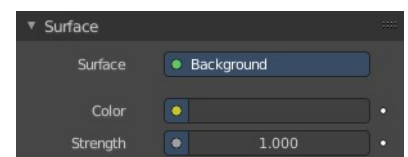

Color without nodes

The color that you can choose here is the background color for rendering the image.

Surface

Here you can choose what shader you want to use for the background. Usually the Background shader. But you can use any shader in the list here too.

The options below changes dependent of the shader that you choose. They are explained in the shader editor chapter.

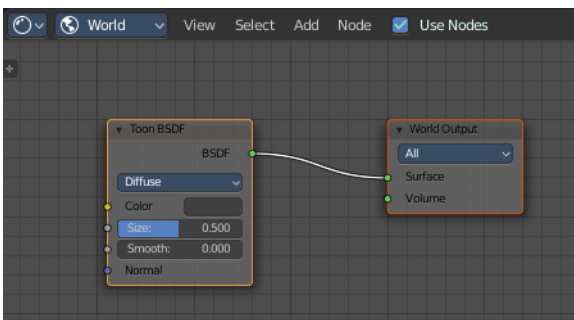
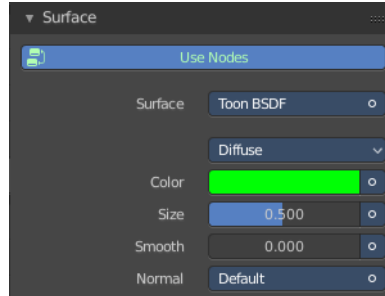
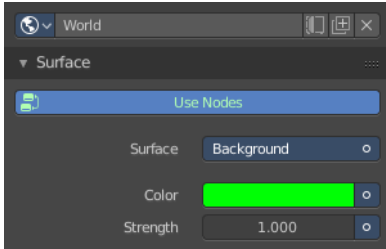
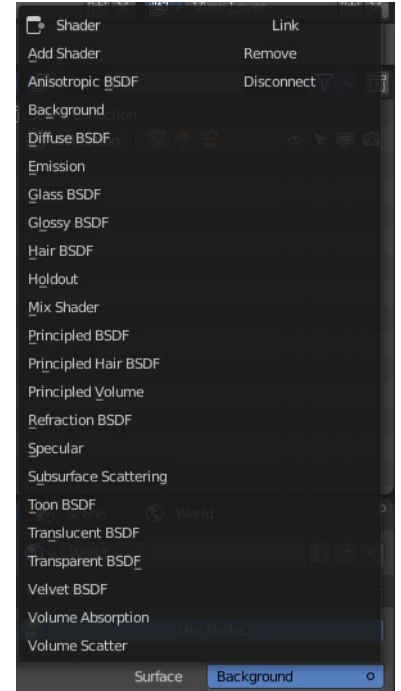

Cycles - Preview Panel

The Preview panel gives you a preview of the background color.

The color can also be an image. This depends of what you have chosen for the color method in the surface panel.

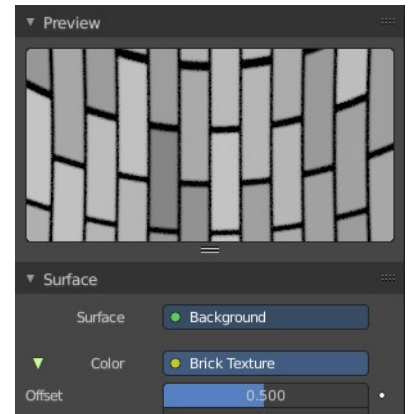
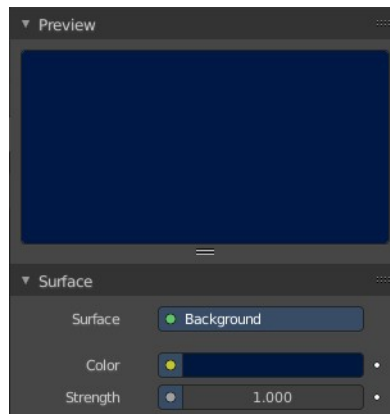

Eevee and Cycles - Volume Panel

This panel just appears when you tick Use Nodes.

Volume rendering is a method to render light as it passes through a media within a 3D region. Here you can choose a shader for volume rendering.

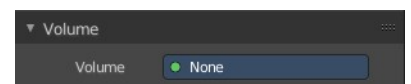

Cycles - Ambient Occlusion Panel

Ambient Occlusion is a method to self shadow surfaces in corners. The closer the faces to each other, the darker they get.

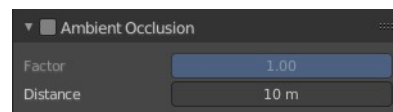

Enable

In the header is a checkbox to enable Ambient Occlusion.

Factor

The factor for ambient occlusion blending.

Distance

The maximum distance at which Ambient Occlusion gets calculated.

Cycles - Ray Visibility Panel

Here you can adjust the ray visibility.

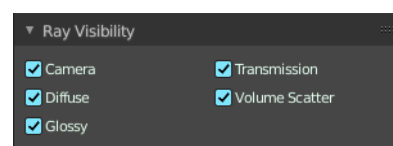

Camera

Object Visibility for Camera rays.

Diffuse

Object Visibility for Diffuse Reflection rays.

Glossy

Object Visibility for Glossy Reflection rays.

Transmission

Object Visibility for Transmission rays.

Volume Scatter

Object Visibility for Volume Scatter rays.

Cycles - Settings Panel

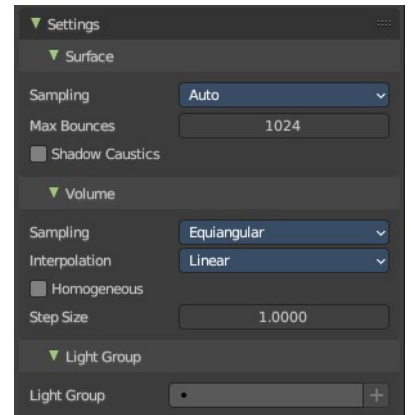

Surface

Sampling

Here you can choose the method for the surface sampling.

Map Resolution

Just with method manual. Adjust the map resolution manually.

Max Bounces

Maximum number of bounces the background light will contribute to the render.

Shadow Caustics

Generate caustics in the shadows of refractive surfaces.

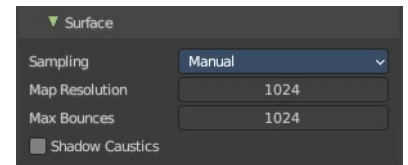
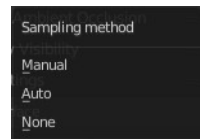

Volume

Sampling

Here you can choose the volume sampling method.

Interpolation

Here you can choose between cubic and linear interpolation.

Homogeneous

When using volume rendering, assume that the volume has the same density everywhere.

Step Size

Distance between volume shader samples when rendering the volume. Lower values increases accuracy and render time.

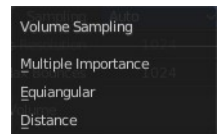

Light Group

Manage the light groups that you want to use in the world settings.

Light group allows you to save light settings into layers. This enables you to adjust the lighting afterwards in compositing for example.

You need to have a lightgroup in the scene. You create them in the View Layer Properties tab in the Passes panel in the Light Groups subpanel.

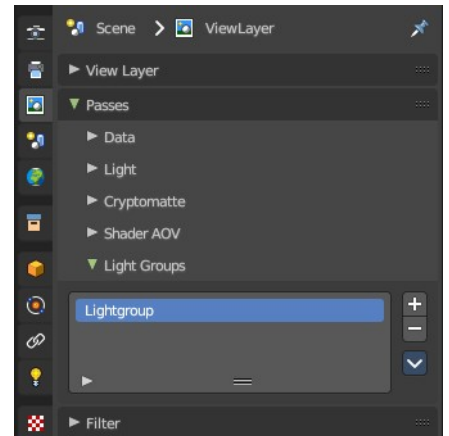



26.7 Editors - Properties Editor - Collection Properties Tab

Table of content

Collection Properties Tab.....	2
Restrictions Panel.....	2
Selectable.....	2
Disable in Renders.....	2
Holdout.....	2
Indirect Only.....	2
Instancing panel.....	2
Instance Offset.....	2
Line Art Panel.....	3
Usage.....	3
Include.....	3
Occlusion Only.....	3
Exclude.....	3
Intersection only.....	3
No Intersection.....	3
Collection Mask.....	3
Masks.....	3
Intersection Priority.....	3
Priority Value.....	3

Collection Properties Tab

The world tab provides you with collection related settings.

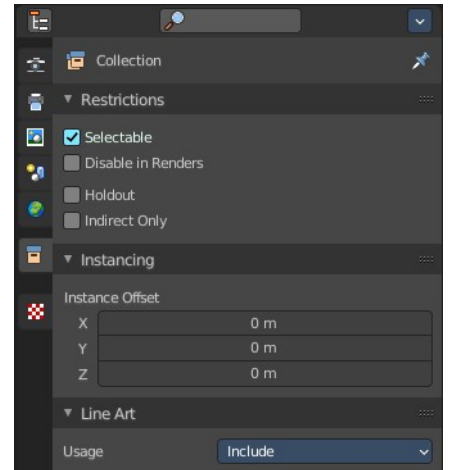

Restrictions Panel

Set restrictions for the selected collection(s).

Selectable

Make this collection and its content selectable.

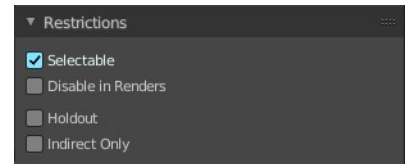

Disable in Renders

Don't render this collection and its content.

Holdout

Mask out objects in collection from view layer.

Indirect Only

Make the objects in the collection just contribute indirectly. By light or shadow or reflections.

Instancing panel

Instance Offset

Adjust an offset from the origin when instancing the collection.

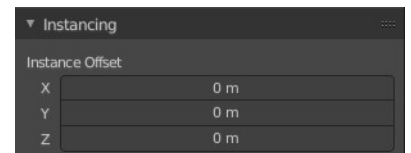

Line Art Panel

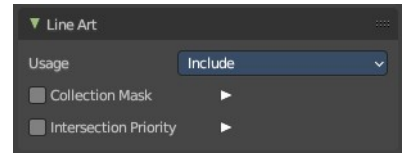

Usage

The method to display the line art in this collection.

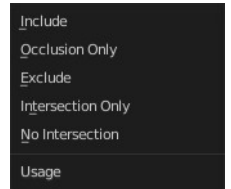

Include

Generate feature lines for this collection.

Occlusion Only

Only use the collection to produce occlusion.

Exclude

Don't use this collection in line art.

Intersection only

Only generate intersection lines for this collection

No Intersection

Include this collection but do not generate intersection lines.

Collection Mask

Use custom intersection masks for faces in this collection.



Masks

You can use up to 8 masks, starting with value 0.

Intersection Priority

Assign intersection priority value for this collection.



Priority Value

The intersection line will be included into the object with the higher intersection priority value.



26.8 Editors - Properties Editor - Object Properties Tab

Table of content

Detailed table of content.....	1
Object Tab.....	5
Object Data Prop.....	5
Transform Panel.....	6
Relations Panel.....	7
Collections Panel.....	8
Instancing Panel.....	10
Motion Paths Panel.....	13
Motion Blur Panel - Cycles.....	15
Shading - Cycles.....	15
Visibility Panel - Eevee and Workbench.....	17
Visibility Panel - Cycles.....	18
Line Art Panel.....	19
Viewport Display Panel.....	19
Custom Properties Panel.....	22

Detailed table of content

Detailed table of content

Detailed table of content.....	1
Object Tab.....	5
Object Data Prop.....	5
Object browser.....	5
File selector menu.....	5
Transform Panel.....	6
Location.....	6
Rotation.....	6
Rotation Mode.....	6
Quaternion.....	6
Scale.....	6
Lock.....	6
Animate Properties.....	7
Delta Transform.....	7
Delta Location.....	7
Delta Rotation.....	7
Delta Scale.....	7
Lock.....	7
Animate Properties.....	7
Relations Panel.....	7
Animate Properties.....	7
Parent.....	8
Parent Type.....	8
Parent Bone.....	8
Camera Parent Lock.....	8

Tracking Axis.....	8
Up Axis.....	8
Pass Index.....	8
Collections Panel.....	8
Link to existing collection.....	8
Add to new Collection.....	9
Collection.....	9
Collection Name.....	9
Remove.....	9
Collections Menu.....	9
Delete.....	9
Select Objects in Collection.....	10
Set Offset From Cursor.....	10
Offset.....	10
Instancing Panel.....	10
None.....	10
Instanceverts.....	10
Workflow:.....	10
Instanceverts Tools.....	11
Animate Property.....	11
Align to Vertex Normal.....	11
Show Instancer.....	11
Viewport.....	11
Render.....	11
Dupliface.....	11
Workflow:.....	12
Instance Face Tools.....	12
Animate Property.....	12
Show Instancer.....	12
Viewport.....	12
Render.....	12
Scale by Face Size.....	12
Factor.....	13
Motion Paths Panel.....	13
Workflow:.....	13
Motion Paths Tools:.....	13
Paths Type.....	13
In Range.....	13
Frame Range Start.....	13
End.....	13
Step.....	13
Around Frame.....	14
Frame Range before.....	14
After.....	14
Step.....	14
Calculation Range.....	14
All Keys.....	14
Selected Keys.....	14
Scene Frame Range.....	14
Manual Range.....	14
Cached range.....	14
Update Paths.....	14
Update All Paths.....	14

Delete Paths.....	14
Display.....	15
Frame Numbers.....	15
Keyframes.....	15
Keyframe Numbers.....	15
Lines.....	15
Thickness.....	15
Custom Color.....	15
Motion Blur Panel - Cycles.....	15
Shading - Cycles.....	15
Shadow Terminator subpanel.....	16
Geometry Offset.....	16
Shading Offset.....	16
Fast GI Approximation subpanel.....	16
AO Distance.....	16
Caustics subpanel.....	16
Cast Shadow Caustics.....	16
Receive Shadow Caustics.....	17
Light Group Subpanel.....	17
Visibility Panel - Eevee and Workbench.....	17
Animate property.....	17
Show In.....	18
Viewports.....	18
Renders.....	18
Grease Pencil.....	18
Use Lights.....	18
Mask.....	18
Holdout.....	18
Visibility Panel - Cycles.....	18
Animate property.....	18
Show in.....	18
Viewports.....	18
Renders.....	18
Ray Visibility Subpanel.....	18
Culling.....	19
Use Camera Cull.....	19
Use Distance Cull.....	19
Line Art Panel.....	19
Usage.....	19
Override crease.....	19
Crease.....	19
Viewport Display Panel.....	19
Animate property.....	20
Show.....	20
Name.....	20
Axis.....	20
Wireframe.....	20
All Edges.....	20
Texture Space.....	20
Shadow.....	21
In Front.....	21
Color.....	21
Display As.....	21

Bounds.....	21
Display Bounds Type.....	21
Custom Properties Panel.....	22
Add.....	22
Edit.....	22
Remove.....	22

Object Tab

The Object tab contains all general object related settings like Transform, Relation or Collection related things. Cycles has two more panels.

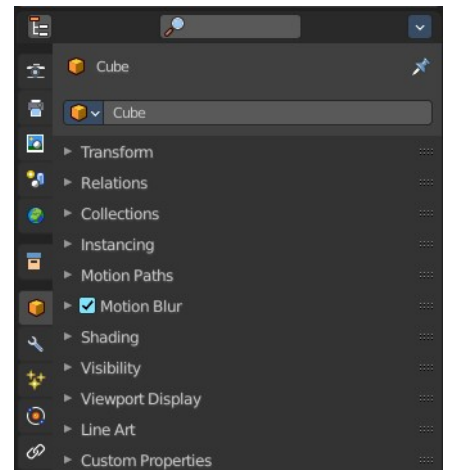
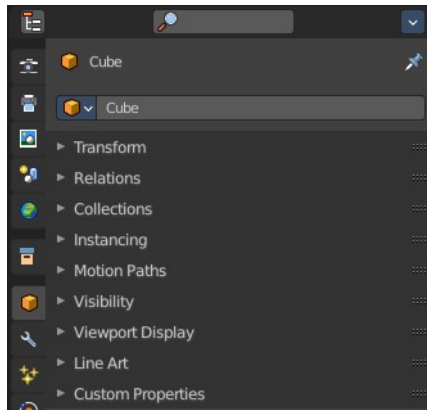

Object Data Prop

Displays what object is currently selected.

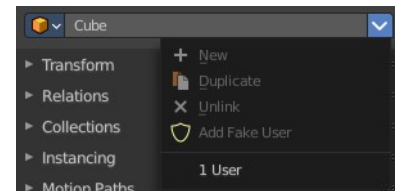

Object browser

A list of the objects in the scene. In this list you can also choose another object. And you can rename the object.

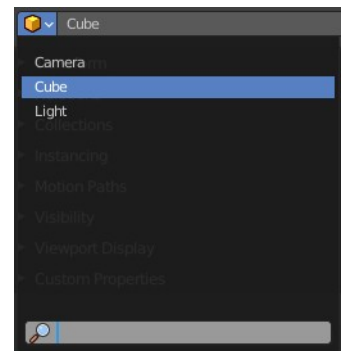

File selector menu

This menu has no meaning in this context. All menu items are disabled.

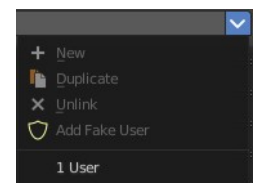

Transform Panel

Transform is position, rotation and scale of the object. It is partially the same content that you see in Object mode in the Properties sidebar in the 3D view.

However, when you switch to Edit mode, with a Bone for example, then you will still have the overall world transform values for the object here, while the Transform panel in the Properties sidebar now displays the edit transform values for the bone.

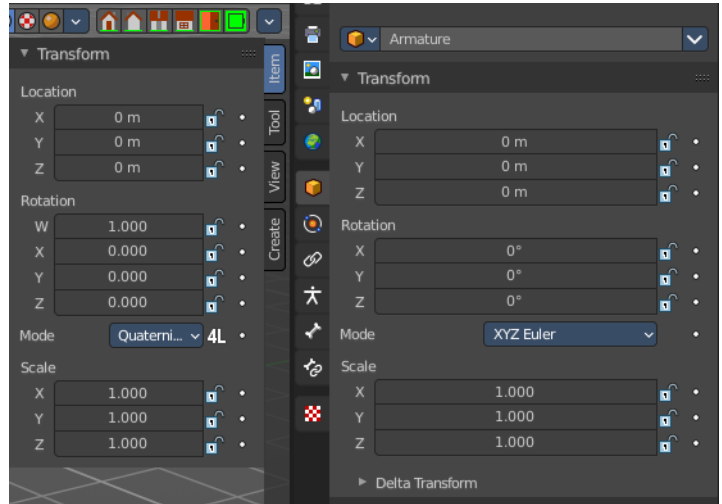

Location

The location of the object.

Rotation

The rotation of the object.

Rotation Mode

The rotation mode. Euler angles are fine for most needs. But sometimes you want to use Quaternion to avoid gimbal lock. Gimbal lock is a mathematical problem where the rotation locks up in two instead of three degrees of freedom.



Quaternion

With euler angles you will have three values available. But with a quaternion you will have four values available. And quaternions reveals a 4L button. This button shows or hides a lock behind the W value. Normally a quaternion has just three locks, one for each of the single axis. The W value is a mathematical construct from the three object axis. And you usually neither want to edit it nor to lock it therefore.

Locking the W axis will lock all axis.

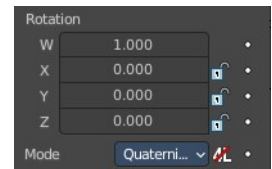
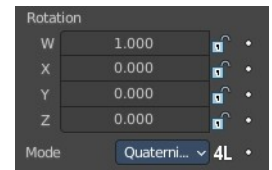

Scale

The scale of the object.

Lock

This properties can be locked.

Animate Properties

This properties can be animated. Activating the Animate Property button sets a keyframe.

Delta Transform

Transforms are absolute to the world coordinates. Delta Transforms are relative to the current transformation.

Adjust the delta transforms.

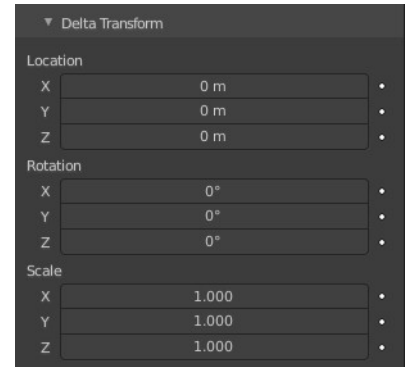

Delta Location

The delta location of the object.

Delta Rotation

The delta rotation of the object.

Delta Scale

The delta scale of the object.

Lock

This properties can be locked.

Animate Properties

This properties can be animated. Activating the Animate Property button sets a keyframe.

Relations Panel

Set up and adjust relations for the object.

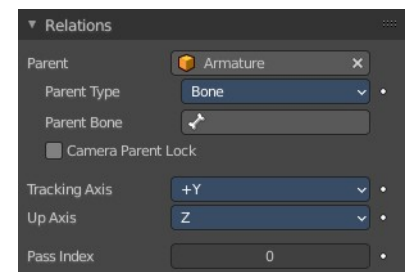
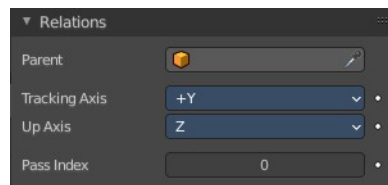

Animate Properties

The properties with the Animate Property at the right can be animated. Activating the Animate Property button sets a keyframe.

Parent

Set a parent object. One way is by the object picker at the right. Or choose the object in the list. This list appears by clicking at the edit box.

Parent Type

See and set the parent type.

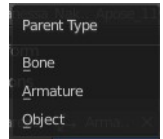

Parent Bone

When you parent an object to an armature then you can choose to which bone you want to parent this object.

Camera Parent Lock

When the camera is locked to the view and in fly mode, transform the parent rather than the camera.

Tracking Axis

The axis that points in forward direction.



Up Axis

The axis that points in the up direction.



Pass Index

The index number for the "Object Index" render pass.

Collections Panel

Collections is a bunch of data, objects, cameras, lights, etc., which you can manage in some ways at once. You can for example hide complete collections, include or exclude it from rendering, instance them, and so on.

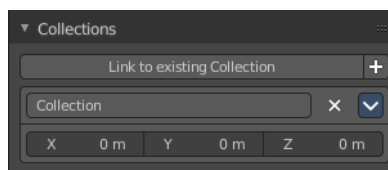

An object must be at least in one collection. Or it gets deleted. But an object can be in multiple collections. This panel allows you to manage in what collection(s) the object is.

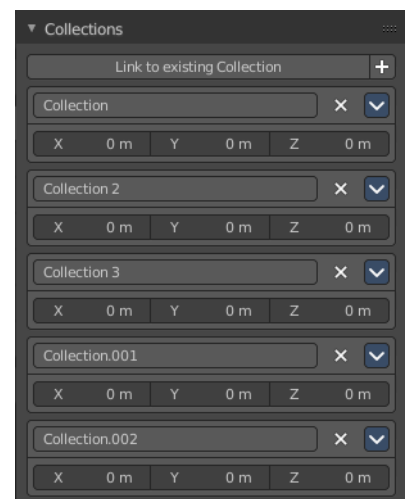

Link to existing collection

A drop down box where you can choose the collection that you want to add the object to. Different from the Link to collection tool in the outliner, this

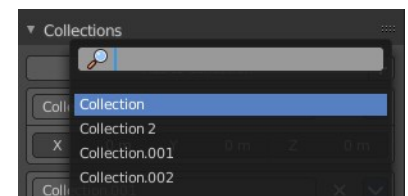

tool lists all collections in the Blender file. Also collections that are not to see in the Scenes or View Layer view.

Add to new Collection

At the end of the Add to Collection element is a + button where you can create more collections.

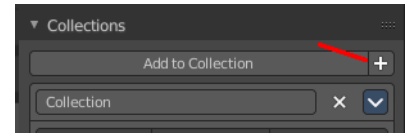

Note that this new created collection is not part of the scene. But shows just at the Blend file level in the outliner. So when you want to create a collection that is accessible from the scene, then create the collection in the outliner instead.

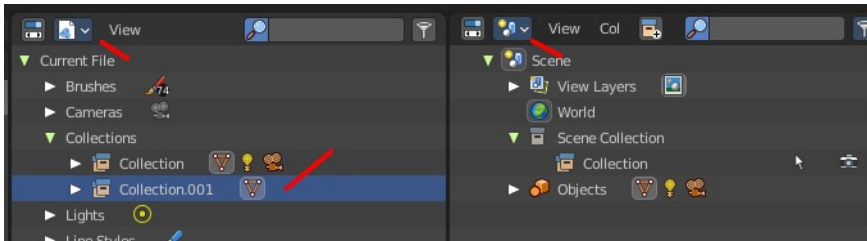

Collections at the scene levels usually gets created with the name Collection + space + single Number.

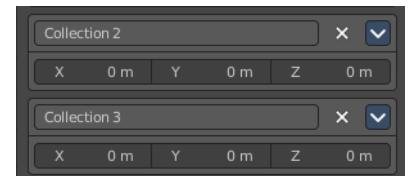

Collections at the Blend file level gets created with Collection + dot + three digit number

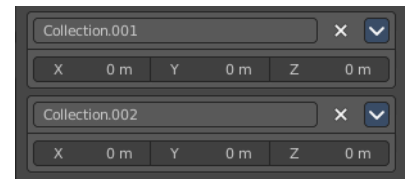

Collection

This is the collection where the object is currently assigned at. As told, an object can be assigned to more than one collection.

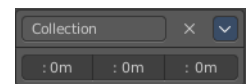

Collection Name

Read and edit the collection name.

Remove

This deletes the collection from the object. Note that the collection still exists.

Collections Menu

Delete

This deletes the collection from the object. Note that the collection still exists.

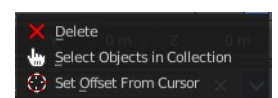

Select Objects in Collection

Selects all objects in the collection.

Set Offset From Cursor

Set offset used for collection instance based on cursor position. Normally the offset is based at the center of the world when instancing, at 0/0/0. When you choose Set Offset From Cursor then this offset is set form the cursor position instead of the world center.

Offset

Offset from the origin to use when instancing.

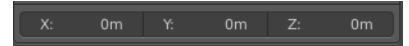

Instancing Panel

Here you find settings for instancing. Instancing means the object exists just one time in ram, and gets reused.

Instancing requires a special setup.

The duplicated geometry by this method are instances of the parent object. And so they cannot be threaten like real objects.

To turn them into editable geometry go to Object menu, and choose Apply / Make Duplicates real.

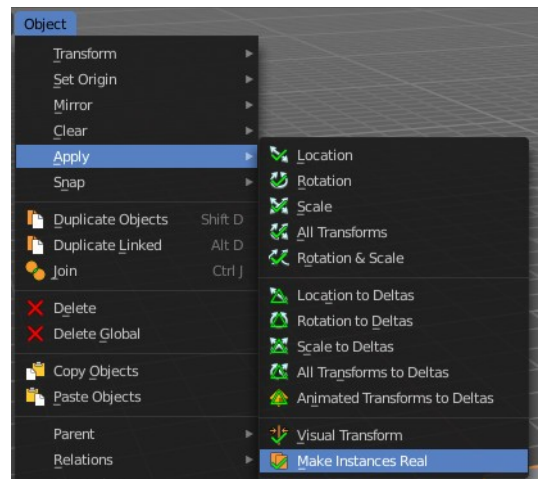
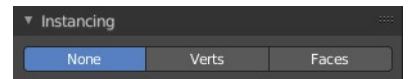

None

No duplication happens.

Instanceverts

InstanceVerts is the duplication of a base object at the location of the vertices of a mesh. In other words, an instance of the base object is placed on every vertex of the mesh.

Workflow:

Create a cube, create a sphere. For demonstration purposes, move the sphere a bit off. Parent the sphere to the cube. Cube

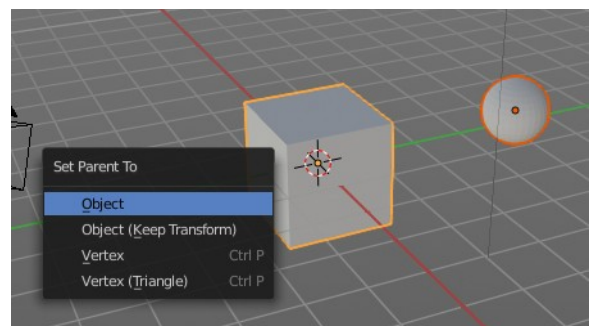

must be the parent, sphere the child.

Select just the cube. In the Duplication Panel enable Verts.

As a result you will now have eight spheres around the child sphere, since the cube has eight vertices. The center point is the sphere.

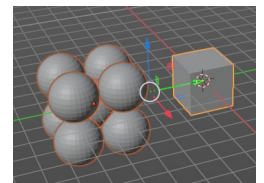
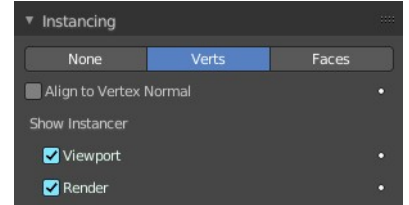

Instanceverts Tools

Animate Property

The properties with the Animate property at the right can be animated. You create a keyframe by clicking at it.

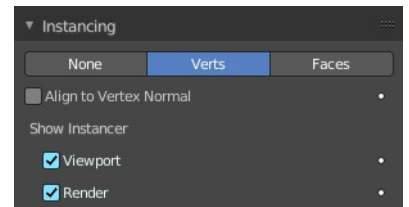

Align to Vertex Normal

Orients the child objects along the normals of the parent vertices.

Show Instancer

Viewport

Show the instance object in the viewport.

Render

Show the instance object in the final rendering.

Dupliface

DupliFaces replicates an object on each face of a parent object, using the initial child object as the center. The faces of the parent object is the pattern that gets used as the pattern to create the duplicated objects. The child object gets used as the center point, and of course to duplicate the geometry from.

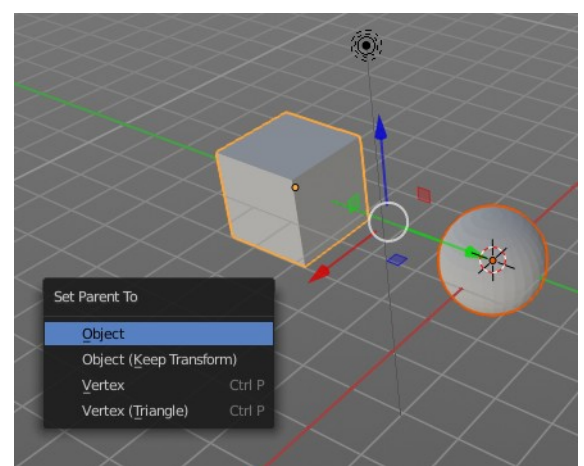

Workflow:

Create a cube, create a sphere. Move the cube a bit off. Parent the sphere to the cube (select sphere, hold down shift, select cube, press ctrl p). Cube must be the parent, sphere the child.

In the Duplication Panel enable Faces.

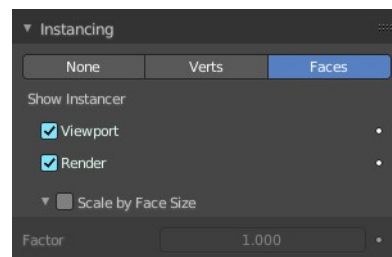

As a result you will now have six spheres at the child sphere, since the cube has six sides.

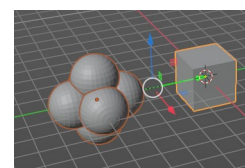

Note

The location, orientation, and scale of the duplicated child(ren) matches that of the faces of the parent. So, if several objects are parented to the cube, they will all be duplicated once for each face on the cube. If the cube is subdivided, every child will be duplicated for each face on the cube.

Instance Face Tools

Animate Property

The properties with the Animate property at the right can be animated. You create a keyframe by clicking at it.

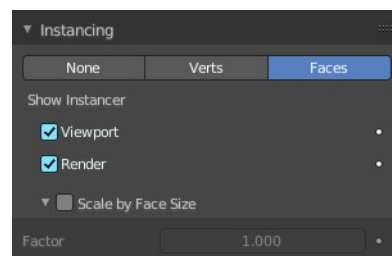

Show Instancer

Viewport

Show the instance object in the viewport.

Render

Show the instance object in the final rendering.

Scale by Face Size

When you tick scale by face size then you can control the size of the child objects.

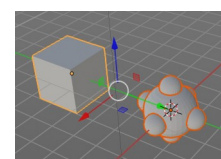

With Scale ticked you can also influence the size of the child objects by changing the parent geometry.

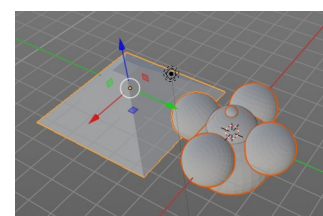

Factor

The scale factor for scale.

Motion Paths Panel

Motion paths is a visual helper to judge the motion of objects.

Motion paths are not displayed by default. They need to be calculated. This can be done here.

Workflow:

We simply need a motion animation first.
For example a moving cube.

Add a cube. Choose a keying set. Set a keyframe at let's say frame 0. Go to frame 20. Move the object. Set a keyframe at frame 20.

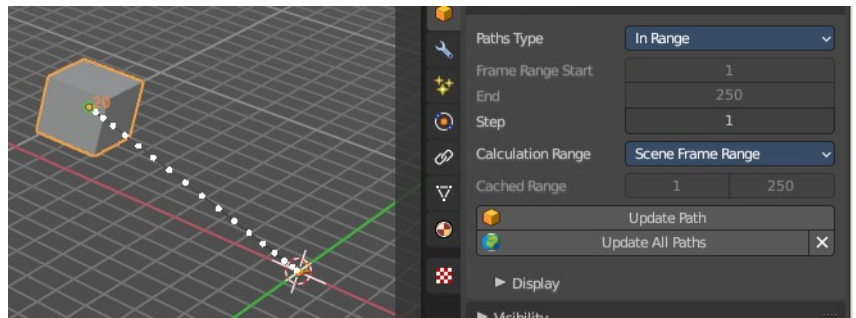

Click Calculate. You will now see the motion path of this object.

Motion Paths Tools:

Paths Type

There are two path types available. In Range and Around Frame.

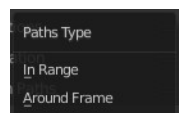

In Range

Displays the full motion path.

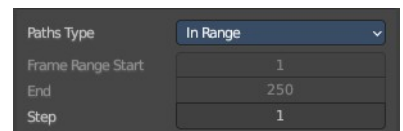

Frame Range Start

The start frame.

End

The end frame.

Step

Number of frames between paths shown.

Around Frame

Displays just the motion path around the current frame. Not the whole path.

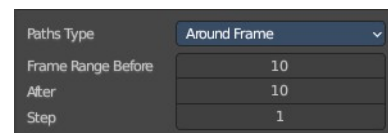

Frame Range before

The frames to display before the current frame.

After

The frames to display after the current frame.

Step

Number of frames between paths shown.

Calculation Range

The type of path range to calculate the motion paths.

All Keys

Calculate all keys. Even when they are out of the range.

Selected Keys

Calculate just selected keys.

Scene Frame Range

Calculate the entire scene / preview range.

Manual Range

Manually determine frame range.

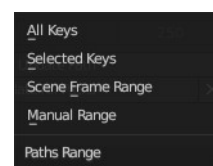

Cached range

Not editable. Internal cache information that should be hidden.

Update Paths

Update the paths after any changes at the animation. You have to update the paths too if you change settings like the paths type.

Update All Paths

Update all paths after any changes at the animation. You have to update the paths too if you change settings like the paths type.

Delete Paths

Deletes ALL motion paths caches in the scene. Hold down shift to delete just the path for the current object.

Display

Here you find some display options for the path.

Frame Numbers

Display the frame number above every knot of the motion path

Keyframes

Display the keyframes in the path as orange dots.

Keyframe Numbers

Display the keyframe number above every keyframe.

Lines

Display a line between the points.

Thickness

The line thickness.

Custom Color

Define a custom color for the motion path. A click at the color area opens a color picker.

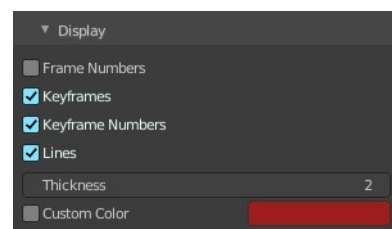

Motion Blur Panel - Cycles

The Motion Blur panel gives you further per object options for motion blur.

Note that Motion Blur needs to be active to make this options work.

You can activate Motion Blur in the render settings.

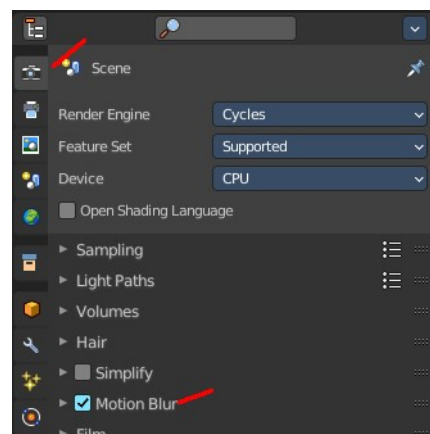

Shading - Cycles

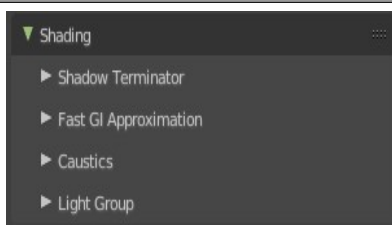

The Shading panel gives you further per object shading options with the Cycles renderer.

Note that not all objects have all subpanels. Lights does for example just contain the Light Group sub panel.

Shadow Terminator subpanel

Geometry Offset

Offset rays from the surface to minimize shadow artifacts at low poly geometry. Only affects triangles at grazing angles to light.

Shading Offset

Push the shadow terminator towards the light to minimize shadow artifacts at low poly geometry.

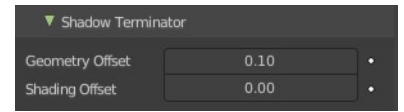

Fast GI Approximation subpanel

AO Distance

The Ambient Occlusion distance that is used for approximate Ambient Occlusion. 0 means the world settings are used.

Note that Fast GI Approximation needs to be active to make this options work.

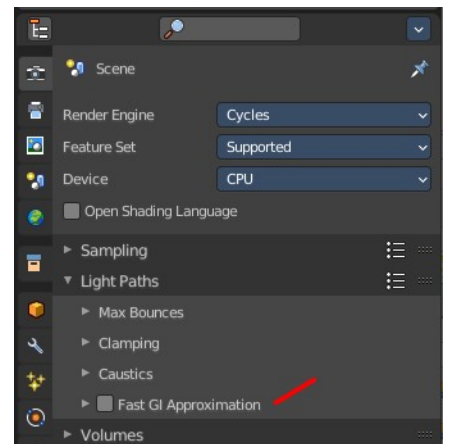
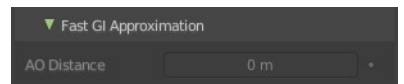

Caustics subpanel

Caustics related settings.

Cast Shadow Caustics

Generates caustics in case the material is a refractive material. Casting lights must have shadow caustics option enabled. This can be found in the object data properties in the Light panel.

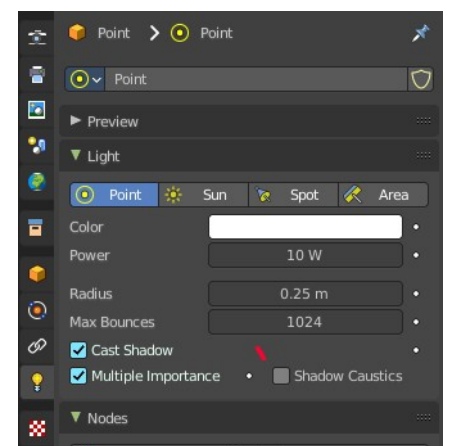
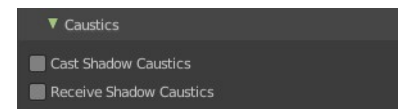

Receive Shadow Caustics

Receive caustics in case the material is a refractive material. Casting lights must have shadow caustics option enabled. This can be found in the object data properties in the Light panel.

Light Group Subpanel

Allows you to assign the current object or lamp to a light group.

You first need to create a light group in the View Layer Properties > Passes > Lightgroups panel. Then you can choose from the existing light groups.

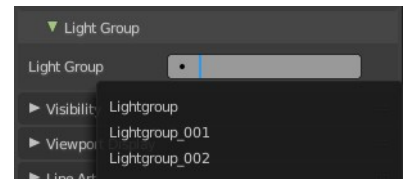
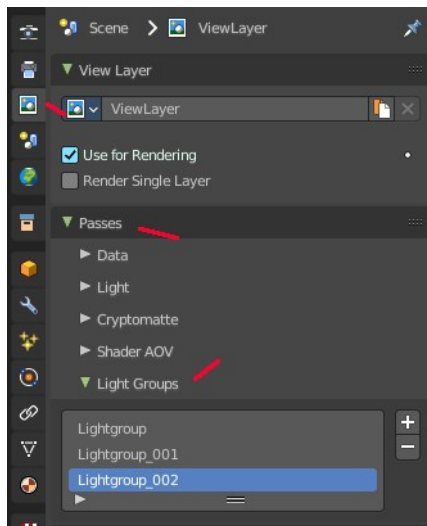

Visibility Panel - Eevee and Workbench

Show or hide options for the selected object.

Animate property

These property can be animated. Clicking at the decorator at the right sets a keyframe.

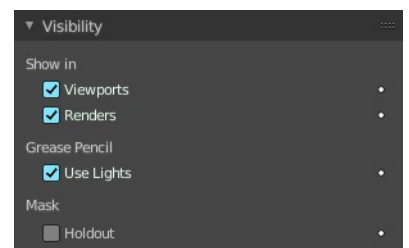

Show In

Viewports

Show the object in the viewport. This can also be done in the outliner.

Renders

Show the object in the rendering. This can also be done in the outliner.

Grease Pencil

Use Lights

Grease Pencil object only. Light affects grease pencil object.

Mask

Holdout

Render the object as a holdout or matte object. This creates a hole in the image in the shape of the object. Which can then be filled with content in the compositing process.

Visibility Panel - Cycles

Note that the content does not show with all object types. The content shown here is with a mesh object.

Show or hide options for the selected object.

Animate property

These property can be animated. Clicking at the decorator at the right sets a keyframe.

Show in

Viewports

Show the object in viewports.

Renders

Show the object in renderers.

Ray Visibility Subpanel

The object visibility for different types of rays.

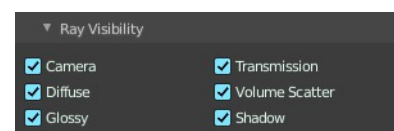
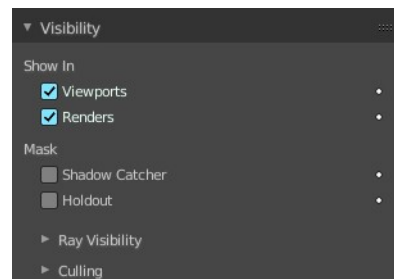

Culling

Use Camera Cull

Allow objects and its duplicates to be culled by the camera space culling.

This option is just active when Simplify in the Render tab is activated, and the camera culling in the simplify panel is ticked too.

Use Distance Cull

Allow objects and its duplicates to be culled by the specified distance.

This option is just active when Simplify in the Render tab is activated, and the camera culling in the simplify panel is ticked too.

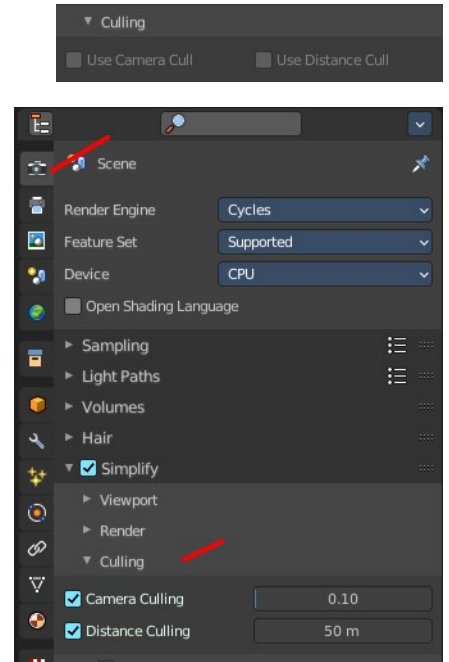

Line Art Panel

Line Art settings.

Usage

How to use this object in line art calculation. The items should be self explaining.

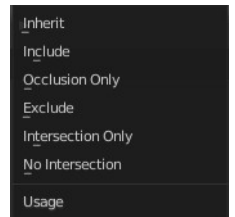
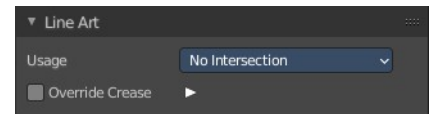

Override crease

Use this objects crease settings to override scene global.

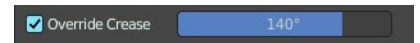

Crease

Angles smaller than this value will be treated as creases.

Viewport Display Panel

Here you will find some further display options for the object. Object name, Wire Frame in Object Mode, etc.

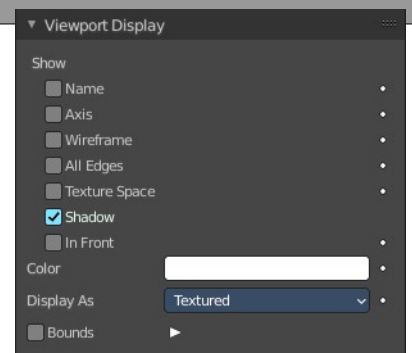

Some of these settings will override general settings. For example when you set the maximum draw type (Display as) to Wire, then it will always display as wire, regardless if you set the Viewport render method to Material or Textured.

The content is different for different object types. Mesh objects have more options than a grease pencil for example.

Note also that some objects have some further special viewport settings in other tabs. For example, Bones have also viewport settings in the Object Data properties, and in the Bone properties.

This panel here is for general viewport display settings for the objects.

Animate property

These properties can be animated. Clicking at the decorator at the right sets a keyframe.

Show

Name

Display the object name at the pivot point.

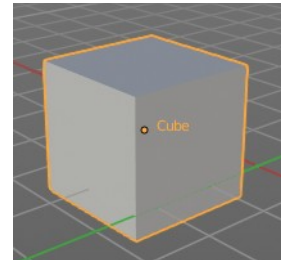

Axis

Display the objects axis. Best done with Wireframe display mode. Solid faces may hide the axis. Or tick in Front. Then the axis gets also drawn above the mesh faces.

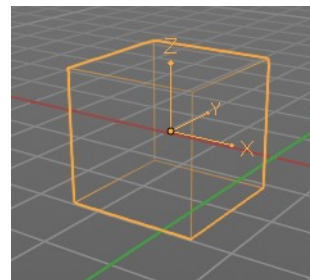

Wireframe

Display parts of the wire frame in Object Mode. See All Edges.

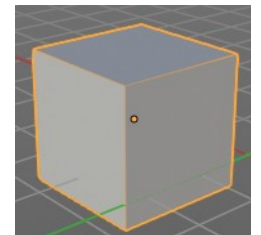

All Edges

This is a hieronymus bosch feature from Blender developers that will most probably trap you again and again. When you tick Wireframe then SOME of the edges of the object gets displayed. You need to tick all edges to display the whole Wireframe.

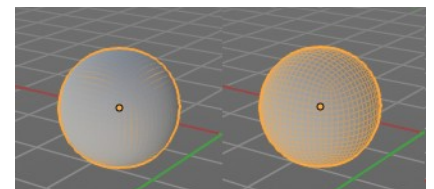

Texture Space

Display the objects texture space. This has to do with the mapping. A sphere can for example have a cubic mapping.

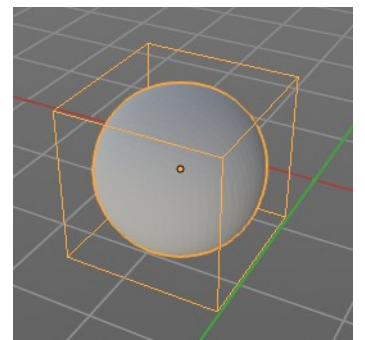

Shadow

The object should throw a shadow in the 3D view. But it seems to be dysfunctional.

In Front

X Ray. Display this object in front of all other objects.

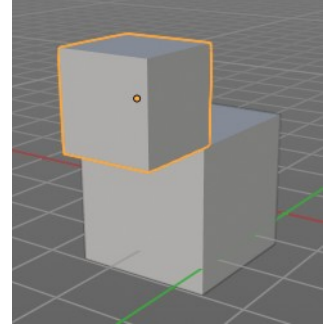

Color

Solid mode setting only.

When you set the Color type to Object in the viewport shading settings, then the object in the viewport is displayed with this color.

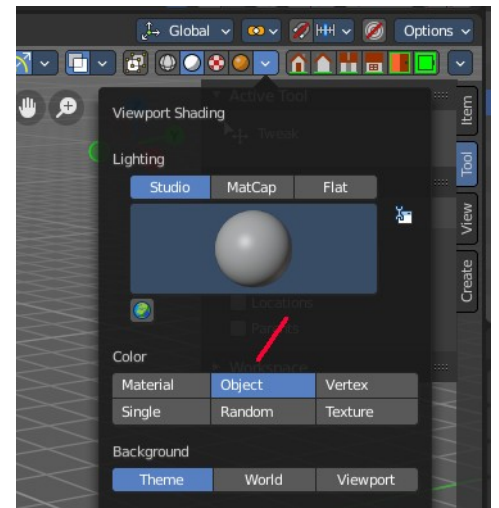
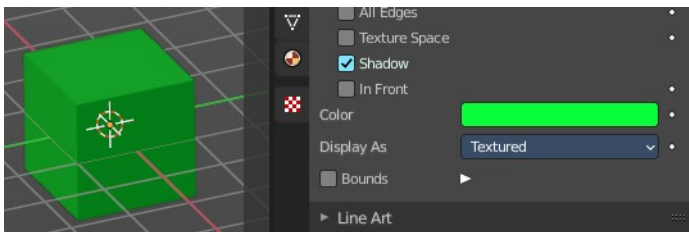

Display As

Adjust the maximum display method for the object. For example when you set the maximum draw type to Wire, then it will always display as wire, regardless if you set the Viewport render method to Material or Textured.

Bounds

Display the bounding box for this object.

Display Bounds Type

What shape to choose for the bounding box. There is more than just the classical box shape available.

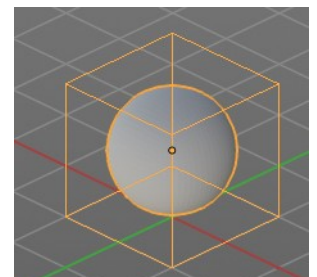
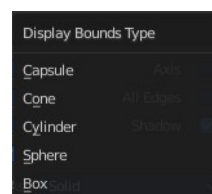

Custom Properties Panel

Define custom properties that can be used for scripting.

Here you might also find custom properties from addons or scripts.

Add

Adds a new property.

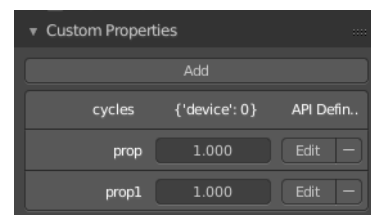

Edit

A panel to adjust the settings for the custom property.

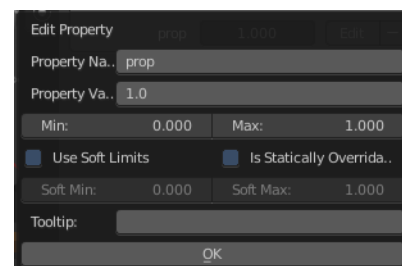

Remove

Removes the property.



26.9 Editors - Properties Editor - Modifiers Properties Tab

Table of content

25.8 Editors - Properties Editor - Modifiers Tab.....	1
Object types with modifiers.....	2
Modifier types.....	2
Modify.....	2
Generate.....	3
Deform.....	3
Simulate.....	3
Color.....	3
General functionality.....	3
Add.....	3
Header elements.....	3
Collapse panel.....	4
Modifier Icon.....	4
Modifier Name.....	4
On Cage.....	4
Edit Mode.....	4
Realtime.....	4
Render.....	4
Header menu.....	4
Apply as Shapekey.....	4
Save as Shapekey.....	5
Duplicate.....	5
Copy to Selected.....	5
Move to first.....	5
Move to last.....	5
Remove.....	5
Change Context.....	5
Reorder.....	5
Animate Property.....	5

25.8 Editors - Properties Editor - Modifiers Tab

Modifiers are automatic operations that affects the geometry of objects in a non destructive way. You can for example subdivide a mesh object. And the base geometry stays intact.

Modifiers can also be applied to the object. In this case the change is destructive.

Modifiers gets added in a so called modifier stack. Simply choose a modifier from the list. Modifiers can build on top of each other and can be reordered. Sometimes the order is important.



Object types with modifiers

There are two general types of objects where you can use modifiers. Mesh objects and Curve objects. The grease pencil object is a special object in this regards. And has some modifiers that the other object types does not have. But it is under the hood also a curve object.

Each of them shows a different set of modifiers. Some modifiers have the same name, but shows different settings for different object types.

Mesh object

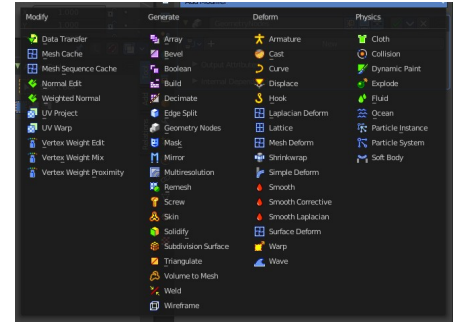

Curve + Text Object



Volume Object

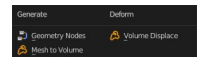

Grease Pencil Object

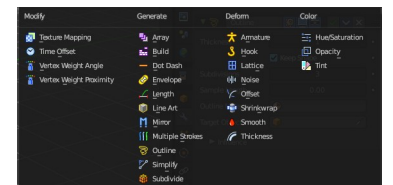

Lattice Object

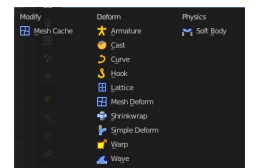

Modifier types

There are five types of modifiers:

Modify

Change the shape of an object, without altering its topology. But not directly, but by some other data like vertex groups.

Generate

Constructive/destructive tools that will affect the whole Topology of the mesh. They can change the general appearance of the object, or add new geometry to it.

Deform

Change the shape of an object, without altering its topology.

Simulate

Those represent physics simulations. In most cases, they are automatically added to the modifiers stack whenever a Particle System or Physics simulation is enabled. Their only role is to define the position in the modifier stack from which is taken the base data for the simulation they represent. As such, they typically have no attributes, and are controlled by settings exposed in separate sections of the Properties.

Color

Just for the grease pencil object. Adds some modifiers to adjust the color.

General functionality

Add

To add a modifier to an object, simply open the drop down menu, and choose the type of modifier that you want to add.

This will add the modifier to the list.

For some modifiers you will also find menu items in the 3D view. The Quick effect Fluid will for example add a fluid and liquid particle system modifier.

This menu entries exists to simplify the workflow. This menu entries are described in other chapters.

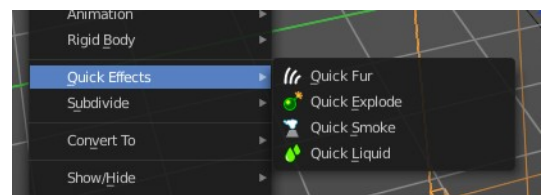
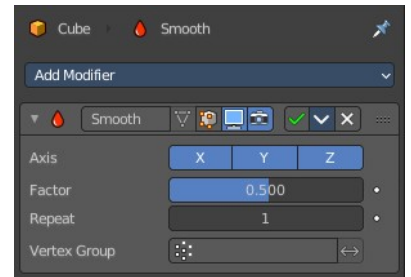

Header elements

You might want to disable a modifier temporarily. Or just see the effect in the final rendering. This can be adjusted in the header. The header is what you see when you collapse the modifier panel.

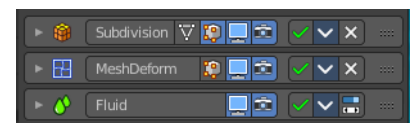

Note that not all modifiers have the same header content. Fluid modifiers for example doesn't even have a remove button. They get removed by removing the fluid simulation in the physics tab.

Elements are explained from left to right.

Collapse panel

The whole modifier panel can be collapsed. Click at the arrow button up left in the header.

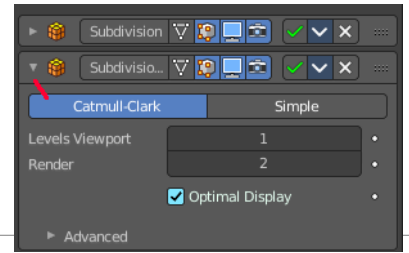

Modifier Icon

This icon shows the type of the modifier. And has no further functionality.

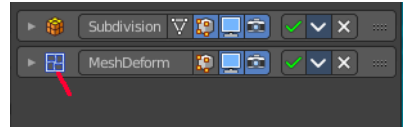

Modifier Name

The name of the modifier. You can rename modifiers by clicking into the edit field and change the text.

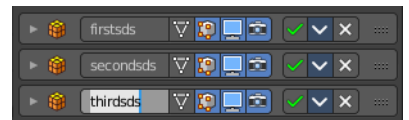

On Cage

Adjust edit cage to modifier result. With this option the geometry will be viewed at the position they will be after the modifier is calculated. Important for the mirror modifier for example.

Edit Mode

Display the modifier result in edit mode.

Realtime

Display the modifier in the viewport.

Render

Display the modifier in the rendered result.

Header menu

Apply as Shapekey

Armature modifier. Applies the current pose as a shape key, and removes the modifier.

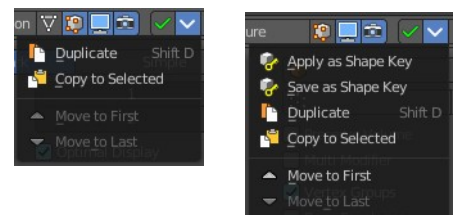

Save as Shapekey

Armature modifier. Applies the current pose as a shape key, and keeps the modifier.

Duplicate

Duplicates the modifier, and places the duplicate below the current modifier.

Copy to Selected

Copies the modifier to the selected object. First select the object where you want to paste the modifier to. Then select the object with the modifier with holding down shift so that both objects are selected. Now use Copy to Selected. And the modifier will copy over to the first object. Works also with multiple objects.

Move to first

Move the modifier to the first position in the stack.

Move to last

Move the modifier to the last position in the stack.

Remove

Removes the modifier from the stack.

Change Context

Some modifiers cannot be removed from the modifiers stack directly. Like fluid modifiers. You need to remove the fluid simulation instead, in the physics tab. With the change context button you jump to the required tab where you can now remove the simulation.

Reorder

You can have more than one modifier in the list. And sometimes the order of the modifiers is very important.

Grab the handler at the right and drag the modifier to the position where you want it to have.

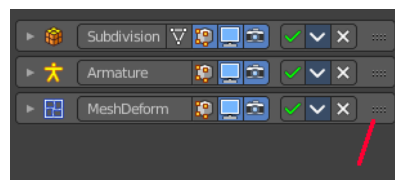

Animate Property

Some of the properties can be animated. Click at the animate property button at the right to add a keyframe.

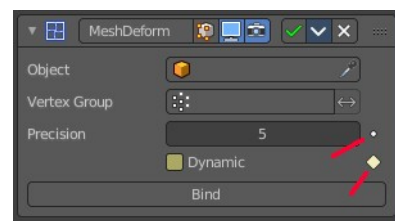



26.9.1 Editors - Properties Editor - Modifiers Properties Tab - Mesh - Modify modifiers

Table of content

Detailed table of content.....	1
Mesh - Modify modifiers.....	5
Data Transfer.....	5
Mesh Cache.....	8
Mesh Sequence Cache.....	9
Normal Edit.....	12
Weighted Normal.....	13
UV Project.....	14
UV Warp.....	15
Vertex Weight Edit.....	16
Vertex Weight Mix.....	19
Vertex Weight Proximity.....	21

Detailed table of content

Detailed table of content

Detailed table of content.....	1
Mesh - Modify modifiers.....	5
Data Transfer.....	5
Usage.....	5
Source Object.....	5
Object transform.....	6
Mix Mode.....	6
Mix Factor.....	6
Vertex Group.....	6
Generate Data Layers.....	6
Vertex data.....	6
Vertex Groups / Bevel Weight.....	6
Mapping.....	6
Vertex Groups.....	6
Layer Selection.....	6
Layer Mapping.....	6
Edge Data.....	6
Sharp, UV Seam, etc.....	7
Mapping.....	7
Face Corner Data.....	7
Custom normals, Vertex Colors, UV's.....	7
Mapping.....	7
Vertex Colors.....	7
Layer Selection.....	7
Layer Mapping.....	7
UV's.....	7
Layer Selection.....	7

Layer Mapping.....	7
Island Precision.....	7
Face Data.....	8
Smooth / Freestyle Mark.....	8
Mapping.....	8
Topology Mapping.....	8
Max Distance.....	8
Ray Radius.....	8
Mesh Cache.....	8
Format.....	8
File Path.....	8
Influence.....	8
Deform Mode.....	8
Interpolation.....	9
Vertex Group.....	9
Time Remapping.....	9
Frame / Time / Factor.....	9
Play Mode.....	9
Frame Start.....	9
Frame Scale.....	9
Axis Mapping.....	9
Forward/Up Axis.....	9
Flip Axis.....	9
Mesh Sequence Cache.....	9
Data property.....	10
Data browser.....	10
Name.....	10
Fake User.....	10
Open Cache File.....	10
Remove.....	10
File Path.....	10
Load File.....	10
Refresh Active.....	10
Object Path.....	10
Read Data.....	10
Vertex Interpolation.....	10
Time Subpanel.....	10
Sequence.....	11
Override Frame.....	11
Frame.....	11
Frame Offset.....	11
Render Procedural subpanel.....	11
Use Render Engine Procedural.....	11
Use Prefetch.....	11
Prefetch Cache Size.....	11
Velocity subpanel.....	11
Velocity Attribute.....	11
Velocity Unit.....	11
Velocity Scale.....	11
Normal Edit.....	12
Mode.....	12
Radial.....	12
Directional.....	12

Target.....	12
Parallel Normals.....	12
Mix.....	12
Mix Mode.....	12
Mix Factor.....	12
Vertex Group.....	13
Max Angle.....	13
Lock Polygon Normals.....	13
Offset.....	13
Weighted Normal.....	13
Weighting Mode.....	13
Face Area.....	13
Corner Angle.....	14
Face Area and Angle.....	14
Weight.....	14
Threshold.....	14
Keep Sharp.....	14
Face Influence.....	14
Vertex Group.....	14
Invert.....	14
UV Project.....	14
UV Map.....	15
Aspect X/Y and Scale X/Y.....	15
Projectors.....	15
Objects.....	15
UV Warp.....	15
Usage.....	15
UV Layer.....	15
UV Center.....	15
Axis U / V.....	16
Object From, To.....	16
Vertex Group.....	16
Invert.....	16
Transform.....	16
Offset.....	16
Scale.....	16
Rotation.....	16
Vertex Weight Edit.....	16
Vertex Group.....	17
Default Weight.....	17
Group Add.....	17
Threshold.....	17
Group Remove.....	17
Threshold.....	17
Normalize Weights.....	17
Falloff subpanel.....	17
Type.....	17
Linear.....	17
Custom Curve.....	17
Sharp, Smooth, Root and Sphere.....	17
Random.....	17
Median Step.....	17
Invert.....	18

Influence.....	18
Global Influence.....	18
Mask Vertex Group.....	18
Invert.....	18
Mask Texture.....	18
Texture Property.....	18
Texture Browser.....	18
Name.....	18
Fake User.....	18
New Texture.....	18
Remove.....	18
Show Texture in Texture Tab.....	18
Channel.....	18
Texture Coordinates.....	19
Vertex Weight Mix.....	19
Vertex Group A.....	19
Vertex Group B.....	19
Default Weight A.....	19
Default Weight B.....	19
Vertex Set.....	19
All.....	19
Vgroup A.....	19
Vgroup B.....	19
Vgroup A or B.....	20
Vgroup and B.....	20
Mix Mode.....	20
Replace weights.....	20
Add to weights.....	20
Subtract from weights.....	20
Multiply weights.....	20
Divide weights.....	20
Difference.....	20
Average.....	20
Influence.....	20
Global Influence.....	20
Mask Vertex Group.....	20
Invert.....	21
Mask Texture.....	21
Texture Property.....	21
Texture Browser.....	21
Name.....	21
Fake User.....	21
New Texture.....	21
Remove.....	21
Show Texture in Texture Tab.....	21
Channel.....	21
Texture Coordinates.....	21
Vertex Weight Proximity.....	21
Vertex Group.....	22
Target Object.....	22
Proximity mode.....	22
Object.....	22
Geometry.....	22

Lowest.....	22
Highest.....	22
Normalize Weights.....	22
Falloff.....	22
Type.....	22
Linear.....	22
Custom Curve.....	22
Sharp, Smooth, Root and Sphere.....	23
Random.....	23
Median Step.....	23
Invert.....	23
Influence.....	23
Global Influence.....	23
Mask Vertex Group.....	23
Invert.....	23
Mask Texture.....	23
Texture Property.....	23
Texture Browser.....	23
Name.....	23
Fake User.....	23
New Texture.....	23
Remove.....	24
Show Texture in Texture Tab.....	24
Channel.....	24
Texture Coordinates.....	24

Mesh - Modify modifiers

Data Transfer

The Data Transfer modifier transfers several types of data from one mesh to another. Data types include vertex groups, UV maps, vertex colors, custom normals...

Transfer works by generating a mapping between source mesh's items (vertices, edges, etc.) and destination ones, either on a one-to-one basis, or mapping several source items to a single destination one, using interpolation.

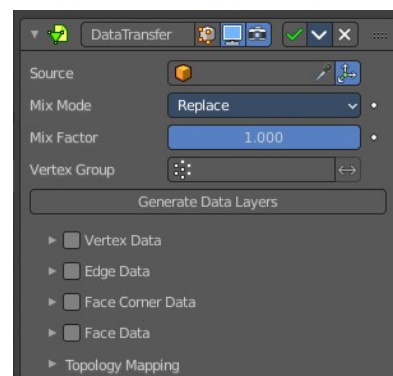

Usage

Using this modifier will not create destination data layers. Use the Generate Data Layers button for this purpose when you are done with selecting the set of source data to transfer.

Creating those data layers on destination mesh is not part of the modifier stack. This means that they will remain. Even once the modifier is deleted, or if the source data selection is modified.

Source Object

Mesh object to copy the data from.

Object transform

Evaluate the source and destination objects in global space instead of local space.

Mix Mode

How to mix the destination elements with the source elements.

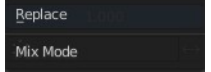

Mix Factor

How much of the transferred data gets mixed into existing one (not supported by all data types).

Vertex Group

Allows per-item fine control of the mix factor. Vertex group influence can be reverted using the small “arrow” button to the right.

Generate Data Layers

This modifier cannot generate needed data layers itself. Adjust the settings to your needs, then press this button to generate matching destination layers, if needed.

Vertex data

Activate this group when you want to transfer vertex data.

Vertex Groups / Bevel Weight

Which vertex data layers to transfer. Vertex groups or Bevel weight.

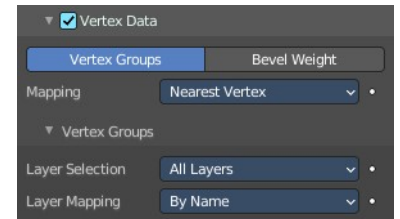

Mapping

The vertex mapping method to use.

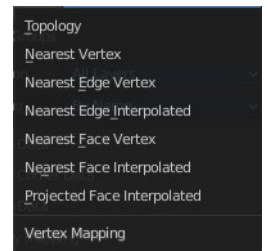

Vertex Groups

Just active with data layer Vertex groups.

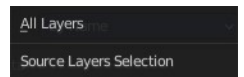

Layer Selection

What layer from the source object gets selected.

Layer Mapping

How to match the destination layer.

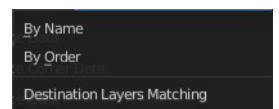

Edge Data

Activate this group when you want to transfer edge data.

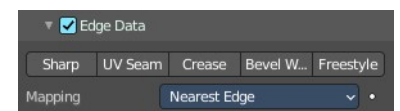

Sharp, UV Seam, etc.

Which edge data layers to transfer. You can just use one method.

Mapping

The edge mapping method to use.

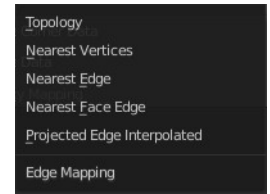

Face Corner Data

Custom normals, Vertex Colors, UV's

Which face corner data to transfer. You can just use one method.

Mapping

The face corner data mapping method to use.

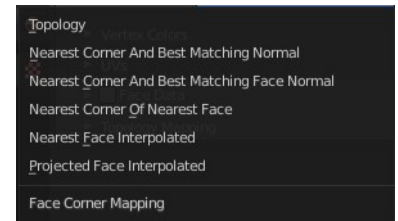
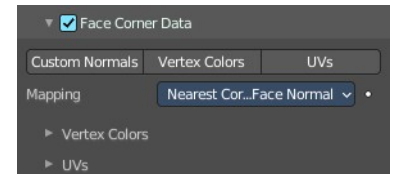

Vertex Colors

Further settings for when you choose Vertex colors.

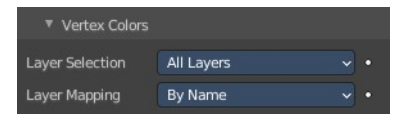

Layer Selection

Source Layer Selection.

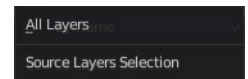

Layer Mapping

Destination layer mapping.

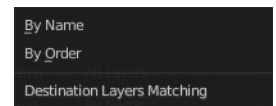

UV's

Further settings for when you choose UV's.

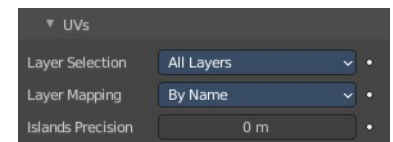

Layer Selection

Source Layer Selection.

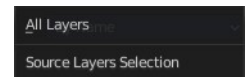

Layer Mapping

Destination layer mapping.

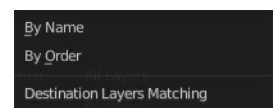

Island Precision

The factor to control the island handling. A value of 0.0 means no island handling. A value of 0.02 is a good starting point.

Face Data

Smooth / Freestyle Mark

Which poly data layers to transfer.

Mapping

The face mapping method.

Topology Mapping

Max Distance

Only Neighbor Geometry. For non topology mapping, the source elements must be closer than the value in the edit box.

Ray Radius

The width of rays.

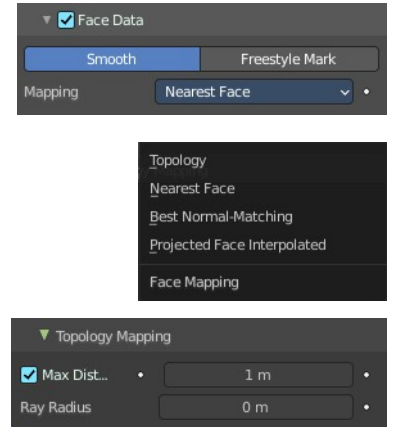

Mesh Cache

The Mesh Cache modifier allows you to apply animated mesh data to a mesh. And deform it when playing back.

This works in a similar way to shape keys. But uses external files, and allows to interchange between applications.

Tip! Both MDD and PC2 depend on the vertex order on the mesh remaining unchanged. This is a limitation of this method, so take care not to add/remove/reorder vertices once this modifier is used.

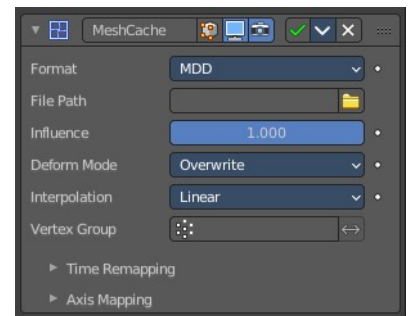

Format

The input file format (currently .mdd and .pc2 are supported).

File Path

Path to the cache file.

Influence

Factor to adjust the influence of the modifier's deformation.

Deform Mode

This setting defaults to Overwrite which will replace the vertex locations with those in the cache file.

When you want to mix a mesh cache file with shape keys, then you can select the Deform option which integrates deformations with the mesh cache result.

Note that this feature is limited to making smaller, isolated edits and will not work for larger changes such as

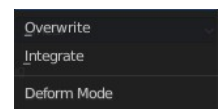
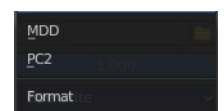

re-posing limbs.

Interpolation

The blend mode between frames. Use linear when the frames in the cache file do not match up exactly with the frames in the blend-file.

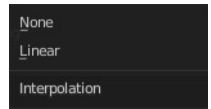

Vertex Group

Which vertex group determines the influence of the modifier per point.

Time Remapping

Frame / Time / Factor

How time is calculated.

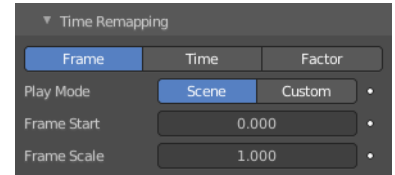

Play Mode

How playback operates.

Frame Start

Play the cache starting from this frame.

Frame Scale

Scale time by this factor (applied after the start value).

Axis Mapping

Forward/Up Axis

The axis for forward and up used in the source file.



Flip Axis

Allows you to flip the coordinates on an axis.

Mesh Sequence Cache

The Mesh Sequence Cache modifier loads data from Alembic files. It supports static meshes, but is mostly used to load animated meshes. Despite its name, this modifier also supports curves. It also handles file sequences, as well as meshes and curves with varying topology (like the result of fluid simulations).

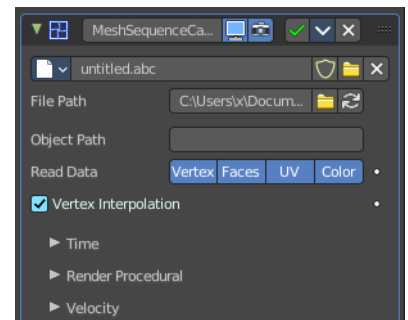
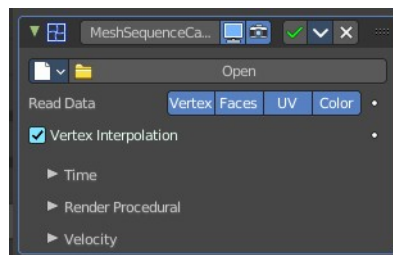

When importing an Alembic file, Mesh Sequence Cache modifiers are automatically added to time-varying

meshes. For time-varying object transforms (so animation of rotation, location, or scale), the Transform Cache Constraint is used.

Data property

Data browser

List of available Alembic files.



Name

The name of the current active alembic file.

Fake User

Keep this file in the scene even when it has no user anymore.

Open Cache File

Open an alembic file.

Remove

Remove the alembic file.

File Path

Path to the Alembic file.

Load File

Open an alembic file.

Refresh Active

Update the files and paths.

Object Path

Path to the object in the alembic file used to lookup geometric data.

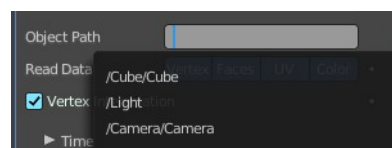

Read Data

Type of data to read for a mesh object. Vertices, polygons, UV maps and Vertex Color layers.

Vertex Interpolation

Allow interpolation of vertex positions.

Time Subpanel

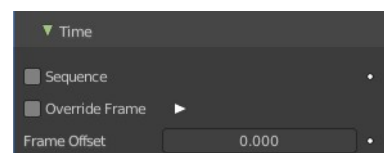

Sequence

Whether or not the cache is separated in a series of files.

Override Frame

Whether to use a custom frame for looking up data in the cache file, instead of using the current scene frame.

Frame

The time to use for looking up the data in the cache file, or to determine which to use in a file sequence.

Frame Offset

Define a frame offset to the current frame.

Render Procedural subpanel

Use Render Engine Procedural

This feature is just available for Cycles, and just in an experimental state.

Display boxes as placeholders in the viewport.

Use Prefetch

This feature is just available for Cycles, and just in an experimental state.

When enabled, the Cycles procedural will preload animation data for faster update.

Prefetch Cache Size

This feature is just available for Cycles, and just in an experimental state.

Memory usage limit for the cache. If the data size does not fit the renderer is aborted. 0 disables the feature.

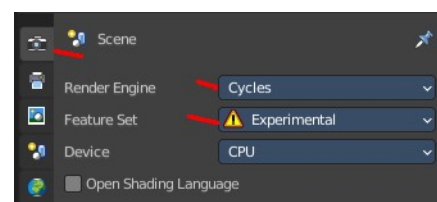
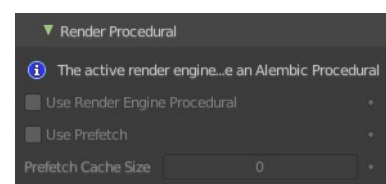

Velocity subpanel

Velocity Attribute

Name of the Alembic Attribute used for generating motion blur data.

Velocity Unit

Define if velocity vectors are interpreted in Frame or Second.

Velocity Scale

Multiplier used to control the magnitude of the velocity for time effects.

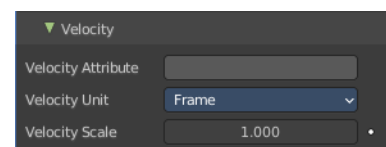

Normal Edit

The Normal Edit modifier affects (or generates) custom normals. It uses a few simple parametric methods to compute them, and mixes back those generated normals with existing ones.

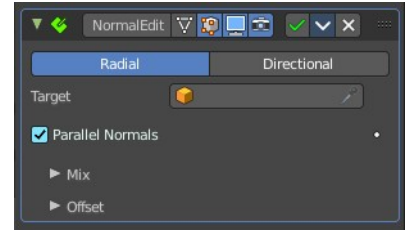

Note! This modifier requires custom normals to be enabled, which can be done by enabling Auto Smooth in the Properties.

Tip. More complex normal manipulations can be achieved by copying normals from one mesh to another, see the Data Transfer Modifier. Some shading effects can also make use of the Weighted Normals modifier.

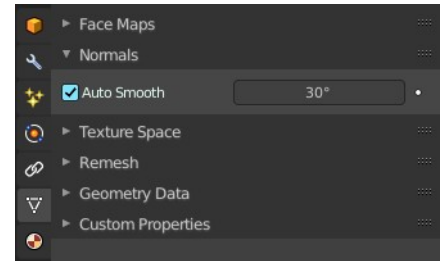

Mode

Radial

Aligns normals with the (origin, vertex_coordinates) vector, in other words all normals seems to radiate from the given center point, as if they were emitted from an ellipsoid surface.

Directional

Makes all normals point (converge) towards a given target object.

Target

Uses this object's origin as reference point when generating normals. A Target object is optional in Radial mode, but mandatory in Directional mode.

Parallel Normals

Only relevant in Directional mode. Makes all normals parallel to the line between both objects' origins, instead of converging towards target's origin.

Mix

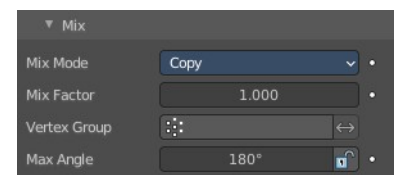

Mix Mode

How to affect existing normals with newly generated ones.

Note that the Multiply option is not a cross product, but a mere component-by-component multiplication.

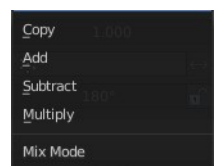

Mix Factor

How much of the generated normals get mixed into existing ones.

Vertex Group

Allows per-item fine control of the mix factor. The vertex group influence can be reverted by using the small “arrow” button to the right.

Max Angle

Forbids new generated normals to have an angle to the original normal above that given threshold. This is useful to prevent extreme changes, that can even lead to inverting the front/back sides of a face, and consequently to ugly shading artifacts.

Lock Polygon Normals

Prevents flipping (reversing front/back sides) of polygons which normal does not match anymore the side to which point its corners’ custom normals. Can also help avoiding shading issues.

Offset

Gives the origin of the modified object an offset before using it to generate normals.

Offset is only relevant in Radial mode if no Target Object is set, and in Directional mode when Parallel Normals is set.

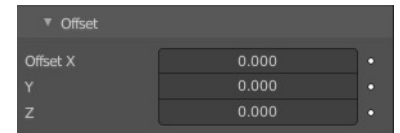

Weighted Normal

This modifier allows you to change the custom normals of a mesh. This can be useful to make some faces appear very flat during shading, among other effects.

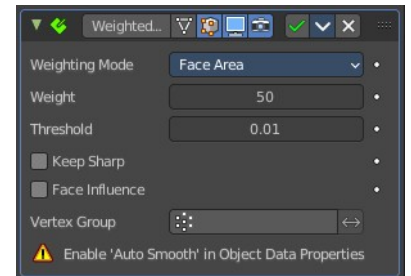

Note! This modifier requires custom normals to be enabled, which can be done by enabling Auto Smooth in the Properties.

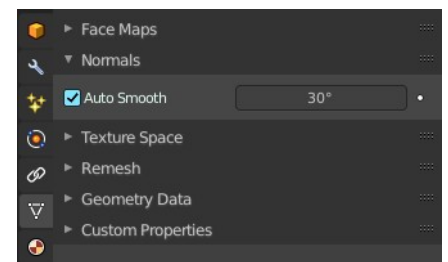

Weighting Mode

The normals around a vertex will be combined to create a custom (per face corner) normal using various weights for each. The Weighting Mode defines how to compute the weights.



Face Area

Weight according to the area of the face that the normal originates. A larger area means that the normal from that face will get a higher weight in final result.

Corner Angle

Weight according to the angle each face forms at the vertex.

Face Area and Angle

Weights are obtained by multiplying the face area and corner angle ones.

Weight

Determines how strongly the weights are biased according to the face areas and/or corner angles, a bit like a contrast setting for a picture.

A value of 50 means all faces are weighted uniformly.

More than 50 means faces with higher area or angles are given even more weight (more “contrast”).

Less than 50 means faces with higher area or angles are given lesser weights (less “contrast”).

Threshold

A weight-rounding threshold which means that, if two angles or areas differ by less than that threshold, they will get equal weights.

Keep Sharp

Preserve sharp edges, though smoothing will still happen if there are multiple faces between any two sharp edges.

Face Influence

Use face weights as assigned by the Set Strength tool or by the Set Strength mode of a Bevel modifier.

For example, if three faces meet at a vertex and have the face weights weak, medium, and strong, then only the normal associated with the strong face will be used to set the final result.

Vertex Group

If a vertex group is specified, the modifier will only affect those vertices.

Invert

Invert the selection (only affect the vertices not in the vertex group).

UV Project

The UV Project modifier acts like a slide projector. It emits a UV map from the negative Z axis of a controller object (such as an empty object), and applies it to the object as the “light” hits it.

UV Project is great for making spotlights more diverse, and also for creating decals to break up repetition.

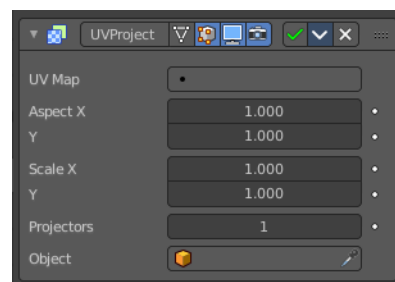

Usually, an Image Texture node mapped to the UV map that the modifier targets is added to the object's material.

UV Map

Which UV map to modify. Defaults to the active rendering layer.



Aspect X/Y and Scale X/Y

Aspect and scale manipulation of the image. Only apply when a camera is used as projector object.

Projectors

Up to ten projector objects are supported. Each face will choose the closest and aligned projector with its surface normal. Projections emit from the negative Z axis (i.e. straight down a camera or light). If the projector is a camera, the projection will adhere to its perspective/orthographic setting.

Objects

Specify the projector object(s).

UV Warp

The UV Warp modifier transforms an object's UV map based on values or two objects. Its purpose is to give you direct control over the object's UV's in the 3D Viewport, allowing you to directly move, rotate, and scale existing UV coordinates using defined values or a controller object or bone.

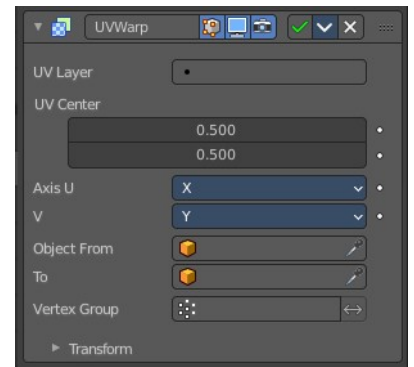

Usage

How the UV's are warped is determined by the difference between the transforms (location, rotation and scale) of the from and to objects.

If the to object has the same transforms as the from object, the UV's will not be changed.

Assuming the UV Axis of the modifier is X/Y and the scale of the objects is (1, 1, 1), if the to object is one unit away from the from object on the X axis, the UV's will be transformed on the U axis (horizontally) by one full UV space (the entire width of the image).

UV Layer

Which UV map to modify. Defaults to the active rendering layer.



UV Center

The center point of the UV map to use when applying scale or rotation. With (0, 0) at the bottom left and (1, 1) at the top right.

Axis U / V

The axes to use when mapping the 3D coordinates into 2D.

Object From, To

The two objects used to define the transformation.

Vertex Group

The vertex group can be used to scale the influence of the transformation per vertex.

Invert

Invert the selection (only affect the vertices not in the vertex group).

Transform

Offset

2D Offset for the warp.

Scale

2D Scale for the warp.

Rotation

2D Rotation for the warp.

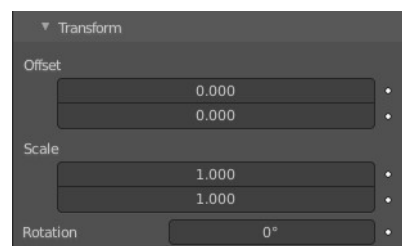

Vertex Weight Edit

This modifier is intended to edit the weights of a vertex group.

The general process is the following, for each vertex:

(Optional) It does the mapping, either through one of the predefined functions, or a custom mapping curve.

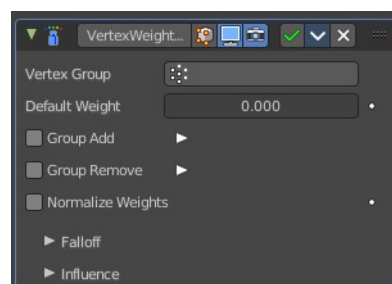

It applies the influence factor, and optionally the vertex group or texture mask (0.0 means original weight, 1.0 means fully mapped weight).

It applies back the weight to the vertex, and/or it might optionally remove the vertex from the group if its weight is below a given threshold, or add it if it is above a given threshold.

Important! This modifier does implicit clamping of weight values in the standard (0.0 to 1.0) range. All values below 0.0 will be set to 0.0, and all values above 1.0 will be set to 1.0.

Note! You can view the modified weights in Weight Paint Mode. This also implies that you will have to disable the Vertex Weight Edit modifier if you want to see the original weights of the vertex group you are editing.

Vertex Group

The vertex group to affect.

Default Weight

The default weight to assign to all vertices not in the given vertex group.

Group Add

Adds vertices with a final weight over Add Threshold to the vertex group.

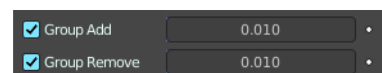

Threshold

The add threshold.

Group Remove

Removes vertices with a final weight below Remove Threshold from the vertex group.

Threshold

The remove threshold.

Normalize Weights

Normalize the resulting weights. Without normalizing the values are clamped between 0 and 1.

Falloff subpanel

Type

How weights are mapped to their new values.

Linear

No mapping.

Custom Curve

Allows the user to manually define the mapping using a curve.

Sharp, Smooth, Root and Sphere

These are classical mapping functions, from spikiest to roundest.

Random

Uses a random value for each vertex.

Median Step

Creates binary weights (0.0 or 1.0), with 0.5 as cutting value.

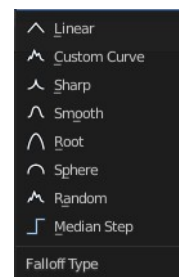
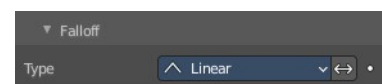

Invert

Inverts the falloff.

Influence

Global Influence

The overall influence of the modifier (0.0 will leave the vertex group's weights untouched, 1.0 is standard influence).

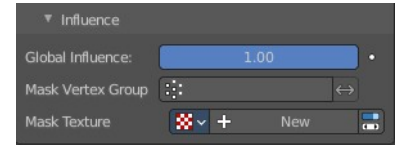

Important! Influence only affects weights, adding/removing of vertices to/from vertex group is not prevented by setting this value to 0.0. In addition, a per-vertex fine control of the effect is possible using either a vertex group or a texture (both are mutually exclusive). The per-vertex values from those will be multiplied with the Global Influence.

Mask Vertex Group

Choose a vertex group for masking.

Invert

Invert vertex group mask influence.

Mask Texture

Choose a texture for masking. Note that using a mask texture will remove the mask vertex group.

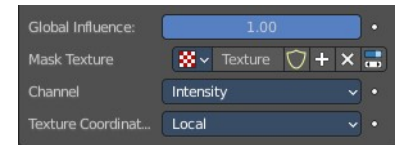

Texture Property

Texture Browser

A list of the available textures in the scene.

Name

The name of the currently active texture. You can rename the texture here by clicking at the edit box.

Fake User

Keep this texture in the scene even if it has no user.

New Texture

Add a new texture.

Remove

Remove the texture.

Show Texture in Texture Tab

Jumps to the texture tab where you can edit your texture.

Channel

Which channel of the texture to use for masking.

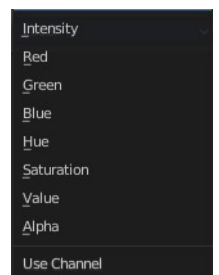
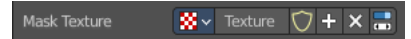

Texture Coordinates

Which texture coordinates of the texture to use for masking.

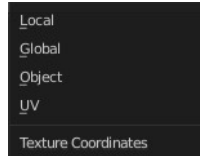

Vertex Weight Mix

Vertex Weight Mix Modifier

This modifier mixes a second vertex group (or a simple value) into the affected vertex group, using different operations.

Important! This modifier does implicit clamping of weight values in the standard (0.0 to 1.0) range. All values below 0.0 will be set to 0.0, and all values above 1.0 will be set to 1.0.

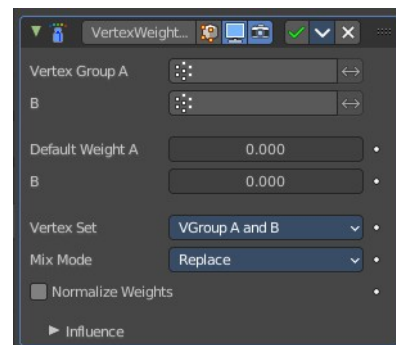

Note! You can view the modified weights in Weight Paint Mode. This also implies that you will have to disable the Vertex Weight Mix modifier if you want to see the original weights of the vertex group you are editing.

Vertex Group A

The vertex group to affect.

Vertex Group B

The second vertex group to mix into the affected one. Leave it empty if you only want to mix in a simple value.

Default Weight A

The default weight to assign to all vertices not in the given vertex group.

Default Weight B

The default weight to assign to all vertices not in the given second vertex group.

Vertex Set

Which vertices should be affected.

Important! When using All vertices, Vertices from group B or Vertices from one group, vertices might be added to the affected vertex group.

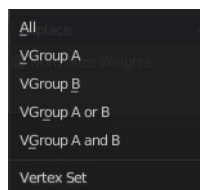

All

Affects all vertices, disregarding the vertex groups content.

Vgroup A

Affects only vertices belonging to the affected vertex group.

Vgroup B

Affects only vertices belonging to the second vertex group.

Vgroup A or B

Affects only vertices belonging to at least one of the vertex groups.

Vgroup and B

Affects only vertices belonging to both vertex groups.

Mix Mode

How the vertex group weights are affected by the other vertex group's weights.

Replace weights

Replaces affected weights with the second group's weights.

Add to weights

Adds the values of Group B to Group A.

Subtract from weights

Subtracts the values of Group B from Group A.

Multiply weights

Multiplies the values of Group B with Group A.

Divide weights

Divides the values of Group A by Group B.

Difference

Subtracts the smaller of the two values from the larger.

Average

Adds the values together, then divides by 2.

Influence

Global Influence

The overall influence of the modifier (0.0 will leave the vertex group's weights untouched, 1.0 is standard influence).

Important! Influence only affects weights, adding/removing of vertices to/from vertex group is not prevented by setting this value to 0.0. In addition, a per-vertex fine control of the effect is possible using either a vertex group or a texture (both are mutually exclusive). The per-vertex values from those will be multiplied with the Global Influence.

Mask Vertex Group

Choose a vertex group for masking.

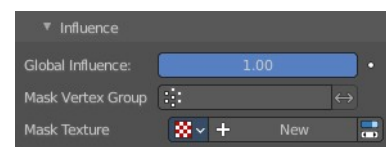

Invert

Invert vertex group mask influence.

Mask Texture

Choose a texture for masking. Note that using a mask texture will remove the mask vertex group.

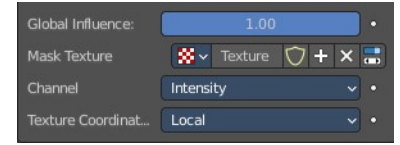

Texture Property

Texture Browser

A list of the available textures in the scene.

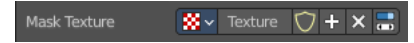

Name

The name of the currently active texture. You can rename the texture here by clicking at the edit box.

Fake User

Keep this texture in the scene even if it has no user.

New Texture

Add a new texture.

Remove

Remove the texture.

Show Texture in Texture Tab

Jumps to the texture tab where you can edit your texture.

Channel

Which channel of the texture to use for masking.

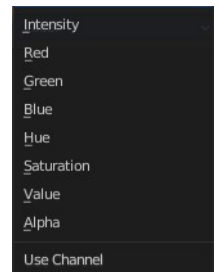

Texture Coordinates

Which texture coordinates of the texture to use for masking.

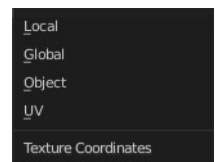

Vertex Weight Proximity

This modifier sets the weights of the given vertex group, based on the distance between the object (or its vertices), and another target object (or its geometry).

Warning1 This modifier does implicit clamping of weight values in the

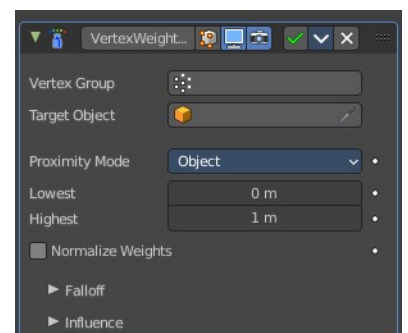

standard (0.0 to 1.0) range. All values below 0.0 will be set to 0.0, and all values above 1.0 will be set to 1.0.

Note! You can view the modified weights in Weight Paint Mode. This also implies that you will have to disable the Vertex Weight Proximity modifier if you want to see the original weights of the vertex group you are editing.

Vertex Group

The vertex group to affect.

Target Object

The object from which to compute distances.

Proximity mode

Object

Use the distance between the modified mesh object and the target object as weight for all vertices in the affected vertex group.

Geometry

Use the distance between each vertex and the target object, or its geometry.

Note! If you enable more than one of them, the shortest distance will be used. If the target object has no geometry (e.g. an empty or camera), it will use the location of the object itself.

Lowest

Distance mapping to 0.0 weight. Tip! Lowest can be set above Highest to reverse the mapping.

Highest

Distance mapping to 1.0 weight.

Normalize Weights

Normalize the resulting weights. Without this option they get only clamped within the 0.0 - 1.0 range.

Falloff

Type

How weights are mapped to their new values.

Linear

No mapping.

Custom Curve

Allows the user to manually define the mapping using a curve.

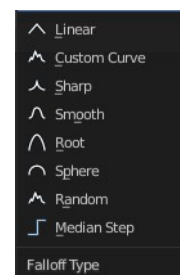
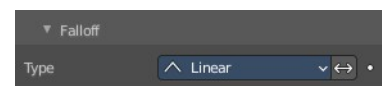
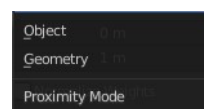

Sharp, Smooth, Root and Sphere

These are classical mapping functions, from spikiest to roundest.

Random

Uses a random value for each vertex.

Median Step

Creates binary weights (0.0 or 1.0), with 0.5 as cutting value.

Invert

Inverts the falloff.

Influence

Global Influence

The overall influence of the modifier (0.0 will leave the vertex group's weights untouched, 1.0 is standard influence).

Important! Influence only affects weights, adding/removing of vertices to/from vertex group is not prevented by setting this value to 0.0. In addition, a per-vertex fine control of the effect is possible using either a vertex group or a texture (both are mutually exclusive). The per-vertex values from those will be multiplied with the Global Influence.

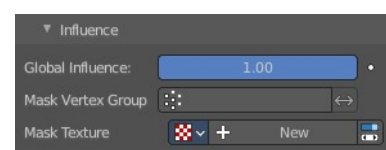

Mask Vertex Group

Choose a vertex group for masking.

Invert

Invert vertex group mask influence.

Mask Texture

Choose a texture for masking. Note that using a mask texture will remove the mask vertex group.

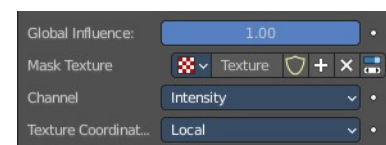

Texture Property

Texture Browser

A list of the available textures in the scene.

Name

The name of the currently active texture. You can rename the texture here by clicking at the edit box.

Fake User

Keep this texture in the scene even if it has no user.

New Texture

Add a new texture.

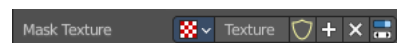

Remove

Remove the texture.

Show Texture in Texture Tab

Jumps to the texture tab where you can edit your texture.

Channel

Which channel of the texture to use for masking.

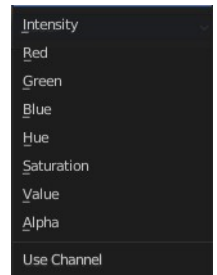

Texture Coordinates

Which texture coordinates of the texture to use for masking.

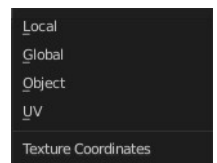



26.9.10 Editors - Properties Editor - Modifiers Properties Tab - Modify modifiers

Table of content

Detailed table of content.....	1
Grease Pencil - Modify modifiers.....	3
Texture Mapping.....	3
Time Offset Modifier.....	5
Vertex Weight Angle.....	7
Vertex Weight Proximity.....	9

Detailed table of content

Detailed table of content

Detailed table of content.....	1
Grease Pencil - Modify modifiers.....	3
Texture Mapping.....	3
Mode.....	3
Stroke.....	3
Stroke Fit Method.....	3
Constant Length.....	3
Stroke Length.....	3
UV Offset.....	3
Rotation.....	3
Scale.....	4
Fill.....	4
Fill Rotation.....	4
Offset X / Y.....	4
Scale.....	4
Stroke and Fill.....	4
Influence Subpanel.....	4
Influence.....	4
Layer.....	4
Invert.....	4
Pass.....	4
Invert.....	4
Material.....	5
Invert.....	5
Pass.....	5
Invert.....	5
Vertex Group.....	5
Invert.....	5
Time Offset Modifier.....	5
Mode.....	5
Regular.....	5
Reverse.....	5
Fixed Frame.....	5
Ping Pong.....	5

Chain.....	6
Frame Offset.....	6
Scale.....	6
Keep Loop.....	6
Segment List.....	6
Add /Remove Segment.....	6
Move Up / Down.....	6
Mode.....	6
Regular.....	6
Reverse.....	6
Ping Pong.....	6
Frame Start.....	6
End.....	6
Repeat.....	7
Custom Range subpanel.....	7
Frame Start / End.....	7
Influence subpanel.....	7
Layer.....	7
Invert.....	7
Pass.....	7
Invert.....	7
Vertex Weight Angle.....	7
Vertex Group.....	7
Angle.....	8
Axis.....	8
Space.....	8
Minimum.....	8
Multiply Weights.....	8
Influence Subpanel.....	8
Influence.....	8
Layer.....	8
Invert.....	8
Pass.....	8
Invert.....	8
Material.....	8
Invert.....	8
Pass.....	9
Invert.....	9
Vertex Group.....	9
Invert.....	9
Vertex Weight Proximity.....	9
Vertex Group.....	9
Target Object.....	9
Lowest.....	9
Highest.....	9
Minimum.....	9
Multiply Weights.....	10
Influence Subpanel.....	10
Influence.....	10
Layer.....	10
Invert.....	10
Pass.....	10
Invert.....	10

Material.....	10
Invert.....	10
Pass.....	10
Invert.....	10
Vertex Group.....	10
Invert.....	10

Grease Pencil - Modify modifiers

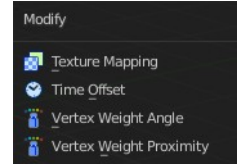

Texture Mapping

The Texture Mapping Modifier changes the strokes texture UV position.

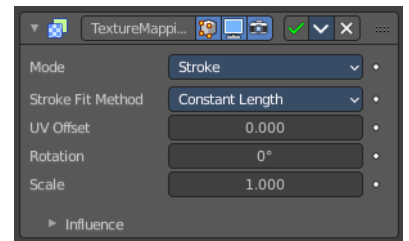

Mode

The texture transformation will be applied to the stroke/fill or stroke UVs.

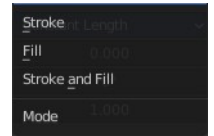

Stroke

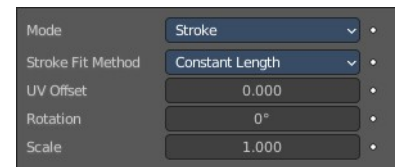

Stroke Fit Method

The texture fitting method.

Constant Length

The texture keep a consistent length along the strokes.



Stroke Length

The texture is normalized to fit the stroke length.

UV Offset

Moves the texture along the strokes.

Rotation

Rotates the points of the strokes. Note that the Rotation option is limited to a range of -90 to 90 degrees.

Scale

Factor for the texture scale.

Fill

Fill Rotation

Sets the texture angle.

Offset X / Y

Moves the texture origin in x and/or y direction

Scale

Factor for the texture scale.

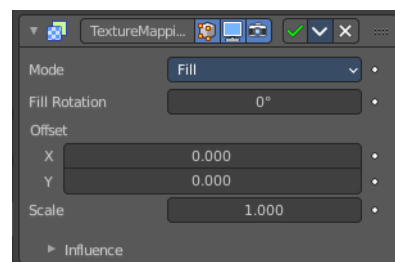

Stroke and Fill

See both single chapters above.

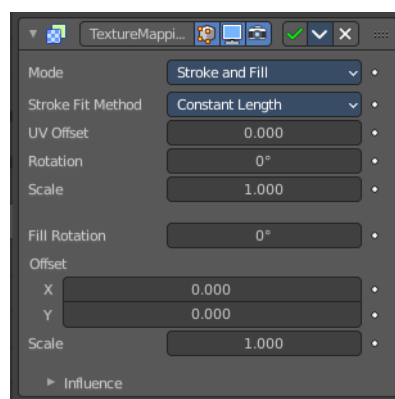

Influence Subpanel

Influence

Layer

Restricts the effect only to one layer or to any layers that share the same pass index. Click to pick the layer that you want to use.

Invert

Inverts the influence.

Pass

The layer pass index.

Invert

Inverts the influence.

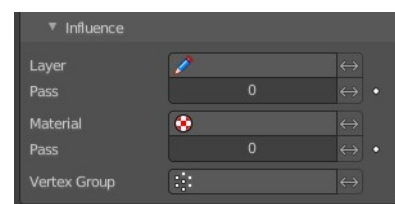

Material

Restricts the effect only to one layer or to any layers that share the same material index. Click to pick the layer that you want to use.

Invert

Inverts the influence.

Pass

The layer pass index.

Invert

Inverts the influence.

Vertex Group

Restricts the effect only to one vertex group. Click to choose the vertex group.

Invert

Inverts the influence.

Time Offset Modifier

Grease Pencil object only. The Time Offset Modifier offsets the position of Grease Pencil keyframes.

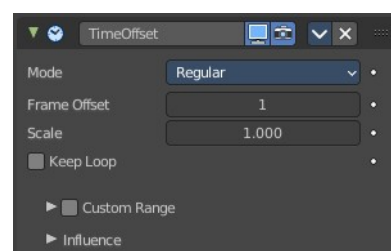

Mode

Regular

Offsets keyframes in default animation playback direction (left to right).

Reverse

Offsets keyframes in inverse animation playback direction (right to left).

Fixed Frame

Keep the selected frame fixed and do not change over time.

Ping Pong

Plays forwards then backwards in a loop.

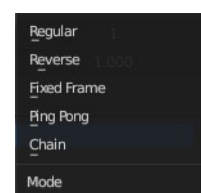

Chain

List of chained animation elements.

Frame Offset

Number of frames to offset the original keyframes.

Scale

Evaluation time (in seconds).

Keep Loop

Moves end frame to the animation start to keep animation in a loop.

The following just shows with Mode Chain:

Segment List

Here you can define animation segments that you want to chain.

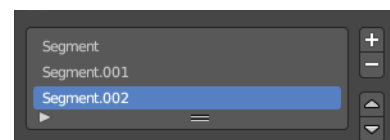

Add /Remove Segment

Add or remove a segment.

Move Up / Down

Move a segment up or down in the list.

Mode

The mode of the segment.

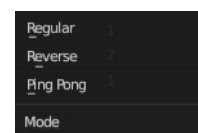

Regular

Offsets keyframes in default animation playback direction (left to right).

Reverse

Offsets keyframes in inverse animation playback direction (right to left).

Ping Pong

Plays forwards then backwards in a loop.

Frame Start

The start frame of the segment.



End

The end frame of the segment.

Repeat

How often to repeat the segment.

Custom Range subpanel

Use a custom range of frames.

Frame Start / End

Sets the range start and end frames.

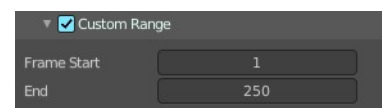

Influence subpanel

Layer

Restricts the effect only to one layer or to any layers that share the same pass index. Click to pick the layer that you want to use.



Invert

Inverts the influence.

Pass

The layer pass index.

Invert

Inverts the influence.

Vertex Weight Angle

This modifier sets the weights of a vertex group based of the angle of the geometry.

Warning! This modifier does implicit clamping of weight values in the standard (0.0 to 1.0) range. All values below 0.0 will be set to 0.0, and all values above 1.0 will be set to 1.0.

Note! You can view the modified weights in Weight Paint Mode. This also implies that you will have to disable the Vertex Weight Proximity modifier if you want to see the original weights of the vertex group you are editing.

Vertex Group

Which vertex group to use.

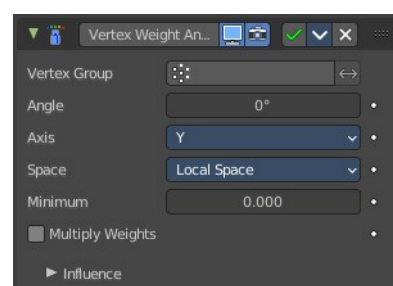

Angle

Distance angle to 0.0 weight. Tip! Lowest can be set above Highest to reverse the mapping.

Axis

Which axis to use.

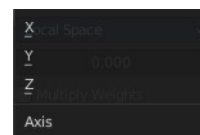

Space

In which space to calculate. Local or Global.

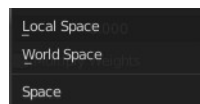

Minimum

Minimum value for vertex weight.

Multiply Weights

Multiply the calculated weights with the existing values of the vertex group.

Influence Subpanel

Influence

Layer

Restricts the effect only to one layer or to any layers that share the same pass index. Click to pick the layer that you want to use.

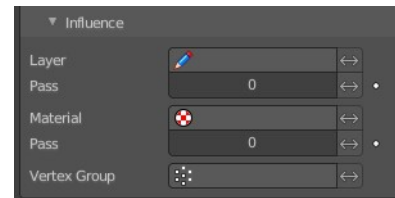

Invert

Inverts the influence.

Pass

The layer pass index.

Invert

Inverts the influence.

Material

Restricts the effect only to one layer or to any layers that share the same material index. Click to pick the layer that you want to use.

Invert

Inverts the influence.

Pass

The layer pass index.

Invert

Inverts the influence.

Vertex Group

Restricts the effect only to one vertex group. Click to choose the vertex group.

Invert

Inverts the influence.

Vertex Weight Proximity

This modifier sets the weights of the given vertex group, based on the distance between the object (or its vertices), and another target object (or its geometry).

Warning1 This modifier does implicit clamping of weight values in the standard (0.0 to 1.0) range. All values below 0.0 will be set to 0.0, and all values above 1.0 will be set to 1.0.

Note! You can view the modified weights in Weight Paint Mode. This also implies that you will have to disable the Vertex Weight Proximity modifier if you want to see the original weights of the vertex group you are editing.

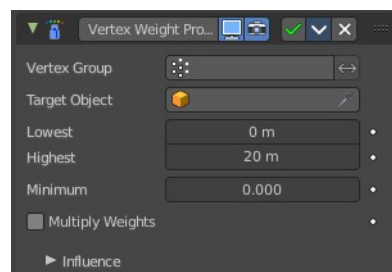

Vertex Group

The vertex group to affect.

Target Object

The object from which to compute distances.

Lowest

Distance mapping to 0.0 weight. Tip! Lowest can be set above Highest to reverse the mapping.

Highest

Distance mapping to 1.0 weight.

Minimum

Minimum value for vertex weight.

Multiply Weights

Multiply the calculated weights with the existing values of the vertex group.

Influence Subpanel

Influence

Layer

Restricts the effect only to one layer or to any layers that share the same pass index. Click to pick the layer that you want to use.

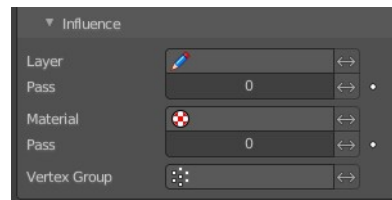

Invert

Inverts the influence.

Pass

The layer pass index.

Invert

Inverts the influence.

Material

Restricts the effect only to one layer or to any layers that share the same material index. Click to pick the layer that you want to use.

Invert

Inverts the influence.

Pass

The layer pass index.

Invert

Inverts the influence.

Vertex Group

Restricts the effect only to one vertex group. Click to choose the vertex group.

Invert

Inverts the influence.



26.9.2 Editors - Properties Editor - Modifiers Properties Tab - Grease Pencil - Generate Modifiers

Table of content

Detailed table of content.....	1
Grease Pencil - Generate modifiers.....	8
Array.....	8
Build.....	10
Dot Dash.....	15
Envelope.....	17
Length.....	18
Line Art.....	20
Mirror.....	27
Multiple Strokes.....	28
Outline.....	29
Simplify.....	31
Subdivide.....	32

Detailed table of content

Detailed table of content

Detailed table of content.....	1
Grease Pencil - Generate modifiers.....	8
Array.....	8
Count.....	8
Material Override.....	8
Relative Offset subpanel.....	8
Factor X/Y/Z.....	8
Constant Offset subpanel.....	9
Distance X/Y/Z.....	9
Object Offset subpanel.....	9
Object.....	9
Randomize.....	9
Offset.....	9
Rotation.....	9
Scale.....	9
Uniform Scale.....	9
Seed.....	9
Influence subpanel.....	9
Layer.....	9
Inverse Layers.....	9
Pass.....	10
Inverse Pass.....	10
Material.....	10
Invert Materials.....	10
Pass.....	10
Inverse Pass.....	10

Build.....	10
Mode.....	10
Sequential mode.....	10
Transition.....	10
Timing.....	11
Natural Drawing Speed.....	11
Speed Factor.....	11
Maximum Gap.....	11
Number of Frames.....	11
Frames.....	11
Delay.....	11
Percentage Factor.....	11
Factor.....	11
Object.....	11
Concurrent Mode.....	11
Transition.....	11
Grow.....	11
Shrink.....	11
Vanish.....	12
Timing.....	12
Number of frames.....	12
Time Alignment.....	12
Align Start.....	12
Align End.....	12
Frames.....	12
Delay.....	12
Percentage Factor.....	12
Time Alignment.....	12
Align Start.....	12
Align End.....	12
Factor.....	12
Object.....	12
Additive.....	13
Timing.....	13
Natural Drawing Speed.....	13
Speed Factor.....	13
Maximum Gap.....	13
Number of frames.....	13
Time Alignment.....	13
Align Start.....	13
Align End.....	13
Frames.....	13
Delay.....	13
Percentage Factor.....	13
Time Alignment.....	13
Align Start.....	13
Align End.....	14
Factor.....	14
Start delay.....	14
Frames.....	14
Object.....	14
Custom Range.....	14
Start.....	14

End.....	14
Fade subpanel.....	14
Factor.....	14
Thickness.....	14
Opacity.....	14
Weight Output.....	14
Influence subpanel.....	14
Layer.....	14
Inverse Layers.....	15
Pass.....	15
Inverse Pass.....	15
Dot Dash.....	15
Offset.....	15
Segment list.....	15
Add Segment.....	15
Remove Segment.....	15
Move Dash Segment up or down.....	15
Search element.....	15
Edit Box.....	15
Invert.....	15
Sort by name.....	16
Reverse.....	16
Dash.....	16
Gap.....	16
Radius.....	16
Opacity.....	16
Material Index.....	16
Cyclic.....	16
Influence subpanel.....	16
Layer.....	16
Inverse Layers.....	16
Pass.....	16
Inverse Pass.....	16
Material.....	16
Invert Materials.....	17
Pass.....	17
Inverse Pass.....	17
Envelope.....	17
Mode.....	17
Deform.....	17
Segments.....	17
Fills.....	17
Spread Length.....	17
Thickness.....	17
Strength.....	17
Material Index.....	17
Skip Segments.....	17
Influence subpanel.....	18
Layer.....	18
Inverse Layers.....	18
Pass.....	18
Inverse Pass.....	18
Material.....	18

Invert Materials.....	18
Pass.....	18
Inverse Pass.....	18
Vertex Group.....	18
Inverse Pass.....	18
Length.....	18
Mode.....	19
Factor Start/End.....	19
Used Length.....	19
Curvature subpanel.....	19
Point Density.....	19
Segment Influence.....	19
Filter Angle.....	19
Invert.....	19
Random Offset subpanel.....	19
Random offset Start.....	19
Random offset End.....	19
Random Noise Offset.....	19
Seed.....	19
Randomize subpanel.....	19
Step.....	20
Influence subpanel.....	20
Layer.....	20
Inverse Layers.....	20
Pass.....	20
Inverse Pass.....	20
Material.....	20
Invert Materials.....	20
Pass.....	20
Inverse Pass.....	20
Line Art.....	20
Source Type.....	21
Collection.....	21
Collection.....	21
Invert.....	21
Layer.....	21
Material.....	21
Line Thickness.....	21
Opacity.....	21
Object.....	21
Object.....	21
Layer.....	22
Material.....	22
Line Thickness.....	22
Opacity.....	22
Scene.....	22
Layer.....	22
Material.....	22
Line Thickness.....	22
Opacity.....	22
Edge types subpanel.....	22
Illumination filtering.....	22
Use Contour.....	22

Silhouette Filtering.....	23
Use Crease.....	23
Crease Threshold.....	23
Crease.....	23
Material Borders.....	23
Intersections.....	23
Edge Marks.....	23
Loose.....	23
Light Contour.....	23
Cast Shadow.....	23
Allow Overlapping Types.....	23
Light Reference subpanel.....	23
Light Object.....	23
Shadow Camera Size.....	23
Near.....	24
Far.....	24
Geometry Processing subpanel.....	24
Custom Camera.....	24
Overlapping Edges as Contour.....	24
Instanced Objects.....	24
Clipping Boundaries.....	24
Crease on Smooth.....	24
Crease on Sharp.....	24
Force Back Face Culling.....	24
Occlusion Subpanel.....	25
Range.....	25
Material Mask subpanel.....	25
Masks.....	25
Exact match.....	25
Intersection subpanel.....	25
Collection Masks.....	25
Exact match.....	25
Face Mask Filtering subpanel.....	25
Invert.....	25
Boundaries.....	25
Keep Contour.....	25
Chain.....	25
Intersection with Contour.....	25
All Lines.....	26
Loose Edges.....	26
Loose As Contour.....	26
Preserve Details.....	26
Geometry Space.....	26
Image Threshold.....	26
Smooth tolerance.....	26
Angle Splitting.....	26
Vertex Weight Transfer subpanel.....	26
Filter Source.....	26
Invert Vertex Group.....	26
Match Output.....	26
Target.....	26
Composition.....	27
Overscan.....	27

Image boundary trimming.....	27
Depth Offset.....	27
Towards custom camera.....	27
Bake subpanel.....	27
Bake Line Art / Bake Line Art (All).....	27
Clear Baked Line Art / Clear Baked Line Art (All).....	27
Mirror.....	27
Object.....	27
Influence.....	27
Layer.....	27
Invert.....	28
Pass.....	28
Invert.....	28
Material.....	28
Invert.....	28
Pass.....	28
Invert.....	28
Multiple Strokes.....	28
Duplicates.....	28
Distance.....	28
Offset.....	28
Fade.....	28
Center.....	29
Thickness.....	29
Opacity.....	29
Influence.....	29
Layer.....	29
Invert.....	29
Pass.....	29
Invert.....	29
Material.....	29
Invert.....	29
Pass.....	29
Invert.....	29
Outline.....	29
Thickness.....	30
Keep Shape.....	30
Subdivisions.....	30
Sample Length.....	30
Outline material.....	30
Target object.....	30
Influence.....	30
Layer.....	30
Invert.....	31
Pass.....	31
Invert.....	31
Simplify.....	31
Mode.....	31
Fixed.....	31
Adaptive.....	31
Sample.....	31
Merge.....	31
Iterations.....	31

Influence.....	31
Layer.....	31
Invert.....	31
Pass.....	32
Invert.....	32
Material.....	32
Invert.....	32
Pass.....	32
Invert.....	32
Subdivide.....	32
Subdivision Type.....	32
Catmull-Clark.....	32
Simple.....	32
Subdivisions.....	32
Influence.....	32
Layer.....	32
Invert.....	33
Pass.....	33
Invert.....	33
Material.....	33
Invert.....	33
Pass.....	33
Invert.....	33

Grease Pencil - Generate modifiers

Some of the modifiers are just available for specific object types.

Left grease pencil object, right a mesh object.

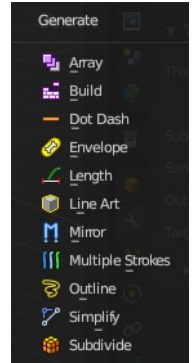

Array

The Array modifier creates an array of copies of the base object. Each copy can offset from the previous one in any of a number of possible ways. Vertices in adjacent copies can be merged if they are nearby, allowing smooth Subdivision Surface frameworks to be generated.

This modifier can be useful when combined with tillable meshes for quickly developing large scenes. It is also useful for creating complex repetitive shapes.

Multiple Array modifiers may be active for an object at the same time. This allows to create complex three-dimensional constructs.

Hint for Offset Calculation. The transformation applied from one copy to the next is calculated as the sum of the three different components (Relative, Constant and Object), each of which can be enabled/disabled independently of the others. This allows, for example, a relative offset of (1.0, 0.0, 0.0) and a constant offset of (0.1, 0.0, 0.0), giving an array of objects neatly spaced along the X axis with a constant 0.1 unit between them, whatever the original object's size.

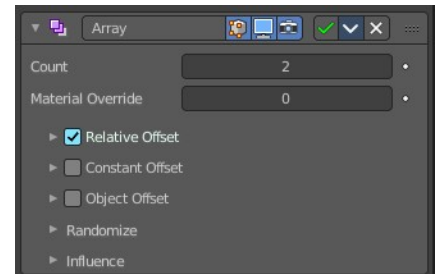

Count

Number of Items

Material Override

Index of the material used for generated strokes. A value of 0 uses the original material.

Relative Offset subpanel

Factor X/Y/Z

Adds a translation equal to the object's bounding box size along each axis to

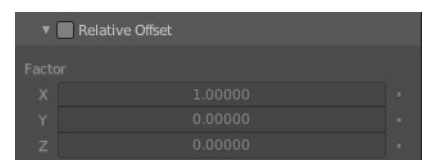

the offset, multiplied by a scaling factor. X, Y and Z scaling factors can be specified.

Constant Offset subpanel

Distance X/Y/Z

Adds a constant translation component to the duplicate object's offset. X, Y and Z constant components can be specified.

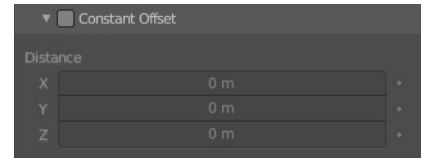

Object Offset subpanel

Adds a transformation taken from a chosen object relative to the current object to the offset.



Object

Choose an object.

Randomize

Randomize the transform values.

Offset

Randomize the offset values.

Rotation

Randomize the rotation values.

Scale

Randomize the scale values.

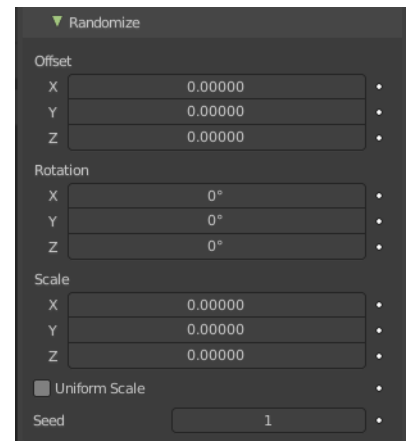

Uniform Scale

Use uniform scaling.

Seed

The random seed value.

Influence subpanel

Layer

Restricts the effect only to one layer or to any layers that share the same pass index. Click to pick the layer that you want to use.

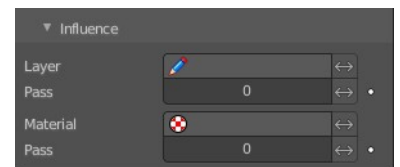

Inverse Layers

Inverts the influence.

Pass

The layer pass index.

Inverse Pass

Inverts the influence.

Material

Restricts the effect only to material that share the same material or pass index. Click to pick the material that you want to use.

Invert Materials

Inverts the influence.

Pass

The material pass index.

Inverse Pass

Inverts the influence.

Build

The Build modifier lets the strokes of the grease pencil object appear or disappear over time when you play the animation.

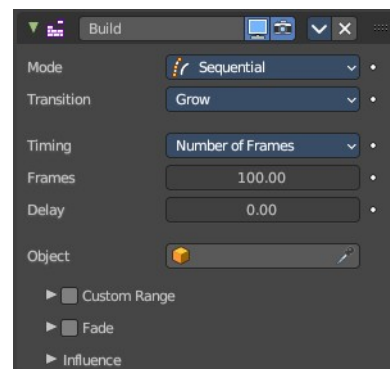

Mode

How many strokes are animated at the same time.

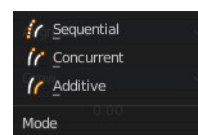

Sequential mode

Strokes appear or disappear one after the other.

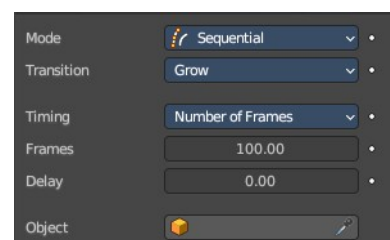

Transition

How the strokes are animated. The items should be self explaining.

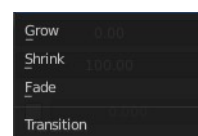

Timing

How to calculate the timing of the frames.

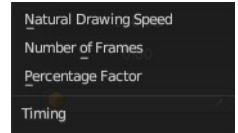

Natural Drawing Speed

Use recorded speed multiplied by a factor.

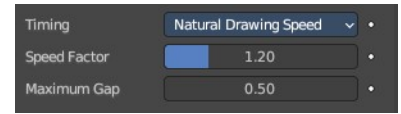

Speed Factor

Multiply recorded drawing speed by a factor.

Maximum Gap

The maximum gap between strokes in seconds.

Number of Frames

Set a fixed number of frames for all build animations.

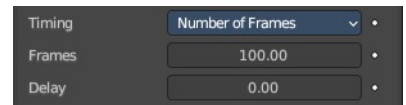

Frames

Maximum number of frames that the build effect can run.

Delay

Number of frames to delay before the modifier has any effect.

Percentage Factor

Set a manual percentage to build.

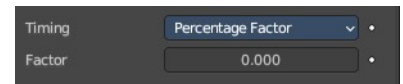

Factor

How much the stroke is visible.

Object

Pick an object as the starting position.

Concurrent Mode

All strokes appear or disappear at once.

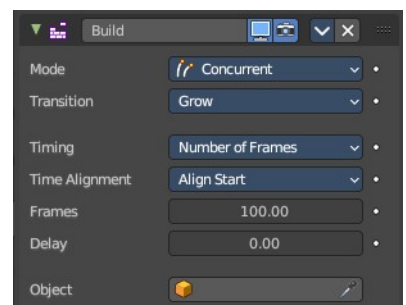

Transition

How the strokes are animated.

Grow

Grow over the animation time.

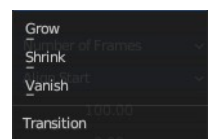

Shrink

Shrink over the animation time.

Vanish

Vanish over the animation time.

Timing

What method to use to build animations. Number of frames, or percentage.

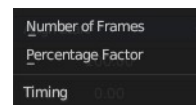

Number of frames

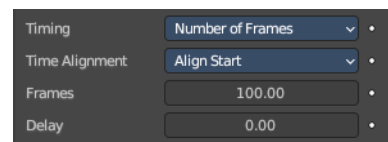

Time Alignment

When strokes should start to appear or disappear.

Align Start

All strokes appears at the same time.



Align End

All strokes disappears at the same time.

Frames

Maximum number of frames that the build effect can run.

Delay

Number of frames after each GP keyframe before the modifier has any effect.

Percentage Factor

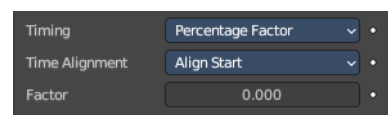

Time Alignment

When strokes should start to appear or disappear.

Align Start

All strokes appears at the same time.



Align End

All strokes disappears at the same time.

Factor

How much the stroke is visible.

Object

Pick an object as the starting position.

Additive

Builds only new strokes. Assumes additive painting.

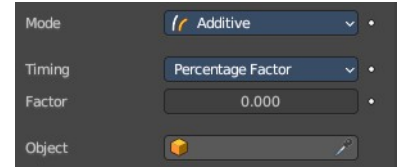

Timing

What method to use to build animations.

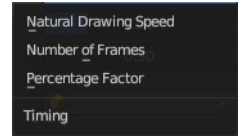

Natural Drawing Speed

Speed Factor

Multiply the recording speed by a factor.

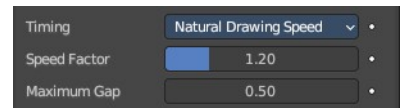

Maximum Gap

The maximum gap between strokes in seconds.

Number of frames

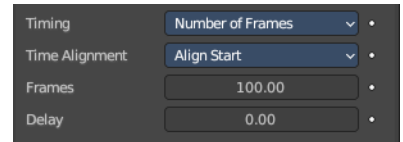

Time Alignment

When strokes should start to appear or disappear.

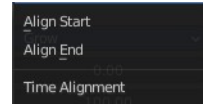

Align Start

All strokes appears at the same time.

Align End

All strokes disappears at the same time.

Frames

Maximum number of frames that the build effect can run.

Delay

Number of frames after each GP keyframe before the modifier has any effect.

Percentage Factor



Time Alignment

When strokes should start to appear or disappear.



Align Start

All strokes appears at the same time.

Align End

All strokes disappears at the same time.

Factor

How much the stroke is visible.

Start delay

Number of frames after each GP keyframe before the modifier has any effect.

Frames

Maximum number of frames that the build effect can run.

Object

Pick an object as the starting position.

Custom Range

Only modify strokes that lies in the specified time frame.

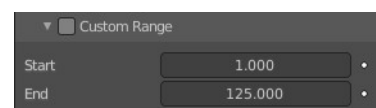

Start

The first frame of the range.

End

The last frame of the range.

Fade subpanel

Fade out strokes instead of cutting them off.

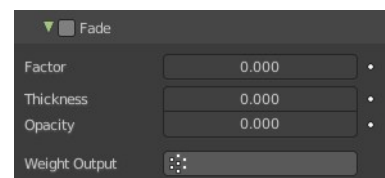

Factor

The factor for how much the stroke is fading out.

Thickness

How much strength fading applies on top of stroke thickness.

Opacity

How much strength fading applies on top of stroke opacity.

Weight Output

Limit the fade to a vertex group.

Influence subpanel

Layer

Restricts the effect only to one layer or to any layers that share the same pass



index. Click to pick the layer that you want to use.

Inverse Layers

Inverts the influence.

Pass

The layer pass index.

Inverse Pass

Inverts the influence.

Dot Dash

Turns a grease pencil stroke into a dotted line.

Offset

The offset into each stroke before the dot creation starts.

Segment list

Manage the single segments of the dotted dash. Segments gets repeated as they appear in the list. Means when you just have one segment in the list, then this shape will be repeated. When you have two, then the first will be displayed, then the second, then the first, and so on. Every segment can have its own settings. Which are managed below.

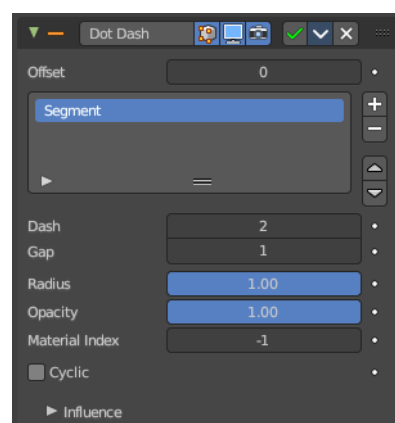

Add Segment

Add a new dash segment.

Remove Segment

Remove the dash segment.

Move Dash Segment up or down

Moves the selected dash segment up or down in the list.

Search element

By clicking at the triangle button you reveal a search field with which you can search through the list.



Edit Box

Type in the search term and hit enter.

Invert

Inverts the search term.

Sort by name

Sorts the list alphabetically.

Reverse

Inverts the list.

Dash

The number of points (vertices) from the original stroke to include in this segment.

Gap

The number of points (vertices) skipped after this segment.

Radius

The radius of the segment. Maximum is 1 of the original stroke.

Opacity

The visibility of this segment.

Material Index

What material to use.

Cyclic

Enable cyclic on individual stroke dashes.

Influence subpanel

Layer

Restricts the effect only to one layer or to any layers that share the same pass index. Click to pick the layer that you want to use.

Inverse Layers

Inverts the influence.

Pass

The layer pass index.

Inverse Pass

Inverts the influence.

Material

Restricts the effect only to material that share the same material or pass index. Click to pick the material that you want to use.

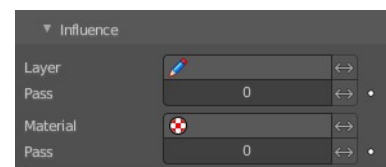

Invert Materials

Inverts the influence.

Pass

The material pass index.

Inverse Pass

Inverts the influence.

Envelope

Generates an envelope shape that connects all points in this envelope.

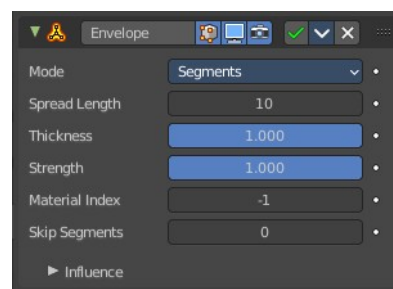

Mode

Deform

Deform the stoke to best match the envelope shape.

Segments

Add segments to create the envelope. Keep the original stroke.

Fills

Add Fill segments to create the envelope. This method does not keep the original stroke.

Spread Length

The number of points to skip to create straight segments.

Thickness

Thickness multiplier for the thickness of the new stroke.

Strength

Strength multiplier for the strength of the new stroke.

Material Index

The material index of the material that is used.

Skip Segments

Define a number of segments to skip to reduce the complexity.

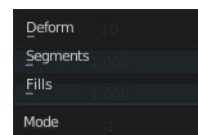

Influence subpanel

Layer

Restricts the effect only to one layer or to any layers that share the same pass index. Click to pick the layer that you want to use.

Inverse Layers

Inverts the influence.

Pass

The layer pass index.

Inverse Pass

Inverts the influence.

Material

Restricts the effect only to material that share the same material or pass index. Click to pick the material that you want to use.

Invert Materials

Inverts the influence.

Pass

The material pass index.

Inverse Pass

Inverts the influence.

Vertex Group

Assign a vertex group to modulate the deform.

Inverse Pass

Inverts the influence.

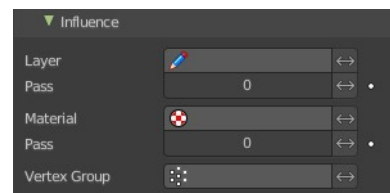

Length

The Length Modifier extends or shortens the original strokes length.

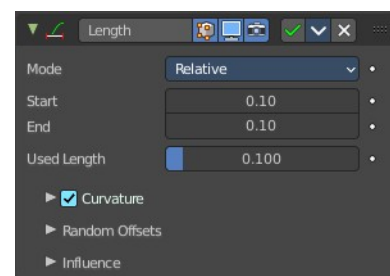

Mode

Defines the mode to use for the length calculation. Relative to the length of the grease pencil stroke, or absolute in geometry space.



Factor Start/End

Length difference for each stroke.

Used Length

What position of the stroke is used for the calculation of the extension.

Curvature subpanel

Follow the curvature of the stroke.

Point Density

Multiplied by Start/End for the total added point count.

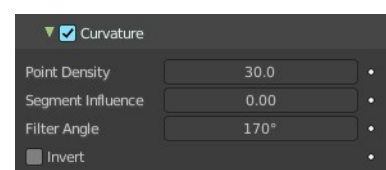

Segment Influence

How much the length of the individual segments should influence the final computed curvature.

Filter Angle

Ignore points of the stroke that derivate from their neighbours by more than this angle.

Invert

Invert the curvature of the stroke's extension.

Random Offset subpanel

Randomization for the start / end lengths.

Random offset Start

Size of random length added to the start of each stroke.

Random offset End

Size of random length added to the end of each stroke.

Random Noise Offset

Smoothly offset the random value of each stroke.

Seed

The random seed value.

Randomize subpanel

Use random values over time.

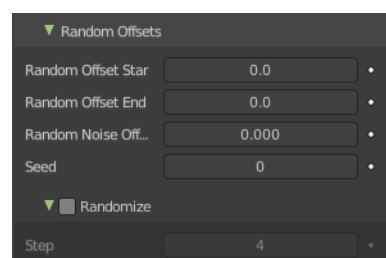

Step

Number of frames before recalculate random values again.

Influence subpanel

Layer

Restricts the effect only to one layer or to any layers that share the same pass index. Click to pick the layer that you want to use.

Inverse Layers

Inverts the influence.

Pass

The layer pass index.

Inverse Pass

Inverts the influence.

Material

Restricts the effect only to material that share the same material or pass index. Click to pick the material that you want to use.

Invert Materials

Inverts the influence.

Pass

The material pass index.

Inverse Pass

Inverts the influence.

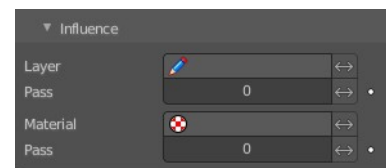

Line Art

The Line Art modifier generates stylized line art from the scene or selected source collection or objects.

Note that due to lack of global cache at the moment, each Line Art modifier will run the entire occlusion calculation for itself. So if you have multiple line art modifiers to select different parts of the scene (to apply different styles, etc.), the evaluation will take much longer. There are plans to remedy this in the future, but this is a known limitation for now.

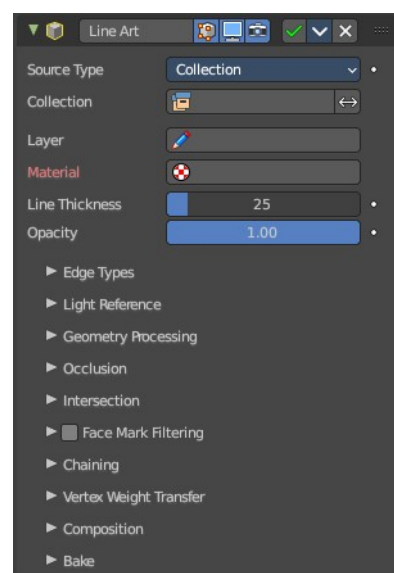

This modifier requires to have a **ACTIVE** camera in the scene, since the outline is created from this active camera. And the outline is created from exact this view of the camera. So better switch to camera view to check if the view fits.

The active camera has the active orange triangle above the widget. You can also see the active camera in the Scene properties.

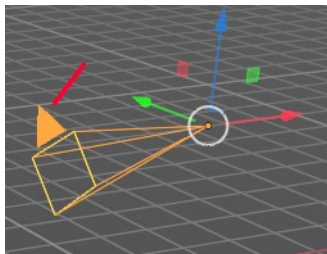
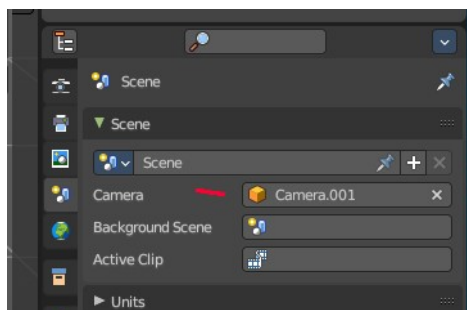

Source Type

What type of geometry source should line art be generated from.

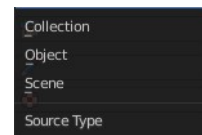

Collection

Collection

The collection where you want to apply the line art to.

Invert

Inverts the selection of collections.

Layer

Grease Pencil layer that is assigned to the generated strokes.

Material

Grease pencil material assigned to the generated strokes.

Line Thickness

The thickness of the line.

Opacity

The opacity of the line.

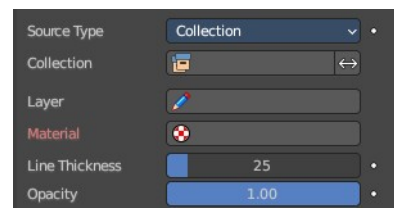

Object

Object

The object where you want to apply the line art to.

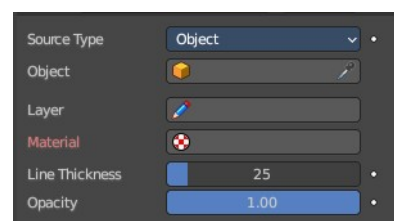

Layer

Grease Pencil layer that is assigned to the generated strokes.

Material

Grease pencil material assigned to the generated strokes.

Line Thickness

The thickness of the line.

Opacity

The opacity of the line.

Scene

Applies the line art grease pencil strokes to the whole scene.

Layer

Grease Pencil layer that is assigned to the generated strokes.

Material

Grease pencil material assigned to the generated strokes.

Line Thickness

The thickness of the line.

Opacity

The opacity of the line.

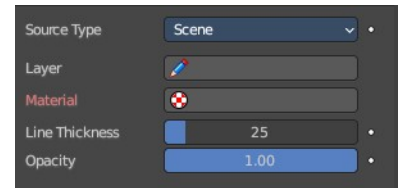

Edge types subpanel

Which kind of edges to influence.

Illumination filtering

You need to pick a light object in the Light Reference panel. How to thread the shadow region filtering. The names should be self explaining.

Use Contour

Use a contour.

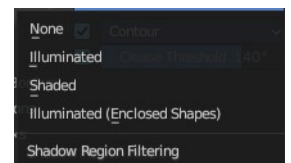
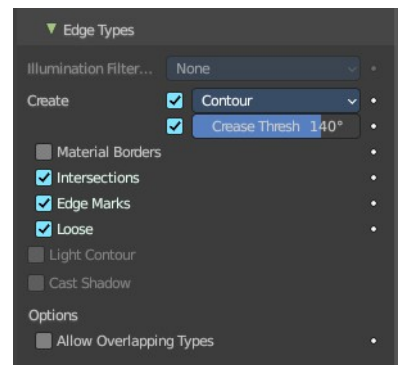

Silhouette Filtering

What kind of contour to use.

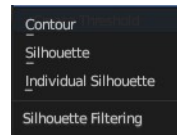

Use Crease

Generate strokes from crease edges.

Crease Threshold

Angles smaller than this value will be treated as creases.

Crease

Influence crease edges. The angle what edges are treated as creases can be adjusted in the edit box.

Material Borders

Generate strokes from borders between materials.

Intersections

Generate strokes from intersections.

Edge Marks

Generate strokes from edge marks.

Loose

Generate strokes from loose geometry.

Light Contour

You need to pick a light object in the Light Reference panel. Generate light shadow separation lines from a referenced light object.

Cast Shadow

You need to pick a light object in the Light Reference panel. The line casts shadow.

Allow Overlapping Types

Allow an edge to have multiple overlapping types.

Light Reference subpanel

This panel allows you to add a light object as a source for line art.

Light Object

Pick the light source.

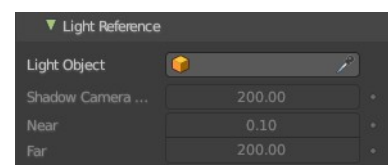

Shadow Camera Size

Represents the orthographic scale of an ortho camera. It calculates the area to cover.

Near

The near clip plane of the shadow camera.

Far

The far clip plane of the shadow camera.

Geometry Processing subpanel

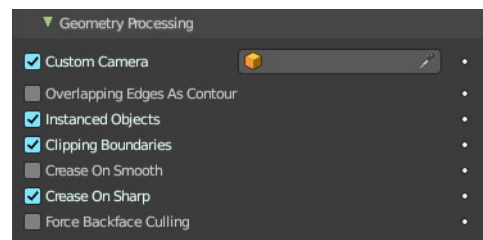

Custom Camera

Allows to pick a different camera than the active scene camera for line art rendering.

Overlapping Edges as Contour

This option allows overlapping edges (e.g. from an edge split modifier or imported geometry where two edges occupy the exact same space) to be drawn as contour. Enabling this option will slow down the calculation slightly but it will handle edge overlapping cases without erroneous occlusion results.

Instanced Objects

This option enables particles and other instanced objects to be loaded for line art calculation. There will be performance impact when there are a large amount of instanced objects in the scene.

Clipping Boundaries

When enabled, line art will generate clipping lines as contour type at the place where near or far clipping planes cut the model. Otherwise there will be no lines.

Crease on Smooth

Allow crease edges to show inside smooth surfaces.

Crease on Sharp

Allow crease to show on sharp edges.

Force Back Face Culling

Remove all backfaces to speed up calculation.

Occlusion Subpanel

Range

If enabled, the modifier will select lines that have an occlusion level between start and end values.

If not enabled just a single Level value slider shows.

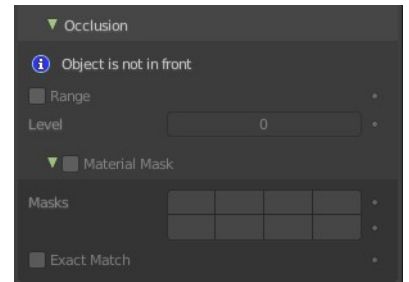

Material Mask subpanel

Use material masks to filter out occluded strokes. You need to have a range level higher than 0.

Masks

Choose up to eight mask bits for the masking.

Exact match

Require matching all material masks instead of just one.

Intersection subpanel

Collection Masks

Choose up to eight mask bits for masking.

Exact match

Require matching all intersections instead of just one.



Face Mask Filtering subpanel

Filter Feature Lines using Freestlye Face Masks.

Invert

Invert face mask filtering.

Boundaries

Filter feature lines based on face mask boundaries.

Keep Contour

Preserve contour lines while filtering.

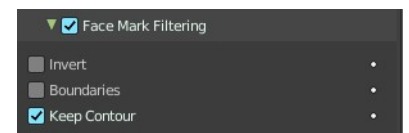

Chain

Intersection with Contour

Allows intersection lines to be chained together with contour lines.

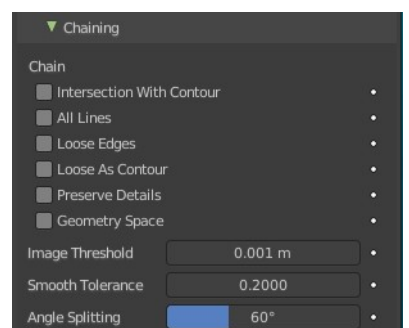

All Lines

Enabling this option will cause all lines to have the type of contour and to be chained together.

Loose Edges

Allow loose edges to be chained together.

Loose As Contour

Loose edges will have contour type.

Preserve Details

Keep the zig-zag noise in initial channing.

Geometry Space

Use Geometry distance for chaining instead of image space.

Image Threshold

Segments with an image distance smaller than this value will be chained together.

Smooth tolerance

Strength of smoothing applied on jagged chains.

Angle Splitting

The angle in screen space below which a stroke is split into two.

Vertex Weight Transfer subpanel

Filter Source

If source mesh has vertex groups whose name starts with this string, then the vertex weight info will be transferred into weight groups in Grease Pencil strokes.

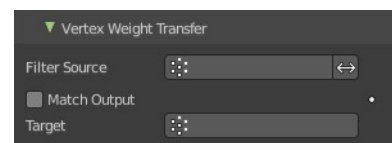

Invert Vertex Group

Inverts the selection.

Match Output

Transfer the filtered object vertex weights into Grease Pencil weight groups with the same names as the filtered ones.

Target

If Match Output is off, then a target vertex group has to be specified. If there are multiple weight groups copied into target, then the highest weight value is copied into it.

Composition

Overscan

A margin to prevent an abrupt end of the stroke at the edge of the image.

Image boundary trimming

Trim all edges right at the boundary of image (including overscan region)

Depth Offset

Move strokes slightly towards the camera to avoid clipping.

Towards custom camera

Offset strokes towards selected camera instead of the active camera.

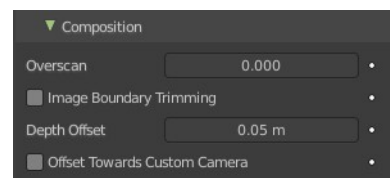

Bake subpanel

Bake Line Art / Bake Line Art (All)

Bakes Line Art strokes for active Grease Pencil object within the start, end frame range in scene.

Bake Line Art (All) bakes all Grease Pencil objects that contains at least one Line Art modifier. After baking, baked Line Art modifier will be deactivated automatically.

Clear Baked Line Art / Clear Baked Line Art (All)

Clears baked line art frames within the scene frame range for active Grease Pencil object.

Clear Baked Line Art (All) applies the same operation for all Grease Pencil objects that contains at least one Line Art modifier.

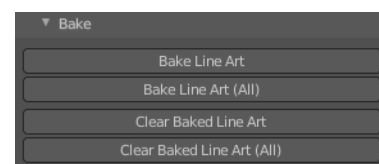

Mirror

The Mirror modifier for the Grease Pencil Object works in Object mode. It mirrors the object along its local X, Y and/or Z axes, across the Object Origin.

It can also use another object as the mirror center, then use that object's local axes instead of its own.

Object

Define an object to mirror at its origin instead of mirroring along the grease pencil origin.

You can animate it to move the mirror axis.

Influence

Layer

Restricts the effect only to one layer or to any layers that share the same pass

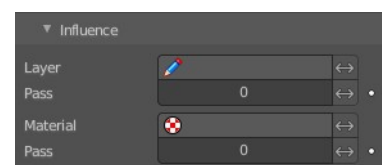

index. Click to pick the layer that you want to use.

Invert

Inverts the influence.

Pass

The layer pass index.

Invert

Inverts the influence.

Material

Restricts the effect only to material that share the same material or pass index. Click to pick the material that you want to use.

Invert

Inverts the influence.

Pass

The material pass index.

Invert

Inverts the influence.

Multiple Strokes

Adds multiple parallel copies of the stroke around the original stroke.

Duplicates

The number of additional strokes.

Distance

Distance between the original and the duplicate strokes.

Offset

Control the offset position (inner or outer) for duplicate strokes.

Fade

Fade out duplicate strokes, using their opacity or thickness.

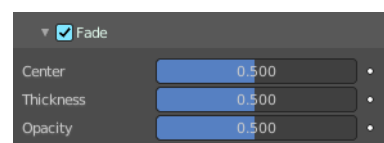
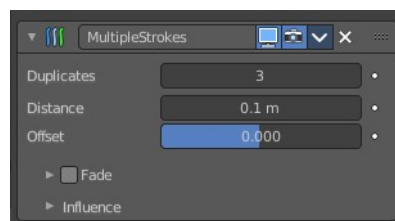

Center

Control the initial position for the fading.

Thickness

Fade influence on strokes thickness.

Opacity

Fade influence on strokes opacity.

Influence

Layer

Restricts the effect only to one layer or to any layers that share the same pass index. Click to pick the layer that you want to use.

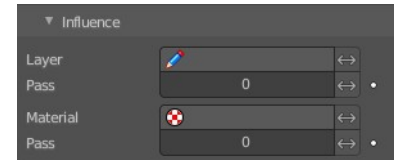

Invert

Inverts the influence.

Pass

The layer pass index.

Invert

Inverts the influence.

Material

Restricts the effect only to material that share the same material or pass index. Click to pick the material that you want to use.

Invert

Inverts the influence.

Pass

The material pass index.

Invert

Inverts the influence.

Outline

Draws an outline around the grease pencil stroke.

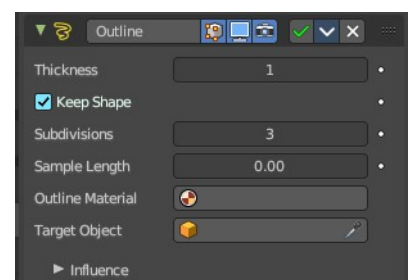

This modifier requires to have a **ACTIVE** camera in the scene, since the outline is created from this active camera. And the outline is created from exact this view of the camera. So better switch to camera view to check if the view fits. You will get a warning in the modifier when the active camera is missing.

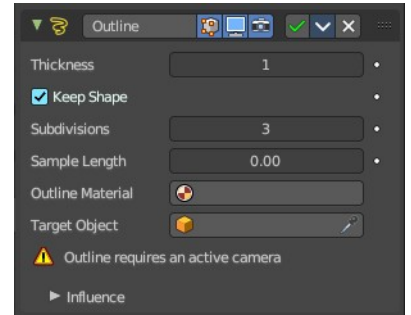

The active camera has the active orange triangle above the widget. You can also see the active camera in the Scene properties.

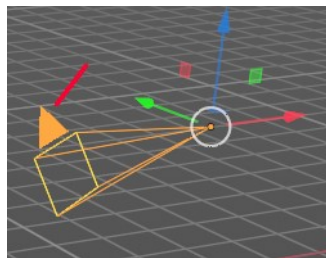
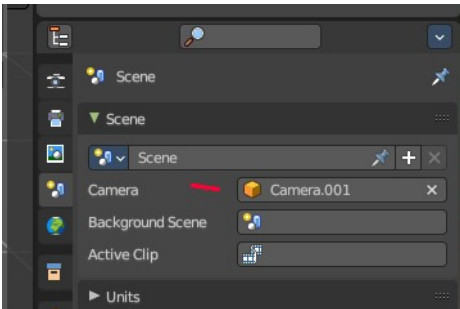

Thickness

The thickness of the outline.

Keep Shape

Try to keep global shape.

Subdivisions

Subdivisions of the outline grease pencil stroke.

Sample Length

The distance between the vertices.

Outline material

Material used for the outline strokes. If no material is chosen then the material from the parent stroke is used.

Target object

A target object to define the stroke start.

Influence

Layer

Restricts the effect only to one layer or to any layers that share the same pass index. Click to pick the layer that you want to use.

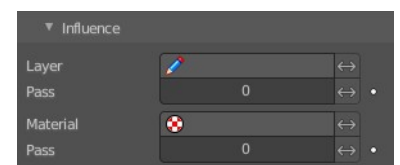

Invert

Inverts the influence.

Pass

The layer pass index.

Invert

Inverts the influence.

Simplify

The Simplify modifier allows you to reduce the amount of points in the strokes. It tries to reduce points while maintaining the lines shape.

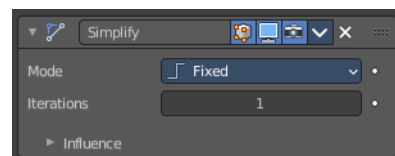

Mode

How to reduce points in the strokes.

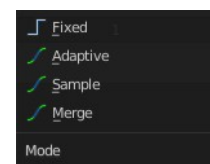

Fixed

Deletes alternated points in the strokes, except the start and end points.

Adaptive

Uses the RDP algorithm (Ramer-Douglas-Peucker algorithm) for points deletion. The algorithm try to obtain a similar line shape with fewer points.

Sample

Recreates the stroke geometry with a predefined length between points.

Merge

Simplifies the strokes by merging points that are closer than a specified distance to each other.

Iterations

Number of times to repeat the procedure.

Influence

Layer

Restricts the effect only to one layer or to any layers that share the same pass index. Click to pick the layer that you want to use.

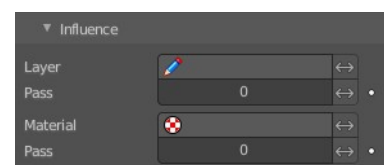

Invert

Inverts the influence.

Pass

The layer pass index.

Invert

Inverts the influence.

Material

Restricts the effect only to material that share the same material or pass index. Click to pick the material that you want to use.

Invert

Inverts the influence.

Pass

The material pass index.

Invert

Inverts the influence.

Subdivide

The Subdivide modifier subdivide the strokes by inserting points between other points to the lines.

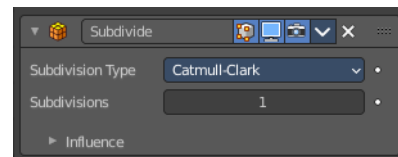

Subdivision Type

Catmull-Clark

Subdivides and smooths the surfaces.

Simple

Only subdivides the surfaces, without any smoothing.



Subdivisions

Number of subdivisions.

Influence

Layer

Restricts the effect only to one layer or to any layers that share the same pass index. Click to pick the layer that you want to use.

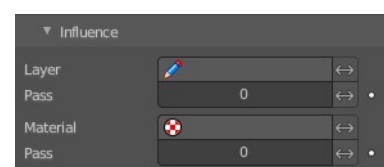

Invert

Inverts the influence.

Pass

The layer pass index.

Invert

Inverts the influence.

Material

Restricts the effect only to material that share the same material or pass index. Click to pick the material that you want to use.

Invert

Inverts the influence.

Pass

The material pass index.

Invert

Inverts the influence.



26.9.12 Editors - Properties Editor - Modifiers Properties Tab - Grease Pencil - Deform Modifiers

Table of content

Detailed table of content.....	1
Deform modifiers.....	5
Armature.....	5
Hook.....	7
Lattice.....	9
Noise.....	10
Offset.....	13
Shrinkwrap.....	15
Smooth.....	18
Thickness.....	20

Detailed table of content

Detailed table of content

Detailed table of content.....	1
Deform modifiers.....	5
Armature.....	5
Object.....	5
Vertex Group.....	5
Invert.....	6
Bind to.....	6
Vertex Groups.....	6
Bone Envelopes.....	6
Hook.....	7
Object.....	7
Vertex Group.....	7
Invert.....	7
Strength.....	7
Reset.....	7
Recenter.....	7
Select.....	8
Assign.....	8
Falloff.....	8
Type.....	8
Radius.....	8
Uniform Falloff.....	8
Influence.....	8
Layer.....	8
Invert.....	8
Pass.....	8
Invert.....	8
Material.....	8

Invert.....	8
Pass.....	8
Invert.....	9
Lattice.....	9
Object.....	9
Vertex Group.....	9
Invert.....	9
Strength.....	9
Influence.....	9
Layer.....	9
Invert.....	9
Pass.....	9
Invert.....	9
Material.....	10
Invert.....	10
Pass.....	10
Invert.....	10
Noise.....	10
Position.....	10
Strength.....	10
Thickness.....	10
UV.....	10
Noise Scale.....	10
Noise Offset.....	10
Noise Seed.....	10
Randomize.....	10
Step.....	11
Influence.....	11
Layer.....	11
Invert.....	11
Pass.....	11
Invert.....	11
Material.....	11
Invert.....	11
Pass.....	11
Invert.....	11
Vertex Group.....	11
Invert.....	11
Custom Curve.....	11
Navigation elements.....	12
Zoom in and out.....	12
Tools.....	12
Reset View.....	12
Vector Handle.....	12
Auto Handle.....	12
Auto Clamped Handle.....	12
Extend Horizontal.....	12
Extend Vertical.....	12
Reset Curve.....	12
Use Clipping.....	12
Delete Points.....	12
Curve window.....	12
X / Y.....	13

Offset.....	13
General Subpanel.....	13
Location X, Y, Z.....	13
Rotation X, Y, Z.....	13
Scale X, Y, Z.....	13
Advanced Subpanel.....	13
Mode.....	13
Random.....	13
Layer.....	13
Stroke.....	13
Material.....	13
Offset.....	13
Rotation.....	13
Scale.....	14
Uniform Scale.....	14
Seed.....	14
Layer Step.....	14
Layer Offset.....	14
Stroke Step.....	14
Stroke Offset.....	14
Material Step.....	14
Material Offset.....	14
Influence subpanel.....	14
Layer.....	14
Invert.....	14
Pass.....	14
Invert.....	14
Material.....	15
Invert.....	15
Pass.....	15
Invert.....	15
Vertex Group.....	15
Invert.....	15
Shrinkwrap.....	15
Wrap Method.....	15
Nearest Surface Point + Target Normal Project.....	15
Snap Mode.....	15
Target.....	15
Project.....	16
Snap Mode.....	16
Limit.....	16
Subdivision Levels.....	16
Axis.....	16
Negative/Positive.....	16
Face Cull.....	16
Invert Cull.....	16
Target.....	16
Auxiliary Target.....	16
Nearest Vertex.....	17
Target.....	17
Offset.....	17
Smooth factor.....	17
Repeat.....	17

Vertex Group.....	17
Invert.....	17
Influence subpanel.....	17
Layer.....	17
Invert.....	17
Pass.....	17
Invert.....	17
Material.....	17
Invert.....	17
Pass.....	18
Invert.....	18
Vertex Group.....	18
Invert.....	18
Smooth.....	18
Mode.....	18
Position.....	18
Strength.....	18
Thickness.....	18
UV.....	18
Factor.....	18
Repeat.....	18
Influence.....	19
Layer.....	19
Invert.....	19
Pass.....	19
Invert.....	19
Material.....	19
Invert.....	19
Pass.....	19
Invert.....	19
Vertex Group.....	19
Invert.....	19
Custom Curve.....	19
Navigation elements.....	19
Zoom in and out.....	20
Thickness.....	20
Uniform Thickness.....	20
Thickness Factor.....	20
Weighted.....	20
Influence.....	20
Layer.....	20
Invert.....	20
Pass.....	20
Invert.....	20
Material.....	20
Invert.....	20
Pass.....	20
Invert.....	21
Vertex Group.....	21
Invert.....	21
Custom Curve.....	21
Navigation elements.....	21
Zoom in and out.....	21

Tools.....	21
Reset View.....	21
Vector Handle.....	21
Auto Handle.....	21
Auto Clamped Handle.....	21
Extend Horizontal.....	21
Extend Vertical.....	21
Reset Curve.....	22
Use Clipping.....	22
Delete Points.....	22
Curve window.....	22
X / Y.....	22

Deform modifiers



Armature

An armature system allows to deform objects accurately by posing bones. The Armature modifier contains the armature settings at the mesh end.

This modifier gets created automatically when you parent a grease pencil to an armature.

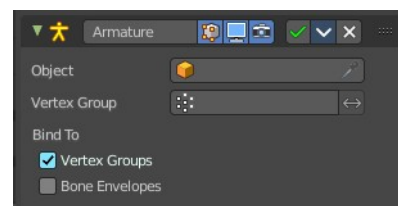

Object

The name of the armature object used by this modifier.

Vertex Group

A vertex group of the object, which weights will be used to determine the influence of this modifier's results when mixing it with the results from other Armature ones.

This is only of use when having at least two of these modifiers on the same object, with Multi Modifier activated.

Invert

Inverts the influence set by the vertex group.

Bind to

Vertex Groups

Meshes and lattices only. Use Vertex groups for deforming the mesh. A bone named “forearm”, will only affect the vertices in the “forearm” vertex group. The influence of one bone on a given vertex is controlled by the weight of this vertex in the relevant group.

The vertex groups are located in the Object Data Properties in the Properties editor.

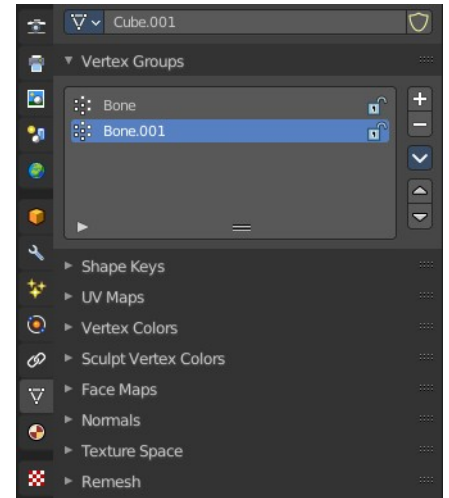

Bone Envelopes

Use the Bone envelopes to deform vertices or control points near them, defined by each bone’s envelope radius and distance.

When envelopes are disabled, Blender uses the set of existing vertex group names to determine which bones influences what mesh part.

Bone envelopes display can be turned on in the Viewport Display panel in the Object Data properties tab in the Properties Editor. Display as ...

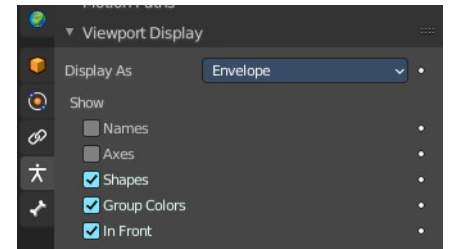

And can be adjusted in the Transform panel in the sidebar of the 3D View, in Edit mode.

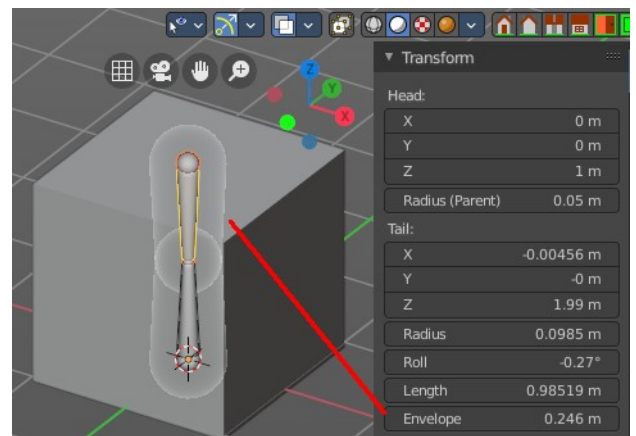

Hook

The Hook modifier is used to deform a mesh, curve or lattice by another object. When you move this hook object, then it pulls vertices or control points with it.

Assigning the hook object to specific vertices of the target object is done in Edit mode. The modifier shows a set of buttons then.

This modifier is automatically created when you add a Hook from the Hooks menu in the Edge menu in edit mode.

Some settings just exists in Edit mode.

Warning! The Hook Modifier stores vertex indices from the original mesh to determine what to affect. Modifiers that generate geometry, like Subdivision Surface, should always be put after the Hook modifier in the stack. Otherwise, the generated geometry can't be affected by the hook's influence.

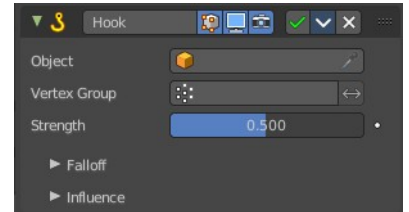

Object

The name of the object to hook vertices to.

Vertex Group

Allows you to define the influence per vertex.

Invert

Inverts the influence of the selected vertex group.

Strength

Adjust this hooks influence on the vertices.

Reset

In Edit mode. Recalculate and clear the offset transform of the hook.

Recenter

In Edit mode. Set the hook center to the 3D cursor position.

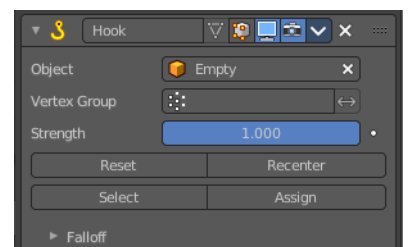
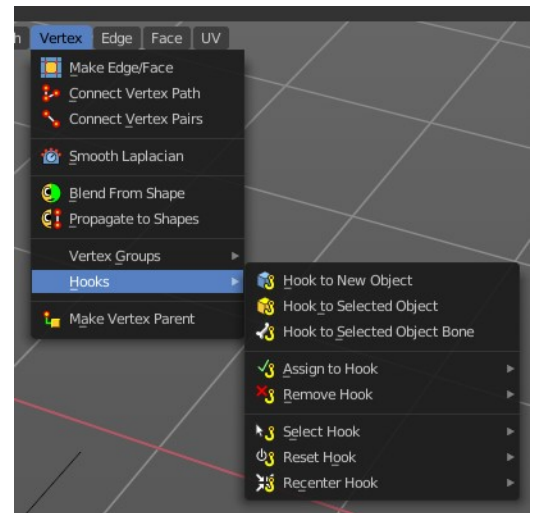

Select

In Edit mode. Select the vertices affected by this hook.

Assign

In Edit mode. Assigns selected vertices to this hook.

Falloff

Type

This can be used to adjust the kind of influence curve that the hook has on the mesh. You can also define a custom curve to get a much higher level of control.

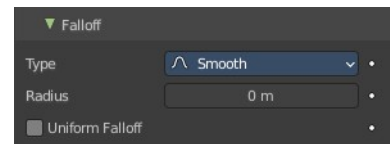

Radius

The size of the hooks influence.

Uniform Falloff

Compensate non uniform scale, and use a uniform falloff.

Influence

Layer

Restricts the effect only to one layer or to any layers that share the same pass index. Click to pick the layer that you want to use.

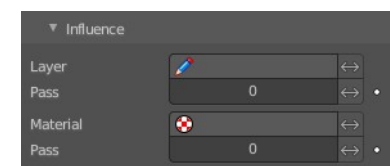

Invert

Inverts the influence.

Pass

The layer pass index.

Invert

Inverts the influence.

Material

Restricts the effect only to material that share the same material or pass index. Click to pick the material that you want to use.

Invert

Inverts the influence.

Pass

The material pass index.

Invert

Inverts the influence.

Lattice

The Lattice modifier deforms the base object by the shape of a Lattice object. It can be used at meshes, curves, surfaces, text, lattices and even particles.

A Lattice modifier with valid settings can be added by selecting the object, holding down shift, select the target lattice object, and then choose Lattice Deform in the Parent menu.

Note! When you want to use a lattice to deform particles, then you need to place the Lattice modifier after the Particle System modifier.

Object

The Lattice object that deforms the base object.

Vertex Group

Limit the modifier's effect to a vertex group of the base mesh.

Invert

Inverts the influence of the selected vertex group.

Strength

A factor to control blending between original and deformed vertex positions.

Influence

Layer

Restricts the effect only to one layer or to any layers that share the same pass index. Click to pick the layer that you want to use.

Invert

Inverts the influence.

Pass

The layer pass index.

Invert

Inverts the influence.

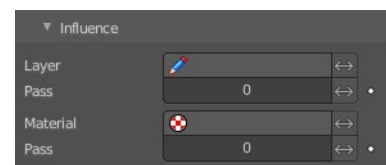
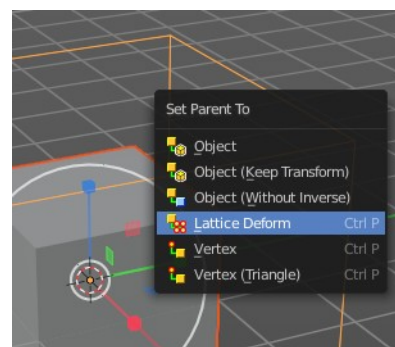
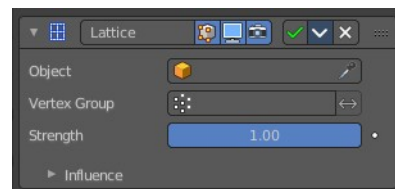

Material

Restricts the effect only to material that share the same material or pass index. Click to pick the material that you want to use.

Invert

Inverts the influence.

Pass

The material pass index.

Invert

Inverts the influence.

Noise

The Noise Modifier adds noise to make the grease pencil line unstable and noisy.

Position

Strength of the noise effect over the point location.

Strength

Strength of the noise effect over the point strength (opacity).

Thickness

Strength of the noise effect over the point thickness.

UV

Strength of the noise effect over the point UV rotation.

Noise Scale

Control the noise frequency scale.

Noise Offset

Offset the noise along the stroke.

Noise Seed

Add a random seed.

Randomize

Use a random value over time.

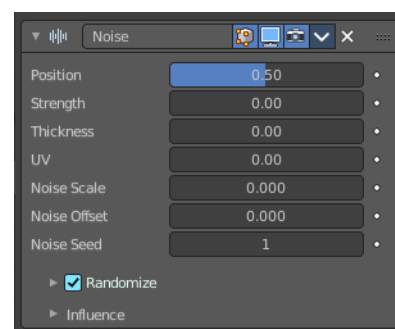

Step

Number of frames before using a new random value.

Influence

Layer

Restricts the effect only to one layer or to any layers that share the same pass index. Click to pick the layer that you want to use.

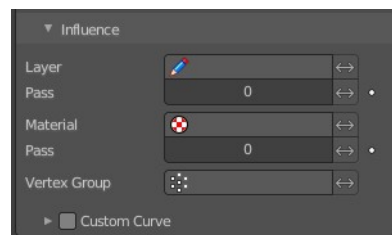

Invert

Inverts the influence.

Pass

The layer pass index.

Invert

Inverts the influence.

Material

Restricts the effect only to material that share the same material or pass index. Click to pick the material that you want to use.

Invert

Inverts the influence.

Pass

The material pass index.

Invert

Inverts the influence.

Vertex Group

Limit the influence to a vertex group.

Invert

Inverts the influence.

Custom Curve

Use a custom curve to define the noise along the strokes.

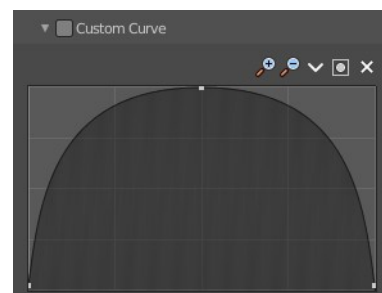

Navigation elements

The navigation elements at the top are described from left to right.



Zoom in and out

The two buttons with the magnifying glass at it zooms in and out in the curve window.

Tools

Tools is a menu where you can find some curve related tools.

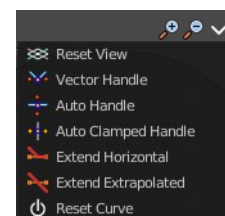

Reset View

Resets the curve windows zoom.

Vector Handle

Set handle type to Vector.

Auto Handle

Set handle type to Auto.

Auto Clamped Handle

Set handle type to Auto Clamped.

Extend Horizontal

Extend the curve points horizontal before the first curve point and after the last curve point.

Extend Vertical

Extend the curve points vertical before the first curve point and after the last curve point.

Reset Curve

Resets the curve to the initial shape.

Use Clipping

Clipping options. Set up clipping for the stroke.

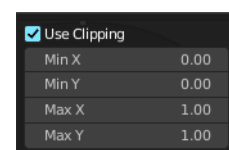

Delete Points

Deletes selected curve points.

Curve window

Tweak and adjust the falloff curve by clicking at a curve point and dragging it around.

Double click adds a new point.

Holding down ctrl activates temporary snapping.

Holding down shift enables slower movement, which allows more accurate

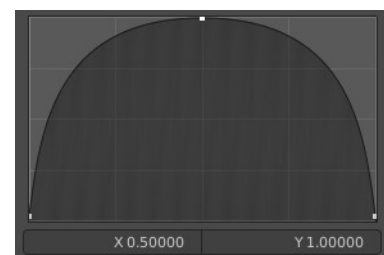

setting.

X / Y

The position of the currently selected curve point.

Offset

The Offset Modifier changes the strokes location, rotation or scale, starting from the object origin.

General Subpanel

Location X, Y, Z

Sets strokes location offset from its object origin.

Rotation X, Y, Z

Sets strokes rotation.

Scale X, Y, Z

Sets strokes scale.

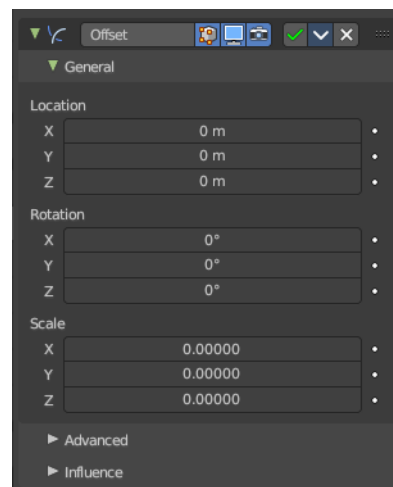

Advanced Subpanel

Mode

Random

Randomize Stroke Offset.

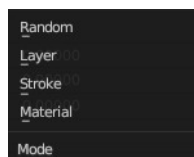

Layer

Offset Layers by the same factor.

Stroke

Offset stroke by the same factor based on stroke draw order.

Material

Offset materials by the same factor.

Offset

Randomize the offset in x y and z axis.

Rotation

Randomize the rotation in x y and z angle.

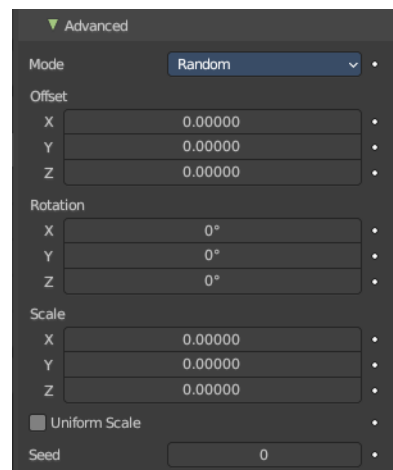

Scale

Randomize the size in x y and z axis.

Uniform Scale

Mode random. Use the same random seed for each scale axis for a uniform scale.

Seed

Mode Random. The random seed for the uniform scale.

Layer Step

Mode Seed. Number of elements that will be grouped.

Layer Offset

Mode Seed. Offset Starting Point.

Stroke Step

Mode Stroke. Number of elements that will be grouped.

Stroke Offset

Mode Stroke. Offset Starting Point.

Material Step

Mode Material. Number of elements that will be grouped.

Material Offset

Mode Material. Offset Starting Point.

Influence subpanel

Layer

Restricts the effect only to one layer or to any layers that share the same pass index. Click to pick the layer that you want to use.

Invert

Inverts the influence.

Pass

The layer pass index.

Invert

Inverts the influence.

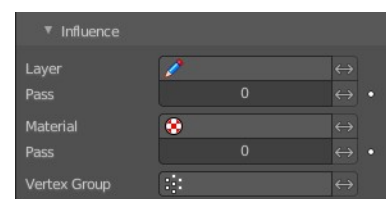

Material

Restricts the effect only to material that share the same material or pass index. Click to pick the material that you want to use.

Invert

Inverts the influence.

Pass

The material pass index.

Invert

Inverts the influence.

Vertex Group

Limit the influence to a vertex group.

Invert

Inverts the influence.

Shrinkwrap

Shrinks the geometry to the surface of another object.

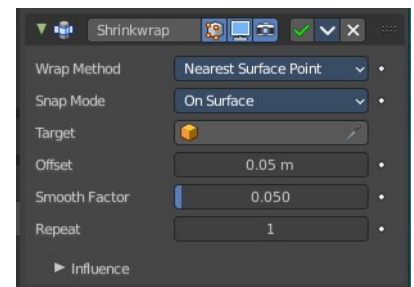

Wrap Method

The method to determine the nearest point on the target's surface for each vertex of the object.

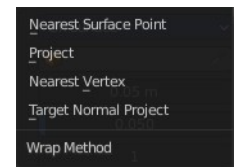

Nearest Surface Point + Target Normal Project

Nearest Surface Point selects the nearest point at the surface. Additionally, Target Normal Project tries to match the interpolated normals of the surface.

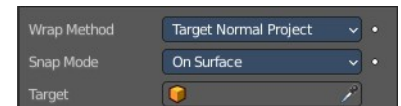

Snap Mode

How the vertex snaps to the surface. The methods should be self explaining.

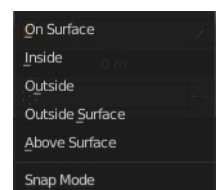

Target

The target mesh to shrink to.

Project

Projects all vertices along a chosen axis until they hit the surface of the target object.

Vertices that never hits the surface are not calculated.

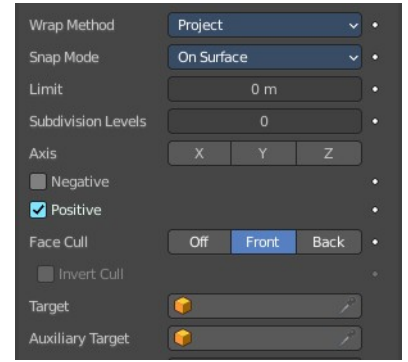

Snap Mode

How the vertex snaps to the surface. The methods should be self explaining.

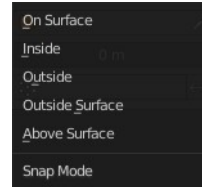

Limit

A distance limit between original vertex and surface. If the distance is larger than this limit vertex would not be projected onto the surface.

Subdivision Levels

This applies a (temporary) Catmull-Clark subdivision to the modified object’s geometry, before computing the wrap.

Axis

Along which local axis of the modified object the projection is done. These options can be combined with each other, yielding a “median axis” of projection. If none are selected, the normal direction is used.

Negative/Positive

This allows you to select the allowed direction(s) of the shrink along the selected axis. If both options are enabled, both ways are evaluated and the closest hit is selected.

Face Cull

Allows you to prevent any projection over the “front side” or the “back side” of the target’s faces. The “side” of a face is determined by its normal.

Invert Cull

When projecting in the negative direction then invert culling.

You need to have negative ticked and face cull either front or back to set this property active.

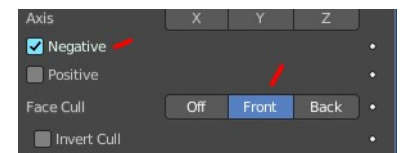

Target

The target mesh to shrink to.

Auxiliary Target

An additional object to project to.

Nearest Vertex

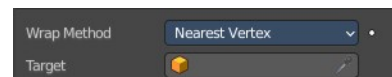

Target

The target mesh to shrink to.

Offset

An offset distance to keep to the target surface.

Smooth factor

Amount of smoothing to apply

Repeat

Number of steps to apply smooth.

Vertex Group

Restrict the affected vertices to a vertex group.

Invert

Inverts the influence of the selected vertex group.

Influence subpanel

Layer

Restricts the effect only to one layer or to any layers that share the same pass index. Click to pick the layer that you want to use.

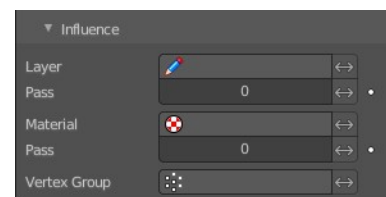

Invert

Inverts the influence.

Pass

The layer pass index.

Invert

Inverts the influence.

Material

Restricts the effect only to material that share the same material or pass index. Click to pick the material that you want to use.

Invert

Inverts the influence.

Pass

The material pass index.

Invert

Inverts the influence.

Vertex Group

Limit the influence to a vertex group.

Invert

Inverts the influence.

Smooth

The Smooth modifier smoothens a stroke.

Mode

What elements to affect.

Position

Affects the position of the point.

Strength

Affects the color strength of the point

Thickness

Affects the thickness of the point.

UV

Affects the uv rotation factor of the point.

Factor

The smoothing amount. Higher values will increase the effect. Values outside expected range (above 1.0 or below 0.0) will distort the mesh.

Repeat

The number of smoothing iterations.

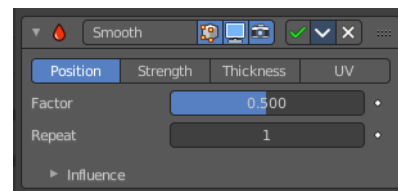

Influence

Layer

Restricts the effect only to one layer or to any layers that share the same pass index. Click to pick the layer that you want to use.

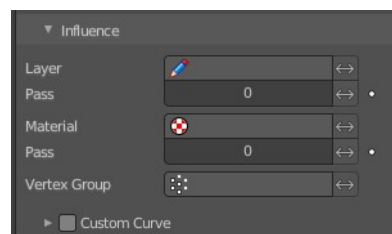

Invert

Inverts the influence.

Pass

The layer pass index.

Invert

Inverts the influence.

Material

Restricts the effect only to material that share the same material or pass index. Click to pick the material that you want to use.

Invert

Inverts the influence.

Pass

The material pass index.

Invert

Inverts the influence.

Vertex Group

Limit the influence to a vertex group.

Invert

Inverts the influence.

Custom Curve

Use a custom curve to define the noise along the strokes.

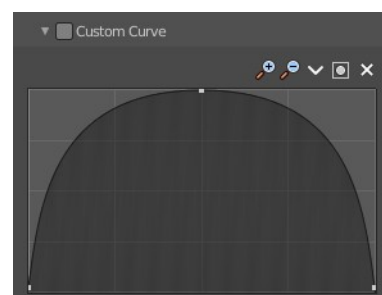

Navigation elements

The navigation elements at the top are described from left to right.



Zoom in and out

The two buttons with the magnifying glass at it zooms in and out in the curve window.

Thickness

The Thickness Modifier change the stroke points thickness.

Uniform Thickness

When enabled, makes the thickness equal for the entire strokes.

Thickness Factor

Value to add or subtract to the actual points thickness.

Weighted

Use weight to modulate effect.

Influence

Layer

Restricts the effect only to one layer or to any layers that share the same pass index. Click to pick the layer that you want to use.

Invert

Inverts the influence.

Pass

The layer pass index.

Invert

Inverts the influence.

Material

Restricts the effect only to material that share the same material or pass index. Click to pick the material that you want to use.

Invert

Inverts the influence.

Pass

The material pass index.

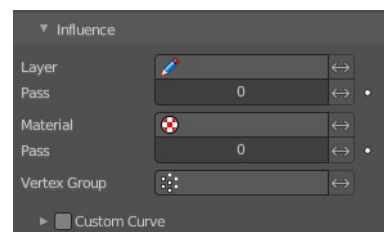
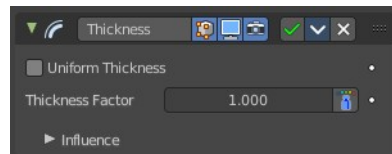

Invert

Inverts the influence.

Vertex Group

Limit the influence to a vertex group.

Invert

Inverts the influence.

Custom Curve

Use a custom curve to define the noise along the strokes.

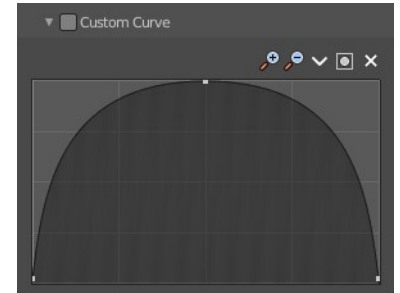

Navigation elements

The navigation elements at the top are described from left to right.

Zoom in and out

The two buttons with the magnifying glass at it zooms in and out in the curve window.



Tools

Tools is a menu where you can find some curve related tools.

Reset View

Resets the curve windows zoom.

Vector Handle

Set handle type to Vector.

Auto Handle

Set handle type to Auto.

Auto Clamped Handle

Set handle type to Auto Clamped.

Extend Horizontal

Extend the curve points horizontal before the first curve point and after the last curve point.

Extend Vertical

Extend the curve points vertical before the first curve point and after the last curve point.

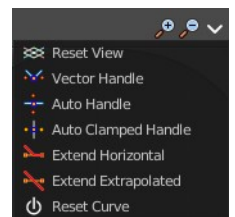

Reset Curve

Resets the curve to the initial shape.

Use Clipping

Clipping options. Set up clipping for the stroke.

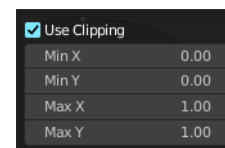

Delete Points

Deletes selected curve points.

Curve window

Tweak and adjust the falloff curve by clicking at a curve point and dragging it around.

Double click adds a new point.

Holding down ctrl activates temporary snapping.

Holding down shift enables slower movement, which allows more accurate setting.

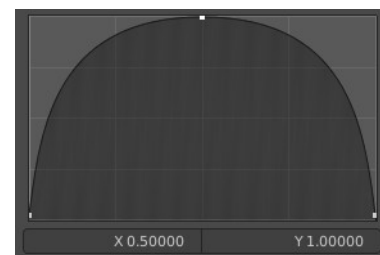

X / Y

The position of the currently selected curve point.



26.9.5 Editors - Properties Editor - Modifiers Properties Tab - Grease Pencil - Color Modifiers

Table of content

Detailed table of content.....	1
Color modifiers.....	4
Hue/Saturation Modifier.....	4
Opacity Modifier.....	6
Tint Modifier.....	9

Detailed table of content

Detailed table of content

Detailed table of content.....	1
Color modifiers.....	4
Hue/Saturation Modifier.....	4
Mode.....	4
Hue.....	4
Saturation.....	4
Value.....	4
Influence.....	4
Layer.....	4
Invert.....	4
Pass.....	4
Invert.....	5
Material.....	5
Invert.....	5
Pass.....	5
Invert.....	5
Custom Curve.....	5
Navigation elements.....	5
Zoom in and out.....	5
Tools.....	5
Reset View.....	5
Vector Handle.....	5
Auto Handle.....	5
Auto Clamped Handle.....	5
Extend Horizontal.....	6
Extend Vertical.....	6
Reset Curve.....	6
Use Clipping.....	6
Delete Points.....	6
Curve window.....	6
X / Y.....	6
Opacity Modifier.....	6
Mode.....	6

Uniform Opacity.....	7
Opacity Factor.....	7
Weighted.....	7
Influence.....	7
Layer.....	7
Invert.....	7
Pass.....	7
Invert.....	7
Material.....	7
Invert.....	7
Pass.....	7
Invert.....	7
Vertex Group.....	7
Invert.....	8
Custom Curve.....	8
Navigation elements.....	8
Zoom in and out.....	8
Tools.....	8
Reset View.....	8
Vector Handle.....	8
Auto Handle.....	8
Auto Clamped Handle.....	8
Extend Horizontal.....	8
Extend Vertical.....	8
Reset Curve.....	8
Use Clipping.....	8
Delete Points.....	9
Curve window.....	9
X / Y.....	9
Tint Modifier.....	9
Mode.....	9
Strength.....	9
Weighted.....	9
Tint Type.....	9
Uniform.....	9
Color.....	9
Gradient.....	10
Color Ramp.....	10
Controls.....	10
+.....	10
-.....	10
Tools menu.....	10
Flip Color Ramp.....	10
Distribute Stops from Left.....	10
Distribute Stops Evenly.....	10
Eyedropper (pipette icon) E.....	10
Reset Color Ramp.....	10
Color Mode.....	10
RGB.....	10
HSV/HSL.....	10
Interpolation.....	10
Ease.....	10
Cardinal.....	10

Linear.....	10
B-Spline.....	11
Constant.....	11
Color Ramp.....	11
Active Color Stop elements.....	11
Choose active color stop.....	11
Pos.....	11
Object.....	11
Radius.....	11
Influence.....	11
Layer.....	11
Invert.....	11
Pass.....	11
Invert.....	11
Material.....	11
Invert.....	12
Pass.....	12
Invert.....	12
Vertex Group.....	12
Invert.....	12
Custom Curve.....	12
Navigation elements.....	12
Zoom in and out.....	12
Tools.....	12
Reset View.....	12
Vector Handle.....	12
Auto Handle.....	12
Auto Clamped Handle.....	12
Extend Horizontal.....	13
Extend Vertical.....	13
Reset Curve.....	13
Use Clipping.....	13
Delete Points.....	13
Curve window.....	13
X / Y.....	13

Color modifiers

Color modifiers just exists for the Grease Pencil object.

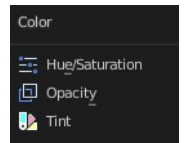

Hue/Saturation

The Hue/Saturation Modifier applies a color transformation to the object output color.

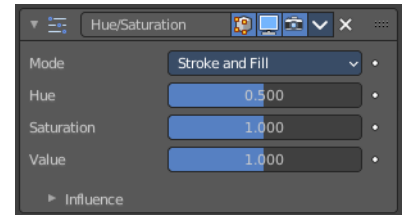

Mode

The color transformation will be applied on the stroke and/or the fill color.

Stroke and Fill, Stroke, Fill



Hue

Specifies the hue rotation of the image. 360° are mapped to (0 to 1). The hue shifts of 0 (-180°) and 1 (+180°) have the same result.

Saturation

A saturation of 0 removes hues from the image, resulting in a greyscale image. A shift greater than 1.0 increases saturation.

Value

Value is the overall brightness of the image. De/Increasing values shift an image darker/lighter.

Influence

Layer

Restricts the effect only to one layer or to any layers that share the same pass index. Click to pick the layer that you want to use.

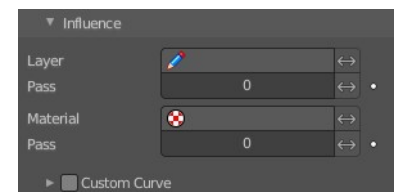

Invert

Inverts the influence.

Pass

The layer pass index.

Invert

Inverts the influence.

Material

Restricts the effect only to material that share the same material or pass index. Click to pick the material that you want to use.

Invert

Inverts the influence.

Pass

The material pass index.

Invert

Inverts the influence.

Custom Curve

Use a custom curve to define the noise along the strokes.

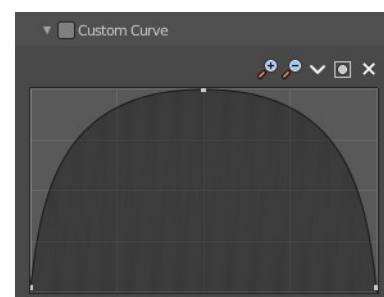

Navigation elements

The navigation elements at the top are described from left to right.

Zoom in and out

The two buttons with the magnifying glass at it zooms in and out in the curve window.



Tools

Tools is a menu where you can find some curve related tools.

Reset View

Resets the curve windows zoom.

Vector Handle

Set handle type to Vector.

Auto Handle

Set handle type to Auto.

Auto Clamped Handle

Set handle type to Auto Clamped.

Extend Horizontal

Extend the curve points horizontal before the first curve point and after the last curve point.

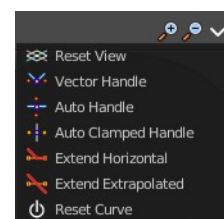

Extend Vertical

Extend the curve points vertical before the first curve point and after the last curve point.

Reset Curve

Resets the curve to the initial shape.

Use Clipping

Clipping options. Set up clipping for the stroke.

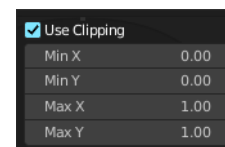

Delete Points

Deletes selected curve points.

Curve window

Tweak and adjust the falloff curve by clicking at a curve point and dragging it around.

Double click adds a new point.

Holding down ctrl activates temporary snapping.

Holding down shift enables slower movement, which allows more accurate setting.

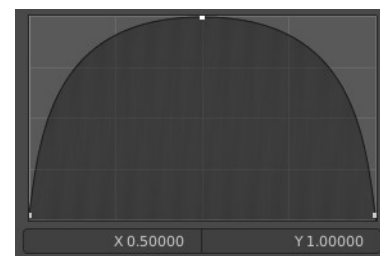

X / Y

The position of the currently selected curve point.

Opacity Modifier

The Opacity Modifier change the opacity (alpha) value of the stroke points.

The alpha value in Grease Pencil is stored per-point. The modifier can alter these values to go from totally transparent points to totally opaque points.

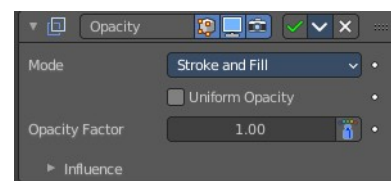

Mode

The color transformation will be applied to the stroke/fill color or stroke Hardness. When Hardness is selected, then the opacity affects the stroke's transparency (alpha) from the center to the border.

Stroke and Fill, Stroke, Fill, or Hardness.

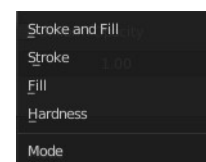

Uniform Opacity

When enabled, makes the opacity equal for the entire strokes.

Opacity Factor

Controls the opacity value of the stroke points. A value of 1.0 respect the original alpha value of the points, a shift less than 1.0 make the points more transparent than originally, and a shift greater than 1.0 make the points more opaque than originally.

Sets value to 2.0 makes the points alpha fully opaque.

Weighted

Use Weight to modulate effect.

Influence

Layer

Restricts the effect only to one layer or to any layers that share the same pass index. Click to pick the layer that you want to use.

Invert

Inverts the influence.

Pass

The layer pass index.

Invert

Inverts the influence.

Material

Restricts the effect only to material that share the same material or pass index. Click to pick the material that you want to use.

Invert

Inverts the influence.

Pass

The material pass index.

Invert

Inverts the influence.

Vertex Group

Limit the influence to a vertex group.

Invert

Inverts the influence.

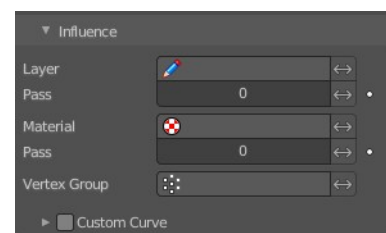

Custom Curve

Use a custom curve to define the noise along the strokes.

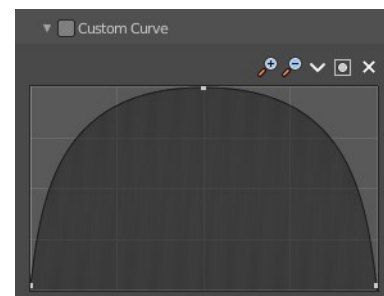

Navigation elements

The navigation elements at the top are described from left to right.

Zoom in and out

The two buttons with the magnifying glass at it zooms in and out in the curve window.



Tools

Tools is a menu where you can find some curve related tools.

Reset View

Resets the curve windows zoom.

Vector Handle

Set handle type to Vector.

Auto Handle

Set handle type to Auto.

Auto Clamped Handle

Set handle type to Auto Clamped.

Extend Horizontal

Extend the curve points horizontal before the first curve point and after the last curve point.

Extend Vertical

Extend the curve points vertical before the first curve point and after the last curve point.

Reset Curve

Resets the curve to the initial shape.

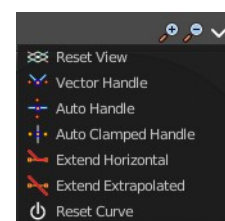

Use Clipping

Clipping options. Set up clipping for the stroke.

Delete Points

Deletes selected curve points.

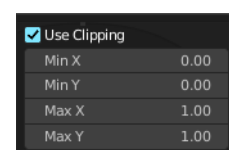

Curve window

Tweak and adjust the falloff curve by clicking at a curve point and dragging it around.

Double click adds a new point.

Holding down ctrl activates temporary snapping.

Holding down shift enables slower movement, which allows more accurate setting.

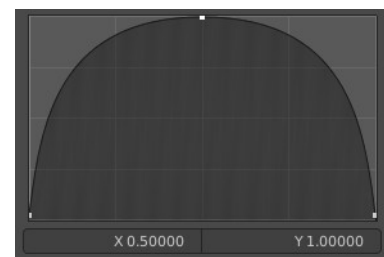

X / Y

The position of the currently selected curve point.

Tint Modifier

The Tint Modifier colorize the original stroke or fill with a selected color.



Mode

The color transformation will be applied on the stroke and/or the fill color.

Stroke and Fill, Stroke, Fill

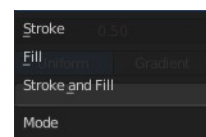

Strength

Controls the amount for the color mixing.

A value of 0 respect the original strokes vertex color, a value of 1.0 totally replace the original color with the tint color.

A shift greater than 1.0 will make the points alpha less transparent than originally (2.0 is fully opaque).

Weighted

Use weight to modulate effect.

Tint Type

Uniform

Color

Defines the tint color for mixing with the original color.



Gradient

Color Ramp

Defines the tint gradient color for mixing with the original vertex color.



Controls

+

Add a stop to your color ramp. The stop will be added after the selected one, in the middle to the next one.

-

Deletes the selected color stop from the list.

Tools menu

Flip Color Ramp

Flips the gradient, inverting the values of the color ramp.

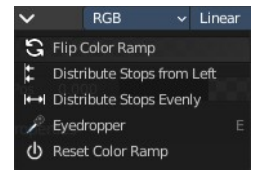

Distribute Stops from Left

Rearrange the stops so that every step has the same space to the right.

Distribute Stops Evenly

Space between all neighboring stops becomes equal.

Eyedropper (pipette icon) E

An Eyedropper to sample a color or gradient from the interface to be used in the color ramp.

Reset Color Ramp

Resets the color ramp to its default state.

Color Mode

RGB

Blends color by mixing each color channel and combining.

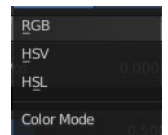

HSV/HSL

Blends colors by first converting to HSV or HSL, mixing, then combining again. This has the advantage of maintaining saturation between different hues, where RGB would de-saturate, this allows for a richer gradient.

Interpolation

Ease

Uses an Ease Interpolation for the color stops.

Cardinal

Uses a Cardinal Interpolation for the color stops.

Linear

Uses a Linear Interpolation for the color stops.

B-Spline

Uses a B-Spline Interpolation for the color stops.



Constant

Uses a Constant Interpolation for the color stops.

Color Ramp

The color band. A click at one of the color stops makes it the active one. You can move the color stops by clicking at them and dragging them around.



Active Color Stop elements

Adjust the active color stop.



Choose active color stop

Choose the color stop by index.

Pos

The position of the active color stop. The range goes from 0.000 to 1.000.

Object

A Data ID to select an object (usually an empty), which position and rotation will be used to define the center of the effect.

Radius

Defines the maximum distance of the effect.

Influence

Layer

Restricts the effect only to one layer or to any layers that share the same pass index. Click to pick the layer that you want to use.

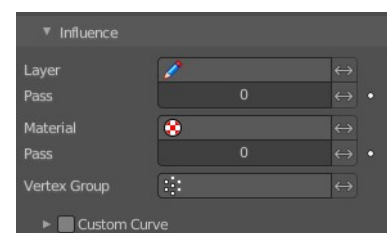

Invert

Inverts the influence.

Pass

The layer pass index.

Invert

Inverts the influence.

Material

Restricts the effect only to material that share the same material or pass index. Click to pick the material that you want to use.

Invert

Inverts the influence.

Pass

The material pass index.

Invert

Inverts the influence.

Vertex Group

Limit the influence to a vertex group.

Invert

Inverts the influence.

Custom Curve

Use a custom curve to define the noise along the strokes.

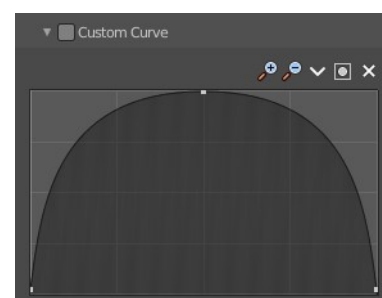

Navigation elements

The navigation elements at the top are described from left to right.

Zoom in and out

The two buttons with the magnifying glass at it zooms in and out in the curve window.

Tools

Tools is a menu where you can find some curve related tools.

Reset View

Resets the curve windows zoom.

Vector Handle

Set handle type to Vector.

Auto Handle

Set handle type to Auto.

Auto Clamped Handle

Set handle type to Auto Clamped.

Extend Horizontal

Extend the curve points horizontal before the first curve point and after the last curve point.

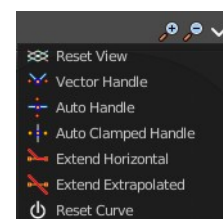

Extend Vertical

Extend the curve points vertical before the first curve point and after the last curve point.

Reset Curve

Resets the curve to the initial shape.

Use Clipping

Clipping options. Set up clipping for the stroke.

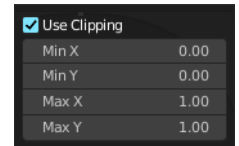

Delete Points

Deletes selected curve points.

Curve window

Tweak and adjust the falloff curve by clicking at a curve point and dragging it around.

Double click adds a new point.

Holding down ctrl activates temporary snapping.

Holding down shift enables slower movement, which allows more accurate setting.

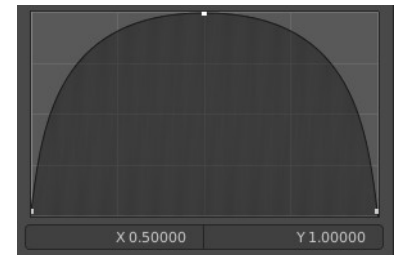

X / Y

The position of the currently selected curve point.

26.9.14 Editors - Properties Editor - Modifiers Properties Tab - Lattice - Modify modifiers

Table of content

Detailed table of content.....	1
Lattice - Modify modifiers.....	1
Mesh Cache.....	1

Detailed table of content

Detailed table of content

Detailed table of content.....	1
Lattice - Modify modifiers.....	1
Mesh Cache.....	1
Format.....	2
File Path.....	2
Influence.....	2
Deform Mode.....	2
Interpolation.....	2
Time Remapping.....	2
Frame / Time / Factor.....	2
Play Mode.....	2
Frame Start.....	2
Frame Scale.....	2
Axis Mapping.....	2
Forward/Up Axis.....	2
Flip Axis.....	3

Lattice - Modify modifiers

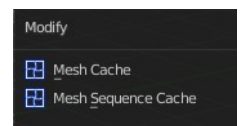

Mesh Cache

The Mesh Cache modifier allows you to apply animated mesh data to a mesh. And deform it when playing back.

This works in a similar way to shape keys. But uses external files, and allows to interchange between applications.

Tip! Both MDD and PC2 depend on the vertex order on the mesh remaining unchanged. This is a limitation of this method, so take care not to add/remove/reorder vertices once this

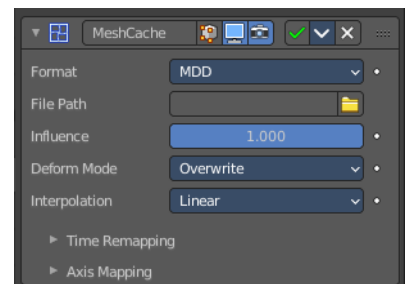

modifier is used.

Format

The input file format (currently .mdd and .pc2 are supported).

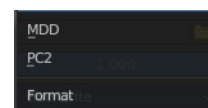

File Path

Path to the cache file.

Influence

Factor to adjust the influence of the modifier's deformation.

Deform Mode

This setting defaults to Overwrite which will replace the vertex locations with those in the cache file.

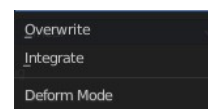

When you want to mix a mesh cache file with shape keys, then you can select the Deform option which integrates deformations with the mesh cache result.

Note that this feature is limited to making smaller, isolated edits and will not work for larger changes such as re-posing limbs.

Interpolation

The blend mode between frames. Use linear when the frames in the cache file do not match up exactly with the frames in the blend-file.

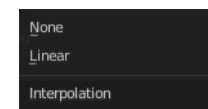

Time Remapping

Frame / Time / Factor

How time is calculated.

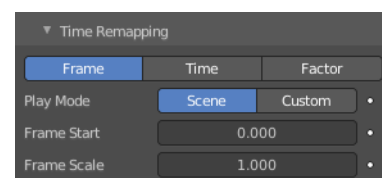

Play Mode

How playback operates.

Frame Start

Play the cache starting from this frame.

Frame Scale

Scale time by this factor (applied after the start value).

Axis Mapping

Forward/Up Axis

The axis for forward and up used in the source file.

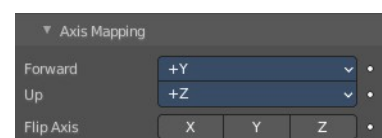

Flip Axis

Allows you to flip the coordinates on an axis.

26.9.15 Editors - Properties Editor - Modifiers Properties Tab - Lattice - Deform Modifiers

Table of content

Detailed table of content.....	1
Lattice - Deform modifiers.....	4
Armature.....	4
Cast.....	6
Curve.....	7
Hook.....	9
Lattice.....	11
Mesh Deform.....	11
Shrinkwrap.....	12
Simple Deform.....	14
Warp.....	15
Wave.....	17

Detailed table of content

Detailed table of content

Detailed table of content.....	1
Lattice - Deform modifiers.....	4
Armature.....	4
Object.....	4
Vertex Group.....	4
Invert.....	5
Preserve Volume.....	5
Multi Modifier.....	5
Bind to.....	5
Vertex Groups.....	5
Bone Envelopes.....	5
Cast.....	6
Shape.....	6
Axis.....	6
Factor.....	6
Radius.....	6
Size.....	6
Size from Radius.....	6
Vertex Group.....	7
Invert.....	7
Object.....	7
Curve.....	7
Curve Object.....	7
Deformation Axis.....	7
Vertex Group.....	7
Invert.....	7
Texture Prop.....	8

Texture browser.....	8
Texture Edit Box.....	8
Fake User.....	8
Add Texture.....	8
Remove.....	8
Change Context.....	8
Coordinates.....	8
Direction.....	8
X, Y, Z.....	8
Space.....	8
Normal.....	8
Custom Normal.....	8
RGB to XYZ.....	9
Space.....	9
Strength.....	9
Mid level.....	9
Vertex Group.....	9
Invert.....	9
Hook.....	9
Object.....	10
Vertex Group.....	10
Invert.....	10
Strength.....	10
Reset.....	10
Recenter.....	10
Select.....	10
Assign.....	10
Falloff.....	10
Type.....	10
Radius.....	10
Uniform Falloff.....	11
Lattice.....	11
Object.....	11
Vertex Group.....	11
Invert.....	11
Strength.....	11
Mesh Deform.....	11
Object.....	11
Vertex Group.....	11
Invert.....	12
Precision.....	12
Dynamic.....	12
Bind.....	12
Unbind.....	12
Shrinkwrap.....	12
Wrap Method.....	12
Nearest Surface Point + Target Normal Project.....	12
Snap Mode.....	13
Target.....	13
Project.....	13
Snap Mode.....	13
Limit.....	13
Subdivision Levels.....	13

Axis.....	13
Negative/Positive.....	13
Face Cull.....	13
Target.....	13
Auxiliary Target.....	13
Nearest Vertex.....	14
Target.....	14
Offset.....	14
Vertex Group.....	14
Invert.....	14
Simple Deform.....	14
Deform Method.....	14
Twist.....	14
Bend.....	14
Taper.....	14
Stretch.....	14
Origin.....	15
Restrictions.....	15
Limits.....	15
Lock.....	15
Vertex Group.....	15
Warp.....	15
Object From.....	15
Object To.....	15
Preserve Volume.....	15
Strength.....	15
Vertex Group.....	15
Invert.....	15
Falloff.....	16
Falloff Type.....	16
Radius.....	16
Texture.....	16
Usage.....	16
Texture Prop.....	16
Texture browser.....	16
Texture Edit Box.....	16
Fake User.....	16
Add Texture.....	16
Remove.....	16
Change Context.....	16
Coordinates.....	16
Wave.....	17
Motion.....	17
Cyclic.....	17
Along Normals.....	17
X/Y/Z.....	17
Falloff.....	17
Height.....	17
Width.....	18
Narrowness.....	18
Vertex Group.....	18
Invert.....	18
Start Position.....	18

Object.....	18
Start Position X/Y.....	18
Time.....	18
Offset.....	18
Life.....	18
Damping.....	18
Speed.....	18
Texture subtab.....	19
Usage.....	19
Texture Prop.....	19
Texture browser.....	19
Texture Edit Box.....	19
Fake User.....	19
Add Texture.....	19
Remove.....	19
Change Context.....	19
Coordinates.....	19

Lattice - Deform modifiers

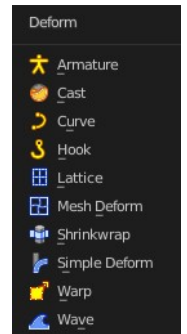

Armature

An armature system allows to deform objects accurately by posing bones. The Armature modifier contains the armature settings at the mesh end.

This modifier gets created automatically when you parent a mesh to an armature.

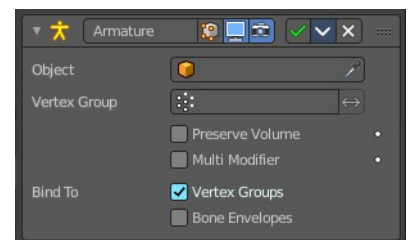

Object

The name of the armature object used by this modifier.

Vertex Group

A vertex group of the object, which weights will be used to determine the influence of this modifier's results when mixing it with the results from other Armature ones.

This is only of use when having at least two of these modifiers on the same object, with Multi Modifier

activated.

Invert

Inverts the influence set by the vertex group.

Preserve Volume

Use quaternions for preserving volume of object during deformation.

Without Preserve Volume, rotations at joints tend to scale down the neighboring geometry, up to nearly zero at 180 degrees from rest position. With it, the geometry is no longer scaled down, but there is a discontinuity when reaching 180 degrees from rest position.

Multi Modifier

You can parent an object to more than one armature. The Multi Modifier allows you to use several armatures to deform the same object, all based on the “non-deformed” data.

The results of the Armature modifiers are then mixed together, using the weights of the Vertex Group as “mixing guides”.

Bind to

Vertex Groups

Meshes and lattices only. Use Vertex groups for deforming the mesh. A bone named “forearm”, will only affect the vertices in the “forearm” vertex group. The influence of one bone on a given vertex is controlled by the weight of this vertex in the relevant group.

The vertex groups are located in the Object Data Properties in the Properties editor.

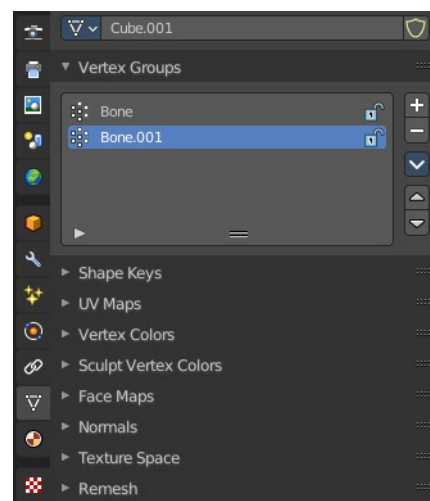

Bone Envelopes

Use the Bone envelopes to deform vertices or control points near them, defined by each bone’s envelope radius and distance.

When envelopes are disabled, Blender uses the set of existing vertex group names to determine which bones influences what mesh part.

Bone envelopes display can be turned on in the Viewport Display panel in the Object Data properties tab in the Properties Editor. Display as ...

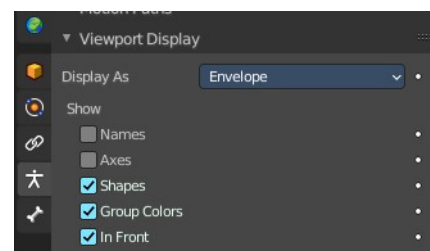

And can be adjusted in the Transform panel in the sidebar of the 3D View, in Edit mode.

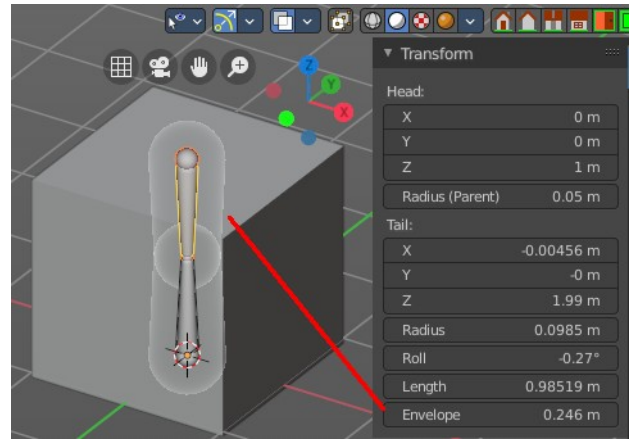

Cast

The Cast modifier shifts the shape of a mesh, curve, surface or lattice object, towards predefined shapes. Sphere, cylinder, cuboid.

Note! For performance reasons, this modifier only works with local coordinates. If the modified object looks wrong, you may need to apply its transformations, especially when casting to a cylinder.

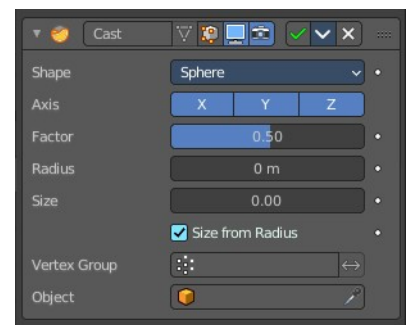

Shape

Choose the target shape of the projection: Sphere, Cylinder or Cuboid.

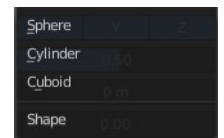

Axis

The directions in which the modifier works. For a Cylinder shape the Z axis remains unaffected.

Factor

The factor to control blending between original and cast vertex positions.

The factor is a linear interpolation. 0.0 gives original coordinates, and the modifier has no effect then. 1.0 casts to the target shape. Values below 0.0 or above 1.0 exaggerate the deformation.

Radius

A value above 0.0 defines a sphere of influence. Vertices outside it are not affected by the modifier.

Size

Alternative size for the projected shape. If zero, it is defined by the initial shape and the control object, if any.

Size from Radius

Calculate Size from Radius. Can give smoother results.

Vertex Group

Restrict the effect to the vertices in that vertex group.

Invert

Inverts the influence of the selected vertex group.

Object

The name of an object to control the effect. The location of this object's origin defines the center of the projection. And its size and rotation transform the projected vertices.

Curve

The Curve modifier deforms a mesh along a curve object. You need to have a curve object in the scene, and choose it as the curve object.

The modifier works in global space on a dominant axis, X, Y, or Z. When you move your mesh in the dominant direction, the object will move along the curve. When you pull into the other axis directions then the object will move away from the dominant axis, and deform.

When you move the object beyond the curve's ends, the object will keep the deformation from the latest curve point.

If the curve is 3D, then the rotation of the object can be controlled by the mean tilt of the curve control points. The mean tilt can be found in edit mode in the sidebar in the Transform panel. Other options in the Shape panel can also have an influence at the deforming result. Like Stretch.

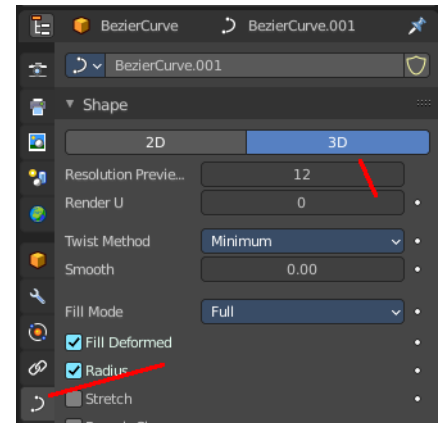
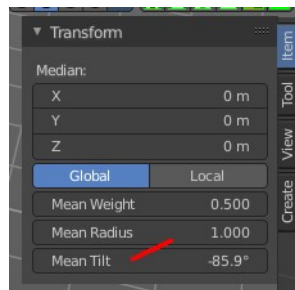
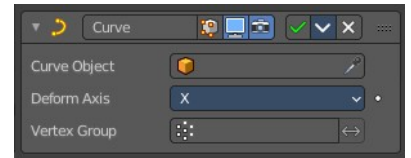

Curve Object

The name of the curve object that will affect the deformed object.

Deformation Axis

The axis to deform along.

Vertex Group

Restrict the effect to the vertices in that vertex group.

Invert

Inverts the influence of the selected vertex group.



Texture Prop

Texture browser

A list of the available textures

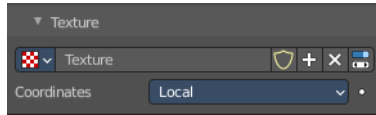

Texture Edit Box

The name of the currently active texture. Allows to rename the texture too.

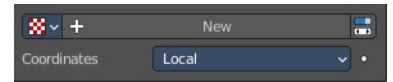

Fake User

Keep this data even when it has no user in the scene.

Add Texture

Add a new texture.

Remove

Removes the texture. Note that the texture is still in the browser list.

Change Context

Jump to texture tab and show the texture.

Coordinates

The texture coordinate system to use for the displacement.

The displacement can be along a particular local axis, along the vertex normal. Or the separate RGB components of the texture can be used to displace vertices in the local X, Y and Z directions simultaneously. This is called Vector Displacement.

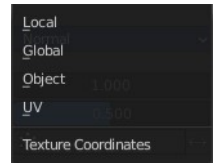

Direction

The direction along which to displace the vertices.

X, Y, Z

Displace along an axis.

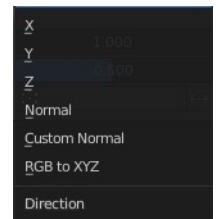

Space

With a direction set to X, Y, Z, or XYZ the modifier can either displace along local or global axes.

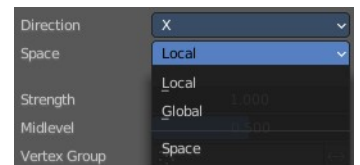

Normal

Displace along the vertex normal.

Custom Normal

Displace along (averaged) custom normals, instead of vertex normals.

RGB to XYZ

Displace along local XYZ axes individually using the RGB components of the texture. Red values displaced along the X axis, Green along the Y, Blue along the Z axis.

Space

With a direction set to X, Y, Z, or XYZ the modifier can either displace along local or global axes.

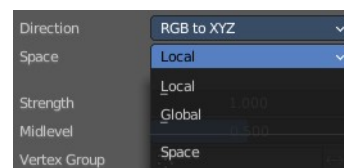

Strength

The strength of the displacement. A negative strength inverts the effect of the modifier.

After offsetting by the Mid level value, the displacement will be multiplied by the Strength value to give the final vertex offset.

$$\text{vertexoffset} = \text{displacement} \times \text{Strength}$$

Mid level

The texture value which will be treated as no displacement by the modifier. Texture values below this threshold will result in negative displacement along the selected direction, while texture values above it will result in positive displacement.

$$\text{displacement} = \text{texturevalue} - \text{Midlevel}$$

Note that that color/luminosity values are typically between (0.0 to 1.0) in Blender, and not between (0 to 255).

Vertex Group

Use a vertex group to control the influence of the modifier.

Invert

Inverts the influence of the selected vertex group.

Hook

The Hook modifier is used to deform a mesh, curve or lattice by another object. When you move this hook object, then it pulls vertices or control points with it.

Assigning the hook object to specific vertices of the target object is done in Edit mode. The modifier shows a set of buttons then.

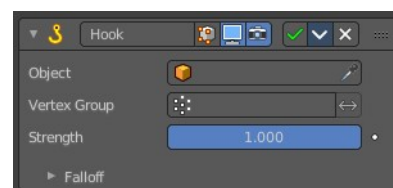

This modifier is automatically created when you add a Hook from the Hooks menu in the Edge menu in edit mode.

Some settings just exists in Edit mode.

Warning! The Hook Modifier stores vertex indices from the original mesh to determine what to affect. Modifiers that generate geometry, like Subdivision Surface, should always be put after the Hook modifier in the stack. Otherwise, the generated geometry can't be affected by the hook's influence.

Object

The name of the object to hook vertices to.

Vertex Group

Allows you to define the influence per vertex.

Invert

Inverts the influence of the selected vertex group.

Strength

Adjust this hooks influence on the vertices.

Reset

In Edit mode. Recalculate and clear the offset transform of the hook.

Recenter

In Edit mode. Set the hook center to the 3D cursor position.

Select

In Edit mode. Select the vertices affected by this hook.

Assign

In Edit mode. Assigns selected vertices to this hook.

Falloff

Type

This can be used to adjust the kind of influence curve that the hook has on the mesh. You can also define a custom curve to get a much higher level of control.

Radius

The size of the hooks influence.

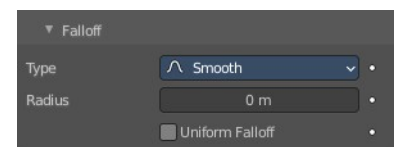
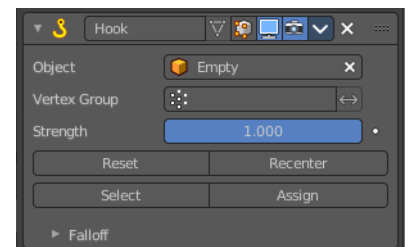
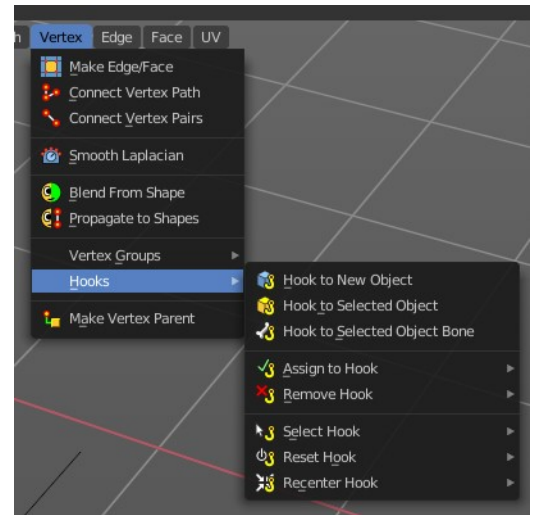

Uniform Falloff

Compensate non uniform scale, and use a uniform falloff.

Lattice

The Lattice modifier deforms the base object by the shape of a Lattice object. It can be used at meshes, curves, surfaces, text, lattices and even particles.

A Lattice modifier with valid settings can be added by selecting the object, holding down shift, select the target lattice object, and then choose Lattice Deform in the Parent menu.

Note! When you want to use a lattice to deform particles, then you need to place the Lattice modifier after the Particle System modifier.

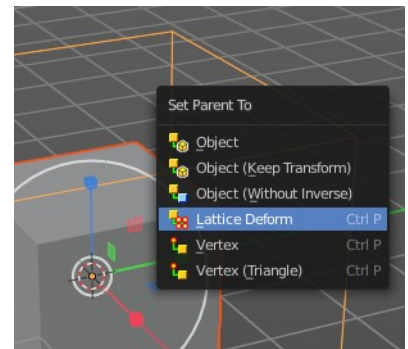
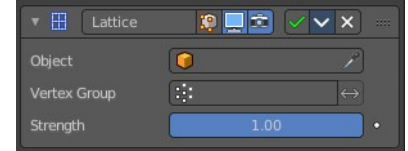

Object

The Lattice object that deforms the base object.

Vertex Group

Limit the modifier's effect to a vertex group of the base mesh.

Invert

Inverts the influence of the selected vertex group.

Strength

A factor to control blending between original and deformed vertex positions.

Mesh Deform

The Mesh Deform modifier allows an arbitrary mesh of any closed shape to act as a deformation cage around another mesh.

Note! The changes are not displayed in edit mode. But Edit mode is where you deform your cage object.

Note! This modifier can run out of memory and crash.

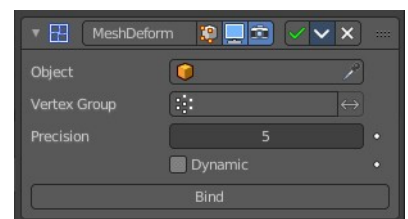

Object

The name of the mesh object to be used as the deforming cage.

Vertex Group

Restrict the affected vertices to a vertex group.

Invert

Inverts the influence of the selected vertex group.

Precision

Controls the accuracy with which the deform mesh cage alters the deformed object when the points on the cage are moved. Higher values means better precision and higher calculation time.

This setting is unavailable once a cage has been bound.

Dynamic

When activated, other mesh altering features (such as other modifiers and shape keys) are taken into account when binding. This increases the deformation quality.

This setting is unavailable once a cage has been bound.

Bind

Bind the current vertex positions of both, the modified geometry and the deforming Object, together. An unbound Mesh Deform modifier has no effect. It must be bound so that altering the shape of the deform mesh cage is able to alter the shape of the modified object.

Warning! It can take a long time for the operation to complete. And the software may not respond for a pretty while.

Unbind

Unbind the meshes. The deformed object will reset back to its original shape that it had before it was bound to the deform mesh cage.

Shrinkwrap

The Shrinkwrap modifier allows an object to “shrink” to the surface of another object. It moves each vertex of the object to the closest position on the surface of the target object.

It can be applied to meshes, lattices, curves, surfaces and texts.

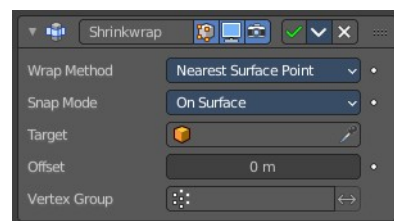

Wrap Method

The method to determine the nearest point on the target’s surface for each vertex of the object.

Nearest Surface Point + Target Normal Project

Nearest Surface Point selects the nearest point at the surface. Additionally, Target Normal Project tries to match the interpolated normals of the surface.

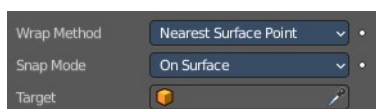

Snap Mode

How the vertex snaps to the surface. The methods should be self explaining.

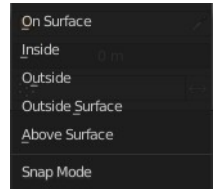

Target

The target mesh to shrink to.

Project

Projects all vertices along a chosen axis until they hit the surface of the target object.

Vertices that never hits the surface are not calculated.

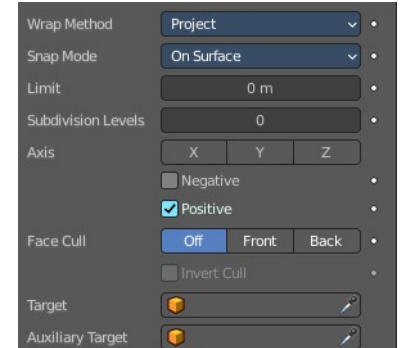

Snap Mode

How the vertex snaps to the surface. The methods should be self explaining.



Limit

A distance limit between original vertex and surface. If the distance is larger than this limit vertex would not be projected onto the surface.

Subdivision Levels

This applies a (temporary) Catmull-Clark subdivision to the modified object's geometry, before computing the wrap.

Axis

Along which local axis of the modified object the projection is done. These options can be combined with each other, yielding a "median axis" of projection. If none are selected, the normal direction is used.

Negative/Positive

This allows you to select the allowed direction(s) of the shrink along the selected axis. If both options are enabled, both ways are evaluated and the closest hit is selected.

Face Cull

Allows you to prevent any projection over the "front side" or the "back side" of the target's faces. The "side" of a face is determined by its normal.

Target

The target mesh to shrink to.

Auxiliary Target

An additional object to project to.

Nearest Vertex

Snaps to the nearest vertex instead of the nearest surface point.

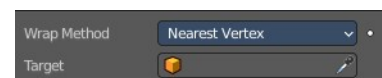

Target

The target mesh to shrink to.

Offset

An offset distance to keep to the target surface.

Vertex Group

Restrict the affected vertices to a vertex group.

Invert

Inverts the influence of the selected vertex group.

Simple Deform

The Simple Deform modifier allows simple deforming of an object of type Mesh, lattice, curve, surface and text.

The deformation is calculated in local coordinate space.

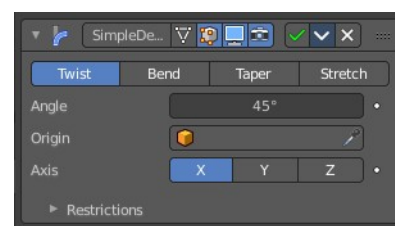

Deform Method

Twist

Twist rotates the object around an axis. Vertices in the same plane as the origin are not rotated. Above the origin the rotation is clockwise. Below the origin the rotation is negative. The amount of rotation is dependent of the distance to the origin. Closer vertices rotates not so strong.

Bend

Bend bends the object over an axis.

Taper

Taper tapers the object across its origin. The scaling factor is weighted by the distance from the origin of the object in the deform axis.

Stretch

Stretch scales the object along an axis.

Angle (Twist & Bend) / Factor (Taper & Stretch)

The total amount of deformation. A negative value reverses the deformation.

Origin

Pick an object to use its origin as the origin for the simple deformation.

Restrictions

Limits

You can set lower and upper limits for the deformation. The upper limit cannot be lower than the lower one. These limits are mapped on the Deform axis.

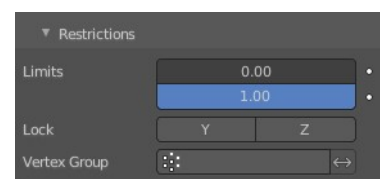

Lock

Not for Bend. Do not allow deformations along these axis.

Vertex Group

Limit the deformation to a vertex group.

Warp

The Warp modifier warps parts of a mesh to a new location by using two target objects. The deformation goes into the direction from the first target object to the second target object. This target objects can be of any type. Empty, Lamp, Camera, etc. For demonstration purposes two spheres are used.

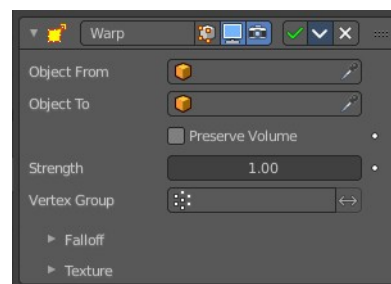
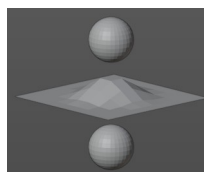

Object From

The object to define the origin transformation of the warp.

Object To

The object to define the destination transformation of the warp.

Preserve Volume

Enables volume preservation when rotating one of the transforms.

Strength

Sets how strong the effect is.

Vertex Group

Limit the modifier to a vertex group.

Invert

Inverts the influence of the selected vertex group.

Falloff

Falloff Type

The falloff type. How the strength of the warp changes as it goes from the center of the transform to the Radius value.

Radius

The distance from the transforms that can be warped by the transform handles.

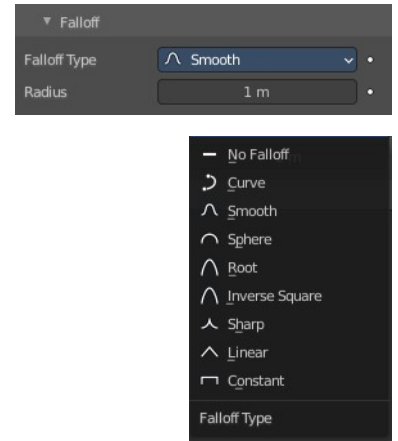

Texture

A texture allows you to control how the vertices are affected by the modifier.

Usage

Add a texture.

Head over to the Texture tab.

In the texture tab either load an existing texture. Or create one. A procedural Noise texture for example.

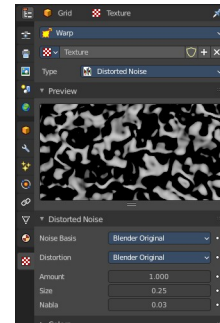
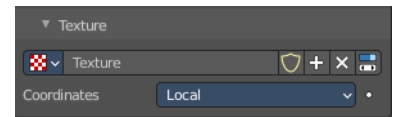

Texture Prop

Texture browser

A list of the available textures

Texture Edit Box

The name of the currently active texture. Allows to rename the texture too.

Fake User

Keep this data even when it has no user in the scene.

Add Texture

Add a new texture.

Remove

Removes the texture. Note that the texture is still in the browser list.

Change Context

Jump to texture tab and show the texture.

Coordinates

What texture coordinate system to use.

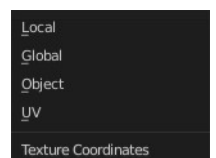
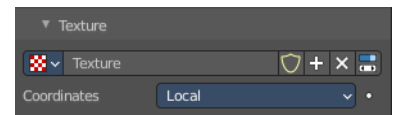
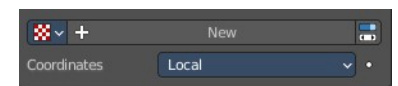

Wave

The Wave modifier adds a ripple-like shape to an object's geometry. The shape can be animated by playing the animation.

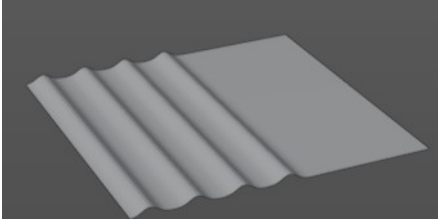

This modifier works with meshes,

lattices, curves, surfaces and texts.

Important! All the values are in local object space. They must be multiplied with the corresponding Scale values of the object to get the real dimensions.

To obtain a nice wave effect similar to sea waves and close to a sinusoidal wave, make the distance between following ripples and the ripple width equal. That is, the Narrowness value must be equal to $2 / \text{Width}$. E.g. for Width to be 1, set Narrow to 2.

Motion

The wave effect deforms vertices/control points in the Z direction. The initial start point is the object origin. The direction is then in X or Y direction. With both activated you get a circle shape.

Cyclic

Repeats the waves.

When you want to have more circles at frame 1 already, then use a negative Offset in the Time subpanel.

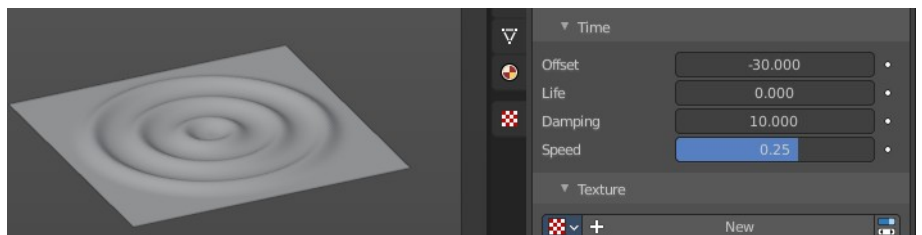

Along Normals

For meshes only. Displaces the mesh along the surface normals (instead of the object's Z axis).

X/Y/Z

Restrict displacement along normals to the selected local axes.

Falloff

Controls how fast the waves fade out as they travel away from the starting point.

Height

The height or amplitude of the ripple.

Width

Distance between the waves. If the pulses are too near to each other, the wave may not reach the zero Z position. In this case the whole wave gets lowered so that the minimum is zero, and the maximum is lower than the expected amplitude.

Narrowness

The actual width of each pulse.

The higher the value the narrower the pulse. The actual width of the area for a single is given by $4 / \text{Narrowness}$.

Vertex Group

Limit the effect of the modifier to a vertex group.

Invert

Inverts the influence of the selected vertex group.

Start Position

Object

Use the origin of another object as the starting point.

Start Position X/Y

Coordinates of the center of the waves, in object's local space.

Time

Settings to control the animation.

Offset

Time offset in frames. The frame at which the wave begins (if Speed is positive), or ends (if Speed is negative). Use a negative frame number to prime and pre-start the waves.

Life

Duration of animation in frames. With a value of zero the animation loops forever.

Damping

An additional number of frames in which the wave slowly damps from the Height value to zero after Life is reached. The dampening occurs for all the ripples and begins in the first frame after the Life is over. Ripples disappear over Damping frames.

Speed

The speed per frame, of the ripple.

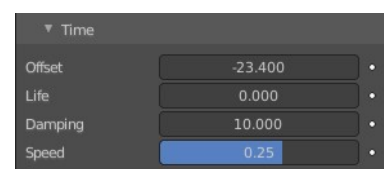

Texture subtab

A texture allows you to control how the vertices are affected by the modifier.

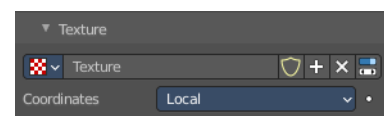

Usage

Add a texture.

Head over to the Texture tab.

In the texture tab either load an existing texture. Or create one. A procedural Noise texture for example.

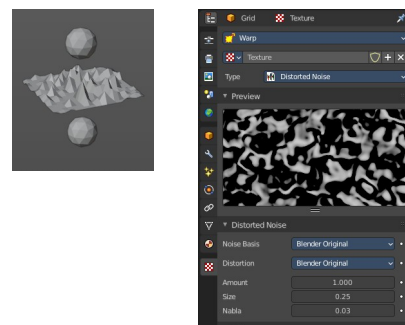

Texture Prop

Texture browser

A list of the available textures

Texture Edit Box

The name of the currently active texture. Allows to rename the texture too.

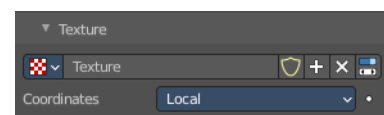
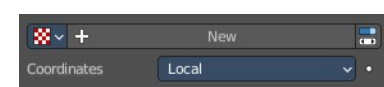

Fake User

Keep this data even when it has no user in the scene.

Add Texture

Add a new texture.

Remove

Removes the texture. Note that the texture is still in the browser list.

Change Context

Jump to texture tab and show the texture.

Coordinates

What texture coordinate system to use.

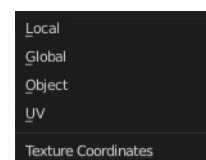

26.9.16 Editors - Properties Editor - Modifiers Properties Tab - Lattice - Deform Modifiers

Table of content

Curve&Text - Physics modifiers.....	1
Soft body.....	1

Lattice - Physics modifiers

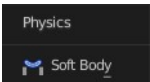

Soft body

The Soft body modifier gets added into the modifier stack when you add a Soft Body physics in the Physics tab. It enables Soft Body simulation for the mesh.

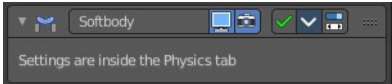

All the Soft body settings and adjustments happens in the Physics tab. The Soft body modifier has no further settings.

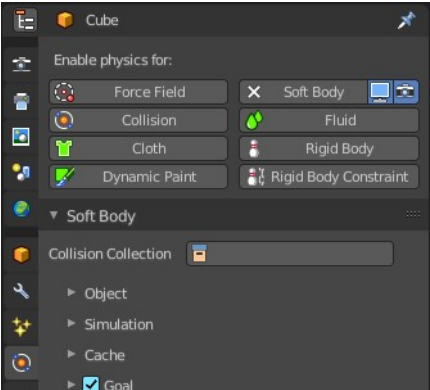



26.9.2 Editors - Properties Editor - Modifiers Properties Tab - Mesh - Generate Modifiers

Table of content

Detailed table of content.....	1
Mesh - Generate modifiers.....	9
Array.....	9
Bevel.....	11
Boolean.....	17
Build.....	18
Decimate.....	19
Edge Split.....	20
Geometry Nodes.....	21
Mask.....	22
Mirror.....	23
Multiresolution.....	24
Remesh.....	27
Screw.....	29
Skin.....	30
Solidify.....	32
Subdivision Surface.....	35
Triangulate.....	38
Volume to mesh.....	38
Weld.....	39
Wireframe.....	40

Detailed table of content

Detailed table of content

Detailed table of content.....	1
Mesh - Generate modifiers.....	9
Array.....	9
Fit Type.....	9
Fixed Count.....	9
Fit Length.....	10
Fit Curve.....	10
Relative Offset.....	10
Factor X/Y/Z.....	10
Constant Offset.....	10
Distance X/Y/Z.....	10
Object Offset.....	10
Object.....	10
Merge.....	10
Distance.....	10
First and Last Copies.....	10
UV's.....	11
Offset U/V.....	11

Caps.....	11
Cap Start / End.....	11
Bevel.....	11
Affect.....	11
Vertices.....	11
Edges.....	11
Width Type.....	11
Offset.....	11
Width.....	12
Depth.....	12
Percent.....	12
Absolute.....	12
Amount.....	12
Segments.....	12
Limit Method.....	12
None.....	12
Angle.....	12
Angle.....	12
Weight.....	12
Vertex Group.....	13
Vertex Group.....	13
Invert.....	13
Profile subpanel.....	13
Super Ellipse.....	13
Shape.....	13
Custom.....	13
Miter Shape.....	13
Custom Profile.....	13
Preset.....	13
Zoom in.....	13
Zoom out.....	13
Tools.....	14
Reset View.....	14
Reset Curve.....	14
Reverse Path.....	14
Toggle Profile Clipping.....	14
Curve view.....	14
Handle Type Auto Handle.....	14
Handle Type Vector Handle.....	14
Handle Type Free Handle.....	14
Handle Type Aligned Free Handle.....	14
X Y Values.....	14
Delete.....	14
Sample Straight Edges.....	14
Sample Even Lengths.....	14
Geometry subpanel.....	15
Miter Inner.....	15
Sharp.....	15
Arc.....	15
Outer.....	15
Sharp.....	15
Patch.....	15
Arc.....	15

Intersections.....	15
Clamp Overlap.....	16
Loop Slide.....	16
Shading subpanel.....	16
Harden Normals.....	16
Mark.....	16
Seam.....	16
Sharp.....	16
Material Index.....	16
Face Strength.....	16
None.....	16
New.....	16
Affected.....	17
All.....	17
Boolean.....	17
Operation.....	17
Intersect.....	17
Union.....	17
Difference.....	18
Operand Type.....	18
Object.....	18
Solver.....	18
Solver Options sub panel.....	18
With solver method fast.....	18
Overlap Threshold.....	18
With Solver Method Exact.....	18
Self Intersection.....	18
Hole Tolerant.....	18
Build.....	18
Start.....	18
Length.....	19
Reversed.....	19
Randomize.....	19
Seed.....	19
Decimate.....	19
Mode.....	19
Collapse.....	19
Ratio.....	19
Symmetry.....	19
Triangulate.....	19
Vertex Group.....	19
Invert.....	20
Factor.....	20
Un-Subdivide.....	20
Iterations.....	20
Planar.....	20
Angle Limit.....	20
Delimit.....	20
Normal.....	20
Material.....	20
Seam.....	20
All Boundaries.....	20
Face Count.....	20

Edge Split.....	20
Edge Angle.....	21
Sharp Edges.....	21
Geometry Nodes.....	21
Data Browser.....	21
Edit box.....	21
Add Fake User.....	21
User.....	21
Add.....	22
Remove.....	22
Custom Inputs and Outputs.....	22
Mask.....	22
Mode.....	22
Vertex Group.....	22
Smooth.....	22
Armature.....	22
Invert.....	22
Threshold.....	23
Mirror.....	23
Workflow.....	23
Axis.....	23
Bisect.....	23
Flip.....	23
Mirror Object.....	23
Clipping.....	23
Merge.....	24
Bisect Distance.....	24
Merge Distance.....	24
Data subpanel.....	24
Mirror UV.....	24
Offset UV.....	24
Vertex Groups.....	24
Flip UDIM.....	24
Multiresolution.....	24
Workflow.....	25
Level Viewport.....	25
Sculpt.....	25
Render.....	25
Sculpt Base Mesh.....	25
Optimal Display.....	25
Subdivision Subpanel.....	25
Subdivision Mode.....	25
Subdivide.....	25
Simple.....	25
Linear.....	25
Unsubdivide.....	26
Delete Higher.....	26
Shape subpanel.....	26
Reshape.....	26
Apply Base.....	26
Generate Subpanel.....	26
Save External.....	26
File path.....	26

Type.....	26
Catmull-Clark.....	26
Simple.....	26
Levels Sculpt.....	27
Viewport.....	27
Render.....	27
Advanced Subpanel.....	27
Quality.....	27
UV Smooth.....	27
Smooth, keep corners.....	27
Sharp.....	27
Use Creases.....	27
Remesh.....	27
Blocks, Smooth, Sharp.....	28
Octree Depth.....	28
Scale.....	28
Sharpness.....	28
Remove Disconnected.....	28
Threshold.....	28
Smooth Shading.....	28
Voxel.....	28
Voxel Size.....	28
Adaptivity.....	28
Smooth Shading.....	28
Screw.....	29
Angle.....	29
Screw.....	29
Iterations.....	29
Axis.....	29
Screw.....	29
Axis Object.....	29
Object Screw.....	29
Steps Viewport.....	29
Render.....	29
Merge.....	29
Merge Distance.....	29
Stretch UV's.....	29
Normals.....	30
Smooth Shading.....	30
Calculate Order.....	30
Flip.....	30
Skin.....	30
Branch Smoothing.....	30
Symmetry Axes X/Y/Z.....	31
Smooth Shading.....	31
Create Armature.....	31
Add Skin Data.....	31
Mark / Clear Loose.....	31
Mark Root.....	31
Equalize Radii.....	31
Solidify.....	32
Mode.....	32
Simple.....	32

Thickness.....	32
Offset.....	32
Even Thickness.....	32
Fill Rim.....	32
Only Rim.....	32
Complex.....	33
Thickness Mode.....	33
Fixed.....	33
Even.....	33
Constraints.....	33
Boundary.....	33
None.....	33
Round.....	33
Flat.....	33
Thickness.....	33
Offset.....	33
Merge Threshold.....	33
Rim.....	34
Fill Rim.....	34
Only Rim.....	34
Vertex Group.....	34
Invert.....	34
Factor.....	34
Flat Faces.....	34
Normals.....	34
Flip Normals.....	34
High Quality Normals.....	34
Materials.....	34
Material Offset.....	34
Rim.....	35
Edge Data.....	35
Inner.....	35
Outer.....	35
Rim.....	35
Bevel Convex.....	35
Thickness Clamp.....	35
Clamp.....	35
Angle Clamp.....	35
Output Vertex Groups.....	35
Shell.....	35
Rim.....	35
Subdivision Surface.....	35
Type.....	36
Catmull-Clark.....	36
Simple.....	36
Levels Viewport.....	36
Render.....	36
Optimal Display.....	36
Advanced.....	36
Quality.....	36
UV Smooth.....	37
None.....	37
Keep Corners.....	37

Keep Corners, Junctions.....	37
Keep Corners, Junctions, Concave.....	37
Keep Boundaries.....	37
All.....	37
Smooth, keep corners.....	37
Sharp.....	37
Boundary Smooth.....	37
Keep Corners.....	37
All.....	37
Use Creases.....	37
Use Custom Normals.....	37
Triangulate.....	38
Quad Method.....	38
Beauty.....	38
Fixed.....	38
Fixed Alternate.....	38
Shortest Diagonal.....	38
N-Gon Method.....	38
Beauty.....	38
Clip.....	38
Minimum Vertices.....	38
Keep Normals.....	38
Volume to mesh.....	38
Object.....	39
Grid Name.....	39
Resolution Mode.....	39
Grid.....	39
Voxel Amount.....	39
Voxel Size.....	39
Threshold.....	39
Adaptivity.....	39
Smooth Shading.....	39
Weld.....	39
Mode.....	39
All.....	39
Connected.....	40
Distance.....	40
Only Loose Edges.....	40
Vertex Group.....	40
Invert.....	40
Wireframe.....	40
Thickness.....	40
Offset.....	40
Boundary.....	40
Replace Original.....	40
Thickness.....	40
Even.....	41
Relative.....	41
Crease Edges.....	41
Crease Weight.....	41
Material Offset.....	41
Vertex Group.....	41
Invert.....	41

Factor.....41

Mesh - Generate modifiers

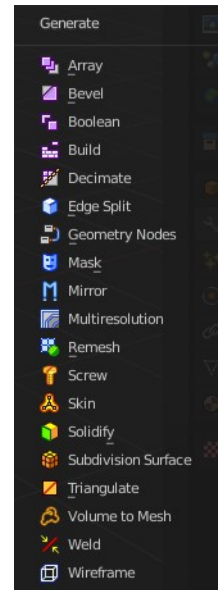

Array

The Array modifier creates an array of copies of the base object. Each copy can offset from the previous one in any of a number of possible ways. Vertices in adjacent copies can be merged if they are nearby, allowing smooth Subdivision Surface frameworks to be generated.

This modifier can be useful when combined with tillable meshes for quickly developing large scenes. It is also useful for creating complex repetitive shapes.

Multiple Array modifiers may be active for an object at the same time. This allows to create complex three-dimensional constructs.

Hint for Offset Calculation. The transformation applied from one copy to the next is calculated as the sum of the three different components (Relative, Constant and Object), each of which can be enabled/disabled independently of the others. This allows, for example, a relative offset of (1.0, 0.0, 0.0) and a constant offset of (0.1, 0.0, 0.0), giving an array of objects neatly spaced along the X axis with a constant 0.1 unit between them, whatever the original object's size.

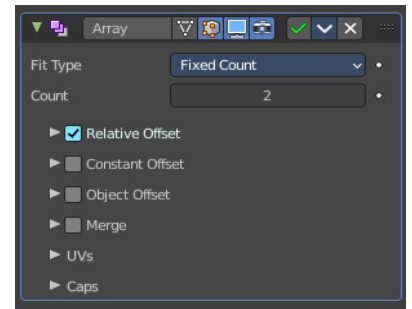

Fit Type

Controls how the length of the array is determined.

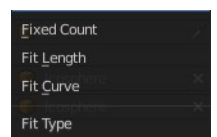

Fixed Count

Generates the number of copies specified in Count.

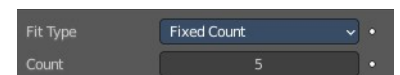

Fit Length

Generates copies to fit within the fixed length given by Length.

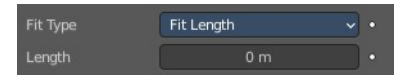

Fit Curve

Generates copies to fit within the length of the curve object specified in Curve. You need to select a curve object.



Note! Both Fit Curve and Fit Length use the local coordinate system size of the base object, which means that scaling the base object in Object Mode will not change the number of copies generated by the modifier.

Fit Length uses the local coordinate system length of the curve, which means that scaling the curve in Object Mode will not change the number of copies generated by the modifier.

Applying the scale can be useful for both.

Relative Offset

Factor X/Y/Z

Adds a translation equal to the object's bounding box size along each axis to the offset, multiplied by a scaling factor. X, Y and Z scaling factors can be specified.



Constant Offset

Distance X/Y/Z

Adds a constant translation component to the duplicate object's offset. X, Y and Z constant components can be specified.

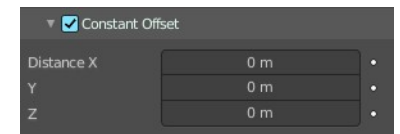

Object Offset

Adds a transformation taken from a chosen object relative to the current object to the offset.



Object

Choose an object.

Merge

If enabled, vertices in each copy will be merged with vertices in the next copy that are within the given Distance.

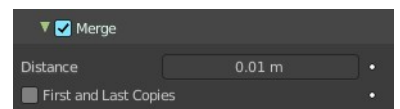

Distance

The merge distance between the vertices. Vertices below this distance will be merged.

First and Last Copies

Merge vertices in first and last duplicates.

UV's

Offset UV

Shifts UV's of each new duplicate by a settable amount.

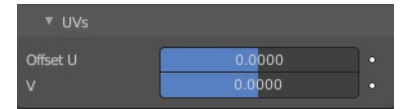

Caps

Cap Start / End

Adds a chosen mesh at the start and end of the array. The start object is added at position -1. The end object at position +1. When Merge is activated, and the cap vertices are within the Distance threshold, they will be merged.



Note! The start/end cap objects currently do not support the First and Last Copies option.

Bevel

The Bevel modifier bevels the edges of the mesh. It is a non-destructive alternative to the Bevel Operation in Edit Mode.

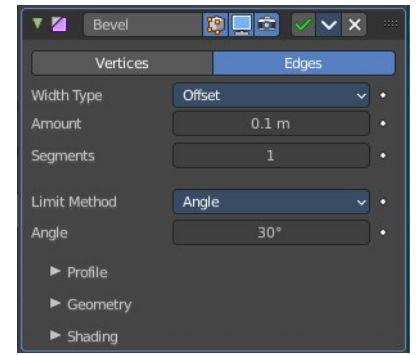
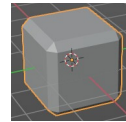

Affect

Vertices

Only the areas near vertices are beveled, the edges remain unchanged.

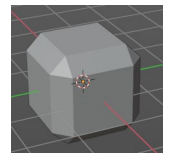

Edges

Bevels both edges and vertices.

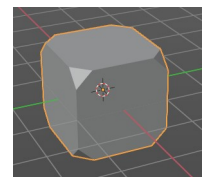

Width Type

Defines how Width will be interpreted to determine the amount of bevel.

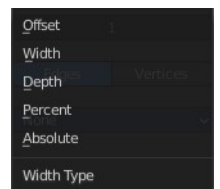

Offset

Value is interpreted as the distance from the original edge to the edge of the beveled face.

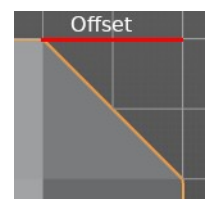

Width

Value is interpreted as the distance between the two new edges formed by the bevel.

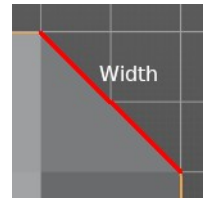

Depth

Value is the perpendicular distance from the new bevel face to original edge.

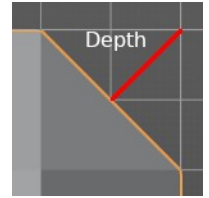

Percent

Similar to Offset but the value is interpreted as a percentage of the adjacent edge length.

Absolute

Amount is absolute along adjacent edge.

Amount

The bevel amount.

Segments

The number of edge loops added along the bevel's face.

Limit Method

Used to control where a bevel is applied to the mesh.

None

No limit, all edges will be beveled.

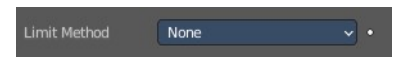

Angle

Only edges where the adjacent faces form an angle smaller than the defined threshold will be beveled. Intended to allow you to bevel only the sharp edges of an object without affecting its smooth surfaces.

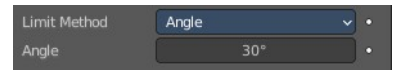

Angle

The angle above which to bevel.

Weight

Use each edge's bevel weight to determine the width of the bevel. When the bevel weight is 0.0, no bevel is applied.

Edge bevel weight can be set in Edit mode in the Edge menu with the Edge Bevel Weight tool.

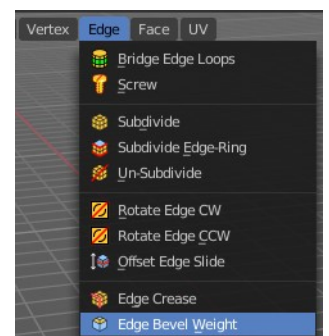
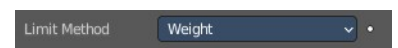

Vertex Group

Use weights from a vertex group to determine the width of the bevel. When the vertex weight is 0.0, no bevel is applied. An edge is only beveled if both of its vertices are in the vertex group. See here about adjusting vertex group weights.

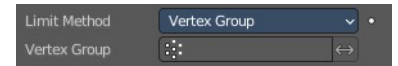

Vertex Group

Choose the vertex group.

Invert

Inverts the influence of the selected vertex group.

Profile subpanel

The profile defines the shape of the bevel. Profile has no effect if the number of segments is below 2.

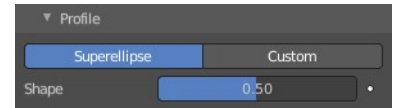

Super Ellipse

Defines a rounded bevel corner.

Shape

The shape of the rounded bevel corner. A value close to 0 bends the roundness to inside. A value towards 1 bends the curve to outside. A value of 0.5 defines a radius around the center point of the bevel.

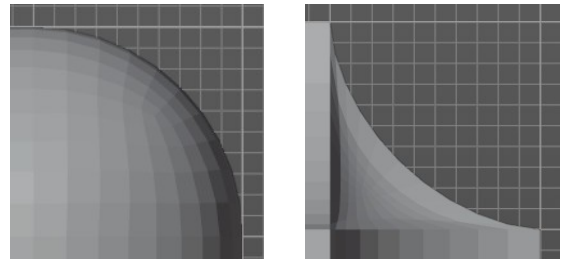

Custom

Here you can define a custom shape profile for the bevel.

Miter Shape

The shape of the custom bevel corner. Has no effect when the miter type is sharp. You need to set it to Arc in the geometry section.

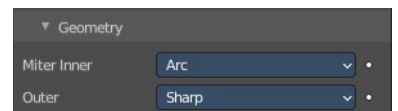

Custom Profile

Choose and adjust a custom bevel profile. This feature needs more than one segment to work.

Preset

Choose some profile presets.

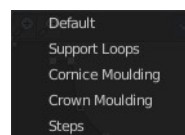

Zoom in

Zooms into the curve view.

Zoom out

Zooms out of the curve view.

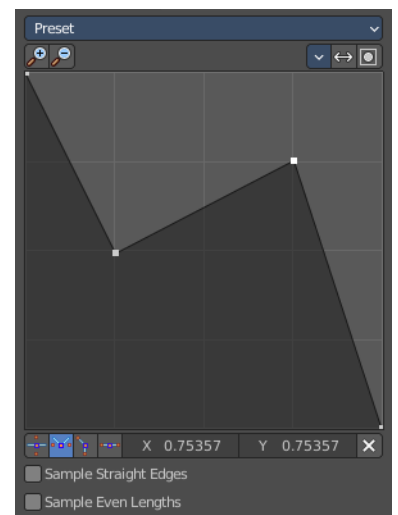

Tools

Reset View

Resets the zoom factor of the curve view.



Reset Curve

Resets the curve to the defaults. This means when you choose a curve preset to reset it to the values of the latest chosen preset.

Reverse Path

The path gets reversed. The first point becomes the last and vice versa.

Toggle Profile Clipping

Toggles the profile clipping.

Curve view

Adjust the profile curve.

Left click where no point is adds a new point. Left click at a point allows you to move it.

Holding down Shift while moving a node point activates precision movement.

Holding down ctrl while moving activates temporary snapping.

When a point is selected then the curve view reveals a sub menu at the bottom.

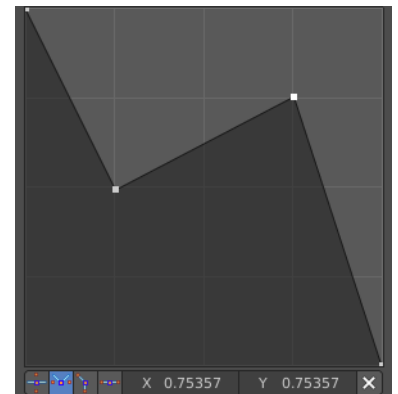

Handle Type Auto Handle

Sets the handle type of this curve point to smooth.

Handle Type Vector Handle

Sets the handle type of this curve point to sharp.

Handle Type Free Handle

Sets the handle type of this curve to Free handles. The curve point has now two handles with which you can adjust the curve before and after the point each.

Handle Type Aligned Free Handle

Sets the handle type of this curve to Free handles. The curve point has now a handle with which you can adjust the curve.

X Y Values

The position of the currently selected curve point.

Delete

Delete the selected curve point.

Sample Straight Edges

Sample edges with vector handles.

Sample Even Lengths

Sample edges with even lengths.

Geometry subpanel

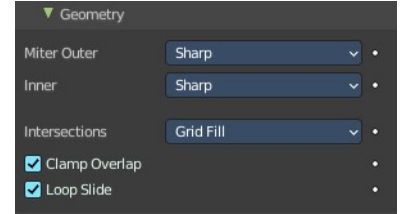

Miter Inner

How the inner miter is set. Miter is how the bevel rounding at a corner is done.

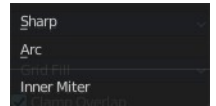

Sharp

Creates a sharp miter.

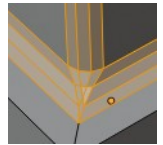

Arc

This replaces the vertex of a miter with 2 vertices, joined by an arc. A separate Spread parameter says how far to move the vertices away from their original position.

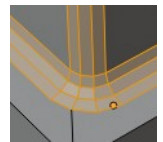

Outer

How the outer miter is set. Miter is how the bevel rounding at a corner is done.



Sharp

Creates a sharp miter.

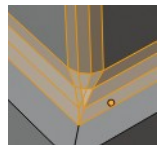

Patch

This replaces the outside vertex of a miter with 3 vertices. And uses a patch pattern there.

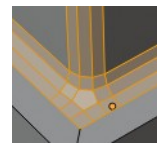

Arc

This replaces the vertex of a miter with 2 vertices, joined by an arc. A separate Spread parameter says how far to move the vertices away from their original position.

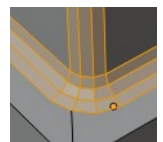

Intersections

If a bevel corner is filled or not. Needs minimum two segments to have effect.

When the inner corners of the cutoff profiles faces meet at the same location with a three way intersection, then no center face is created.



The direction of the cutoff faces depends on the original vertex's normal.



Clamp Overlap

Limits the width of each beveled edge so that edges cannot cause overlapping intersections with other geometry.

Loop Slide

If there are unbeveled edges along with beveled edges into a vertex, the bevel tries to slide along those edges when possible. Turning the option off can lead to more even bevel widths.

Shading subpanel

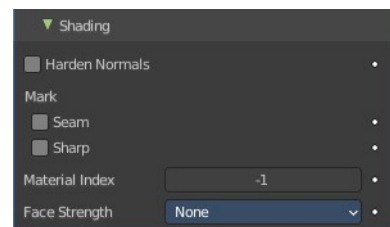

Harden Normals

Match normals of new faces to adjacent faces.

Autosmooth needs to be enabled for this feature. And the shading needs to be smooth.

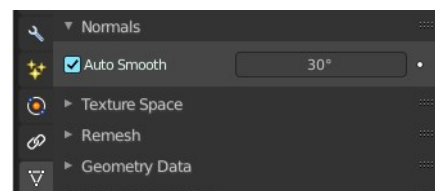

Mark

Seam

When the beveled edge is a seam edge, then the bevel will also contain a seam to keep the seam into account.

Sharp

When the beveled edge is a sharp edge, then the bevel will also contain a sharp edge to keep the sharp edge into account.

Material Index

The index of the material slot to use for the bevel. When set to -1, the material of the nearest original face will be used.

Face Strength

Set the Face Strength on the faces involved in the bevel by the mode specified here.

This face strength then can be used in conjunction with a following Weighted Normals modifier (with the Face Influence option checked).

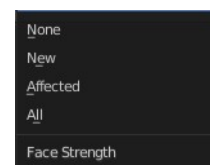

None

Do not set face strength.

New

Set the face strength of new faces along edges to Medium, and the face strength of new faces at vertices to Weak.

Affected

In addition to those set for the New case, also set the faces adjacent to new faces to have strength Strong.

All

In addition to those set for the Affected case, also set all the rest of the faces of the model to have strength Strong.

Boolean

The Boolean modifier uses one of the three available Boolean operations to create a single mesh out of two mesh objects. Union, Difference and Intersect. This modifier needs a second object to be the target of the operation.

Boolean operations may or may not deliver useful results. And requires nearly always manual cleanup afterwards since it tends to create N-Gon geometry and can create micro triangles. You should also avoid co-planar faces. Manifold meshes works best.

Tip! Tick Wireframe, and All Edges in the Viewport Display panel to see the bool result in realtime happen. And hide the bool object. That way you can tweak the positions of the objects if needed.

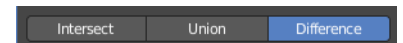
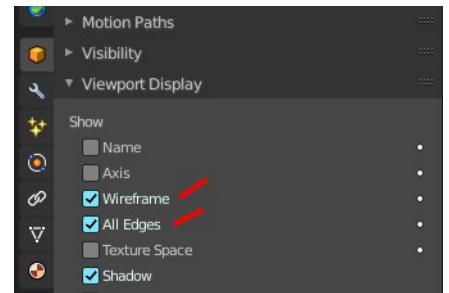
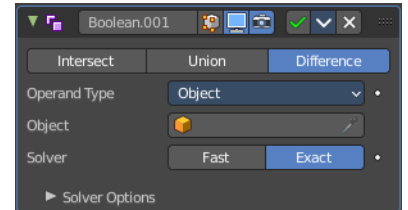

Operation

The Boolean operation to use.

Demonstrated at a cube with the modifier applied, and a sphere as the target object.

Intersect

Keeps the intersecting geometry, removes the non intersecting geometry.

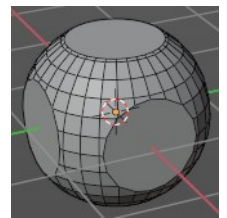

Union

The target mesh is added to the modified mesh.

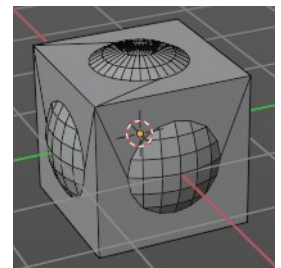

Difference

Keeps the non intersecting geometry, removes the intersecting geometry.

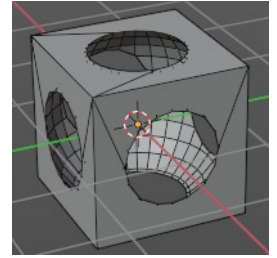

Operand Type

Object

The target mesh object. You need to choose a target mesh object for the boolean operation.

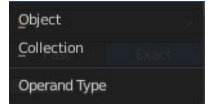

Solver

Fast or Exact.

Solver Options sub panel

With solver method fast

Overlap Threshold

The threshold for overlapping geometry. This value determines above which value a boolean operation happens.

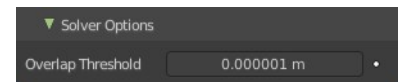

With Solver Method Exact

Self Intersection

Allow self intersection in operanding objects.

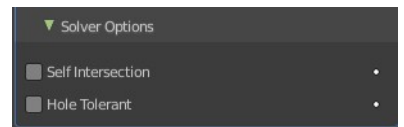

Hole Tolerant

Better results when the mesh contains holes.

Build

The Build modifier lets the faces of the mesh object to appear or disappear one after the other over time when you play the animation.

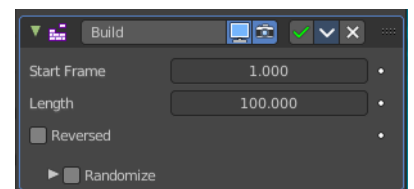

By default, faces appear in the order in which they are stored in memory, which follows the order how they are created. This face/vertex order can be altered in Edit Mode by using Sort Mesh Elements in the Mesh menu.

Start

The start frame of the building process.

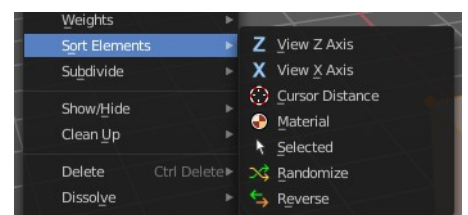

Length

The number of frames over which to rebuild the object.

Reversed

The modifier will operate in reverse, and start with the full mesh. And deconstruct it towards the end frame.

Randomize

Randomizes the order in which the faces are built.



Seed

The random seed. Changing this value gives a different “random” order when Randomize is checked. This order is always the same for a given seed/mesh set.

Decimate

The Decimate modifier allows you to reduce the vertex/face count of a mesh with minimal shape changes. The result is just displayed in Object mode. In Edit mode the unaltered mesh is shown.

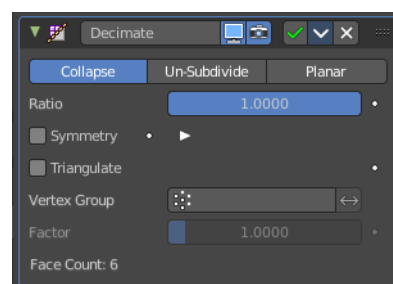

Mode

Collapse

This algorithm uses progressive merging of vertices, taking the shape of the mesh into account.

Ratio

The ratio of faces to keep after decimation. 1.0 is not altered. The lower the value the stronger the reduction.

Note! Although the Ratio is directly proportional to the number of remaining faces, triangles are used when calculating the ratio.

This means that if your mesh contains quads or other polygons, the number of remaining faces will be larger than expected, because those will remain unchanged if their edges are not collapsed.

This is only true if the Triangulate option is disabled.

Symmetry

Maintains symmetry on a single axis.



Triangulate

Keeps any resulting triangulated geometry from the decimation process.

Vertex Group

A vertex group that controls what parts of the mesh are decimated.

Invert

Decimate the geometry except the vertex group.

Factor

The influence factor of the vertex group.

Un-Subdivide

This algorithm tries to unsubdivide divided faces.

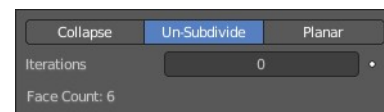

Iterations

The number of times to perform the unsubdivide operation. Two iterations is the same as one subdivide operation, so you will usually want to use even numbers.

Planar

This algorithm reduces details by unioning adjacent faces that are below an angle limit.

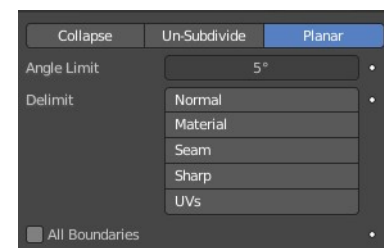

Angle Limit

Dissolve geometry which form angles (between surfaces) higher than this setting.

Delimit

Prevent dissolving geometry in certain places.

Normal

Does not dissolve edges on the borders of areas where the face normals are reversed.

Material

Does not dissolve edges on the borders of where different materials are assigned.

Seam

Does not dissolve edges marked as seams.

All Boundaries

When enabled, all vertices along the boundaries of faces are dissolved.

Face Count

The face count of the decimated mesh.

Edge Split

The Edge Split modifier splits single edges into two independent edges when the adjacent faces are below the defined angle. Or when the edge is marked as sharp. Which can be done in edit mode in the Edge menu with the Mark Sharp tool.

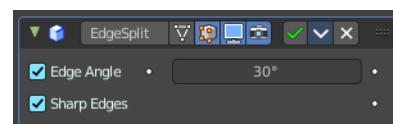

Splitting an edge affects vertex normal generation at that edge, and makes the edge appear sharp. So this modifier can be used to achieve the same effect as Auto Smooth. And make edges appear sharp when their angle is above a certain threshold. It can also be used for manual control of the smoothing process, where the user defines which edges should appear smooth or sharp (see Mesh Smoothing for other ways to do this). If desired, both modes can be active at once.

Note! This modifier is kept mostly for historical/compatibility reasons. Everything it can do in shading, and much more, can now be achieved using custom normals. Unless you really need the topology changes it generates, it is not advised to use it in new projects.

Edge Angle

The angle above which to split edges.

Sharp Edges

When you have marked edges as sharp, then these edges will be split.

Note! Non-manifold edges will always be split.

Geometry Nodes

The geometry Nodes modifier adds a geometry node tree, which can be modified in the geometry node editor.

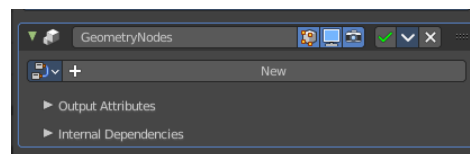

Manage the nodes. If there is no geometry node tree for the current object, then you will see the New button

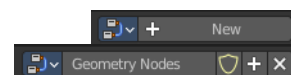

Data Browser

The list of available geometry node trees in the scene.

Edit box

The name of the current active geometry node tree. Here you can also rename the node tree.

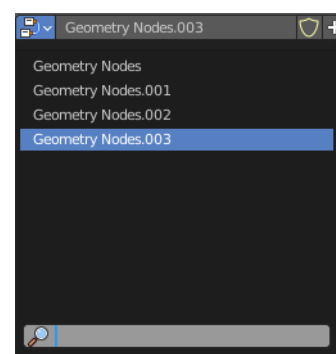

Add Fake User

With this button you assign a fake user to this selected geometry node tree.

Data, like node trees, that is not longer linked to anything else gets removed when you save and reload a scene. Bforartists has the concept of fake users to go around this behavior. An image with a fake user is in fact linked to something. And so it is not lost when you save and reload the scene.

User

The number of users that uses this data. Data with a user number of 0 will be removed with closing Bforartists.

Add

Add a geometry node.

Remove

Removes the geometry node tree. To delete it completely you need to purge it. See Fake user.

Custom Inputs and Outputs

In case you define custom inputs and outputs in the geometry nodes editor, then these inputs and outputs also shows in the modifier.

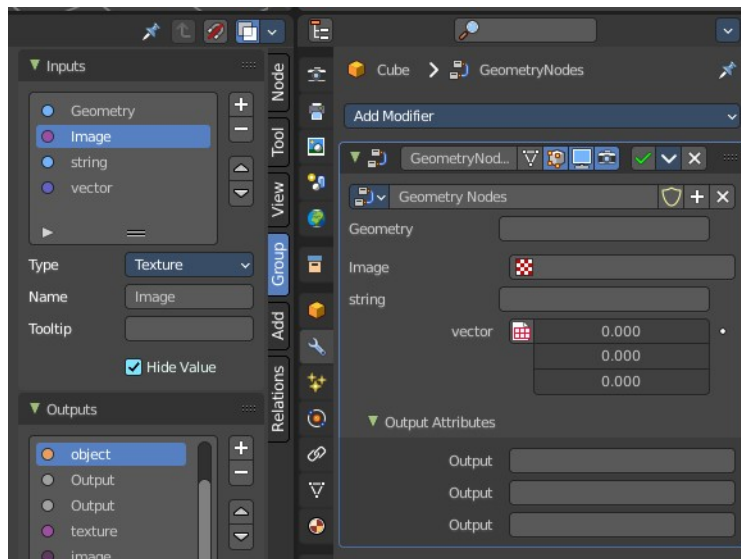

Mask

The Mask modifier allows to hide vertices of an object dynamically based on vertex groups or an Armature.

Mode

Use Vertex Groups or an armature to hide the mesh Vertex Group works in Object mode. Armature works in Pose mode, and uses the active bone for masking.

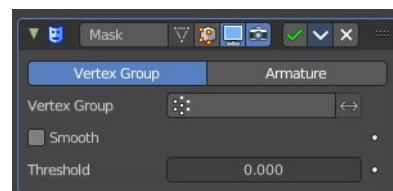

Vertex Group

Here you can select the vertex group that you want to use for masking. The geometry from this vertex group is shown.

Smooth

Use vertex group weights to cut faces at the weight contour.

Armature

When in Pose Mode, vertices belonging to the vertex group associated with the active bone (same names) will be visible. Vertices not in that group will be hidden.

Invert

Show the not selected geometry instead of the selected.

Threshold

Vertices with weights less or equal to this value will be hidden.

Mirror

The Mirror modifier mirrors a mesh along its local X, Y and/or Z axes, across the Object Origin. It can also use another object as the mirror center, then use that object's local axes instead of its own.

Workflow

Usually this modifier is used for mirror modeling in edit mode. In Edit mode just the original side is editable then. Recommend is to remove half of the mesh before starting. The missing part will then be added by the Mirror modifier. But you can also use the Bisect feature.

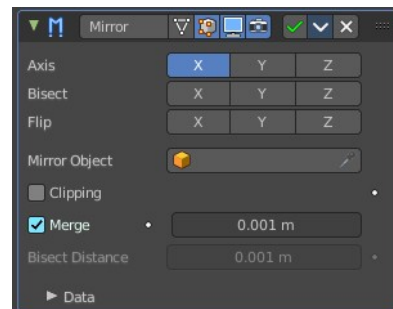

Axis

The axis to mirror along.

You can select more than one of these axes. And will then get more mirrored copies. With one axis you get a single mirror, with two axes four mirrors, and with all three axes eight mirrors.

Bisect

If the mesh is already on both sides of the mirror plane, it is cut by that plane. And only one side (the “negative” one by default) is kept to perform the mirror process.

Note. When you turn Bisect on and pull at the mirror part, then you won't have the mirroring effect to the original side.

Flip

When Bisect is enabled on an axis, you can use this setting to switch the side kept and mirrored (i.e. when it is enabled, the “positive” side will be kept, instead of the “negative” one).

Mirror Object

An Object Selector to select an object (usually an empty), which position and rotation will be used to define mirror planes (instead of using the ones from the modified object).

You can animate it to move the mirror axis.

Clipping

Prevents vertices from moving through the mirror plane(s) when you transform them in Edit Mode.

If it is enabled but vertices are beyond the mirror plane and outside of the Merge Distance, the vertices will not be merged. But as soon as the vertices are within Merge Distance they are snapped together and cannot be moved beyond the mirror plane.

Note! Vertices on the mirror plane will be unable to move away from the mirror plane as long as Clipping is enabled. You must disable it to be able to move the vertices along the mirror axis again.

Merge

Where a vertex is in the same place (within the Merge Distance) as its mirror it will be merged with the mirrored vertex.

Bisect Distance

Vertices are removed up to this distance from the bisect plane.

Merge Distance

The maximum distance between a vertex and its mirror copy at which they are merged together (being snapped on the mirror plane). Needs Merge to be enabled.

Data subpanel

Mirror UV

Mirror the UV texture coordinates across the middle of the image.

Offset UV

Mirrored UV Offset along u and v axis.

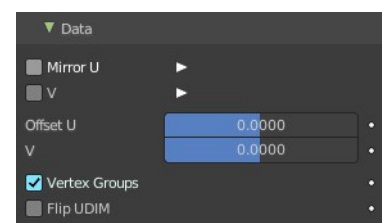

Vertex Groups

Try to mirror existing vertex groups.

Note! The vertex groups you want to mirror must be named following the usual left/right pattern (i.e. with suffixes like “.R”, “.right”, “.L”, etc.). The mirror side vertex group must already exist (it will not be created automatically). It must also be completely empty (no vertices assigned to it).

Flip UDIM

Mirror the texture coordinates around each tile center.

Multiresolution

The Multiresolution modifier, in short “Multires”) allows you to subdivide a mesh similarly to the Subdivision Surface modifier, but also allows you to edit the new subdivision levels in Sculpt Mode.

Note! Multiresolution cannot be re-positioned in the stack after any modifier that will change geometry or other object data (This means all Generate, some Modify and some Simulate modifiers cannot come before the Multiresolution modifier). It needs to work at the unaltered base mesh.

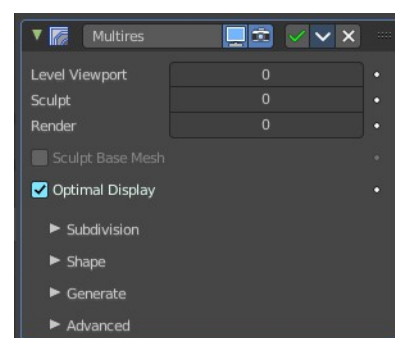

Workflow

Add the modifier. Switch to Sculpt mode. Click at the Subdivide button. The Levels sculpt slider will now turn to 1. Do some sculpting. Click at the Subdivide button again. The Levels sculpt slider will now turn to 2. You have added a second sds layer now. Do some sculpt now. Click at the Subdivide button again, and you have a third sds sculpting level. Do some sculpt now.

To work at level 1 SDS simply change the Levels sculpt value back to 1. Or to 2 when you want to work at layer 2.

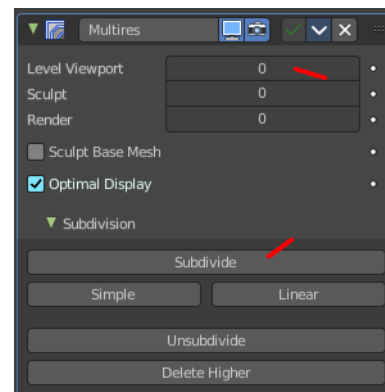

Level Viewport

Number of subdivisions in the viewport when not in sculpt mode.

Sculpt

Number of subdivisions to use in sculpt mode.

Render

Number of subdivisions when rendering the image.

Sculpt Base Mesh

Sculpt at the base mesh, not at the multires sds layer. Note that this property is greyed out when you are not in sculpt mode.

Optimal Display

In object mode the subdivided edges will not be drawn. Only the edges of the base geometry.

Subdivision Subpanel

Subdivision Mode

Subdivide

Adds another layer of subdivision. This subdivision method divides the mesh smooth with the catmull clark algorithm.

Simple

Adds another layer of subdivision. The simple method just divides the existing faces.

Linear

Adds another layer of subdivision. The linear method divides the existing faces and interpolates linear.

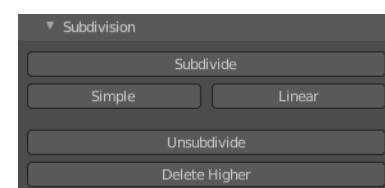

Unsubdivide

Removes all subdivision layers.

Delete Higher

Removes the highest subdivision layer.

Shape subpanel



Reshape

Copies vertex coordinates from another mesh.

Usage: first select a different mesh object with matching topology and vertex indices. Shift select the object you wish to copy vertex coordinates to. Click Reshape.

Apply Base

Modifies the original unsubdivided mesh to match the form of the subdivided sculpted mesh.

Generate Subpanel

Rebuild all possible sds levels to generate a lower resolution base mesh

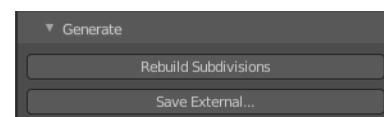

Save External

Saves displacements to an external .btx file. The Multiresolution sds information is then stored externally, so that the blend files doesn't become too big.

File path

Once saved you will see the path to the btx file below the save external button. The save external button has turned into Pack external then.

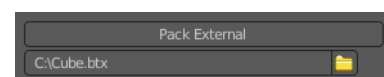

Type

Sets the type of subdivision. Note! You need to set the subdivision type before you start. You can't change it afterwards.

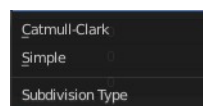

Catmull-Clark

Creates a smoothed surface, using the standard Catmull-Clark subdivision surface algorithm.

Simple

Maintains the current shape, and simply subdivides edges.

Levels Sculpt

The subdivision layer.

Viewport

Set the level of subdivisions to show in Object Mode. In Sculpt mode this value has no effect.

Render

Set the level of subdivisions to show when rendering.

Advanced Subpanel

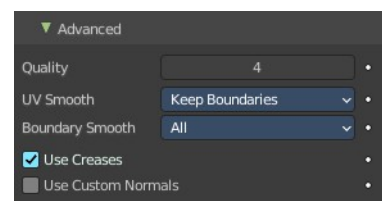

Quality

How precisely the vertices are positioned. This settings becomes active when you have an edge crease applied. This can be done in edit mode in the edge menu.

UV Smooth

How to handle UV's during subdivision.

Smooth, keep corners

UV islands are smoothed, but their boundary remain sharp.

Sharp

UV remain unchanged.

Use Creases

Use the crease information. This settings becomes active when you have an edge crease applied.

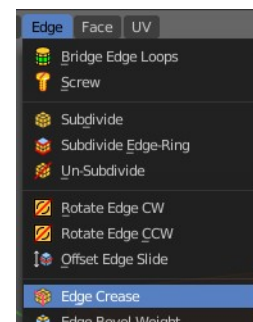

Remesh

The Remesh modifier generates new mesh topology. The output follows the surface curvature of the input. But its topology contains quads.

The output and also the settings of the three basic modes Blocks, Smooth and Sharp is almost identical. Except the smoothing.

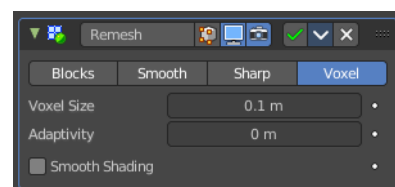

Blocks, Smooth, Sharp

Blocks has no smoothing at all. Smooth outputs a smooth surface. Sharp outputs a smooth surface but preserves sharp edges and corners.

Octree Depth

The resolution of the Octree. Higher values gives finer details.

Scale

The ratio of the largest dimension of the model over the size of the grid.

Sharpness

Sharp mode only. Tolerance for outliers. Higher values produce edges more similar to the input, while lower values filter out noise.

Remove Disconnected

Filter out small disconnected pieces of the output.

Threshold

Use this to control how small a disconnected component must be to be removed.

Smooth Shading

Output faces with smooth shading. The smooth/flat shading of the input faces is not preserved.

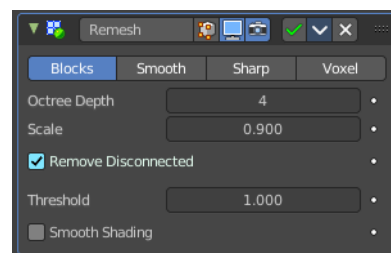

Voxel

Generate a new manifold mesh from the current geometry while trying to preserve the mesh's original volume.

Voxel Size

The voxel size. Defines the resolution of the created mesh.

Adaptivity

Reduces the final face count by simplifying geometry where detail is not needed. This feature triangulates faces that do not need as much detail.

Smooth Shading

Output faces with smooth shading. The smooth/flat shading of the input faces is not preserved.

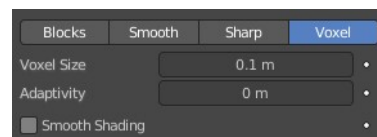

Screw

The Screw modifier takes a profile object, a mesh or a curve, to create a helix-like shape.

The profile should be properly aligned to the cardinal direction of the object.

Angle

Degrees for a single helix iteration.

Screw

Offsets the iteration along its axis.

Iterations

Number of iterations.

Axis

The axis along which the helix will be built.

Screw

The height of one helix iteration.

Axis Object

Pick an object to define the axis direction. The helix will then point into the direction of this object.

Object Screw

Use the distance from the Axis Object to define the height of one helix iteration.

Steps Viewport

Number of steps used for a single revolution displayed in the 3D Viewport.

Render

Number of steps used for a single revolution used during render time. Higher values gives higher quality.

Merge

Merge vertices that lie on the axis of rotation. Closes off end points with a triangle fan.

Merge Distance

Vertices under this distance to the axis are merged.

Stretch UV's

Stretch the UV coordinates from (0.0 to 1.0) when UV's are present.

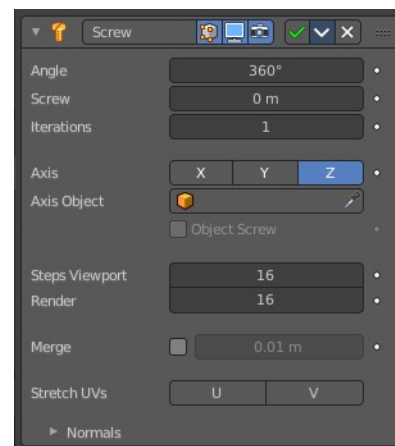

Normals

Smooth Shading

Output faces with smooth shading. The smooth/flat shading of the input geometry is not preserved.

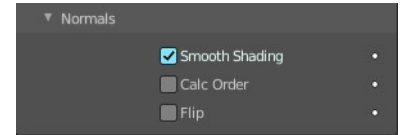

Calculate Order

Order of edges is calculated to avoid problems with normals and shading. Only needed for meshes, not curves.

Flip

Flip normals direction.

Skin

The Skin modifier uses vertices and edges to create a skinned surface. The output is mostly quads. But intersections can also produce triangles.

You can use geometry with faces as the base geometry. But the modifier just uses the vertices and edges information.

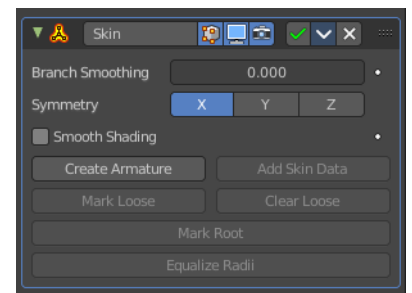

Note! Faces in the original geometry are ignored. The modifier works with the edges and vertices of the geometry. The faces of a cube for example gets removed. The new geometry appears around the edges.

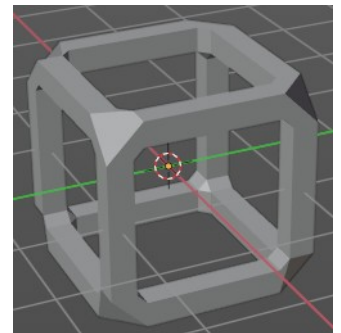

Note! The thickness of the created geometry can be adjusted in Edit mode with the Skin Resize tool.

Note! The Edit mode also activates most of the in Object mode greyed out tools.

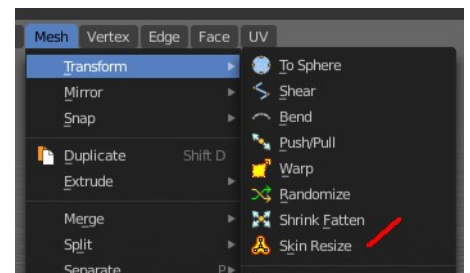

Branch Smoothing

A branch point is a vertex with three or more connected edges. These areas tend to produce more complicated topology, some of which may overlap. This setting relaxes the surface around these points, with the side effect of shrinking it.

Symmetry Axes X/Y/Z

Keep the output topology symmetrical in their here chosen axes.

Note! They do not add geometry flipped across an axis. For that, the Mirror modifier should be used, typically placed above the Skin modifier.

Smooth Shading

Output faces with smooth shading rather than flat shading. The smooth/flat shading of the input geometry is not preserved.

Create Armature

Creates an armature modifier below the Skin modifier. Each edge becomes a bone. And the generated mesh of the Skin modifier is assigned to this armature, with automatic weights. Deforming the armature will then deform the mesh.

Note! If the root vertex has more than one adjacent edge, an extra bone will be created to serve as the root.

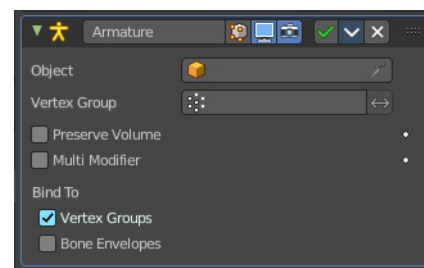

Add Skin Data

The Skin modifier uses a custom set of data in the mesh. This data is generated automatically when you add the Skin modifier the first time. There are use cases where this data can get lost, and the Skin modifier quits working. Add Skin Data then becomes available, and you can update the data.

Mark / Clear Loose

You need to be in Edit Mode to make this tool active.

By default, a branch vertex (vertex with three or more connected edges) will generate extra edge loops along adjacent edges in order to keep the output tight. Branches can be made loose by clicking Mark Loose, which will allow the output to stretch between all adjacent vertices. This can be disabled again by clicking Clear Loose.

Mark Root

You need to be in Edit Mode to make this tool active.

Marking a vertex as root causes that vertex to be used for calculating rotations for connected limbs. Root vertices also affect the armature output, they will be used as the origin for the root bones.

Each set of connected vertices should have one root node (one is selected by default if you do not assign any manually). Mark Root enforces the one-root per set rule, so it is not necessary to manually unmark roots.

Equalize Radii

You need to be in Edit Mode to make this tool active.

Makes the skin radii of selected vertices equal on each axis.

Solidify

The Solidify modifier adds depth and thickness to the faces of a geometry.

Example. A cube with one face removed.

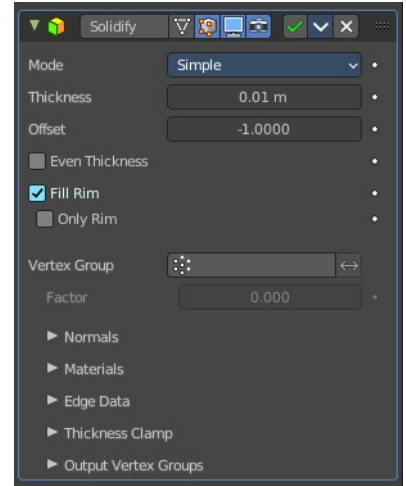
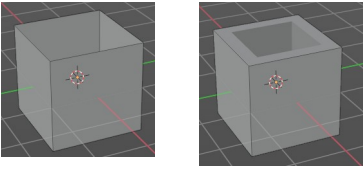

Mode

Simple

This algorithm simply extrudes the geometry. It does not work on geometry where edges have more than two adjacent faces.

Important! Simple mode will not be able to solidify the boundary between two adjacent faces that does not point into the same direction.

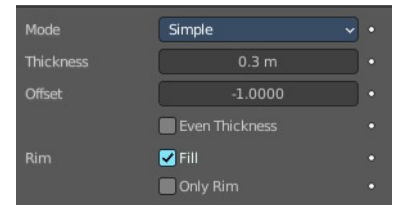
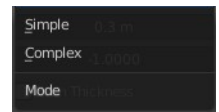

Thickness

The extrude amount.

Offset

A value between (-1 to 1) to locate the solidified output inside or outside the original mesh. The inside and outside is determined by the face normals. Set to 0.0, the solidified output will be centered on the original mesh.

Even Thickness

Maintain the thickness by adjusting for sharp corners.

Note! Solidify thickness is an approximation. The final wall thickness is not guaranteed. The best option to preserve wall thickness is complex mode with constraints thickness mode. But even this is not guaranteed to work perfect in every case.

Fill Rim

Fills the gap between the inner and outer edges.

Note! Fill Rim and Only Rim only make a difference on Non-manifold objects, since the rims are generated from the borders of the original geometry.

Only Rim

Will not extrude surfaces parallel to the original one, but instead will only add the perpendicular rim.

Complex

This solidify algorithm can handle every geometric situation to guarantee a manifold output geometry. It is able to solidify shapes like Möbius strips, Klein bottles, architectural wall layouts and many more which the Simple Mode isn't able to do.

If the special cases are not present it is recommended to choose Simple because the extra logic makes this algorithm much slower.

Note! There are no options for crease in the Modifier tab because crease is handled in a dynamic way. The modifier will transfer the creases of the original mesh in a smart way to the output mesh to work with the Subdivision Surface modifier.

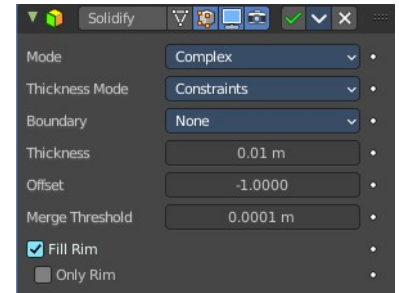

Thickness Mode

Choose the kind of thickness handling.

Fixed

The new vertices are always in a fixed distance to the old ones.

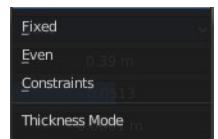

Even

Adjusts for sharp corners, but may not always work when more than three faces come together.

Constraints

For up to three faces it is always guaranteed to find an optimal solution.

Boundary

Choose the kind of boundary handling.

None

No boundary fix is applied. Results are stable.



Round

Adjusts the boundary for an opening to face inwards (like a hole in an egg).

Flat

Adjusts the boundary of a planar opening to be a flat (like a cut sphere).

Thickness

The extrude amount.

Important! The modifier thickness is calculated using local vertex coordinates. If the object has a non-uniform scale, the thickness will vary on different sides of the object. To fix this, either Apply or Clear the scale.

Offset

A value between (-1 to 1) to locate the solidified output inside or outside the original mesh. The inside and outside is determined by the face normals. Set to 0.0, the solidified output will be centered on the original mesh.

Merge Threshold

The distance within which degenerated geometry is merged.

Rim

Note! Fill and Only Rim only make a difference on Non-manifold objects, since the rims are generated from the borders of the original geometry.

Fill Rim

Fills the gap between the inner and outer edges.

Only Rim

Will only leave the generated perpendicular rim

Note! Fill and Only Rim only make a difference on Non-manifold objects, since the rims are generated from the borders of the original geometry.

Vertex Group

Only vertices in this group are solidified. Their weights are multiplied by the thickness, so vertices with lower weights will be less thick.

Invert

Reverses the vertex group, so that only vertices which are not in the vertex group are solidified.

Factor

How much the vertex weights are taken into account. You need to have a vertex group assigned to activate this item.

On 0.0, vertices with zero weight will have no thickness at all (creates duplicate vertices).

On 0.5, vertices with zero weight will be half as thick as those with full weight.

On 1.0, the weights are ignored and the Thickness value is used for every vertex.

Flat Faces

Just in Complex Mode. Use the minimal vertex weight assigned to the vertices of a face to make sure that new faces stays parallel to their original ones. This is slow, so disable it when it is not needed.

Normals

Flip Normals

Reverse the normals of all geometry (both the inner and outer surfaces).



High Quality Normals

Just Simple Mode. Normals are calculated to produce a more even thickness.



Materials

Material Offset

Choose a different material for the new geometry. This is applied as an offset from the original material of the face from which it was solidified.



A value of 0 means it will use the same material.

A value of 1 means it will use the material immediately below the original material.

A value of -2 means the material two positions above the original material will be used.

These values are clamped to the top-most and bottom-most material slots.

Rim

Choose a different material for the rim faces.

Edge Data

Inner, Outer and Rim are simple mode only.

Inner

Set a crease to the inner edges.

Outer

Set a crease to the outer edges.

Rim

Set a crease to the rim.

Bevel Convex

Edge bevel weight to be added to outside edges.

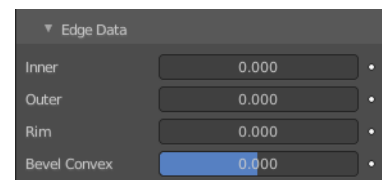

Thickness Clamp

Clamp

A value between (0 to 2) to clamp offsets to avoid self-intersection. The amount is determined by the length of the shortest adjacent edge.

Angle Clamp

If enabled clamping will also consider angles in the geometry, not only lengths. Becomes active when the clamp value is above 0.0.

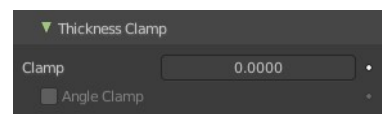

Output Vertex Groups

Shell

Vertex group that the generated shell geometry will be weighted to. This allows you to use other modifiers to only affect the shell geometry by using a that modifier's vertex group influence control.



Rim

Same as Shell Vertex Group, but for the generated rim geometry.

Subdivision Surface

The Subdivision Surface modifier subdivides the faces of the mesh. With Simple it just divides the faces. The Catmull-Clark algorithm allows you to

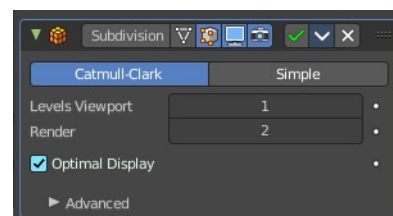

smoothen the result.

Type

Catmull-Clark

Subdivides and smooths the surfaces.

Note! Catmull-Clark subdivision rounds off edges. And sometimes this is not what you want. There are several solutions that allow you to control the subdivision. You can add a so called support edge or a support loop to keep the edge sharp.

Or you can change the crease of the edges in question. Edge Crease can be adjusted in the Transform panel in the Item tab of the sidebar in the 3D view. You need to be in Edit mode.

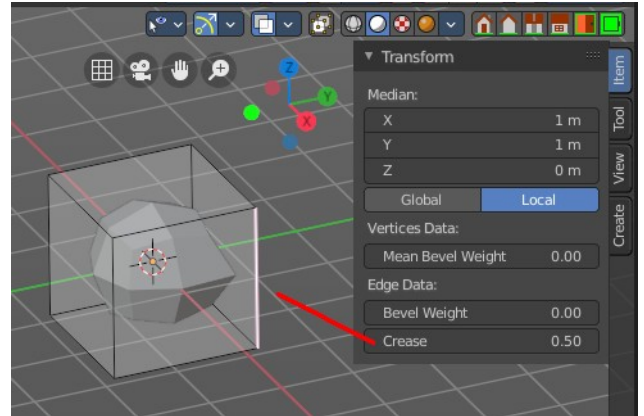

Note! Abrupt normal changes in the surface can produce ugly black gouges, even when these flipped normals are not an issue for the shape itself. A quick way to fix this is to use the Recalculate Normals operation in Edit Mode. If you still have some ugly black gouges you can try to manually flip the normals in question.

Simple

Only subdivides the surfaces, without any smoothing.

Levels Viewport

The number of subdivision levels shown in the 3D Viewport.

Render

The number of subdivision levels shown in the final render.

Optimal Display

When rendering the wire frame of this object, the wires of the new subdivided edges will be skipped. Only the edges of the original geometry will be displayed.

Advanced

Quality

How precisely the vertices are positioned, relatively to their theoretical position of an infinitely subdivided mesh.

Note! This value can have an affect on how accurate Edge Creases can be. Using a higher Quality value will allow for a wider range of crease values to work accurately.

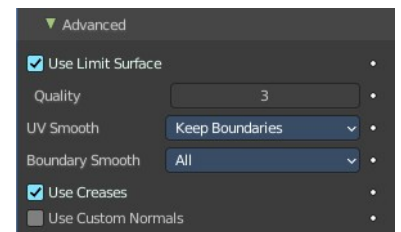

UV Smooth

How to handle UV's during subdivision.

None

UVs are not smoothed, boundaries are kept sharp.

Keep Corners

UV's are smoothed, corners on discontinued boundaries are kept sharp.

Keep Corners, Junctions

UV's are smoothed, corners on discontinued boundaries are kept sharp. And conjunctions of three or more regions are kept sharp.

Keep Corners, Junctions, Concave

UV's are smoothed, corners on discontinued boundaries are kept sharp. And conjunctions of three or more regions and darts and concave corners are kept sharp.

Keep Boundaries

UV's are smoothed, boundaries are kept sharp.

All

UV's and boundaries are smoothed.

Smooth, keep corners

UV islands are smoothed, but their boundary remain sharp.

Sharp

UV remain unchanged.

Boundary Smooth

Keep Corners

Smooth boundaries, but corners are kept sharp.

All

Smooth boundaries, including corners.

Use Creases

Use the Weighted Edge Creases values stored in edges to control the smoothness of the edges.

Use Custom Normals

Interpolates existing custom normals to resulting mesh.

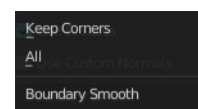
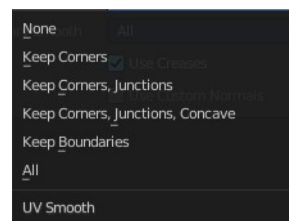

Triangulate

The Triangulate modifier triangulates all faces in a mesh.

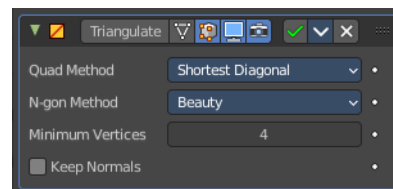

Quad Method

How to triangulate quads.

Beauty

Tries to split the quads in a way that takes the topology into account.

Fixed

Split the quads on their 1st and 3rd vertices.

Fixed Alternate

Split the quads on their 2nd and 4th vertices.

Shortest Diagonal

Split the quads based on the diagonal distance between their vertices.

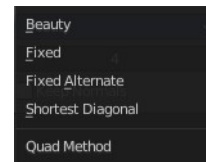

N-Gon Method

How to triangulate N-Gons.

Beauty

Tries to split the N-Gons in a way that takes the topology into account.

Clip

Split the N-Gons by using an ear-clipping algorithm

Minimum Vertices

Minimum number of vertices a face must have to be triangulated. For example, setting this value to 5, will prevent triangulation of Quads and only triangulate N-gons.

Keep Normals

When using custom normals, try to preserve the same shading as before triangulation.

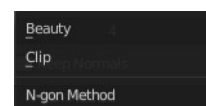

Volume to mesh

This modifier is the inverse of the Mesh to Volume modifier. It takes an existing volume object and converts one of its grids to a mesh. Only scalar grids (such as the density grid) can be converted.

Tip! To copy and move the generated mesh separately from the volume

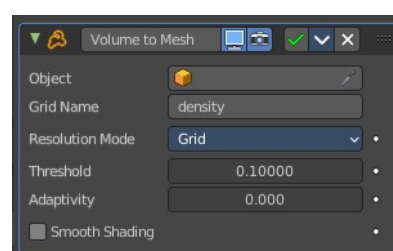

object, use a collection instance.

Object

The source volume object. Pick the volume object here.

Grid Name

The name of the grid to convert. The grid has to be a scalar grid.

Resolution Mode

How the resolution of the final mesh is controlled.



Grid

This makes the resolution dependent on the resolution of the grid that is converted. Higher resolution grids result in a higher resolution mesh. In many cases, that is the most efficient mode.

Voxel Amount

Specifies the approximate resolution of the final mesh. The voxel size is adapted to the size of the entire volume.

Voxel Size

Use a fixed resolution that does not change when the volume changes.

Threshold

Voxels with a larger value are considered to be inside the mesh and all other voxels outside. The mesh will be generated on the boundary of inside and outside voxels. This is sometimes also called the “iso value”.

Adaptivity

This is similar to decimating the final to reduce resolution where it is not needed.

Smooth Shading

Enables smooth shading on the generated mesh.

Weld

The Weld modifier merges vertices within a threshold.

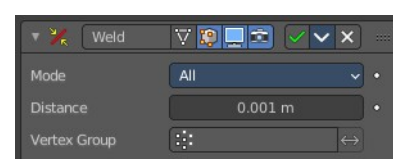

Mode

All

Full merge by distance.

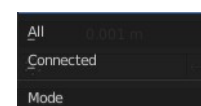

Connected

Just along the edges.

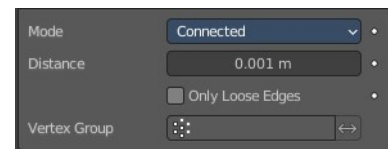

Distance

The maximum distance to merge vertices.

Only Loose Edges

Just with Connected. Welds only loose edges.

Vertex Group

Only merge vertices from this vertex group.

Invert

Inverts the influence of the selected vertex group. Only vertices outside of this vertex group will be merged.

Wireframe

The Wireframe modifier hides the faces of a mesh, and turns the edges into four sided polygon geometry. The result then looks like you would have a wire frame view of the mesh.

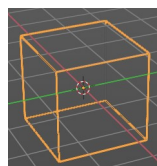

The mesh needs to have faces.

Thickness

The depth or size of the wire frames.

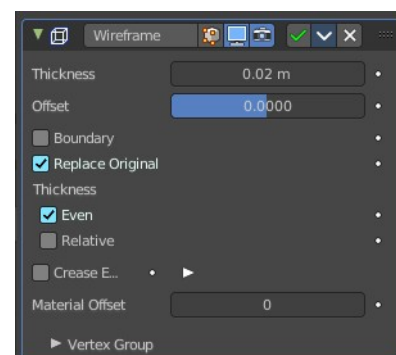

Offset

A value between (-1 to 1) to change whether the wire frames. are generated inside or outside of the original mesh. Set to zero, Offset will center the wire frames. around the original edges.

Boundary

Creates wire frames. on mesh island boundaries.

Replace Original

Replace the original mesh by the generated wire frame mesh. If not, the wire frame is generated on top of it.

Thickness

Warning! Wireframe thickness is an approximation. While Even Thickness should yield good results in many cases, skinny faces can cause ugly spikes. In this case you can either reduce the extreme angles in the geometry or disable the Even Thickness option.

Even

Maintain thickness by adjusting for sharp corners. Sometimes improves quality but also increases computation time.

Relative

Determines the edge thickness by the length of the edge. Longer edges will be thicker.

Crease Edges

This option is intended for usage with the Subdivision modifier. Enable this option to crease edges on their junctions and prevent large curved intersections.

Crease Weight

Define how much crease (0 to 1, nothing to full) the junctions should receive.

Material Offset

Uses the chosen material index as the material for the wire frame; this is applied as an offset from the first material.

Vertex Group

Restrict the modifier to only this vertex group, and use its weighting for thickness.

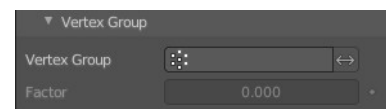

Invert

Inverts the vertex group weights.

Factor

Percentage that the vertex has influence over the final wire frame result.



26.9.3 Editors - Properties Editor - Modifiers Properties Tab - Mesh - Deform Modifiers

Table of content

Detailed table of content.....	1
Mesh - Deform modifiers.....	5
Armature.....	5
Cast.....	7
Curve.....	8
Displace.....	9
Hook.....	11
Laplacian Deform.....	12
Lattice.....	14
Mesh Deform.....	15
Shrinkwrap.....	16
Simple Deform.....	18
Smooth.....	19
Smooth Corrective.....	19
Smooth Laplacian.....	20
Surface Deform.....	21
Warp.....	22
Wave.....	24

Detailed table of content

Detailed table of content

Detailed table of content.....	1
Mesh - Deform modifiers.....	5
Armature.....	5
Object.....	6
Vertex Group.....	6
Invert.....	6
Preserve Volume.....	6
Multi Modifier.....	6
Bind to.....	6
Vertex Groups.....	6
Bone Envelopes.....	6
Cast.....	7
Shape.....	7
Axis.....	7
Factor.....	7
Radius.....	7
Size.....	8
Size from Radius.....	8
Vertex Group.....	8
Invert.....	8
Object.....	8

Curve.....	8
Curve Object.....	8
Deformation Axis.....	8
Vertex Group.....	9
Invert.....	9
Displace.....	9
Workflow.....	9
Texture.....	9
Texture Prop.....	9
Texture browser.....	9
Texture Edit Box.....	9
Fake User.....	9
Add Texture.....	9
Remove.....	9
Change Context.....	9
Coordinates.....	9
Direction.....	10
X, Y, Z.....	10
Space.....	10
Normal.....	10
Custom Normal.....	10
RGB to XYZ.....	10
Space.....	10
Strength.....	10
Mid level.....	10
Vertex Group.....	11
Invert.....	11
Hook.....	11
Object.....	11
Vertex Group.....	11
Invert.....	11
Strength.....	11
Reset.....	11
Recenter.....	11
Select.....	12
Assign.....	12
Falloff.....	12
Type.....	12
Radius.....	12
Uniform Falloff.....	12
Laplacian Deform.....	12
Workflow.....	12
Repeat.....	13
Anchor Weights.....	13
Invert.....	13
Bind.....	13
Unbind.....	13
Error Messages.....	14
Vertex group group_name is not valid.....	14
Vertices changed from X to Y.....	14
Edges changed from X to Y.....	14
The system did not find a solution.....	14
Lattice.....	14

Object.....	14
Vertex Group.....	14
Invert.....	14
Strength.....	14
Mesh Deform.....	15
Object.....	15
Vertex Group.....	15
Invert.....	15
Precision.....	15
Dynamic.....	15
Bind.....	15
Unbind.....	15
Shrinkwrap.....	16
Wrap Method.....	16
Nearest Surface Point + Target Normal Project.....	16
Snap Mode.....	16
Target.....	16
Project.....	16
Snap Mode.....	16
Limit.....	16
Subdivision Levels.....	16
Axis.....	17
Negative/Positive.....	17
Face Cull.....	17
Invert Cull.....	17
Target.....	17
Auxiliary Target.....	17
Nearest Vertex.....	17
Target.....	17
Offset.....	17
Vertex Group.....	17
Invert.....	17
Simple Deform.....	18
Deform Method.....	18
Twist.....	18
Bend.....	18
Taper.....	18
Stretch.....	18
Origin.....	18
Restrictions.....	18
Limits.....	18
Lock.....	18
Vertex Group.....	18
Smooth.....	19
Axis.....	19
Factor.....	19
Repeat.....	19
Vertex Group.....	19
Invert.....	19
Smooth Corrective.....	19
Factor.....	19
Repeat.....	19
Scale.....	19

Smooth Type.....	19
Simple.....	20
Length Weight.....	20
Vertex Group.....	20
Invert.....	20
Only Smooth.....	20
Pin Boundaries.....	20
Rest Source.....	20
Original Coordinates.....	20
Bind Coordinates.....	20
Smooth Laplacian.....	20
Repeat.....	20
Axis.....	21
Lambda Factor.....	21
Lambda Border.....	21
Preserve Volume.....	21
Normalized.....	21
Vertex Group.....	21
Invert.....	21
Surface Deform.....	21
Workflow.....	22
Target.....	22
Interpolation Falloff.....	22
Strength.....	22
Vertex Group.....	22
Invert.....	22
Sparse Bind.....	22
Bind.....	22
Unbind.....	22
Warp.....	22
Object From.....	23
Object To.....	23
Preserve Volume.....	23
Strength.....	23
Vertex Group.....	23
Invert.....	23
Falloff.....	23
Falloff Type.....	23
Radius.....	23
Texture.....	23
Usage.....	23
Texture Prop.....	24
Texture browser.....	24
Texture Edit Box.....	24
Fake User.....	24
Add Texture.....	24
Remove.....	24
Change Context.....	24
Coordinates.....	24
Wave.....	24
Motion.....	25
Cyclic.....	25
Along Normals.....	25

X/Y/Z.....	25
Falloff.....	25
Height.....	25
Width.....	25
Narrowness.....	25
Vertex Group.....	25
Invert.....	25
Start Position.....	26
Object.....	26
Start Position X/Y.....	26
Time.....	26
Offset.....	26
Life.....	26
Damping.....	26
Speed.....	26
Texture subtab.....	26
Usage.....	26
Texture Prop.....	26
Texture browser.....	27
Texture Edit Box.....	27
Fake User.....	27
Add Texture.....	27
Remove.....	27
Change Context.....	27
Coordinates.....	27

Mesh - Deform modifiers

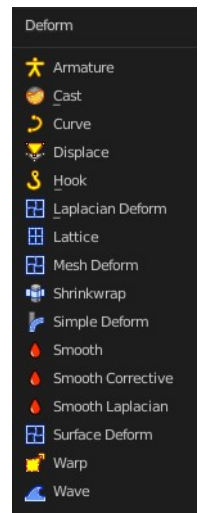

Armature

An armature system allows to deform objects accurately by posing bones. The Armature modifier contains the armature settings at the mesh end.

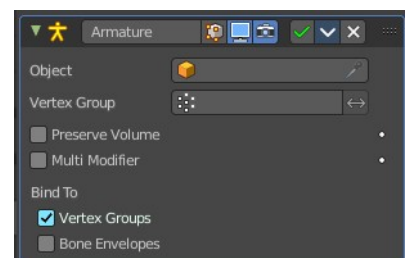

This modifier gets created automatically when you parent a mesh to an armature.

Object

The name of the armature object used by this modifier.

Vertex Group

A vertex group of the object, which weights will be used to determine the influence of this modifier's results when mixing it with the results from other Armature ones.

This is only of use when having at least two of these modifiers on the same object, with Multi Modifier activated.

Invert

Inverts the influence set by the vertex group.

Preserve Volume

Use quaternions for preserving volume of object during deformation.

Without Preserve Volume, rotations at joints tend to scale down the neighboring geometry, up to nearly zero at 180 degrees from rest position. With it, the geometry is no longer scaled down, but there is a discontinuity when reaching 180 degrees from rest position.

Multi Modifier

You can parent an object to more than one armature. The Multi Modifier allows you to use several armatures to deform the same object, all based on the “non-deformed” data.

The results of the Armature modifiers are then mixed together, using the weights of the Vertex Group as “mixing guides”.

Bind to

Vertex Groups

Meshes and lattices only. Use Vertex groups for deforming the mesh. A bone named “forearm”, will only affect the vertices in the “forearm” vertex group. The influence of one bone on a given vertex is controlled by the weight of this vertex in the relevant group.

The vertex groups are located in the Object Data Properties in the Properties editor.

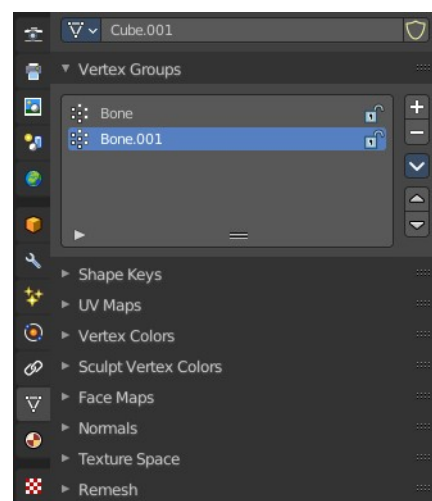

Bone Envelopes

Use the Bone envelopes to deform vertices or control points near them, defined by each bone's envelope radius and distance.

When envelopes are disabled, Blender uses the set of existing vertex group names to determine which bones influences what mesh part.

Bone envelopes display can be turned on in the Viewport Display panel in the Object Data properties tab in the Properties Editor. Display as ...

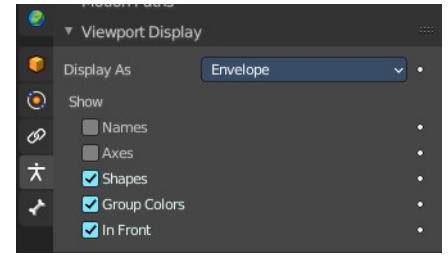

And can be adjusted in the Transform panel in the sidebar of the 3D View, in Edit mode.

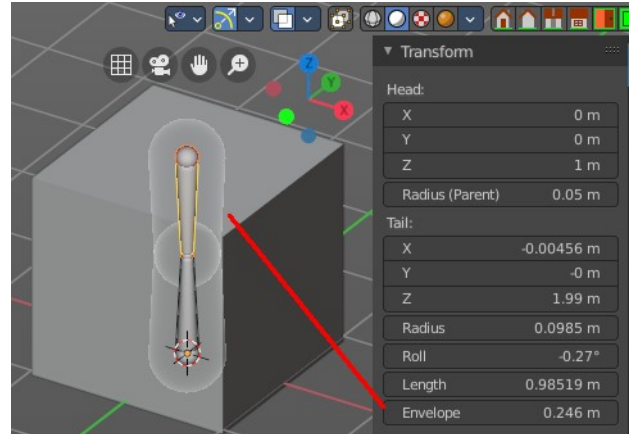

Cast

The Cast modifier shifts the shape of a mesh, curve, surface or lattice object, towards predefined shapes. Sphere, cylinder, cuboid.

Note! For performance reasons, this modifier only works with local coordinates. If the modified object looks wrong, you may need to apply its transformations, especially when casting to a cylinder.

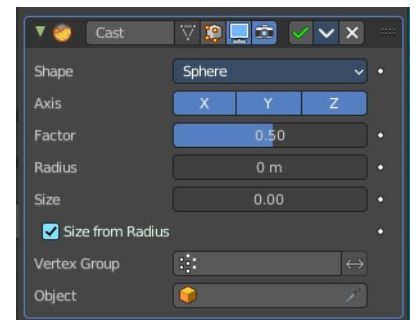

Shape

Choose the target shape of the projection: Sphere, Cylinder or Cuboid.

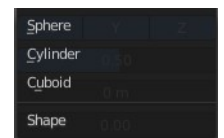

Axis

The directions in which the modifier works. For a Cylinder shape the Z axis remains unaffected.

Factor

The factor to control blending between original and cast vertex positions.

The factor is a linear interpolation. 0.0 gives original coordinates, and the modifier has no effect then. 1.0 casts to the target shape. Values below 0.0 or above 1.0 exaggerate the deformation.

Radius

A value above 0.0 defines a sphere of influence. Vertices outside it are not affected by the modifier.

Size

Alternative size for the projected shape. If zero, it is defined by the initial shape and the control object, if any.

Size from Radius

Calculate Size from Radius. Can give smoother results.

Vertex Group

Restrict the effect to the vertices in that vertex group.

Invert

Inverts the influence of the selected vertex group.

Object

The name of an object to control the effect. The location of this object's origin defines the center of the projection. And its size and rotation transform the projected vertices.

Curve

The Curve modifier deforms a mesh along a curve object. You need to have a curve object in the scene, and choose it as the curve object.

The modifier works in global space on a dominant axis, X, Y, or Z. When you move your mesh in the dominant direction, the object will move along the curve. When you pull into the other axis directions then the object will move away from the dominant axis, and deform.

When you move the object beyond the curve's ends, the object will keep the deformation from the latest curve point.

If the curve is 3D, then the rotation of the object can be controlled by the mean tilt of the curve control points. The mean tilt can be found in edit mode in the sidebar in the Transform panel. Other options in the Shape panel can also have an influence at the deforming result. Like Stretch.

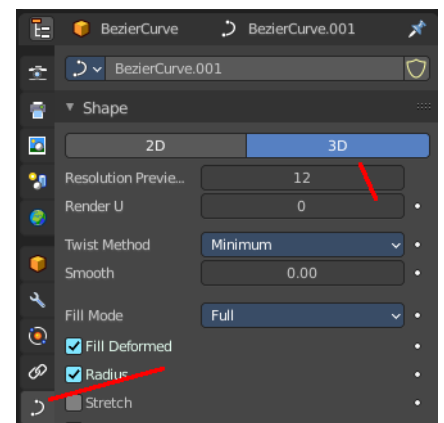
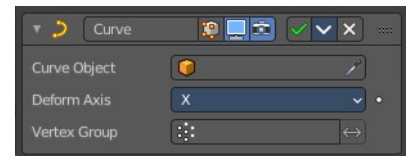
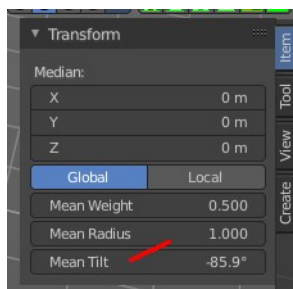

Curve Object

The name of the curve object that will affect the deformed object.

Deformation Axis

The axis to deform along.



Vertex Group

Restrict the effect to the vertices in that vertex group.

Invert

Inverts the influence of the selected vertex group.

Displace

The Displace modifier displaces vertices in a mesh based on the greyscale values of a texture. You can use image textures or procedural textures.

Workflow

Create a texture. Switch to the Texture tab. Load an image texture, or change the type to any procedural image type that fits your needs. Like Clouds.

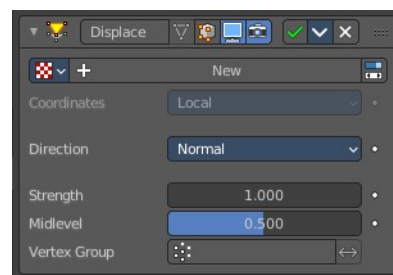

Texture

The name of the texture from which the displacement for each vertex is derived. If this field is empty, the modifier defaults to 1.0 (white).

Texture Prop

Texture browser

A list of the available textures

Texture Edit Box

The name of the currently active texture. Allows to rename the texture too.

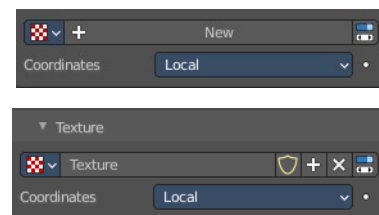

Fake User

Keep this data even when it has no user in the scene.

Add Texture

Add a new texture.

Remove

Removes the texture. Note that the texture is still in the browser list.

Change Context

Jump to texture tab and show the texture.

Coordinates

The texture coordinate system to use for the displacement.

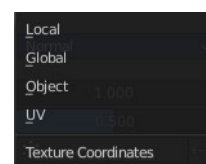

The displacement can be along a particular local axis, along the vertex normal. Or the separate RGB components of the texture can be used to displace vertices in the local X, Y and Z directions simultaneously. This is called Vector Displacement.

Direction

The direction along which to displace the vertices.

X, Y, Z

Displace along an axis.

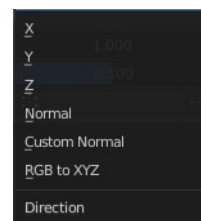

Space

With a direction set to X, Y, Z, or XYZ the modifier can either displace along local or global axes.

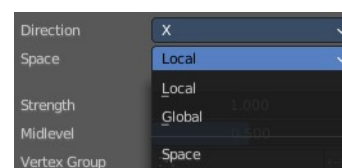

Normal

Displace along the vertex normal.

Custom Normal

Displace along (averaged) custom normals, instead of vertex normals.

RGB to XYZ

Displace along local XYZ axes individually using the RGB components of the texture. Red values displaced along the X axis, Green along the Y, Blue along the Z axis.

Space

With a direction set to X, Y, Z, or XYZ the modifier can either displace along local or global axes.

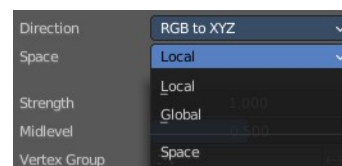

Strength

The strength of the displacement. A negative strength inverts the effect of the modifier.

After offsetting by the Mid level value, the displacement will be multiplied by the Strength value to give the final vertex offset.

$$\text{vertexoffset} = \text{displacement} \times \text{Strength}$$

Mid level

The texture value which will be treated as no displacement by the modifier. Texture values below this threshold will result in negative displacement along the selected direction, while texture values above it will result in positive displacement.

$$\text{displacement} = \text{texturevalue} - \text{Midlevel}$$

Note that that color/luminosity values are typically between (0.0 to 1.0) in Blender, and not between (0 to 255).

Vertex Group

Use a vertex group to control the influence of the modifier.

Invert

Inverts the influence of the selected vertex group.

Hook

The Hook modifier is used to deform a mesh, curve or lattice by another object. When you move this hook object, then it pulls vertices or control points with it.

Assigning the hook object to specific vertices of the target object is done in Edit mode. The modifier shows a set of buttons then.

This modifier is automatically created when you add a Hook from the Hooks menu in the Edge menu in edit mode.

Some settings just exists in Edit mode.

Warning! The Hook Modifier stores vertex indices from the original mesh to determine what to affect. Modifiers that generate geometry, like Subdivision Surface, should always be put after the Hook modifier in the stack. Otherwise, the generated geometry can't be affected by the hook's influence.

Object

The name of the object to hook vertices to.

Vertex Group

Allows you to define the influence per vertex.

Invert

Inverts the influence of the selected vertex group.

Strength

Adjust this hooks influence on the vertices.

Reset

In Edit mode. Recalculate and clear the offset transform of the hook.

Recenter

In Edit mode. Set the hook center to the 3D cursor position.

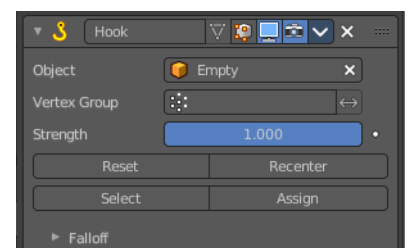
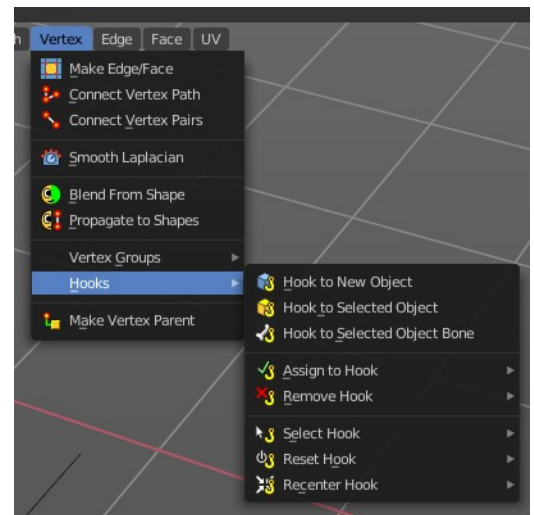
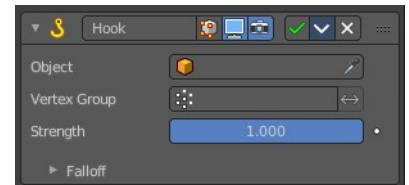

Select

In Edit mode. Select the vertices affected by this hook.

Assign

In Edit mode. Assigns selected vertices to this hook.

Falloff

Type

This can be used to adjust the kind of influence curve that the hook has on the mesh. You can also define a custom curve to get a much higher level of control.

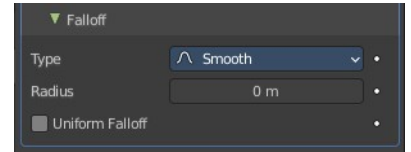

Radius

The size of the hooks influence.

Uniform Falloff

Compensate non uniform scale, and use a uniform falloff.

Laplacian Deform

The Laplacian Deform modifier allows you to pose a mesh by using some anchor vertices and moving them around. The modifier takes care for a proper deformation of the rest of the vertices.

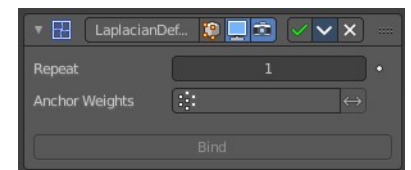

This modifier needs a hook modifier to move the geometry.

Note! With a dense mesh above 100k the algorithm may fail.

Workflow

Switch to Edit mode. Create a single vertex group, and add the vertices that you want to use as the anchor areas.

You need at least two anchor areas.

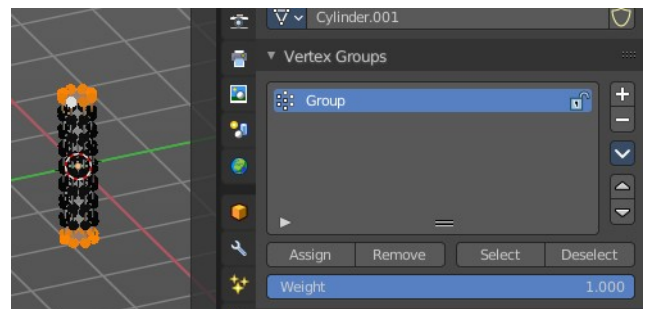

Add a hook to each of this anchor areas. In our case one to the top of the cylinder, and one to the bottom of the cylinder.

I add the hook by Hook to New Object from the Vertex menu here, which creates an empty.

You should now have two hook objects in the modifier stack of the cylinder. And two empties.

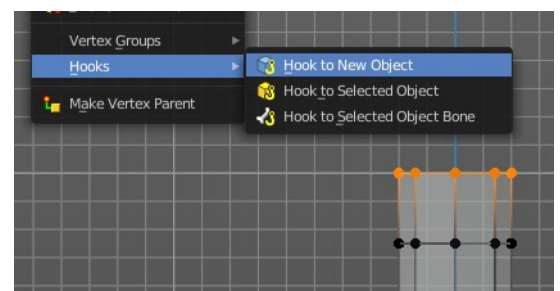

Switch back to object mode. Select the cylinder. Add a Laplacian Deform modifier. In the Anchor Weights edit box select the vertex group that we have created.



Click at Bind to bind the vertex group to the modifier. Note! Binding happens with the current deformation. Not to the unmodified base mesh. When you have moved the hooks already to deform the mesh, then this will be the base for the calculation.

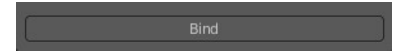

Now move the hooked empties.

Without the Laplacian deform modifier moving the hooked empties will now only pull the vertices that are hooked.

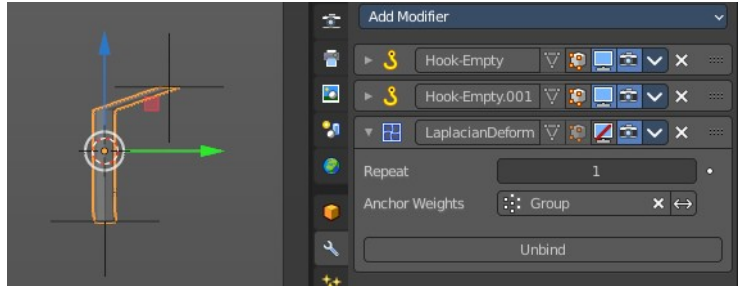

With the Laplacian deform modifier the deformation affects all geometry, which allows you to pose the mesh. The algorithm tries to interpolate the result to give the best possible fitting deformation.

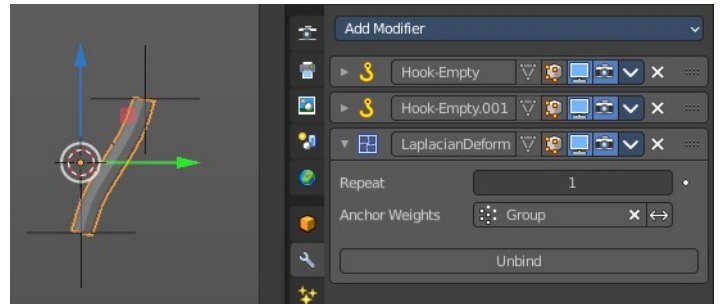

Repeat

How many iterations to use to improve the deformation. More iterations improves detail and calculation time.

Anchor Weights

The group of vertices to use for the transformation. The weight of each vertex does not affect the behavior of the modifier. The method only calculates vertices with a weight greater than 0.

Invert

Inverts the influence of the selected vertex group.

Bind

Bind the vertex group to the modifier. Note! Binding happens with the current deformation. Not to the unmodified base mesh. When you have moved the hooks to deform the mesh, then this will be the base for the calculation.

Unbind

Unconnect the vertex group from the modifier.

Error Messages

Vertex group group_name is not valid

This message is displayed when a user deletes the vertex group or changes its name.

Vertices changed from X to Y

This message is displayed when a user adds or deletes vertices to/from the mesh.

Edges changed from X to Y

This message is displayed when a user adds or deletes edges to/from the mesh.

The system did not find a solution

This message is displayed if the solver could not find a solution.

Lattice

The Lattice modifier deforms the base object by the shape of a Lattice object. It can be used at meshes, curves, surfaces, text, lattices and even particles.

A Lattice modifier with valid settings can be added by selecting the object, holding down shift, select the target lattice object, and then choose Lattice Deform in the Parent menu.

Note! When you want to use a lattice to deform particles, then you need to place the Lattice modifier after the Particle System modifier.

Object

The Lattice object that deforms the base object.

Vertex Group

Limit the modifier's effect to a vertex group of the base mesh.

Invert

Inverts the influence of the selected vertex group.

Strength

A factor to control blending between original and deformed vertex positions.

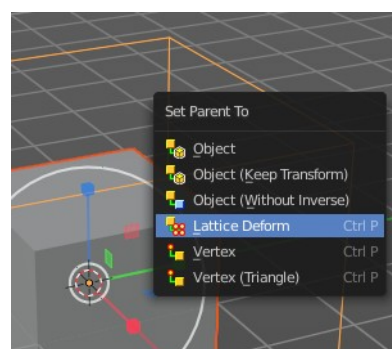
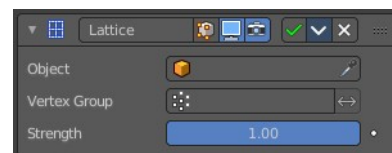

Mesh Deform

The Mesh Deform modifier allows an arbitrary mesh of any closed shape to act as a deformation cage around another mesh.

Note! The changes are not displayed in edit mode. But Edit mode is where you deform your cage object.

Note! This modifier can run out of memory and crash.

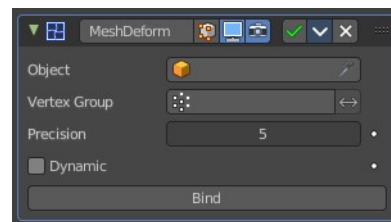

Object

The name of the mesh object to be used as the deforming cage.

Vertex Group

Restrict the affected vertices to a vertex group.

Invert

Inverts the influence of the selected vertex group.

Precision

Controls the accuracy with which the deform mesh cage alters the deformed object when the points on the cage are moved. Higher values means better precision and higher calculation time.

This setting is unavailable once a cage has been bound.

Dynamic

When activated, other mesh altering features (such as other modifiers and shape keys) are taken into account when binding. This increases the deformation quality.

This setting is unavailable once a cage has been bound.

Bind

Bind the current vertex positions of both, the modified geometry and the deforming Object, together. An unbound Mesh Deform modifier has no effect. It must be bound so that altering the shape of the deform mesh cage is able to alter the shape of the modified object.

Warning! It can take a long time for the operation to complete. And the software may not respond for a pretty while.

Unbind

Unbind the meshes. The deformed object will reset back to its original shape that it had before it was bound to the deform mesh cage.

Shrinkwrap

The Shrinkwrap modifier allows an object to “shrink” to the surface of another object. It moves each vertex of the object to the closest position on the surface of the target object.

It can be applied to meshes, lattices, curves, surfaces and texts.

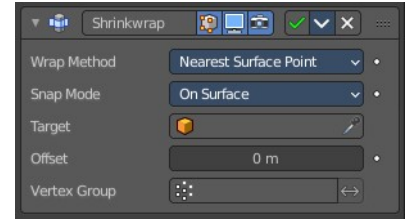

Wrap Method

The method to determine the nearest point on the target’s surface for each vertex of the object.

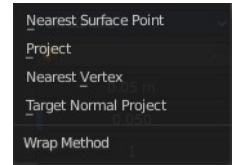

Nearest Surface Point + Target Normal Project

Nearest Surface Point selects the nearest point at the surface. Additionally, Target Normal Project tries to match the interpolated normals of the surface.



Snap Mode

How the vertex snaps to the surface. The methods should be self explaining.

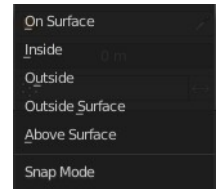

Target

The target mesh to shrink to.

Project

Projects all vertices along a chosen axis until they hit the surface of the target object.

Vertices that never hits the surface are not calculated.

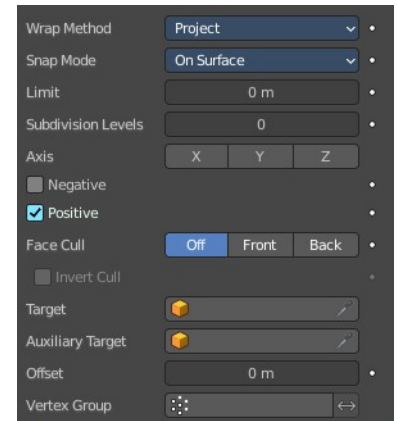

Snap Mode

How the vertex snaps to the surface. The methods should be self explaining.

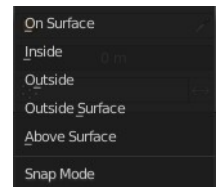

Limit

A distance limit between original vertex and surface. If the distance is larger than this limit vertex would not be projected onto the surface.

Subdivision Levels

This applies a (temporary) Catmull-Clark subdivision to the modified object’s geometry, before computing the wrap.

Axis

Along which local axis of the modified object the projection is done. These options can be combined with each other, yielding a “median axis” of projection. If none are selected, the normal direction is used.

Negative/Positive

This allows you to select the allowed direction(s) of the shrink along the selected axis. If both options are enabled, both ways are evaluated and the closest hit is selected.

Face Cull

Allows you to prevent any projection over the “front side” or the “back side” of the target’s faces. The “side” of a face is determined by its normal.

Invert Cull

When projecting in the negative direction then invert culling.

You need to have negative ticked and face cull either front or back to set this property active.

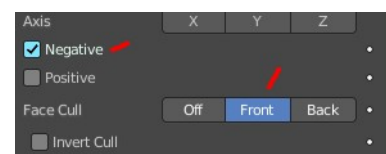

Target

The target mesh to shrink to.

Auxiliary Target

An additional object to project to.

Nearest Vertex

Snaps to the nearest vertex instead of the nearest surface point.

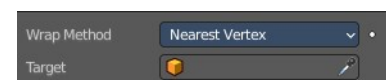

Target

The target mesh to shrink to.

Offset

An offset distance to keep to the target surface.

Vertex Group

Restrict the affected vertices to a vertex group.

Invert

Inverts the influence of the selected vertex group.

Simple Deform

The Simple Deform modifier allows simple deforming of an object of type Mesh, lattice, curve, surface and text.

The deformation is calculated in local coordinate space.

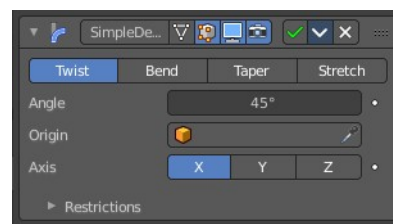

Deform Method

Twist

Twist rotates the object around an axis. Vertices in the same plane as the origin are not rotated. Above the origin the rotation is clockwise. Below the origin the rotation is negative. The amount of rotation is dependent of the distance to the origin. Closer vertices rotates not so strong.

Bend

Bend bends the object over an axis.

Taper

Taper tapers the object across its origin. The scaling factor is weighted by the distance from the origin of the object in the deform axis.

Stretch

Stretch scales the object along an axis.

Angle (Twist & Bend) / Factor (Taper & Stretch)

The total amount of deformation. A negative value reverses the deformation.

Origin

Pick an object to use its origin as the origin for the simple deformation.

Restrictions

Limits

You can set lower and upper limits for the deformation. The upper limit cannot be lower than the lower one. These limits are mapped on the Deform axis.

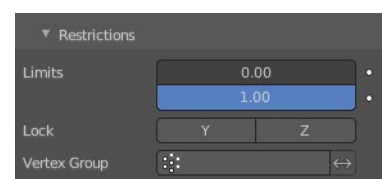

Lock

Not for Bend. Do not allow deformations along these axis.

Vertex Group

Limit the deformation to a vertex group.

Smooth

The Smooth modifier smoothens a mesh by flattening the angles between adjacent faces.

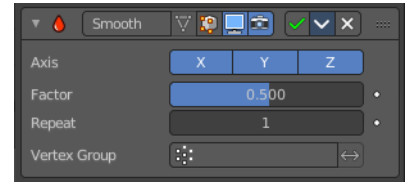

Axis

The axis to modify.

Factor

The smoothing amount. Higher values will increase the effect. Values outside expected range (above 1.0 or below 0.0) will distort the mesh.

Repeat

The number of smoothing iterations.

Vertex Group

Limit the modifier to a vertex group.

Invert

Inverts the influence of the selected vertex group.

Smooth Corrective

The Smooth Corrective modifier tries to reduce highly distorted areas of a mesh. Like an armature with distortions at bent knees.

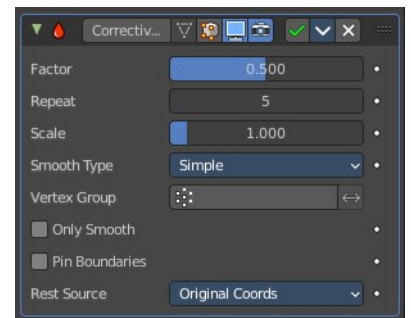

Factor

The factor to control the smoothing amount. Higher values will increase the effect. Values outside expected range (above 1.0 or below 0.0) will distort the mesh.

Repeat

The number of smoothing iterations, equivalent to executing the Smooth tool multiple times.

Scale

Additional scaling factor to increase the size of the mesh. This is useful because sometimes the Smooth Corrective modifier will introduce volume loss, especially when used with a rig.

Smooth Type

The smoothing method.



Simple

Relaxes vertices to their connected edges.

Length Weight

Weights by the distance of surrounding vertices. This option can give higher quality smoothing in some cases, by better preserving the shape of the original form.

Vertex Group

Restrict the effect to a vertex group.

Invert

Inverts the influence of the vertex group.

Only Smooth

Preview the smoothing used, before correction is applied.

Pin Boundaries

Prevent boundary vertices from smoothing.

Rest Source

Select the source for reference vertex positions that defines the undeformed state.



Original Coordinates

Use the original input vertex positions. This relies on the original mesh having the same number of vertices as the input, modified mesh.

Bind Coordinates

Optionally you may bind the modifier to a specific state. This is required when there are constructive modifiers such as Subdivision Surface or Mirror in the stack before this modifier.

Smooth Laplacian

The Smooth Laplacian modifier tries to reduce noise on a mesh's surface with minimal changes to its shape. It can also exaggerate the shape using a negative Factor.

Repeat

Repeat the smoothing operation multiple times. Each repetition causes the flow curvature of the mesh to be recalculated again, and as a result it removes more noise with every new iteration using a small Factor < 1.0 .

With a value of 0, no smoothing is done.

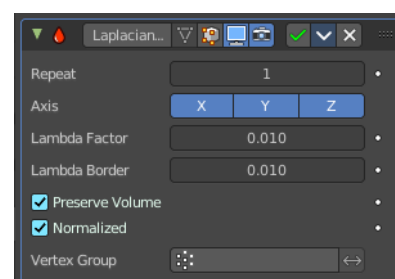

Axis

Enable deforming in single axis directions. The axis are in world space.

Lambda Factor

Controls the amount of displacement of every vertex along the flow curvature.

Lambda Border

Border edges must be controlled separately. Border edges are controlled by the lambda border value.

Preserve Volume

The smoothing process can shrink the volume. Presever Volume tries to prevent that.

Normalized

Normalize the results dependent on face sizes. When disabled, geometry spikes may occur.

Vertex Group

Limit the modifier effect to a vertex group.

Invert

Inverts the influence of the vertex group.

Surface Deform

The Surface Deform modifier allows an arbitrary mesh surface to control the deformation of another object.

A use case is to use a cloth simulation of a low poly mesh to drive the motion of your final mesh.

The target mesh:

- Must not contain edges with more than two faces.
- Must not contain concave faces.
- Must not contain overlapping vertices (doubles).
- Must not contain faces with co-linear edges.

Note! The meshes are bound in global coordinates. But later transformations on the objects are ignored. This means that one can freely transform the target or modified object after binding, without affecting the modified object. The modified mesh will only pick up changes to the target object's mesh itself.

Note! The more a mesh surface differs from the target mesh surface, the more likely it will show undesirable artifacts. So it is recommended to have reasonably well matching meshes to get a good bind.

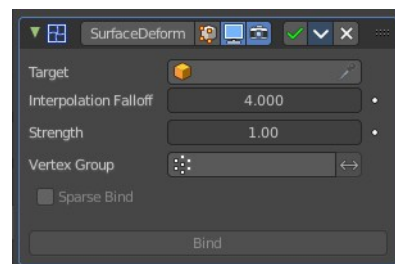

Workflow

Create a cloth simulation at your low poly object.

Create the high poly version.

Add the Surface Deform modifier.

Choose the object with the cloth simulation as the target.

Click at the Bind button to make the deformation real.

The object with the modifier applied will now deform, following the vertice motion of the source object.

Target

The object with the cloth deform animation.

Interpolation Falloff

How much a vertex bound to one face of the target will be affected by the surrounding faces. This essentially controls how smooth the deformations are. This setting becomes unavailable after binding.

Note! Lower values result in smoother deformations, but may also introduce artifacts.

Strength

The overall amount of influence the modifier has on deforming the mesh.

Vertex Group

Limit the influence to a vertex group.

Invert

Inverts the influence of the selected vertex group.

Sparse Bind

Requires to choose a vertex group. Only record binding data for vertices matching the vertex group at the time of bind.

Bind

Bind the current state of the modified mesh to the current state of the target mesh. Any later change in the target mesh will deform the source mesh then. Bind is required to make the modifier work.

Unbind

Unbind the source mesh from the target mesh.

Warp

The Warp modifier warps parts of a mesh to a new location by using two target objects. The deformation goes

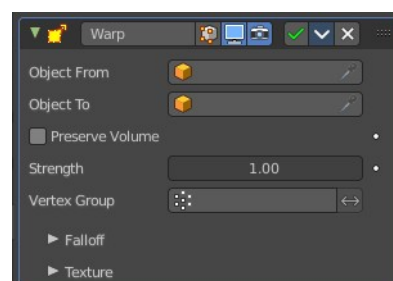
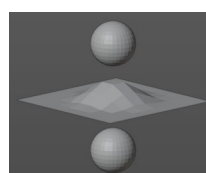

into the direction from the first target object to the second target object. This target objects can be of any type. Empty, Lamp, Camera, etc. For demonstration purposes two spheres are used.

Object From

The object to define the origin transformation of the warp.

Object To

The object to define the destination transformation of the warp.

Preserve Volume

Enables volume preservation when rotating one of the transforms.

Strength

Sets how strong the effect is.

Vertex Group

Limit the modifier to a vertex group.

Invert

Inverts the influence of the selected vertex group.

Falloff

Falloff Type

The falloff type. How the strength of the warp changes as it goes from the center of the transform to the Radius value.

Radius

The distance from the transforms that can be warped by the transform handles.

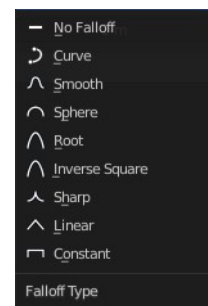
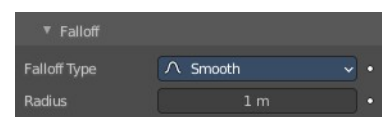

Texture

A texture allows you to control how the vertices are affected by the modifier.

Usage

Add a texture.

Head over to the Texture tab.

In the texture tab either load an existing texture. Or create one. A procedural Noise texture for example.

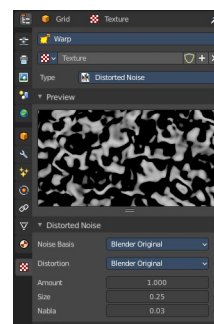
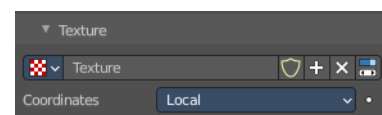

Texture Prop

Texture browser

A list of the available textures

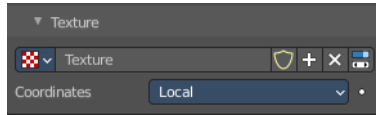

Texture Edit Box

The name of the currently active texture. Allows to rename the texture too.

Fake User

Keep this data even when it has no user in the scene.

Add Texture

Add a new texture.

Remove

Removes the texture. Note that the texture is still in the browser list.

Change Context

Jump to texture tab and show the texture.

Coordinates

What texture coordinate system to use.

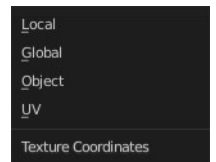

Wave

The Wave modifier adds a ripple-like shape to an object's geometry. The shape can be animated by playing the animation.

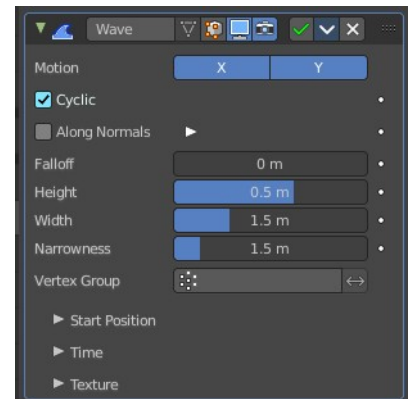
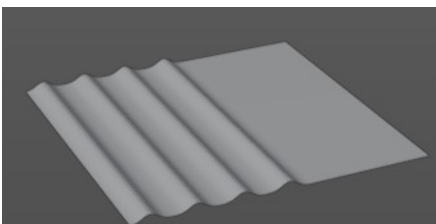

This modifier works with meshes, lattices, curves, surfaces and texts.

Important! All the values are in local object space. They must be multiplied with the corresponding Scale values of the object to get the real dimensions.

To obtain a nice wave effect similar to sea waves and close to a sinusoidal wave, make the distance between following ripples and the ripple width equal. That is, the Narrowness value must be equal to $2 / \text{Width}$. E.g. for Width to be 1, set Narrow to 2.

Motion

The wave effect deforms vertices/control points in the Z direction. The initial start point is the object origin. The direction is then in X or Y direction. With both activated you get a circle shape.

Cyclic

Repeats the waves.

When you want to have more circles at frame 1 already, then use a negative Offset in the Time subpanel.

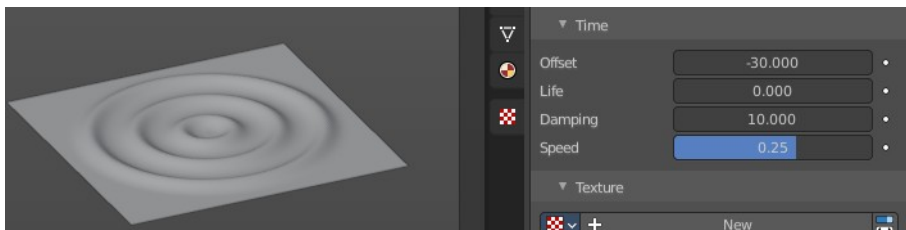

Along Normals

For meshes only. Displaces the mesh along the surface normals (instead of the object's Z axis).



X/Y/Z

Restrict displacement along normals to the selected local axes.

Falloff

Controls how fast the waves fade out as they travel away from the starting point.

Height

The height or amplitude of the ripple.

Width

Distance between the waves. If the pulses are too near to each other, the wave may not reach the zero Z position. In this case the whole wave gets lowered so that the minimum is zero, and the maximum is lower than the expected amplitude.

Narrowness

The actual width of each pulse.

The higher the value the narrower the pulse. The actual width of the area for a single is given by $4 / \text{Narrowness}$.

Vertex Group

Limit the effect of the modifier to a vertex group.

Invert

Inverts the influence of the selected vertex group.

Start Position

Object

Use the origin of another object as the starting point.

Start Position X/Y

Coordinates of the center of the waves, in object's local space.

Time

Settings to control the animation.

Offset

Time offset in frames. The frame at which the wave begins (if Speed is positive), or ends (if Speed is negative). Use a negative frame number to prime and pre-start the waves.

Life

Duration of animation in frames. With a value of zero the animation loops forever.

Damping

An additional number of frames in which the wave slowly damps from the Height value to zero after Life is reached. The dampening occurs for all the ripples and begins in the first frame after the Life is over. Ripples disappear over Damping frames.

Speed

The speed per frame, of the ripple.

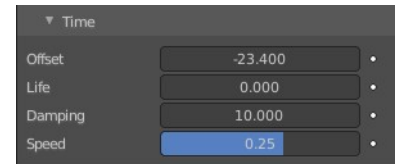

Texture subtab

A texture allows you to control how the vertices are affected by the modifier.

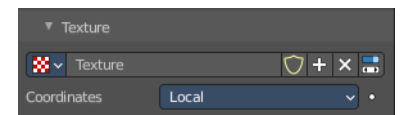

Usage

Add a texture.

Head over to the Texture tab.

In the texture tab either load an existing texture. Or create one. A procedural Noise texture for example.

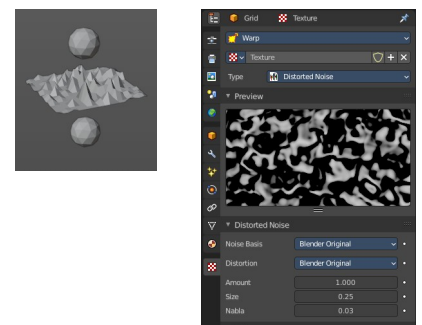

Texture Prop

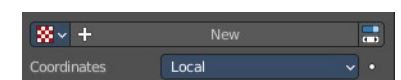

Texture browser

A list of the available textures

Texture Edit Box

The name of the currently active texture. Allows to rename the texture too.

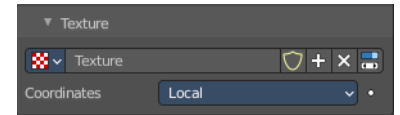

Fake User

Keep this data even when it has no user in the scene.

Add Texture

Add a new texture.

Remove

Removes the texture. Note that the texture is still in the browser list.

Change Context

Jump to texture tab and show the texture.

Coordinates

What texture coordinate system to use.

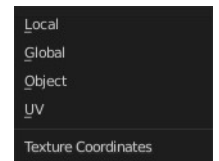



26.9.4 Editors - Properties Editor - Modifiers Properties Tab - Mesh - Deform Modifiers

Table of content

Detailed table of content.....	1
Mesh - Physics modifiers.....	3
Cloth.....	3
Collision.....	3
Dynamic Paint.....	4
Explode.....	4
Fluid.....	5
Ocean.....	6
Particle Instance.....	10
Particle System.....	13
Soft body.....	13

Detailed table of content

Detailed table of content

Detailed table of content.....	1
Mesh - Physics modifiers.....	3
Cloth.....	3
Collision.....	3
Dynamic Paint.....	4
Explode.....	4
Particle UV.....	4
Alive / Dead / Unborn.....	4
Alive.....	4
Dead.....	4
Unborn.....	5
Cut Edges.....	5
Size.....	5
Vertex Group.....	5
Invert.....	5
Protect.....	5
Refresh.....	5
Fluid.....	5
Ocean.....	6
Geometry.....	6
Generate.....	6
Displace.....	6
Repeat X, Repeat Y.....	6
Resolution.....	6
Time.....	6
Depth.....	6
Size.....	7

Spatial Size.....	7
Random Seed.....	7
Generate Normals.....	7
Waves.....	7
Scale.....	7
Smallest Wave.....	7
Choppiness.....	7
Wind Velocity.....	7
Alignment.....	7
Direction.....	8
Damping.....	8
Foam.....	8
Data Layer.....	8
Coverage.....	8
Spray.....	8
Data Layer.....	8
Invert.....	8
Spectrum.....	9
Spectrum.....	9
Turbulent Ocean.....	9
Established Ocean.....	9
Established Ocean (Sharp Peaks).....	9
Shallow Water.....	9
Bake.....	9
Bake Ocean.....	9
Cache Path.....	9
Frame Start, End.....	9
Foam Fade.....	10
Particle Instance.....	10
Object.....	10
Particle System.....	10
Create Instances.....	10
Regular.....	10
Children.....	10
Size.....	11
Show.....	11
Unborn.....	11
Alive.....	11
Dead.....	11
Amount.....	11
Offset.....	11
Coordinate Space.....	11
Axis.....	11
Create Along Paths.....	12
Position.....	12
Random.....	12
Rotation.....	12
Random.....	12
Keep Shape.....	12
Layers.....	12
Index.....	12
Value.....	12
Particle System.....	13

Mesh - Physics modifiers

Cloth

The cloth modifier gets added into the modifier stack when you add a cloth physics in the Physics tab. It enables cloth simulation for the mesh.

All the cloth settings and adjustments happens in the Physics tab. The cloth modifier has no further settings.

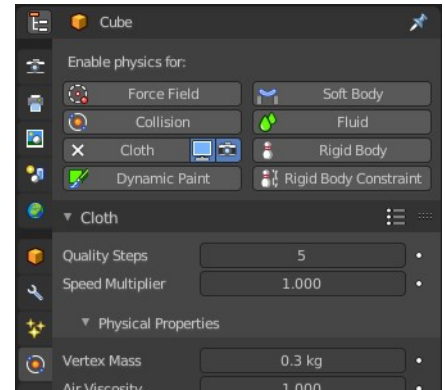
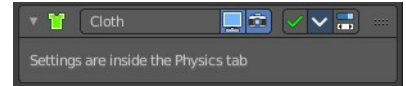

Collision

The collision modifier gets added into the modifier stack when you add a collision physics in the Physics tab. It enables collision for the mesh.

All the collision settings and adjustments happens in the Physics tab. The collision modifier has no further settings.

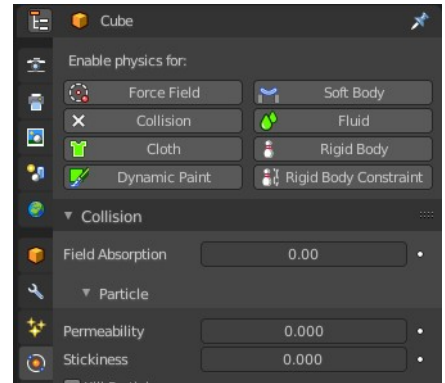
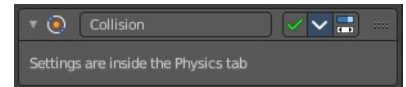

Dynamic Paint

The dynamic paint modifier gets added into the modifier stack when you add a dynamic paint physics in the Physics tab. It enables dynamic painting. Which turns objects into paintable canvases to modify vertex colors or displacement. Like footsteps in snow.

All the collision settings and adjustments happens in the Physics tab. The dynamic paint modifier has no further settings.

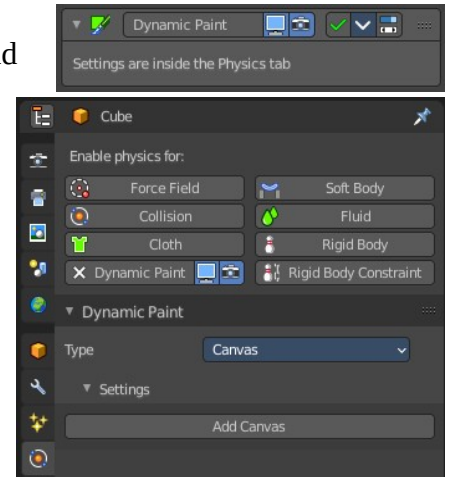

Explode

The Explode modifier gets added into the modifier stack when you add a Quick Explode quick effect, together with a particle system. It splits the object apart, and uses the split parts as particles for an explosion like particle animation.

The modifier requires particles to work. The particles effect controls how the explosion looks like. And the explode modifier must come after the particles modifier.

The Explode modifier has some further settings. But all the particles settings and adjustments happens in the Physics tab.

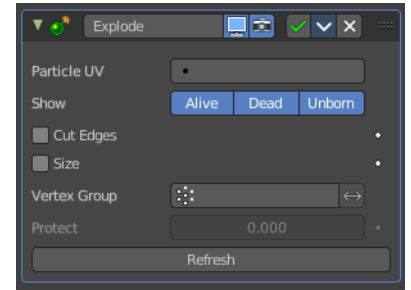

Particle UV

The UV map to change with particle age. The U value of the coordinates in that UV map will be overwritten with the age of the particle attached to the matching mesh face. In proportion, from 0 for not yet born particles, to 1 for dead ones.

The V value is set to a constant 0.5 value.

This allows to make the color of a fragment (face) vary during its 'explosion' phase, by using a texture with a gradient of colors along its U axis.

Alive / Dead / Unborn

Alive

Show faces when their attached particles are alive.

Dead

Show faces when their attached particles are dead.

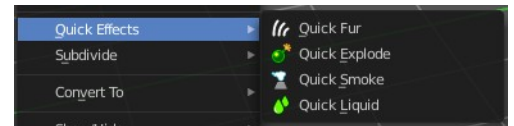

Unborn

Show faces when their attached particles are unborn.

Cut Edges

Split the mesh in pieces based on location of emitted particles, instead of using existing faces. This will produce a splitting that appears more random.

Size

Scale each face using the size of its attached particle, once that particle is alive.

Vertex Group

Limit the modifier effect to a vertex group.

Invert

Inverts the influence of the selected vertex group.

Protect

Clean vertex group edges.

Depending on the weights assigned to that vertex group. A value of 1 completely protect those faces from being affected by the Explode modifier. A value of 0 fully applies the modifier to the faces.

Refresh

Refresh data in the Explode modifier.

Fluid

The fluid modifier gets added into the modifier stack when you add a fluid physics in the Physics tab. It enables fluid simulations.

All the settings and adjustments happens in the Physics tab. The fluid modifier has no further settings.

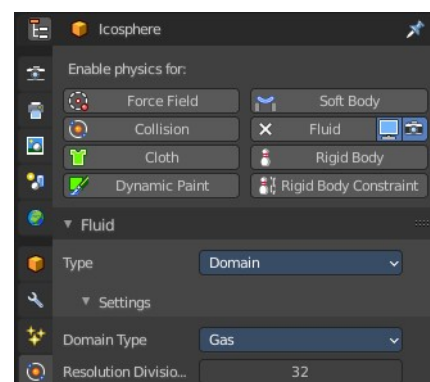
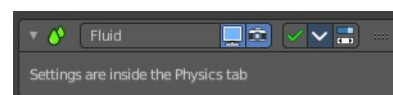

Ocean

The Ocean modifier is a tool to simulate and generate a deforming ocean surface. It is intended to simulate deep ocean waves and foam.

By default, the simulator only generates displacement data, since it takes the least amount of work and gives the fastest feedback. Additional simulation data can be generated for rendering as well.

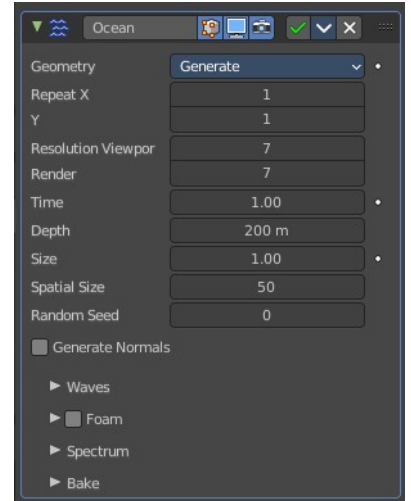

Geometry

Generate

Creates a tiled mesh grid. The existing mesh object is replaced by the ocean grid. The generated mesh comes with UV mapping.

Displace

The ocean modifier displaces the existing mesh.

Repeat X, Repeat Y

How often the grid is tiled in X and Y directions. The UV's gets repeated.

Resolution

The resolution of the internal 2D grids generated by the simulation.

The internal grids are powers of two of the resolution value. So a resolution value of 16 will create simulation data of size 256×256. The higher the resolution, the more details will be produced, but the slower it will be to calculate.

Note! When using the Generate modifier geometry option, this resolution value also determines the resolution of the generated mesh surface, equal to the resolution of the internal simulation data.

Time

The time at which the ocean surface is being evaluated. To make an animated ocean, you will need to animate this value by adding keyframes. The speed that the time value is changing will determine the speed of the wave animation.

Depth

The constant depth of the ocean floor under the simulated area. Lower values simulate shallower waters by producing higher frequency details and smaller waves.

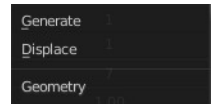

Size

A simple scaling factor that does not affect the height of the waves or behavior of the simulation.

Spatial Size

The width of the ocean surface area being simulated, in meters. This also determines the size of the generated mesh, or the displaced area. Of course, you can scale the object with the Ocean modifier in Object Mode to tweak the apparent size in your scene.

Random Seed

A different seed will produce a different simulation result.

Generate Normals

Simulates additional normal map data.

When mapped to Normals, this can be used by the Ocean texture as a bump map. And enables generating normal map image sequences when baking.

Waves

Scale

An overall scale control for the amplitude of the waves. It approximates the height or depth of the waves above or below zero.

Rather than just scaling the ocean object in Z, it scales all aspects of the simulation, displacement in X and Y, and corresponding foam and normals too.

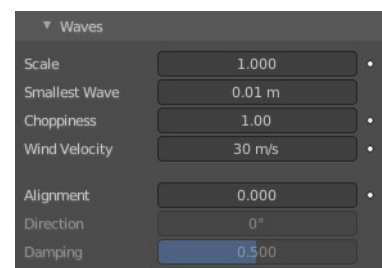

Smallest Wave

A minimum limit for the size of generated waves. Acts similarly to a low-pass filter, removing higher frequency wave detail.

Choppiness

The choppiness of the wave peaks. With a choppiness of 0, the ocean surface is only displaced up and down in the Z direction, but with higher choppiness, the waves are also displaced laterally in X and Y, to create sharper wave peaks.

Wind Velocity

Wind speed in meters/second. With a low velocity, waves are restricted to smaller surface waves.

Alignment

The directionality of the wave shapes due to wind. At a value of 0, the wind and waves are randomly, uniformly oriented.

With higher Alignment values, the wind is blowing in a more constant direction, making the waves appear more compressed and aligned to a single direction.

Direction

The direction in degrees that the waves are aligned to. X axis is used as reference.

Damping

The amount that inter-reflected waves are damped out. This has the effect of making the wave motion more directional, and not just the wave shape.

With a Damping of 0.0, waves are reflected off each other in every direction, with a Damping of 1.0, these inter-reflected waves are damped out, leaving only waves traveling in the direction of the wind.

Foam

Simulate extra foam data.

Data Layer

Type in a name. This name defines a vertex data layer which is used by the Ocean Modifier to store a foam map as vertex colors. This name is then used to access this vertex data layer by an Attribute node in the ocean material.

Note that creating the full working ocean material is an own chapter, which cannot be covered here.

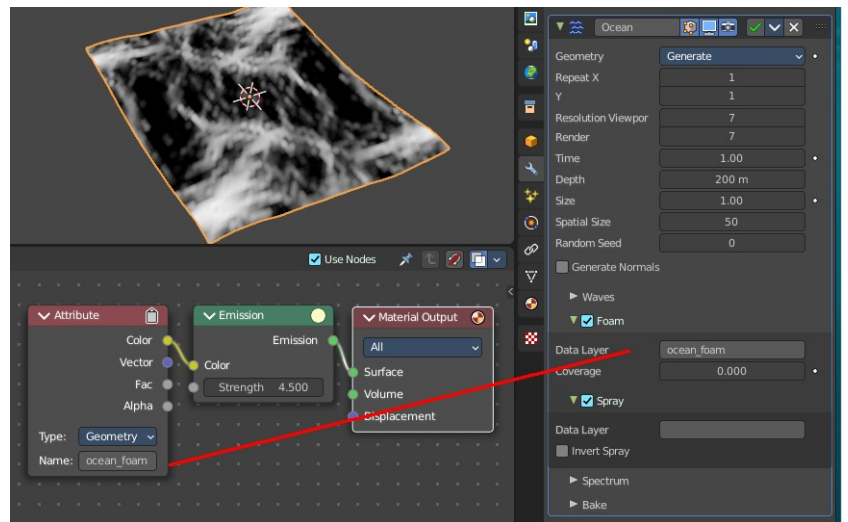
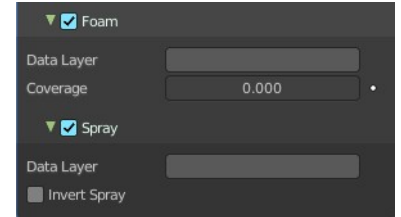

Coverage

The amount of foam covering the waves. Negative values will reduce the amount of foam, and leave only the topmost peaks. Positive values will add to it.

Spray

Data Layer

Type in a name. This name defines a vertex data layer which is used by the Ocean Modifier to store a spray direction map as vertex colors. This name is then used to access this vertex data layer by an Attribute node in the ocean material.

Invert

Inverts the spray direction map.

Spectrum

Spectrum

What wave spectrum model to use. Wave spectra are used to describe how energy moves through the waves at different frequencies. Energy travels through waves differently depending on the depth of the water and the wind speed.

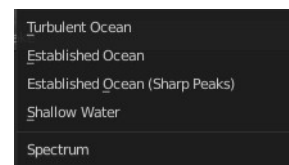
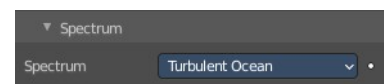

Turbulent Ocean

Use for turbulent seas with foam (Phillips).

Established Ocean

Use for a large area, established ocean where the ocean would extend for miles with wind blowing for days allowing the waves to reach a point of equilibrium (Pierson-Moskowitz method).

Established Ocean (Sharp Peaks)

Similar to regular Established Ocean however, waves will continue to grow with time creating sharper peaks (JONSWAP and Pierson-Moskowitz method). An extra parameter is used to define the sharpness of these peaks.

Shallow Water

Use for shallow water with depths less than about 10 meters which makes it great for small lakes and ponds without heavy wind (JONSWAP and TMA – Texel-Marsen-Arsloe methods).

Bake

The data for the ocean modifier can be baked to files in a given directory. When a simulation is baked, the simulator engine is completely bypassed, and the modifier/texture retrieves all information from the baked files. Baked files are faster, allows rendering in external renderers, and enables more advanced foam maps.

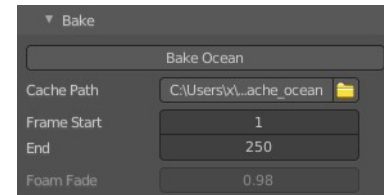

The created images are stored in exr format. And can be opened and modified in any graphics software that is able to handle the format.

Bake Ocean

Bake an image sequence of ocean data.

Cache Path

Folder to store the baked EXR files in. The sequences will be in the form disp_####.exr, normal_####.exr, and foam_####.exr, where #### is the four digit frame number. If the cache path folder does not exist, it will be created.

Frame Start, End

Frames of the simulation to bake (inclusive). The start and end frames of the bake are repeated when accessing frames outside of the baked range.

Foam Fade

How much the foam accumulates over time. This feature is for baked ocean only.

Particle Instance

Adds a copy of the mesh to the particle positions of a particle system. This happens relative to the object origin.

To use this modifier you must have at least one other object that has a Particles System attached.

Because of how the Particle Instance modifier influences the underlying particle systems on other objects, some of the effects generated by the modifier can look and act different. This depends on the underlying settings of the particle systems it is associated with.

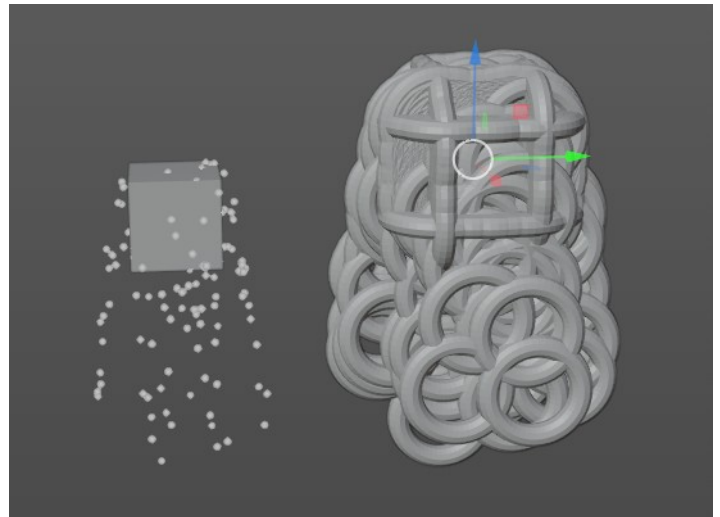
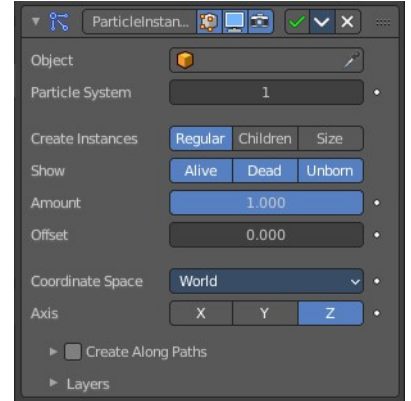

Object

Add the target object with the particle system.

Particle System

The particle system from the target Object to use.

Create Instances

Instance settings.

Regular

The modifier will use the regular (parents) particles to duplicate the mesh of the modified object.

Children

The modifier will use the children particles to duplicate the mesh of the modified object.

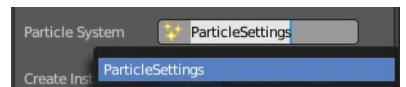

Size

Scale the instanced copies of the mesh by the particle size attribute. When disabled, all the copies appear the same size as the origin.

Show

Particle display settings.

Unborn

Use the unborn particles to duplicate the mesh to.

Alive

Use the alive particles to duplicate the mesh to.

Dead

Use the dead particles to duplicate the mesh to.

Amount

Allows you to randomly skip particles to adjust the amount of instances.

Warning! The random algorithm used currently only ensures that relative amount to be respected statistically. The actual amount of instances generated will differ from the theoretical one, depending on the Seed value of the target particle system (and the Offset value described below, too).

That deviation is not significant with high number of particles, but it will be highly noticeable with low numbers (e.g. with 100 particles in the target system, and an Amount value of 0.1, it can generate either up to 15 or 5 instances, instead of the 10 expected).

Offset

A relative offset in the range of particles used for instantiation. Allows you to avoid overlapping of the used particles, when the same particle system is used in multiple modifier instances.

Tip! If you want to fully avoid overlaps, your Offset value must be at least as high as your Amount value.

Coordinate Space

What coordinate system to use for the target object. World space or Local space.

With World space the locations of the copies of the modified mesh will depend on the location of the modified object and of the target object.

With Local space the locations of the copies of the modified mesh will depend only on the location of the modified object.

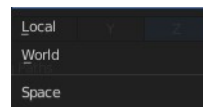

Axis

Which axis of the modified object to use as pole axis to apply the rotation from the instantiated particles. Only one axis can be chosen.

Create Along Paths

By default, the instances are placed depending on the particles position in the current frame. By enabling Create Along Paths, the instance of the modified object follows deforms its shape along the particle path (or the hair strand). This allows you to select the position along the particles path regardless of the current frame.



Tip! You can adjust the path of particles on the Render panel of the Particle System tab by adjusting the Path visualization type

Note! When the type is not Hair or Keyed Physics, the particle system must be baked.

Note! When you use Strands you must also have Dead activated in the Show settings. Since they die immediately.

Position

What percentage of the path that the instance fills. Or the position on the path if the Keep Shape option is enabled.

Random

Adds randomness to the Position value of each instance.

Rotation

Specifies the rotation around the path.

Random

Adds randomness to the Rotation value of each instance.

Keep Shape

Enabling this prevents the instance from being deformed, and places it on the path according to the Position value.

Layers

Select vertex color layers. These layers will be filled with colors based on the particles information. And can be used in a shader to add variance to a material.

You can create vertex color layers in the Object Data properties in the Vertex Colors panel.

Index

A vertex color layer for values based on the particles index.

Value

A vertex color layer for random per-particle values.

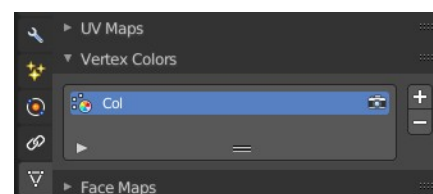
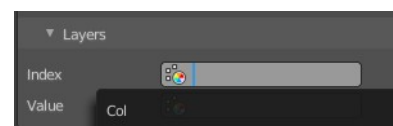

Particle System

The Particle System modifier gets added into the modifier stack when you add a particle system in the Particles tab. It enables particle simulation at the object.

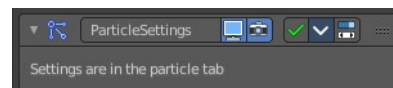

All the particle settings and adjustments happens in the Particles tab. The Particle System modifier has no further settings.

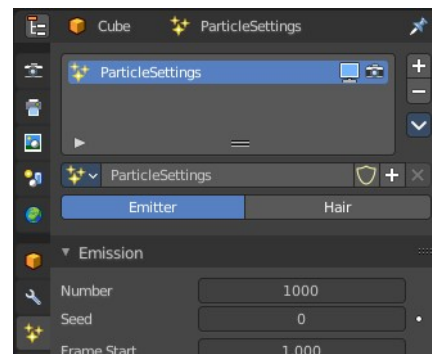

Soft body

The Soft body modifier gets added into the modifier stack when you add a Soft Body physics in the Physics tab. It enables Soft Body simulation for the mesh.

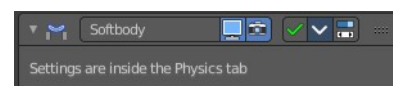

All the Soft body settings and adjustments happens in the Physics tab. The Soft body modifier has no further settings.

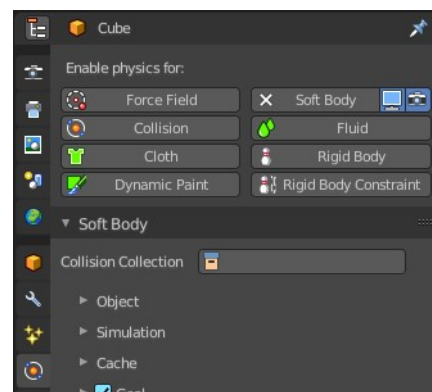



26.9.5 Editors - Properties Editor - Modifiers Properties Tab - Curve&Text - Modify modifiers

Table of content

Detailed table of content.....	1
Curve&Text - Modify modifiers.....	2
Mesh Cache.....	2
Mesh Sequence Cache.....	3

Detailed table of content

Detailed table of content

Detailed table of content.....	1
Curve&Text - Modify modifiers.....	2
Mesh Cache.....	2
Format.....	2
File Path.....	2
Influence.....	2
Deform Mode.....	2
Interpolation.....	2
Time Remapping.....	3
Frame / Time / Factor.....	3
Play Mode.....	3
Frame Start.....	3
Frame Scale.....	3
Axis Mapping.....	3
Forward/Up Axis.....	3
Flip Axis.....	3
Mesh Sequence Cache.....	3
Data property.....	3
Data browser.....	3
Name.....	4
Fake User.....	4
Open Cache File.....	4
Remove.....	4
File Path.....	4
Load File.....	4
Refresh Active.....	4
Sequence.....	4
Use Render Engine Procedural.....	4
Use Prefetch.....	4
Prefetch Cache Size.....	4
Override Frame.....	4
Frame.....	4
Frame Offset.....	5
Velocity Attribute.....	5
Velocity Unit.....	5
Frame.....	5

Second.....5
 Object Path.....5
 Velocity Scale.....5

Curve&Text - Modify modifiers

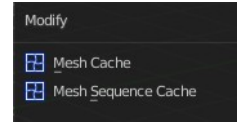

Mesh Cache

The Mesh Cache modifier allows you to apply animated mesh data to a mesh. And deform it when playing back.

This works in a similar way to shape keys. But uses external files, and allows to interchange between applications.

Tip! Both MDD and PC2 depend on the vertex order on the mesh remaining unchanged. This is a limitation of this method, so take care not to add/remove/reorder vertices once this modifier is used.

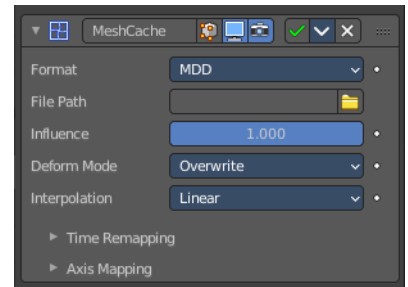

Format

The input file format (currently .mdd and .pc2 are supported).

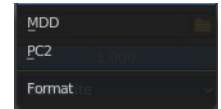

File Path

Path to the cache file.

Influence

Factor to adjust the influence of the modifier's deformation.

Deform Mode

This setting defaults to Overwrite which will replace the vertex locations with those in the cache file.

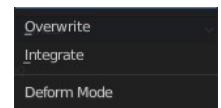

When you want to mix a mesh cache file with shape keys, then you can select the Deform option which integrates deformations with the mesh cache result.

Note that this feature is limited to making smaller, isolated edits and will not work for larger changes such as re-posing limbs.

Interpolation

The blend mode between frames. Use linear when the frames in the cache file do not match up exactly with the frames in the blend-file.

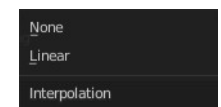

Time Remapping

Frame / Time / Factor

How time is calculated.

Play Mode

How playback operates.

Frame Start

Play the cache starting from this frame.

Frame Scale

Scale time by this factor (applied after the start value).

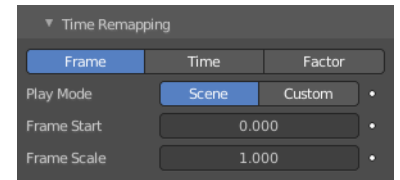

Axis Mapping

Forward/Up Axis

The axis for forward and up used in the source file.

Flip Axis

Allows you to flip the coordinates on an axis.



Mesh Sequence Cache

The Mesh Sequence Cache modifier loads data from Alembic files. It supports static meshes, but is mostly used to load animated meshes. Despite its name, this modifier also supports curves. It also handles file sequences, as well as meshes and curves with varying topology (like the result of fluid simulations).

The mesh version of this modifier looks a bit different.

When importing an Alembic file, Mesh Sequence Cache modifiers are automatically added to time-varying meshes. For time-varying object transforms (so animation of rotation, location, or scale), the Transform Cache Constraint is used.

The

Data property

Data browser

List of available Alembic files.

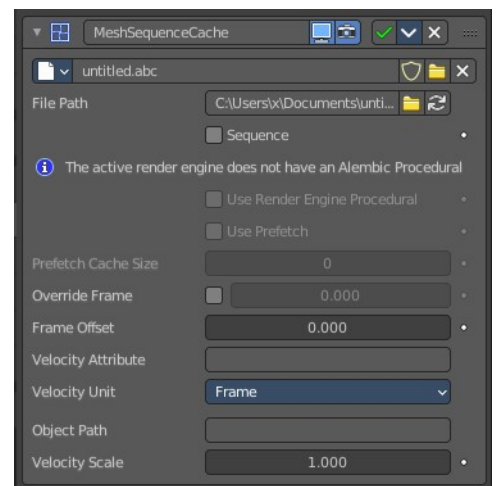
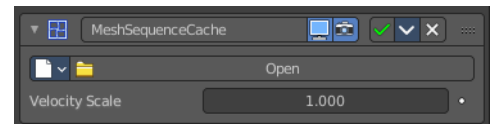

Name

The name of the current active alembic file.

Fake User

Keep this file in the scene even when it has no user anymore.

Open Cache File

Open an alembic file.

Remove

Remove the alembic file.

File Path

Path to the Alembic file.

Load File

Open an alembic file.

Refresh Active

Update the files and paths.

Sequence

Whether or not the cache is separated in a series of files.

Use Render Engine Procedural

This feature is just available for Cycles, and just in an experimental state.

Display boxes as placeholders in the viewport.

Use Prefetch

This feature is just available for Cycles, and just in an experimental state.

When enabled, the Cycles procedural will preload animation data for faster update.

Prefetch Cache Size

This feature is just available for Cycles, and just in an experimental state.

Memory usage limit for the cache. If the data size does not fit the renderer is aborted. 0 disables the feature.

Override Frame

Whether to use a custom frame for looking up data in the cache file, instead of using the current scene frame.

Frame

The time to use for looking up the data in the cache file, or to determine which to use in a file sequence.

Frame Offset

Define a frame offset to the current frame.

Velocity Attribute

Name of the Alembic Attribute used for generating motion blur data.

Velocity Unit

Define how velocity vectors are interpreted regarding time.

Frame

The delta time is 1 frame.

Second

The delta time is 1/FPS.

Object Path

The path to the Alembic object inside the archive.

Velocity Scale

Multiplier used to control the magnitude of the velocity for time effects.



26.9.6 Editors - Properties Editor - Modifiers Properties Tab - Curve&Text - Generate Modifiers

Table of content

Detailed table of content.....	1
Curve&Text - Generate modifiers.....	6
Array.....	6
Bevel.....	8
Build.....	14
Decimate.....	15
Edge Split.....	16
Geometry Nodes.....	17
Mirror.....	18
Remesh.....	19
Screw.....	21
Solidify.....	22
Subdivision Surface.....	26
Triangulate.....	27
Weld.....	28

Detailed table of content

Detailed table of content

Detailed table of content.....	1
Curve&Text - Generate modifiers.....	6
Array.....	6
Fit Type.....	6
Fixed Count.....	7
Fit Length.....	7
Fit Curve.....	7
Relative Offset.....	7
Factor X/Y/Z.....	7
Constant Offset.....	7
Distance X/Y/Z.....	7
Object Offset.....	7
Object.....	7
Merge.....	7
Distance.....	8
First and Last Copies.....	8
UV's.....	8
Offset U/V.....	8
Caps.....	8
Cap Start / End.....	8
Bevel.....	8
Affect.....	8
Vertices.....	8
Edges.....	8

Width Type.....	8
Offset.....	9
Width.....	9
Depth.....	9
Percent.....	9
Absolute.....	9
Amount.....	9
Segments.....	9
Limit Method.....	9
None.....	9
Angle.....	9
Angle.....	9
Weight.....	9
Vertex Group.....	10
Vertex Group.....	10
Invert.....	10
Profile.....	10
Super Ellipse.....	10
Shape.....	10
Custom.....	10
Miter Shape.....	10
Custom Profile.....	11
Preset.....	11
Zoom in.....	11
Zoom out.....	11
Tools.....	11
Reset View.....	11
Reset Curve.....	11
Reverse Path.....	11
Toggle Profile Clipping.....	11
Curve view.....	11
Handle Type Auto Handle.....	11
Handle Type Vector Handle.....	11
Handle Type Free Handle.....	11
Handle Type Aligned Free Handle.....	11
X Y Values.....	12
Delete.....	12
Sample Straight Edges.....	12
Sample Even Lengths.....	12
Geometry.....	12
Miter Inner.....	12
Sharp.....	12
Arc.....	12
Outer.....	12
Sharp.....	12
Patch.....	12
Arc.....	13
Intersections.....	13
Clamp Overlap.....	13
Loop Slide.....	13
Shading.....	13
Harden Normals.....	13
Mark.....	13

Seam.....	13
Sharp.....	13
Material Index.....	14
Face Strength.....	14
None.....	14
New.....	14
Affected.....	14
All.....	14
Build.....	14
Start.....	14
Length.....	14
Reversed.....	14
Randomize.....	15
Seed.....	15
Decimate.....	15
Mode.....	15
Collapse.....	15
Ratio.....	15
Symmetry.....	15
Triangulate.....	15
Vertex Group.....	15
Invert.....	15
Un-Subdivide.....	15
Iterations.....	16
Planar.....	16
Angle Limit.....	16
Delimit.....	16
Normal.....	16
Material.....	16
Seam.....	16
All Boundaries.....	16
Face Count.....	16
Edge Split.....	16
Edge Angle.....	17
Sharp Edges.....	17
Geometry Nodes.....	17
Data Browser.....	17
Edit box.....	17
Add Fake User.....	17
User.....	17
Add.....	17
Remove.....	18
Mirror.....	18
Workflow.....	18
Axis.....	18
Bisect.....	18
Flip.....	18
Mirror Object.....	18
Clipping.....	18
Merge.....	19
Bisect Distance.....	19
Merge Distance.....	19
Data.....	19

Mirror U, V.....	19
Offset U, V.....	19
Vertex Groups.....	19
Flip UDIM.....	19
Remesh.....	19
Blocks, Smooth, Sharp.....	20
Octree Depth.....	20
Scale.....	20
Sharpness.....	20
Remove Disconnected.....	20
Threshold.....	20
Smooth Shading.....	20
Voxel.....	20
Voxel Size.....	20
Adaptivity.....	20
Smooth Shading.....	20
Screw.....	21
Angle.....	21
Screw.....	21
Iterations.....	21
Axis.....	21
Screw.....	21
Axis Object.....	21
Object Screw.....	21
Steps Viewport.....	21
Render.....	21
Merge.....	21
Merge Distance.....	21
Stretch UV's.....	21
Normals.....	22
Smooth Shading.....	22
Calculate Order.....	22
Flip.....	22
Solidify.....	22
Mode.....	22
Simple.....	22
Thickness.....	22
Offset.....	22
Even Thickness.....	22
Rim.....	23
Fill.....	23
Only Rim.....	23
Complex.....	23
Thickness Mode.....	23
Fixed.....	23
Even.....	23
Constraints.....	23
Boundary.....	23
None.....	23
Round.....	24
Flat.....	24
Thickness.....	24
Offset.....	24

Merge Threshold.....	24
Rim.....	24
Fill.....	24
Only Rim.....	24
Vertex Group.....	24
Invert.....	24
Factor.....	24
Flat Faces.....	25
Normals.....	25
Flip Normals.....	25
High Quality Normals.....	25
Materials.....	25
Material Offset.....	25
Rim.....	25
Edge Data.....	25
Inner.....	25
Outer.....	25
Rim.....	25
Bevel Convex.....	25
Thickness Clamp.....	25
Clamp.....	25
Angle Clamp.....	26
Output Vertex Groups.....	26
Shell.....	26
Rim.....	26
Subdivision Surface.....	26
Type.....	26
Catmull-Clark.....	26
Simple.....	26
Levels Viewport.....	26
Render.....	27
Optimal Display.....	27
Advanced.....	27
Quality.....	27
UV Smooth.....	27
Smooth, keep corners.....	27
Sharp.....	27
Use Creases.....	27
Triangulate.....	27
Quad Method.....	27
Beauty.....	27
Fixed.....	27
Fixed Alternate.....	28
Shortest Diagonal.....	28
Polygon Method.....	28
Beauty.....	28
Clip.....	28
Minimum Vertices.....	28
Keep Normals.....	28
Weld.....	28
Mode.....	28
All.....	28
Connected.....	28

Distance.....	28
Only Loose Edges.....	28
Vertex Group.....	28
Invert.....	29

Curve&Text - Generate modifiers

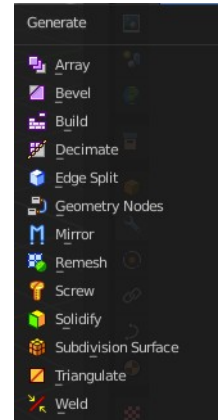

Array

The Array modifier creates an array of copies of the base object. Each copy can offset from the previous one in any of a number of possible ways. Vertices in adjacent copies can be merged if they are nearby, allowing smooth Subdivision Surface frameworks to be generated.

This modifier can be useful when combined with tillable meshes for quickly developing large scenes. It is also useful for creating complex repetitive shapes.

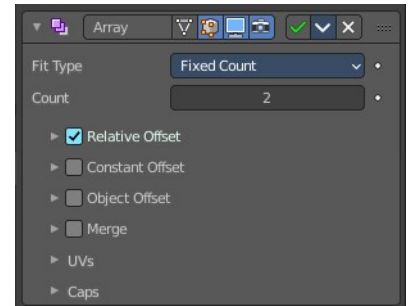

Multiple Array modifiers may be active for an object at the same time. This allows to create complex three-dimensional constructs.

Hint for Offset Calculation. The transformation applied from one copy to the next is calculated as the sum of the three different components (Relative, Constant and Object), each of which can be enabled/disabled independently of the others. This allows, for example, a relative offset of (1.0, 0.0, 0.0) and a constant offset of (0.1, 0.0, 0.0), giving an array of objects neatly spaced along the X axis with a constant 0.1 unit between them, whatever the original object's size.

Fit Type

Controls how the length of the array is determined.

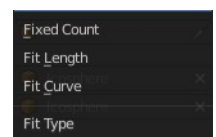

Fixed Count

Generates the number of copies specified in Count.



Fit Length

Generates copies to fit within the fixed length given by Length.

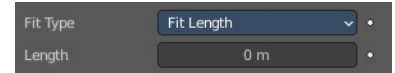

Fit Curve

Generates copies to fit within the length of the curve object specified in Curve. You need to select a curve object.



Note! Both Fit Curve and Fit Length use the local coordinate system size of the base object, which means that scaling the base object in Object Mode will not change the number of copies generated by the modifier.

Fit Length uses the local coordinate system length of the curve, which means that scaling the curve in Object Mode will not change the number of copies generated by the modifier.

Applying the scale can be useful for both.

Relative Offset

Factor X/Y/Z

Adds a translation equal to the object's bounding box size along each axis to the offset, multiplied by a scaling factor. X, Y and Z scaling factors can be specified.



Constant Offset

Distance X/Y/Z

Adds a constant translation component to the duplicate object's offset. X, Y and Z constant components can be specified.

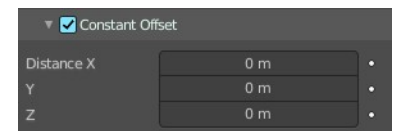

Object Offset

Adds a transformation taken from a chosen object relative to the current object to the offset.



Object

Choose an object.

Merge

If enabled, vertices in each copy will be merged with vertices in the next copy that are within the given Distance.

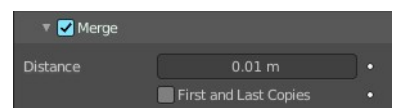

Distance

The merge distance between the vertices. Vertices below this distance will be merged.

First and Last Copies

Merge vertices in first and last duplicates.

UV's

Offset UV

Shifts UV's of each new duplicate by a settable amount.

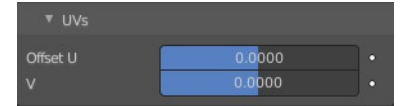

Caps

Cap Start / End

Adds a chosen mesh at the start and end of the array. The start object is added at position -1. The end object at position +1. When Merge is activated, and the cap vertices are within the Distance threshold, they will be merged.



Note! The start/end cap objects currently do not support the First and Last Copies option.

Bevel

The Bevel modifier bevels the edges of the mesh. It is a non-destructive alternative to the Bevel Operation in Edit Mode.

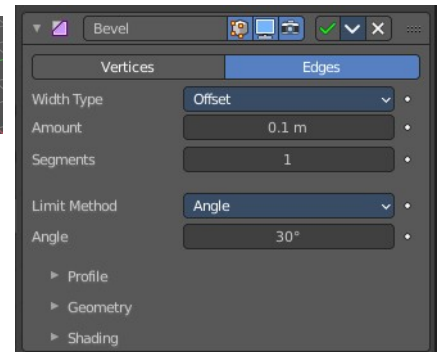
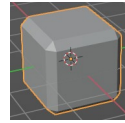

Affect

Vertices

Only the areas near vertices are beveled, the edges remain unchanged.

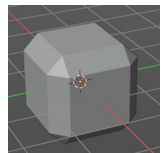

Edges

Bevels both edges and vertices.

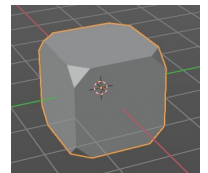

Width Type

Defines how Width will be interpreted to determine the amount of bevel.

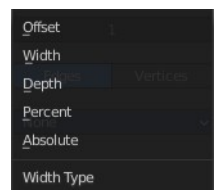

Offset

Value is interpreted as the distance from the original edge to the edge of the beveled face.

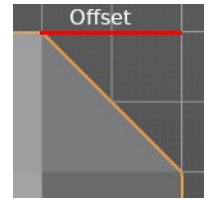

Width

Value is interpreted as the distance between the two new edges formed by the bevel.



Depth

Value is the perpendicular distance from the new bevel face to original edge.

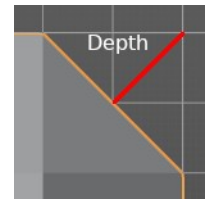

Percent

Similar to Offset but the value is interpreted as a percentage of the adjacent edge length.

Absolute

Amount is absolute along adjacent edge.

Amount

The bevel amount.

Segments

The number of edge loops added along the bevel's face.

Limit Method

Used to control where a bevel is applied to the mesh.

None

No limit, all edges will be beveled.

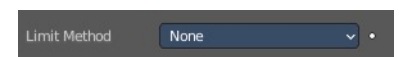

Angle

Only edges where the adjacent faces form an angle smaller than the defined threshold will be beveled. Intended to allow you to bevel only the sharp edges of an object without affecting its smooth surfaces.

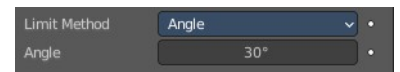

Angle

The angle above which to bevel.

Weight

Use each edge's bevel weight to determine the width of the bevel. When the bevel weight is 0.0, no bevel is applied.

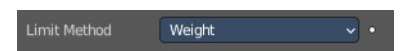

Edge bevel weight can be set in Edit mode in the Edge menu with the Edge Bevel Weight tool.

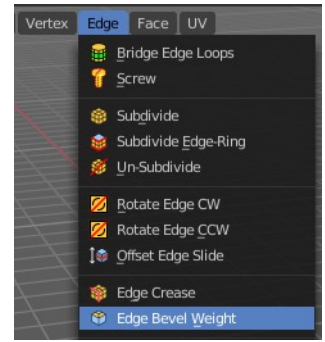

Vertex Group

Use weights from a vertex group to determine the width of the bevel. When the vertex weight is 0.0, no bevel is applied. An edge is only beveled if both of its vertices are in the vertex group. See here about adjusting vertex group weights.

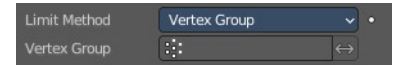

Vertex Group

Choose the vertex group.

Invert

Inverts the influence of the selected vertex group.

Profile

The profile defines the shape of the bevel. Profile has no effect if the number of segments is below 2.

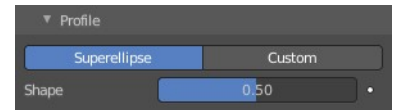

Super Ellipse

Defines a rounded bevel corner.

Shape

The shape of the rounded bevel corner. A value close to 0 bends the roundness to inside. A value towards 1 bends the curve to outside. A value of 0.5 defines a radius around the center point of the bevel.

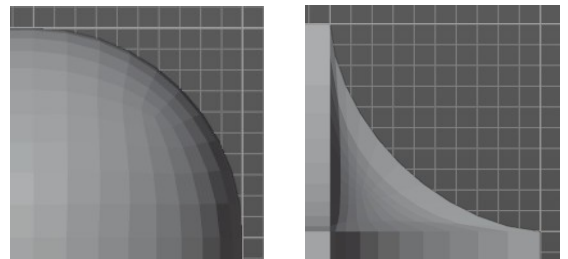

Custom

Here you can define a custom shape profile for the bevel.

Miter Shape

The shape of the custom bevel corner. Has no effect when the miter type is sharp. You need to set it to Arc in the geometry section.

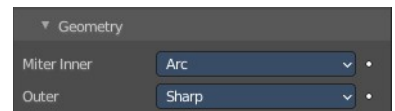

Custom Profile

Choose and adjust a custom bevel profile. This feature needs more than one segment to work.

Preset

Choose some profile presets.

Zoom in

Zooms into the curve view.

Zoom out

Zooms out of the curve view.

Tools

Reset View

Resets the zoom factor of the curve view.

Reset Curve

Resets the curve to the defaults. This means when you choose a curve preset to reset it to the values of the latest chosen preset.

Reverse Path

The path gets reversed. The first point becomes the last and vice versa.

Toggle Profile Clipping

Toggles the profile clipping.

Curve view

Adjust the profile curve.

Left click where no point is adds a new point. Left click at a point allows you to move it.

Holding down Shift while moving a node point activates precision movement.

Holding down ctrl while moving activates temporary snapping.

When a point is selected then the curve view reveals a sub menu at the bottom.

Handle Type *Auto Handle*

Sets the handle type of this curve point to smooth.

Handle Type *Vector Handle*

Sets the handle type of this curve point to sharp.

Handle Type *Free Handle*

Sets the handle type of this curve to Free handles. The curve point has now two handles with which you can adjust the curve before and after the point each.

Handle Type *Aligned Free Handle*

Sets the handle type of this curve to Free handles. The curve point has now a handle with which you can adjust

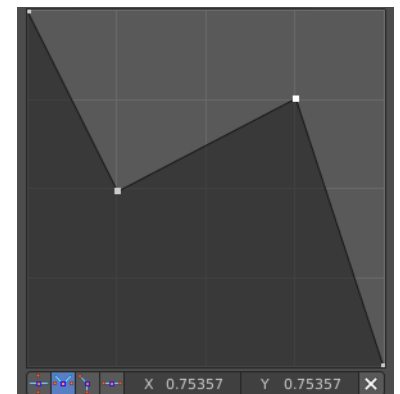
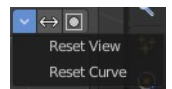
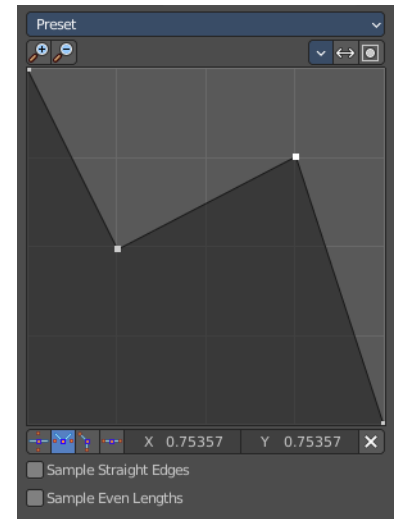

the curve.

XY Values

The position of the currently selected curve point.

Delete

Delete the selected curve point.

Sample Straight Edges

Sample edges with vector handles.

Sample Even Lengths

Sample edges with even lengths.

Geometry

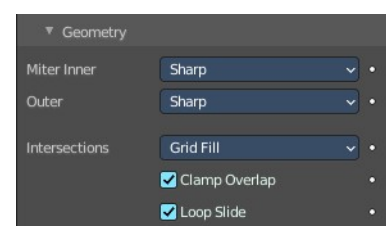

Miter Inner

How the inner miter is set. Miter is how the bevel rounding at a corner is done.

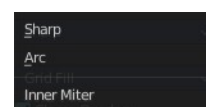

Sharp

Creates a sharp miter.

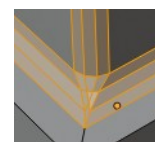

Arc

This replaces the vertex of a miter with 2 vertices, joined by an arc. A separate Spread parameter says how far to move the vertices away from their original position.

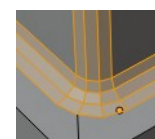

Outer

How the outer miter is set. Miter is how the bevel rounding at a corner is done.



Sharp

Creates a sharp miter.

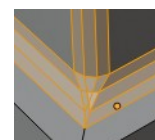

Patch

This replaces the outside vertex of a miter with 3 vertices. And uses a patch pattern there.

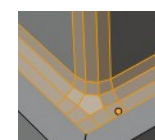

Arc

This replaces the vertex of a miter with 2 vertices, joined by an arc. A separate Spread parameter says how far to move the vertices away from their original position.

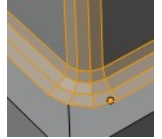

Intersections

If a bevel corner is filled or not. Needs minimum two segments to have effect.

When the inner corners of the cutoff profiles faces meet at the same location with a three way intersection, then no center face is created.

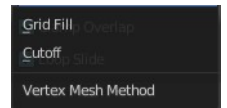

The direction of the cutoff faces depends on the original vertex's normal.



Clamp Overlap

Limits the width of each beveled edge so that edges cannot cause overlapping intersections with other geometry.

Loop Slide

If there are unbeveled edges along with beveled edges into a vertex, the bevel tries to slide along those edges when possible. Turning the option off can lead to more even bevel widths.

Shading

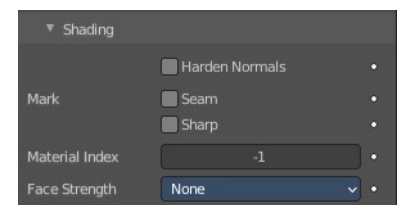

Harden Normals

Match normals of new faces to adjacent faces.

Autosmooth needs to be enabled for this feature. And the shading needs to be smooth.

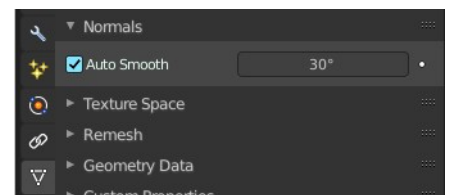

Mark

Seam

When the beveled edge is a seam edge, then the bevel will also contain a seam to keep the seam into account.

Sharp

When the beveled edge is a sharp edge, then the bevel will also contain a sharp edge to keep the sharp edge into account.

Material Index

The index of the material slot to use for the bevel. When set to -1, the material of the nearest original face will be used.

Face Strength

Set the Face Strength on the faces involved in the bevel by the mode specified here.

This face strength then can be used in conjunction with a following Weighted Normals modifier (with the Face Influence option checked).

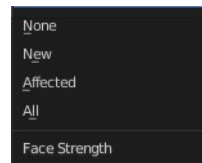

None

Do not set face strength.

New

Set the face strength of new faces along edges to Medium, and the face strength of new faces at vertices to Weak.

Affected

In addition to those set for the New case, also set the faces adjacent to new faces to have strength Strong.

All

In addition to those set for the Affected case, also set all the rest of the faces of the model to have strength Strong.

Build

The Build modifier lets the faces of the mesh object to appear or disappear one after the other over time when you play the animation.

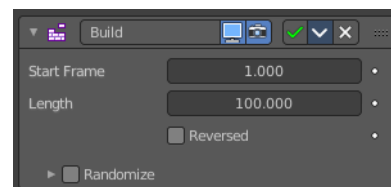

By default, faces appear in the order in which they are stored in memory, which follows the order how they are created. This face/vertex order can be altered in Edit Mode by using Sort Mesh Elements in the Mesh menu.

Start

The start frame of the building process.

Length

The number of frames over which to rebuild the object.

Reversed

The modifier will operate in reverse, and start with the full mesh. And deconstruct it towards the end frame.

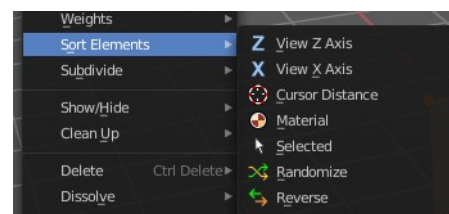

Randomize

Randomizes the order in which the faces are built.

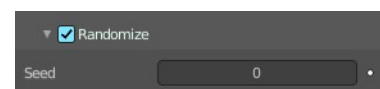

Seed

The random seed. Changing this value gives a different “random” order when Randomize is checked. This order is always the same for a given seed/mesh set.

Decimate

The Decimate modifier allows you to reduce the vertex/face count of a mesh with minimal shape changes. The result is just displayed in Object mode. In Edit mode the unaltered mesh is shown.

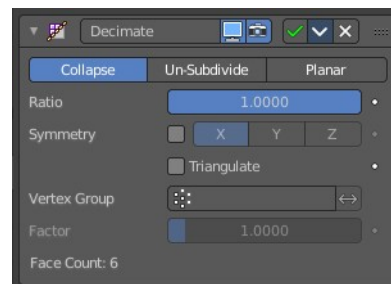

Mode

Collapse

This algorithm uses progressive merging of vertices, taking the shape of the mesh into account.

Ratio

The ratio of faces to keep after decimation. 1.0 is not altered. The lower the value the stronger the reduction.

Note! Although the Ratio is directly proportional to the number of remaining faces, triangles are used when calculating the ratio.

This means that if your mesh contains quads or other polygons, the number of remaining faces will be larger than expected, because those will remain unchanged if their edges are not collapsed.

This is only true if the Triangulate option is disabled.

Symmetry

Maintains symmetry on a single axis.

Triangulate

Keeps any resulting triangulated geometry from the decimation process.

Vertex Group

A vertex group that controls what parts of the mesh are decimated.

Invert

Decimate the geometry except the vertex group.

Un-Subdivide

This algorithm tries to unsubdivide divided faces.

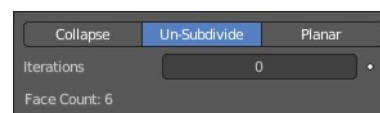

Iterations

The number of times to perform the un-subdivide operation. Two iterations is the same as one subdivide operation, so you will usually want to use even numbers.

Planar

This algorithm reduces details by unioning adjacent faces that are below an angle limit.

Angle Limit

Dissolve geometry which form angles (between surfaces) higher than this setting.

Delimit

Prevent dissolving geometry in certain places.

Normal

Does not dissolve edges on the borders of areas where the face normals are reversed.

Material

Does not dissolve edges on the borders of where different materials are assigned.

Seam

Does not dissolve edges marked as seams.

All Boundaries

When enabled, all vertices along the boundaries of faces are dissolved.

Face Count

The face count of the decimated mesh.

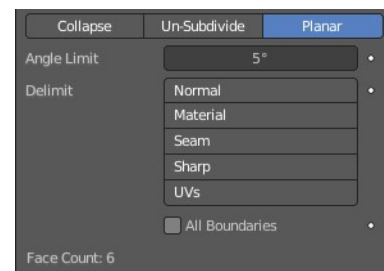

Edge Split

The Edge Split modifier splits single edges into two independent edges when the adjacent faces are below the defined angle. Or when the edge is marked as sharp. Which can be done in edit mode in the Edge menu with the Mark Sharp tool.

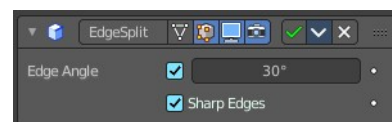

Splitting an edge affects vertex normal generation at that edge, and makes the edge appear sharp. So this modifier can be used to achieve the same effect as Auto Smooth. And make edges appear sharp when their angle is above a certain threshold. It can also be used for manual control of the smoothing process, where the user defines which edges should appear smooth or sharp (see Mesh Smoothing for other ways to do this). If desired, both modes can be active at once.

Note! This modifier is kept mostly for historical/compatibility reasons. Everything it can do in shading, and much more, can now be achieved using custom normals. Unless you really need the topology changes it generates, it is not advised to use it in new projects.

Edge Angle

The angle above which to split edges.

Sharp Edges

When you have marked edges as sharp, then these edges will be split.

Note! Non-manifold edges will always be split.

Geometry Nodes

The geometry Nodes modifier adds a geometry node tree, which can be modified in the geometry node editor.

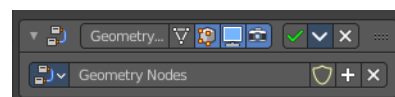

Manage the nodes. If there is no geometry node tree for the current object, then you will see the New button

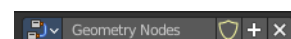

Data Browser

The list of available geometry node trees in the scene.

Edit box

The name of the current active geometry node tree. Here you can also rename the node tree.

Add Fake User

With this button you assign a fake user to this selected geometry node tree.

Data, like node trees, that is not longer linked to anything else gets removed when you save and reload a scene. Bforartists has the concept of fake users to go around this behavior. An image with a fake user is in fact linked to something. And so it is not lost when you save and reload the scene.

User

The number of users that uses this data. Data with a user number of 0 will be removed with closing Bforartists.

Add

Add a geometry node.

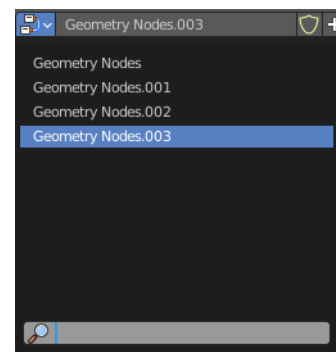

Remove

Removes the geometry node tree. To delete it completely you need to purge it. See Fake user.

Mirror

The Mirror modifier mirrors a mesh along its local X, Y and/or Z axes, across the Object Origin. It can also use another object as the mirror center, then use that object's local axes instead of its own.

Workflow

Usually this modifier is used for mirror modeling in edit mode. In Edit mode just the original side is editable then. Recommend is to remove half of the mesh before starting. The missing part will then be added by the Mirror modifier. But you can also use the Bisect feature.

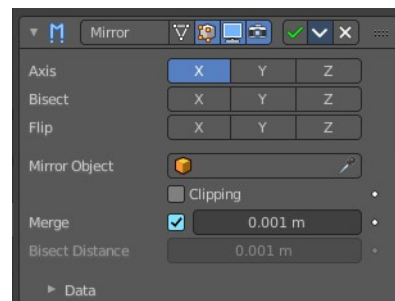

Axis

The axis to mirror along.

You can select more than one of these axes. And will then get more mirrored copies. With one axis you get a single mirror, with two axes four mirrors, and with all three axes eight mirrors.

Bisect

If the mesh is already on both sides of the mirror plane, it is cut by that plane. And only one side (the “negative” one by default) is kept to perform the mirror process.

Note. When you turn Bisect on and pull at the mirror part, then you won't have the mirroring effect to the original side.

Flip

When Bisect is enabled on an axis, you can use this setting to switch the side kept and mirrored (i.e. when it is enabled, the “positive” side will be kept, instead of the “negative” one).

Mirror Object

An Object Selector to select an object (usually an empty), which position and rotation will be used to define mirror planes (instead of using the ones from the modified object).

You can animate it to move the mirror axis.

Clipping

Prevents vertices from moving through the mirror plane(s) when you transform them in Edit Mode.

If it is enabled but vertices are beyond the mirror plane and outside of the Merge Distance, the vertices will not be merged. But as soon as the vertices are within Merge Distance they are snapped together and cannot be moved beyond the mirror plane.

Note! Vertices on the mirror plane will be unable to move away from the mirror plane as long as Clipping is enabled. You must disable it to be able to move the vertices along the mirror axis again.

Merge

Where a vertex is in the same place (within the Merge Distance) as its mirror it will be merged with the mirrored vertex.

Bisect Distance

Vertices are removed up to this distance from the bisect plane.

Merge Distance

The maximum distance between a vertex and its mirror copy at which they are merged together (being snapped on the mirror plane). Needs Merge to be enabled.

Data

Mirror U, V

Mirror the UV texture coordinates across the middle of the image.

Offset U, V

Offset the UV texture coordinates across the middle of the image.

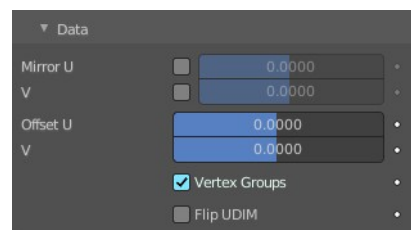

Vertex Groups

Try to mirror existing vertex groups.

Note! The vertex groups you want to mirror must be named following the usual left/right pattern (i.e. with suffixes like “.R”, “.right”, “.L”, etc.). The mirror side vertex group must already exist (it will not be created automatically). It must also be completely empty (no vertices assigned to it).

Flip UDIM

Mirror the texture coordinates around each tile center.

Remesh

The Remesh modifier generates new mesh topology. The output follows the surface curvature of the input. But its topology contains quads.

The output and also the settings of the three basic modes Blocks, Smooth and Sharp is almost identical. Except the smoothing.

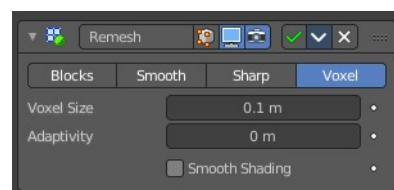

Blocks, Smooth, Sharp

Blocks has no smoothing at all. Smooth outputs a smooth surface. Sharp outputs a smooth surface but preserves sharp edges and corners.

Octree Depth

The resolution of the Octree. Higher values gives finer details.

Scale

The ratio of the largest dimension of the model over the size of the grid.

Sharpness

Sharp mode only. Tolerance for outliers. Higher values produce edges more similar to the input, while lower values filter out noise.

Remove Disconnected

Filter out small disconnected pieces of the output.

Threshold

Use this to control how small a disconnected component must be to be removed.

Smooth Shading

Output faces with smooth shading. The smooth/flat shading of the input faces is not preserved.

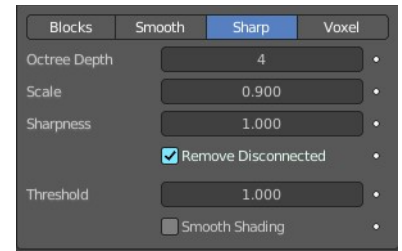

Voxel

Generate a new manifold mesh from the current geometry while trying to preserve the mesh's original volume.

Voxel Size

The voxel size. Defines the resolution of the created mesh.

Adaptivity

Reduces the final face count by simplifying geometry where detail is not needed. This feature triangulates faces that do not need as much detail.

Smooth Shading

Output faces with smooth shading. The smooth/flat shading of the input faces is not preserved.

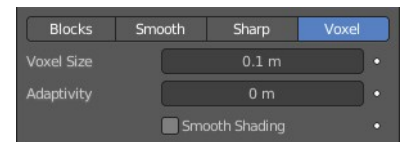

Screw

The Screw modifier takes a profile object, a mesh or a curve, to create a helix-like shape.

The profile should be properly aligned to the cardinal direction of the object.

Angle

Degrees for a single helix iteration.

Screw

Offsets the iteration along its axis.

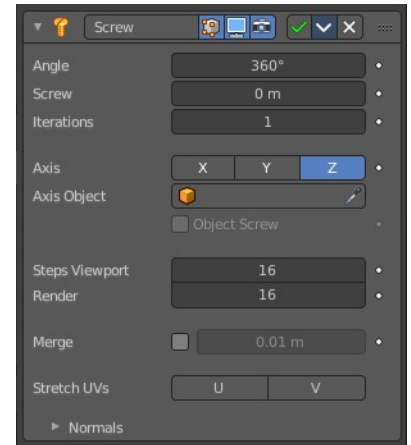

Iterations

Number of iterations.

Axis

The axis along which the helix will be built.

Screw

The height of one helix iteration.

Axis Object

Pick an object to define the axis direction. The helix will then point into the direction of this object.

Object Screw

Use the distance from the Axis Object to define the height of one helix iteration.

Steps Viewport

Number of steps used for a single revolution displayed in the 3D Viewport.

Render

Number of steps used for a single revolution used during render time. Higher values gives higher quality.

Merge

Merge vertices that lie on the axis of rotation. Closes off end points with a triangle fan.

Merge Distance

Vertices under this distance to the axis are merged.

Stretch UV's

Stretch the UV coordinates from (0.0 to 1.0) when UV's are present.

Normals

Smooth Shading

Output faces with smooth shading. The smooth/flat shading of the input geometry is not preserved.



Calculate Order

Order of edges is calculated to avoid problems with normals and shading. Only needed for meshes, not curves.

Flip

Flip normals direction.

Solidify

The Solidify modifier adds depth and thickness to the faces of a geometry.

Example. A cube with one face removed.

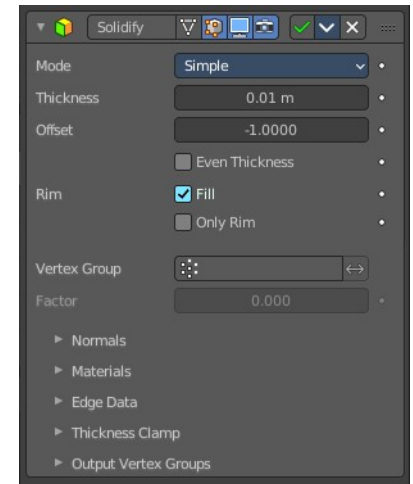
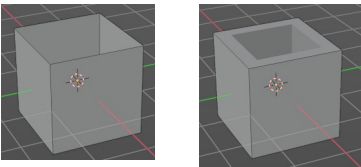

Mode

Simple

This algorithm simply extrudes the geometry. It does not work on geometry where edges have more than two adjacent faces.

Important! Simple mode will not be able to solidify the boundary between two adjacent faces that does not point into the same direction.

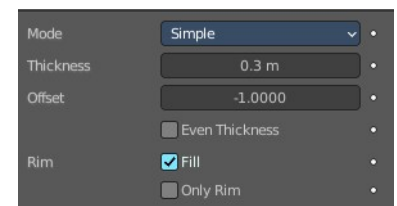
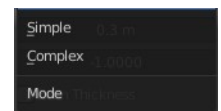

Thickness

The extrude amount.

Offset

A value between (-1 to 1) to locate the solidified output inside or outside the original mesh. The inside and outside is determined by the face normals. Set to 0.0, the solidified output will be centered on the original mesh.

Even Thickness

Maintain the thickness by adjusting for sharp corners.

Note! Solidify thickness is an approximation. The final wall thickness is not guaranteed. The best option to preserve wall thickness is complex mode with constraints thickness mode. But even this is not guaranteed to work perfect in every case.

Rim

Note! Fill and Only Rim only make a difference on Non-manifold objects, since the rims are generated from the borders of the original geometry.

Fill

Fills the gap between the inner and outer edges.

Only Rim

Will not extrude surfaces parallel to the original one, but instead will only add the perpendicular rim.

Complex

This solidify algorithm can handle every geometric situation to guarantee a manifold output geometry. It is able to solidify shapes like Möbius strips, Klein bottles, architectural wall layouts and many more which the Simple Mode isn't able to do.

If the special cases are not present it is recommended to choose Simple because the extra logic makes this algorithm much slower.

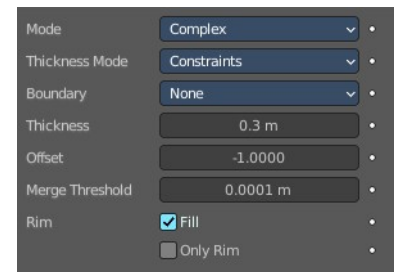

Note! There are no options for crease in the Modifier tab because crease is handled in a dynamic way. The modifier will transfer the creases of the original mesh in a smart way to the output mesh to work with the Subdivision Surface modifier.

Thickness Mode

Choose the kind of thickness handling.

Fixed

The new vertices are always in a fixed distance to the old ones.

Even

Adjusts for sharp corners, but may not always work when more than three faces come together.

Constraints

For up to three faces it is always guaranteed to find an optimal solution.

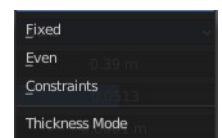

Boundary

Choose the kind of boundary handling.

None

No boundary fix is applied. Results are stable.

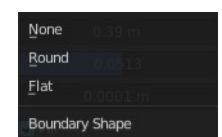

Round

Adjusts the boundary for an opening to face inwards (like a hole in an egg).

Flat

Adjusts the boundary of a planar opening to be a flat (like a cut sphere).

Thickness

The extrude amount.

Important! The modifier thickness is calculated using local vertex coordinates. If the object has a non-uniform scale, the thickness will vary on different sides of the object. To fix this, either Apply or Clear the scale.

Offset

A value between (-1 to 1) to locate the solidified output inside or outside the original mesh. The inside and outside is determined by the face normals. Set to 0.0, the solidified output will be centered on the original mesh.

Merge Threshold

The distance within which degenerated geometry is merged.

Rim

Note! Fill and Only Rim only make a difference on Non-manifold objects, since the rims are generated from the borders of the original geometry.

Fill

Fills the gap between the inner and outer edges.

Only Rim

Will only leave the generated perpendicular rim

Note! Fill and Only Rim only make a difference on Non-manifold objects, since the rims are generated from the borders of the original geometry.

Vertex Group

Only vertices in this group are solidified. Their weights are multiplied by the thickness, so vertices with lower weights will be less thick.

Invert

Reverses the vertex group, so that only vertices which are not in the vertex group are solidified.

Factor

How much the vertex weights are taken into account. You need to have a vertex group assigned to activate this item.

On 0.0, vertices with zero weight will have no thickness at all (creates duplicate vertices).

On 0.5, vertices with zero weight will be half as thick as those with full weight.

On 1.0, the weights are ignored and the Thickness value is used for every vertex.

Flat Faces

Just in Complex Mode. Use the minimal vertex weight assigned to the vertices of a face to make sure that new faces stays parallel to their original ones. This is slow, so disable it when it is not needed.

Normals

Flip Normals

Reverse the normals of all geometry (both the inner and outer surfaces).

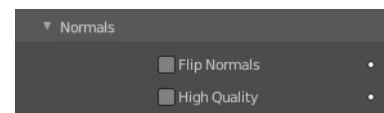

High Quality Normals

Just Simple Mode. Normals are calculated to produce a more even thickness.

Materials

Material Offset

Choose a different material for the new geometry. This is applied as an offset from the original material of the face from which it was solidified.



A value of 0 means it will use the same material.

A value of 1 means it will use the material immediately below the original material.

A value of -2 means the material two positions above the original material will be used.

These values are clamped to the top-most and bottom-most material slots.

Rim

Choose a different material for the rim faces.

Edge Data

Inner, Outer and Rim are simple mode only.

Inner

Set a crease to the inner edges.

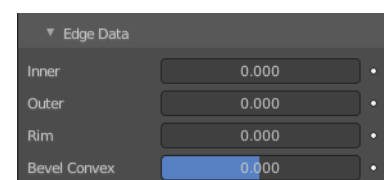

Outer

Set a crease to the outer edges.

Rim

Set a crease to the rim.

Bevel Convex

Edge bevel weight to be added to outside edges.

Thickness Clamp

Clamp

A value between (0 to 2) to clamp offsets to avoid self-intersection. The amount is determined by the length of the shortest adjacent edge.

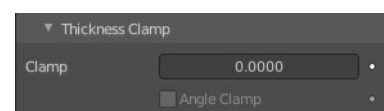

Angle Clamp

If enabled clamping will also consider angles in the geometry, not only lengths. Becomes active when the clamp value is above 0.0.

Output Vertex Groups

Shell

Vertex group that the generated shell geometry will be weighted to. This allows you to use other modifiers to only affect the shell geometry by using a that modifier's vertex group influence control.

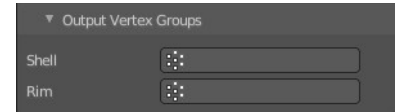

Rim

Same as Shell Vertex Group, but for the generated rim geometry.

Subdivision Surface

The Subdivision Surface modifier subdivides the faces of the mesh. With Simple it just divides the faces. The Catmull-Clark algorithm allows you to smoothen the result.

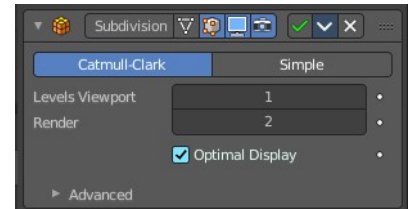

Type

Catmull-Clark

Subdivides and smooths the surfaces.

Note! Catmull-Clark subdivision rounds off edges. And sometimes this is not what you want. There are several solutions that allow you to control the subdivision. You can add a so called support edge or a support loop to keep the edge sharp.

Or you can change the crease of the edges in question. Edge Crease can be adjusted in the Transform panel in the Item tab of the sidebar in the 3D view. You need to be in Edit mode.

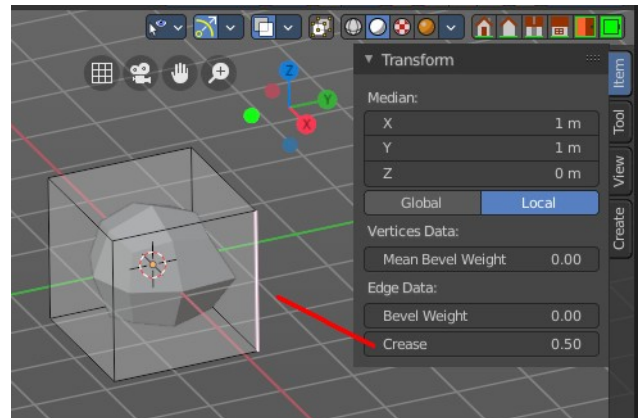

Note! Abrupt normal changes in the surface can produce ugly black gouges, even when these flipped normals are not an issue for the shape itself. A quick way to fix this is to use the Recalculate Normals operation in Edit Mode. If you still have some ugly black gouges you can try to manually flip the normals in question.

Simple

Only subdivides the surfaces, without any smoothing.

Levels Viewport

The number of subdivision levels shown in the 3D Viewport.

Render

The number of subdivision levels shown in the final render.

Optimal Display

When rendering the wire frame of this object, the wires of the new subdivided edges will be skipped. Only the edges of the original geometry will be displayed.

Advanced

Quality

How precisely the vertices are positioned, relatively to their theoretical position of an infinitely subdivided mesh.

Note! This value can have an affect on how accurate Edge Creases can be. Using a higher Quality value will allow for a wider range of crease values to work accurately.

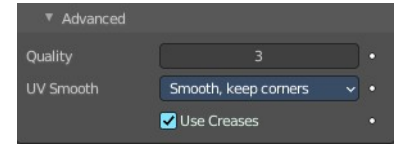

UV Smooth

How to handle UV's during subdivision.

Smooth, keep corners

UV islands are smoothed, but their boundary remain sharp.

Sharp

UV remain unchanged.

Use Creases

Use the Weighted Edge Creases values stored in edges to control the smoothness of the edges.

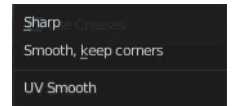

Triangulate

The Triangulate modifier triangulates all faces in a mesh.

Quad Method

How to triangulate quads.

Beauty

Tries to split the quads in a way that takes the topology into account.

Fixed

Split the quads on their 1st and 3rd vertices.

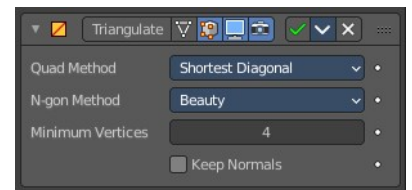

Fixed Alternate

Split the quads on their 2nd and 4th vertices.

Shortest Diagonal

Split the quads based on the diagonal distance between their vertices.

Polygon Method

How to triangulate N-Gons.

Beauty

Tries to split the N-Gons in a way that takes the topology into account.

Clip

Split the N-Gons by using an ear-clipping algorithm

Minimum Vertices

Minimum number of vertices a face must have to be triangulated. For example, setting this value to 5, will prevent triangulation of Quads and only triangulate N-gons.

Keep Normals

When using custom normals, try to preserve the same shading as before triangulation.

Weld

The Weld modifier merges vertices within a threshold.

Mode

All

Full merge by distance.

Connected

Just along the edges.

Distance

The maximum distance to merge vertices.

Only Loose Edges

Just with Connected. Welds only loose edges.

Vertex Group

Only merge vertices from this vertex group.

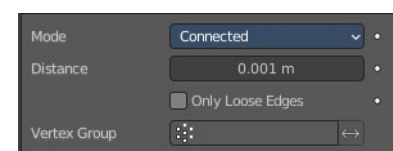
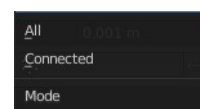
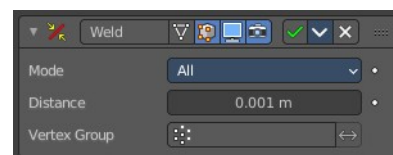

Invert

Inverts the influence of the selected vertex group. Only vertices outside of this vertex group will be merged.



26.9.7 Editors - Properties Editor - Modifiers Properties Tab - Curve&Text - Deform Modifiers

Table of content

Detailed table of content.....	1
Curve&Text - Deform modifiers.....	4
Armature.....	4
Cast.....	6
Curve.....	7
Hook.....	10
Lattice.....	11
Mesh Deform.....	11
Shrinkwrap.....	12
Simple Deform.....	14
Smooth.....	15
Warp.....	16
Wave.....	18

Detailed table of content

Detailed table of content

Detailed table of content.....	1
Curve&Text - Deform modifiers.....	4
Armature.....	4
Object.....	5
Vertex Group.....	5
Invert.....	5
Preserve Volume.....	5
Multi Modifier.....	5
Bind to.....	5
Vertex Groups.....	5
Bone Envelopes.....	5
Cast.....	6
Shape.....	6
Axis.....	6
Factor.....	6
Radius.....	7
Size.....	7
Size from Radius.....	7
Vertex Group.....	7
Invert.....	7
Object.....	7
Curve.....	7
Curve Object.....	7
Deformation Axis.....	8
Vertex Group.....	8
Invert.....	8

Texture Prop.....	8
Texture browser.....	8
Texture Edit Box.....	8
Fake User.....	8
Add Texture.....	8
Remove.....	8
Change Context.....	8
Coordinates.....	8
Direction.....	8
X, Y, Z.....	8
Space.....	9
Normal.....	9
Custom Normal.....	9
RGB to XYZ.....	9
Space.....	9
Strength.....	9
Mid level.....	9
Vertex Group.....	9
Invert.....	9
Hook.....	10
Object.....	10
Vertex Group.....	10
Invert.....	10
Strength.....	10
Reset.....	10
Recenter.....	10
Select.....	10
Assign.....	10
Falloff.....	11
Type.....	11
Radius.....	11
Uniform Falloff.....	11
Lattice.....	11
Object.....	11
Vertex Group.....	11
Invert.....	11
Strength.....	11
Mesh Deform.....	11
Object.....	12
Vertex Group.....	12
Invert.....	12
Precision.....	12
Dynamic.....	12
Bind.....	12
Unbind.....	12
Shrinkwrap.....	12
Wrap Method.....	13
Nearest Surface Point + Target Normal Project.....	13
Snap Mode.....	13
Target.....	13
Project.....	13
Snap Mode.....	13
Limit.....	13

Subdivision Levels.....	13
Axis.....	13
Negative/Positive.....	13
Face Cull.....	14
Target.....	14
Auxiliary Target.....	14
Nearest Vertex.....	14
Target.....	14
Offset.....	14
Vertex Group.....	14
Invert.....	14
Simple Deform.....	14
Deform Method.....	14
Twist.....	14
Bend.....	14
Taper.....	15
Stretch.....	15
Origin.....	15
Restrictions.....	15
Limits.....	15
Lock.....	15
Vertex Group.....	15
Smooth.....	15
Axis.....	15
Factor.....	15
Repeat.....	15
Vertex Group.....	15
Invert.....	16
Warp.....	16
Object From.....	16
Object To.....	16
Preserve Volume.....	16
Strength.....	16
Vertex Group.....	16
Invert.....	16
Falloff.....	16
Falloff Type.....	16
Radius.....	16
Texture.....	17
Usage.....	17
Texture Prop.....	17
Texture browser.....	17
Texture Edit Box.....	17
Fake User.....	17
Add Texture.....	17
Remove.....	17
Change Context.....	17
Coordinates.....	17
Wave.....	18
Motion.....	18
Cyclic.....	18
Along Normals.....	18
X/Y/Z.....	18

Falloff.....	18
Height.....	18
Width.....	18
Narrowness.....	19
Vertex Group.....	19
Invert.....	19
Start Position.....	19
Object.....	19
Start Position X/Y.....	19
Time.....	19
Offset.....	19
Life.....	19
Damping.....	19
Speed.....	19
Texture subtab.....	20
Usage.....	20
Texture Prop.....	20
Texture browser.....	20
Texture Edit Box.....	20
Fake User.....	20
Add Texture.....	20
Remove.....	20
Change Context.....	20
Coordinates.....	20

Curve&Text - Deform modifiers

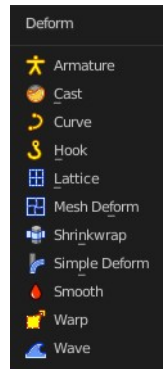

Armature

An armature system allows to deform objects accurately by posing bones. The Armature modifier contains the armature settings at the mesh end. This modifier gets created automatically when you parent a mesh to an armature.

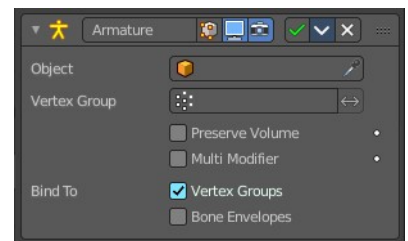

Object

The name of the armature object used by this modifier.

Vertex Group

A vertex group of the object, which weights will be used to determine the influence of this modifier's results when mixing it with the results from other Armature ones.

This is only of use when having at least two of these modifiers on the same object, with Multi Modifier activated.

Invert

Inverts the influence set by the vertex group.

Preserve Volume

Use quaternions for preserving volume of object during deformation.

Without Preserve Volume, rotations at joints tend to scale down the neighboring geometry, up to nearly zero at 180 degrees from rest position. With it, the geometry is no longer scaled down, but there is a discontinuity when reaching 180 degrees from rest position.

Multi Modifier

You can parent an object to more than one armature. The Multi Modifier allows you to use several armatures to deform the same object, all based on the “non-deformed” data.

The results of the Armature modifiers are then mixed together, using the weights of the Vertex Group as “mixing guides”.

Bind to

Vertex Groups

Meshes and lattices only. Use Vertex groups for deforming the mesh. A bone named “forearm”, will only affect the vertices in the “forearm” vertex group. The influence of one bone on a given vertex is controlled by the weight of this vertex in the relevant group.

The vertex groups are located in the Object Data Properties in the Properties editor.

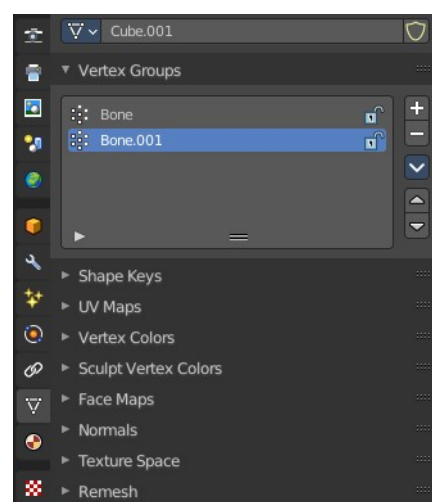

Bone Envelopes

Use the Bone envelopes to deform vertices or control points near them, defined by each bone's envelope radius and distance.

When envelopes are disabled, Blender uses the set of existing vertex group names to determine which bones

influences what mesh part.

Bone envelopes display can be turned on in the Viewport Display panel in the Object Data properties tab in the Properties Editor. Display as ...

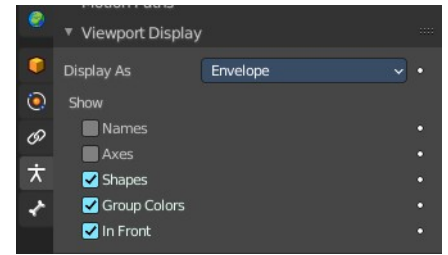

And can be adjusted in the Transform panel in the sidebar of the 3D View, in Edit mode.

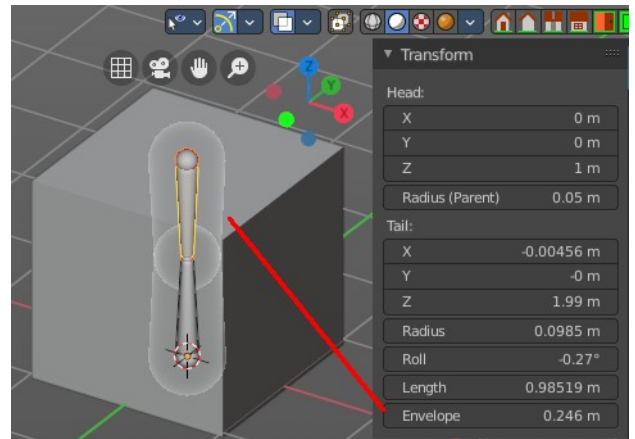

Cast

The Cast modifier shifts the shape of a mesh, curve, surface or lattice object, towards predefined shapes. Sphere, cylinder, cuboid.

Note! For performance reasons, this modifier only works with local coordinates. If the modified object looks wrong, you may need to apply its transformations, especially when casting to a cylinder.

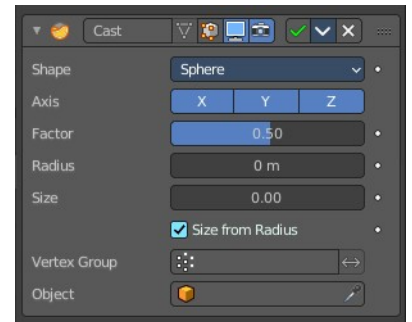

Shape

Choose the target shape of the projection: Sphere, Cylinder or Cuboid.

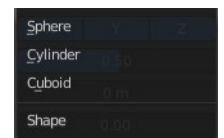

Axis

The directions in which the modifier works. For a Cylinder shape the Z axis remains unaffected.

Factor

The factor to control blending between original and cast vertex positions.

The factor is a linear interpolation. 0.0 gives original coordinates, and the modifier has no effect then. 1.0 casts to the target shape. Values below 0.0 or above 1.0 exaggerate the deformation.

Radius

A value above 0.0 defines a sphere of influence. Vertices outside it are not affected by the modifier.

Size

Alternative size for the projected shape. If zero, it is defined by the initial shape and the control object, if any.

Size from Radius

Calculate Size from Radius. Can give smoother results.

Vertex Group

Restrict the effect to the vertices in that vertex group.

Invert

Inverts the influence of the selected vertex group.

Object

The name of an object to control the effect. The location of this object's origin defines the center of the projection. And its size and rotation transform the projected vertices.

Curve

The Curve modifier deforms a mesh along a curve object. You need to have a curve object in the scene, and choose it as the curve object.

The modifier works in global space on a dominant axis, X, Y, or Z. When you move your mesh in the dominant direction, the object will move along the curve. When you pull into the other axis directions then the object will move away from the dominant axis, and deform.

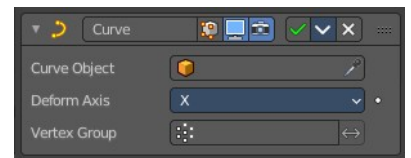

When you move the object beyond the curve's ends, the object will keep the deformation from the latest curve point.

If the curve is 3D, then the rotation of the object can be controlled by the mean tilt of the curve control points. The mean tilt can be found in edit mode in the sidebar in the Transform panel. Other options in the Shape panel can also have an influence at the deforming result. Like Stretch.

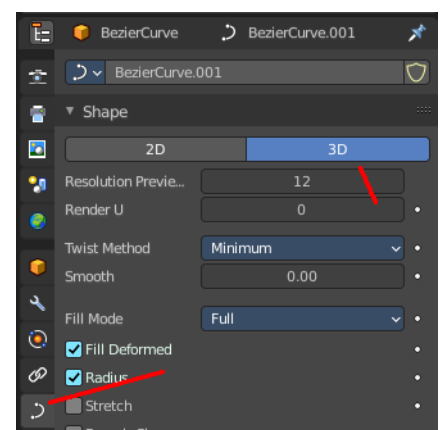
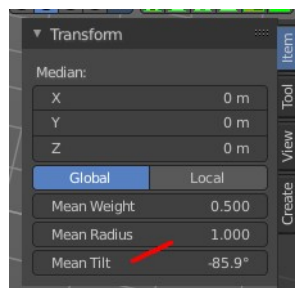

Curve Object

The name of the curve object that will affect the deformed object.

Deformation Axis

The axis to deform along.

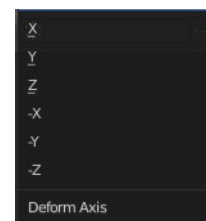

Vertex Group

Restrict the effect to the vertices in that vertex group.

Invert

Inverts the influence of the selected vertex group.

Texture Prop

Texture browser

A list of the available textures

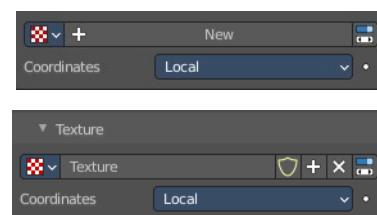

Texture Edit Box

The name of the currently active texture. Allows to rename the texture too.

Fake User

Keep this data even when it has no user in the scene.

Add Texture

Add a new texture.

Remove

Removes the texture. Note that the texture is still in the browser list.

Change Context

Jump to texture tab and show the texture.

Coordinates

The texture coordinate system to use for the displacement.

The displacement can be along a particular local axis, along the vertex normal. Or the separate RGB components of the texture can be used to displace vertices in the local X, Y and Z directions simultaneously. This is called Vector Displacement.

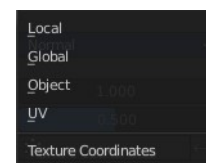

Direction

The direction along which to displace the vertices.

X, Y, Z

Displace along an axis.

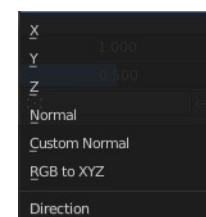

Space

With a direction set to X, Y, Z, or XYZ the modifier can either displace along local or global axes.

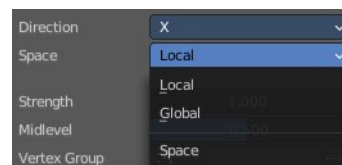

Normal

Displace along the vertex normal.

Custom Normal

Displace along (averaged) custom normals, instead of vertex normals.

RGB to XYZ

Displace along local XYZ axes individually using the RGB components of the texture. Red values displaced along the X axis, Green along the Y, Blue along the Z axis.

Space

With a direction set to X, Y, Z, or XYZ the modifier can either displace along local or global axes.

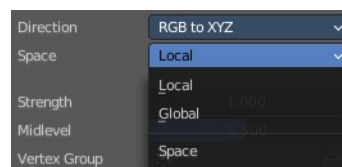

Strength

The strength of the displacement. A negative strength inverts the effect of the modifier.

After offsetting by the Mid level value, the displacement will be multiplied by the Strength value to give the final vertex offset.

$$\text{vertexoffset} = \text{displacement} \times \text{Strength}$$

Mid level

The texture value which will be treated as no displacement by the modifier. Texture values below this threshold will result in negative displacement along the selected direction, while texture values above it will result in positive displacement.

$$\text{displacement} = \text{texturevalue} - \text{Midlevel}$$

Note that that color/luminosity values are typically between (0.0 to 1.0) in Blender, and not between (0 to 255).

Vertex Group

Use a vertex group to control the influence of the modifier.

Invert

Inverts the influence of the selected vertex group.

Hook

The Hook modifier is used to deform a mesh, curve or lattice by another object. When you move this hook object, then it pulls vertices or control points with it.

Assigning the hook object to specific vertices of the target object is done in Edit mode. The modifier shows a set of buttons then.

This modifier is automatically created when you add a Hook from the Hooks menu in the Edge menu in edit mode.

Some settings just exists in Edit mode.

Warning! The Hook Modifier stores vertex indices from the original mesh to determine what to affect. Modifiers that generate geometry, like Subdivision Surface, should always be put after the Hook modifier in the stack. Otherwise, the generated geometry can't be affected by the hook's influence.

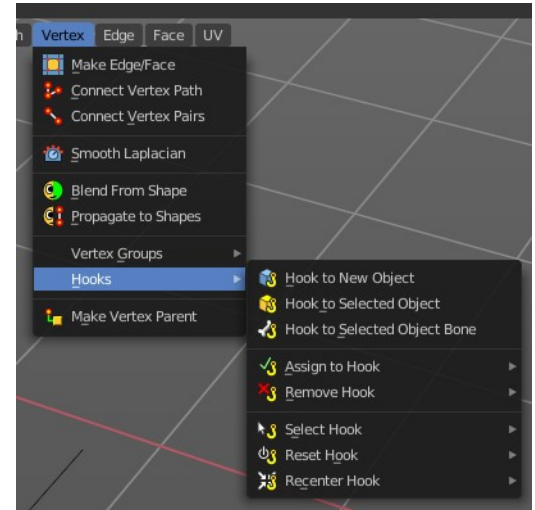
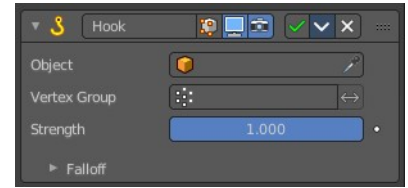

Object

The name of the object to hook vertices to.

Vertex Group

Allows you to define the influence per vertex.

Invert

Inverts the influence of the selected vertex group.

Strength

Adjust this hooks influence on the verticles.

Reset

In Edit mode. Recalculate and clear the offset transform of the hook.

Recenter

In Edit mode. Set the hook center to the 3D cursor position.

Select

In Edit mode. Select the vertices affected by this hook.

Assign

In Edit mode. Assigns selected vertices to this hook.

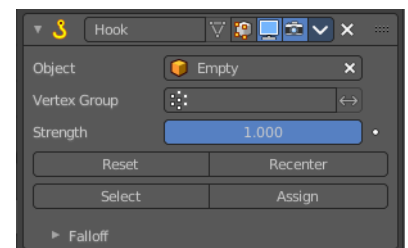

Falloff

Type

This can be used to adjust the kind of influence curve that the hook has on the mesh. You can also define a custom curve to get a much higher level of control.

Radius

The size of the hooks influence.

Uniform Falloff

Compensate non uniform scale, and use a uniform falloff.

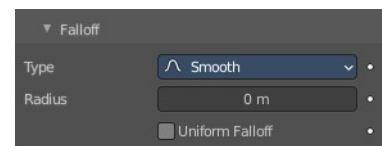

Lattice

The Lattice modifier deforms the base object by the shape of a Lattice object. It can be used at meshes, curves, surfaces, text, lattices and even particles.

A Lattice modifier with valid settings can be added by selecting the object, holding down shift, select the target lattice object, and then choose Lattice Deform in the Parent menu.

Note! When you want to use a lattice to deform particles, then you need to place the Lattice modifier after the Particle System modifier.

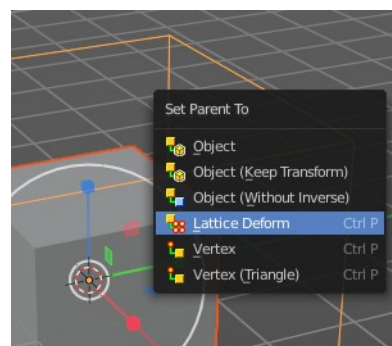
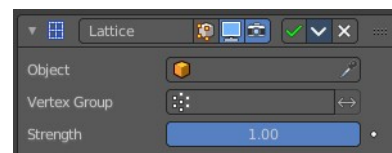

Object

The Lattice object that deforms the base object.

Vertex Group

Limit the modifier's effect to a vertex group of the base mesh.

Invert

Inverts the influence of the selected vertex group.

Strength

A factor to control blending between original and deformed vertex positions.

Mesh Deform

The Mesh Deform modifier allows an arbitrary mesh of any closed shape to act as a deformation cage around another mesh.

Note! The changes are not displayed in edit mode. But Edit mode is where

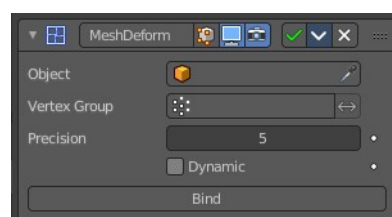

you deform your cage object.

Note! This modifier can run out of memory and crash.

Object

The name of the mesh object to be used as the deforming cage.

Vertex Group

Restrict the affected vertices to a vertex group.

Invert

Inverts the influence of the selected vertex group.

Precision

Controls the accuracy with which the deform mesh cage alters the deformed object when the points on the cage are moved. Higher values means better precision and higher calculation time.

This setting is unavailable once a cage has been bound.

Dynamic

When activated, other mesh altering features (such as other modifiers and shape keys) are taken into account when binding. This increases the deformation quality.

This setting is unavailable once a cage has been bound.

Bind

Bind the current vertex positions of both, the modified geometry and the deforming Object, together. An unbound Mesh Deform modifier has no effect. It must be bound so that altering the shape of the deform mesh cage is able to alter the shape of the modified object.

Warning! It can take a long time for the operation to complete. And the software may not respond for a pretty while.

Unbind

Unbind the meshes. The deformed object will reset back to its original shape that it had before it was bound to the deform mesh cage.

Shrinkwrap

The Shrinkwrap modifier allows an object to “shrink” to the surface of another object. It moves each vertex of the object to the closest position on the surface of the target object.

It can be applied to meshes, lattices, curves, surfaces and texts.

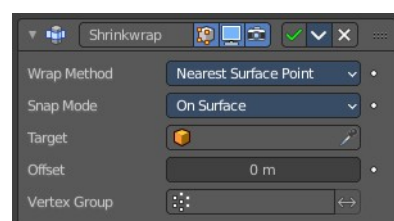

Wrap Method

The method to determine the nearest point on the target’s surface for each vertex of the object.

Nearest Surface Point + Target Normal Project

Nearest Surface Point selects the nearest point at the surface. Additionally, Target Normal Project tries to match the interpolated normals of the surface.



Snap Mode

How the vertex snaps to the surface. The methods should be self explaining.

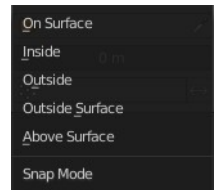

Target

The target mesh to shrink to.

Project

Projects all vertices along a chosen axis until they hit the surface of the target object.

Vertices that never hits the surface are not calculated.

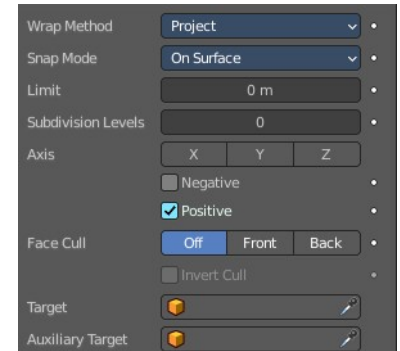

Snap Mode

How the vertex snaps to the surface. The methods should be self explaining.

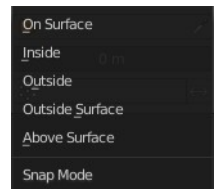

Limit

A distance limit between original vertex and surface. If the distance is larger than this limit vertex would not be projected onto the surface.

Subdivision Levels

This applies a (temporary) Catmull-Clark subdivision to the modified object’s geometry, before computing the wrap.

Axis

Along which local axis of the modified object the projection is done. These options can be combined with each other, yielding a “median axis” of projection. If none are selected, the normal direction is used.

Negative/Positive

This allows you to select the allowed direction(s) of the shrink along the selected axis. If both options are enabled, both ways are evaluated and the closest hit is selected.

Face Cull

Allows you to prevent any projection over the “front side” or the “back side” of the target’s faces. The “side” of a face is determined by its normal.

Target

The target mesh to shrink to.

Auxiliary Target

An additional object to project to.

Nearest Vertex

Snaps to the nearest vertex instead of the nearest surface point.

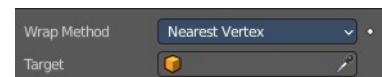

Target

The target mesh to shrink to.

Offset

An offset distance to keep to the target surface.

Vertex Group

Restrict the affected vertices to a vertex group.

Invert

Inverts the influence of the selected vertex group.

Simple Deform

The Simple Deform modifier allows simple deforming of an object of type Mesh, lattice, curve, surface and text.

The deformation is calculated in local coordinate space.

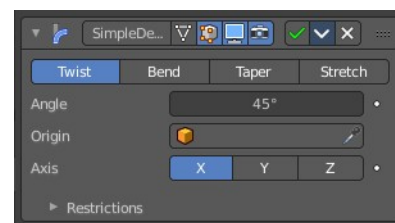

Deform Method

Twist

Twist rotates the object around an axis. Vertices in the same plane as the origin are not rotated. Above the origin the rotation is clockwise. Below the origin the rotation is negative. The amount of rotation is dependent of the distance to the origin. Closer vertices rotates not so strong.

Bend

Bend bends the object over an axis.

Taper

Taper tapers the object across its origin. The scaling factor is weighted by the distance from the origin of the object in the deform axis.

Stretch

Stretch scales the object along an axis.

Angle (Twist & Bend) / Factor (Taper & Stretch)

The total amount of deformation. A negative value reverses the deformation.

Origin

Pick an object to use its origin as the origin for the simple deformation.

Restrictions

Limits

You can set lower and upper limits for the deformation. The upper limit cannot be lower than the lower one. These limits are mapped on the Deform axis.

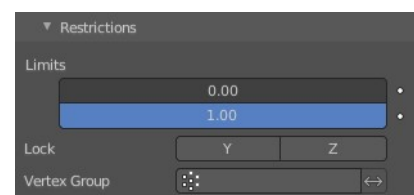

Lock

Not for Bend. Do not allow deformations along these axis.

Vertex Group

Limit the deformation to a vertex group.

Smooth

The Smooth modifier smoothens a mesh by flattening the angles between adjacent faces.

Axis

The axis to modify.

Factor

The smoothing amount. Higher values will increase the effect. Values outside expected range (above 1.0 or below 0.0) will distort the mesh.

Repeat

The number of smoothing iterations.

Vertex Group

Limit the modifier to a vertex group.

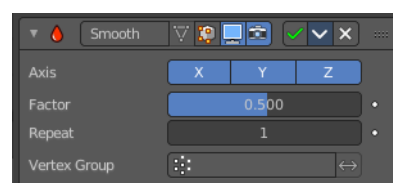

Invert

Inverts the influence of the selected vertex group.

Warp

The Warp modifier warps parts of a mesh to a new location by using two target objects. The deformation goes into the direction from the first target object to the second target object. This target objects can be of any type. Empty, Lamp, Camera, etc. For demonstration purposes two spheres are used.

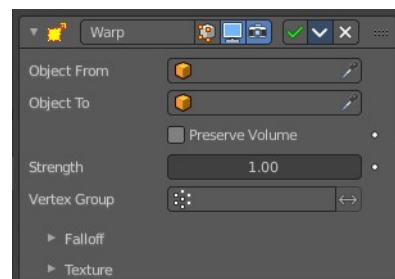
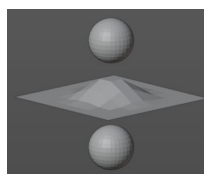

Object From

The object to define the origin transformation of the warp.

Object To

The object to define the destination transformation of the warp.

Preserve Volume

Enables volume preservation when rotating one of the transforms.

Strength

Sets how strong the effect is.

Vertex Group

Limit the modifier to a vertex group.

Invert

Inverts the influence of the selected vertex group.

Falloff

Falloff Type

The falloff type. How the strength of the warp changes as it goes from the center of the transform to the Radius value.

Radius

The distance from the transforms that can be warped by the transform handles.

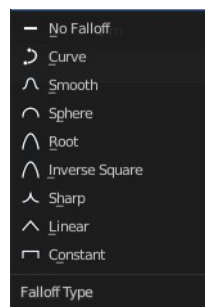
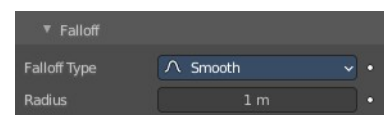

Texture

A texture allows you to control how the vertices are affected by the modifier.

Usage

Add a texture.

Head over to the Texture tab.

In the texture tab either load an existing texture. Or create one. A procedural Noise texture for example.

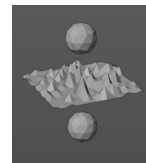
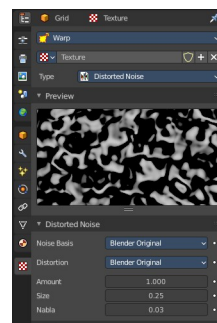
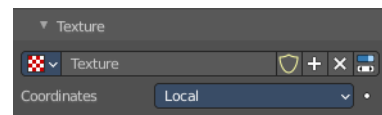

Texture Prop

Texture browser

A list of the available textures

Texture Edit Box

The name of the currently active texture. Allows to rename the texture too.

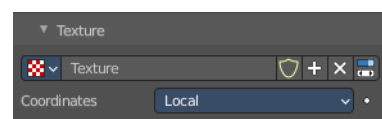
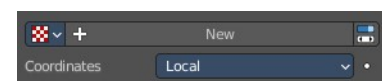

Fake User

Keep this data even when it has no user in the scene.

Add Texture

Add a new texture.

Remove

Removes the texture. Note that the texture is still in the browser list.

Change Context

Jump to texture tab and show the texture.

Coordinates

What texture coordinate system to use.

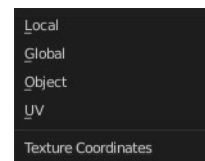

Wave

The Wave modifier adds a ripple-like shape to an object's geometry. The shape can be animated by playing the animation.

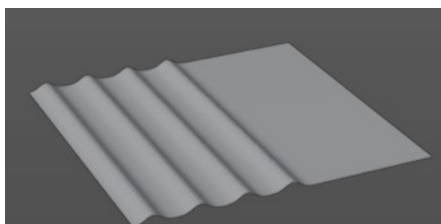

This modifier works with meshes,

lattices, curves, surfaces and texts.

Important! All the values are in local object space. They must be multiplied with the corresponding Scale values of the object to get the real dimensions.

To obtain a nice wave effect similar to sea waves and close to a sinusoidal wave, make the distance between following ripples and the ripple width equal. That is, the Narrowness value must be equal to $2 / \text{Width}$. E.g. for Width to be 1, set Narrow to 2.

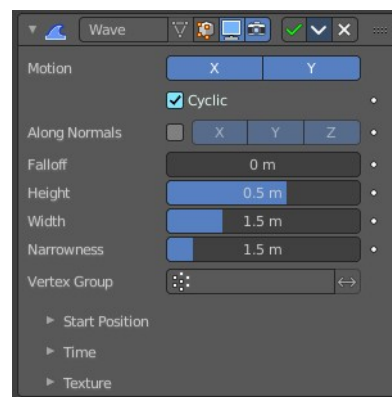

Motion

The wave effect deforms vertices/control points in the Z direction. The initial start point is the object origin. The direction is then in X or Y direction. With both activated you get a circle shape.

Cyclic

Repeats the waves.

When you want to have more circles at frame 1 already, then use a negative Offset in the Time subpanel.

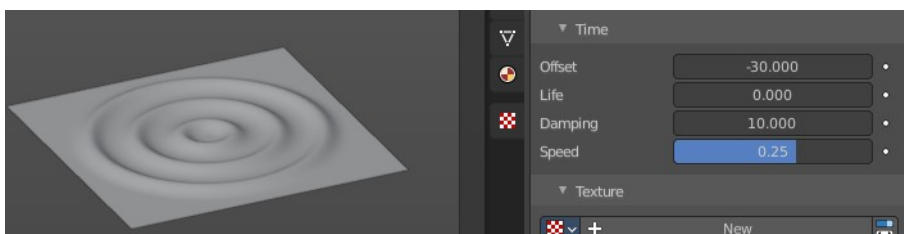

Along Normals

For meshes only. Displaces the mesh along the surface normals (instead of the object's Z axis).

X/Y/Z

Restrict displacement along normals to the selected local axes.

Falloff

Controls how fast the waves fade out as they travel away from the starting point.

Height

The height or amplitude of the ripple.

Width

Distance between the waves. If the pulses are too near to each other, the wave may not reach the zero Z

position. In this case the whole wave gets lowered so that the minimum is zero, and the maximum is lower than the expected amplitude.

Narrowness

The actual width of each pulse.

The higher the value the narrower the pulse. The actual width of the area for a single is given by $4 / \text{Narrowness}$.

Vertex Group

Limit the effect of the modifier to a vertex group.

Invert

Inverts the influence of the selected vertex group.

Start Position

Object

Use the origin of another object as the starting point.



Start Position X/Y

Coordinates of the center of the waves, in object's local space.

Time

Settings to control the animation.

Offset

Time offset in frames. The frame at which the wave begins (if Speed is positive), or ends (if Speed is negative). Use a negative frame number to prime and pre-start the waves.

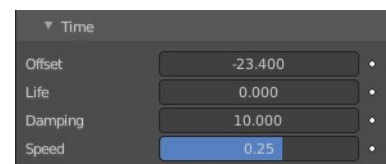

Life

Duration of animation in frames. With a value of zero the animation loops forever.

Damping

An additional number of frames in which the wave slowly damps from the Height value to zero after Life is reached. The dampening occurs for all the ripples and begins in the first frame after the Life is over. Ripples disappear over Damping frames.

Speed

The speed per frame, of the ripple.

Texture subtab

A texture allows you to control how the vertices are affected by the modifier.

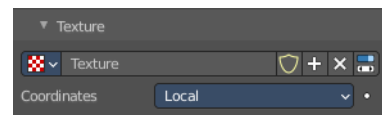

Usage

Add a texture.

Head over to the Texture tab.

In the texture tab either load an existing texture. Or create one. A procedural Noise texture for example.

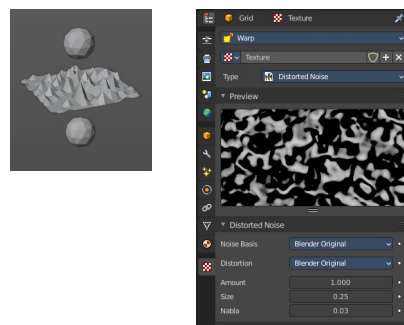

Texture Prop

Texture browser

A list of the available textures

Texture Edit Box

The name of the currently active texture. Allows to rename the texture too.

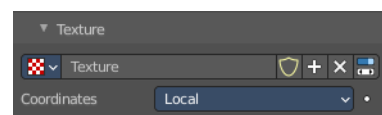
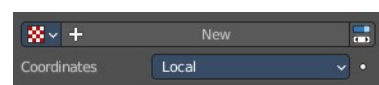

Fake User

Keep this data even when it has no user in the scene.

Add Texture

Add a new texture.

Remove

Removes the texture. Note that the texture is still in the browser list.

Change Context

Jump to texture tab and show the texture.

Coordinates

What texture coordinate system to use.

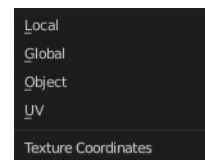



26.9.8 Editors - Properties Editor - Modifiers Properties Tab - Curve&Text - Deform Modifiers

Table of content

Curve&Text - Physics modifiers.....	1
Soft body.....	1

Curve&Text - Physics modifiers

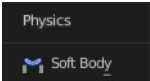

Soft body

The Soft body modifier gets added into the modifier stack when you add a Soft Body physics in the Physics tab. It enables Soft Body simulation for the mesh.

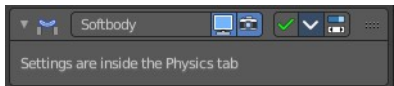

All the Soft body settings and adjustments happens in the Physics tab. The Soft body modifier has no further settings.

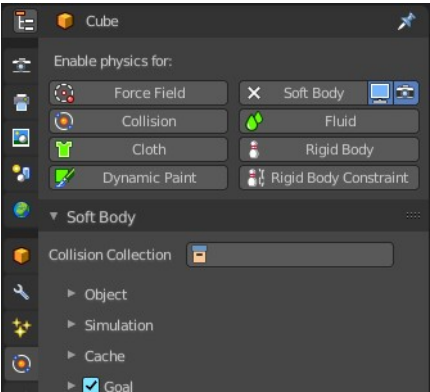



26.9.9 Editors - Properties Editor - Modifiers Properties Tab - Volume - Modifiers

Table of content

Detailed table of content.....	1
Volume - Generate modifiers.....	2
Geometry Nodes.....	2
Mesh to Volume.....	3
Volume - Deform modifiers.....	3
Volume Displace.....	4

Detailed table of content

Detailed table of content

Detailed table of content.....	1
Volume - Generate modifiers.....	2
Geometry Nodes.....	2
Data Browser.....	2
Edit box.....	2
Add Fake User.....	2
User.....	2
Add.....	2
Remove.....	2
Mesh to Volume.....	3
Object.....	3
Density.....	3
Fill Volume.....	3
Exterior Band Width.....	3
Interior Band Width.....	3
Resolution Mode.....	3
Voxel Amount.....	3
Voxel Size.....	3
Volume - Deform modifiers.....	3
Volume Displace.....	4
Texture Prop.....	4
Texture Browser.....	4
Edit Box.....	4
Change Context.....	4
Unlink.....	4
File selector menu.....	4
New.....	4
Duplicate.....	4
Unlink.....	5
Add Fake User.....	5
User.....	5
Texture Mapping.....	5
Strength.....	5

Sample Radius.....5
 Mid Level X Y Z.....5

Volume - Generate modifiers

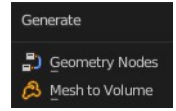

Geometry Nodes

The geometry modifier adds a geometry node tree, which can be modified in the geometry node editor.

Manage the nodes. If there is no geometry node tree for the current object, then you will see the New button

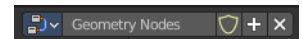
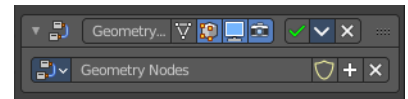

Data Browser

The list of available geometry node trees in the scene.

Edit box

The name of the current active geometry node tree. Here you can also rename the node tree.

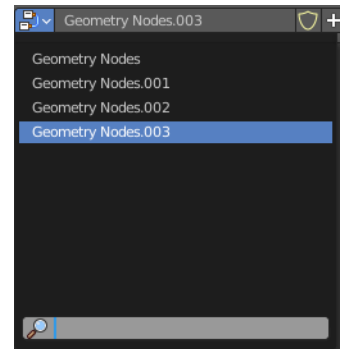

Add Fake User

With this button you assign a fake user to this selected geometry node tree.

Data, like node trees, that is not longer linked to anything else gets removed when you save and reload a scene. Bforartists has the concept of fake users to go around this behavior. An image with a fake user is in fact linked to something. And so it is not lost when you save and reload the scene.

User

The number of users that uses this data. Data with a user number of 0 will be removed with closing Bforartists.

Add

Add a geometry node.

Remove

Removes the geometry node tree. To delete it completely you need to purge it. See Fake user.

Mesh to Volume

You need a volume object.

The Mesh to Volume modifier uses a mesh to create a new volume grid. All previously existing volume grids on the volume object are discarded. So this modifier is usually added to an empty volume object. The new volume grid is called “density”.

Tip! To copy and move the generated volume separately from the mesh object, use a collection instance.

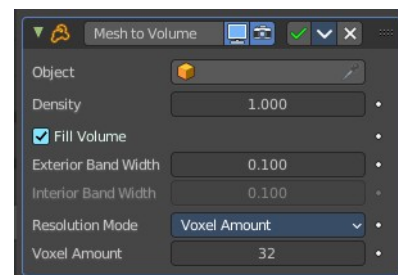

Object

The mesh object to use for the volume generation. Pick a mesh object here.

Density

Makes the generated volume appear denser or less dense when rendering.

Fill Volume

The entire enclosed volume or otherwise only the voxels close to the surface will get a density greater than zero. This setting is only used when the mesh object is Manifold.

Exterior Band Width

The maximum distance of the included voxels to the surface on the outside of the mesh.

Interior Band Width

The maximum distance of the included voxels to the surface on the inside of the mesh. Activating Fill Volume is similar to increasing the interior band width to a high number.

Resolution Mode

Mode for how the voxel size is specified.



Voxel Amount

This allows setting an approximate number of voxels that will be used to represent mesh along its diagonal. When the dimensions of the mesh changes, the voxel size will change as well. For final rendering of animations, it's better to specify the voxel size explicitly to avoid artifacts.

Voxel Size

This allows setting the exact voxel size that will be used. This is idea for rendering when the voxel size should not change between frames.

Volume - Deform modifiers

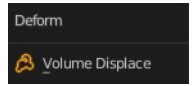

Volume Displace

The Volume Displace modifier displaces existing volume grids by a 3D texture. It uses the RGB color channels of the texture to displace the volume into the X, Y and Z direction.

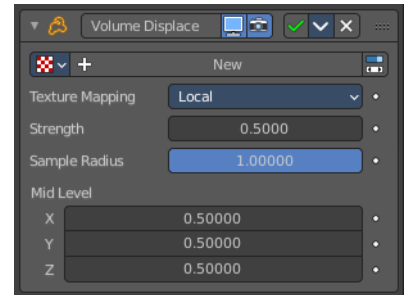

Texture Prop

The texture to use for the displacement of the voxels. For a three dimensional displacement colored textures should be used. Greyscale images just displaces into one direction. Colored images into all three directions.

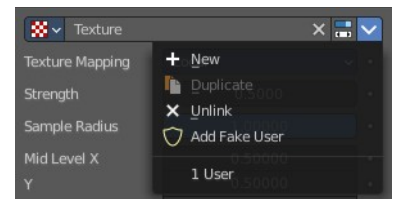

Texture Browser

A list of the available textures in the scene. Textures can be added in the Texture tab in the Properties Editor.

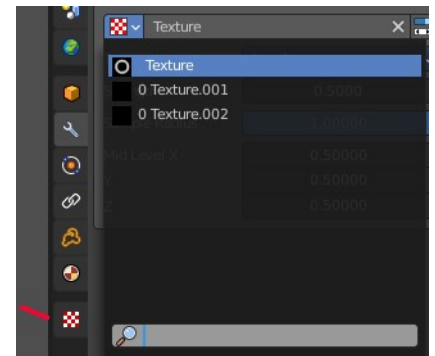

Edit Box

The name of the texture. Here you can also rename the texture.

Change Context

Jump to the Texture tab to load a texture.

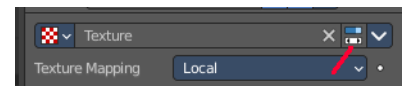

Unlink

Removes the currently active texture.

File selector menu

New

Creates a new texture slot. It is blank. You first need to load a texture, which can be done in the Texture tab in the Properties Editor.

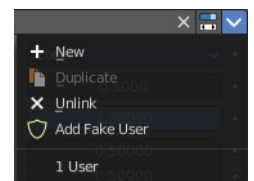

Duplicate

Not active in this context.

Unlink

Removes the currently active texture.

Add Fake User

With this button you assign a fake user to this selected world.

Data, like worlds, that is not longer linked to anything else gets removed when you save and reload a scene. Bforartists has the concept of fake users to go around this behavior. An image with a fake user is in fact linked to something. And so it is not lost when you save and reload the scene.

User

The number of users that uses this data. Data with a user number of 0 will be removed with closing Bforartists.

Texture Mapping

What space to use to map the texture onto the object.

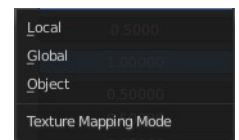

Strength

Controls how far voxels are displaced.

Sample Radius

Smaller values result in better performance, but might cut off the volume outside.

Mid Level X Y Z

This should be modified if the texture offsets the entire volume in one direction and you want to center it again. For performance reasons, the displaced volume should stay close to its original position.



27 Editors - File browser

Table of content

File Browser.....	3
File Browser Header.....	4
Navigation.....	4
Previous Folder.....	4
Next Folder.....	4
Parent File.....	4
Refresh.....	4
New Folder.....	4
File path.....	4
Search.....	4
Display As.....	5
Vertical List.....	5
Horizontal List.....	5
Thumbnails.....	5
Display Options.....	5
Columns.....	5
Size.....	5
Date.....	5
Recursion.....	5
Sort by.....	6
Reverse Sorting.....	6
Filter.....	6
Filter.....	6
Folders, etc.....	6
Show Hidden.....	6
Toggle Region.....	6
Tool Shelf.....	6
System Panel.....	7
System Bookmarks.....	7
Bookmarks.....	7
Recent.....	7
Sidebar.....	8
Load UI.....	8
Trusted Source.....	8
Advanced panel.....	8
File dialog.....	9
Click navigation.....	9
Double Click to load.....	9
Double click to save.....	9
Select and load more than one file.....	9
Box select.....	9
Renaming.....	9
File Name.....	9
Open / Save.....	9
Cancel.....	9
Footer / Header.....	10
View Menu.....	10

Source List.....	10
File Path.....	10
Frame selected.....	10
Area Menu.....	10
Horizontal Split.....	10
Vertical Split.....	10
Duplicate Area into new Window.....	10
Toggle Maximize Area.....	10
Close Area.....	10
Pie Menus.....	11
View.....	11
Select menu.....	11
Box Select.....	11
Inverse.....	11
None.....	11
All.....	11
Files context menu.....	11
Back.....	11
Forward.....	11
Go to Parent.....	11
Refresh.....	12
Increase Number.....	12
Decrease Number.....	12
Rename.....	12
Delete.....	12
New Folder.....	12
Add Bookmark.....	12
Display Mode.....	12
Display Size.....	12
Recursion.....	12
Sort.....	12

File Browser

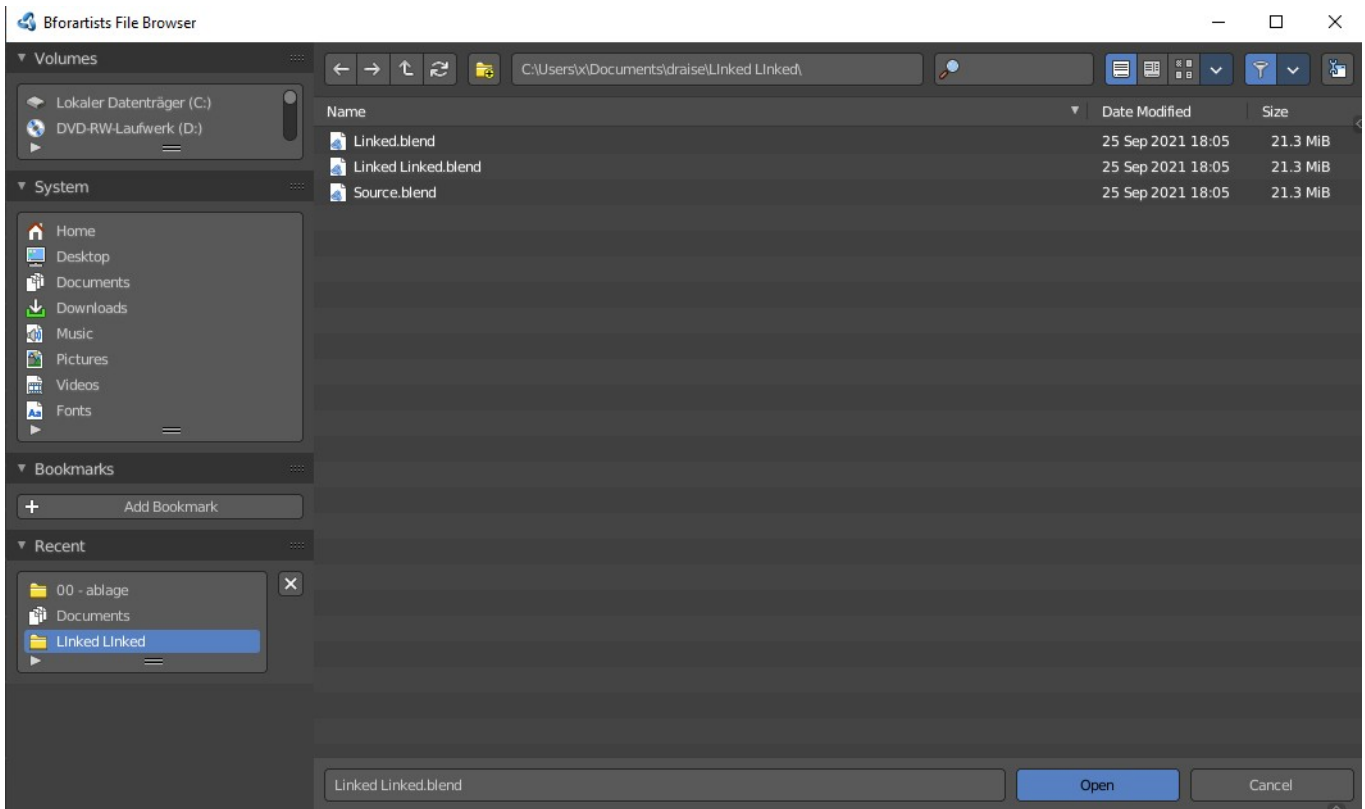

The file browser is an explorer dialog that allows you to browse for locations and files, and allows you to load and save them.

The file browser has multiple uses. While its often used for save/load, it can be kept open for other uses too.

In the file browser you can:

- Opening and Saving Blend files.
- Import/Export other file formats.
- Picking new locations for existing file-paths (images, video's, fonts... etc).
- Browsing inside other .blend files, when using *Append and Link*.

You can also keep the file selector open, as with any other window type. In this case the buttons to load files is removed. This is for example done in the Shader editor workspace. This allows you to drag files directly into the editor where you need it.

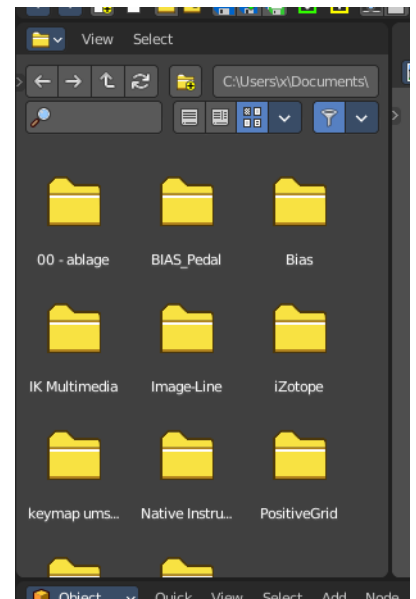

File Browser Header

There are several tools in the header to find. The range goes from navigation elements across filters up to display options.

There are two header areas. The header area that contains the

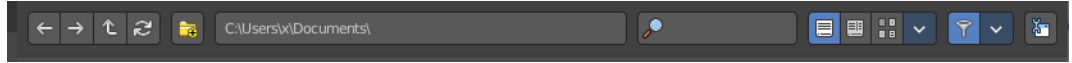

navigation and filter elements. And the editor header like in a traditional editor. This header is hidden when you use the file browser as a file selector. But it is still available. It resides at the bottom, and can be revealed by clicking at the small triangle button down right.

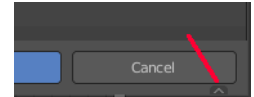

For this content see Footer Header chapter below.

Navigation

Navigate in the folder hierarchy.



Previous Folder

Navigate to the previous folder.

Next Folder

Navigate to the next folder.

Parent File

Go upwards in the hierarchy.

Refresh

Refresh the file list.

New Folder

Creates a new folder.



File path

The current directory.



Search

Name Filter. Allows you to search for specific files and folders.



Display As



Vertical List

Displays the content of the file browser as a vertical list.

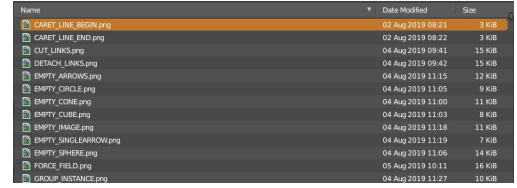

Horizontal List

Displays the content of the file browser as a horizontal list.

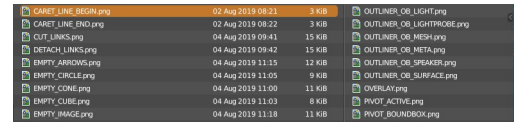

Thumbnails

Displays the content of the file browser as thumbnails. This is especially of use for images or blend files with thumbnail preview.

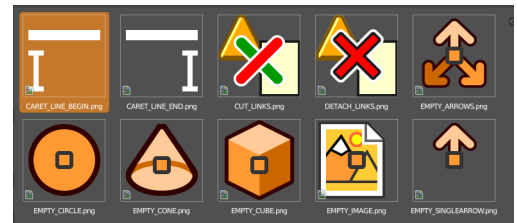

When you link or append from a blend file then the thumbnails also shows folders with icons for the different content of the library blend file.

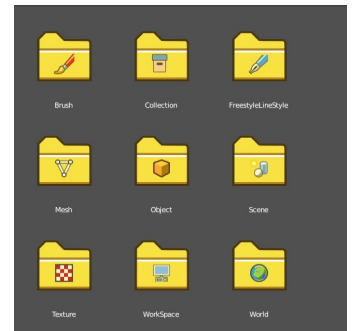

Display Options

Columns

When in columns view ...

Size

Display the size of the files.

Date

Display the creation date of the files.

Recursion

Adjust how deep the explorer should dig. Normally it just lists the content of the currently selected directory. But it is also possible to list the content of the folders three levels lower.

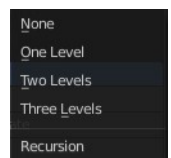
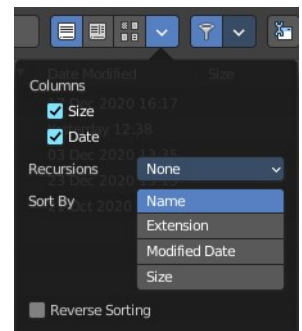

The recursion direction is always downwards. Default is None.

Sort by

Sort the files by chosen method. The methods are self explaining.

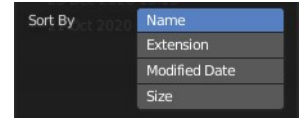

Reverse Sorting

Reverts the sorting direction.

Filter

Filter

Enable the filtering.

Folders, etc.

The different file types that should be filtered. What is ticked here and what file types shows depends of what file browser you call. If you want to load a blend file. Or a FBX file from the File menu in the header. Or an image in the UV Editor for example.

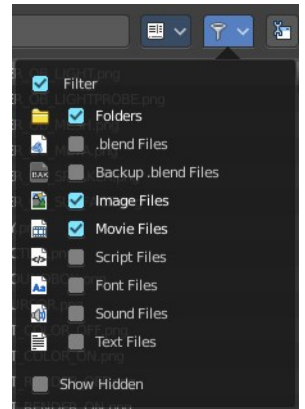

Show Hidden

Shows hidden Dot files.

This is a Unix feature. Unix systems like Linux or Mac hides files from file browsers and explorers by having a dot before the file. A good example is the .htaccess file at servers. Show hidden Dot Files makes such files visible to the file browser.

Toggle Region

Toggles the sidebar at the right. The sidebar contains various im- and export settings for the single file types.

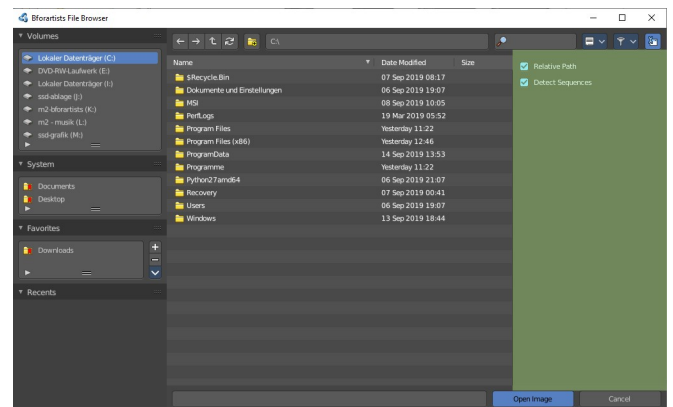

Tool Shelf

The Tool Shelf at the left provides you with some panels for quick access to files and bookmarks.

System Panel

Lists your drives.

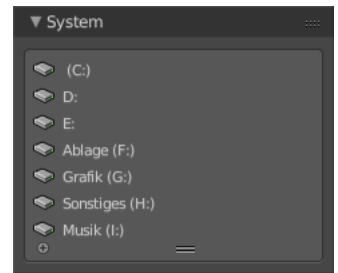

System Bookmarks

Lists some system libraries.

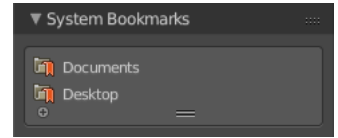

Bookmarks

Add your own bookmarks. A direct bookmark towards the Downloads folder for example.

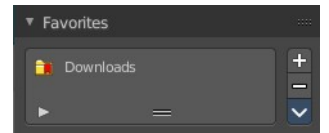
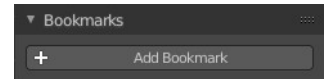

Recent

A list of the recent accessed folders.

Greyed out folders are not longer existing directories. There is unfortunately no way to remove them from within Bforartists. You would need to do this manually in the History text files in the settings folder.

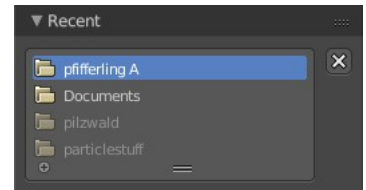

Under Windows this is the bookmarks.txt file in the Appdata folder.

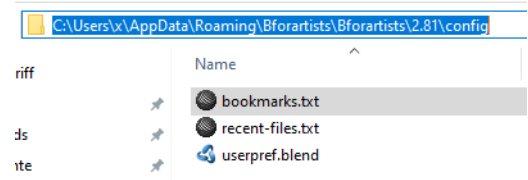

Sidebar

The sidebar is usually closed in most cases. Sometimes you need to open it. This can be done with a click at the Toggle Region button up right.

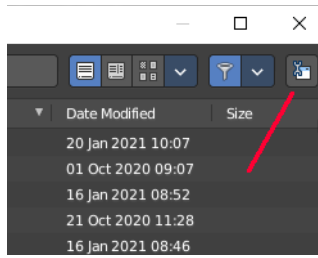

In the sidebar you will for example find the special Import or Export settings for the current file format. And here you will also find further settings. loading a Blend file you will just see two entries. When you append from a file then it's a bit more settings. And for file formats like FBX you will find all the settings for the current file format.

At the right you see the import dialog for FBX.

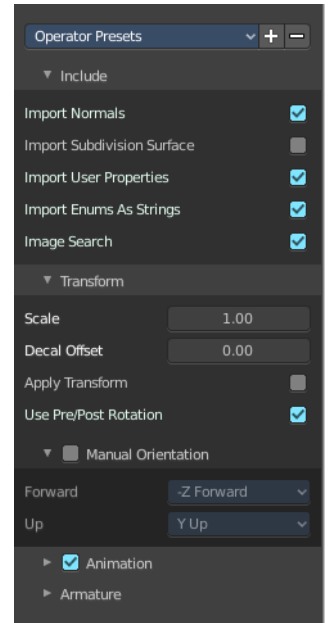

As an example, and to explain the two settings for loading a blend file:

Load UI

Bforartists comes with the feature *Load UI* unticked. This means the Bforartists UI will not change when you load a scene. Here you can temporary enable to load the scene with the layout and UI arrangement in which the scene was saved.

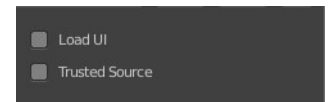

Trusted Source

With Load UI you can also load script files, which can execute. This is a potential security risk when the file comes from an unknown source.

Advanced panel

When you append from a blend file, then you will find an Advanced panel with further filter settings in the sidebar. This filter allows you to filter the content for exact object types.

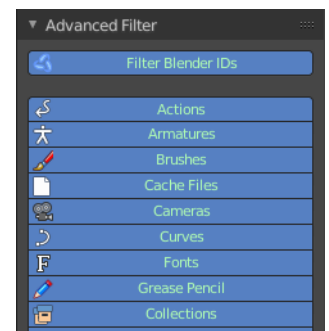

File dialog

The file dialog is the actual place where your files and directories gets listed.

Click navigation.

Double clicking at a folder enters the folder. To go upwards in the hierarchy see Parent File button in the header.

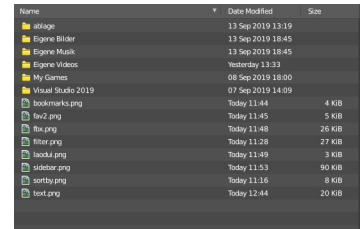

Double Click to load

Double clicking at a file loads the chosen file when you are in a load dialog. The file dialog will then close.

Double click to save

Double clicking at a file overwrites the chosen file when you are in a save dialog. The file dialog will then close.

Select and load more than one file

Holding down shift allows you to select and to load more than one file.

Box select

You can drag a box around the files by simply left clicking and moving the mouse.

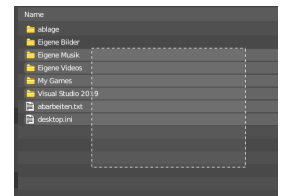

Renaming

You can rename files and folders from within this list. Holding down ctrl and clicking at a file enters the edit file name mode.

File Name

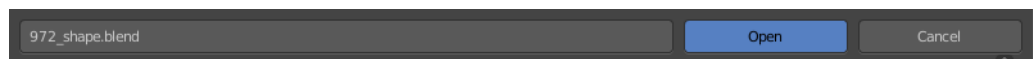

The file that you want to load or to save.

Open / Save

Open or save the current file(s).

Cancel

Cancel the loading or save process and close the file browser.

Footer / Header

The footer is hidden by default when you call the file browser to load and save scenes and files. But contains some more functionality. And when you integrate the file browser into a workspace then the header shows at the top. In the Shading workspace for example.



You can reveal the footer by clicking at the triangle button at the right.

And then you will see the footer bar. Which will reveal two menus. View and Select.



View Menu

Source List

Shows or hides the tool shelf at the left side.

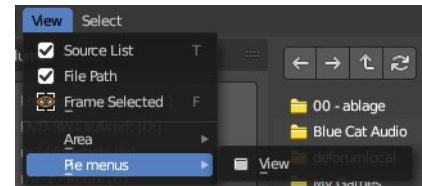

File Path

Shows the header region with the file path and the navigation and filter elements.

Frame selected

Centers the selected elements.

Area Menu

Area is a menu with window related settings.

Horizontal Split

Splits the editor horizontally into two editors.

Vertical Split

Splits the editor vertically into two editors.

Duplicate Area into new Window

Creates a floating window out of the current editor.

Toggle Maximize Area

Displays the editor maximized with menus.

To return to split view press hotkey Ctrl Up Arrow, or reuse the menu item in the View menu.

Close Area

Closes the area window.

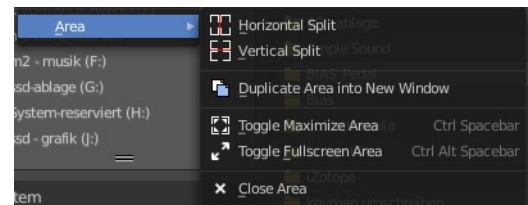

Pie Menu

Every editor usually has also a few pie menus that can be called by hotkeys. Here you can manage the hotkeys. And see which pie menus even exists.

View

Reveals the View pie menu.

Select menu

Box Select

Allows you to box select files. Note that this is an old obsolete operator. You don't need to press the hotkey anymore for box select.

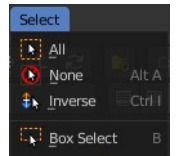

Inverse

Inverts the selection.

None

Select none.

All

Select all.

Files context menu

When you right click into the view at one of the browser items, then a files context menu opens. This menu comes from the File browser, and contains a few menu items that are not valid for the asset browser. Like create a folder. And the importer does not have the possibility to increase Number for example.

Back

Go to previous folder.

Forward

Go to next folder.

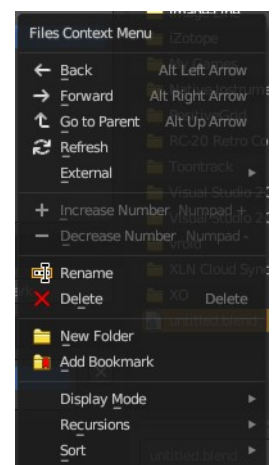

Go to Parent

Go upwards the hierarchy by one.

Refresh

Refresh the file list.

External submenu

The menu content differs, dependant from which editor you call the file browser, and which menu item is chosen.

Open

Opens the file in Bforartists.

Open Folder

Opens the folder that contains the file in the explorer.

Command Prompt Here

Opens the command prompt at the location of the file.

Properties

Shows the file properties.

Edit

Opens the file in the corresponding software that is defined as the software to open the file with. A bitmap with Windows Paint for example.

Print

Prints the file.

Play

Plays the selected file. A movie in the Windows Media Player for example.

Find

Search for files of this type.

Show

Show this file in the explorer

Browse

Browse this file.

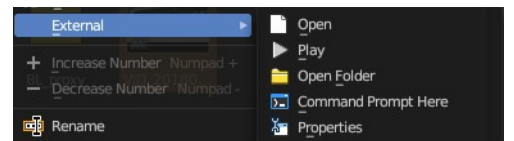
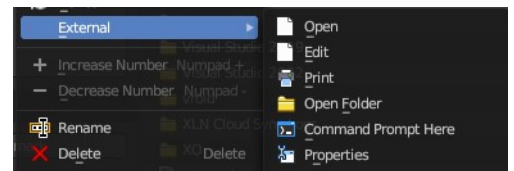
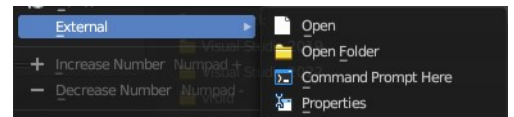
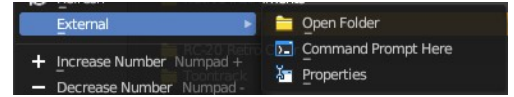

Preview

Preview this file.

Install

Install this file.

Runas

Run this file as a specific user.

Find in Folder

Search for items in this folder.

Increase Number

Increases the number at the selected data file in the file name edit box.

Decrease Number

Decreases the number at the selected data file in the file name edit box.

Rename

Rename the selected item.

Delete

Delete the selected item.

New Folder

Add a new folder.

Add Bookmark

Adds a bookmark in the file browser tool shelf in the Bookmark panel.

Display Mode

Display the content as a list or as icons.



Display Size

Set the display size of the file browser to four predefined sizes.



Recursion

Recursion is a menu where you can adjust how deep the explorer

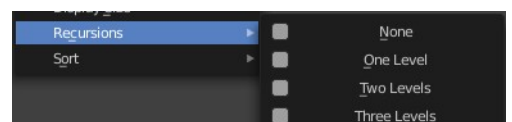

should dig. Normally it just lists the content of the currently selected directory. But it is also possible to list the content of the folders three levels lower.

The recursion direction is always downwards. Default is None.

Sort

Sort the content by the chosen method.





28 Editors - Asset Browser

Table of content

- Detailed table of content.....2
- Asset Browser.....5
- How to.....5
 - Asset handling.....5
 - Asset Library.....6
 - Drag n Drop of materials.....7
- Header.....7
- Header - View menu.....8
 - Source List.....8
 - File Path.....8
 - Frame Selected.....8
 - Display Size.....8
 - Area Menu.....8
- Header - Select menu.....9
 - Box Select.....9
 - Inverse.....9
 - None.....9
 - All.....9
- Header - Catalog menu.....9
 - Undo.....9
 - Redo.....9
 - Asset Library Paths.....10
 - Save Asset Catalogs.....10
 - New Asset Catalog.....10
- Header - Asset menu.....10
 - Paste as new asset.....10
 - Create Pose Asset.....10
- Header - Tools and Options.....10
 - Import Type.....11
 - Display Mode.....11
 - Size.....11
 - Search.....11
 - Filter.....11
 - Toggle Region.....11
 - Drop collection as Instances.....12
 - Import Method.....12
- Tool shelf.....12
 - Asset Library chooser.....12
 - Asset Catalogs.....13
 - Unassigned.....14
 - Asset catalog right click menus.....14
- Sidebar.....15
 - Name.....15
 - Info Panel.....15
 - Preview Panel.....15
 - Tags Panel.....16
- Assets context menu.....16

Refresh Asset Library.....	16
Clear Asset.....	16
Clear Asset (Set Fake User).....	16
Open Blend File.....	16
Display Size.....	16
Pose Assets context menu.....	17
Apply Pose.....	17
Apply Pose Flipped.....	17
Blend Pose.....	17
Select Pose Bones.....	17
Deselect Pose Bones.....	17
Assign Action.....	17

Detailed table of content

Detailed table of content

Detailed table of content.....	2
Asset Browser.....	5
How to.....	5
Asset handling.....	5
Asset Library.....	6
Drag n Drop of materials.....	7
Header.....	7
Header - View menu.....	8
Source List.....	8
File Path.....	8
Frame Selected.....	8
Display Size.....	8
Area Menu.....	8
Horizontal Split.....	8
Vertical Split.....	8
Duplicate Area into new Window.....	8
Toggle Maximize Area.....	8
Toggle Fullscreen Area.....	8
Close Area.....	9
Header - Select menu.....	9
Box Select.....	9
Inverse.....	9
None.....	9
All.....	9
Header - Catalog menu.....	9
Undo.....	9
Redo.....	9
Asset Library Paths.....	10
Save Asset Catalogs.....	10
New Asset Catalog.....	10
Header - Asset menu.....	10
Paste as new asset.....	10
Create Pose Asset.....	10

Header - Tools and Options.....	10
Import Type.....	11
Display Mode.....	11
Display mode options.....	11
Vertical and horizontal List.....	11
Columns.....	11
Size.....	11
Search.....	11
Filter.....	11
Toggle Region.....	11
Drop collection as Instances.....	12
Import Method.....	12
Follow Preferences.....	12
Link.....	12
Append.....	12
Append (Reuse Data).....	12
Tool shelf.....	12
Asset Library chooser.....	12
Current File.....	12
User Library.....	13
Refresh.....	13
Asset Catalogs.....	13
Save Asset Catalogs.....	13
New Asset Catalog.....	13
Unassigned.....	14
Asset catalog right click menus.....	14
Right clicking at the All item.....	14
Mark as asset.....	14
Clear Asset.....	14
Right clicking at one of the catalog items.....	14
New Catalog.....	14
Delete catalog.....	14
Rename.....	14
Mark as asset.....	14
Clear Asset.....	14
Sidebar.....	15
Name.....	15
Info Panel.....	15
Source.....	15
Description.....	15
Author.....	15
Preview Panel.....	15
Load Custom Preview.....	15
Generate Preview.....	15
Tags Panel.....	16
Tags List.....	16
Drag handler.....	16
Search.....	16
Add Asset Tag.....	16
Remove Asset Tag.....	16
Assets context menu.....	16
Refresh Asset Library.....	16
Clear Asset.....	16

Clear Asset (Set Fake User).....	16
Open Blend File.....	16
Display Size.....	16
Pose Assets context menu.....	17
Apply Pose.....	17
Apply Pose Flipped.....	17
Blend Pose.....	17
Select Pose Bones.....	17
Deselect Pose Bones.....	17
Assign Action.....	17

Asset Browser

The Asset browser is an explorer dialog that allows you to store assets, and reuse them at a later point.

Assets can be everything. Objects, scenes, grease pencil strokes and so on.

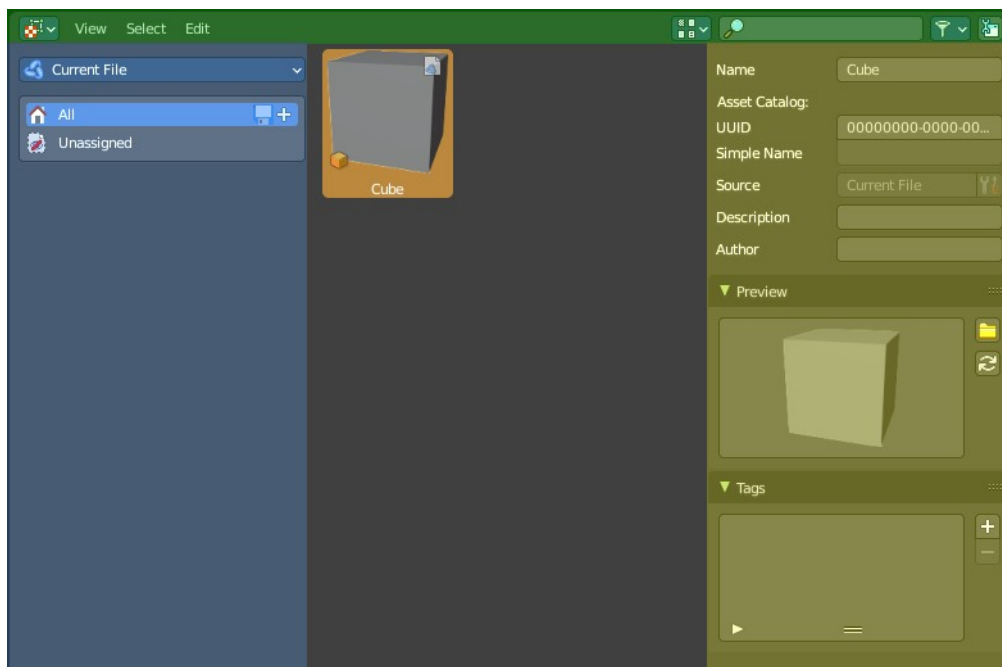

The asset browser interface is divided into several areas.

Header (green)

Categories (blue)

Sidebar (yellow)

Content area (no color)

How to

Asset handling

To insert or remove an asset you can use the right click menu in the outliner. Or the object menu in the 3d viewport. Mark Asset and Clear Asset.

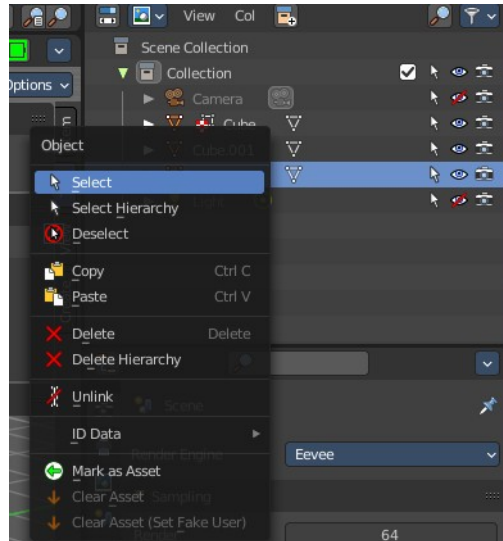
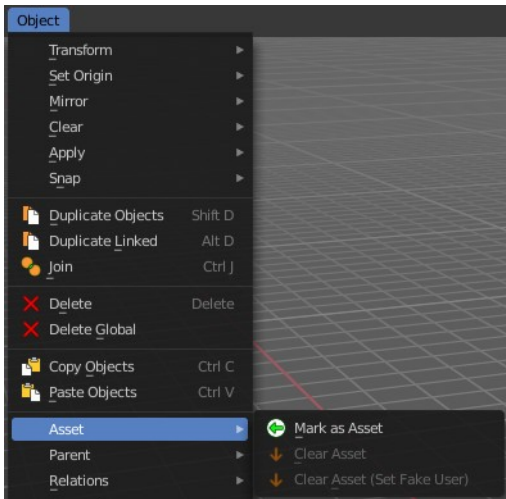

When it is something like a material or a texture, then you can also right click at the menu in the data prop. This will also reveal a menu where you can add or remove the asset.

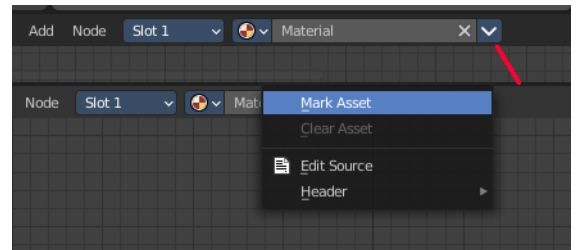

Dragging items into the browser is currently not supported. The other direction works though. You can drag assets from the browser into the 3d view.

Poses can be inserted in pose mode. But how is currently not documented.

Asset Library

There are two ways to deal with assets. You can either store them in the current blend file for later use. This is the “Current file” method.

Or you can switch to “User Library”, and/or create an external library from a fixed path.

If you’d like to view all, select the “All” category.

To setup your external library, go to Preferences > File Paths > Asset Libraries to add this path to your asset libraries then. You can also do the same from header menu Catalog > Asset Library Paths.

You can add more than one asset library from the preferences.

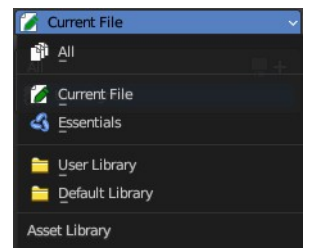

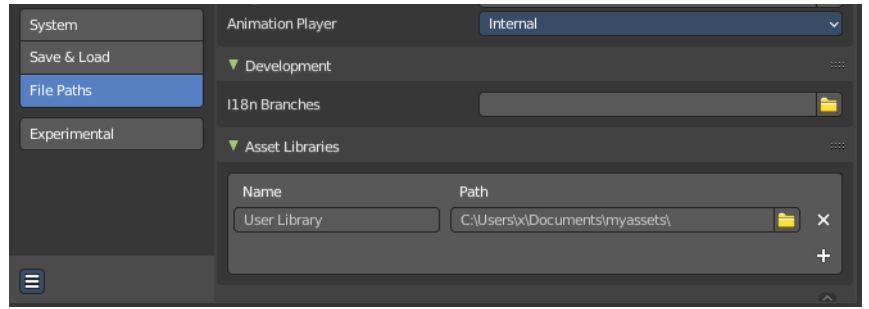
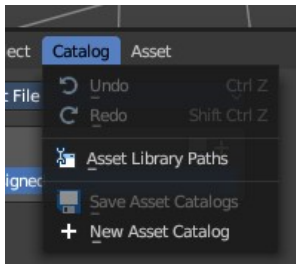

Drag n Drop of

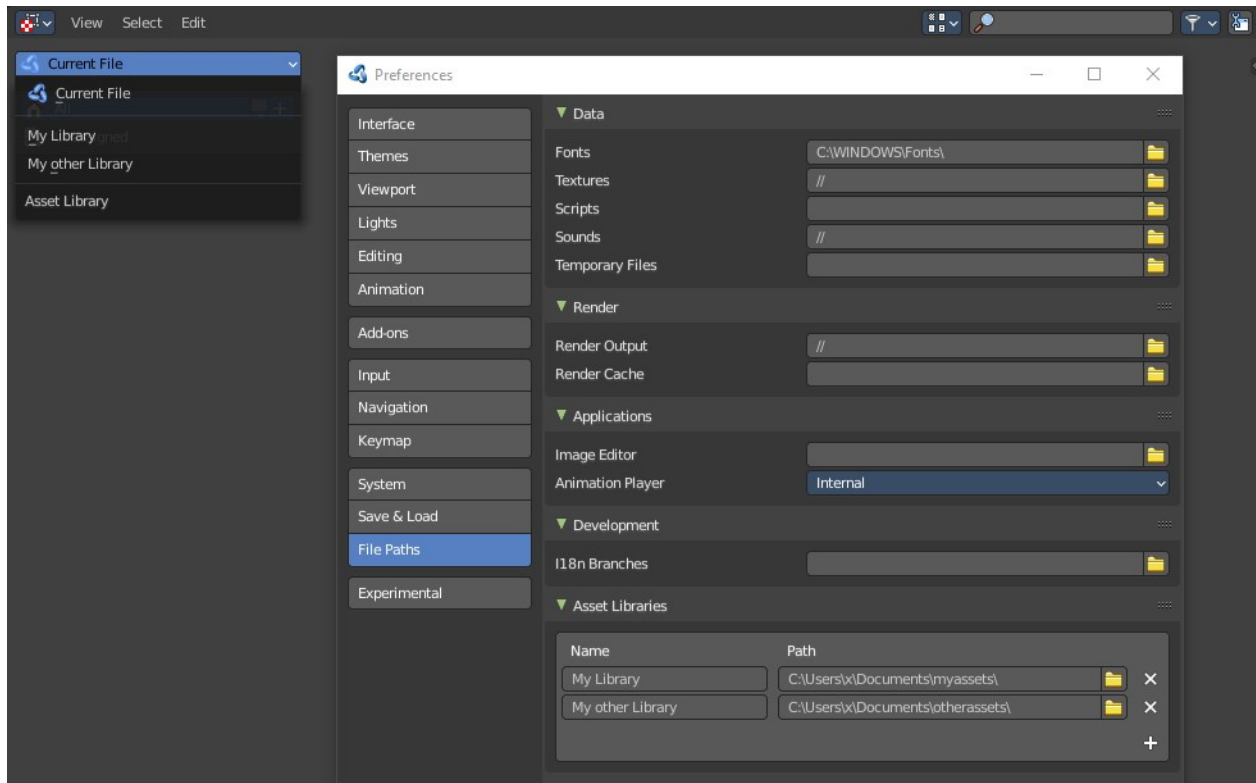

materials

Materials can be dragged directly at the material slots in the Properties Editor.

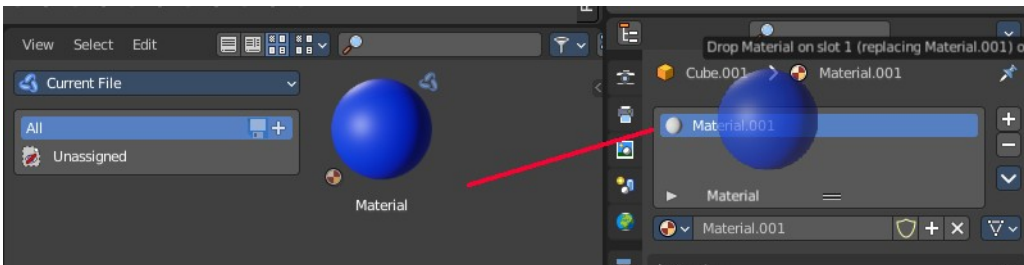

Header



There are several tools in the header to find. Menus, and a few options.

Header - View menu

The view menu contains view related functionality.

Source List

Shows or hides the tool shelf at the left side.

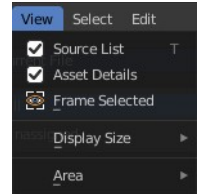

File Path

Please ignore. This entry is a bug. The asset browser shares the code with the file browser.

Frame Selected

Scrolls the selection into view.

Display Size

The display size for the assets.

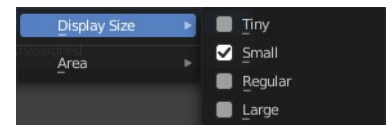

Area Menu

Area is a menu with window related settings.

Horizontal Split

Splits the editor horizontally into two editors.

Vertical Split

Splits the editor vertically into two editors.

Duplicate Area into new Window

Creates a floating window out of the current editor.

Toggle Maximize Area

Displays the editor maximized with menus.

To return to split view press hotkey Ctrl Up Arrow, or reuse the menu item in the View menu.

Toggle Fullscreen Area

Displays the editor maximized without menus.

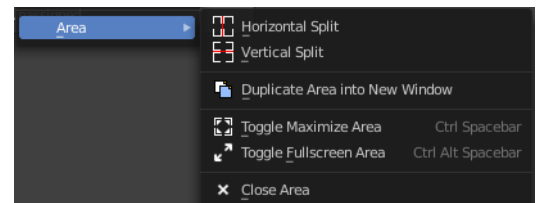

To return from the full screen view press hotkey Alt F10, or use the little button that appears up right when you move the mouse in this corner.

Close Area

Closes the editor.

Header - Select menu

Select functionality.

Box Select

Allows you to box select files. Note that this is an old obsolete operator. You don't need to press the hotkey anymore for box select.

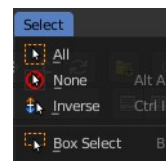

Inverse

Inverts the selection.

None

Select none.

All

Select all.

Header - Catalog menu

Undo

Undo of the last edit operation.

Redo

Redo of the last edit operation.

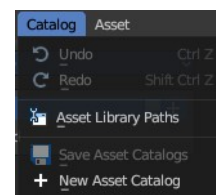

Asset Library Paths

Opens the file browser at the Paths tab. Here you can show, edit, and add paths to new asset libraries.

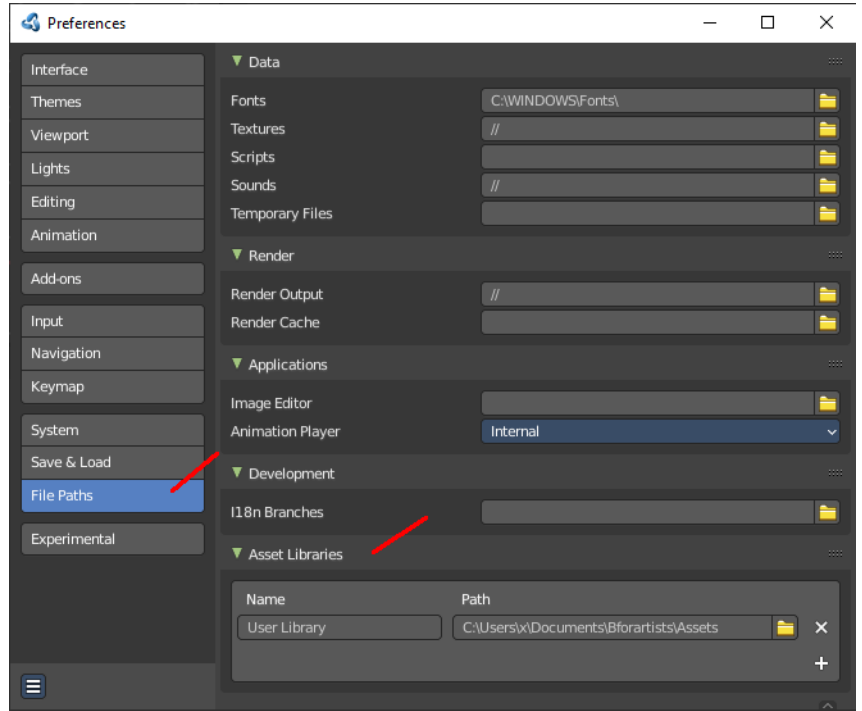

Save Asset Catalogs

Save all changed asset catalogs.

New Asset Catalog

Add a new asset catalog.

Header - Asset menu

This menu contains asset related menu items.

Paste as new asset

Pastes a previously copied asset.

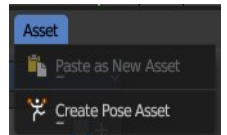

Create Pose Asset

Creates a pose asset from the selected armature. You need to be in pose mode in the 3d view to activate this menu item.

Header - Tools and Options



Import Type

Just with a user library. Allows you to define how to import the assets.

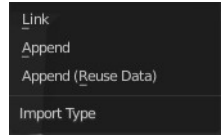

Display Mode

Allows you to switch between list view and thumbnail preview view.



Display mode options

Vertical and horizontal List

Columns

What info to show for the assets.

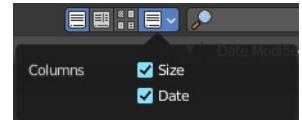

Size

The display size of the thumbnails for the assets. The range for these thumbnails goes from tiny with 64 pixels up to large with 256 pixels.

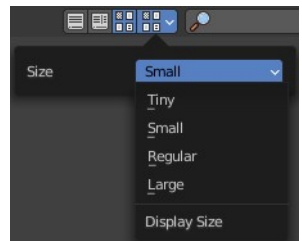

Search

Name Filter. Allows you to search for specific files and folders.



Filter

Allows you to filter the assets library in various ways. The menu items should be self explaining.

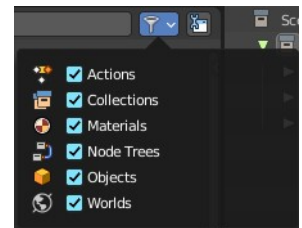

Toggle Region

Toggles the sidebar at the right. The sidebar contains various im- and export settings for the single file types.

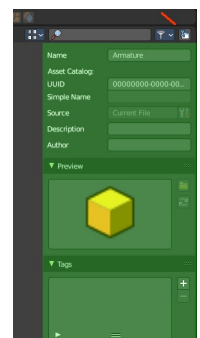

Drop collection as Instances

When it's on, you link collections as instances. When off, it links to scene. Default is off.

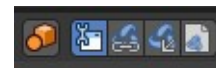

Import Method

Follow Preferences

Use the import method set in the Preferences for this asset library, don't override it.

Link

Import the assets as linked data

Append

Import the assets as copied data, with no link to the original asset data

Append (Reuse Data)

Import the assets as copied data-block while avoiding multiple copies of nested, typically heavy data. For example the textures of a material asset, or the mesh of an object asset, don't have to be copied every time this asset is imported. The instances of the asset share the data instead.

Tool shelf

The toolshelf shows the different catalogs that you can use to store your assets.

These catalogs are currently dysfunctional. You can just add or remove the categories. But not insert assets to it.

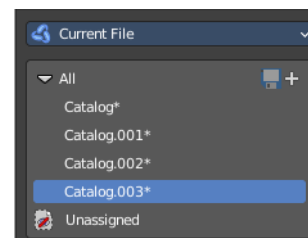

Asset Library chooser

Here you can choose what asset library to use.

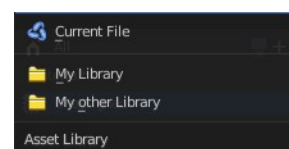

Current File

Uses the current Blend file as the asset library. All assets are stored into the current blend file. And this means that when you remove objects from the scene, then the assets in the assets library will also vanish.

User Library

Uses the blend file in the path that is defined in the user preferences as the asset library.

Working with more than one blend file is currently not supported.

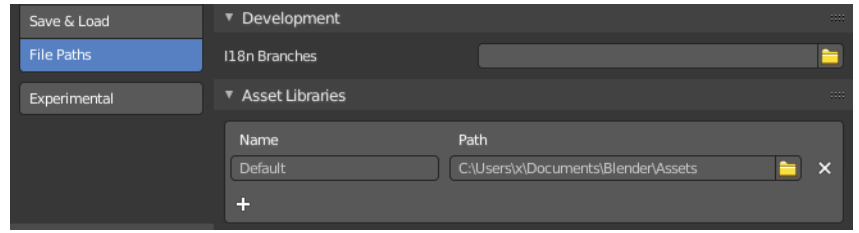

Refresh

With a user library you will get a refresh button besides the asset library chooser. Refreshes the content.

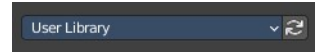

Asset Catalogs

Asset catalogs allows you to organize your assets.

Note that asset catalogs does not work with the external asset libraries. Just with the asset library in the current file.

First save your file. The method does not work at a blend file that is not saved yet.

Then create your catalog, and name them.

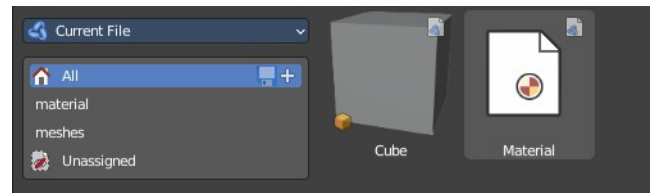

Then select one of your assets. And drag it onto the catalog that you want to add it to.

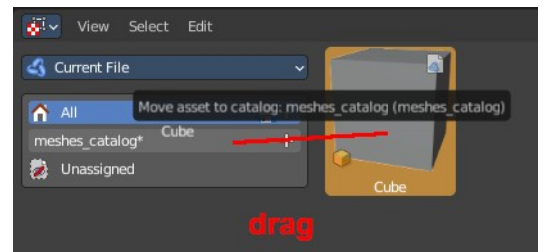

Finally, save the asset.

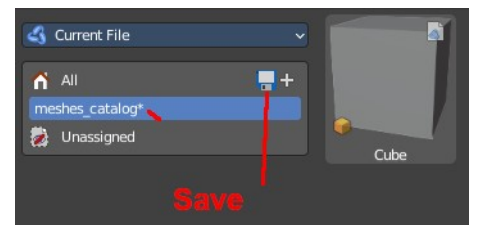

Save Asset Catalogs

Saves the current asset catalog to file and make the changes permanent.

New Asset Catalog

Creates a new asset catalog. Asset catalogs can be nested too.

Unassigned

The assets that are currently not in a catalog.

Asset catalog right click menus

Note that the Edit Source button is a developer feature.

Right clicking at the All item

Mark as asset

Marks the object as an asset. Dysfunctional in this context.



Clear Asset

Removes all assets.

Right clicking at one of the catalog items

Content depends if you have an asset selected or not.

New Catalog

Creates a new nested catalog inside of the current catalog.

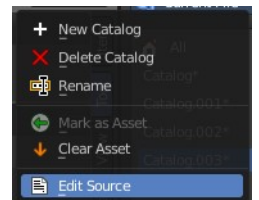
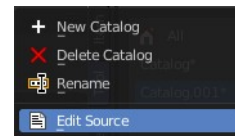

Delete catalog

Deletes the catalog and all of its childs.

Rename

Rename the current catalog.

Mark as asset

Marks the object as an asset. Dysfunctional in this context.

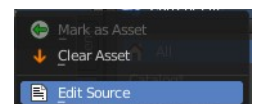

Clear Asset

Removes all assets.

Sidebar

At the right side you will find the Sidebar. It is usually hidden. But can be revealed by a click at the little triangle button, or with a click at the Toggle Region button in the header at the right.

Name

The name of the asset. Here you can also rename the asset. Note that the name of the asset in the view does not refresh immediately at the moment. You can force a refresh of it in the Preview panel by clicking at the Generate Preview button

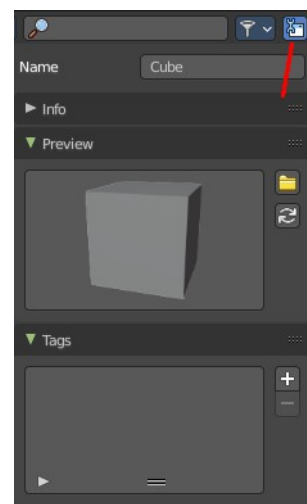

Info Panel

Some additional infos about the asset.

Source

A source that can't be edited for the Blender developers.

Description

Add a description for the asset.

Author

Add the name of the author of the asset.

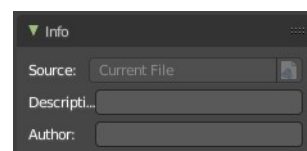

Preview Panel

A preview of the asset. By default the same image that you see in the view when you create the asset.

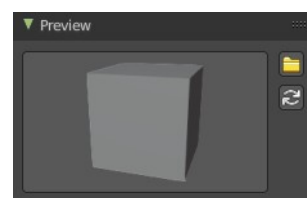

Load Custom Preview

Opens a file browser where you can choose a custom icon for this asset.

Generate Preview

Generates a preview icon from the content. Note that this will reset the custom icon.

Tags Panel

Enter custom tags for this asset. This tags allows you to sort your assets by tag.

Tags List

The list of the current tags.

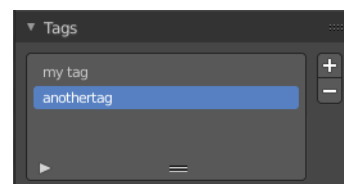

Drag handler

Allows you to resize the list.

Search

Search the list. This search can be expanded by clicking at the little triangle button down left.



Add Asset Tag

Adds a tag to the tag list. This tag can be renamed in the list.

Remove Asset Tag

Removes the selected tag from the tag list.

Assets context menu

When you right click into the view then an Asset context menu opens.

Refresh Asset Library

Refresh the file list.

Clear Asset

Removes the asset from the asset library.

Clear Asset (Set Fake User)

Removes the asset from the asset library. But sets it to fake user, so that it remains in the scene.

Open Blend File

Opens the path for the blend file that contains the active asset. Just active with User Library.

Display Size

Set the display size of the file browser to four predefined sizes.

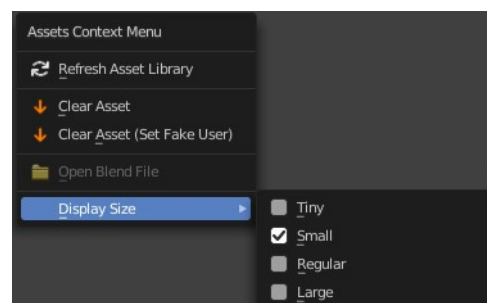

Pose Assets context menu

When you right click on a pose asset in the Asset Browser, you get extra options to help apply the pose. To use them, make sure you have a compatible armature selected, are in Pose Mode and have the bones you'd like to pose selected.

Note: Pose action assets are single keyframe action clips marked as assets either from the NLA or the Dopesheet editors. Animation keyframe sequences cannot be marked as assets.

Apply Pose

Apply the given pose action to the active rig. When you select this, this will apply the pose to selected bones.

Apply Pose Flipped

Apply the given pose action to the active rig with a flipped axis. When you select this, this will apply the flipped pose to selected bones. Flipping happens usually from bones labeled .L and .R

Blend Pose

Blend the given pose action to the active rig. This is useful to interpolate from the original pose to the new pose. When using, you will see a slider in the asset browser header giving you a degree of blend.

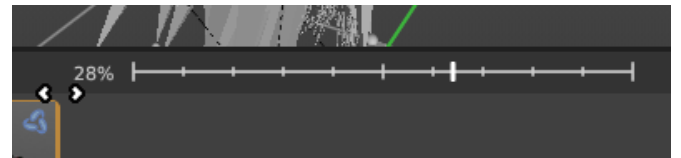

Select Pose Bones

Select those bones used in this pose action. This will select all the necessary bones you need to apply the pose effectively. If you have no bones selected, the pose will not apply. Poses only apply to bones that are selected.

Deselect Pose Bones

Deselect those bones used in this pose action. This will ultimately clear the selection based on the pose action bones defined in the marked action clip.

Assign Action

Set the pose action as the active action on the active object. This will ultimately load the pose action animation clip to the Action Editor of the Dopesheet, allowing you to edit the pose. This only works in the source file with the marked poses.



28.1 Asset Browser – Default Asset Library

Table of content

Default Asset Library.....	1
The Asset Browser.....	1
Library Contents.....	1
Categories.....	2
Simple Usage.....	3
Preparation.....	3
Load Assets.....	3
The available light set-ups.....	4

Default Asset Library

Bforartists comes with a default asset library – registered by addon. This is enabled by default. With this asset library you can find numerous default assets to get you up and running with your art quickly and efficiently.

The Asset Browser

The Asset Browser is an editor in the Asset Workspace that gives you some standard lighting settings for the Cycles and Eevee renderer, objects in collections, node groups, materials and more. It contains for example the classical three-point setup. But also some basic volumetrics examples – or a shader ball or color checker reference stand.

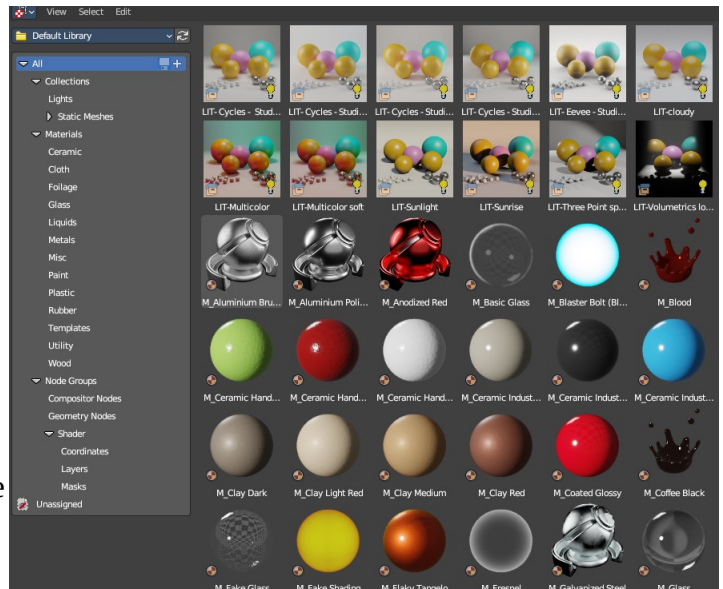

The default library addon can be turned off in the User Preferences.

Note that the Eevee light setup is rudimentary. Eevee is a realtime render engine. To achieve more realistic results you may want to use Light probes, and bake the lights and shadows. This cannot be done by the addon though. Light probes requires a scene, light and object specific setup.

Library Contents

To select the Default Library, choose it from drop-down box that contains the libraries that comes with Bforartists. Here you can select what asset you want to load.

The assets are grouped by categories.

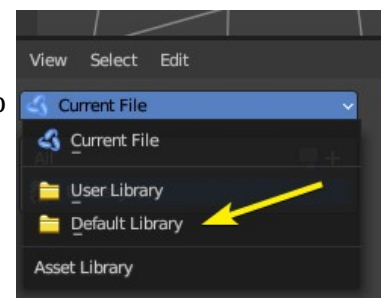

Categories

- Collections
 - Lights
 - Static Meshes
 - Backgrounds
 - Utility
- Materials
 - Ceramic
 - Cloth
 - Foilage
 - Glass
 - Liquids
 - Metals
 - Misc
 - Paint
 - Plastic
 - Rubber
 - Templates
 - Utility
 - Wood
- Node groups
 - Compositor Nodes
 - Geometry Nodes
 - Shader
 - Coordinates
 - Layers
 - Masks

Simple Usage

Preparation

Select the Assets Workspace or alternatively change and editor by toggling the Hide Editor Type and changing it to the Asset Browser.

Once you have an asset browser open, select the Default Library from the drop down to the top left of the editor.

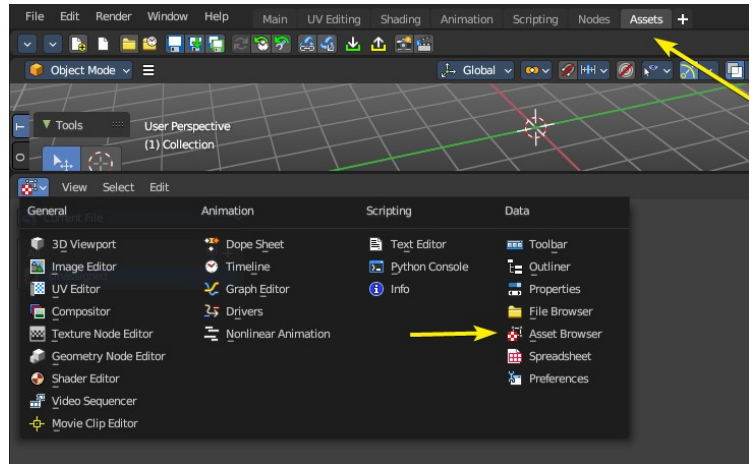

If you don't see any assets, press the refresh icon.

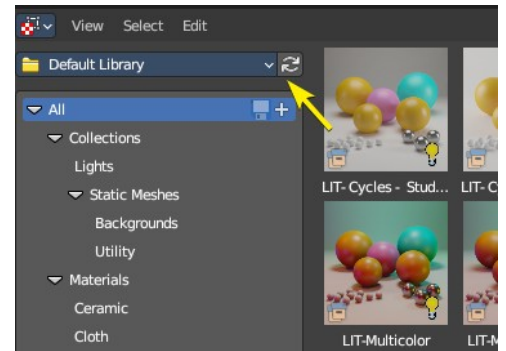

Loading Assets

Click on any categories in the left sidebar, then click and drag on an item to then add it into either the Node editors or the 3D View.

The asset and editor context may influence where you can drag and drop. Example: A collection can only be added to the 3D Viewport, but a Node Group can only be added to the Node Editor in the correct mode (Shader, Geometry Nodes, etc)

You can also drag and drop the assets onto data slots.

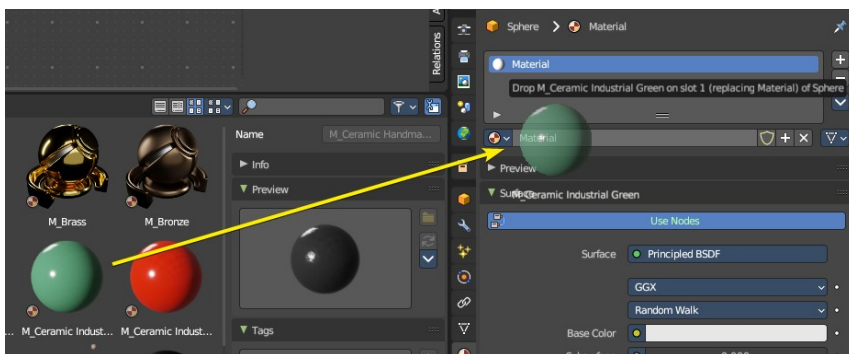
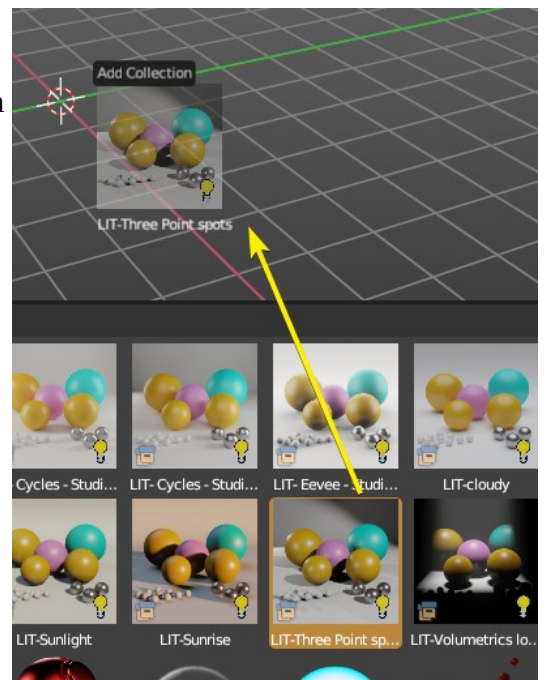

The available light set-ups

Here you can get an overview how the result looks like for the different lighting set-ups. Note that just the Cycles results are showing here.

Be careful with the volumetrics examples. Especially the Musgrave example can render eons.

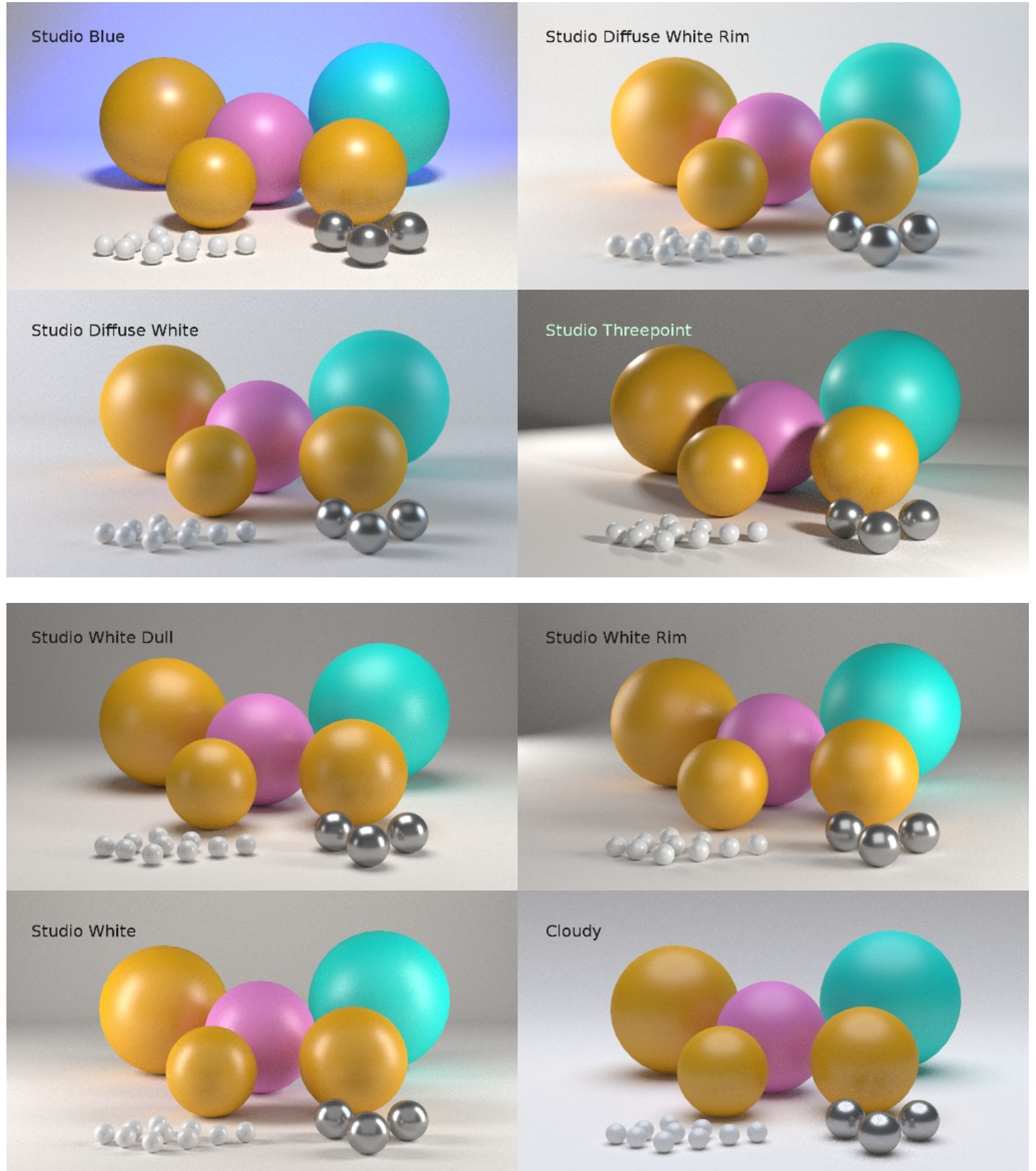

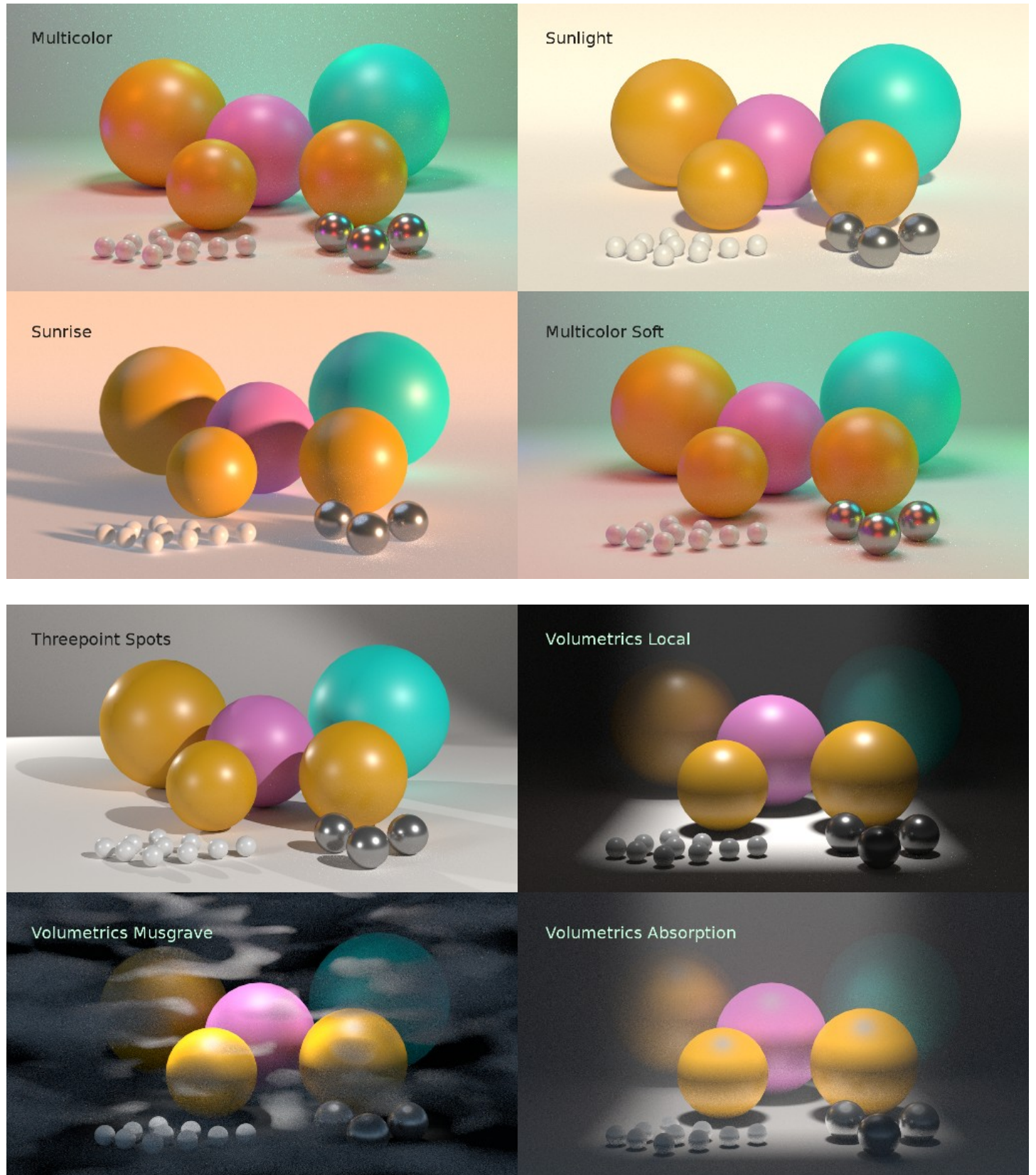



29 Editors - Spreadsheet

Table of content

- Spreadsheet.....2
- Editortype Menu.....2
- Header tools and options.....2
 - Object Evaluation State.....2
 - Evaluated.....3
 - Original.....3
 - Node.....3
 - Geometry Component Type.....3
 - Mesh.....3
 - Point Cloud.....3
 - Instances.....3
 - Attribute Domain.....3
 - Vertex.....3
 - Edge.....3
 - Face.....3
 - Face Corner.....3
 - Toggle Pin.....3
 - Name of the object.....4
 - Selected Only.....4
 - Row Filter.....4
- Tool Shelf.....4
- Main region.....4
- Sidebar.....4
 - Row filter panel.....5
 - Header.....5
 - Enabled.....5
 - Title string.....5
 - Remove Row Filter.....5
 - Drag handler.....5
 - Panel content.....5
 - Column.....5
 - Operation.....5
 - Value.....5
 - Threshold.....5
- Footer.....5

Spreadsheet

The Spreadsheet Editor allows you to inspect geometry attributes.

The geometry nodes editor allows you to especially inspect specific nodes and their output.

Geometry nodes have a switch for that in the header, which can be turned on or off.

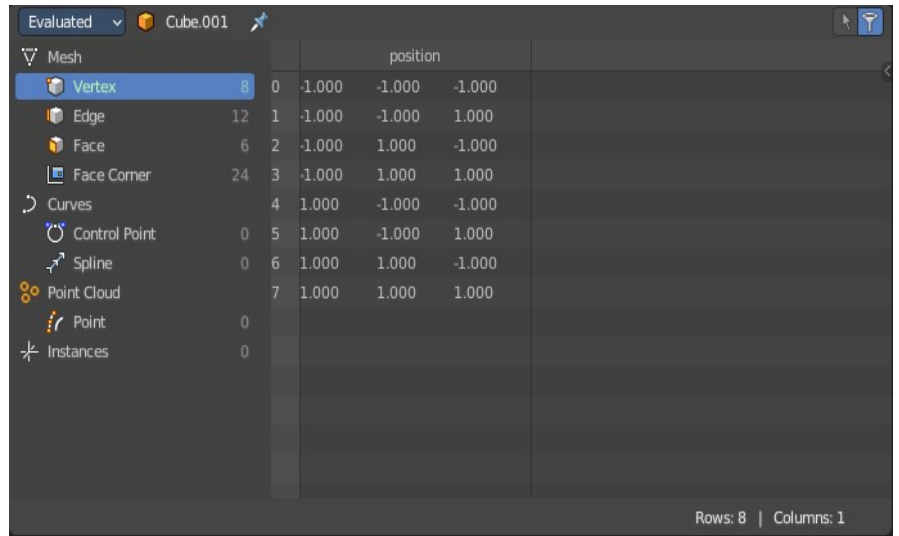

Editortype Menu

Bforartists is made of several editor types. Headers can display a menu where you can switch to other editor types.

This menu is hidden by default. It is meant to edit the layouts, and should not be necessary for regular work. You can reveal it in the header right click menu.

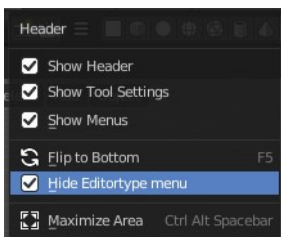
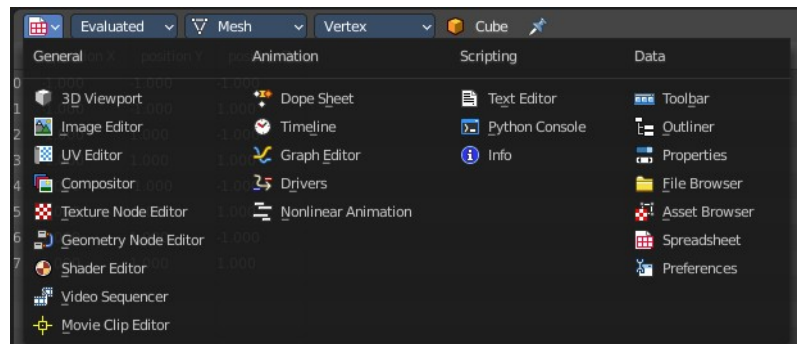

Header tools and options

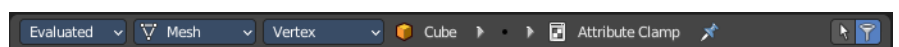

Object Evaluation State

Display the data of an object at different states of its evaluation.

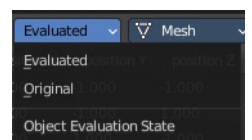

Evaluated

Display the data from object with all modifiers applied.

Original

Display the data from original object without any modifiers applied.

Node

Display the data from the currently active node in the geometry node editor. The active node has the Geometry node output icon in the header on.

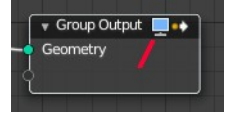

Geometry Component Type

Part of the geometry to display data from.

Mesh

Mesh component containing point, corner, face and edge data.

Point Cloud

Point cloud component containing only point data.

Instances

Display which objects and collections are instanced and their transforms.

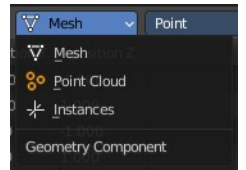

Attribute Domain

Attribute domain to display.

Vertex

Display attributes that are stored per vertex.

Edge

Display attributes that are stored per edge.

Face

Display attributes that are stored per face.

Face Corner

Display attributes that are stored per face corner.

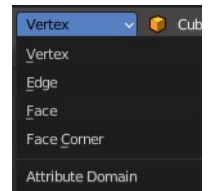

Toggle Pin

Keep the data from the pinned object visible, even when another object becomes the active one.

Name of the object

The name of the selected object. This is a breadcrumb menu. It can be collapsed.

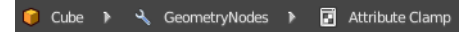

Selected Only

This option is only available if the object is in Edit Mode. When checked, only data for the selected mesh elements is shown.



Row Filter

Turn on or off the row filters defined in the sidebar.

Tool Shelf

The tool shelf allows you to filter out the data that you want to look at.

▼ Mesh		shade_smooth	material_index	normal		
Vertex	8	<input type="checkbox"/>	0	-1.000	-0.000	0.000
Edge	12	<input type="checkbox"/>	0	0.000	1.000	0.000
Face	6	<input type="checkbox"/>	0	1.000	-0.000	0.000
Face Corner	24	<input type="checkbox"/>	0	0.000	-1.000	0.000
Curves	4	<input type="checkbox"/>	0	0.000	0.000	-1.000
Control Point	0	<input type="checkbox"/>	0	0.000	-0.000	1.000
Spline	0					
Point Cloud						
Point	0					
Instances	0					

Main region

Displays the list of the actual content. This content is dependant of the chosen data types.

	position X	position Y	position Z
0	-1.000	-1.000	-1.000
1	-1.000	-1.000	1.000
2	-1.000	1.000	-1.000
3	-1.000	1.000	1.000
4	1.000	-1.000	-1.000
5	1.000	-1.000	1.000
6	1.000	1.000	-1.000
7	1.000	1.000	1.000

Sidebar

Here you can define row filters to filter out values in the corresponding columns and rows that you don't want to display.

The filter can then be turned off and on with the filter button in the header.

Note that the sidebar is closed by default. Click at the little triangle button to open it.

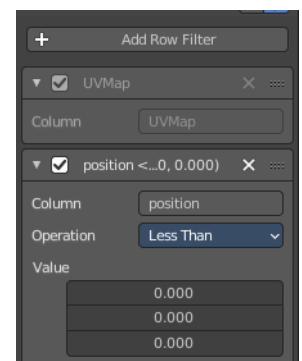
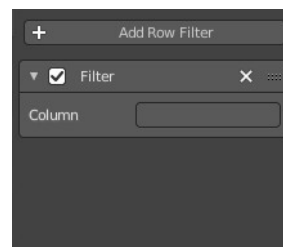

To create a filter, press the Add Row Filter button, then write the column type you would like to filter.

Row filter panel

Header

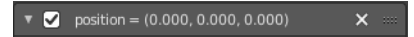

The header allows you to close and open the filter panel by clicking at the triangle button at the front.

Enabled

Enable or disable this filter

Title string

Some rows provides you with further informations in the header. In this case the position of the original geometry.

Remove Row Filter

Removes the filter.

Drag handler

This handler allows you to reorder the panel above or below other panels.

Panel content

Column

To filter out a row you need to type in the name of the row. Attention, this name is case sensitive.

Operation

The filter method to filter out values.

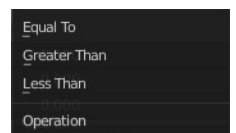

Value

The vector values allows you to set a base value for the single vectors. A position has for example 3 values. A UV map is 2d, and so you just have two values.

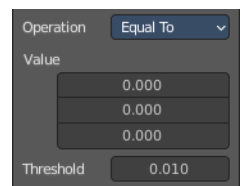

Threshold

Just with operation method Equal to.

Allows you to define a threshold in which the "equal to" operation is evaluated. So that a value of 10.001 is still considered as in range for a value of 10 for example.

Footer

The status bar in the footer shows how



many rows and columns there are and how many have been filtered out.



30 Editors - Preferences

Table of content

Detailed Table of content.....	2
Preferences.....	9
Navigation Sidebar.....	9
Interface Tab.....	10
Display Panel.....	10
Editors Panel.....	11
Translation Panel.....	12
Text Rendering Panel.....	13
Interface Font.....	14
Monospace Font.....	14
Menus Panel.....	14
Pie Menus.....	14
Themes.....	15
Presets.....	15
Install.....	16
Reset.....	16
List of Editors.....	16
Viewport.....	16
Display.....	16
Quality.....	17
Textures.....	18
Selection.....	19
Lights.....	19
Studio Lights.....	19
MatCaps.....	20
LookDevHDRI's.....	21
Editing.....	21
Objects.....	21
3D Cursor.....	22
Annotations.....	23
Weight Paint.....	23
Grease Pencil.....	24
Text.....	25
Node.....	25
Miscellaneous.....	25
Animation.....	25
Timeline.....	26
Addons.....	28
Header.....	29
Input.....	30
Keyboard.....	30
Mouse.....	30
Tablet.....	31
Touchpad.....	31
NDOF.....	31
Navigation.....	32
Orbit & Pan.....	32

Zoom.....	33
Fly & Walk.....	34
Keymap.....	35
Header.....	35
Key map Editor.....	36
System.....	38
Cycles Render Devices.....	38
Operating System Settings.....	38
Memory and Limits.....	39
Video Sequencer.....	39
Sound.....	40
Save & Load.....	42
Blend Files.....	42
File Browser.....	44
File Paths.....	44
Data.....	44
Script Directories.....	45
Render.....	45
Applications.....	45
Development.....	46
Asset Libraries.....	46
Experimental.....	47

Detailed Table of content

Detailed table of content

Detailed Table of content.....	2
Preferences.....	9
Navigation Sidebar.....	9
Save Preferences menu.....	9
Auto Save preferences.....	9
Save current State.....	9
Revert to Saved.....	9
Load Factory Settings.....	9
Interface Tab.....	10
Display Panel.....	10
Resolution Scale.....	10
Line Width.....	10
Viewport Line Width.....	10
Splash Screen.....	10
Tool tips.....	11
Python Tool tips.....	11
Developer Extras.....	11
Editors Panel.....	11
Region Overlap.....	11
Color Picker Type.....	11
Header Position.....	11
Factor Display Type.....	12
Temporary Editors subpanel.....	12
Render in.....	12

File browser.....	12
Status Bar subpanel.....	12
Translation Panel.....	12
Language.....	12
Tool tips.....	12
Interface.....	12
New Data.....	12
Text Rendering Panel.....	13
Anti Aliasing.....	14
Hinting.....	14
Interface Font.....	14
Monospace Font.....	14
Menus Panel.....	14
Open on Mouse Over.....	14
Top Level.....	14
Sub Level.....	14
Pie Menus.....	14
Animation Timeout.....	14
Top Key Timeout.....	14
Recenter Timeout.....	14
Radius.....	14
Threshold.....	15
Confirm Threshold.....	15
Themes.....	15
Presets.....	15
Create new Theme.....	15
Install.....	16
Reset.....	16
List of Editors.....	16
Viewport.....	16
Display.....	16
Text Info Overlay.....	16
Object Info.....	16
View Name.....	17
Playback FPS.....	17
Gizmo Size.....	17
Object Origin Size.....	17
3D Viewport Axis.....	17
Off.....	17
Simple Axis.....	17
Size.....	17
Brightness.....	17
Interactive Navigation.....	17
Size.....	17
Quality.....	18
Viewport Anti-Aliasing.....	18
Multi sampling.....	18
Grease Pencil Multi sampling.....	18
Edit Mode Smooth Wires.....	18
Textures.....	18
Limit Size.....	18
Anisotropic Filtering.....	18
Clip Alpha.....	18

Image Display Method.....	18
Selection.....	19
Lights.....	19
Studio Lights.....	19
Install.....	19
Preview Window.....	19
Delete Studio Light.....	20
Copy Studio Light settings to the Studio Light Editor.....	20
Edit Studio Light.....	20
Save as Studio Light.....	20
Use Light.....	20
Diffuse.....	20
Specular.....	20
Smooth.....	20
Direction.....	20
MatCaps.....	20
LookDevHDRI's.....	21
Editing.....	21
Objects.....	22
New Objects.....	22
Link Materials To.....	22
ObData.....	22
Object.....	22
Align To.....	22
World.....	22
View.....	22
Enter Edit Mode.....	22
Instance Empty Size.....	22
Duplicate Data.....	22
3D Cursor.....	22
Cursor Surface Project.....	22
Cursor Lock Adjust.....	23
Annotations.....	23
Default Color.....	23
Eraser radius.....	23
Simplify Stroke.....	23
Weight Paint.....	23
Use Custom Colors.....	23
Tools Menu.....	23
Background Color.....	24
Gradient Stroke Mode.....	24
Grease Pencil.....	24
Manhattan Distance.....	24
Euclidean Distance.....	25
Miscellaneous.....	25
Sculpt Overlay Color.....	25
Node Auto Offset Margin.....	25
Animation.....	25
Timeline.....	26
Allow negative Frames.....	26
Minimum Grid Spacing.....	26
Time Code Style.....	26
Zoom To Frame Type.....	26

Keyframes.....	26
Visual Keying.....	26
Only Insert Needed.....	27
Auto Keyframing.....	27
Show Warning.....	27
Only Insert Available.....	27
Enable in new scenes.....	27
F-Curves.....	27
Unselected Opacity.....	27
Default Smoothing Mode.....	27
Default Interpolation.....	27
Default Handles.....	27
XYZ to RGB.....	28
Channel Group Colors.....	28
Only Show Selected F-Curve Keyframes.....	28
F-Curve High Quality Drawing.....	28
Addons.....	28
Header.....	28
Official / Community / Testing.....	28
Install Add-on.....	29
Refresh.....	29
Category.....	29
Search.....	29
List of Addons.....	29
Input.....	29
Keyboard.....	29
Emulate Numpad.....	29
Default to advanced numeric input.....	30
Mouse.....	30
Emulate 3 Button Mouse.....	30
Tablet.....	30
Tablet API.....	30
Max Threshold.....	30
Softness.....	30
Touchpad.....	31
Multi Touch Gestures.....	31
NDOF.....	31
Pan Sensitivity.....	31
Orbit Sensitivity.....	31
Deadzone.....	31
Navigation.....	31
Rotation.....	31
Show Navigation Guide.....	31
Invert Zoom.....	31
Lock Camera Pan/Zoom.....	31
Pan Swap Y and X Axes.....	31
Invert Axis Pan.....	31
Orbit.....	32
Fly / Walk.....	32
Lock Horizon.....	32
Helicopter Mode.....	32
Navigation.....	32
Orbit & Pan.....	32

Orbit Method.....	32
Orbit around selection.....	32
Auto Perspective.....	32
Auto Depth.....	33
Smooth View.....	33
Rotation Angle.....	33
Zoom.....	33
Zoom Method.....	33
Continue.....	33
Dolly.....	33
Scale.....	33
Zoom Axis.....	33
Invert Mouse Zoom Direction.....	33
Invert Wheel Zoom Direction.....	33
Zoom to Mouse Position.....	34
Fly & Walk.....	34
View Navigation.....	34
Walk.....	34
Reverse Mouse.....	34
Mouse Sensitivity.....	34
Teleport Duration.....	34
Walk Speed.....	34
Speed Factor.....	34
Gravity.....	34
View Height.....	34
Jump Height.....	35
Fly.....	35
Keymap.....	35
Header.....	35
Key Configs.....	35
Import.....	35
Export.....	36
Filter Type.....	36
Search Field.....	36
Key map Editor.....	36
Map Type.....	36
Type of Event.....	36
Operator.....	36
Type of Event.....	36
Value.....	37
Secondary hotkeys.....	37
Specific settings.....	37
Restore.....	37
System.....	37
Cycles Render Devices.....	38
None.....	38
CUDA.....	38
OptiX.....	38
HIP.....	38
oneAPI.....	38
Operating System Settings.....	38
Make default.....	38
Memory and Limits.....	39

Undo Steps.....	39
Undo Memory Limit.....	39
Global Undo.....	39
Console Scrollback Lines.....	39
Texture Time Out.....	39
Garbage Collection Rate.....	39
VBO Time Out.....	39
Garbage Collection Rate.....	39
Video Sequencer.....	39
Memory Cache Limit.....	39
Use Disk Cache.....	39
Directory.....	40
Cache Limit.....	40
Compression.....	40
Proxy Setup.....	40
Automatic.....	40
Manual.....	40
Sound.....	40
Audio Device.....	40
OpenAL.....	40
OpenAL - OpenAL Soft.....	40
SDL.....	40
Null.....	40
Channels.....	41
Mixing Buffer.....	41
Sample Rate.....	41
Sample Format.....	41
Save & Load.....	41
Blend Files.....	41
Relative Paths.....	41
Compress File.....	41
Load UI.....	42
File Preview.....	42
None.....	42
Auto.....	42
Screenshot.....	42
Camera Preview.....	42
Tabs as Spaces.....	42
Save Prompt.....	42
Save Versions.....	42
Recent Files.....	43
Auto Save.....	43
Auto Save Temporary File.....	43
Timer.....	43
Auto Run Python Scripts.....	43
Excluded paths.....	43
File Browser.....	43
Filter Files.....	43
Show Hidden File/Data.....	43
Show Recent Locations.....	44
Show System Bookmarks.....	44
File Paths.....	44
Data.....	44

Fonts.....	44
Textures.....	44
Sounds.....	44
Temporary Files.....	44
Script Directories.....	44
Render.....	45
Render Output.....	45
Render Cache.....	45
Applications.....	45
Image Editor.....	45
Animation Player.....	45
Text Editor.....	46
Program.....	46
Arguments.....	46
Development.....	46
118n Branches.....	46
Asset Libraries.....	46
Asset List.....	46
Add.....	46
Remove.....	46
Path.....	47
Import Method.....	47
Append (Reuse Data).....	47
Append.....	47
Link.....	47
Relative Path.....	47
Experimental.....	47

Preferences

The Preferences is the place where you can tweak several settings to your needs. It can be opened in the Edit menu in the top bar.

The Preferences contains several tabs. And every tab contains several rows or panels with content. We will go through them one by one.

When you have changed something, and want that changes to be permanent, then you are required to save the user settings. See the Save User Settings button in the header.

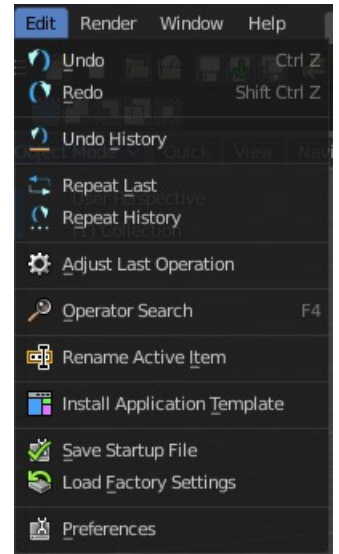

Navigation Sidebar

At the left side you will find the navigation elements to access the different categories. At the bottom resides the Save Preferences menu.

Save Preferences menu

Auto Save preferences

Changes at the preferences are saved automatically when Auto Save Preferences is ticked. When this option is off, then changes needs to be saved manually. When you don't save the changes, then Bforartists loads the next time with the status before the changes.

Save current State

Manually saves the current state.

Revert to Saved

This option is just available when Auto Save preferences is off. It reverts the settings to the last saved state.

Load Factory Settings

Resets the settings to the factory defaults.

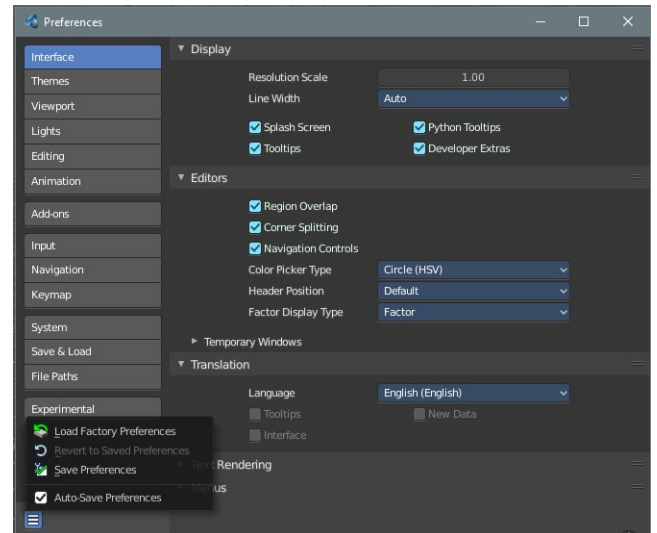

Note

Not everything can be changed from the Preferences. Everything regarding layout is stored in the Startup File, and not in the Preferences. So when you want to save a layout change then you have to save the startup file. The menu item is right above the Preferences button in the Edit menu.

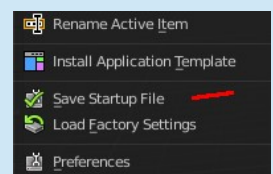

Interface Tab

The Interface category contains settings to change how UI elements are displayed and how they react.

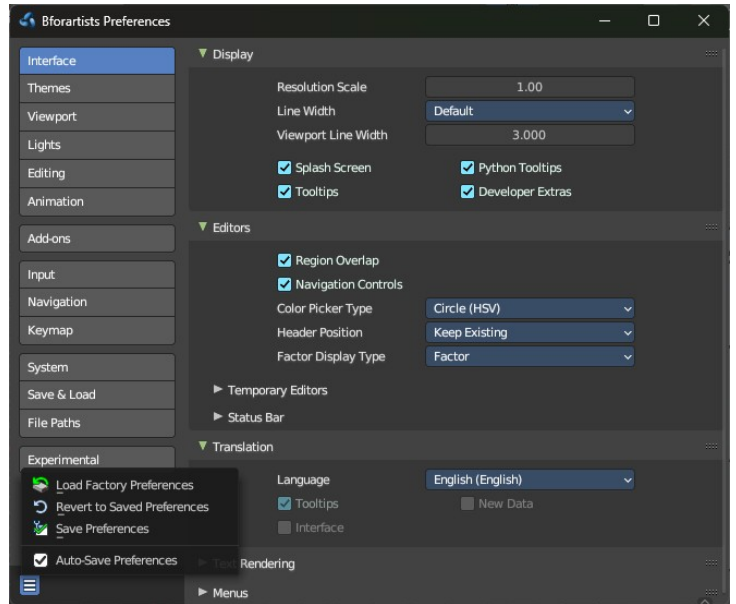

Display Panel

Resolution Scale

At 4K displays the whole UI elements are usually ways too small. Scale the whole UI size display by moving the slider to the needed value.

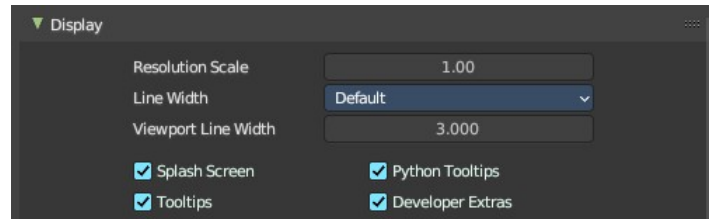

Line Width

Define the size of the line between the editors. This is a theming setting.



Viewport Line Width

Changes the appearance of only lines in the 3D Viewport.

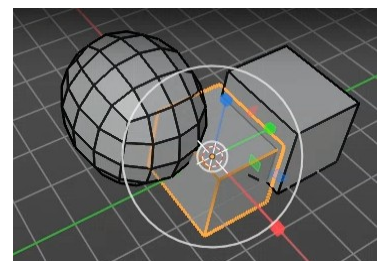

Splash Screen

Display the Splash Screen when starting Bforartists.

Tool tips

Display tool tips in the UI. With this feature unticked you won't see any tool tips anymore. It is not recommended to turn this feature off. The icon buttons needs the tool tips to display the tool name.

Python Tool tips

Every tool tip can also display the Python code tag for the tool. It may look like noise in the first moment. But can give you some further hints here and there. Some tool tips, like the Node editor buttons, doesn't have a proper tool description by design. Here the Python tool tip can tell you the function when you turn it into pure icon buttons.

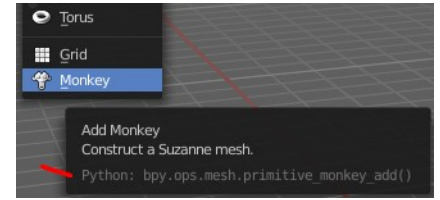

The tools in the tool shelf doesn't have a Python tool tip by design. This buttons sits on top of the normal operators, and doesn't access the tool tip of it.

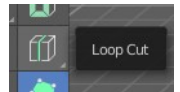

Note: It is not recommended to turn the Python tool tips off.

Developer Extras

This tick box turns on or off the developer entries in the right click menus.

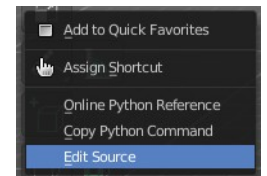
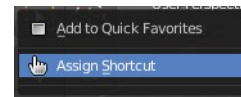

Editors Panel

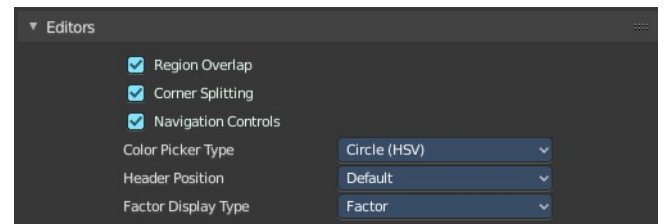

Region Overlap

This checkbox will enable Blender to draw the Header, Tool Shelf and the Sidebar overlapping the 3D View. The transparent areas becomes workspace area. You can for example select vertices now in the transparent areas.

If you have a capable graphics card and drivers with *Triple Buffer* support, clicking the checkbox will enable the overlapping regions to be drawn using the *Triple Buffer* method, which will also enable them to be drawn using Alpha, showing the 3D View contents trough the *Object Tools* and *Transform Properties* regions.

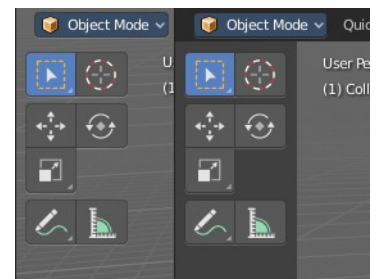

Color Picker Type

Choose the type of Color picker that will show when you click on a color field. You can choose between three square types and two circle types.

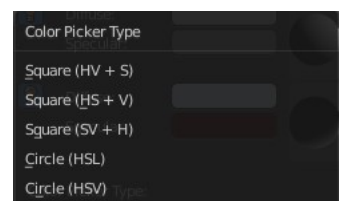
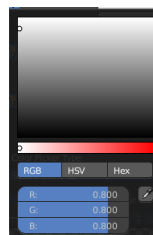

Header Position

Define at which default position the headers of the editors should reside.

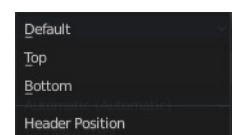

Factor Display Type

Display factor values either as percentage or as factor.

Temporary Editors subpanel

How the temporary editors behave.

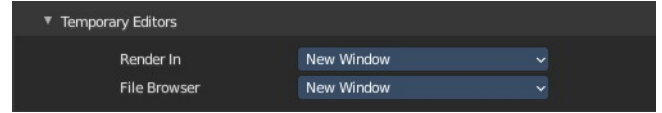

Render in

Where to display the rendered image.

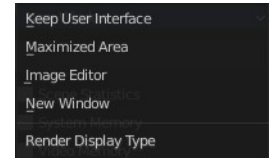

File browser

Where to open the file browser.

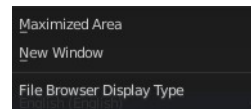

Status Bar subpanel

What content to display in the status bar at the bottom.

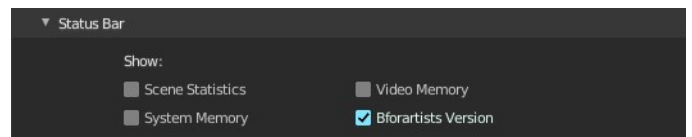

Translation Panel

Choose another default language for Bforartists.

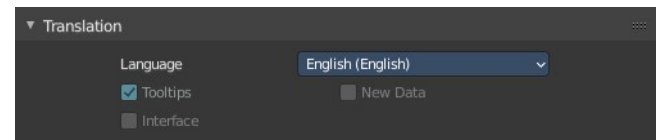

Language

Choose between automatic language detection. In this case the system language gets chosen. Or pick a language that you want to use.

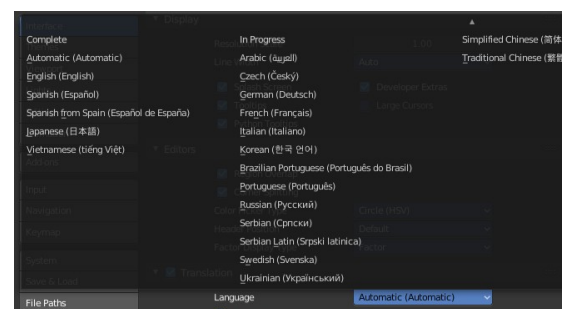

Tool tips

Tool tips translates the tool tips too.

Interface

Interface translates all the interface texts

New Data

New data is meant to edit the localization texts.

This can be done in the right click menus of the tools when

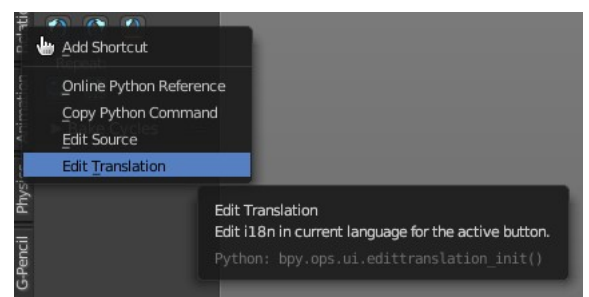

everything is set up in the correct way.

This is a development feature. You need a repository of Bforartists!

Note
This feature is currently not functional in Bforartists. It ends in an error message.

Let's nevertheless document the way how it should work. Note that you need a Bforartists repository for that. The binary version does not come with the editable *.po files, but with already compiled *.mo files for the translation.

Note that you first need to set the path to the translation files for that. Or you will get an error. This is done in the File tab. The |18n string.

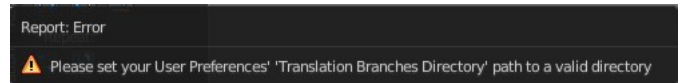

The path should lead to the *.po files that you want to translate. Which can be found in the Bforartists repository.

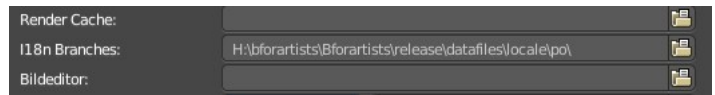

And you need to enable the Manage UI translations add-on. And to fix the paths in this add-on. The default paths are currently set for Blender.

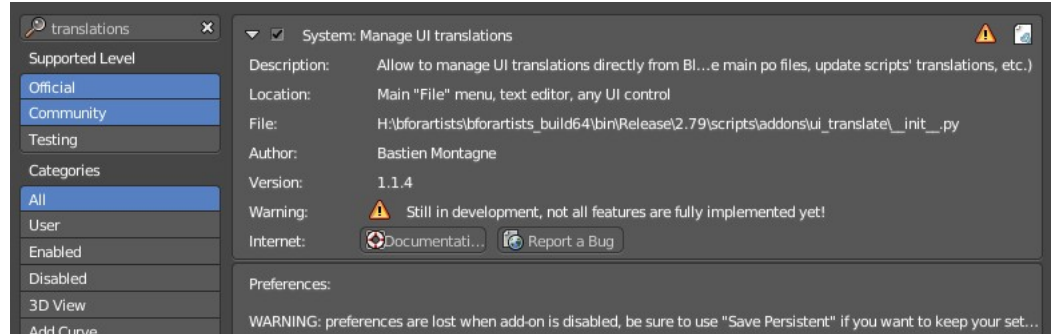

And then you might end in this error here ...

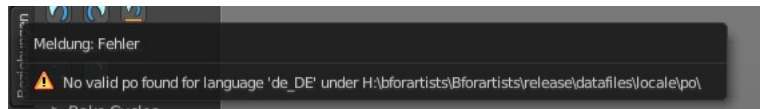

In case somebody has an idea what's going on here, every hint is welcome ...

Text Rendering Panel

Text related settings for the font of the interface.

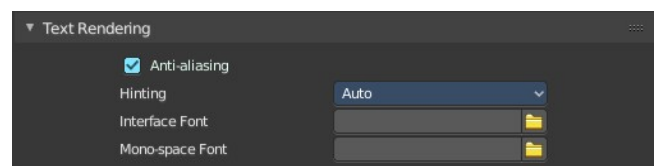

Anti Aliasing

Use Anti Alias at the UI elements to prevent pixelated look of the font.

Hinting

What sharpening method to use to make the text render sharp.



Interface Font

Define a custom interface font. The font in the whole UI.

Monospace Font

Define a custom Monospace font. That's the one used in the python console for example.

Menu Panel

Open on Mouse Over

Normally you click at a menu to open it. With Open on Mouse Over the menu opens up when you just hover with the mouse over it.

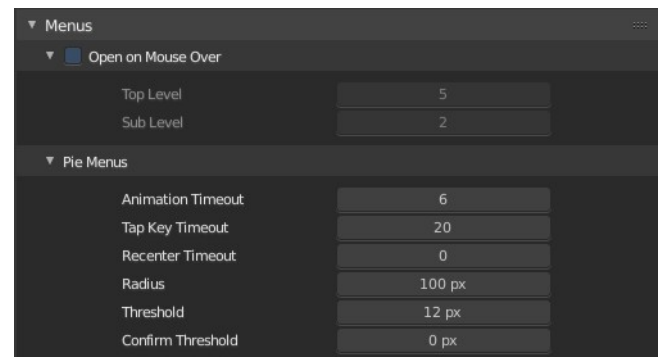

Top Level

Adjust the time delay before the top level menu opens on mouse over.

Sub Level

Adjust the time delay before a sub level menu opens on mouse over.

Pie Menu

Bforartists has some pie menus that can be called by hotkeys. Here you find some settings for it.

Animation Timeout

The pie menu fades in with an animation. Adjust the time needed to fully unfold the pie menu.

Top Key Timeout

Pie menu button longer held than this time will dismiss the menu on release.

Recenter Timeout

Pie menus will use the initial mouse position as center for this amount of time. The value is in 1/100 seconds.

Radius

The pie menu size in pixels.

Threshold

The distance that is needed from the center to move the mouse so that a selection can be made.

Confirm Threshold

Distance threshold after which selection is made. A value of zero disables this feature.

Themes

The Themes tab allows you to customize interface appearance and colors. There are various elements that can be themed.

Any change here will appear in real-time on your screen in the corresponding editor.

To change a color for a UI element, simply click at one of the color fields. A color dialog will open up to choose a new color.

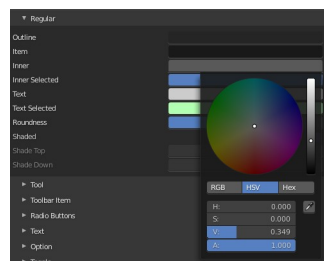
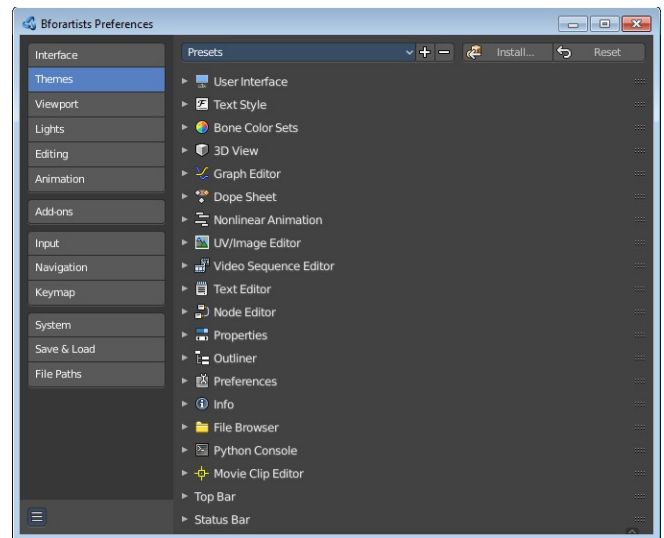

Presets

Bforartists comes with several theme presets. You can choose between them in the drop down box. Don't forget to save the user settings to make the change to the new preset permanent.

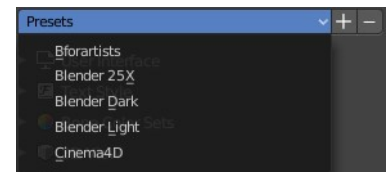

Create new Theme

To create a new theme, click the + button next to the preset selection drop-down and enter a name. This will save the theme to an XML file in the ./scripts/presets/interface_theme/ sub directory of one of the configuration directories.

To share the new created theme you have to copy it from that folder. This XML file can then be loaded as a theme at another

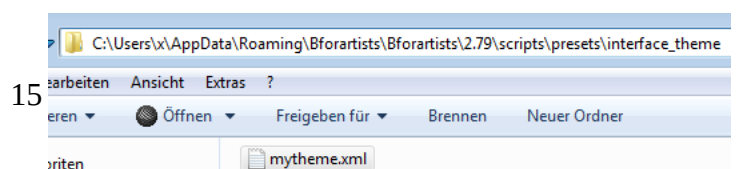
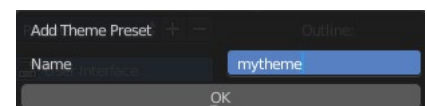

computer with Bforartists installed.

Install

Install an external theme. This button will open a file browser.

Reset

Resets all made changes, and resets the current theme to its initial state.

List of Editors

The list of the editors that you can theme. Every editor can have its own theming.

Viewport

Contains the settings for the 3D Viewport.

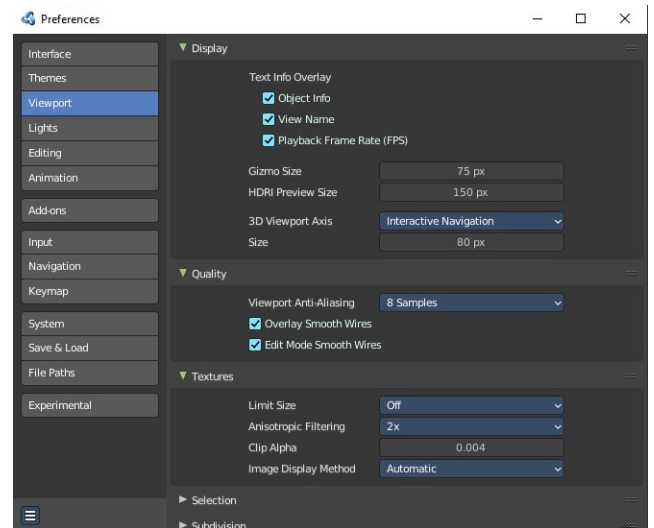

Display

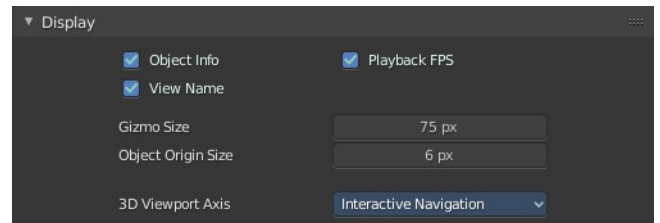

Text Info Overlay

Object Info

Display current frame, collection name and Object name in the upper left edge of the 3D view.

The letters appears in yellow when the current frame of the selected object has a keyframe.

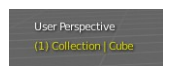
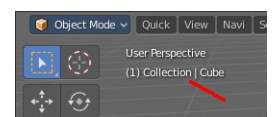

View Name

Display the name of the current view up left in the 3D view.



Playback FPS

Show the frames per second screen refresh rate while an animation is played back. It appears in the viewport corner, displaying red if the frame rate set cannot be reached. And replaces the View name while the animation is playing.



Gizmo Size

Adjust the size of the transform gizmo that appears when you have one of the transform tools activated.

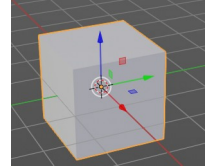

Object Origin Size

Adjust the size of the orange dot that represents the center of the object. The pivot.

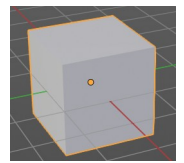

3D Viewport Axis

Adjust the appearance of the 3D Viewport mini axis widget.

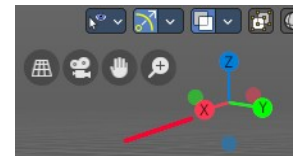
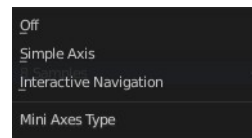

Off

Hides the Mini axis widget

Simple Axis

Shows simple axis. This widget type is not interactive. It just shows the state of the viewport rotation.

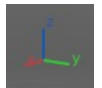

Size

The size of the simple mini axis widget.

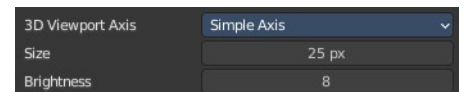

Brightness

The brightness of the simple mini axis widget.

Interactive Navigation

The default mini axis widget. This widget is interactive. Clicking and dragging will rotate the viewport. Clicking at one of the colored spots at the end of the axis will snap to the nearest orthographic view.

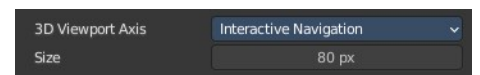

Size

The size of the interactive navigation widget.

Quality

Contains the settings to adjust the display quality in the



viewport.

Viewport Anti-Aliasing

The anti alias quality settings for the solid mode rendering in the 3d viewport.

Multi sampling

Set the OpenGL Multi sampling in case your system supports it.

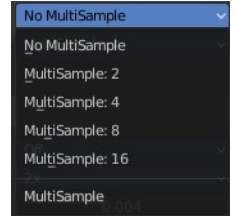

Grease Pencil Multi sampling

The grease pencil drawing has its own OpenGL Multi sampling. Set the OpenGL Multi sampling in case your system supports it.

Edit Mode Smooth Wires

Enable Edit Mode edge smoothing which reduces anti alias and makes the edge more sharp. A change requires a restart of the software.

Textures

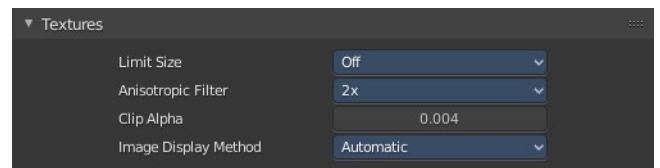

Limit Size

Limit the maximum resolution for pictures used in textured display to save memory. The limit options are specified in a square of pixels, (e.g.: the option 256 means a texture of 256×256 pixels) This is useful for game engineers, whereas the texture limit matches paging blocks of the textures in the target graphic card memory. Available Options are: *Off* (No limit), *128*, *256*, *512*, *1024*, *2048*, *4096*, and *8192*.

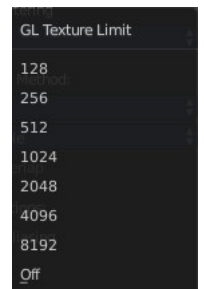

Anisotropic Filtering

Sets the level of anisotropic filtering. This improves the quality of how textures are drawn at the cost of performance. Available Options are: *Off* (No Filtering), *2x*, *4x*, *8x*, and *16x*.

Clip Alpha

Clip alpha when the value is below the here defined value.

Image Display Method

The method that is used to draw textures in the viewport.

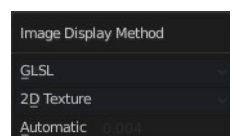

Selection

OpenGL Depth picking tries to pick the object in front. Without this method you may pick an object underneath.

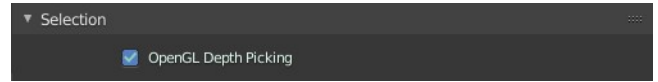

Lights

The viewport uses different light setups in different situations. You can switch between them in the shading drop down in the 3d view up right.

This tab allows you to customize these light setups. And install custom light setups.

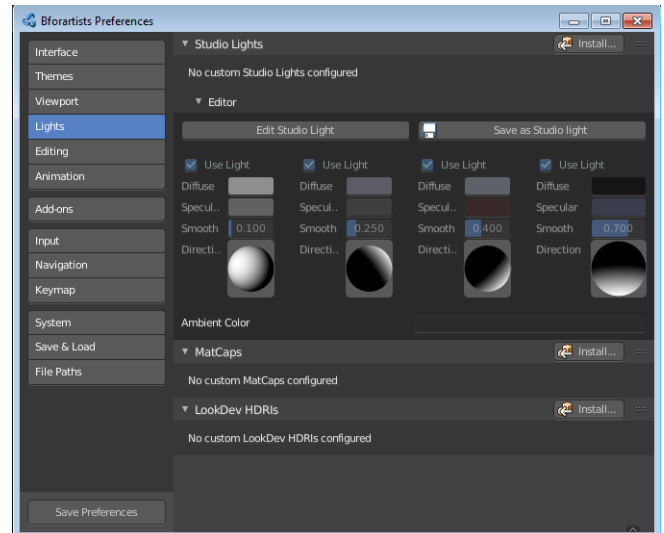

Studio Lights

The 3D view uses Solid OpenGL lamps to light the 3D view. You can enable four different light sources here. These lamps does not affect the rendering. Their only purpose is to light the 3D view.

You can turn on or off the lamps. But there should be at least one light enabled.

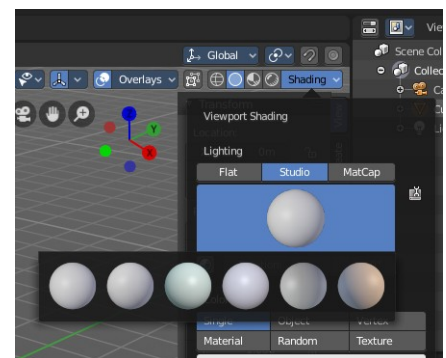

Install

Install an external studio light.

Preview Window

This window appears when you have a studio light saved, or a new studio light installed.

Down left you can see the name of the saved library.

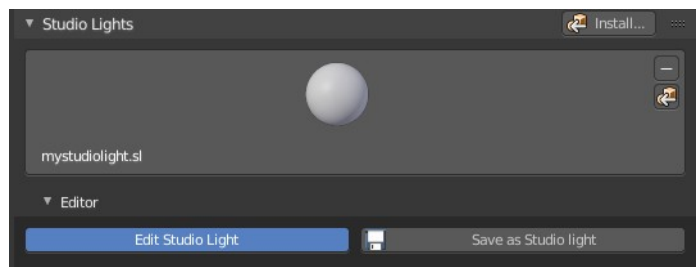

mystudio.sl .

This window gives you a preview of how this studio light looks like in the 3D view then.

Up right you can find two buttons.

Delete Studio Light

Deletes the studio light.

Copy Studio Light settings to the Studio Light Editor

The editor settings does not update immediately. It shows the default studio light setting. So when you want to edit the studio light, then you want to press this button to update the editor values first.

Edit Studio Light

Enable the editing of the studio light setup.

Save as Studio Light

Save the current light setup as a studio light setup. Note that this does not export the light, but saves its settings internally in the appdata directory.

Use Light

Turn on or off this specific light.

Diffuse

Diffuse color is the constant color of the lamp.

Specular

Specular is the highlight color of the lamp.

Smooth

Smooth the lighting from this specific light.

Direction

Adjust the direction. Click into the field and drag the sphere around until you have your desired light setup.

MatCaps

Matcaps is a special material that can be assigned quickly to preview geometry. Usually matcaps are used while sculpting. You can switch between them in the shading drop down in the 3d view up right.

Install and manage custom matcaps.

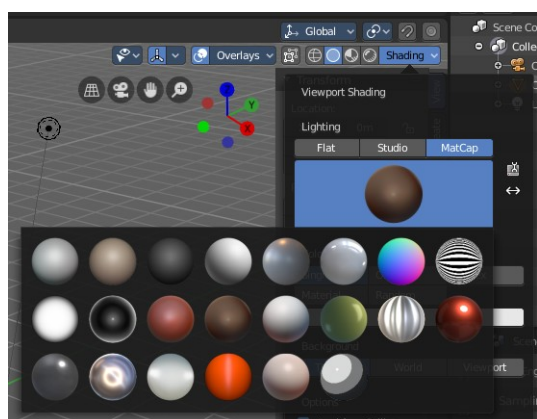

LookDevHDRI's

You can light the scene with an environment image instead of lights. This is done with hdri images.

The viewport can do this in realtime when the shading is set to Viewport Shading.

Install and manage custom LookDev HDRI's. Basically every image could do the trick here. But the hdri's uses a special spherical mapping. So you better use hdri images for this purpose.

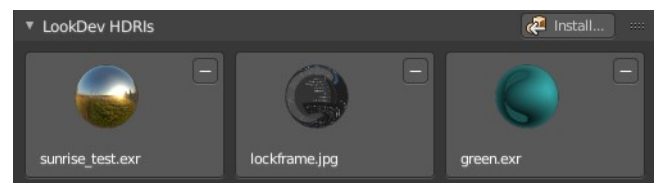
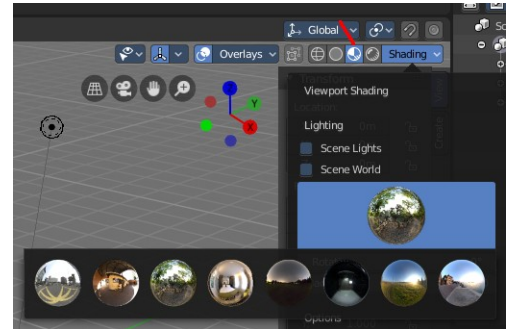

Editing

Contains the settings around editing. Objects, Data, etc.

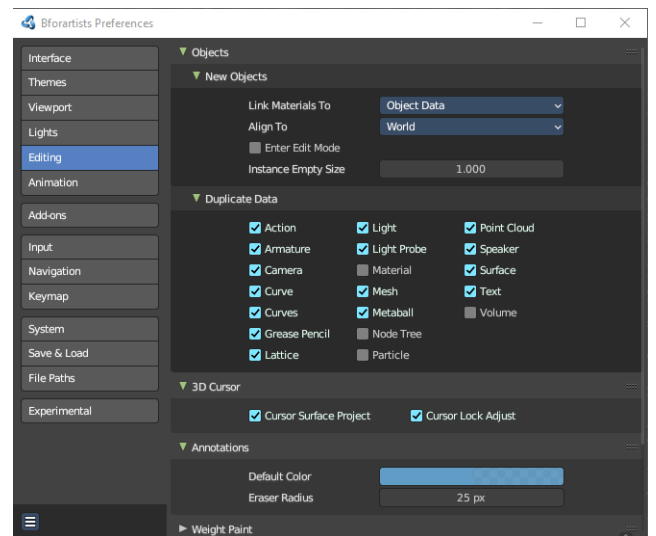

Objects

New Objects

Link Materials To

Define how materials will be linked to its objects. Almost everything in Bforartists is organized in a hierarchy of data-blocks. A data-block can be thought of as containers for

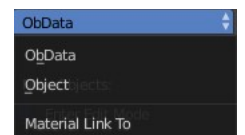
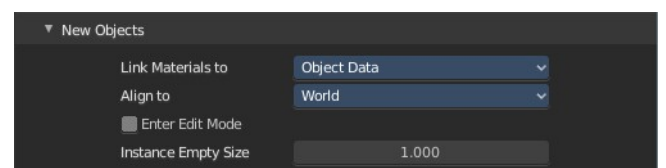

certain pieces of information. For example, the Object data-block contains information about the Object's location while the Object Data `ObData` data-block contains information about the mesh.

ObData

Any created material will be created as part of the ObData data-block.

Object

Any created material will be created as part of the Object data-block.

Align To

World

New objects align with world coordinates.

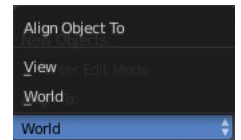

View

New object align with view coordinates.

Enter Edit Mode

If selected, Edit Mode is automatically activated when you create a new object.

Instance Empty Size

Increase or decrease the size of collection empties.

Duplicate Data

When you duplicate data, then most or all its subpart gets duplicated too. Define which supports should be duplicated when you duplicate an object.

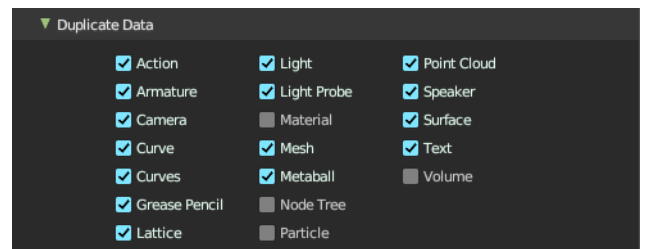

3D Cursor

Cursor Surface Project

Use the surface depth to place the 3D cursor. That way you can place the 3D cursor at the surface of an object.

Cursor Lock Adjust

Place the cursor without a jumping effect at the new location when lock to cursor is used.

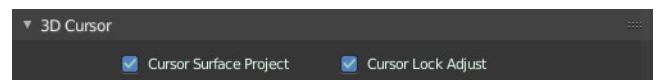

Annotations

Default Color

The default color for the annotations pencil.



Eraser radius

The eraser radius.

Weight Paint

Use Custom Colors

Bforartists uses by default a gradient that goes from red to green to blue to black to display the different weight at a mesh.

Setup a custom gradient for the colors of a weight paint.

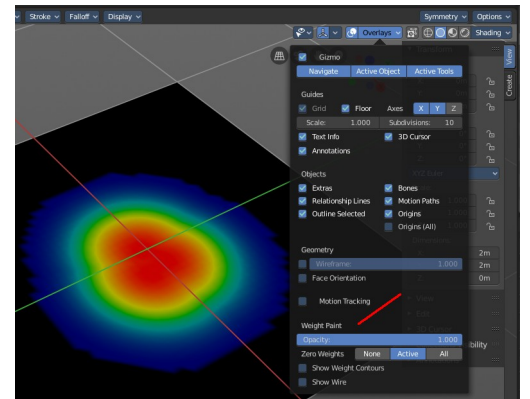
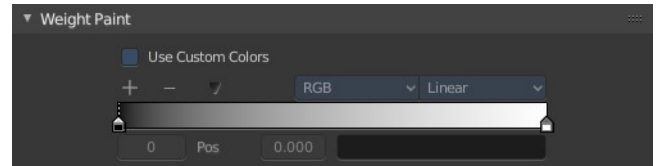

The + Button adds a color stop point, which can be moved around. That way you can have more than one color in the gradient.



The - Button removes the currently selected color stop point.

Tools Menu

Flip Color ramp flips the color ramp.

Distribute Stops from Left distributes the color stops from the left. The position at the right will remain empty.

Distribute Stops evenly distributes the color stops evenly across the gradient.

Eyedropper allows you to pick a color from the gradient.

Reset color ramp resets the color ramp to the default state.

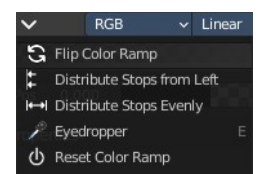

Color Mode is a drop down box to choose the color mode for the gradient.

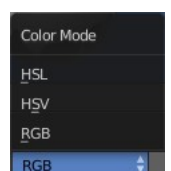

Interpolation is a drop down box to choose the interpolation mode for the gradient.

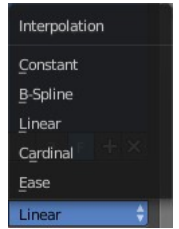

In the **Color Ramp element** you will see the color ramp with the single color stops.



Choose Active Color Stop is the stop point of the gradient.



Position is an edit box where you can numerically fine tune the position of the currently selected color stop.

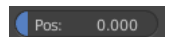

Color Ramp Element displays the color of the current selected color stop. When you click at it then you can open a color picker to change the color of the current color stop.

Background Color

Background color is the same color than the secondary color from the color picker. When you click at it then you can open a color picker to change the secondary color.

Gradient Stroke Mode

Set the gradient stroke mode.

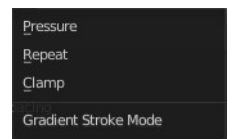

Grease Pencil



Manhattan Distance

The minimum number of pixels the mouse has to move horizontally or vertically before the movement is recorded.

Euclidean Distance

The minimum distance that mouse has to travel before movement is recorded.

Text

Auto-close Character Pairs

Automatically close relevant character pairs when typing in the text editor.

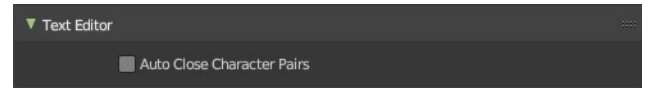

Node

Auto Offset Margin

Minimum distance in the node editor between nodes for auto offsetting.

When you insert a new node between two existing connected nodes, then the two nodes gets pushed to left and right, with an offset. Adjust this offset.

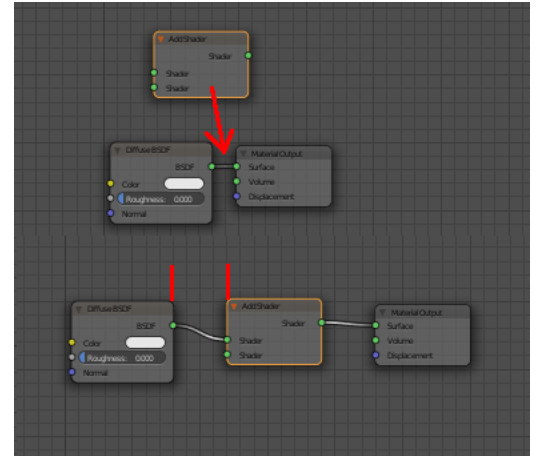
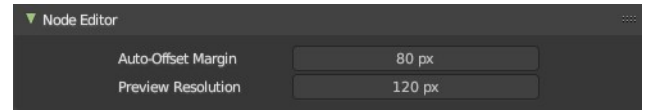

Preview Resolution

Resolution used for shader node previews, which are displayed above the nodes.

Miscellaneous

Sculpt Overlay Color

This color button allows the user to define a color to be used in the inner part of the brushes circle when in sculpt mode, and it is placed as an overlay to the brush, representing the focal point of the brush influence.

The overlay color is visible only when the overlay visibility is selected (clicking at the eye to set its visibility), and the transparency of the overlay is controlled by the alpha slider located at the brush pop-up, located at the top of the tool shelf, when in sculpt mode.

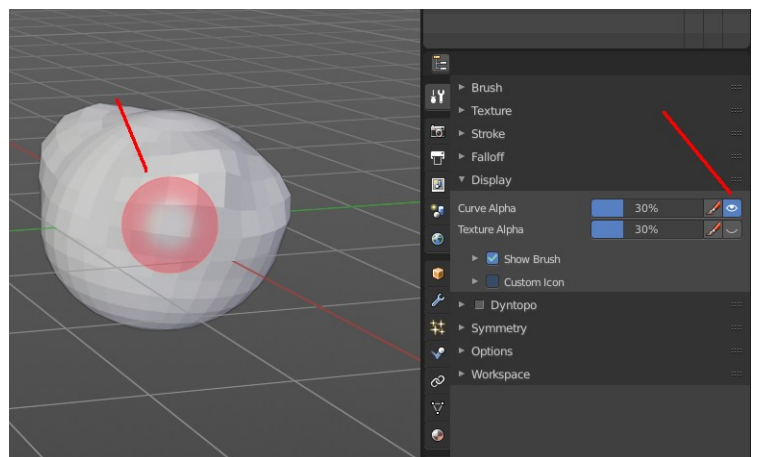

Animation

Contains the settings for the animation editors.

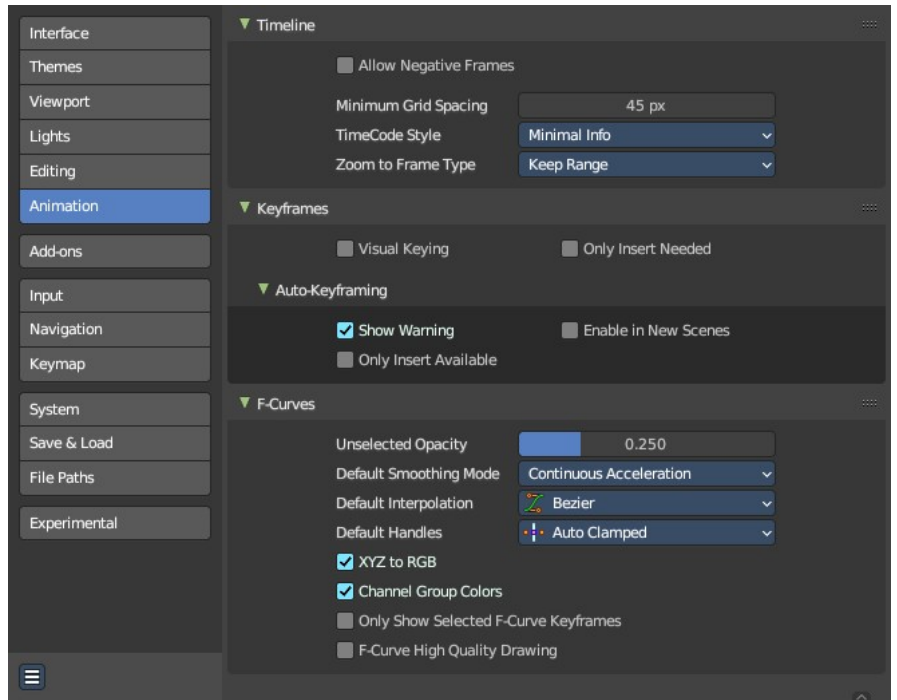

Timeline

Allow negative Frames

Minimum Grid Spacing

Adjust the minimum number of pixels between grid lines in a 2D viewport. This affects for example Timeline, Dope sheet, Graph or NLE Editor.



Time Code Style

In Timeline, Dope sheet, Graph and NLE editor you can either display the keyframe number or the time in the timeline. Define how the time gets displayed when you have chosen to display time.

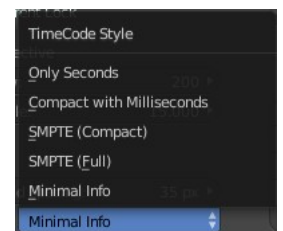
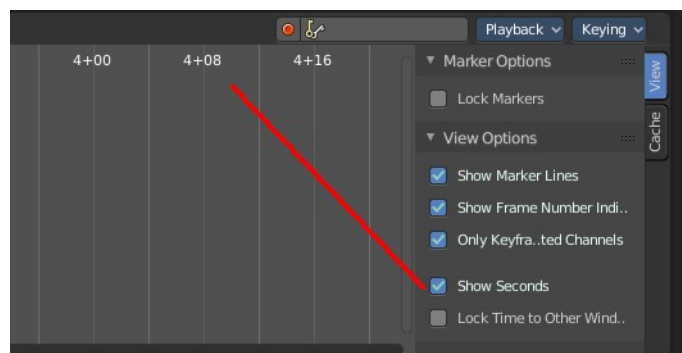

Zoom To Frame Type

Timeline, Dope sheet, Graph and NLE. Define how zooming to frame focuses around current frame.

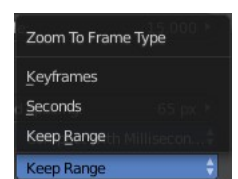

Keyframes

Visual Keying

When an object is using constraints, the objects property value doesn't actually change. *Visual Keying* will add keyframes to the object property, with a value based on the visual transformation from the constraint.

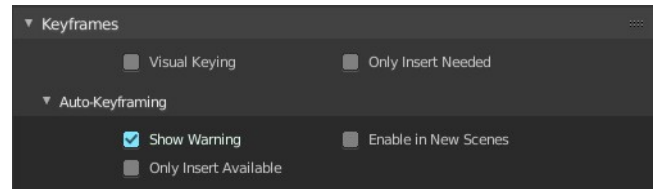

Only Insert Needed

This will only insert keyframes if the value of the property is different.

Auto Keyframing

Show Warning

Displays a warning at the top right of the *3D View*, when moving objects, if *Auto Keyframe* is on.

Only Insert Available

This will only add keyframes to channel F-Curves that already exist.

Enable in new scenes

Automatic keyframe insertion for objects and bones as Default setting for new scenes.

F-Curves

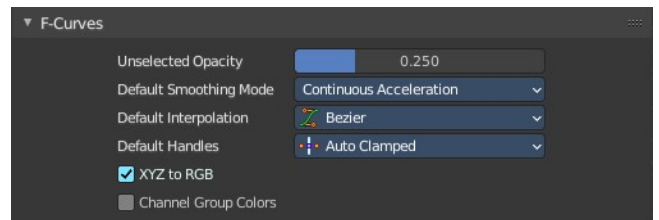

Unselected Opacity

The amount that unselected F-curves stands out from the background in the Graph Editor.

Default Smoothing Mode

Auto handle smoothing mode for new added curves. None or Continuous acceleration.

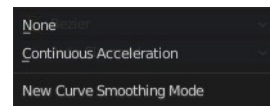

Default Interpolation

This controls how the state between two keyframes is computed. Default interpolation for new keyframes is Bezier which provides smooth acceleration and deceleration whereas Linear or Constant is more abrupt.

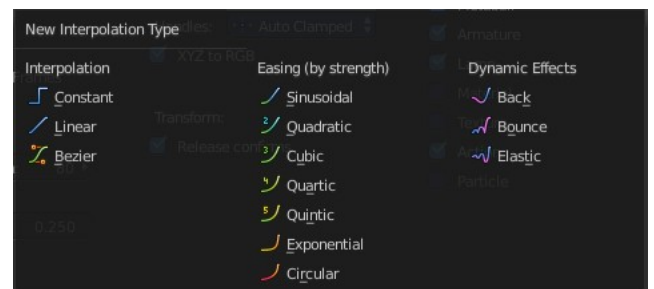

Default Handles

The default handle types for F-Curves.

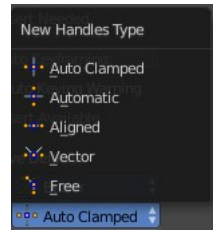

XYZ to RGB

Color for X, Y or Z animation curves (location, scale or rotation) are the same as the color for the X, Y and Z axis.

Channel Group Colors

Use animation channel group colors. Uses the bone group colors.

Only Show Selected F-Curve Keyframes

Just show the keyframes from the selected curves only.

F-Curve High Quality Drawing

Display the curves in highest quality.

Addons

An add-on is external software written by other developers. Add-ons are a way to extend the core functionality of Bforartists. Bforartists already comes with lots of add-ons. Some already activated. Here you can manage them, and add even more add-ons if required.

Note that Bforartists works with Blender addons.

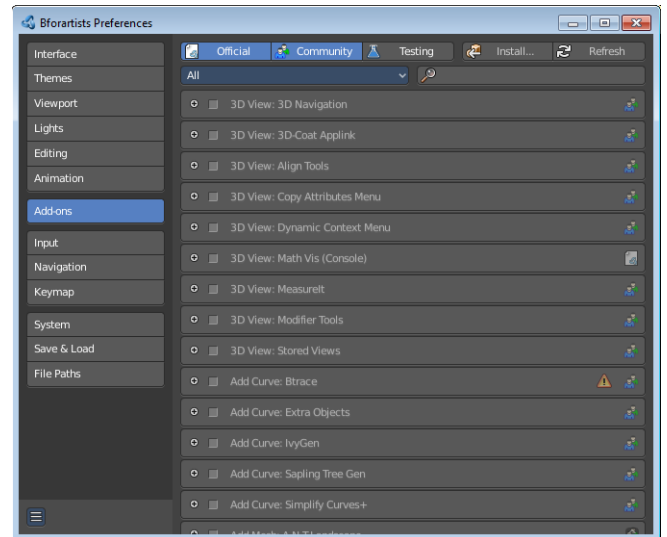

Note also that this list contains some add-ons that are required by Bforartists to work proper. You will see a warning in those addons. Don't turn them off. Or vital parts of Bforartists will not longer work. Like the toolbar.

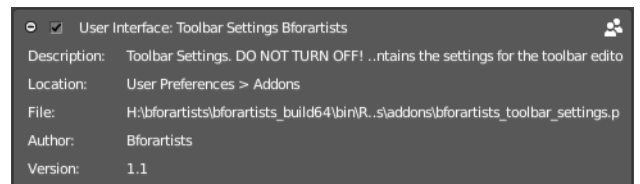

Header

Official / Community / Testing

Filter the addons by supported level.

The addons comes in three flavors. The official addons are the addons from the Blender developers. Community are the addons from Community developers that doesn't officially belong to the Blender developer team. And Testing add-ons are add-ons that aren't really finished yet. They can do the job, but are experimental.

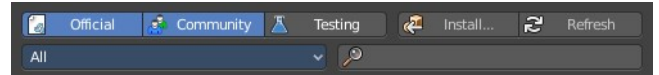

Install Add-on

Install external add-ons. Note that addons that comes as a zip file should be loaded zipped. And not unzipped.

Refresh

Scan the add-on directories for new modules. This is useful when you decide to install an add-on manually.

Category

Refine the search down to single categories.

Search

Search for keywords.

List of Addons

This is the list of installed add-ons. Installed does not necessarily mean that they are enabled. To enable an add-on, tick the checkbox at the left. When you expand an add-on then you will find some further informations. Sometimes you will also find some more settings.

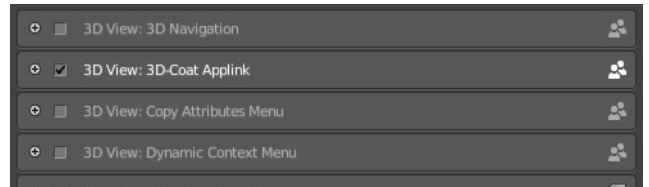

Input

This tab contains some input related settings.

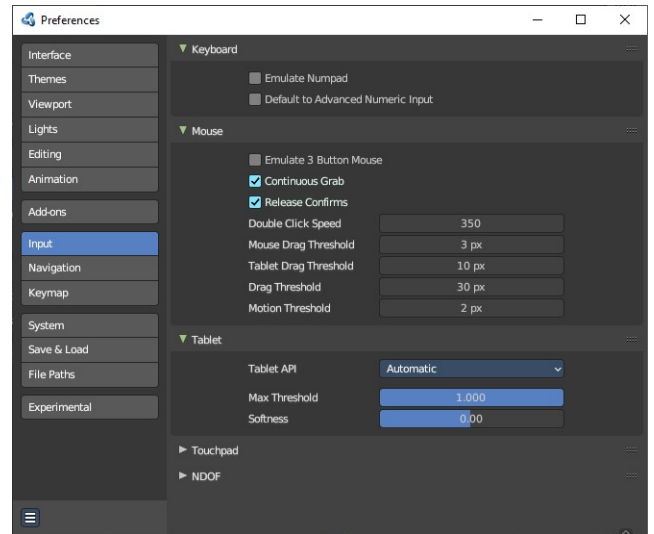

Keyboard

Emulate Numpad

Laptops usually doesn't have Numpad keys. Choose to use the number keys above the letters as Numpad keys.

Default to advanced numeric input

When entering numbers while transforming default to advanced mode for full math expression evaluation.

Mouse

Emulate 3 Button Mouse

In the Windows world 3 button mouses are common. But Apple for example has a single mouse button. Bforartists can emulate a 3 button mouse. The third mouse button will then be emulated by a key combination.

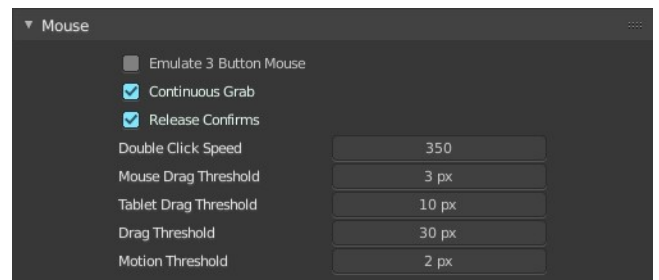

3-button Mouse	2-button Mouse	Apple Mouse
LMB	LMB	LMB (mouse button)
MMB	Alt - LMB	Alt - LMB (Option/Alt key + mouse button)
RMB	RMB	Cmd - LMB (Command/Apple key + mouse button)

Mouse/Keyboard combinations referenced in this manual can be expressed with the combinations shown in the table. For example, MMB drag becomes Alt - LMB drag. Shift - Alt - RMB becomes Shift - Alt - Cmd - LMB on a single-button mouse.

Tablet

This panel contains some tablet related settings.

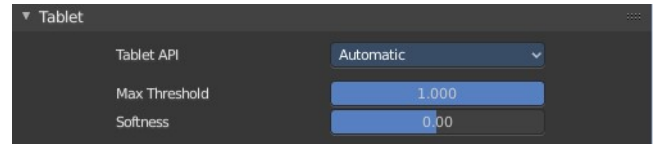

Tablet API

Choose which API Bforartists should choose for the pressure sensitivity of your tablet.

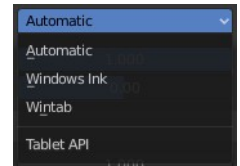

Max Threshold

The raw input pressure value which is interpreted as 100 % by Bforartists.

Softness

Adjust the pressure softness of the low pressure response onset using a gamma curve.

Touchpad



Multi Touch Gestures

Use multi touch gestures for navigation with touchpad instead of scroll wheel emulation.

NDOF

You can use a 3D mouse in Bforartists. Here you find some 3D mouse related settings.

Pan Sensitivity

Adjust the pan sensitivity.

Orbit Sensitivity

Adjust the orbit sensitivity

Deadzone

The initial movement that is needed before the movement gets recognized.

Navigation

Choose the navigation style between Free and Orbit.

Rotation

Adjust in what style you rotate the 3D View. Turntable and Trackball navigation reacts a bit different. Turntable

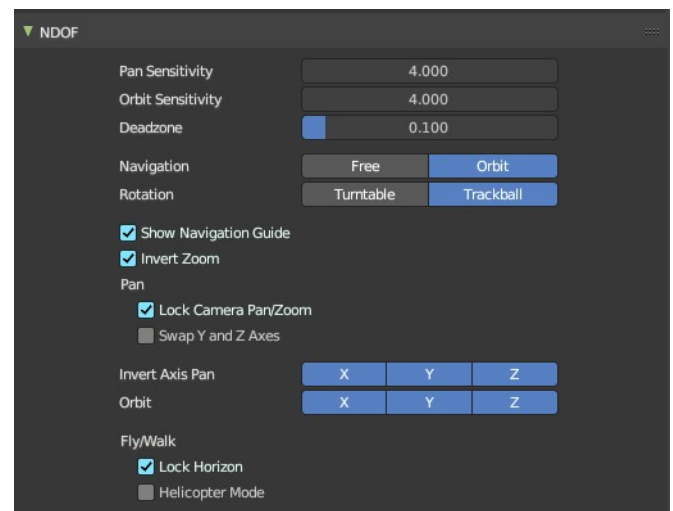

navigation tries to hold the horizon line while rotation. Turntable rotation rotates also the horizon line.

Show Navigation Guide

Display the axis and center during rotation.

Invert Zoom

Zoom using opposite direction.

Lock Camera Pan/Zoom

Pan / Zoom the camera view instead of leaving the camera view when orbiting.

Pan Swap Y and X Axes

Pan uses up - down instead of forward - backward

Invert Axis Pan

The invert axis for panning. Inactive axis are not inverted.

Orbit

The axis to orbit around when panning.

Fly / Walk

Lock Horizon

Keep horizon level while flying with 3D mouse.

Helicopter Mode

Using up/down directly controls the Z position in the 3D viewport.

Navigation

The navigation section contains the settings for navigating in the 3D view.

Orbit & Pan

Orbit Method

Adjust in what style you rotate the 3D View. Turntable and Trackball navigation reacts a bit different. Turntable navigation tries to hold the horizon line while rotation. Turntable rotation rotates also the horizon line.

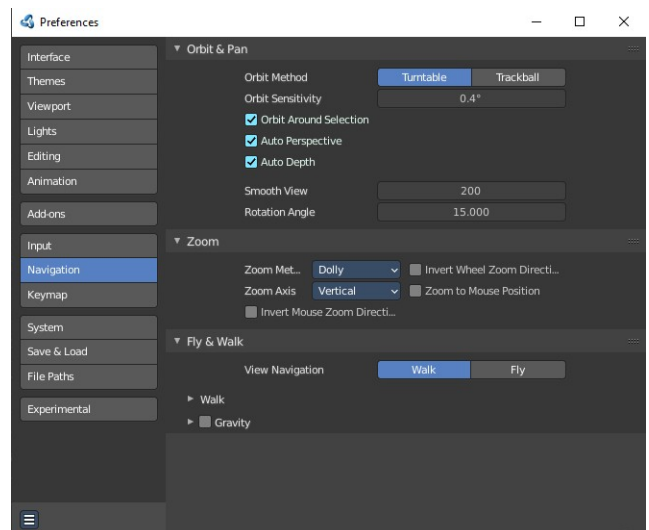

Orbit around selection

The selected object becomes the rotation center of the viewport. When there is no selection the point of the last selection will be used.

Auto Perspective

With Auto perspective off when you switch to one of the side views, then the chosen orthographic or perspective view is kept. Means when you have the distorted perspective view, and switch to top view, then your mesh will be perspective distorted here too.

With Auto Perspective the view in the side views will be orthographic, and not perspective, no matter what View Persp/Ortho is chosen.

Auto Depth

Use the depth under the mouse to improve view pan, rotate, zoom functionality.

Smooth View

The switch to change to another view is animated. Adjust the length of time the animation takes when changing the view with the Numpad (Top/Side/Front/Camera...). A value of zero will remove the animation, and immediately switch to the chosen view.

Rotation Angle

Rotation step size in degrees, when Numpad4, Numpad6, Numpad8, or Numpad2 are used to rotate the 3D View.

Zoom

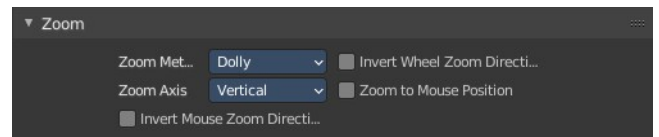

Zoom Method

Adjust the zoom style.

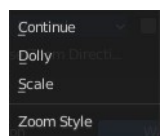

Continue

The *Continue* zooming option allows you to control the speed (and not the value) of zooming by moving away from the initial click point. Moving up from the initial click-point or to the right will zoom out, moving down or to the left will zoom in. The further away you move, the faster the zoom movement will be.

Dolly

Dolly zooming works similarly to *Continue* zooming except that zoom speed is constant.

Scale

Scale zooming depends on where you first click in the view.

Zoom Axis

With Vertical moving up zooms out and moving down zooms in. With Horizontal moving left zooms in and moving right zooms out.



Invert Mouse Zoom Direction

Inverts the Zoom direction for Dolly and Continue zooming.

Invert Wheel Zoom Direction

Inverts the direction of the mouse wheel zoom.

Zoom to Mouse Position

When enabled, the mouse pointer position becomes the focus point of zooming instead of the 2D window center.

Fly & Walk

Fly and walk are special navigation modes. They can be found in the Navi menu. The Fly & walk section also contains some settings from the View navigation style, since this style uses elements from walk and fly navigation too.

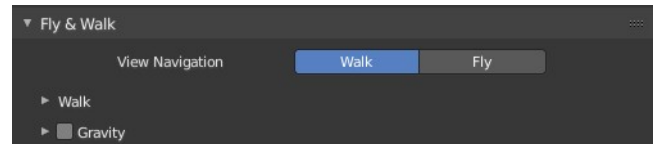

View Navigation

Adjust how the View navigation in the 3D view behaves. You can choose between walk and fly.

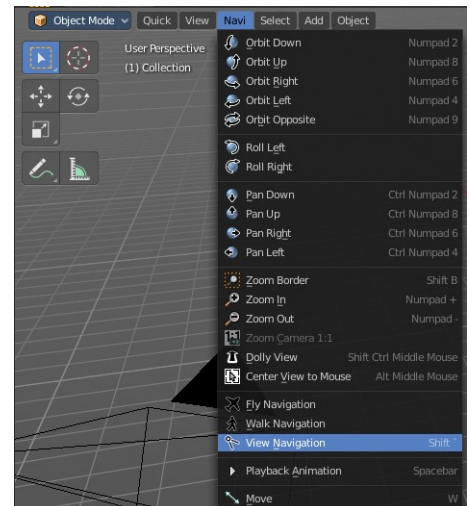

Walk

Reverse Mouse

Reverse the mouse movement when you move upwards or downwards

Mouse Sensitivity

Adjust how strong the viewport movement reacts to the mouse movement

Teleport Duration

Adjust the teleport duration when teleporting in navigation mode.

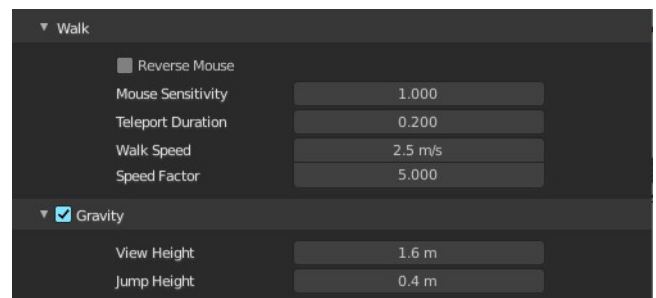

Walk Speed

Adjust the walk speed

Speed Factor

Adjust the run speed.

Gravity

Choose if the virtual character, your point of view, uses gravity.

View Height

Adjust the height of the point of view for your virtual character. This setting requires to have Gravity on.

Jump Height

Adjust the maximal jump height for your virtual character. This setting requires to have Gravity on.

Fly

Fly has no further settings.

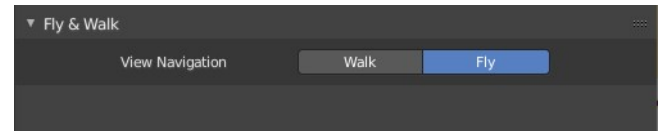

Keymap

The key map allows you to customize how Bforartists reacts to mouse and keyboard, and change key map entries. All Input behavior is defined in the key map.

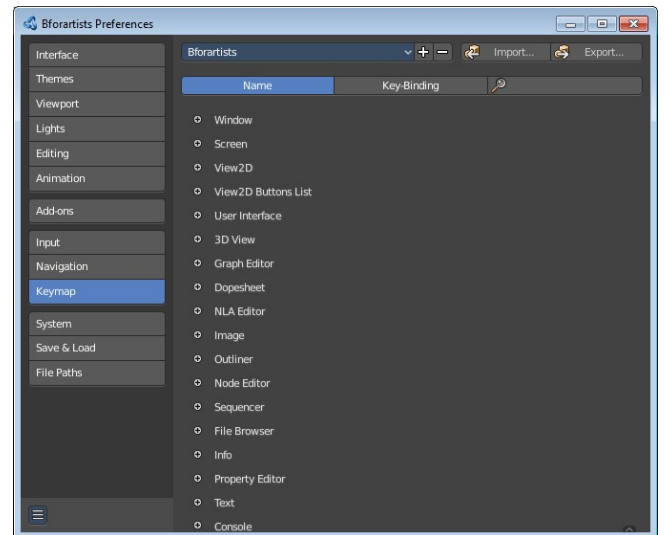

Header

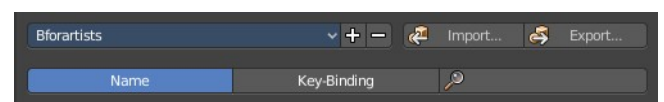

Key Configs

A drop down menu to choose existing key maps. The + button at the right adds a new key map. The current configuration will then be saved as a new key map.

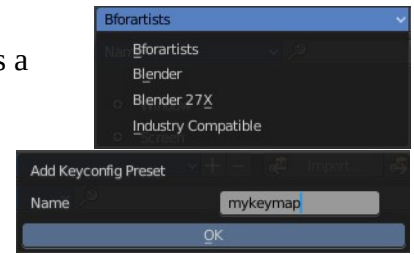

Import

Import an external key map. This opens up a file selector to choose the python file.

Export

Export a key configuration python file from Bforartists.

Filter Type

Define if you want to search for a tool name or for a hotkey. By tool name, or by the hotkey name

Search Field

Enter a search string.

Key map Editor

The Key map editor is the list where the single inputs are defined. Every input can have several specific operator settings in the lower area. The upper area defines the general things like the key combos. The lower area those operator specific settings.

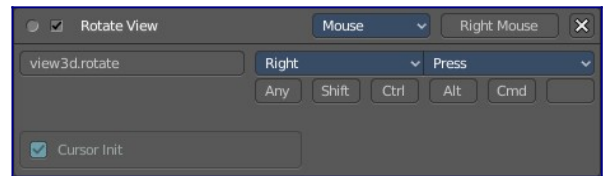

Normally you don't edit those key entries manually. Most of the usual tools have an entry in the right click menu to create or to change the hotkey. But sometimes you have to do this task manually.

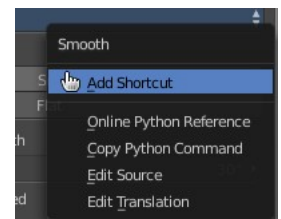

Map Type

Here you define what input will control the function.

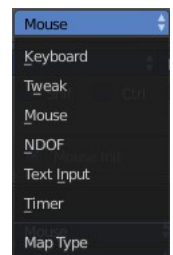

Type of Event

Here you define your main hotkey. In our case the right mouse.

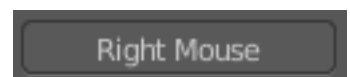

Operator

The Python operator name for the tool.

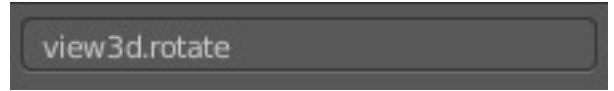

Type of Event

The main hotkey again. For special events like mouse events you have a drop down box here.



Value

What key action is required. On click, on double click, etc. ...

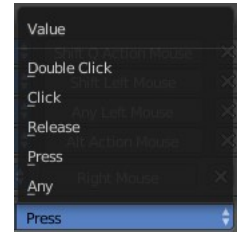

Secondary hotkeys

Many hotkeys uses a key combination, for example Shift D for select. Define those secondary hotkeys.



Specific settings

Every operator can have several settings. And some tools even just defines itself by those different settings. Here you can see two different zoom view operators. They just differ in the Delta value.

What is equal in the key map in all cases is the RNA entry. That's the name of the operator again. But this time not the Python code operator name. But the C code operator name.

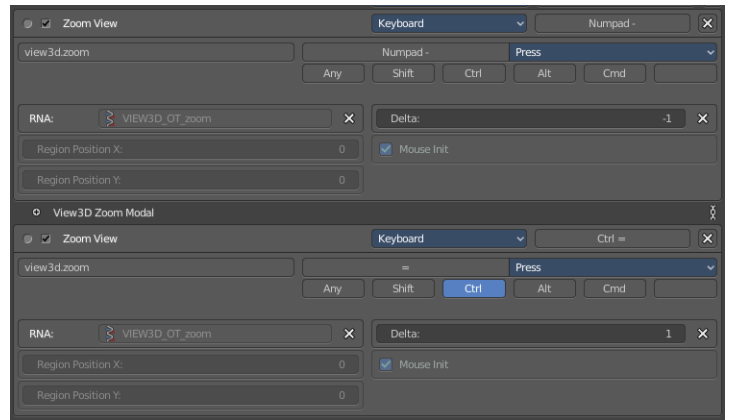

Restore

When you modify a key map item, then you will see a Restore button appear at the right side. This indicates that this key map item got modified. A click at the Restore button will restore the original hotkey

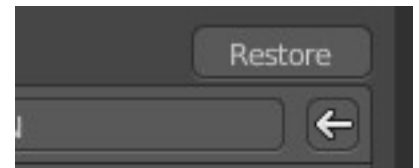

System

The system tab contains system relevant settings. Such as Cuda for Cycles renderer or OpenCL or Memory related settings.

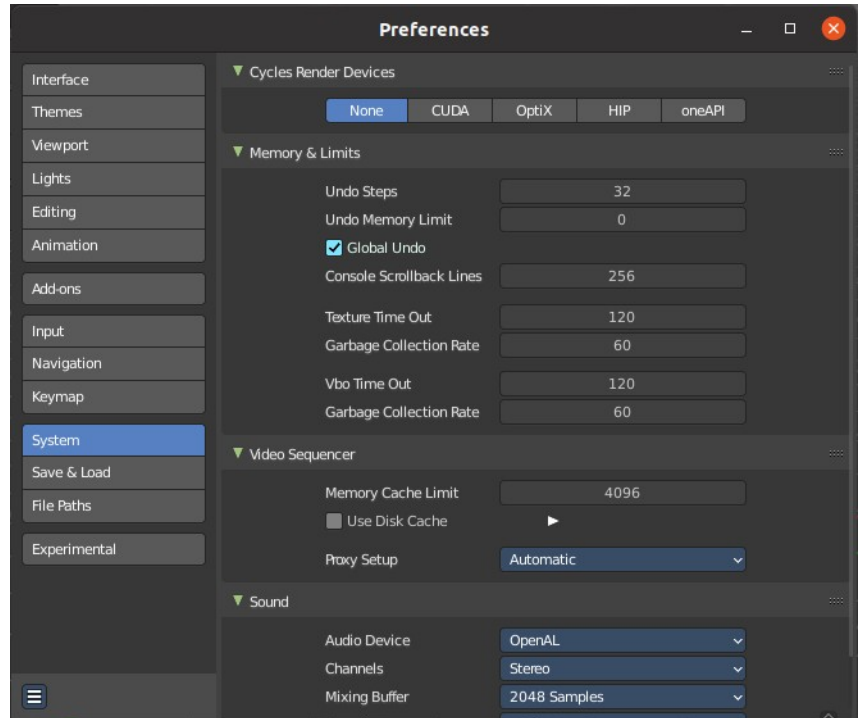

Cycles Render Devices

The Options here will set the compute device used by the Cycles render engine.

None

When set to *None* or the only option is *None*: your CPU will be used as a computing device for Cycles Render Engine.

CUDA

If the system has a compatible Nvidia CUDA enabled graphics card you will be able to use it to render with the Cycles render engine.

OptiX

Optix is a raytracing framework from Nvidia that runs on the GPU.

HIP

If the system has a compatible HIP device, it will show up has an option for rendering cycles.

oneAPI

If the system has a compatible oneAPI device, it will show up has an option for rendering cycles.

Operating System Settings

Windows only.

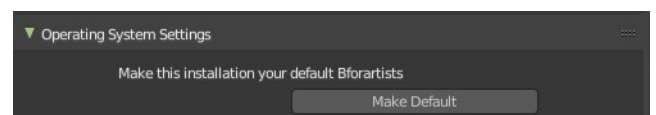

Make default

Associates the .blend file with this installation of Bforartists. This means that double clicking at a .blend file will now open this file with the currently open Bforartists installation. This is useful when you work with different versions of Bforartists, and want to open the files with an older or newer version.

Memory and Limits

Undo Steps

Number of Undo steps available.

Undo Memory Limit

Maximum memory usage in Mb (0 is unlimited).

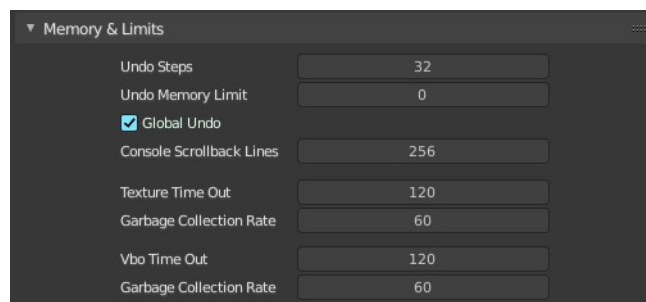

Global Undo

Bforartists Undo system is split in several subpart. Global undo stores the undo step outside of Edit mode. For example for duplicating Objects, changing panel settings or switching between modes.

Console Scrollback Lines

Maximum number of lines to store for the console buffer.

Texture Time Out

Time since last access of a GL texture in seconds, after which it is freed. Set to 0 to keep textures allocated. Minimum: 0, Maximum: 3600.

Garbage Collection Rate

Number of seconds between each run of the GL texture garbage collector. Minimum: 0, Maximum: 3600.

VBO Time Out

Time since last access of a GL Vertex buffer object, in short VBO, in seconds after which it is freed. Set to 0 to keep VBO allocated.

Garbage Collection Rate

Number of seconds between each run of the GL vertex buffer garbage collector. Minimum: 0, Maximum: 3600.

Video Sequencer

Memory Cache Limit

Upper limit of the sequence's memory cache (megabytes). For optimum clip editor and sequencer performance, high values are recommended.

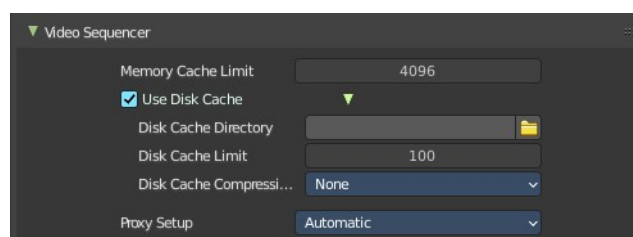

Use Disk Cache

Store cached images to disk.

Directory

The disk cache directory.

Cache Limit

The disk cache limit in gigabytes.

Compression

What compression method to use. Note that compression saves space, but costs performance.

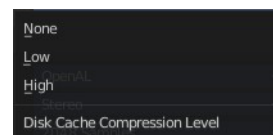

Proxy Setup

Proxies are preview objects, reduced in size to make a smooth working possible. Images for example.

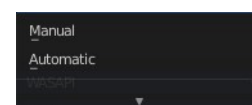

Automatic

Automatically create proxies for each image material.

Manual

You have to create the proxies by hand.

Sound

Audio Device

Set the audio device.

OpenAL

Provides buffered sound rendering with 3D/spatial support.

OpenAL - OpenAL Soft

Provides buffered sound rendering with 3D/spatial support.

SDL

Uses Simple Direct Media Layer API from libsdl.org to render sounds directly to the sound device output.

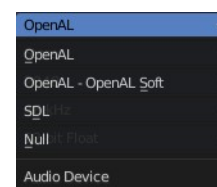
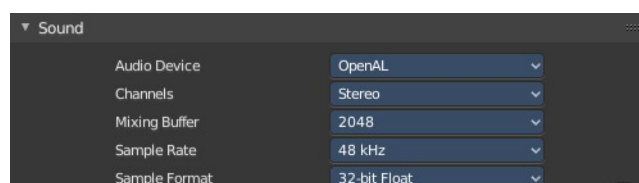

Null

No Audio support. No audio output, but audio strips can be loaded normally.

Channels

Set the audio channel count. Available options are: Mono, Stereo, 4 Channels , 5.1 Surround , 7.1 Surround

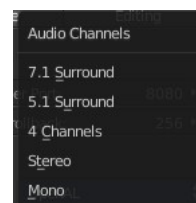

Mixing Buffer

Set the number of samples used by the audio mixing buffer. Available options are: 512 , 1024 , 2048, 4096 , 8192, 16384, and 32768



Sample Rate

Set the audio sample rate. Available options are: 44.1 Khz, 48 Khs, 96 Khz and 192Khz

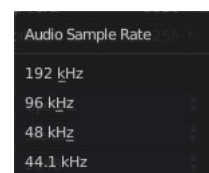

Sample Format

Set the audio sample format. Available options are: 32 bit float, 8 bit Unsigned, 16 Bits Signed, 24 Bits Signed, 32 Bits Signed, 32 Bits Float, and 64 Bits Float.

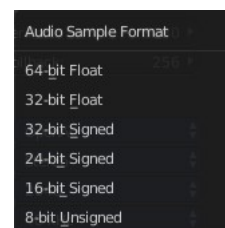

Save & Load

Blend Files

Blend file related settings. What happens at load, what happens at save ...

Relative Paths

By default, external files use a relative path.

Compress File

Compress blend-file when saving.

The option to Compress files will compact your files whenever Blender is saving them. Dense meshes, large packed textures or lots of elements in your scene will result in a large blend being created.

This option may slow down Blender when you quit, or under normal operation when Blender is saving your backup files. Using this option traces processor time for file-size.

Load UI

In Bforartists you can load the scene in the screen layout in which you have saved it. Default is off.

This can also be changed individually when loading a file from the *Open blend-file* panel of the File Browser.

File Preview

None

When this option is off, previews of images and materials in the File Browser are created on demand.

Auto

Automatically create previews of images and materials in the File Browser. The best preview type is chosen automatically.

Screenshot

Capture the entire window to create previews of images and materials in the File Browser.

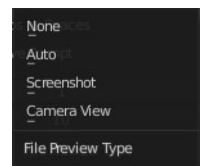
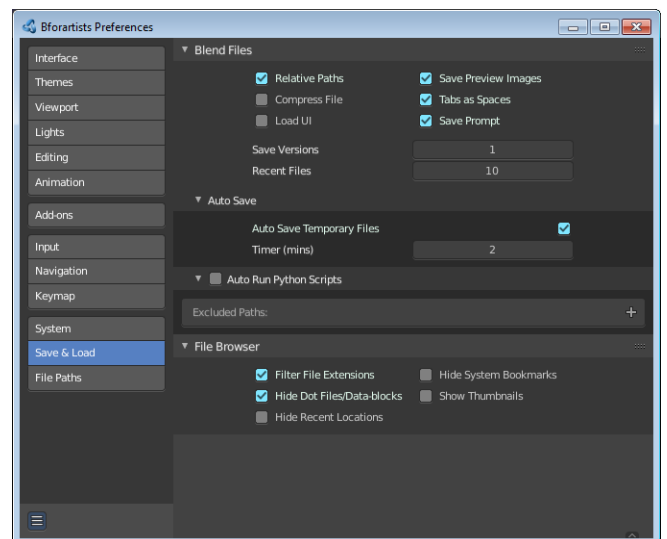
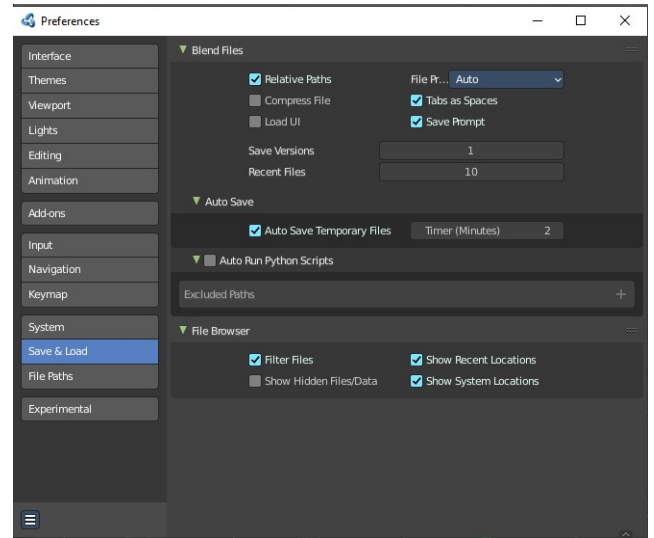

Camera Preview

Use a workbench render to create the previews of images and materials in the File Browser.

Tabs as Spaces

For text files, automatically convert tabs into spaces when loading a blend file that contains a text file. Correct indentation is relevant for python scripts.

Save Prompt

Ask for confirmation when quitting with unsaved changes.

Save Versions

Number of versions created for the same file (for backup).

This option tells Bforartists to keep the indicated number of saved versions of your file in your current working directory when you manually save a file. These files will have the extension: `.blend1`, `.blend2`, etc., with the number increasing to the number of versions you specify. Older files will be named with a higher number. e.g. With the default setting of 2, you will have three versions of your file: `*.blend` (your last save), `*.blend1` (your second last save) and `*.blend2` (your third last save).

Recent Files

The number of recent files to display in the Recent panel.

Auto Save

Auto Save Temporary File

Enable Auto Save. Auto save creates a temporary file.

Checking this box tells Blender to automatically save a backup copy of your work-in-progress to the Temp directory (refer to the File tab in the Preferences for its location).

The Auto Saved files are named using a random number and have a blend extension.

Timer

Adjust the number of minutes between each Auto Save. The minimum is 1, and the Maximum is 60 (Save at every one hour).

Auto Run Python Scripts

Run the python scripts at loading a blend file that includes these scripts.

Excluded paths

Define file paths where loaded blend files should not run the included scripts even when auto run python scripts is ticked.

File Browser

File browser related settings.

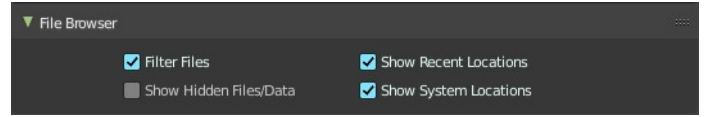

Filter Files

By activating this, the file dialog in the File Browser will only show appropriate files in the Load dialog, Blend files for example.

The selection of file types can also be changed in the header of the file dialog.



Show Hidden File/Data

On non Windows systems like Linux and Mac OS X files are hidden by a dot in front of the file name. Here you can make them visible in the file browser if you want. Note that this feature does not work with Windows.

Show Recent Locations

Hides the *Recent* panel of the File Browser which displays recently accessed folders.

Show System Bookmarks

Hides the System Bookmarks panel of the File Browser which displays the system bookmarks.

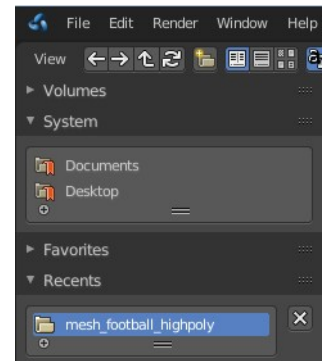

File Paths

Contains everything file path related.

Data

Fonts

Default location when searching for font files.

Textures

Default location when searching for image textures.

Sounds

Default location when searching for sound files.

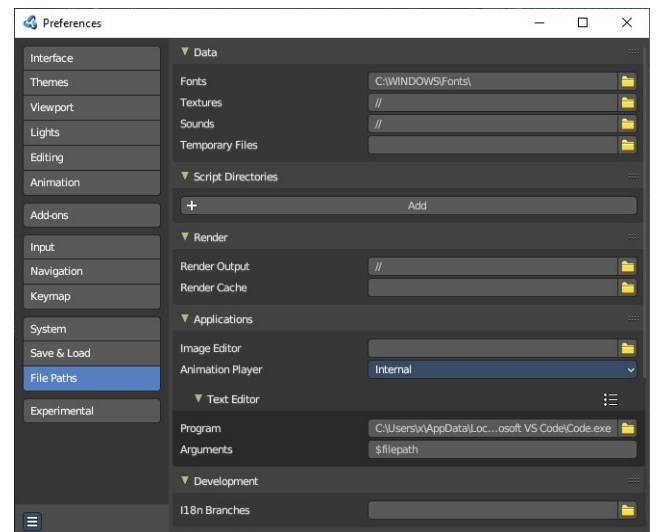

Temporary Files

The location where temporary files are stored.

Script Directories

An additional location to search for Python scripts.

By default Bforartists looks in several directories (OS dependent) for scripts. Here you can add another directory to check for scripts. This can be used to store certain scripts/templates/presets independently of the currently used Blender Version.

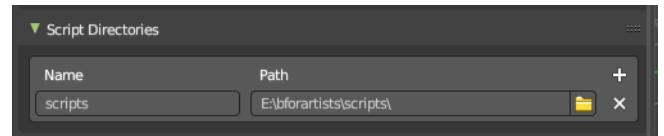
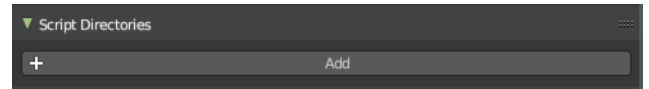

Inside the specified folder specific folders have to be created to tell Bforartists what to look for where. This folder structure has to mirror the structure of the scripts folder found in the installation directory of :

- scripts
- add-ons
- modules
- presets
- camera
- cloth
- interface_theme
- operator
- render
- ...
- startup
- templates

Not all of the folders have to be present.

Python scripts (including driver expressions) are not executed by default for security reasons.

Render

Render Output

Where rendered images/videos are saved.



Render Cache

The location where cached render images are stored.

Applications

Image Editor

The path to an external image editing software to use for image editing. Photoshop, Gimp, etc.

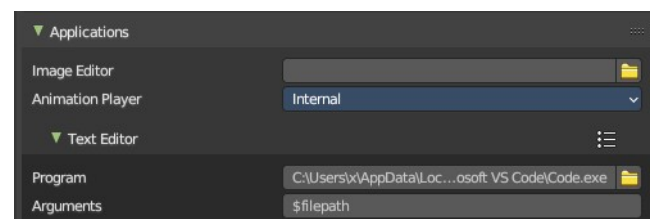

Animation Player

By default Bforartists uses the internal player to play back animations. Choose an external program to use for playback of rendered animations. There are also some presets available.

Text Editor

Here you can define an external text editor. Which allows you to edit text files externally. Which then can be done from the File menu in the text editor.

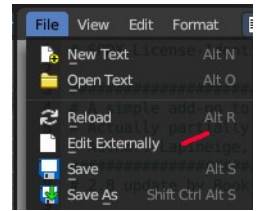

Program

Enter the path to the external text editor.

Arguments

Enter at least a filepath argument so that the code can be opened by the external editor. More arguments can be found in the tooltip.

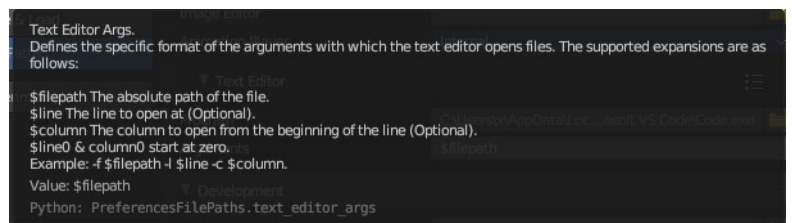

Development

I18n Branches

The path to the /branches directory in your local repository translation copy. This allows translating the UI. See interface tab, the translation panel.



Asset Libraries

The default paths for custom asset libraries. The functionality should be self explaining.

To change the path simply type in a path, or use the path picker at the end.

To add a new path to an asset library click at the + button below the list.

To remove a path click at the X button at the end.

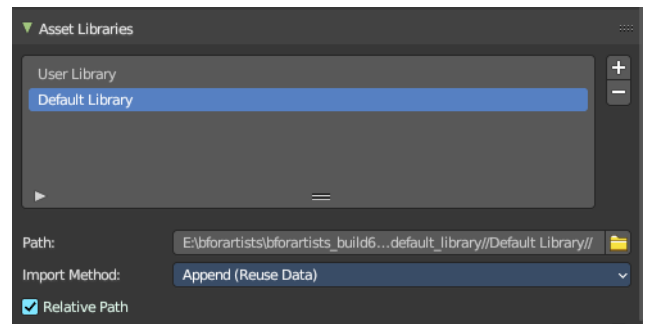

Asset List

The list of available asset libraries.

Add

Add a new asset library to the asset list.

Remove

Remove the selected library from the asset list.

Path

The path to the current selected asset library.

Import Method

How to import the assets from the asset library into the scene.

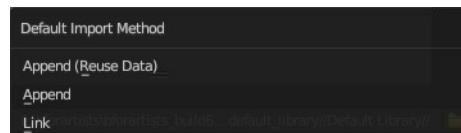

Append (Reuse Data)

Imports the assets as a copied data. The data is fully imported, and not linked to the asset library. This method reuses existing materials or meshes.

Append

Imports the assets as a copied data. The data is fully imported, and not linked to the asset library. This method also imports every material and mesh from scratch, and can create duplicated redundant data.

Link

Links the assets to the assets in the asset library. The data is linked to the asset library. When you remove the asset library then the linked data is also removed.

Relative Path

Use relative paths when linking from this librar

Experimental

Here you may find some experimental settings from the Blender development. We will not cover them here. They change very quick. Use at own risk!

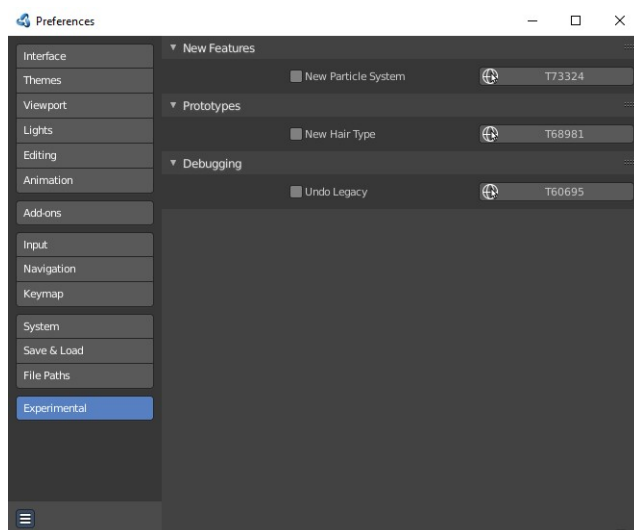



31 Data System

Table of content

Data System.....	1
Data-Blocks.....	1
Users (Garbage Collection).....	2
Fake User.....	2
Users (Sharing).....	2
Removing Data-Blocks.....	2
Data-Block Types.....	3

Data System

Each `.blend` file contains a database. This database contains all scenes, objects, meshes, textures, etc. that are in the file.

A file can contain multiple scenes and each scene can contain multiple objects. Objects can contain multiple materials which can contain many textures. It is also possible to create links between different objects.

Data-Blocks

The base unit for any Bforartists project is the data-block. Examples of data-blocks include: meshes, objects, materials, textures, node-trees, scenes, texts, brushes and even screens.

For clarity, bones, sequence strips and vertex groups are **not** data-blocks, they belong to armature, scene and mesh types respectively.

Some common characteristics:

- They're the primary contents of the `.blend` file.
- They can link to each other, for reuse and instancing. (*child/parent, object/object-data, with modifiers and constraints too*).
- Their names are unique.
- They can be added/removed/edited/duplicated.
- They can be linked between files (*only enabled for a limited set of data-blocks*)
- They can have their own animation data.
- They can have custom properties.

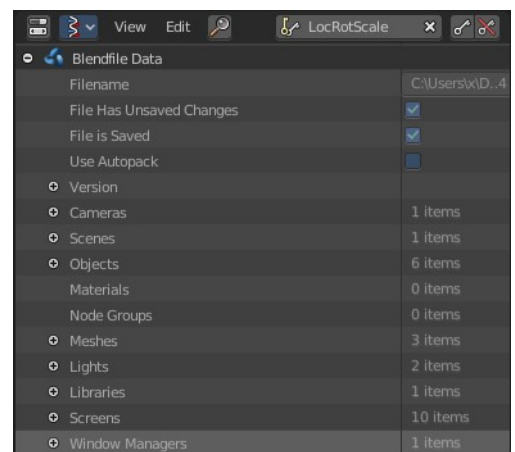

When doing more complex projects managing data-blocks becomes more important, especially when inter-linking `.blend` files.

Users (Garbage Collection)

Bforartists follows the general rule where unused data is eventually removed.

Since its common to add and remove a lot of data while working, this has the advantage of not having to manually manage every single data-block.

This works by skipping zero user data-blocks when writing `.blend` files.

In some cases you want to save a data-block even when its unused (*typically for re-usable asset libraries*). see Fake User.

Fake User

Since zero user data-blocks aren't saved. There are times when you want to force the data to be kept irrespective of its users.

If you're building a `.blend` file to serve as a library of things that you intend to link-to from *other* files, you'll need to make sure that they don't accidentally get deleted from the library file.

Do this by giving the data-blocks a *Fake User*, by pressing the *F* button next to the name of the data-block. This prevents the user count from ever becoming zero: therefore, the data-block won't be deleted. (since Bforartists doesn't keep track of how many other files link to this one.)

Users (Sharing)

Many data-blocks can be shared among other data-blocks,

Examples where sharing data is common.

- Sharing textures among materials.
- Sharing meshes between objects (instances).
- Sharing animated actions between objects, for example to make all the lights dim together.

You can also share data-blocks between files, see.

- *linked libraries*.

Removing Data-Blocks

As covered in Users (Garbage Collection), data-blocks are typically removed when they're no longer used.

There are some exceptions to this however.

The following data-blocks can be removed directly: Scene, Text, Group and Screen.

Other data-blocks such as groups and actions can be *Unlinked* from the *Outliner* context menu.

Tip

Some data (images especially) is hard to keep track of, especially since image views are counted as users.

For data-blocks that can be unlinked - hold **Shift** while pressing on the *X* button, This force-clears the user-count, so the data-block will be removed on reload.

Data-Block Types

For reference, here is a table of data-blocks types stored in `.blend` files.

Link: Library Linking, *supports being linked into other blend files.*

Pack: File Packing, *supports file contents being packed into the blend file.*

Type	Link	Pack	Description
Action	✓	✗	Stores animation F Curves. Used as data-block animation data, and the Non-Linear-Editor.
Armature	✓	✗	Skeleton used to deform meshes. Used as object-data & by the Armature Modifier.
Brush	✓	✗	Used by paint tools.
Camera	✓	✗	Used as object-data.
Curve	✓	✗	Used by camera, font & surface objects.
Font	✓	✓	References font files. Used by Font object-data.
GreasePencil	✓	✗	2D/3D sketch data. Used as overlay <i>helper</i> info, by the 3D-View, Image, Sequencer & Movie Clip editors.
Group	✓	✗	Reference object's. Used by dupli-groups & often library-linking.
Image	✓	✓	Image files. Used by textures & shader nodes.
Lamp	✓	✗	Used as object-data.
Lattice	✗	✗	Grid based lattice deformation. Used as object-data and by the Lattice Modifier.
Library	✗	✓	References to external <code>.blend</code> files. Access from the outliner's <i>Blend file</i> view.
LineStyle	✓	✗	Used by the FreeStyle render-engine.
Mask	✓	✗	2D animated mask curves. Used by compositing nodes & sequencer strip.
Material	✓	✗	Set shading and texturing render properties. Used by objects, meshes & curves.
Mesh	✓	✗	Geometry verts/edges/faces. Used as object-data.
MetaBall	✓	✗	An isosurface in 3D space. Used as object-data.
MovieClip	✓	✗	Reference to an image sequence or video file. Used in the motion-tracking editor.
NodeGroup	✓	✗	Collections of re-usable nodes. Used in the node-editor.
Object	✓	✗	An entity in the scene with location,

Type	Link	Pack	Description
			scale, rotation. Used by scenes & groups.
Particle	✓	✗	Particle settings. Used by particle systems.
Palette	✓	✗	Store color presets. Access from the paint tools.
Scene	✓	✗	Primary store of all data displayed and animated. Used as top-level storage for objects & animation.
Screen	✗	✗	Screen layout. Used by each window, which has its own screen.
ShapeKeys	✗	✗	Geometry shape storage, which can be animated. Used by mesh, curve and lattice objects.
Sounds	✓	✓	References to sound files. Used by speaker objects and the game-engine.
Speaker	✓	✗	Sound sources for a 3D scene. Used as object-data.
Text	✓	✗	Text data. Used by Python scripts and OSL shaders.
Texture	✓	✗	2D/3D textures. Used by materials, world and brushes.
World	✓	✗	Used by scenes for render environment settings.



32 Advanced - Command Line

Table of content

Command Line Arguments.....	1
Render Options.....	1
Format Options.....	2
Animation Playback Options.....	2
Window Options.....	3
Python Options.....	3
Debug Options.....	3
Misc Options.....	4
Other Options.....	5
Experimental features.....	5
Argument Parsing.....	5
Argument Order.....	5
Environment Variables.....	6

Command Line Arguments

You can start Bforartists from the command line to perform a specific task. To render in Background for example, without the graphical interface.

The general usage is: `Bforartists [arguments ...] [file] [arguments ...]`

Example - rendering an animation in background mode, allowing drivers and other scripts to run:

```
Bforartists --background --enable-autoexec my_movie.blend --render-anim
```

Or running a script with it:

```
Bforartists --myscene.blend --background --python myscript.py
```

In the background case the user-preferences are still used but you may want to override them.

- Enable with `-y` or `--enable-autoexec`
- Disable with `-Y` or `--disable-autoexec`

Note

These command line arguments can be used to start a regular Bforartists instance and will still override the user-preferences.

Render Options

- b, --background
Run in background (often used for UI-less rendering)
- a, --render-anim
Render frames from start to end (inclusive)

- S, --scene <name>
Set the active scene <name> for rendering
- f, --render-frame <frame>
Render frame <frame> and save it. +<frame> start frame relative, -<frame> end frame relative.
- s, --frame-start <frame>
Set start to frame <frame>, supports +/- for relative frames too.
- e, --frame-end <frame>
Set end to frame <frame>, supports +/- for relative frames too.
- j, --frame-jump <frames>
Set number of frames to step forward after each rendered frame
- o, --render-output <path>

Set the render path and file name. Use // at the start of the path to render relative to the blend file.

The # characters are replaced by the frame number, and used to define zero padding.

- ani_##_test.png becomes ani_01_test.png
- test-#####.png becomes test-000001.png

When the filename does not contain #, The suffix ##### is added to the filename.

The frame number will be added at the end of the filename, eg:

```
Bforartists -b foobar.blend -o //render_ -F PNG -x 1 -a
```

//render_ becomes //render_####, writing frames as //render_0001.png

- E, --engine <engine>
Specify the render engine use -E help to list available engines
- t, --threads <threads>
Use amount of <threads> for rendering and other operations [1-64], 0 for systems processor count.

Format Options

- F, --render-format <format>
Set the render format, Valid options are...
TGA IRIS JPEG MOVIE IRIZ RAWTGA AVIRAW AVIJPEG PNG BMP FRAMESERVER
(formats that can be compiled into Bforartists, not available on all systems)
HDR TIFF EXR MULTILAYER MPEG AVICODEC QUICKTIME CINEON DPX DDS
- x, --use-extension <bool>
Set option to add the file extension to the end of the file

Animation Playback Options

- a <options> <file(s)>
Playback <file(s)>, only operates this way when not running in background.
 - p <sx> <sy> Open with lower left corner at <sx>, <sy>
 - m Read from disk (Don't buffer)
 - f <fps> <fps-base> Specify FPS to start with
 - j <frame> Set frame step to <frame>
 - s <frame> Play from <frame>
 - e <frame> Play until <frame>

Window Options

- w, --window-border
Force opening with borders (default)
- W, --window-borderless
Force opening without borders
- p, --window-geometry <sx> <sy> <w> <h>
Open with lower left corner at <sx>, <sy> and width and height as <w>, <h>
- con, --start-console
Start with the console window open (ignored if -b is set), (Windows only)
- no-native-pixels
Do not use native pixel size, for high resolution displays (MacBook Retina)

Python Options

- y, --enable-autoexec
Enable automatic Python script execution
- Y, --disable-autoexec
Disable automatic Python script execution (pydrivers & startup scripts), (default).
- P, --python <filename>
Run the given Python script file
- python-text <name>
Run the given Python script text block
- python-expr <expression>
Run the given expression as a Python script
- python-console
Run Bforartists with an interactive console
- python-exit-code
Set the exit-code in [0..255] to exit if a Python exception is raised (only for scripts executed from the command line), zero disables.
- addons
Comma separated list of addons (no spaces)

Debug Options

- d, --debug

Turn debugging on
 - Enables memory error detection
 - Disables mouse grab (to interact with a debugger in some cases)
 - Keeps Python's `sys.stdin` rather than setting it to `None`
- debug-value <value>
Set debug value of <value> on startup
- debug-events
Enable debug messages for the event system
- debug-ffmpeg
Enable debug messages from FFmpeg library
- debug-handlers
Enable debug messages for event handling

- debug-libmv**
Enable debug messages from libmv library
- debug-cycles**
Enable debug messages from Cycles
- debug-memory**
Enable fully guarded memory allocation and debugging
- debug-jobs**
Enable time profiling for background jobs.
- debug-python**
Enable debug messages for Python
- debug-depsgraph**
Enable debug messages from dependency graph
- debug-depsgraph-no-threads**
Switch dependency graph to a single threaded evaluation
- debug-gpumem**
Enable GPU memory stats in status bar
- debug-wm**
Enable debug messages for the window manager, also prints every operator call
- debug-all**
Enable all debug messages (excludes libmv)
- debug-fpe**
Enable floating point exceptions
- disable-crash-handler**
Disable the crash handler

Misc Options

- factory-startup**
Skip reading the startup.blend in the users home directory
- env-system-datafiles**
Set the Bforartists_SYSTEM_DATAFILES environment variable
- env-system-scripts**
Set the Bforartists_SYSTEM_SCRIPTS environment variable
- env-system-python**
Set the Bforartists_SYSTEM_PYTHON environment variable
- nojoystick**
Disable joystick support
- noglsl**
Disable GLSL shading
- noaudio**
Force sound system to None
- setaudio**
Force sound system to a specific device NULL SDL OPENAL JACK
- h, --help**
Print this help text and exit
- R**
Register .blend extension, then exit (Windows only)
- r**
Silently register .blend extension, then exit (Windows only)
- v, --version**

Print Bforartists version and exit

--

Ends option processing, following arguments passed unchanged. Access via Python's `sys.argv`

Other Options

`/?`

Print this help text and exit (windows only)

`--debug-freestyle`

Enable debug/profiling messages from Freestyle rendering

`--debug-gpu`

Enable gpu debug context and information for OpenGL 4.3+.

`--disable-abort-handler`

Disable the abort handler

`--enable-new-depsgraph`

Use new dependency graph

`--verbose <verbose>`

Set logging verbosity level.

Experimental features

`--enable-new-depsgraph`

Use new dependency graph

Argument Parsing

Arguments must be separated by white space, eg:

```
Bforartists -ba test.blend
```

...will ignore the a

```
Bforartists -b test.blend -f8
```

...will ignore 8 because there is no space between the -f and the frame value

Argument Order

Arguments are executed in the order they are given. eg:

```
Bforartists --background test.blend --render-frame 1 --render-output '/tmp'
```

...will not render to /tmp because `--render-frame 1` renders before the output path is set

```
Bforartists --background --render-output /tmp test.blend --render-frame 1
```

...will not render to /tmp because loading the blend file overwrites the render output that was set

```
Bforartists --background test.blend --render-output /tmp --render-frame 1
```

...works as expected.

Environment Variables

Bforartists_USER_CONFIG:

Directory for user configuration files.

Bforartists_USER_SCRIPTS:

Directory for user scripts.

Bforartists_SYSTEM_SCRIPTS:

Directory for system wide scripts.

Bforartists_USER_DATAFILES:

Directory for user data files (icons, translations, ..).

Bforartists_SYSTEM_DATAFILES:

Directory for system wide data files.

Bforartists_SYSTEM_PYTHON:

Directory for system python libraries.

TEMP:

Store temporary files here.

TMP:

or \$TMPDIR Store temporary files here.

SDL_AUDIODRIVER:

LibSDL audio driver - alsa, esd, dma.

PYTHONHOME:

Path to the python directory, eg. /usr/lib/python.



33 Advanced - Scripting & Extending Bforartists

Table of content

- Scripting & Extending Bforartists.....1
- Python.....1
- Extending Bforartists.....1
- Scripting & Security.....2
- Scripts in Blend Files.....2
- Auto Execution.....2
- Manual Execution.....2
- Controlling Script Execution.....2
- BAM Asset Manager.....3
- Installing BAM.....3
- bam pack.....3
- Examples.....4
- bam remap.....5
- Subcommands.....6
- remap start.....6
- remap finish.....6
- remap reset.....6

Scripting & Extending Bforartists

Python

Python is an interpreted, interactive, object-oriented programming language.

Python scripts are a way to extend Bforartists functionality. Most areas of Bforartists can be scripted, including Animation, Rendering, Import and Export, Object Creation and the scripting of repetitive tasks.

This can be done by the Blender Python API (Application Programming Interface). It comes also with an introduction to scripting and some examples. <https://docs.blender.org/api/blender2.8/index.html>

Extending Bforartists

You can either write scripts, and perform them in the text editor. Scripts must be loaded and executed from scratch every time you need them. Or you can write complete addons. Addons can be activated, and loads with Bforartists.

You can find quite a few example scripts in the text editor in the file menu.

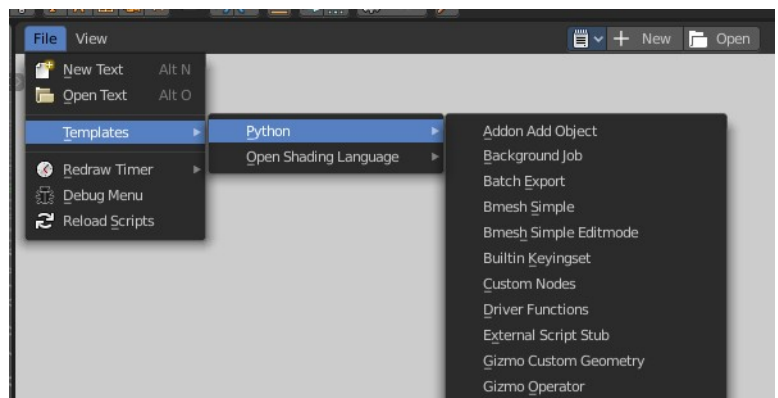

Scripting & Security

The ability to include Python scripts within blend files is valuable for advanced tasks such as rigging, automation and using the game-engine, however it poses a security risk since Python doesn't restrict what a script can do.

Therefore, you should only run scripts from sources you know and trust.

Automatic execution is disabled by default, however some blend files need this to function properly.

When a blend file tries to execute a script and is not allowed, a message will appear in the header with the option to **Reload Trusted** or **Ignore** the message.

Scripts in Blend Files

Auto Execution

Here are the different ways blend files may automatically run scripts.

Registered Text-Blocks

A text block can have its *Register* option enabled which means it will load on start.

Animation Drivers

Python expressions can be used to *Drive* values and are often used in more advanced rigs and animations.

Game Engine Auto-Start

Scripts are often used for game logic, blend files can have *Auto Start* enabled with runs the game on load.

Manual Execution

There are other ways scripts in a blend file may execute that require user interaction (therefor will run even when auto-execution is off), but you should be aware that this is the case since it's not necessarily obvious.

- Running a script in the text editor (*ok, this is obvious!*).
- Rendering with FreeStyle - *FreeStyle uses scripts to control line styles*
- Running the Game-Engine.

Controlling Script Execution

Blender files can also contain scripts. Which can be auto run when you load the blend file. Auto running scripts can be a security issue. There are two ways to control script execution in blend files. In the load dialog for a blend file. Or in the Preferences.

In the Blender file selector you will see down left the checkbox **Trusted source**.

Enable it to allow auto execution of the scripts in the blend file.

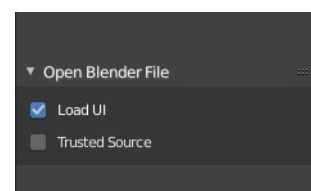

Auto-Run Python Scripts in the Preferences in the Save & Load Panel allows you to run scripts in blend files automatically.

The Excluded Paths edit box below allows you to exclude certain directories. You can for example exclude the download directory. And allow auto run from all other directories at your computer.

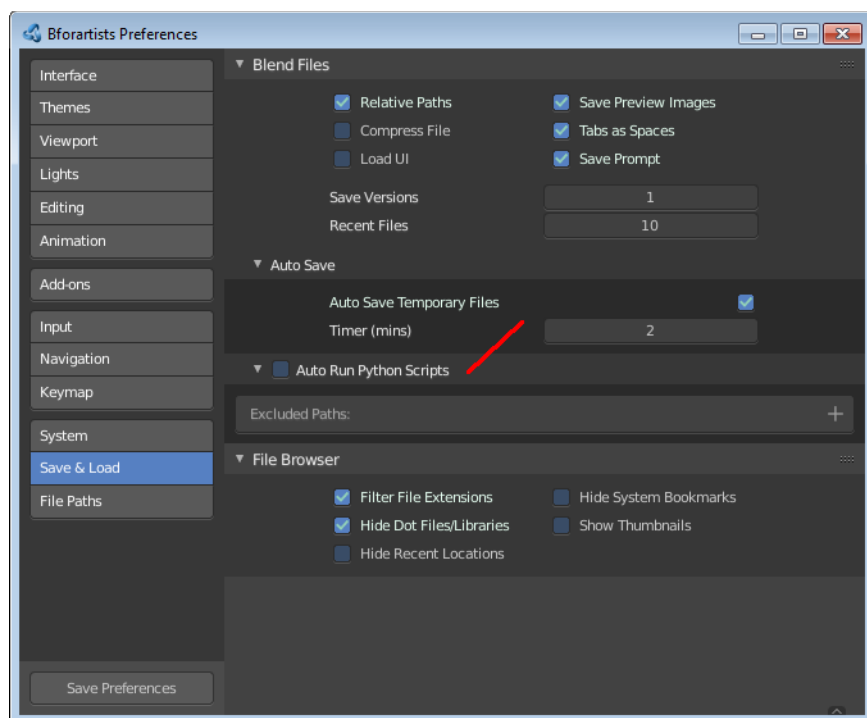

BAM Asset Manager

Refactoring linked .blend files is a common practice in a production environment. While some basic operations can be accomplished within Blender, sometimes it is more practical to perform them on the command line or via a script. During the production of Cosmos Laundromat (Gooseberry Open Movie Project) the *BAM Asset Manager* (BAM) was developed. The original scope of BAM included client-server asset management tools going beyond Blender, but it was later refocused on core utilities to perform two operations:

- blendfile packing
- automatic dependencies remapping

Installing BAM

BAM is a standalone Python package, that can be run on any system without any particular configuration. The only requirement is Python 3 (and pip, the Python package manager, to easily install BAM).

Windows, Linux and macOS provide different ways to install Python 3 and pip. Check out the online docs to learn more about a specific platform.

Once Python 3 and pip are available, BAM can be installed via command line by typing:

```
pip3 install blender-bam
```

After a successful installation, the *bam* command will be available. By typing it and pressing the Enter key, all the available sub commands will be displayed.

bam pack

This command is used for packing a .blend file and *all* its dependencies into a .zip file for redistribution.

```
usage: bam pack [-h] [-o FILE] [-m MODE] [-e PATTERNS] [-a] [-q] [-c LEVEL]
           paths [paths ...]
```

You can simply pack a blend file like this to create a zip-file of the same name.

```
bam pack /path/to/scene.blend
```

You may also want to give an explicit output directory. The example shows how to pack a blend with maximum compression for online downloads

```
bam pack /path/to/scene.blend --output my_scene.zip --compress=best
```

The command provides several options to adapt to different workflows (final distribution, partial extraction, rendering).

-o, --output <FILE>

Output file or a directory when multiple inputs are passed

-m, --mode <MODE>

Output file or a directory when multiple inputs are passed. Possible choices: ZIP, FILE

-e, --exclude <PATTERN(S)>

Optionally exclude files from the pack.

```
--exclude="*.png"
```

Using Unix shell-style wildcards (*case insensitive*).

```
--exclude="*.txt;*.avi;*.wav"
```

Multiple patterns can be passed using the ; separator.

-a, --all-deps

Follow all dependencies (unused indirect dependencies too)

-q, --quiet

Suppress status output

-c, --compress <LEVEL>

Compression level for resulting archive Possible choices: default, fast, best, store

--repo <DIR PATH>

Specify a “root” path from where to pack the selected file. This allows for the creation of a sparse copy of the production tree, without any remapping.

--warn-external

Report external libraries errors (missing paths)

Examples

Consider the following directory layout, and in particular the file *01_01_A.lighting.blend* with its linked libraries.

```
~/agent327/
├─ lib/
│  ├─ chars/
│  │  ├─ agent.blend ----->|
│  │  ├─ boris.blend ----->|
│  │  └─ barber.blend ----->|
│  └─ scenes/
│     ├─ 01-opening ----->|
│     ├─ 01_01_A.lighting.blend <--| < BAM pack this file
│     └─ 01_01_A.anim.blend ----->|
```

Once we run `bam pack /scenes/01-opening/01_01_A.lighting.blend` we obtain a `01_01_A.lighting.zip` inside of which we find the following structure.

```
~/01_01_A.lighting
├── 01_01_A.lighting.blend
│   └── /
│       ├── 01_01_A.anim.blend
│       └── lib/
│           └── chars/
│               ├── agent.blend
│               └── boris.blend
```

Note how all paths have been remapped relative to the placement of `01_01_A.lighting.blend` in the root of the output. If we run `bam pack /scenes/01-opening/01_01_A.lighting.blend --repo ~/agent327`, the output will be different.

```
~/01_01_A.lighting
├── lib/
│   ├── chars/
│   │   ├── agent.blend
│   │   └── boris.blend
├── scenes
│   └── 01-opening/
│       ├── 01_01_A.lighting.blend < The BAM packed file
│       └── 01_01_A.anim.blend
```

In this case no path is remapped, and we simply strip out any file that is not referenced as a direct or indirect dependency of `01_01_A.lighting.blend`. This is effectively a sparse copy of the original production tree.

bam remap

Remap blend file paths

usage: `bam remap [-h] {start,finish,reset} ...`

This command is a 3 step process:

- first run `bam remap start .` which stores the current state of your project (recursively).
- then re-arrange the files on the file system (rename, relocate).
- finally run `bam remap finish` to apply the changes, updating the `.blend` files internal paths.

```
cd /my/project
```

```
bam remap start .
mv photos textures
mv barbershop_v14_library.blend barberhop_libraray.blend
bam remap finish
```

Note

Remapping creates a file called `bam_remap.data` in the current directory. You can relocate the entire project to a new location but on executing `finish`, this file must be accessible from the current directory.

Note

This command depends on files unique contents, take care not to modify the files once remap is started.

Subcommands

remap start

Start remapping the blend files

usage: bam remap start [-h] [-j] [paths [paths ...]]

-j, --json

Generate JSON output

remap finish

Finish remapping the blend files

usage: bam remap finish [-h] [-r] [-d] [-j] [paths [paths ...]]

-r, --force-relative

Make all remapped paths relative (even if they were originally absolute)

-d, --dry-run

Just print output as if the paths are being run

-j, --json

Generate JSON output

remap reset

Cancel path remapping

usage: bam remap reset [-h] [-j]



34 Advanced - Working Limits

Table of content

Working Limits.....	1
Space.....	1
Time.....	1
Text Fields.....	2

Working Limits

There are some limits that you should take into account. Precision issues when working with mesh data for example.

Space

While object positions, vertex locations are not clamped, larger values become increasingly imprecise.

To get an idea of the precision you can work with using different scales.

Here's a table of scales and their associated accuracy.

10:	1/1,048,576 th
100:	1/131,072 th
1,000:	1/16,384 th
10,000:	1/1,024 th
100,000:	1/128 th
1,000,000:	1/16 th

Hint

For a rough rule of thumb, values within -5,000/+5,000 are typically reliable (range of 10,000).

Internally *single precision* floating point calculations are used.

Time

The maximum number of frames for each scene is currently 500,000, and allows for continuous shots for duration's of:

24 fps: 5 hours, 47 seconds.

25 fps: 5 hours, 33 seconds.

30 fps: 4 hours, 37 seconds.

60 fps: 2 hours, 18 seconds.

Note

In practice, a finished work is typically composed of output from many scenes. So this limit does not prevent you from creating longer works.

Text Fields

Fixed strings are used internally, and while it is not useful to list all limits, here are some common limits. *Text fields are used for various things like data-block names, modifiers, vertex-groups, UV-layers...*

directory:	767 characters
file-name:	255 characters
file-path:	1023 characters
identifier:	63 characters

Note

Multi-byte encoding means some Unicode characters use more than a single ASCII character.



35 Bforartists Addons

Table of content

- Bforartists Addons.....1
- Default Addons.....1
 - Activated Addons:.....1
 - Official.....1
 - Community.....2
- Included Addons.....2
 - Import-Export: Bforartists Default Asset Library.....3
 - Mesh: Mesh Tools – Bforartists version.....3
 - Mesh: Smart Delete bfa.....3
 - Paint: Bforartists Brush Panel.....3
 - User Interface: Important Hotkeys BFA.....3
 - User Interface: Toolbar Settings Bforartists.....4
 - Utility: X Ray Weight Paint.....4
 - View: 3D View Reset.....4

Bforartists Addons

Bforartists comes with default and included addons to help improve the user experience. Some of these can be activated by the user and saved in the preferences for daily use. Many addons are shipped which include specific user experience improvements. Feel free to activate and use when necessary.

Default Addons

These addons are turned on by default and shipped with Bforartists. Most come directly from the Blender repository. These addons are split into official and community addons.

Activated Addons:

Official

- Animation: Pose Library
- Import-Export: BioVision Motion Capture (BVH) format
- Import-Export: FBX format
- Import-Export: STL format
- Import-Export: Scalable Vector Graphics (SVG) 1.1 format

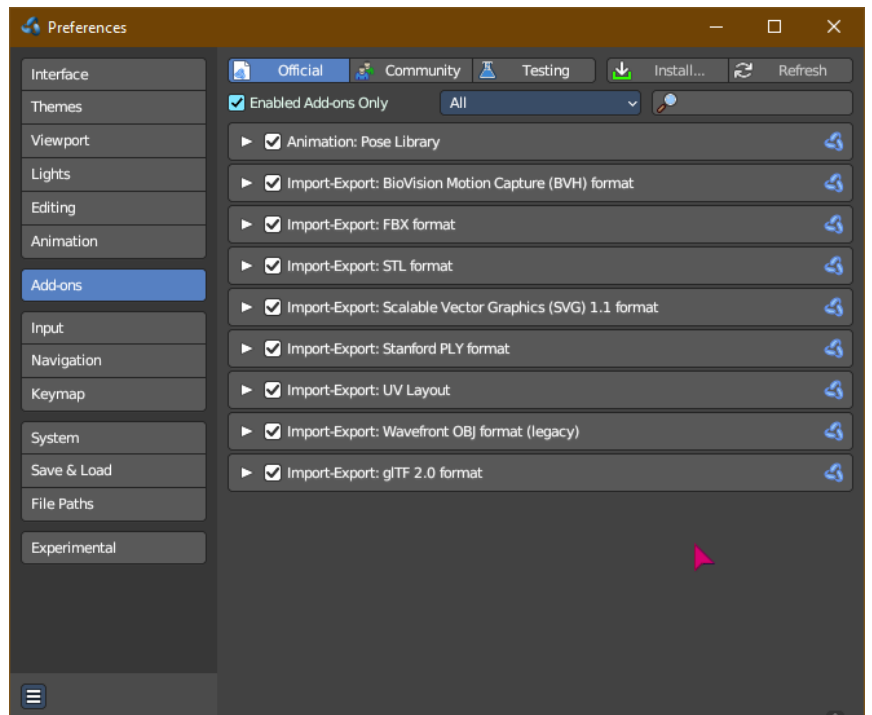

- Import-Export: Stanford PLY format
- Import-Export: UV Layout
- Import-Export: Wavvefront OBJ format (legacy)
- Import-Export: glTF 2.0 format

Community

- Create: Create IsoCam
- Import-Export: Bforartists Default Asset Library
- Import-Export: Web3d X3D/VRML2 format
- Mesh: Mesh Tools – Bforartists version
- Mesh: Smart Delete bfa
- User Interface: Align View Buttons
- User Interface: Important Hotkeys BFA
- User Interface: Toolbar Settings Bforartists
- View: 3D View Reset

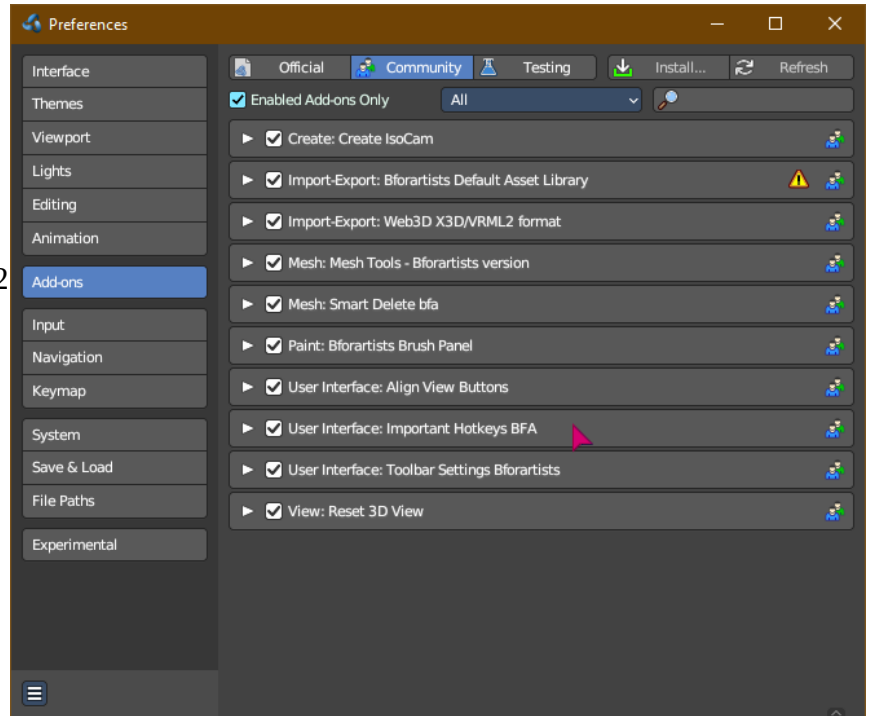

Note

To activate/deactivate an addon, go to Edit – Preferences – Addons tab – and untick any activated addons. If you'd like to keep your addons for future use, you can either **save the preferences**, or activate them on demand per workspace in the workspace settings in the property shelf.

Included Addons

Bforartists has included custom addons to improve the user experience. Most are activated by default, some are optional.

- Import-Export: Bforartists Default Asset Library

- Mesh: Mesh Tools – Bforartists version
- Mesh: Smart Delete bfa
- Paint: Bforartists Brush Panel
- User Interface: Important Hotkeys BFA
- User Interface: Toolbar Settings Bforartists
- Utility: X Ray Weight Paint
- View: 3D View Reset

Import-Export: Bforartists Default Asset Library

This addon is activated by default. This includes a default asset library shipped with Bforartists. To know more about what this library includes and how to access it, refer to chapter **28.1 Asset Browser – Default Asset library**

Mesh: Mesh Tools – Bforartists version

This addon is activated by default. This addon is a default Blender addon that has been modified to work with Bforartists in a better integrated way.

Mesh: Smart Delete bfa

This addon is activated by default. This addon improves the user experience of deleting geometry, so that you can save a few clicks every time you want to remove geometry. Now it detects what you have selected and removes it in a predictable way. To use it, press DEL on selected geometry.

This addon is thanks to Reiner.

Paint: Bforartists Brush Panel

This addon is optional and deactivated by default. This adds a Brush Tab to most painting and drawing modes and objects. This includes panels per brush operator listing all brush types dynamically, including all listed brushes. This also includes custom icons and is responsive per the toolshelf standards.

This addon is thanks to Iyad Ahmed and Draise.

User Interface: Important Hotkeys BFA

This addon is activated by default. This addon includes a button to show important hotkeys as an overlay in the 3D View, showing hotkeys.

This addon is thanks to Reiner.



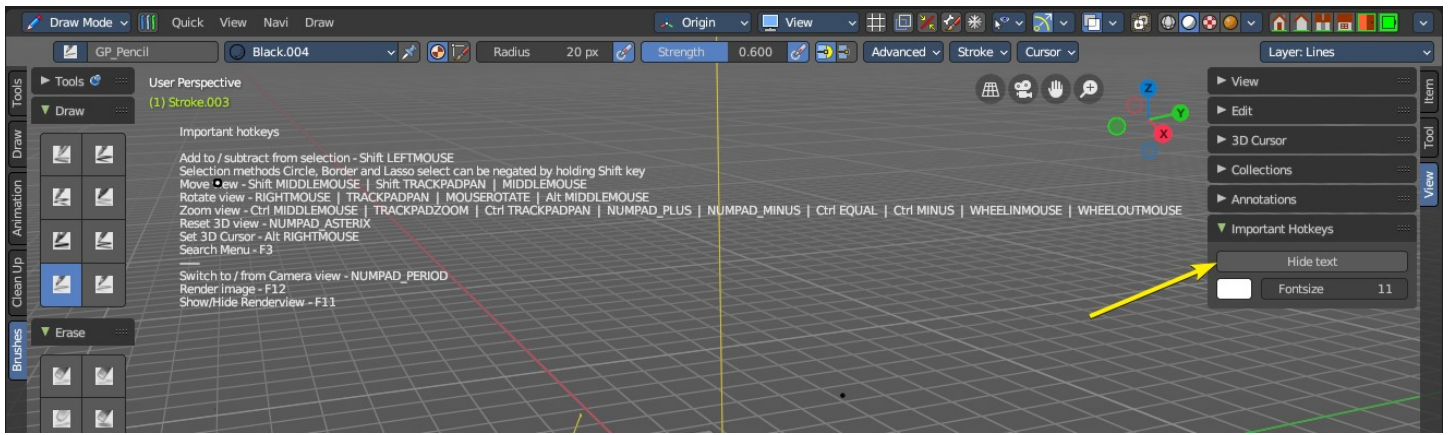

User Interface: Toolbar Settings Bforartists

This addon is activated by default. This stores the toolbar settings. Do not turn off.

Utility: X Ray Weight Paint

This addon is optional and deactivated by default. This addon helps automate the process of setting up xray painting for armature weight painting. This helps set up various user settings for a desired user experience.

This addon is thanks to Blender Boi. You can find the repository here: <https://github.com/BlenderBoi/XRayWeightPaint->

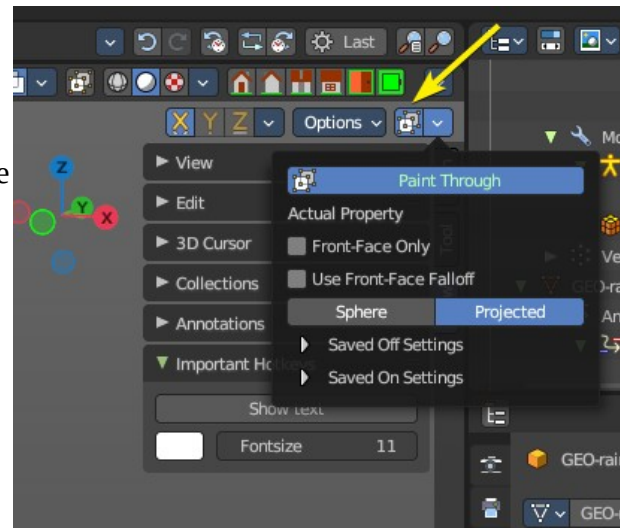

View: 3D View Reset

This addon is activated by default. This adds an operator to the interface to reset the view – both accessible in the 3D View – View header menu entry and the optional header buttons to the top right. You can alternatively use the * key on the Numpad.

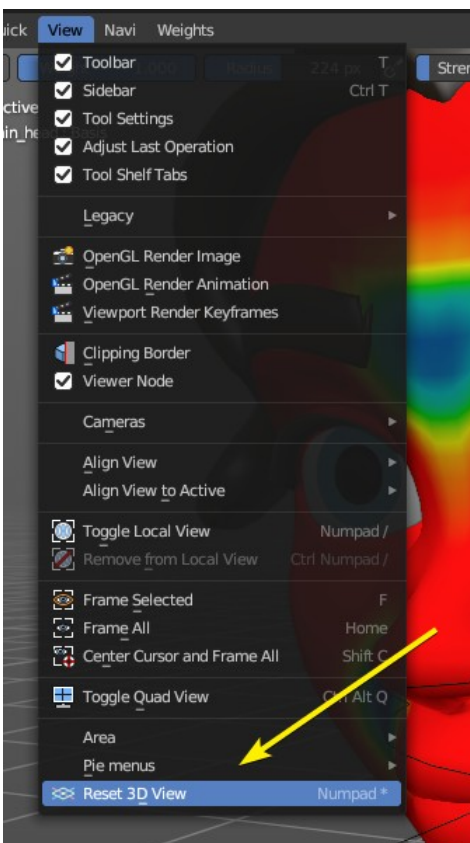



35.1 Bforartists Brush Panels

Table of content

Bforartists Brush Panel.....	2
Use.....	2
Brush Panels and Modes.....	3
Mesh Objects.....	3
Sculpt Mode.....	3
Draw.....	3
Draw Sharp.....	3
Clay.....	3
Clay Strips.....	3
Layer.....	3
Inflate.....	3
Blob.....	3
Crease.....	3
Smoothing.....	4
Flatten.....	4
Fill.....	4
Scrape.....	4
Multiplane Scrape.....	4
Pinch.....	4
Grab.....	4
Elastic Deformation.....	4
Snake Hook.....	4
Thumb.....	4
Pose.....	4
Nudge.....	4
Rotate.....	4
Topology.....	4
Boundary.....	5
Cloth.....	5
Simplify.....	5
Mask.....	5
Draw Face Sets.....	5
Displacement Erase.....	5
Displacement Smear.....	5
Paint.....	5
Vertex Paint.....	5
Draw.....	5
Smear.....	5
Average.....	5
Blur.....	5
Weight Paint.....	6
Draw.....	6
Smear.....	6
Average.....	6
Blur.....	6
Texture Paint.....	6
Draw.....	6

Soften.....	6
Smear.....	6
Clone.....	6
Fill.....	6
Mask.....	6
Grease Pencil.....	6
Draw Mode.....	7
Draw.....	7
Erase.....	7
Fill.....	7
Tint.....	7

Bforartists Brush Panel

This addon is optional and deactivated by default.

This adds a **Brushes Tab** to most painting and drawing modes and objects. This includes an individual panel per brush operator listing all brush types dynamically, including all user created brushes. This also includes the ability to display custom icons and is responsive per the toolshelf standards.

Note

To activate/deactivate an addon, go to Edit – Preferences – Addons tab – and untick any activated addons.

If you'd like to keep your addons for future use, you can either **save the preferences**, or activate them on demand per workspace in the workspace settings in the property shelf.

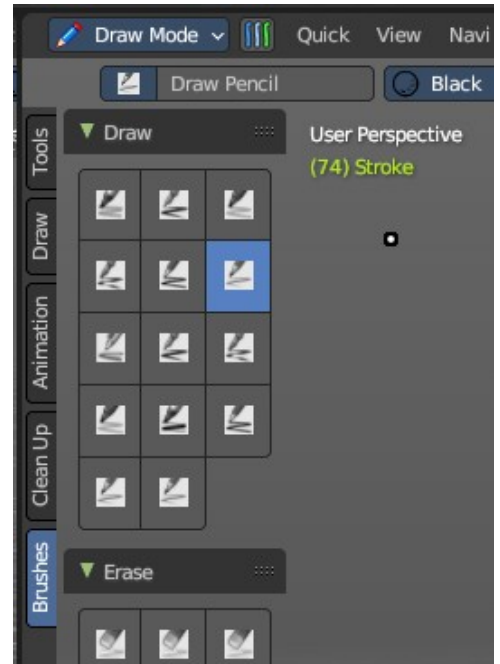

Use

To use, go into a paint mode (**Sculpt, Texture Paint, Vertex Paint, Weight Paint or Grease Pencil Draw Mode**), select the Brush tab in the Tool Shelf to the left, and then select a brush. When you select a brush, the button will automatically select the brush operator and select the brush type stored in the brush library. You can link/append and create any new brush type for later use – you can also assign iconography on demand.

If you don't see the toolshelf tabs, go to View and turn on Tool Shelf Tabs.

To add brushes, you can use the add button in the Property Shelf under the Tool tab or in the Header brush type dropdown, you can add new brushes or remove brushes.

Note

Keep in mind a removed brush is still stored in orphan data till you purge data or save and reload the file. If brush type contains a (fake) user, this brush will

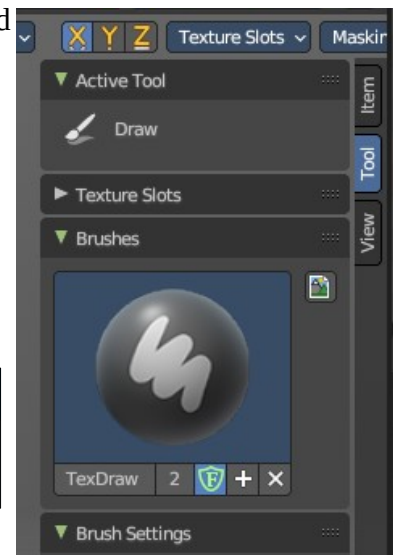

not be purged from the file.

To add icons to brushes, in the Brushes panel in the Tool tab of the Property Shelf, you can use the Custom Icon to load any image as a brush icon.

You can find the Brush tab and panels in the **3D View Editor** or the **Image Editor** with the correct painting modes.

For more information, please refer to the relevant chapters on the painting modes per object type.

Brush Panels and Modes

Mesh Objects

These brush panels are included with all mesh object painting modes.

Sculpt Mode

The Sculpt mode activated from the top left of the 3D View or by hotkey.

Draw

All Draw brush types.

Draw Sharp

All Draw Sharp brush types.

Clay

All Clay brush types.

Clay Strips

All Clay Strips brush types.

Layer

All Layer brush types.

Inflate

All Inflate brush types.

Blob

All Blob brush types.

Crease

All Crease brush types.



Smoothing

All Smoothing brush types.

Flatten

All Flatten brush types.

Fill

All Fill brush types.

Scrape

All Scrape brush types.

Multipane Scrape

All Multipane Scrape brush types.

Pinch

All Pinch brush types.

Grab

All Grab brush types.

Elastic Deformation

All Elastic Deformation brush types.

Snake Hook

All Snake Hook brush types.

Thumb

All Thumb brush types.

Pose

All Pose brush types.

Nudge

All Nudge brush types.

Rotate

All Rotate brush types.

Topology

All Topology brush types.

Boundary

All Boundary brush types.

Cloth

All Cloth brush types.

Simplify

All Simplify brush types.

Mask

All Mask brush types.

Draw Face Sets

All Draw Face Sets brush types.

Displacement Erase

All Displacement Erasebrush types.

Displacement Smear

All Displacement Smear brush types.

Paint

All Paint brush types.

Vertex Paint

The Vertex Paint mode activated from the top left of the 3D View or by hotkey.

Draw

All Draw brush types.

Smear

All Smear brush types.

Average

All Average brush types.

Blur

All Blur brush types.

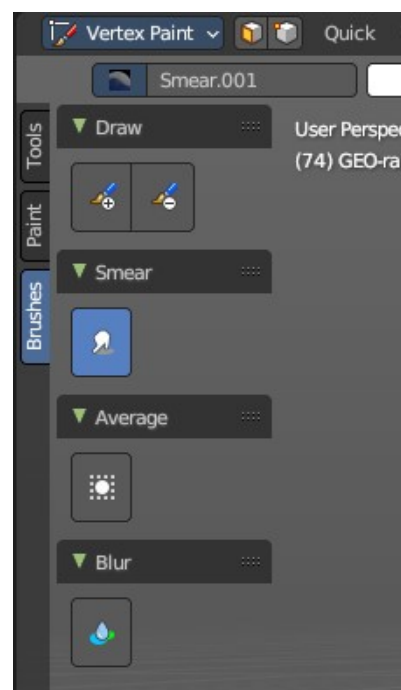

Weight Paint

The Weight Paint mode activated from the top left of the 3D View or by hotkey.

Draw

All Draw brush types.

Smear

All Smear brush types.

Average

All Average brush types.

Blur

All Blur brush types.

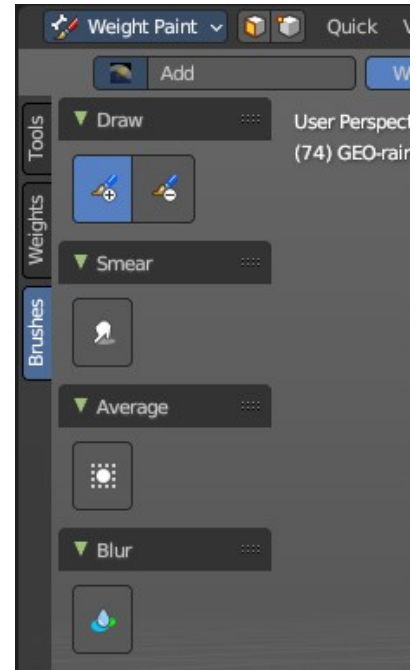

Texture Paint

The Texture Paint mode activated from the top left of the 3D View or by hotkey.

Draw

All Draw brush types.

Soften

All Soften brush types.

Smear

All Smear brush types.

Clone

All Clone brush types.

Fill

All Fill brush types.

Mask

All Mask brush types.

Grease Pencil

These brush panels are included with the Grease Pencil object Draw Mode.



Draw Mode

The draw mode activated from the top left of the 3D View or by hotkey.

Draw

All Draw brush types.

Erase

All Erase brush types.

Fill

All Fill brush types.

Tint

All Tint brush types.



36 Troubleshooting

Table of content

- Troubleshooting.....1
- Troubleshooting the 3D View.....1
 - Objects Invisible in Camera View.....1
 - Performance.....1
 - Slow Selection.....1
 - Navigation.....2
 - Lost in Space.....2
 - Invisible Limit Zooming In.....2
 - Tools.....2
 - Invalid Selection.....2
- Troubleshooting Graphics Hardware.....3
 - Performance.....3
- Troubleshooting Crashes.....4
- Recovering from mistakes or problems.....4
 - Options for Files (System Level).....5
 - Save and Auto Save.....5
 - Recovering Auto Saves.....6
 - Recover Last Session.....6
 - Recover Auto Save.....6
- Compatibility (OSX).....6
 - Mouse Motion Jitters (SmoothMouse).....6
- Compatibility (Windows).....6
 - Bforartists Hangs on Window Duplication (Nahimic for MSI).....6

Troubleshooting

There are some common problems in Bforartists. Before you proceed make sure your computer meets the minimum requirements. And make sure your drivers are up to date and your graphics card is supported.

Troubleshooting the 3D View

Objects Invisible in Camera View

If you have a large scene, viewing it through Camera View may not display all of the Objects in the scene. One possibility may be that the clipping distance of the camera is too low. The camera will only show objects that fall within the clipping range.

Performance

Slow Selection

Bforartists uses OpenGL drawing for selection, some graphics card drivers are slow at performing this operation.

This becomes especially problematic on dense geometry.

Possible Solutions:

OpenGL Occlusion Queries (User Preference)

See User Preferences ▶ System ▶ Selection

This option defaults *Automatic*, try setting this to *OpenGL Occlusion Queries*, since there is a significant performance difference under some configurations.

Upgrade OpenGL Driver

In some cases slow selection is resolved by using updated drivers. *It's generally good to use recent drivers when using 3D software.*

Select Centers (Workaround)

In *Object Mode*, holding `Ctrl` while selecting uses the object center point. While this can be useful on its own, it has the side-effect of not relying on OpenGL selection.

Change Draw Modes (Workaround)

Using *Wireframe* or even *Bounding Box* draw modes can be used to more quickly select different objects.

Note

Obviously the workarounds listed here aren't long term solutions, but it's handy to know if you're stuck using a system with poor OpenGL support.

Ultimately, if none of these options work out it may be worth upgrading your hardware.

Navigation

Lost in Space

When navigating your scene, you may accidentally navigate away from your scene and find yourself with a blank view-port.

The solution is to use the Reset 3D View operator in the View menu. This resets the 3D view to the initial state.

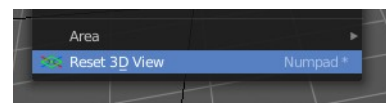

Invisible Limit Zooming In

This problem lies in the nature of the default zooming method. It zooms towards a point in the scene. And when it reaches this point, then it cannot zoom any further.

One solution is to zoom out and move towards the object instead of zooming.

You can also try some other zoom methods. Dolly or Border Zoom doesn't have these problems.

Tools

Invalid Selection

There are times when selection fails under some configurations, often this is noticeable in mesh *Edit Mode*, selecting vertices/edges/faces where random elements are selected.

Internally Bforartists uses OpenGL for selection, so the graphics card driver is relied on giving correct results.

Possible Solutions:

Disable Anti-Aliasing (FSAA, Multi-Sampling)

This is by far the most common cause of selection issues.

There are known problems with some graphics cards when using FSAA/multi-sampling.

You can disable this option by:

- Turning FSAA/multi-sampling off in your graphics card driver options.
- Turning *Multi-Sampling* off in the system preferences.

Change Anti-Aliasing Sample Settings

Depending on your OpenGL configuration, some specific sample settings may work, while others fail.

Unfortunately finding working configuration involves trial & error testing.

Upgrade OpenGL Driver

As with any OpenGL related issues, using recent drivers can resolve problems.

However it should be noted that this is a fairly common problem and remains unresolved with many drivers.

Troubleshooting Graphics Hardware

Bforartists makes use of OpenGL, which is typically hardware accelerated.

This means issues with the graphics card hardware and drivers can impact on Bforartists's behavior. This page lists some known issues using Bforartists on different graphics hardware and how to trouble-shoot them.

Performance

When the entire interface very slow and unresponsive (*even with the default startup scene*). This is likely a problem with the OpenGL configuration.

Unfortunately in this situation you may have to do some of your own tests to find the cause, here are some common causes and possible solutions.

Upgrade your OpenGL Driver

If you're experiencing any strange graphics problems with Bforartists, its always good to double check you're using the latest drivers.

Disable Anti-Aliasing (FSAA, Multi-Sampling)

See Invalid Selection, Disable Anti-Aliasing.

Change the Window Draw Method

This is set in the system preferences. Its selected automatically, however when experiencing problems its worth checking if changing this resolves interface drawing problems.

Troubleshooting Crashes

Like every other software, Bforartists can crash. The most common causes of Bforartists crashes are.

- Running out of memory.
- Issues with graphics hardware/drivers.
- Bugs in Bforartists.

Firstly, you may be able to recover your work with File ▶ Recover Last Session.

To prevent the problem from happening again, you can check that the graphics drivers are up to date, upgrade your machine's hardware (the RAM or graphics card), and disable some options that are more memory intensive:

- Disable *Region Overlap* and *Triple buffering* at User Preferences ▶ System ▶ Window Draw Method.
- Using multi sample, anti-aliasing also increase the memory usage and make display slower.
- On Linux, the Window Manager (KDE, Gnome, Unity) may be using hardware accelerated effects (eg. window shadows and transparency) that are using up the memory that Bforartists needs. Try disabling the desktop effects or switch to a light-weight Window Manager.

Recovering from mistakes or problems

Bforartists provides a number of ways for the user to recover from mistakes, and reduce the chance of losing their work in the event of operation errors, computer failures, or power outages. There are two ways for you to recover from mistakes or problems:

At the User Level (Relating to *Actions*)

- For your actions, there are options like *Undo*, *Redo* and an *Undo History*, used to roll back from mistakes under normal operation, or return back to a specific action.
- Bforartists also has new features like *Repeat* and *Repeat History*, and the new *Redo Last* which you can use in conjunction with the options listed.

At the System Level (Relating to *Files*)

- There are options to save your files like *Auto Save* that saves your file automatically over time, and *Save on Quit*, which saves your Bforartists file automatically when you exit Bforartists.

Note

In addition to these functions being enabled by default, the *Save on Quit* functionality cannot be disabled.

As a general rule for every software usage: save often, save very often, and don't forget to save often!

Options for Files (System Level)

Save and Auto Save

Computer crashes, power outages or simply forgetting to save can result in the loss or corruption of your work. To reduce the chance of losing files when those events occur, Bforartists can use an *Autosave* function. The *Save and Load* tab of the *User Preferences* window allows you to configure the two ways that Bforartists provides for you to regress to a previous version of your work.

Save on Quit

The function *Save on Quit* is enabled by default in Bforartists. Bforartists will always save your files when you quit the application under normal operation.

Save Versions

This option tells Bforartists to keep the indicated number of saved versions of your file in your current working directory when you manually save a file. These files will have the extension: `.blend1`, `.blend2`, etc., with the number increasing to the number of versions you specify. Older files will be named with a higher number. e.g. With the default setting of `2`, you will have three versions of your file: `*.blend` (your last save), `*.blend1` (your second last save) and `*.blend2` (your third last save).

Auto Save Temporary Files

Checking this box tells Bforartists to *automatically* save a backup copy of your work-in-progress to the Temp directory (refer to the *File* panel in the *User Preferences* window for its location). This will also enable the *Timer (mins)* control which specifies the number of minutes between each Auto Save. The default value of the Bforartists installation is `5` (5 minutes). The minimum is `1`, and the Maximum is `60` (Save at every one hour). The Auto Saved files are named using a random number and have a `.blend` extension.

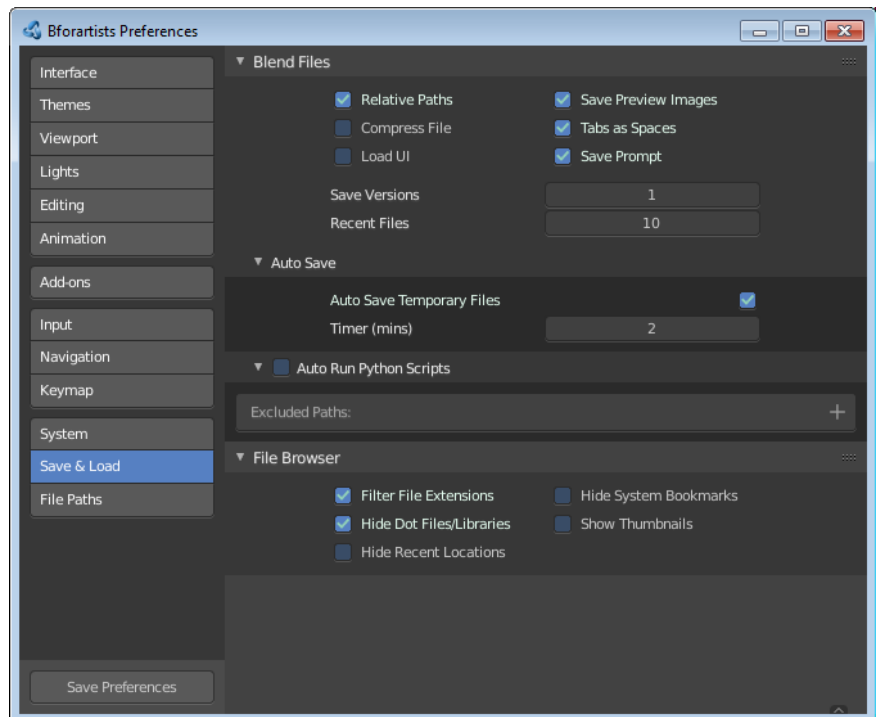

Tip

Compress Files

The option to Compress files will try to compact your files whenever Bforartists is saving them. Large Scenes, dense Meshes, big Textures or lots of elements in your Scene will result in a big `.blend` being created. This option could slow down Bforartists when you quit, or under normal operation when Bforartists is saving your backup files. In fact, using this option you will trade processor time for file space.

Recovering Auto Saves

Recover Last Session

File ▶ Recover Last Session will open the quit .blend that is saved into the *Temp* directory when you exit Bforartists. Note that files in your *Temp* directory are deleted when you reboot.

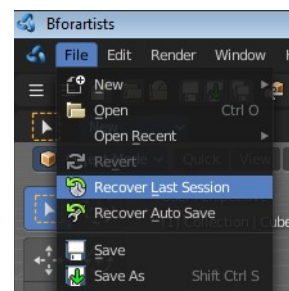

Recover Auto Save

File ▶ Recover Auto Save... allows you to open the Auto Saved file. After loading the Auto Saved version, you may save it over the current file in your working directory as a normal .blend file.

Recover Autosave will open the file browser.

Important

When recovering an Auto Saved file, you will lose any changes made since the last *Auto Save* was performed. Only **one** Auto Saved file exists for each project (i.e. Bforartists does not keep older versions - hence you won't be able to go back more than a few minutes with this tool).

Compatibility (OSX)

Mouse Motion Jitters (SmoothMouse)

Problem

When grabbing an object or orbiting the view, cursor motion is jittery.

Solutions

- Uninstall **SmoothMouse**.
- Disable Continuous Grab

Compatibility (Windows)

Bforartists Hangs on Window Duplication (Nahimic for MSI)

Problem

Accessing Window ▶ Duplicate Window, hangs Bforartists, using 100% of one core.

Solution

Uninstall **Nahimic for MSI**



37 Glossary

This page lists definitions for terms used in Bforartists and this manual.

Action Safe

Area of the screen visible on most devices. Place content inside it to ensure it does not get cut off.

Active

When many items are selected, the last selected item will be the active one. Used in situations where the interface only shows options for one item at a time.

Aliasing

Rendering artifacts in the form of jagged lines.

Alpha Channel

Additional channel in an image for transparency.

Straight Alpha

Method where RGBA channels are stored as (R, G, B, A) channels, with the RGB channels unaffected by the alpha channel. This is the alpha type used by paint programs such as Photoshop or Gimp, and used in common file formats like PNG, BMP or Targa. So, image textures or output for the web are usually straight alpha.

Premultiplied Alpha

Method where RGBA channels are stored as $(R \times A, G \times A, B \times A, A)$, with the alpha multiplied into the RGB channel.

This is the natural output of render engines, with the RGB channels representing the amount of light that comes toward the viewer, and alpha representing how much of the light from the background is blocked. The OpenEXR file format uses this alpha type. So, intermediate files for rendering and compositing are often stored as premultiplied alpha.

Conversion (Straight/Premultiplied) Alpha

Conversion between the two alpha types is not a simple operation and can involve data loss, as both alpha types can represent data that the other cannot, though it is often subtle.

Straight alpha can be considered to be an RGB color image with a separate alpha mask. In areas where this mask is fully transparent, there can still be colors in the RGB channels. On conversion to premultiplied alpha, this mask is applied and the colors in such areas become black and are lost.

Premultiplied alpha, on the other hand, can represent renders that are both emitting light and letting through light from the background. For example, a transparent fire render might be emitting light, but also letting through all light from objects behind it. On converting to straight alpha, this effect is lost.

Ambient Light

The light that comes from the surrounding environment as a whole.

Ambient Occlusion

A ratio of how much ambient light a surface point would be likely to receive. If a surface point is under a foot or table, it will end up much darker than the top of someone's head or the tabletop.

Animation

Simulation of motion.

Anti-aliasing

Is the technique of minimizing aliasing, by e.g. rendering multiple samples per pixel.

Armature

An Object consisting of bones. Used to rig characters, props, etc.

Axis

A reference line which defines coordinates along one cardinal direction in n-dimensional space.

Axis Angle

Rotation method where X, Y, and Z correspond to the axis definition, while W corresponds to the angle around that axis, in radians.

Baking

The process of computing and storing the result of a potentially time-consuming calculation so as to avoid needing to calculate it again.

Bevel

The operation to chamfer or bevel edges of an object.

Bezier

A computer graphics technique for generating and representing curves.

Blend Modes

Color Blend Modes

Methods for blending two colors together.

Bone

The building block of an Armature. Made up of a Head, Tail and Roll Angle which define a set of local axes and a point of rotation at the Head.

Boolean

A type of logic dealing with binary true/false states.

Bounding Box

The box that encloses the shape of an object. The box is aligned with the local space of the object.

Bump Mapping

Technique for simulating slight variations in surface height using a greyscale “heightmap” texture.

BVH

Bounding Volume Hierarchy. File format. A hierarchical structure of geometric objects.

Caustics

The optical phenomenon of light concentration focused by specular reflections or refracting objects. In example observable on light passing through a glass of water onto a table or the pattern at the bottom of a swimming pool.

In rendering this refers to diffuse reflected light paths after a glossy or refraction bounce.

Child

An Object that is affected by its Parent.

Chroma / Chrominance

In general, a resulting image color decomposition, where its (L or Y) luminance channel is separated. There are two different contexts whereas this term is used:

Video systems

Refers to the general color decomposition resulting in Y (Luminance) and C (Chrominance) channels, whereas the chrominance is represented by: $U = (\text{Blue} - \text{Luminance})$ and $V = (\text{Red} - \text{Luminance})$.

Matte compositing

Refers to a point in the color gamut surrounded by a mixture of a determined spectrum of its RGB neighboring colors. This point is called Chroma key and this key (a chosen color) is used to create an Alpha Mask. The total amount of gamut space for this chrominance point is defined by users in a circular or square-shaped format.

Chromaticities

The coordinates of the primaries on the CIE 1931 xy chromaticity diagram.

Clamp / Clamping

Limits a variable to a range. The values over or under the range are set to the constant values of the range's minimum or maximum.

Collection

A device for organizing objects. See also Collections.

Color Gamut

A gamut traditionally refers to the volume of color a particular color model/space can cover. In many instances, it is often illustrated via a 2D model using CIE Yxy coordinates.

Color Space

A coordinate system in which a vector represent a color value. By doing so, the color space defines three things:

The exact color of each of the primaries. The White Point. A transfer function

sRGB

A color space that uses the Rec .709 primaries and white point but, with a slightly different transfer function.

HSV

Three values often considered as more intuitive (human perception) than the RGB system.

Hue

The Hue of the color.

Saturation

Also known as colorfulness, saturation is the quantity of hue in the color (from desaturated – a shade of gray – to saturated – brighter colors).

Value

The brightness of the color (dark to light).

HSL

Hue, Saturation

Luminance

The intensity of light either in an image/model channel, or emitted from a surface per square unit in a given direction.

YUV

Luminance-Chrominance standard used in broadcasting analog PAL (European) video.

YCbCr

Luminance-ChannelBlue-ChannelRed Component video for digital broadcast use, whose standards have been updated for HDTV and commonly referred to as the HDMI format for component video.

Concave Face

Face in which one vertex is inside a triangle formed by other vertices of the face.

Constraint

A way of controlling one object with data from another.

Convex Face

Face where, if lines were drawn from each vertex to every other vertex, all lines would remain in the face. Opposite of a concave face.

Co planar

Refers to any set of elements that are all aligned to the same 2D plane in 3D space.

Crease

Property of an edge. Used to define the sharpness of edges in subdivision surface meshes.

Curve

A type of object defined in terms of a line interpolated between Control Vertices. Available types of curves include Bezier, NURBS and Poly.

Cyclic

Often referring to an object being circular. This term is often associated with Curve.

Data User

An existing Blender object, which is using its own data, or linked data (data owned and controlled by another Blender object).

Diffuse Light

Even, directed light coming off a surface. For most things, diffuse light is the main lighting we see. Diffuse light comes from a specific direction or location and creates shading. Surfaces facing towards the light source will be brighter, while surfaces facing away from the light source will be darker.

Directional Light

The light that has a specific direction, but no location. It seems to come from an infinitely far away source, like the sun. Surfaces facing the light are illuminated more than surfaces facing away, but their location does not matter. A Directional Light illuminates all objects in the scene, no matter where they are.

Displacement Mapping

A method for distorting vertices based on an image or texture. Similar to Bump Mapping, but instead operates on the mesh's actual geometry. This relies on the mesh having enough geometry to represent details in the image.

Display Referenced

Refers to an image whose Luminance channel is limited to a certain range of values (usually 0-1). The reason it is called display referenced is because a display cannot display an infinite range of values. So, the term Scene Referenced must go through a transfer function to be converted from one to the other.

DOF

Depth Of Field. The distance in front of and behind the subject which appears to be in focus. For any given lens setting, there is only one distance at which a subject is precisely in focus, but focus falls off gradually on either side of that distance, so there is a region in which the blurring is tolerable. This region is greater behind the point of focus than it is in front, as the angle of the light rays change more rapidly; they approach being parallel with increasing distance.

Double Buffer

Technique for rendering and displaying content on the screen. Blender uses two buffers (images) to render the

interface, the content of one buffer is displayed while rendering occurs on the other buffer. When rendering is complete, the buffers are switched.

Edge

Straight segment (line) that connects two vertices, and can be part of a face.

Edge Loop

Chain of edges belonging to consecutive quads. An edge loop ends at a pole or a boundary. Otherwise, it is cyclic.

Edge Ring

Path of all edges along a face loop that share two faces belonging to that loop.

Empty

An Object without any Vertices, Edges or Faces.

Euler / Euler Rotation

Rotation method where rotations applied on each X, Y, Z axis component.

F-Curve

A curve that holds the animation values of a specific property.

Face

Mesh element that defines a piece of surface. It consists of three or more edges.

Face Loop

Chain of consecutive quads. A face loop stops at a triangle or N-gon (which do not belong to the loop), or at a boundary. Otherwise, it is cyclic.

Face Normal

The normalized vector perpendicular to the plane that a face lies in. Each face has its own normal.

Fake User

A special Data User, a program construct that is used to mark an object (e.g. material) to be saved in a blend-file, even when no Real User is using the object. Objects that are not used by any Data User are not included in saved blend-files.

Field of View

The area in which objects are visible to the camera. Also see Focal Length.

Focal Length

The distance required by a lens to focus collimated light. Defines the magnification power of a lens. Also see Field of View.

Frame Types

In video compression, a frame can be compressed by several different algorithms. These algorithms are known

as picture types or frame types and there are three major types: I, P, and B frames.

I-frames

The least compressible but don't require other video frames to decode.

P-frames

Use data from previous frames to decompress and are more compressible than I-frames.

B-frames

Use both previous and forward frames for data reference to get the highest amount of compression.

Gamma

An operation used to adjust the brightness of an image.

Geometric Center

The mean average of the positions of all vertices making up the object.

Gimbal

A pivoted support that allows the rotation of an object about a single axis.

Gimbal Lock

The limitation where axes of rotation can become aligned, losing the ability to rotate on an axis (typically associated with euler rotation).

Global Illumination

A super-set of radiosity and ray tracing. The goal is to compute all possible light interactions in a given scene, and thus, obtain a truly photo realistic image. All combinations of diffuse and specular reflections and transmissions must be accounted for. Effects such as color bleeding and caustics must be included in a global illumination simulation.

Global Space

The global world coordinates. Is equal to World Space.

Glossy Map

A black and white texture that defines where the object is glossy.

HDRI

High Dynamic Range Image. A set of techniques that allow a far greater dynamic range of exposures than normal digital imaging techniques. The intention is to accurately represent the wide range of intensity levels found in real scenes, ranging from direct sunlight to the deepest shadows.

Head

A sub component of a Bone. The point of rotation for the bone has X, Y, and Z coordinates measured in the Local Space of the Armature Object. Used in conjunction with the Tail to define the local Y axis of the bone in Pose Mode. The larger of the two ends when displayed as an Octahedron.

Interpolation

The process of calculating new data between points of known value, like keyframes.

Inverse Kinematics

The process of determining the movement of interconnected segments of a body or model. Using ordinary Kinematics on a hierarchically structured object you can, for example, move the shoulder of a puppet. The upper and lower arm and hand will automatically follow that movement. IK will allow you to move the hand and let the lower and upper arm go along with the movement. Without IK the hand would come off the model and would move independently in space.

IOR

Index Of Refraction. A property of transparent materials. When a light ray travels through the same volume it follows a straight path. However, if it passes from one transparent volume to another, it bends. The angle by which the ray is bent can be determined by the IOR of the materials of both volumes.

Keyframe

A frame in an animated sequence drawn or otherwise constructed directly by the user. In classical animation, when all frames were drawn by animators, the senior artist would draw these frames, leaving the “in between” frames to an apprentice. Now, the animator creates only the first and last frames of a simple sequence (keyframes); the computer fills in the gap.

Keyframing

Inserting Keyframes to build an animated sequence.

Lattice

A type of object consisting of a non-render-able three-dimensional grid of vertices.

Light Bounces

Refers to the reflection or transmission of a light ray upon interaction with a material. See also Light Paths.

Local Space

A 3D coordinate system that originates (for Objects) at the Object Origin. or (for Bones) at the Head of the Bone.

Luminance

The intensity of light either in an image/model channel, or emitted from a surface per square unit in a given direction.

Manifold

Manifold meshes, also called water-tight meshes, define a closed non-self-intersecting volume (see also non-manifold). A manifold mesh is a mesh in which the structure of the connected faces in a closed volume will always point the normals (and there surfaces) to the outside or to the inside of the mesh without any overlaps. If you recalculate those normals, they will always point at a predictable direction (To the outside or to the inside of the volume). When working with non-closed volumes, a manifold mesh is a mesh in which the normals will always define two different and non-consecutive surfaces. A manifold mesh will always define an even number

of non-overlapped surfaces.

MatCap

Stands for “material capture”, using an image to represent a complete material including lighting and reflections.

Matte

Matte painting is the technique to union real life footage like a photo with cg content like a mesh.

Mask

A greyscale image used to include or exclude parts of an image. A matte is applied as an Alpha Channel, or it is used as a mix factor when applying Color Blend Modes.

Mesh

Type of object consisting of vertices, edges and faces.

Micro polygons

A polygon roughly the size of a pixel or smaller.

MIP / Mip-map / Mip-mapping

‘MIP’ is an acronym of the Latin phrase ‘multum in parvo’, meaning ‘much in little’. Mip-maps are progressively lower resolution representations of an image, generally reduced by half squared interpolations using anti-aliasing. Mip-mapping is the process used to calculate lower resolutions of the same image, reducing memory usage to help speed visualization, but increasing memory usage for calculations and allocation. Mip-mapping is also a process used to create small anti-aliased samples of an image used for texturing. The mip-mapping calculations are made by CPU's, but modern graphic processors can be selected for this task and are way faster.

MIS

Multiple Importance Sampling. A process of estimating the direction of light rays to improve sampling quality.

Motion Blur

The phenomenon that occurs when we perceive a rapidly moving object. The object appears to be blurred because of our persistence of vision. Simulating motion blur makes computer animation appear more realistic.

Multi sampling

Rendering multiple samples per pixel, for anti-aliasing.

N-gon

A face that contains more than four vertices.

NDOF

A general term used to describe a 3D mouse, or any input devices which supports more degrees of freedom than a conventional 2D input device, see: NDOF (3D Mouse).

Non-linear Animation

Animation technique that allows the animator to edit motions as a whole, not just the individual keys. Non-linear animation allows you to combine, mix, and blend different motions to create entirely new animations.

Non-manifold

Non-Manifold meshes essentially define geometry which cannot exist in the real world. This kind of geometry is not suitable for several types of operations, especially those where knowing the volume (inside/outside) of the object is important (refraction, fluids, booleans, or 3D printing, to name a few). A non-manifold mesh is a mesh in which the structure of a non-overlapped surface (based on its connected faces) will not determine the inside or the outside of a volume based on its normals, defining a single surface for both sides, but ended with flipped normals. When working with non-closed volumes, a non-manifold mesh will always determine at least one discontinuity in the normal directions, either by an inversion of a connected loop, or by an odd number of surfaces. A non-manifold mesh will always define an odd number of surfaces.

There are several types of non-manifold geometry:

Some borders and holes (edges with only a single connected face), as faces have no thickness.

Edges and vertices not belonging to any face (wire).

Edges connected to three or more faces (interior faces).

Vertices belonging to faces that are not adjoining (e.g. two cones sharing the vertex at the apex).

Normal

The normalized vector perpendicular to a surface.

Normals can be assigned to vertices, faces and modulated across a surface using normal mapping.

Normal Mapping

Is similar to Bump mapping, but instead of the image being a greyscale heightmap, the colors define in which direction the normal should be shifted, the three color channels being mapped to the three directions X, Y and Z. This allows more detail and control over the effect.

NURBS

Non-uniform Rational Basis Spline

A computer graphics technique for generating and representing curves and surfaces.

Object

Container for a type (Mesh, Curve, Surface, Metaball, Text, Armature, Lattice, Empty, Camera, Light) and basic 3D transform data (Object Origin).

Object Center / Object Origin

A reference point used to position, rotate, and scale an Object and to define its Local Space coordinates.

Octahedron

An eight-sided figure commonly used to depict the Bones of an Armature.

OpenGL

The graphics system used by Blender (and many other graphics applications) for rendering 3D graphics, often taking advantage of hardware acceleration.

Overscan

The term used to describe the situation. when not all of a televised image is present on a viewing screen.

Parent

An Object that affects its Child objects.

Parenting

Creating a Parent-Child relationship between two objects.

Particle system

Technique that simulates certain kinds of fuzzy phenomena, which are otherwise very hard to reproduce with conventional rendering techniques. Common examples include fire, explosions, smoke, sparks, falling leaves, clouds, fog, snow, dust, meteor tails, stars, and galaxies, or abstract visual effects like glowing trails, magic spells. Also used for things like fur, grass or hair.

Phong

Local illumination model that can produce a certain degree of realism in three-dimensional objects by combining three elements: diffuse, specular and ambient for each considered point on a surface. It has several assumptions – all lights are points, only surface geometry is considered, only local modeling of diffuse and specular, specular color is the same as light color, ambient is a global constant.

Pivot Point

The pivot point is the point in space around which all rotations, scalings and mirror transformations are centered.

Pixel

The smallest unit of information in a 2D raster image, representing a single color made up of red, green, and blue channels. If the image has an alpha channel, the pixel will contain a corresponding fourth channel.

Pole

Vertex where three, five, or more edges meet. A vertex connected to one, two, or four edges is not a pole.

Polygon

A geometry face with multiple vertices. A tri has three vertices, a quad has four vertices, an N-gon has more than four vertices. And they all are polygons.

Pose Mode

Used for posing, keyframing, weight painting, constraining and parenting the bones of an armature.

Posing

Moving, Rotating and Scaling the bones of an armature to achieve an aesthetically pleasing pose for a character.

Premultiplied Alpha

If an alpha channel is used in an image, there are two common representations that are available: straight (unassociated) alpha, and premultiplied (associated) alpha. With straight alpha, the RGB components represent the color of the object or pixel, disregarding its opacity. With premultiplied alpha, the RGB components represent the emission of the object or pixel, and the alpha represents the occlusion.

Primaries

In color theory, primaries (often known as primary colors) are the abstract lights, using an absolute model, that make up a color space.

Primitive

A basic object that can be used as a basis for modeling more complicated objects.

Procedural Texture

Computer generated (generic) textures that can be configured via different parameters.

Projection

In computer graphics, there are two common camera projections used. Perspective and Orthographic.

Perspective

A perspective view is geometrically constructed by taking a scene in 3D and placing an observer at point O. The 2D perspective scene is built by placing a plane (e.g. a sheet of paper) where the 2D scene is to be rendered in front of point O, perpendicular to the viewing direction. For each point P in the 3D scene a PO line is drawn, passing by O and P. The intersection point S between this PO line and the plane is the perspective projection of that point. By projecting all points P of the scene you get a perspective view.

Orthographic

In an orthographic projection, you have a viewing direction but not a viewing point O. The line is then drawn through point P so that it is parallel to the viewing direction. The intersection S between the line and the plane is the orthographic projection of the point P. By projecting all points P of the scene you get the orthographic view.

Proxy

For video editing, a proxy is a smaller version of the original file, typically using an optimized video codec and lower resolution version (faster to load) that stands in for the main image or video.

When proxies are built, editing functions like scrubbing and scrolling and compositing is much faster but gives lower resolution and slightly imprecise result.

Quad / Quadrilateral / Quadrangle

Face that contains exactly four vertices.

Quaternion / Quaternion Rotation

Rotation method where rotations are defined by four values (X, Y, Z, and W). X, Y, and Z also define an axis, and W an angle, but it is quite different from Axis Angle.

Radiosity

A global lighting method that calculates patterns of light and shadow for rendering graphics images from three-dimensional models. One of the many different tools which can simulate diffuse lighting in Blender.

Seed

The seed is a value that gets used for random number generators. It is not really random since the same seed will always produce the same random number set. But random enough for most randomization needs. Choosing another seed value will produce another set of random numbers.

Ray Tracing

Rendering technique that works by tracing the path taken by a ray of light through the scene, and calculating reflection, refraction, or absorption of the ray whenever it intersects an object in the world. More accurate than scanline, but much slower.

Real User

A Blender object, which is a Data User. Opposite of Fake User, which is only a program construct.

Refraction

The change in direction of a wave due to a change in velocity. It happens when waves travel from a medium with a given index of refraction to a medium with another. At the boundary between the media, the wave changes direction; its wavelength increases or decreases but frequency remains constant.

Render

The process of computationally generating a 2D image from 3D geometry.

RGB

A color model based on the traditional primary colors, Red/Green/Blue. RGB colors are also directly broadcasted to most computer monitors.

Rig

A system of relationships that determine how something moves. The act of building of such a system.

Roll / Roll Angle

The orientation of the local X and Z axes of a Bone. Has no effect on the local Y axis as local Y is determined by the location of the Head and Tail.

Rolling Shutter

In real CMOS cameras the sensor is read out with scanlines and hence different scanlines are sampled at a different moment in time. This, for example, make vertical straight lines being curved when doing a horizontal camera pan. See also Rolling Shutter on Wikipedia.

Roughness Map

A greyscale texture that defines how rough or smooth the surface of a material is. This may also be known as a Glossy Map.

Scanline

Rendering technique. Much faster than ray tracing, but allows fewer effects, such as reflections, refractions, motion blur and focal blur.

Scene Referenced

An image whose Luminance channel is not limited.

Shading

Process of altering the color of an object/surface in the 3D scene, based on its angle to lights and its distance from lights to create a photo realistic effect.

Smoothing

Defines how faces are shaded. Faces can be either solid (faces are rendered flat) or smooth (faces are smoothed by interpolating the normal on every point of the face).

Specular Light

A light which is reflected precisely, like a mirror. Also used to refer to highlights on reflective objects.

SSS

Subsurface Scattering. Mechanism of light transport in which light penetrates the surface of a translucent object, is scattered by interacting with the material, and exits the surface at a different point. All non-metallic materials are translucent to some degree. In particular, materials such as marble, skin, and milk are extremely difficult to simulate realistically without taking subsurface scattering into account.

Straight Alpha

If an alpha channel is used in an image, there are two common representations that are available: straight (unassociated) alpha, and premultiplied (associated) alpha. With straight alpha, the RGB components represent the color of the object or pixel, disregarding its opacity. With premultiplied alpha, the RGB components represent the emission of the object or pixel, and the alpha represents the occlusion.

Subdiv / SDS

Subdivision Surface. A method of creating smooth higher poly surfaces which can take a low polygon mesh as input.

Subdividing

Technique for adding more geometry to a mesh. It creates new vertices on subdivided edges, new edges between subdivisions and new faces based on new edges. If new edges cross a new vertex is created at their crossing point.

Tail

A sub component of a Bone. Has X, Y and Z coordinates measured in the Local Space of the Armature Object. Used in conjunction with the Head to define the local Y axis of a bone in Pose Mode. The smaller of the two ends when displayed as an Octahedron.

Tessellation

The tiling of a plane using one or more geometric shapes usually resulting in Micro polygons.

Texture

Specifies visual patterns on surfaces and simulates physical surface structure.

Texture Space

The bounding box to use when using Generated mapping to add a Texture to an image.

Time code

A coded signal on videotape or film giving information about the frame number and time the frame was recorded. Time codes are used to sync media between different recording devices, including both audio and video.

Title Safe

Area of the screen visible on all devices. Place text and graphics inside this area to make sure they do not get cut off.

Topology

The arrangement of Vertices, Edges, and Faces which define the shape of a mesh. See vertex, edge, and face.

Transforms

The combined idea of location, rotation, and scale.

Triangle / Tri

Face with exactly three vertices.

User

The user for the current object.

UV Map

Defines a relation between the surface of a mesh and a 2D texture. In detail, each face of the mesh is mapped to a corresponding face on the texture. It is possible and often common practice to map several faces of the mesh to the same or overlapping areas of the texture.

Vertex / Vertices

A point in 3D space containing a location. It may also have a defined color. Vertices are the terminating points of edges.

Vertex Group

Collection of vertices. Vertex groups are useful for limiting operations to specific areas of a mesh.

Voxel

A cubic 3D equivalent to the square 2D pixel. The name is a combination of the terms “Volumetric” and “Pixel”. Used to store smoke and fire data from physics simulations.

Walk Cycle

In animation, a walk cycle is a character that has just the walking function animated. Later on in the animation

process, the character is placed in an environment and the rest of the functions are animated.

Weight Painting

Assigning vertices to a Vertex Group with a weight of 0.0 - 1.0.

White Point

A reference value for white light defined by what happens when all the primaries, of the particular color model, are combined evenly.

A white point is defined by a set of CIE illuminates which correspond to a color temperature. For example, D65 corresponds to 6500K light, D70 corresponding to 7000K and so on.

World Space

A 3D coordinate system that originates at a point at the origin of the world. Compare to Local Space.

Z-buffer

Raster-based storage of the distance measurement between the camera and the surface points. Surface points which are in front of the camera have a positive Z value and points behind have negative values. The Z-depth map can be visualized as a greyscale image.



38 About this Manual

Table of content

About this Manual.....	1
Manipulating Bforartists Manual.....	1
License.....	1

About this Manual

Bforartists is a fork of the open source software Blender. And every software needs a manual. Bforartists 1 was equal enough to use the Blender manual in big parts for that. But even when the tools are the same than in Blender, the user interface differs quite a bit.

For Bforartists 2 we did a complete rewrite, and so this manual does not contain any parts from the Blender manual anymore.

Manipulating Bforartists Manual

The Bforartists Manual is a community driven effort to which anyone can contribute.

And this very easy, since the manual comes not only as PDF files, but also as editable *.odt files. That's the file format for Libre and Open Office. Both free and open source Office solutions. To manipulate or to fix a typo, a word, a sentence or even a whole chapter is as easy as manipulating the text in Libre Office or Open Office, commit the changes to the manual repository, and tell the Bforartists developers to put it online.

The repository with the ODT files can be found here: <https://github.com/Bforartists/Manual>

License

The Bforartists's Manual is free and published under Public Domain*

This means that anyone is free to download, edit and share the manual. It also means that when contributing to the manual you don't hold exclusive copyright to your text. You are, of course, acknowledged and appreciated for your contribution. However others can change and improve your text in order to keep the manual consistent and up to date.

*** As of writing this part here the Blender manual for 2.77 and below was put under a Public Domain AS CC0 license. Which is simply invalid. You can have either Public domain. Or CC0. Those two licenses contradicts each other.**

It also seems that the Blender manual was put under CC0 and then once more under CC0 BY-SA without asking all involved persons if they wanted to do so. The original manual was under OCL license. Another license breach.

So we choose the license type that seems to fit most here, especially when looking at the old licensing. Public Domain. The old Blender parts are still under OCL license.

The Bforartists 2 manual should not contain any old Blender manual material anymore, and is fully licensed under Public Domain.



39 Bforartists History

Table of content

- Bforartists 3 History..... 1
 - Preface:..... 1
 - History:..... 2
- Bforartists 2 History..... 2
 - Preface:..... 2
 - History:..... 3
- Bforartists 1 History..... 3
 - Preface:..... 4
 - History:..... 4
- Blender’s History..... 5
 - Video: From Blender 1.60 to 2.50..... 6
 - Version/Revision Milestones..... 6
 - The start!..... 6
 - Blender goes Open Source..... 7
 - Blender 2.5x - The Recode!..... 8
 - Blender 2.6x to 2.7x - Improvements & Stabalizing..... 8
- About Free Software and the GPL..... 9

Bforartists 3 History

Preface:

The Bforartists 3 release marks another milestone in the history of Bforartists. There is nothing really special in feature terms. It's the permanent continued development and improvement as we do since years. Bit by bit. And improvement by improvement. A left aligned prop here, a new panel to improve usability there, and so on.

But with Blender 3 there is also a Bforartists version 3, with all the features from Blender 3.

Until Bforartists 3 we followed our own versioning. In the future we will try to stick as close as possible to the Blender versioning numbers. To make clear what Blender version is compatible with what Bforartists version, and vice versa. It can still happen though that this goes out of sync. In case we need to do a showstopper release for example. But the plan is to stick close.

With Bforartists 3 we also have reached a point where the manageable big development goals by us are all fulfilled. This means there won't be this massive changes to the UI anymore like in the past. It can still happen, but it is not the rule anymore. Bforartists was always in a productive state. But it now has finally reached a stable status in terms of feature completeness. So the main work in future versions is now to keep Bforartists up to date, and adjust it to the changes that comes in from Blender.

History:

28.08.2023 – Bforartists 3.6.2 released.
07.08.2023 – Bforartists 3.6.1 released.
05.07.2023 – Bforartists 3.6.0 released.
08.05.2023 – Bforartists 3.5.1 released.
03.04.2023 – Bforartists 3.5.0 released.
10.01.2023 – Bforartists 3.4.1 released.
07.12.2022 – Bforartists 3.4.0 released.
12.10.2022 – Bforartists 3.3.1 released.
07.09.2022 – Bforartists 3.3.0 released.
08.08.2022 – Bforartists 3.2.2 released.
08.07.2022 – Bforartists 3.2.1 released.
09.06. 2022 - Bforartists 3.2.0 released.
09.04. 2022 - Bforartists 3.1.3 released. A hotfix release.
04.04. 2022 - Bforartists 3.1.2 released.
10.03. 2022 - Bforartists 3.1.0 released.
02.02. 2022 - Bforartists 3.0.1 released.
03.12.2021 - Bforartists 3.0.0 released.

Bforartists 2 History

Preface:

It was for a while not clear if and how we continue with the Bforartists 2 development. The Blender developers did quite a few things right with 2.80. Icon buttons in the tool shelf, streamlined UI and so on. In best case Blender 2.80 would have made a Bforartists 2 obsolete.

But they did from our point of view also quite a few things wrong again. The hard to read monochrome icons and still a hard to read standard theme, the new tool shelf, which is one gigantic hacky solution that doubles the tool set, still a big mess full of double menu entries, and so on. But alone the toolbar from Bforartists 1 justified the further development already. It is so useful. And so the decision was made to continue with development.

There was no exact date when the development started again. There was quite a few things still to do for Bforartists 1, which was at the same time preparation work for Bforartists 2 already. Manual for example. And the merge of Blender 2.80 code into the Bforartists master was also a longer process across several days. The official starting point was the release of the Bforartists 2 Manifest, which defines the will and the further

development goals.

- Reiner

History:

18.07.2021 - Bforartists 2.9.3 released.

01.07.2021 - Bforartists 2.9.2 released. A showstopper bug made a new version necessary.

25.06.2021 - Bforartists 2.9.1 released. This release ends the development cycle for Bforartists 2 in general.

11.06.2021 - Bforartists 2.9.0 released.

27.02.2021 - Bforartists 2.8.0 released.

26.01.2021 - Bforartists 2.7.0 released.

26.11.2020 - Bforartists 2.6.0 released.

24.09.2020 - Bforartists 2.5.1 released.

01.09.2020 - Bforartists 2.5.0 released.

03.07.2020 - Bforartists 2.4.0 released.

10.06.2020 - Bforartists 2.3.0 released.

26.05.2020 - Bforartists 2.2.0 released.

04.06.2020 - Bforartists 2.1.0 released.

18.04.2019 - Bforartists 2 Gold released. This release is the first productive version of Bforartists 2.

12.04.2019 - Bforartists 2 Release candidate released.

16.03.2020 - Bforartists 2 Beta 0.9.1 released. The first beta.

14.02.2020 - Bforartists 2 Alpha 0.9.0 released.

21.11.2019 - Bforartists 2 Alpha 0.8.0 released.

03.10.2019 - Bforartists 2 Alpha 0.7.0 released.

31.07.2019 - Bforartists 2 Alpha 0.6.0 released.

03.06.2019 - Bforartists 2 Alpha 0.5.0 released.

06.05.2019 - Bforartists 2 Alpha 0.4.0 released.

01.04.2019 - Bforartists 2 Alpha 0.3.0 released.

03.03.2019 - Bforartists 2 Alpha 0.2.0 released.

04.02.2019 - Bforartists 2 Alpha 0.1.0 released.

01.12.2018 - Merging Blender 2.80 into Bforartists Master.

27.10.2018 - Bforartists 2 Manifest released.

Bforartists 1 History

Preface:

Welcome to Bforartists, the free and open source 3D modeling, rendering and animation suite.

Bforartists is a fork of the popular open source 3d software Blender. And, similar to Blender, of course also open source and under the GPL license. The primary goal of the Bforartists fork is to deliver a better graphical UI and a better usability. This means a complete switch in the usage philosophy. Away from the hotkey and speed centered usage. Away from crazy decisions like RMB select. Towards a user friendly and intuitive graphical UI that can be used with a mouse and one hand when necessary. And that is much closer to the common UI standards of many other software.

The idea to solve the UI dilemma of Blender and to fork it was long around since years. It was no easy decision to really start it. Blender is a code monster. And so the answer to the question shall i really start a fork was always no. But at one point it was simply enough how the user interface got threaten by the Blender developers. The answer if Blender should be forked turned from *no* to *possible with some big caveats*. And then the decision was made to fork Blender.

The Bforartists project itself started officially at July the 2nd 2015. That's when the first real steps were done.

History:

2.6.2015 - Decision day. The first pages for the UI proposal were written. The work at the homepage started. Which was the official start of the whole project.

2.7.2015 - The domain bforartists was registered.

13.8.2015 - The Bforartists page was finished and went live.

22.8.2015 - GitHub account was created and went live.

21.9.2015 - The first Bforartists version 0.1 was released. It was based at Blender 2.75. And contained not this much more than the changed branding.

14.10.2015 - Version 0.2 brought the changes for Blender 2.76. And that was the moment when Bforartists started to walk alone.

19.12.2015 - Version 0.2.1 introduced a new key map and a new navigation scheme. And already quite a few changes at the UI layout. Blender has a ton of missing UI entries and a ton of double and even triple menu entries. It also brought in the Blender 2.76 a and b patches to Bforartists

27.01.2016 - Bforartists 0.2.2 was mainly around a plugin to display the most needed hotkeys up left.

18.03.2016 - Bforartists 0.3.0 introduced the first incarnation of icon buttons in the tool shelf.

26.03.2016 - Bforartists 0.3.1 came with some small fixes that were overlooked for version 0.3.0. The splash screen was changed because of ongoing trolling.

02.08.2016 - Bforartists 0.4.0 was a small refinement release that was the final stroke below the try to implement Qt and new editor types. Which did simply not work.

04.09.2016 - Bforartists 0.4.1 brought mainly changes to the tool tips. Nearly every tool tip contains the tool name now too.

16.09.2016 - 0.4.2 is another small release mainly around catching some more tool tips. and small quirks. New is the Materials Library FX add-on, which is also naively included into Blender 2.78 now.

24.09.2016 - 0.5.0 is a milestone release. It marks the end of the first big development cycle. The tracker is empty for the first time since development start.

02.11.2016 - 0.6.0 brings fixes to the addons, first sub tabs in the panels, and the Mini lightlib add-on.

01.12.2016 - 0.7.0 was mainly cleanup work in the Properties editor.

08.01.2017 - Version 0.8.0 brings the new Toolbar editor.

27.02.2017 - Version 0.9.0 is the merge of the actual Blender version 2.78 C into Bforartists.

13.03.2017 - Version 0.9.1 is a bug fix release that fixes some show stoppers from version 0.9.0.

10.4.2017 - Version 0.9.2 is around cleaning up the menus and connecting some loose ends. And it introduces a Mac build.

13.9.2017 - Version 0.9.3 is the merge of Blender 2.79 into Bforartists. Plus a few smaller adjustments and fixes.

14.9.2017 - An emergency release because of a showstopper bug. The bake panels were missing.

02.03.2018 - Version 0.9.6 brings the changes from Blender 2.79a, and adds 260 changes from Bforartists side.

19.04.2018 - Version 0.9.7 brings the full key map, the changes from Blender 2.79b, and lots of small improvements and fixes. More compact brush panels for example.

04.05.2018 - Version 1.0.0 RC1 marks the end of this development cycle. All initial development goals that could be fulfilled are fulfilled.

11.05.2018 - Version 1.0.0 is live.

Blender's History

In 1988 Ton Roosendaal co-founded the Dutch animation studio NeoGeo. NeoGeo quickly became the largest 3D animation studio in the Netherlands and one of the leading animation houses in Europe. NeoGeo created award-winning productions (European Corporate Video Awards 1993 and 1995) for large corporate clients such as multi-national electronics company Philips. Within NeoGeo Ton was responsible for both art direction and internal software development. After careful deliberation Ton decided that the current in-house 3D toolset for NeoGeo was too old and cumbersome to maintain, and needed to be rewritten from scratch. In 1995 this rewrite began and was destined to become the 3D software creation we all know as Blender. As NeoGeo continued to refine and improve Blender it became apparent to Ton that Blender could be used as a tool for other artists outside of NeoGeo.

In 1998, Ton decided to found a new company called Not a Number (NaN) as a spin-off of NeoGeo to further market and develop Blender. At the core of NaN was a desire to create and distribute a compact, cross platform

3D application for free. At the time this was a revolutionary concept as most commercial 3D applications cost thousands of dollars. NaN hoped to bring professional level 3D modeling and animation tools within the reach of the general computing public. NaN's business model involved providing commercial products and services around Blender. In 1999 NaN attended its first SIGGRAPH conference in an effort to more widely promote Blender. Blender's first SIGGRAPH convention was a huge success and gathered a tremendous amount of interest from both the press and attendees. Blender was a hit and its huge potential confirmed!

Following the success of the SIGGRAPH conference in early 2000, NaN secured financing of €4.5M from venture capitalists. This large inflow of cash enabled NaN to rapidly expand its operations. Soon NaN boasted as many as fifty employees working around the world trying to improve and promote Blender. In the summer of 2000, Blender 2.0 was released. This version of Blender added the integration of a game engine to the 3D application. By the end of 2000, the number of users registered on the NaN website surpassed 250,000.

Unfortunately, NaN's ambitions and opportunities didn't match the company's capabilities and the market realities of the time. This over-extension resulted in restarting NaN with new investor funding and a smaller company in April 2001. Six months later NaN's first commercial software product, Blender Publisher was launched. This product was targeted at the emerging market of interactive web-based 3D media. Due to disappointing sales and the ongoing difficult economic climate, the new investors decided to shut down all NaN operations. The shutdown also included discontinuing the development of Blender. Although there were clearly shortcomings in the then current version of Blender, such as a complex internal software architecture, unfinished features and a non-standard way of providing the GUI, the enthusiastic support from the user community and customers who had purchased Blender Publisher in the past meant that Ton couldn't justify leaving Blender to fade into insignificance. Since restarting a company with a sufficiently large team of developers wasn't feasible, Ton Roosendaal founded the non-profit organization Blender Foundation in March 2002.

The Blender Foundation's primary goal was to find a way to continue developing and promoting Blender as a community-based open source project. In July 2002, Ton managed to get the NaN investors to agree to a unique Blender Foundation plan to attempt to release Blender as open source. The "Free Blender" campaign sought to raise €100,000 so that the Foundation could buy the rights to the Blender source code and intellectual property rights from the NaN investors and subsequently release Blender to the open source community. With an enthusiastic group of volunteers, among them several ex-NaN employees, a fund raising campaign was launched to "Free Blender". To everyone's surprise and delight the campaign reached the €100,000 goal in only seven short weeks. On Sunday October 13, 2002, Blender was released to the world under the terms of the GNU GPL. Blender development continues to this day driven by a team of dedicated volunteers from around the world led by Blender's original creator, Ton Roosendaal.

Video: From Blender 1.60 to 2.50

<https://vimeo.com/8567074>

Version/Revision Milestones

The start!

- 1.00 - January 1994: Blender in development at animation studio NeoGeo.
- 1.23 - January 1998: SGI version published on the web, IrisGL.
- 1.30 - April 1998: Linux and FreeBSD version, port to OpenGL and X11.
- 1.3x - June 1998: NaN founded.
- 1.4x - September 1998: Sun and Linux Alpha version released.
- 1.50 - November 1998: First Manual published.
- 1.60 - April 1999: C-key (new features behind a lock, \$95), MS-Windows version released.
- 1.6x - June 1999: BeOS and PPC version released.
- 1.80 - June 2000: End of C-key, Blender full freeware again.
- 2.00 - August 2000: Interactive 3D and real-time engine.
- 2.10 - December 2000: New engine, physics, and Python.
- 2.20 - August 2001: Character animation system.
- 2.21 - October 2001: Blender Publisher launch.
- 2.2x - December 2001: Mac OSX version.

Blender goes Open Source

- **13 October 2002: Blender goes Open Source, 1st Blender Conference.**
- 2.25 - October 2002: Blender Publisher becomes freely available.
- Tuhopuu1 - Oct 2002: The experimental tree of Blender is created, a coder's playground.
- 2.26 - February 2003: The first true open source Blender release.
- 2.27 - May 2003: The second open source Blender release.
- 2.28x - July 2003: First of the 2.28x series.
- 2.30 - October 2003: Preview release of the 2.3x UI makeover presented at the 2nd Blender Conference.
- 2.31 - December 2003: Upgrade to stable 2.3x UI project.
- 2.32 - January 2004: Major overhaul of internal rendering capabilities.
- 2.33 - April 2004: Game Engine returns, ambient occlusion, new procedural textures.
- 2.34 - August 2004: Particle interactions, LSCM UV mapping, functional YafRay integration, weighted creases in subdivision surfaces, ramp shaders, full OSA, and many many more.
- 2.35 - November 2004: Another version full of improvements: object hooks, curve deforms and curve tapers, particle duplicators and much more.
- 2.36 - December 2004: A stabilization version, much work behind the scene, normal and displacement mapping improvements.
- 2.37 - June 2005: Transformation tools and widgets, softbodies, force fields, deflections, incremental subdivision surfaces, transparent shadows, and multi-threaded rendering.
- 2.40 - December 2005: Full rework of armature system, shape keys, fur with particles, fluids and rigid bodies.
- 2.41 - January 2006: Lots of fixes, and some game engine features.
- 2.42 - July 2006: The nodes release, array modifier, vector blur, new physics engine, rendering, lip sync, and many other features. This was the release following Project Orange.

- 2.43 - February 2007: Multi-resolution meshes, multi-layer UV textures, multi-layer images and multi-pass rendering and baking, sculpting, retopology, multiple additional matte, distort and filter nodes, modeling and animation improvements, better painting with multiple brushes, fluid particles, proxy objects, sequencer rewrite, and post-production UV texturing.
- 2.44 - May 2007: The big news, in addition to two new modifiers and re-awakening the 64-bit OS support, was the addition of subsurface scattering, which simulates light scattering beneath the surface of organic and soft objects.
- 2.45 - September 2007: Serious bug fixes, with some performance issues addressed.
- 2.46 - May 2008: The Peach release was the result of a huge effort of over 70 developers providing enhancements to provide hair and fur, a new particle system, enhanced image browsing, cloth, a seamless and non-intrusive physics cache, rendering improvements in reflections, AO, and render baking, a mesh deform modifier for muscles and such, better animation support via armature tools and drawing, skinning, constraints and a colorful Action Editor, and much more. It was the release following Project Peach.
- 2.47 - August 2008: Bugfix release.
- 2.48 - October 2008: The Apricot release, cool GLSL shaders, lights and GE improvements, snap, sky simulator, shrinkwrap modifier, and Python editing improvements. This was the release following Project Apricot.
- 2.49 - June 2009: Node-based textures, armature sketching (called Etch-a-Ton), boolean mesh operation improvements, JPEG2000 support, projection painting for direct transfer of images to models, and a significant Python script catalogue. GE enhancements included video textures, where you can play movies in-game, upgrades to the Bullet physics engine, dome (fish-eye) rendering, and more API GE calls made available.

Blender 2.5x - The Recode!

- 2.5x - From 2009 to August 2011: This series released four pre-version (from Alpha 0 in November 2009 to Beta in July 2010) and three stable versions (from 2.57 - April 2011 - to 2.59 - August 2011). It is one of the most important development projects, with a total refactor of the software with new functions, redesign of the internal window manager and event/tool/data handling system, and new Python API. The final version of this project was Blender 2.59 in August 2011.

Blender 2.6x to 2.7x - Improvements & Stabilizing

- 2.60 - October 2011: Internationalization of the UI, improvements in animation system and the GE, vertex weight groups modifiers, 3D audio and video, bug fixes, and the UI internationalization.
- 2.61 - December 2011: The Cycles renderer was added in trunk, the camera tracker was added, dynamic paint for modifying textures with mesh contact/approximation, the Ocean Sim modifier to simulate ocean and foam, new add-ons, bug fixes, and more extensions added for the Python API.
- 2.62 - February 2012: The Carve library was added to improve boolean operations, support for object tracking was added, the Remesh modifier was added, many improvements in the GE, matrices and vectors in the Python API were improved, new add-ons, and many bug fixes.
- 2.63 - April 2012: Bmesh was merged to trunk with full support for n-sided polygons, sculpt hiding, a panoramic camera for Cycles, mirror ball environment textures and float precision textures, render layer mask layers, ambient occlusion and viewport display of background images and render layers, new

import and export add-ons were added, and 150 bug fixes.

- 2.64 - October 2012: Mask editor, improved motion tracker, OpenColorIO, Cycles improvements, sequencer improvements, better mesh tools (Inset and Bevel were improved), new keying nodes, sculpt masking, Collada improvements, new skin modifier, new compositing nodes backend, and many bugs were fixed.
- 2.65 - December 2012: Fire and smoke improvements, anisotropic shader for Cycles, modifier improvements, bevel tool now includes rounding, new add-ons, and over 200 bug fixes.
- 2.66 - February 2013: Dynamic topology, rigid body simulation, improvements in UI and usability (including retina display support), Cycles now supports hair, the bevel tool now supports individual vertex bevelling, new *Mesh Cache* modifier and the new *UV Warp* modifier, new SPH particle fluid solver. More than 250 bug fixes.
- 2.67 - May 2013: Freestyle was added, paint system improvements, subsurface scattering for Cycles, Ceres library in the motion tracker, new custom python nodes, new mesh modeling tools, better support for UTF8 text and improvements in text editors, new add-ons for 3D printing, over 260 bug fixes.
- 2.68 - July 2013: New and improved modeling tools, three new Cycles nodes, big improvements in the motion tracker, Python scripts and drivers are disabled by default when loading files for security reasons, and over 280 bug fixes.
- 2.69 - October 2013: Even more modeling tools, Cycles improved in many areas, plane tracking is added to the motion tracker, better support for FBX import/export, and over 270 bugs fixed.
- 2.70 - March 2014: Cycles gets basic volumetric support on the CPU, more improvements to the motion tracker, two new modeling modifiers, some UI consistency improvements, and more than 560 bug fixes.
- 2.71 - June 2014: Deformation motion blur and fire/smoke support is added to Cycles, UI popups are now draggable, performance optimizations for sculpting mode, new interpolation types for animation, many improvements to the GE, and over 400 bug fixes.
- 2.72 - October 2014: Cycles gets volume and SSS support on the GPU, pie menus are added and tooltips greatly improved, the intersection modeling tool is added, new sun beam node for the compositor, Freestyle now works with Cycles, texture painting workflow is improved, and more than 220 bug fixes.
- 2.73 - January 2015: Cycles gets improved volumetric support, major upgrade to grease pencil, MS-Windows gets Input Method Editors (IMEs) and general improvements to painting, freestyle, sequencer and add-ons.
- 2.74 - March 2015: Support for custom-normals, viewport compositing and improvements to hair dynamics.
- 2.75 - July 2015: Integrated stereo/multi-view pipeline, corrective smooth modifier and new dependency graph (*enable as a command line option*).
- 2.76 - November 2015: Pixar OpenSubdiv support, Viewport and File Browser performance boost, node auto-offset, and a text effect strip for the Sequencer.

About Free Software and the GPL

When one hears about “free software”, the first thing that comes to mind might be “no cost”. While this is typically true, the term “free software” as used by the Free Software Foundation (originators of the GNU Project and creators of the GNU General Public



License) is intended to mean “free as in freedom” rather than the “no cost” sense (which is usually referred to as “free as in free beer” or *gratis*). Free software in this sense is software which you are free to use, copy, modify, redistribute, with no limit. Contrast this with the licensing of most commercial software packages, where you are allowed to load the software on a single computer, are allowed to make no copies, and never see the source code. Free software allows incredible freedom to the end user. Since the source code is universally available, there are also many more chances for bugs to be caught and fixed.

When a program is licensed under the GNU General Public License (the GPL):

- You have the right to use the program for any purpose.
- You have the right to modify the program, and have access to the source codes.
- You have the right to copy and distribute the program.
- You have the right to improve the program, and release your own versions.

In return for these rights, you have some responsibilities if you distribute a GPL'd program, responsibilities that are designed to protect your freedoms and the freedoms of others:

- You must provide a copy of the GPL with the program, so that recipients are aware of their rights under the license.
- You must include the source code or make the source code freely available.
- If you modify the code and distribute the modified version, you must license your modifications available under the GPL (or a compatible license).
- You may not restrict the licensing of the program beyond the terms of the GPL. (you may not turn a GPL'd program into a proprietary product.)

For more on the GPL, check the its page on the GNU Project web site.

Note

The GPL only applies to the Bforartists application and **not** the artwork you create with it; for more info see the Bforartists or Blender License.



40 - Manual Update History

- 05.08.2023 - Updated the manual to Bforartists 3 version 3.6.1
- 05.07.2023 - Updated the manual to Bforartists 3 version 3.6.0
- 08.05.2023 - Updated the manual to Bforartists 3 version 3.5.1
- 03.04.2023 - Updated the manual to Bforartists 3 version 3.5.0
- 11.01.2023 - Updated the manual to Bforartists 3 version 3.4.1
- 08.12.2022 - Updated the manual to Bforartists 3 version 3.4.0
- 12.10.2022 - Updated the manual to Bforartists 3 version 3.3.1
- 18.09.2022 - Updated the manual to Bforartists 3 version 3.3.0
- 08.08.2022 - Updated the manual to Bforartists 3 version 3.2.2
- 08.07.2022 - Updated the manual to Bforartists 3 version 3.2.1
- 09.06.2022 - Updated the manual to Bforartists 3 version 3.2.0
- 09.04.2022 - Updated the manual to Bforartists 3 version 3.1.3
- 04.04.2022 - Updated the manual to Bforartists 3 version 3.1.2
- 10.03.2022 - Updated the manual to Bforartists 3 version 3.1.0
- 02.02.2022 - Updated the manual to Bforartists 3 version 3.0.1
- 30.11.2021 - Updated the manual to Bforartists 3 version 3.0.0
- 18.07.2021 - Updated the manual to Bforartists 2 version 2.9.3
- 01.07.2021 - Updated the manual to Bforartists 2 version 2.9.2
- 25.06.2021 - Updated the manual to Bforartists 2 version 2.9.1
- 10.06.2021 - Updated the manual to Bforartists 2 version 2.9.0
- 27.02.2021 - Updated the manual to Bforartists 2 version 2.8.0
- 26.01.2021 - Updated the manual to Bforartists 2 version 2.7.0
- 27.11.2020 - Updated the manual to Bforartists 2 version 2.6.0
- 24.09.2020 - Updated the manual to Bforartists 2 version 2.5.1
- 01.09.2020 - Updated the manual to Bforartists 2 version 2.5.0
- 31.08.2020 - Cleanup and spell checking.
- 28.08.2020 - Improved chapter 7.3.6 Editors - 3D View - Sidebar - Tool Tab - Mesh - Sculpt Mode
- 27.08.2020 - Updated the manual to Bforartists 2 version 2.5.0
- 24.08.2020 - Added chapters 13 around video editing

17.08.2020 - Added chapter 25.10.6 + 25.10.7 + 25.10.8

13.08.2020 - Added chapter 25.10.4 + 25.10.5

11.08.2020 - Added chapter 25.10.3

10.08.2020 - Added chapter 25.10.2

08.08.2020 - Added chapter 25.10 and 25.10.1

07.08.2020 - Added chapters around 25.9, Particles tab

04.08.2020 - Updated manual to Bforartists 2.4.0

30.07.2020 - Added chapter 25.14 Editors - Properties Editor - Texture Tab.pdf

29.07.2020 - Added chapter 25.13 Editors - Properties Editor - Materials Tab.pdf

28.07.2020 - UV Editor , added chapters 25.12 around the object data tab

22.07.2020 - UV Editor , added documentation for UDIM

18.07.2020 - Small additions and corrections. Added chapter 25.12 and 7.3.15

14.07.2020 - Updated the manual to the latest changes of Bforartists 2.3.0

12.07.2020 - Added chapter 25.8.4 and 25.8.5

09.07.2020 – Added chapter 25.8.3

06.07.2020 – Added chapter 25.8.1 and 25.8.2

03.07.2020 - Added chapter 25.8 Editors - Properties Editor - Modifiers Tab.odt, Update chapter 7.2.2

01.07.2020 - Added chapter 25.11 Editors - Properties Editor - Object Constraints Tab

30.06.2020 - Updated chapter 25.7

29.06.2020 - Updated chapters 12, 20 and 25.4, added chapter 25.5

28.06.2020 - Updated the manual to the changes of Bforartists, splitted chapter 5 into sub chapters, added chapter 25.6 Editors - Properties Editor - World Tab

25.06.2020 - Added chapter 25.3 Editors - Properties Editor - Output Tab

21.06.2020 - Added chapters 19 around NLA editor

17.06.2020 - Added chapters 7.0.x around the 3D view context menus

12.06.2020 - Updated chapter 36 Standard Keymap

10.06.2020 - Updated chapter 33 Glossary

09.06.2020 - Reordered some chapters, added some missing information

09.06.2020 - Removed lots of "Here you can" phrases

07.06.2020 - Added chapters 18 around Drivers Editor

29.05.2020 - Manual update for upcoming Bforartists 2.1.0 version

28.05.2020 - Manual update for upcoming Bforartists 2.1.0 version

01.06.2020 - Added chapters 17 around Graph Editor

28.05.2020 - Manual update for upcoming Bforartists 2.1.0 version

25.05.2020 - Added chapters 16 around the Timeline

23.05.2020 - Updated chapters to new sculpting feature Draw Face Sets

22.05.2020 - Updated chapter 2 Keymap

20.05.2020 - Manual update for upcoming Bforartists 2.1.0 version, changed order of chapters in chapter 8 and 9.

16.05.2020 - Added chapters 15 around the dope sheet editor

09.05.2020 - Added chapters 14 around the movie clip editor.

28.04.2020 - Added chapter 37 - How to use the Manual

18.04.2020 - Updated the manual for Bforartists 2 gold

16.04.2020 - Updated the manual for Bforartists 2 Release Candidate

02.04.2020 - Added chapters 11 around the compositor editor

20.03.2020 - Added chapters 10 around the shader editor.

17.03.2020 - Updated the manual to Bforartists 2 Beta 0.9.1

21.02.2020 - Small changes at chapter 2, 7.1.5, 7.1.14, 7.3.11 and 22, rework at chapters 7.3.6 to 7.3.15

20.02.2020 - Updated chapter 8.3.1 and 7.3.11

19.02.2020 - Updated the manual to the latest changes for the Bforartists 2 Alpha 0.9.0 release

13.02.2020 - updated chapters 7.3.6 Editors - 3D View - Sidebar - Tool Tab - Sculpt Mode, 7.3.7 Editors - 3D View - Sidebar - Tool Tab - Vertex Paint Mode, 7.3.8 Editors - 3D View - Sidebar - Tool Tab - Weight Paint Mode, 7.3.9 Editors - 3D View - Sidebar - Tool Tab - Texture Paint Mode and 8.3.1 Editors - Image Editor - Sidebar - Tools Tab in Paint Mode

04.02.2020 - added chapter 10 Editors - Shader Editor.pdf

01.02.2020 - moved the chapters properties - tools tab to 3d view - tools tab

23.01.2020 - added chapter 9.3 Editors - UV Editor - Sidebar.pdf, 9.3.1 Editors - UV Editor - Sidebar - Image Tab.pdf, 9.3.2 Editors - UV Editor - Sidebar - Tools Tab.pdf and 9.3.3 Editors - UV Editor - Sidebar - View Tab.pdf

01.01.2020 - reorganized chapter 7.1 and 7.2

29.12.2019 - updated chapter 1 Installing Bforartists.pdf

29.12.2019 - added chapter 9.1.5 Editors - UV Editor - Header - Header Tools.pdf

20.12.2019 - added chapter 9.1.4 Editors - UV Editor - Header - UV menu.pdf

18.12.2019 - added chapter 9.1.3 Editors - UV Editor - Header - Image Menu.pdf

- 17.12.2019 - added chapter 9.1.2 Editors - UV Editor - Header - Select Menu.pdf
- 16.12.2019 - added chapter 9 Editors - UV Editor.pdf, 9.1 Editors - UV Editor - Header.pdf, 9.1.1 Editors - UV Editor - Header - View Menu.pdf
- 12.12.2019 - added chapter 8.3.3 Editors - Image Editor - Sidebar - View Tab.pdf, 8.3.4 Editors - Image Editor - Sidebar - Scopes Tab.pdf and 8.3.5 Editors - Image Editor - Sidebar - Mask Tab.pdf
- 09.12.2019 - added chapter 8.3.2 Editors - Image Editor - Sidebar - Image Tab.pdf
- 28.11.2019 - added chapter 8.1.7 Editors - Image Editor - Tool Shelf.pdf
- 20.11.2019 - added chapter 8.1.3 Editors - Image Editor - Header - Select menu, 8.1.4 Editors - Image Editor - Header - Add menu, 8.1.5 Editors - Image Editor - Header - Mask menu, 8.1.6 Editors - Image Editor - Header - Header Tools.pdf
- 18.11.2019 - added chapter 8.1.2 Editors - Image Editor - Header - Image menu.pdf
- 17.11.2019 - small changes at chapter 7.2, 7.23 and 8, added 8.1 Editors - Image Editor - Header.pdf and 8.1.1 Editors - Image Editor - Header - View menu.pdf
- 16.11.2019 - added chapter 8 Editors - Image Editor.pdf, Update chapter 6 Editors introduction.pdf
- 15.11.2019 - added chapter 7.3.1 Editors - 3D View - Sidebar - Mini Lightlib.pdf
- 14.11.2019 - added chapter 7.3 Editors - 3D View - Sidebar.pdf
- 11.11.2019 - added brush menu to chapters 7.2, renamed chapters
- 10.11.2019 - Added chapter 7.1.15 Editors - 3D View - Tool Shelf - Grease Pencil - Weight Paint Mode and 7.1.16 Editors - 3D View - Tool Shelf - Armature - Edit Mode.pdf and 7.1.17 Editors - 3D View - Tool Shelf - Armature - Pose Mode.pdf and 7.1.18 Editors - 3D View - Tool Shelf - Lattice - Edit Mode.pdf
- 09.11.2019 - Added chapter 7.1.14 Editors - 3D View - Tool Shelf - Grease Pencil - Draw Mode
- 08.11.2019 - Added chapter 7.1.13 Editors - 3D View - Tool Shelf - Grase Pencil - Sculpt Mode.pdf
- 06.11.2019 - Added chapter 7.1.11 Editors - 3D View - Tool Shelf - Text - Edit Mode.pdf, 7.1.12 Editors - 3D View - Tool Shelf - Grase Pencil - Edit Mode.pdf
- 05.11.2019 - Added chapter 7.1.9 Editors - 3D View - Tool Shelf - Surface - Edit Mode, 7.1.10 Editors - 3D View - Tool Shelf - Metaball - Edit Mode
- 04.11.2019 - Added chapter 7.1.7 Editors - 3D View - Tool Shelf - Mesh - Particle Edit Mode.pdf and 7.1.8 Editors - 3D View - Tool Shelf - Curve - Edit Mode.pdf, small fixes
- 31.10.2019 - Added chapter 7.1.6 Editors - 3D View - Tool Shelf - Mesh - Textute Paint Mode.pdf
- 30.10.2019 - Added chapter 7.1.5 Editors - 3D View - Tool Shelf - Mesh - Weight Paint Mode.pdf
- 29.10.2019 - Added chapter 7.1.4 Editors - 3D View - Tool Shelf - Mesh - Vertex Paint Mode.pdf
- 28.10.2019 - Added chapter 7.1.3 Editors - 3D View - Tool Shelf - Mesh - Sculpt Mode.pdf
- 27.10.2019 - Updated chapter 25.1.3 Editors - Properties Editor - Tools Tab - Sculpt Mode.odt
- 26.10.2019 - Added chapter 7.1.2 Editors - 3D View - Tool Shelf - Mesh - Edit Mode.pdf

22.10.2019 - Added chapter 7.1.1 Editors - 3D View - Tool Shelf - Object Mode.pdf

18.10.2019 - Added chapter 7.1 Editors - 3D View - Tool Shelf.pdf

16.10.2019 - Reordered the header menu chapters in the 3d view.

15.10.2019 - Added chapter 7.2.8.15 Editors - 3D View - Header - Grease Pencil - Draw mode - Draw menu.pdf and 7.2.8.15 Editors - 3D View - Header - Grease Pencil - Weight Paint Mode - Weights Menu.pdf

13.10.2019 - Added chapter 7.2.14 Editors - 3D View - Header - Armature - Pose mode - Pose menu.pdf

09.10.2019 - Added chapter 7.2.12 Editors - 3D View - Header - Particle - Particle mode - Particle menu.pdf

08.10.2019 - Added chapter 7.2.11 Editors - 3D View - Header - Mesh - Weight Paint mode - Weight menu.pdf

07.10.2019 - Added chapter 7.2.9 Editors - 3D View - Header - Mesh - Sculpt mode - Sculpt menu.pdf and 7.2.9.1 Editors - 3D View - Header - Mesh - Sculpt mode - Mask menu.pdf and 7.2.10 Editors - 3D View - Header - Mesh - Vertex Paint mode - Paint menu.pdf

06.10.2019 - Added chapter 7.2.8.17 Editors - 3D View - Header - Armature - Edit mode - Armature menu.pdf, 7.2.8.18 Editors - 3D View - Header - Lattice - Edit mode - Lattice menu.pdf

05.10.2019 - Update the manual to the changes of Bforartists 0.7.0 #141

30.09.2019 - Added chapter 7.2.8.15 Editors - 3D View - Header - Grease Pencil - Edit mode - Stroke menu.pdf, added chapter 7.2.8.16 Editors - 3D View - Header - Grease Pencil - Edit mode - Points menu.pdf

27.09.2019 - Added chapter 7.2.8.14 Editors - 3D View - Header - Grease Pencil - Edit mode - Grease Pencil menu.pdf

23.09.2019 - Added chapter 7.2.8.13 Editors - 3D View - Header - Text - Edit mode - Font menu.pdf

22.09.2019 - Added chapter 7.2.8.12 Editors - 3D View - Header - Text - Edit mode - Edit menu.pdf

21.09.2019 - Fixes at chapter 7.2.8.8 and 7.2.8.9, added chapter 7.2.8.10 Editors - 3D View - Header - Surface - Edit mode - Surface menu, added 7.2.8.11 Editors - 3D View - Header - Metaball - Edit mode - Metaball menu.pdf

20.09.2019 - Added chapter 7.2.8.8 Editors - 3D View - Header - Edit mode - Control points menu.pdf, 7.2.8.9 Editors - 3D View - Header - Curve - Edit mode - Segments menu.pdf, renamed chapter 7.2.8.2 up to 7.2.8.8

19.09.2019 - Added chapter 7.2.8.7 Editors - 3D View - Header - Edit mode - Curve menu.pdf

18.09.2019 - Added chapter 7.2.8.6 Editors - 3D View - Header - Edit mode - UV menu.pdf

17.09.2019 - Added chapter 7.2.8.5 Editors - 3D View - Header - Edit mode - Faces menu.pdf

16.09.2019 - Added chapter 7.2.8.4 Editors - 3D View - Header - Edit mode - Edge Menu.pdf

15.09.2019 - Added chapter 7.2.8.3 Editors - 3D View - Header - Edit Mode - Vertex Menu.pdf

13.09.2019 - Added chapter 7.2.8.2 Editors - 3D View - Header - Edit mode - Mesh menu.pdf

05.09.2019 - Updated chapter 7.2.8.1 Editors - 3D View - Header - Edit mode - Add menu. Small fixes at 7.2.7 Editors - 3D View - Header - Object menu and 35 Bforartists History

03.09.2019 - Updated chapter 24 Editors - Outliner

- 02.09.2019 - Added chapter 7.2.7 Editors - 3D View - Header - Object menu
- 23.08.2019 - Added chapter 7.2.6 Editors - 3D View - Header - Add Menu
- 23.08.2019 - Added chapter 7.2.5 Editors - 3D View - Header - Select Menu
- 18.08.2019 - Added chapter 7.2.4 Editors - 3D View - Header - Navigation Menu
- 17.08.2019 - Added chapter 7.2.3 Editors - 3D View - Header - View Menu
- 16.08.2019 - Added chapter 7.2.2 Editors - 3D View - Header - Quick Menu
- 15.08.2019 - Added chapter 7.2.1 Editors - 3D View - Header tools and Options
- 25.07.2019 - Update chapter 7.2 Editors - 3D View - Header to BFA 2#63
- 22.07.2019 - Update chapter 7 Editors - 3D View to BFA 2 #61
- 19.07.2019 - Update chapter 25.2 Editors - Properties Editor - Render Tab to BFA 2 #98
- 12.07.2019 - Rework chapter 25.1 to 25.1.8 #137
- 07.07.2019 - Added chapter 25.16 Editors - Properties Editor - Bone Constraints
- 05.07.2019 - Updated chapter 27 Editors - Preferences
- 02.07.2019 - Updated chapter 2 - Standard Keymap
- 22.05.2019 - Added chapter 27 Editors - Preferences
- 16.05.2019 - Updated the chapters 2, 23, 24, 25 to fit to Bforartists 0.4.0 release
- 28.04.2019 - Updated the existing chapters with images to the latest development changes.
- 26.04.2019 - Added chapters 25.1 up to 25.1.8, the tools tab chapters
- 11.04.2019 - updated chapter 3,4,6 and 25 with new screenshots.
- 09.04.2019 - Small changes at chapter 4 and 5
- 08.04.2019 - Added chapter 6 Editors introduction.pdf
- 07.04.2019 - Added chapter 20 Editors - Text Editor.pdf
- 04.04.2019 - Added chapter 30 Advanced - Scripting & Extending Bforartists.pdf + 29 Advanced - Command Line.odt
- 02.04.2019 - Added chapter 31 Advanced - Working Limits
- 02.04.2019 - Added chapter 32 - Troubleshooting.pdf
- 01.04.2019 - Added chapter 25 Editors - Properties Editor.pdf
- 01.04.2019 - Updated chapter 3 and 4
- 31.03.2019 - Added chapter 3 Interface, and 4 Workspaces
- 28.03.2019 - Added chapter 26 Editors - File browser
- 27.03.2019 - Added chapter 28 Data System and updated chapter 5

Bforartists 3 Reference Manual - 40 Manual Update History

26.03.2019 - Added chapter 21 Editors - Python Console

25.03.2019 - Renamed all chapters again.

24.03.2019 - renamed chapter Topbar into Topbar and Footer. And extended this chapter.

21.03.2019 - Added chapter 35 Editors - Outliner

16.03.2019 - Added chapter 7 Topbar

06.03.2019 - Added chapter 17 + 36

04.03.2019 - Added chapter 95 + 96 + 1

04.03.2019 - changed the internal chapter numbering.

03.03.2019 - Updated chapter 20 Bforartists History.

08.02.2019 - Updated chapter 20 Bforartists History.

01-09-2018 - Initial commits. This changes marks the foundation for the Bforartists 2 manual.



41 Standard Keymap

Table of content

Introduction.....	8
Window.....	8
Window.....	8
Screen.....	9
Screen / Screen (Global).....	9
Screen /Screen Editing.....	10
Screen / Region Context Menu.....	10
View 2D.....	10
View 2D.....	11
View 2D Buttons List.....	11
View 2D Buttons List.....	11
User Interface.....	12
User Interface.....	12
3D View.....	12
3D View / 3D View (Global).....	12
3D View - Object Mode.....	16
3D View - Object Mode - Object Mode (Global).....	16
3D View - Object Mode - 3D View Tool : Tweak.....	17
3D View - Object Mode - 3D View Tool : Select Box.....	17
3D View - Object Mode - 3D View Tool : Select Circle.....	17
3D View - Object Mode - 3D View Tool : Select Lasso.....	17
3D View - Object Mode - 3D View Tool : Cursor.....	17
3D View - Object Mode - 3D View Tool : Move.....	18
3D View - Object Mode - 3D View Tool : Rotate.....	18
3D View - Object Mode - 3D View Tool : Scale.....	18
3D View - Object Mode - 3D View Tool : Measure.....	18
3D View - Object Mode - 3D View Tool : Add Primitive.....	18
3D View - Mesh.....	18
3D View - Mesh - Mesh (Global).....	18
3D View - Mesh - 3D View Tool : Tweak.....	20
3D View - Mesh - 3D View Tool : Select Box.....	20
3D View - Mesh - 3D View Tool : Select Circle.....	20
3D View - Mesh - 3D View Tool : Select Lasso.....	20
3D View - Mesh - 3D View Tool : Cursor.....	20
3D View - Mesh - 3D View Tool : Move.....	20
3D View - Mesh - 3D View Tool : Rotate.....	20
3D View - Mesh - 3D View Tool : Scale.....	21
3D View - Mesh - 3D View Tool : Transform.....	21
3D View - Mesh - 3D View Tool : Measure.....	21
3D View - Mesh - 3D View Tool : Edit Mesh, Add Primitive.....	21
3D View - Mesh - 3D View Tool : Edit Mesh, Extrude Region.....	21
3D View - Mesh - 3D View Tool : Edit Mesh, Extrude Along Normals.....	21
3D View - Mesh - 3D View Tool : Edit Mesh, Extrude Individual.....	21
3D View - Mesh - 3D View Tool : Edit Mesh, Extrude to Cursor.....	21
3D View - Mesh - 3D View Tool : Edit Mesh, Inset Faces.....	21
3D View - Mesh - 3D View Tool : Edit Mesh, Bevel.....	21
3D View - Mesh - 3D View Tool : Edit Mesh, Loop Cut.....	22

3D View - Mesh - 3D View Tool : Edit Mesh, Offset Edge Loop Cut.....	22
3D View - Mesh - 3D View Tool : Edit Mesh, Knife.....	22
3D View - Mesh - 3D View Tool : Edit Mesh, Bisect.....	22
3D View - Mesh - 3D View Tool : Edit Mesh, Poly Build.....	22
3D View - Mesh - 3D View Tool : Edit Mesh, Spin.....	22
3D View - Mesh - 3D View Tool : Edit Mesh, Spin Duplicate.....	22
3D View - Mesh - 3D View Tool : Edit Mesh, Smooth.....	22
3D View - Mesh - 3D View Tool : Edit Mesh, Randomize.....	22
3D View - Mesh - 3D View Tool : Edit Mesh, Edge Slide.....	22
3D View - Mesh - 3D View Tool : Edit Mesh, Vertex Slide.....	23
3D View - Mesh - 3D View Tool : Edit Mesh, Shrink/Fatten.....	23
3D View - Mesh - 3D View Tool : Edit Mesh, Push Pull.....	23
3D View - Mesh - 3D View Tool : Edit Mesh, Shear.....	23
3D View - Mesh - 3D View Tool : Edit Mesh, To Sphere.....	23
3D View - Mesh - 3D View Tool : Edit Mesh, Rip Region.....	23
3D View - Mesh - 3D View Tool : Edit Mesh, Rip Edge.....	23
3D View - Curve.....	23
3D View - Curve (Global).....	23
3D View - Curve - 3D View Tool : Tweak.....	24
3D View - Curve - 3D View Tool : Select Box.....	24
3D View - Curve - 3D View Tool : Select Circle.....	25
3D View - Curve - 3D View Tool : Select Lasso.....	25
3D View - Curve - 3D View Tool : Cursor.....	25
3D View - Curve - 3D View Tool : Move.....	25
3D View - Curve - 3D View Tool : Rotate.....	25
3D View - Curve - 3D View Tool : Scale.....	25
3D View - Curve - 3D View Tool : Transform.....	25
3D View - Curve - 3D View Tool : Measure.....	25
3D View - Curve - 3D View Tool : Edit Curve, Draw.....	25
3D View - Curve - 3D View Tool : Edit Curve, Extrude.....	26
3D View - Curve - 3D View Tool : Edit Curve, Extrude Cursor.....	26
3D View - Curve - 3D View Tool : Edit Curve, Radius.....	26
3D View - Curve - 3D View Tool : Edit Curve, Tilt.....	26
3D View - Curve - 3D View Tool : Edit Mesh, Shear.....	26
3D View - Curve - 3D View Tool : Edit Curve, Randomize.....	26
3D View - Curve.....	26
3D View - Curve (Global).....	26
3D View - Armature.....	26
3D View - Armature (Global).....	27
3D View - Armature - 3D View Tool : Tweak.....	27
3D View - Armature - 3D View Tool : Select Box.....	27
3D View - Armature - 3D View Tool : Select Circle.....	28
3D View - Armature - 3D View Tool : Select Lasso.....	28
3D View - Armature - 3D View Tool : Cursor.....	28
3D View - Armature - 3D View Tool : Move.....	28
3D View - Armature - 3D View Tool : Rotate.....	28
3D View - Armature - 3D View Tool : Scale.....	28
3D View - Armature - 3D View Tool : Transform.....	28
3D View - Armature - 3D View Tool : Measure.....	28
3D View - Armature - 3D View Tool : Edit Armature - Roll.....	29
3D View - Armature - 3D View Tool : Edit Armature - Bone Size.....	29
3D View - Armature - 3D View Tool : Edit Armature - Bone Envelope.....	29
3D View - Armature - 3D View Tool : Edit Armature - Extrude.....	29

3D View - Armature - 3D View Tool : Edit Armature - Extrude to Cursor.....	29
3D View - Armature - 3D View Tool : Edit Armature, Shear.....	29
3D View - Metaball.....	29
3D View - Metaball(Global).....	29
3D View - Metaball - 3D View Tool : Tweak.....	30
3D View - Metaball - 3D View Tool : Select Box.....	30
3D View - Metaball - 3D View Tool : Select Circle.....	30
3D View - Metaball - 3D View Tool : Select Lasso.....	30
3D View - Metaball - 3D View Tool : Cursor.....	30
3D View - Metaball - 3D View Tool : Move.....	30
3D View - Metaball - 3D View Tool : Rotate.....	30
3D View - Metaball - 3D View Tool : Scale.....	30
3D View - Metaball - 3D View Tool : Transform.....	31
3D View - Metaball - 3D View Tool : Measure.....	31
3D View - Armature - 3D View Tool : Shear.....	31
3D View - Lattice.....	31
3D View - Lattice - Lattice(Global).....	31
3D View - Lattice - 3D View Tool : Tweak.....	31
3D View - Lattice - 3D View Tool : Select Box.....	31
3D View - Lattice - 3D View Tool : Select Circle.....	31
3D View - Lattice - 3D View Tool : Select Lasso.....	32
3D View - Lattice - 3D View Tool : Cursor.....	32
3D View - Lattice - 3D View Tool : Move.....	32
3D View - Lattice - 3D View Tool : Rotate.....	32
3D View - Lattice - 3D View Tool : Scale.....	32
3D View - Lattice - 3D View Tool : Transform.....	32
3D View - Lattice - 3D View Tool : Measure.....	32
3D View - Lattice - 3D View Tool : Shear.....	32
3D View - Font.....	32
3D View - Font - Font (Global).....	33
3D View - Font - 3D View Tool : Tweak.....	34
3D View - Font - 3D View Tool : Cursor.....	34
3D View - Font - 3D View Tool : Measure.....	34
3D View - Pose.....	34
3D View - Pose - Pose (Global).....	34
3D View - Pose - 3D View Tool : Tweak.....	35
3D View - Pose - 3D View Tool : Select Box.....	35
3D View - Pose - 3D View Tool : Select Circle.....	35
3D View - Pose - 3D View Tool : Select Lasso.....	35
3D View - Pose - 3D View Tool : Cursor.....	35
3D View - Pose - 3D View Tool : Move.....	35
3D View - Pose - 3D View Tool : Rotate.....	35
3D View - Pose - 3D View Tool : Scale.....	35
3D View - Pose - 3D View Tool : Transform.....	36
3D View - Pose - 3D View Tool : Measure.....	36
3D View - Pose - 3D View Tool : Pose, Breakdowner.....	36
3D View - Pose - 3D View Tool : Pose, Push.....	36
3D View - Pose - 3D View Tool : Pose, Relax.....	36
3D View - Vertex Paint.....	36
3D View - Vertex Paint Global.....	36
3D View - Weight Paint.....	37
3D View - Weight Paint - Weight Paint (Global).....	37
3D View - Weight Paint - 3D View Tool : Paint Weight, Gradient.....	37

3D View - Weight Paint - 3D View Tool : Paint Weight, Sample Weight.....	37
3D View - Weight Paint - 3D View Tool : Paint Weight, Sample Vertex Group.....	37
3D View - Paint Vertex Selection (Weight, Vertex).....	37
3D View - Paint Vertex Selection (Weight, Vertex).....	38
3D View - Paint Face Mask (Weight, Vertex, Texture).....	38
3D View - Image Paint.....	38
3D View - Image Paint (Global).....	38
3D View - Sculpt.....	39
3D View - Sculpt - Sculpt(Global).....	39
3D View - Weight Paint - 3D View Tool : Sculpt, Box Mask.....	40
3D View - Weight Paint - 3D View Tool : Sculpt, Lasso Mask.....	41
3D View - Weight Paint - 3D View Tool : Sculpt, Box Hide.....	41
3D View - Weight Paint - 3D View Tool : Sculpt, Mesh Filter.....	41
3D View - Weight Paint - 3D View Tool : Sculpt, Cloth Filter.....	41
3D View - Weight Paint - 3D View Tool : Move.....	41
3D View - Weight Paint - 3D View Tool : Rotate.....	41
3D View - Weight Paint - 3D View Tool : Scale.....	41
3D View - Weight Paint - 3D View Tool : Transform.....	41
3D View - Sculpt Curves.....	41
3D View - Sculpt Curves.....	41
3D View - Particle.....	42
3D View - Particle - Particle (Global).....	42
3D View - Particle - 3D View Tool : Tweak.....	42
3D View - Particle - 3D View Tool : Select Box.....	43
3D View - Particle - 3D View Tool : Select Circle.....	43
3D View - Particle - 3D View Tool : Select Lasso.....	43
3D View - Particle - 3D View Tool : Cursor.....	43
3D View - Knife Tool Modal Map.....	43
3D View - Custom Normals Modal Map.....	44
3D View - Bevel Modal Map.....	44
3D View - Paint Stroke Modal.....	45
3D View - Paint Curve.....	45
3D View - Object Non Modal.....	45
3D View - View 3D Walk Modal.....	46
3D View - View 3D Fly Modal.....	47
3D View - View 3D Rotate Modal.....	48
3D View - View 3D Move Modal.....	48
3D View - View 3D Zoom Modal.....	48
3D View - View 3D Dolly Modal.....	48
3D View - 3D View Generic.....	48
Graph Editor.....	48
Graph Editor / Graph Editor (Global).....	48
Graph Editor / Graph Editor Generic.....	50
Dope sheet.....	50
Dope sheet (Global).....	50
Dope sheet Generic.....	51
Dope sheet Generic.....	51
NLA Editor.....	51
NLA Editor / NLA Editor (Global).....	51
NLA Editor / NLA Channels.....	52
NLA Editor / NLA Generic.....	52
Image.....	52
Image / Image (Global).....	53

Image / UV Editor / UV Editor (Global).....	53
Image / UV Editor / Image Editor Tool: UV, Tweak.....	55
Image / UV Editor / Image Editor Tool: UV, Select Box.....	55
Image / UV Editor / Image Editor Tool: UV, Select Circle.....	55
Image / UV Editor / Image Editor Tool: UV, Select Lasso.....	55
Image / UV Editor / Image Editor Tool: UV, Cursor.....	55
Image / UV Editor / Image Editor Tool: UV, Move.....	55
Image / UV Editor / Image Editor Tool: UV, Rotate.....	55
Image / UV Editor / Image Editor Tool: UV, Scale.....	56
Image / Image Paint.....	56
Image / Image generic.....	56
Outliner.....	57
Outliner.....	57
Node Editor.....	58
Node Editor / Node Editor Global.....	58
Node Editor / Generic.....	60
SequencerCommon.....	60
SequencerCommon(Global).....	60
Sequencer.....	60
Sequencer (Global).....	60
Sequencer Tool: Tweak.....	62
Sequencer Tool: Tweak (fallback).....	62
Sequencer Tool: Select Box.....	62
Sequencer Tool: Select Box(fallback).....	62
SequencerPreview.....	63
SequencerPreview (Global).....	63
Sequencer Tool: Tweak.....	63
Sequencer Tool: Tweak (fallback).....	64
Sequencer Tool: Select Box.....	64
Sequencer Tool: Select Box(fallback).....	64
Sequencer Tool: Cursor.....	64
Sequencer Tool: Move.....	64
Sequencer Tool: Rotate.....	64
Sequencer Tool: Scale.....	64
Sequencer Tool: Sample.....	64
File Browser.....	64
File Browser / File Browser (Global).....	65
File Browser / File Browser Main.....	65
File Browser / File Browser Buttons.....	66
Info.....	66
Info.....	66
Property Editor.....	67
Property Editor.....	67
Text.....	67
Text / Text (Global).....	67
Text / Text Generic.....	69
Console.....	69
Console.....	69
Clip.....	70
Clip / Clip (Global).....	70
Clip / Clip Editor.....	71
Clip / Clip Graph Editor.....	72
Clip / Clip Dope sheet Editor.....	73

Grease Pencil.....	73
Grease Pencil / Grease Pencil(Global).....	73
Grease Pencil / Stroke Curve Edit Mode.....	73
Grease Pencil - Grease Pencil in Stroke edit mode.....	73
Grease Pencil / Grease Pencil Stroke Paint (Draw Brush).....	75
Grease Pencil / Grease Pencil Stroke Paint (Fill).....	75
Grease Pencil / Grease Pencil Stroke Paint (Erase).....	76
Grease Pencil / Grease Pencil Stroke Paint (Tint).....	76
Grease Pencil / Grease Pencil Stroke Paint Mode.....	76
Grease Pencil / Grease Pencil Stroke Sculpt Mode.....	76
Grease Pencil / Grease Pencil Stroke Sculpt Mode (Smooth).....	77
Grease Pencil / Grease Pencil Stroke Sculpt Mode (Thickness).....	77
Grease Pencil / Grease Pencil Stroke Sculpt Mode (Strength).....	77
Grease Pencil / Grease Pencil Stroke Sculpt Mode (Grab).....	77
Grease Pencil / Grease Pencil Stroke Sculpt Mode (Push).....	77
Grease Pencil / Grease Pencil Stroke Sculpt Mode (Twist).....	77
Grease Pencil / Grease Pencil Stroke Sculpt Mode (Pinch).....	78
Grease Pencil / Grease Pencil Stroke Sculpt Mode (Randomize).....	78
Grease Pencil / Grease Pencil Stroke Sculpt Mode (Clone).....	78
Grease Pencil / Grease Pencil Stroke Weight Mode.....	78
Grease Pencil / Grease Pencil Stroke Weight (Draw).....	78
Grease Pencil / Grease Pencil Stroke Vertex Mode.....	78
Grease Pencil / Grease Pencil Stroke Vertex (Draw).....	79
Grease Pencil / Grease Pencil Stroke Vertex (Blur).....	79
Grease Pencil / Grease Pencil Stroke Vertex (Average).....	80
Grease Pencil / Grease Pencil Stroke Vertex (Smear).....	80
Grease Pencil / Grease Pencil Stroke Vertex (Replace).....	80
Mask Editing.....	80
Mask Editing.....	80
Frames.....	81
Frames.....	81
Markers.....	82
Markers.....	82
Animation.....	82
Animation.....	82
Animation Channels.....	83
Animation Channels.....	83
View 3D Gesture Circle.....	83
View 3D Gesture Circle.....	83
Gesture Straight Line.....	84
Gesture Straight Line.....	84
Gesture Zoom Border.....	84
Gesture Zoom Border.....	84
Gesture Box.....	84
Gesture Box.....	84
Standard Modal Map.....	85
Standard Modal Map.....	85
Transform Modal Map.....	85
Transform Modal Map.....	85
Eyedropper Modal Map.....	86
Eyedropper Modal Map.....	86
Eyedropper ColorBand Point Sampling Map.....	86
Eyedropper ColorBand Point Sampling Map.....	87

Introduction

The interaction concept for Bforartists is the graphical UI. And so the Bforartists key map is as reduced as possible. It still contains most of the standard navigation hotkeys, and also standard hotkeys like for copy and paste, but nearly all hotkeys for tools are removed. So that users can implement their own hotkeys how they need it and when they need it.

The key map that you can find in the Input Manager in the User Preferences is nevertheless still pretty heavy as you can see here. That's because the Input Manager in the user preferences contains all available user interaction. And not just the usual hotkeys to call tools like in other software. There is no distinction between tools and things like editor manipulation. Every user interaction is defined here. So be careful what you change at the here listed input nodes. You may remove a vital part to deal with windows for example.

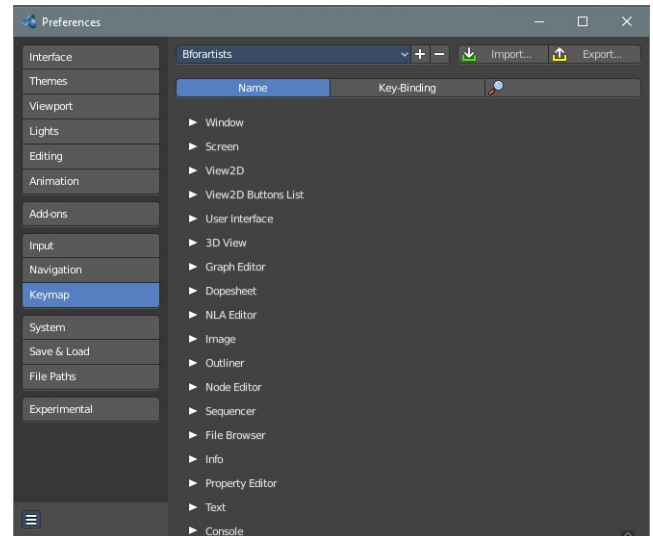

The hotkeys are also editor specific. So there are lots of repetitions when you need the same hotkeys across several editors too. Navigation hotkeys for example exists in all editor sub categories.

The key manager is divided into categories. And this part of the manual follows the same structure.

Legend

dbl- = Double tap. You need to press this key twice.

Ndof hotkeys are for tablet or 3d mouse.

Note that some hotkeys are used in more than one menu. That's for example the case for hotkeys in the Node Editor section. They are true in three different editors, Shader Editor, Compositor, and Texture Node Editor. To make it even worse, some exists in just one editor, and in a special mode.

Window

Window

Name	Function	Menu location	Hotkey
Reload Startup File	Creates a new scene	Header / New	Ctrl N
Open Blender File	Open Blender file	Header / Open	Ctrl O
Save Blender File	Save Blender File	Header / Save	Ctrl S
Save As Blender File	Save As Blender File	Header / Save as	Shift Ctrl S
Call Menu	Calls the Quick Favorites menu	No Location	Q
Call Menu	Ndof device for 3dConnexion	No Location	Ndof Menu
Context Scale Float	Ndof device for 3dConnexion	No Location	Ndof Plus
Context Scale Float	Ndof device for 3dConnexion	No Location	Ndof Minus

Window			
Context Scale Float	N dof device for 3dConnexion	No Location	Shift N dof Plus
Context Scale Float	N dof device for 3dConnexion	No Location	Shift N dof Minus
Update Reports Display	Unknown	No Location	Timer Report
Search Menu	Search Menu	Header / Edit Menu / Operator Search	F3
Toggle System Console	Toggles System Console - Windows only, makes problems on Linux.	Header / Window Menu / Toggle System Console	Alt F5
Call Menu	Calls the file context menu	None	F4
Rename Active Item	Calls a menu to rename the selected item	None	F2
Batch Rename	Batch rename of selected items	None	Ctrl F2

Screen

Screen / Screen (Global)			
Name	Function	Surface menu location	Hotkey
Animation Step	Unknown	No Location	Timer 0
Region Alpha	Unknown	No Location	Timer Region
Toggle Maximize Area	Toggles the current selected editor between Fullscreen and Windowed. WITHOUT menus	Right Mouse menu of the menu bars	Ctrl Spacebar
Toggle Maximize Area	Toggles the current selected editor between Fullscreen and Windowed. WITHOUT menus	Right Mouse menu of the menu bars	Ctrl Alt Spacebar
Cycle Space Context	Calls a pie menu to switch between modes.	None	Ctrl Tab
Cycle Workspace	Cycle through the workspaces	None	Ctrl Page Up
Cycle Workspace	Cycle through the workspaces	None	Ctrl Page Down
Toggle Quad View	Toggle Quad View	3D View / View Menu / Area Menu / Toggle Quad View	Ctrl Alt Q
Execute File Window	Execute. Like entering a value, then press enter....	None	Return
Execute File Window	Execute. Like entering a value, then press enter....	None	Numpad Enter
Cancel File load	Cancel file load	None	Esc
Undo	Undo	Sometimes in Object menu, sometimes in Edit menu. Also in 3D View Tool shelf / History	Ctrl Z
Redo	Redo Sometimes in Object menu, sometimes in Edit menu. Also in 3D View Tool shelf / History	Sometimes in Object menu, sometimes in Edit menu. Also in 3D View Tool shelf / History	Shift Ctrl Z
Render Image / Animation	Render a single image	Info Editor / Render / Render Image	F12
Render Image / Animation	Render animation sequence	Info Editor / Render / Render Animation	Ctrl F12
Cancel Render View	Escapes the Render View	No Menu entry	Esc
Show / Hide Render View	Show / Hide Render View	Header / Render / Show / Hide Render View	F11

Screen / Screen (Global)			
Play Rendered Animation	Play	Header / Render menu / View Animation	Ctrl F11
Flip Region	flips tool shelf or sidebar to the other side	None	F5
Redo Last	Calls the adjust last operation panel under the mouse	If available down left. Also in the toolbar.	F6
Undo	Undo of the last operation in asset manager	Edit menu	Ctrl Z
Redo	Redo of the last operation in asset manager	Edit menu	Shift Ctrl Z

Screen /Screen Editing			
Name	Function	Surface menu location	Hotkey
Handle Area Action Zones	Split / Join window code. Needed for Move Area edges and Area Options	None	Left Mouse
Handle Area Action Zones	Make new floating window. First part. You need both parts.	None	Shift Left Mouse
Handle Area Action Zones	Drag into other editor window to swap position with it. First part. You need both parts.	None	Left Mouse
Handle Area Action Zones	Drag into other editor window to swap position with it. First part. You need both parts.	None	Shift Left Mouse
Handle Area Action Zones	Drag into other editor window to swap position with it. First part. You need both parts.	None	Ctrl Left Mouse
Split area	Split Area code	None	Action Zone Area
Join Area	Join Area code	None	Action Zone Area
Duplicate Area into new Window	Make new floating window. Second part. You need both parts.	None	Shift Action Zone Area
Swap Areas	Drag into other editor window to swap position with it. Second part. You need both parts.	None	Ctrl Action Zone Area
Scale Region Size	Scale Region Size	None	Action Zone Region
Toggle Fullscreen Area	Toggle Fullscreen Area	None	Action Zone Fullscreen
Move Area Edges	Split Windows	None	Left Mouse
Area Options	Join Windows	None	Right Mouse

Screen / Region Context Menu			
Name	Function	Surface menu location	Hotkey
Context Menu	Calls the Right Mouse menu	Every menu bar	Right Mouse

View 2D

View 2D			
Name	Function	Surface menu location	Hotkey
Scroller Activate	Zooms in and out in Compositing and Texture Node editor	None	Left Mouse
Scroller Activate	Zooms in and out in Compositing and Texture Node editor	None	Middle Mouse
Pan View	Pans the view in Compositing and Texture Node editor	None	Middle Mouse
Pan View	Pans the view in Compositing and Texture Node editor	None	Shift Middle Mouse
Pan View	Pans the view in Compositing and Texture Node editor	None	Mouse/ Trackpad pan
Scroll right	Zooms in and out in Compositing and Texture Node editor	None	Ctrl Wheel down
Scroll left	Zooms in and out in Compositing and Texture Node editor	None	Ctrl Wheel up
Scroll down	Zooms in and out in Compositing and Texture Node editor	None	Shift Wheel down
Scroll up	Zooms in and out in Compositing and Texture Node editor	None	Shift Wheel up
NDOF Pan/Zoom	N dof device for 3dConnexion	None	N dof Motion
Zoom out	Zooms in and out in Compositing and Texture Node editor	UV Editor / View / View Zoom Out	Wheel out
Zoom in	Zooms in and out in Compositing and Texture Node editor	UV Editor / View / View Zoom In	Wheel in
Zoom out	Zooms in and out in Compositing and Texture Node editor	None	Numpad -
Zoom in	Zooms in and out in Compositing and Texture Node editor	None	Numpad +
Zoom 2D View	Zooms in and out in Compositing and Texture Node editor	None	Ctrl Mouse/ Trackpad pan
Smooth view 2D	???	None	Timer 1
Scroll down	Zooms in and out in Compositing and Texture Node editor	None	Wheel down
Scroll up	Zooms in and out in Compositing and Texture Node editor	None	Wheel up
Scroll right	Zooms in and out in Compositing and Texture Node editor	None	Wheel down
Scroll left	Zooms in and out in Compositing and Texture Node editor	None	Wheel up
Zoom 2D View	Zooms in and out in Compositing and Texture Node editor	None	Ctrl Middle Mouse
Zoom 2D View	Zooms in and out in Compositing and Texture Node editor	None	Mouse/Trackpad Zoom
Zoom Border	Calls the Zoom border navigation in Compositing and Texture Node editor	None	Shift B

View 2D Buttons List

View 2D Buttons List			
Name	Function	Surface menu location	Hotkey

View 2D Buttons List			
Scroller Activate	UV Editor Tool shelf navigation	None	Left Mouse
Scroller Activate	UV Editor Tool shelf navigation	None	Middle Mouse
Pan View	UV Editor Tool shelf navigation	None	Middle Mouse
Scroller Activate	UV Editor Tool shelf navigation	None	Mouse /Trackpad Pan
Scroll down	UV Editor Tool shelf navigation	None	Wheel down
Scroll up	UV Editor Tool shelf navigation	None	Wheel up
Scroll down	UV Editor Tool shelf navigation	None	Page down
Scroll up	UV Editor Tool shelf navigation	None	Page Up
Zoom 2D View	UV Editor Tool shelf navigation	None	Ctrl Middle Mouse
Zoom 2D View	UV Editor Tool shelf navigation	None	Mouse/ Trackpad Zoom
Zoom 2D View	UV Editor Tool shelf navigation	None	Ctrl Mouse/Trackpad Pan
Zoom out	UV Editor Tool shelf navigation	None	Numpad -
Zoom in	UV Editor Tool shelf navigation	None	Numpad +
Reset View	UV Editor Tool shelf navigation	None	Home

User Interface

User Interface			
Name	Function	Surface menu location	Hotkey
Eyedropper	Pick color	None	E
Eyedropper Colorband	Pick color	None	E
Eyedropper Colorband (points)	Pick color	None	Alt+E
Eyedropper Datablock	Pick color	None	E
Eyedropper Depth	Pick color	None	E
Copy Data Path	Copy Data Path	None	Shift Ctrl C
Copy Data Path	Copy Data Path	None	Shift Ctrl Alt C
Insert Keyframe (Buttons)	Insert Keyframes at buttons	None	I
Delete Keyframe (Buttons)	Delete Keyframes at buttons	None	Alt I
Clear Keyframe (Buttons)	Clears Keyframes at buttons	None	Shift Alt I
Add Driver	Add Driver	None	Ctrl D
Remove Driver	Remove Driver	None	Ctrl Alt D
Add to Keying Set	Add to Keying Set	None	K
Remove from Keying Set	Remove from Keying Set	None	Alt K
Reset to Default Value	Resets the prop under the mouse to its default value	None	Backspace
Rename View Item	Renames the view item in the Category Shelf	Asset Browser Category Shelf	F2

3D View

3D View / 3D View (Global)			
Name	Function	Surface menu location	Hotkey

3D View / 3D View (Global)			
Reset 3D View	Resets the 3D View		Numpad *
Set 3D Cursor	Sets the 3D cursor position to Mouse position.	None	Alt Right Mouse
Local View	Switches to local view and back, just showing the selection then	3D View / View menu	Numpad /
Remove from Local View	Removes the selected object from the local view	3D View / View menu	Ctrl Numpad /
Rotate View	Rotate view	None	Right Mouse
Pan View	Move view	3D view / tool shelf /tools tab / transform panel / Translate Button	Shift Middle Mouse
Zoom View	Zoom view. See also the other zoom methods.	3D view / tool shelf /tools tab / transform panel / Scale Button	Ctrl Middle Mouse
Dolly View	Dolly View moves the World camera forward or backward. Be careful with that one! You can trap yourself that regular zoom seems to have no more effect.	3D Viewport / View / Navigation / Dolly Zoom	Shift Ctrl Middle Mouse
View Selected	Brings the selected object into focus. With all regions.	3D Viewport / View / View Selected all Regions	Ctrl Numpad 0
View Selected	Brings the selected object into focus	3D Viewport / View / View Selected	Numpad 0
Smooth View	???	None	Timer 1
Rotate View	Rotates the view with trackpad	None	Mouse/Trackpad pan
Rotate View	Rotates the view with trackpad	None	Mouse/Trackpad Rotate
Move View	Moves the view with trackpad	None	Shift Mouse/Trackpad pan
Zoom View	Zooms the view with trackpad	None	Mouse/Trackpad Zoom
Zoom View	Zooms the view with trackpad	None	Ctrl Mouse/Trackpad pan
Zoom View	Zooms in	3D Viewport / View / View Selected	Numpad +
Zoom View	Zooms out	3D Viewport / View / View Selected	Numpad -
Zoom View	Zooms in	None	Ctrl = (german keyboard Ctrl *)
Zoom View	Zooms out	None	Ctrl -
Zoom View	Zooms in	None	Wheel in
Zoom View	Zooms out	None	Wheel out
Dolly View	Moves in. Dolly View moves the World camera forward or backward. Be careful with that one! You can trap yourself that regular zoom seems to have no more effect.	None	Shift Numpad +
Dolly View	Moves out. Dolly View moves the World camera forward or backward. Be careful with that one! You can trap yourself that regular zoom seems to have no more effect.	None	Shift Numpad -
Dolly View	Moves in. Dolly View moves the World camera forward or backward. Be careful with that one! You can trap yourself that regular zoom seems to have no more effect.	None	Shift Ctrl = (german keyboard Shift Ctrl *)

3D View / 3D View (Global)			
Dolly View	Moves out. Dolly View moves the World camera forward or backward. Be careful with that one! You can trap yourself that regular zoom seems to have no more effect.	None	Shift Ctrl -
Frame Camera bounds	Fits the camera passepayout into the viewport	3D Viewport / View / View Camera Center	Home (Pos1 at german keyboard)
View Lock Center	Center the view lock offset	3D Viewport / View / Align View	Home (Pos1 at german keyboard)
Frame All	View all objects in the scene	3D Viewport / View / View all	Home (Pos1 at german keyboard)
Frame All	View all objects in the scene in all regions.	None	Ctrl Home
Frame All	View and center all objects in the scene	None	Shift C
View	Calls the pivot point pie menu	None	` (german keyboard .)
View Navigation	Enters the Walk/Fly mode	Navi / View navigation (Walk/Fly)	Shift ` (german keyboard Shift .)
View Camera	Enters or leaves the camera view.	3D Viewport / View / Active Camera	Numpad ,
View Numpad	Switches to Front Ortho sight	3D Viewport / View / Front	Numpad 1
View Orbit	Orbit down	3D Viewport / View / Navigation / Orbit down	Numpad 2
View Numpad	Switches to Left Ortho sight	3D Viewport / View / Front	Numpad 3
View Orbit	Orbit Left	3D Viewport / View / Navigation / Orbit Left	Numpad 4
View Persp/ Ortho	Changes between orthographic and perspective presentation of the 3D viewport.	3D Viewport / View / View Persp/Ortho	Numpad 5
View Orbit	Orbit Right	3D Viewport / View / Navigation / Orbit Right	Numpad 6
View Numpad	Switches to Top Ortho sight	3D Viewport / View / Top	Numpad 7
View Orbit	Orbit Up	3D Viewport / View / Navigation / Orbit Up	Numpad 8
View Numpad	Switches to Back Ortho sight	3D Viewport / View / Back	Ctrl Numpad 1
View Numpad	Switches to Left Ortho sight	3D Viewport / View / Left	Ctrl Numpad 3
View Numpad	Switches to Bottom Ortho sight	3D Viewport / View / Bottom	Ctrl Numpad 7
View Pan	Moves the view down	3D Viewport / View / Pan down	Ctrl Numpad 2
View Pan	Moves the view left	3D Viewport / View / Pan Left	Ctrl Numpad 4
View Pan	Moves the view right	3D Viewport / View / Pan Right	Ctrl Numpad 6
View Pan	Moves the view up	3D Viewport / View / Pan Up	Ctrl Numpad 8
View Orbit	Mirrors the axis orientation	3D Viewport / View / Navigation / Orbit opposite	Numpad 9
View Axis	Switches to Front Ortho, but with the selected Object in center.	3D Viewport / View / Align View / Front	Shift Numpad 1
View Axis	Switches to Right Ortho, but with the selected Object in center.	3D Viewport / View / Align View / Right	Shift Numpad 3
View Axis	Switches to Top Ortho, but with the selected Object in center.	3D Viewport / View / Align View / Top	Shift Numpad 7
View Axis	Switches to Back Ortho, but with the selected Object in center.	3D Viewport / View / Align View / Back	Shift Ctrl Numpad 1
View Axis	Switches to Left Ortho, but with the selected Object in center.	3D Viewport / View / Align View / Left	Shift Ctrl Numpad 3

3D View / 3D View (Global)			
View Axis	Switches to Bottom Ortho, but with the selected Object in center.	3D Viewport / View / Align View / Bottom	Shift Ctrl Numpad 7
View Axis			Tweak Middle North
View Axis			Tweak Middle South
View Axis			Tweak Middle East
View Axis			Tweak Middle West
Center View to Mouse	Centers the view to the mouse	Navi menu	Alt Middle Mouse
N dof Orbit View with Zoom	N dof device for 3dConnexion	None	N dof Motion
N dof Orbit View	N dof device for 3dConnexion	None	Ctrl N dof Motion
N dof Pan View	N dof device for 3dConnexion	None	Shift N dof Motion
N dof Move View	N dof device for 3dConnexion	None	Shift Ctrl N dof Motion
View Selected	N dof device for 3dConnexion	None	N dof fit
N dof Orbit View with Zoom N dof Orbit View with Zoom	N dof device for 3dConnexion	None	N dof roll ccw
View Roll	N dof device for 3dConnexion	None	N dof roll cw
View Roll	N dof device for 3dConnexion	None	N dof Front
View Axis	N dof device for 3dConnexion	None	N dof Back
View Axis	N dof device for 3dConnexion	None	N dof Left
View Axis	N dof device for 3dConnexion	None	N dof Right
View Axis	N dof device for 3dConnexion	None	N dof Top
View Axis	N dof device for 3dConnexion	None	N dof Bottom
View Axis	N dof device for 3dConnexion	None	Shift N dof Front
View Axis	N dof device for 3dConnexion	None	Shift N dof Right
View Axis	N dof device for 3dConnexion	None	Shift N dof Top
Select	Activate/Select	None	Left Mouse
Select	Activate/Select	None	Shift Left Mouse
Select	Activate/Select	None	Ctrl Left Mouse
Select	Activate/Select	None	Alt Left Mouse
Select	Activate/Select	None	Shift Ctrl Left Mouse
Select	Activate/Select	None	Ctrl Alt Left Mouse
Select	Activate/Select	None	Shift Alt Left Mouse
Select	Activate/Select	None	Shift Ctrl Alt Left Mouse
Lasso Select	Lasso Select, select	3D Viewport / Select / Lasso Select	Tweak Right Any
Lasso Select	Lasso Select, deselect	None	Tweak Right Any
Zoom Border	Zoom in our out by drawing a border	3D Viewport / Navi	Shift B
Copy Objects	Copy	3D Viewport / Object / Copy	Ctrl C
Paste Objects	Paste	3D Viewport / Object / Paste	Ctrl V
Snap	Calls the Snap Pie Menu	None	Shift E
Move	Move	None	Tweak Left Any
Interactive Light Track to Cursor	Navigate a lamp of type sun or spot light to point at objects	None	Shift T
Pivot Point	Call pivot pie menu	None	.
Orientation	Call orientation pie menu	None	,
Set Tool by Name	Cycles through the select methods	The select tools are in the toolbar	Shift Q

3D View / 3D View (Global)			
Pan View	Pans the view	None	Middle Mouse
Rotate View	Rotates the view	None	Alt Middle Mouse
Toggle X Ray	Toggles the x ray mode in edit mode	Header	Alt Z
Toggle X Ray	Toggles the x ray mode in edit mode	Header	Alt Y
Move	Legacy move tool	Navi menu	Ctrl W
Rotate	Legacy rotate tool	Navi menu	Ctrl E
Scale	Legacy scale tool	Navi menu	Ctrl R
Context Toggle - Widgets	Toggles the gizmos in the 3d view	Header	Shift + Tab
Context Toggle - Overlays	Toggles the overlays in the 3D	Header	Tab

3D View - Object Mode

3D View - Object Mode - Object Mode (Global)			
Name	Function	Surface menu location	Hotkey
Groundplane	Creates a groundplane	Isocam Add-on - Add menu	Shift Ctrl Alt 4
Gameisocam4to3	Creates a camera	Isocam Add-on - Add menu	Shift Ctrl Alt 3
Gameisocam	Creates a camera	Isocam Add-on - Add menu	Shift Ctrl Alt 2
Trueisocam	Creates a camera	Isocam Add-on - Add menu	Shift Ctrl Alt 1
(De)select All	Select all / Deselect all	3D Viewport / Select /	A
Select None	Deselects all	3D Viewport / Select /	Alt A
Select Inverse	Inverse selection	3D Viewport / Select /	Ctrl I
(De)select All	Deselects all	None	dbl - A
Make Parent	Make Parent	3D Viewport / Object / Parent	Ctrl P
Clear Parent	Clears the Parent relationship	3D Viewport / Object / Parent	Alt P
Delete	Delete	3D Viewport / Object / Delete	Delete
Duplicate Objects	Duplicate Objects	3D Viewport / Object / Duplicate Objects	Shift D
Duplicate Linked	Duplicate linked Objects	3D Viewport / Object / Duplicate Linked	Alt D
Join	Join Object	3D Viewport / Object / Join	Ctrl J
Subdivision Set	Adds a SDS modifier to selected object and sets SDS Level to value	3D Viewport / Object / Subdivide / Subdivision Set	Ctrl 0
Subdivision Set	Adds a SDS modifier to selected object and sets SDS Level to value	3D Viewport / Object / Subdivide / Subdivision Set	Ctrl 1
Subdivision Set	Adds a SDS modifier to selected object and sets SDS Level to value	3D Viewport / Object / Subdivide / Subdivision Set	Ctrl 2
Subdivision Set	Adds a SDS modifier to selected object and sets SDS Level to value	3D Viewport / Object / Subdivide / Subdivision Set	Ctrl 3
Subdivision Set	Adds a SDS modifier to selected object and sets SDS Level to value	3D Viewport / Object / Subdivide / Subdivision Set	Ctrl 4
Subdivision Set	Adds a SDS modifier to selected object and sets SDS Level to value	3D Viewport / Object / Subdivide / Subdivision Set	Ctrl 5
Show hidden Objects	Show hidden objects	3D View / Object / Show Hide	Alt H
Hide Objects	Hide selected Objects	3D View / Object / Show Hide	H

3D View - Object Mode - Object Mode (Global)			
Insert Keyframe Menu	Calls the Keyframe menu	3D View / Object / Animation	I
Delete Keyframe	Delete Keyframe	3D View / Object / Animation	Alt I
Hide Unselected	Hide unselected objects	3D View / Object / Show Hide	Shift H
Object Context Menu	Calls a menu under the mouse	None	Right Mouse Click
Set Tool by Name	builtin.select_box	Tool shelf	B
Set Tool by Name	builtin.select_circle	Tool shelf	G
Set Tool by Name	builtin.move	Tool shelf	W
Set Tool by Name	builtin.rotate	Tool shelf	E
Set Tool by Name	builtin.scale	Tool shelf	R
Set Tool by Name	builtin.select	Tool shelf	D
Select Collection Group	Selects all in a Collection Group	3D Viewport	dbl - Shift Left Mouse
Select Collection Group (Extended)	Selects all in a Collection Group and extends current selection	3D Viewport	dbl - Ctrl Shift Left Mouse

3D View - Object Mode - 3D View Tool : Tweak			
Name	Function	Surface menu location	Hotkey
Select	Select all / Deselect all	Tool shelf	Left Mouse
Select	Toggle selection	Tool shelf	Shift Left Mouse

3D View - Object Mode - 3D View Tool : Select Box			
Name	Function	Surface menu location	Hotkey
Box Select	Select	Tool shelf	Tweak Left Any
Box Select	Add to selection	Tool shelf	Shift Tweak Left Any
Box Select	Subtract from selection	Tool shelf	Ctrl Tweak Left Any
Box Select	Intersect selection	Tool shelf	Shift Ctrl Tweak Left Any

3D View - Object Mode - 3D View Tool : Select Circle			
Name	Function	Surface menu location	Hotkey
Circle Select	Select	Tool shelf	Left Mouse
Circle Select	Add to selection	Tool shelf	Shift Left Mouse
Circle Select	Subtract from selection	Tool shelf	Ctrl Left Mouse

3D View - Object Mode - 3D View Tool : Select Lasso			
Name	Function	Surface menu location	Hotkey
Lasso Select	Select	Tool shelf	Tweak Left Any
Lasso Select	Add to selection	Tool shelf	Shift Tweak Left Any
Lasso Select	Subtract from selection	Tool shelf	Ctrl Tweak Left Any
Lasso Select	Intersect selection	Tool shelf	Shift Ctrl Tweak Left Any

3D View - Object Mode - 3D View Tool : Cursor			
Name	Function	Surface menu location	Hotkey
Set 3D Cursor	3D Cursor	Tool shelf	Left Mouse

3D View - Object Mode - 3D View Tool : Cursor

Move	3D Cursor	Tool shelf	Tweak Left Any
------	-----------	------------	----------------

3D View - Object Mode - 3D View Tool : Move

Name	Function	Surface menu location	Hotkey
Move		Tool shelf	Tweak Left Any

3D View - Object Mode - 3D View Tool : Rotate

Name	Function	Surface menu location	Hotkey
Rotate		Tool shelf	Tweak Left Any

3D View - Object Mode - 3D View Tool : Scale

Name	Function	Surface menu location	Hotkey
Resize	3D Cursor	Tool shelf	Tweak Left Any

3D View - Object Mode - 3D View Tool : Measure

Name	Function	Surface menu location	Hotkey
Ruler Add	The measure tool	Tool shelf	Tweak Left Any
Ruler Remove	The measure tool	Tool shelf	Delete

3D View - Object Mode - 3D View Tool : Add Primitive

Name	Function	Surface menu location	Hotkey
Add Primitive Object	Adds a primitive	Tool shelf	Tweak Left Any

3D View - Mesh**3D View - Mesh - Mesh (Global)**

Name	Function	Surface menu location	Hotkey
Select Mode	Vertice Select	3D View / Header	X
Select Mode	Edge Select	3D View / Header	C
Select Mode	Face Select	3D View / Header	V
Loop Select	Selects an edge loop	None	Alt Left Mouse
Loop Select	Selects an edge loop, adds to selection.	None	Shift Alt Left Mouse
Edge Ring Select	Selects a ring loop	None	Ctrl Alt Left Mouse
Edge Ring Select	Selects a ring loop, adds to selection.	None	Shift Ctrl Alt Left Mouse
Pick shortest path	Select shortest path between start and end edge	None	Ctrl Left Mouse
Pick shortest path	Select shortest path between start and end edge	None	Shift Ctrl Left Mouse
(De)select all	Selects / deselects all	3D View / Select / select all	A
Select None	Selects / deselects all	3D View / Select / Deselect all	Alt A
Select Inverse	Inverts the selection	3D View / Select / Inverse	Ctrl I
(De)select all	Clears the selection	3D View / Select / Inverse	dbl - A

3D View - Mesh - Mesh (Global)			
Select More	Select more	3D View / Select / Select More	Ctrl Numpad +
Select Less	Select less	3D View / Select / Select Less	Ctrl Numpad -
Select Linked	Select Linked	3D View / Select / Linked Pick Select	L
Select Linked	Deselect Linked	3D View / Select / Linked Pick Deselect	Shift L
Hide selection	Hide selected Object	3D Viewport / Mesh / Show Hide / Hide selected	H
Reveal Hidden	Show hidden Objects	3D Viewport / Mesh / Show Hide / Show Hidden	Alt H
Add Duplicate	Adds a duplicate	3D Viewport / Mesh / Add Duplicate	Shift D
Separate	Separate	3D Viewport / Mesh / Separate	P
Duplicate or Extrude to Cursor	Adds a duplicate of selection at mouse position, slightly rotates source object and target object	3D Viewport / Tool Shelf / Tools / Mesh Tools/ DupliEx	Ctrl Right Mouse
Duplicate or Extrude to Cursor	Adds a duplicate of selection at mouse position, slightly rotates target object only	3D Viewport / Tool Shelf / Tools / Mesh Tools/ DupliExRot	Shift Ctrl Right Mouse
Delete	Calls the Delete menu with special delete methods	3D Viewport / Mesh / Delete	Ctrl Delete
Dissolve Selection	Dissolves the selection. No pattern to see what method is used though.	None	Shift Ctrl Delete
UV Mapping	Calls the UV mapping sub menu	3D Viewport / Header	U
Mark Seam	Mark Seam for Unwrapping	3D Viewport / Header / UV menu	M
	3D Viewport / Header / UV menu		
Clear Seam	Clear Seam for Unwrapping	3D Viewport / Header / UV menu	N
Smart Delete	Deletes mode dependent what is selected in Edit mode.	3D Viewport / Mesh / Delete	Delete
Hide Unselected	Hide unselected Object(s)	3D Viewport / Mesh / Show Hide / Hide unselected	Shift H
Subdivision Set	Adds a SDS modifier to selected object and sets SDS Level to value	3D Viewport / Mesh / Subdivide / Subdivision Set	Ctrl 0
Subdivision Set	Adds a SDS modifier to selected object and sets SDS Level to value	3D Viewport / Mesh / Subdivide / Subdivision Set	Ctrl 1
Subdivision Set	Adds a SDS modifier to selected object and sets SDS Level to value	3D Viewport / Mesh / Subdivide / Subdivision Set	Ctrl 2
Subdivision Set	Adds a SDS modifier to selected object and sets SDS Level to value	3D Viewport / Mesh / Subdivide / Subdivision Set	Ctrl 3
Subdivision Set	Adds a SDS modifier to selected object and sets SDS Level to value	3D Viewport / Mesh / Subdivide / Subdivision Set	Ctrl 4
Subdivision Set	Adds a SDS modifier to selected object and sets SDS Level to value	3D Viewport / Mesh / Subdivide / Subdivision Set	Ctrl 5
Call Menu	Calls the right click menu under the mouse	None	Right Mouse Click
Set Tool by Name	builtin.select_box	Tool Shelf	B
Set Tool by Name	builtin.select_circle	Tool Shelf	G
Set Tool by Name	builtin.extrude_region	Tool Shelf	S
Set Tool by Name	builtin.move	Tool Shelf	W
Set Tool by Name	builtin.rotate	Tool Shelf	E

3D View - Mesh - Mesh (Global)			
Set Tool by Name	builtin.scale	Tool Shelf	R
Set Tool by Name	builtin.select	Tool Shelf	D
Set Tool by Name	builtin.knife	Tool Shelf	K
Set Tool by Name	builtin.loop_cut	Tool Shelf	Alt C
Set Tool by Name	builtin.bevel	Tool Shelf	Ctrl B

3D View - Mesh - 3D View Tool : Tweak			
Name	Function	Surface menu location	Hotkey
Select	Tweak	Tool shelf	Left Mouse
Select	Tweak	Tool shelf	Left Mouse

3D View - Mesh - 3D View Tool : Select Box			
Name	Function	Surface menu location	Hotkey
Box Select	Select	Tool shelf	Tweak Left Any
Box Select	Add to selection	Tool shelf	Shift Tweak Left Any
Box Select	Subtract from selection	Tool shelf	Ctrl Tweak Left Any
Box Select	Intersect selection	Tool shelf	Shift Ctrl Tweak Left Any

3D View - Mesh - 3D View Tool : Select Circle			
Name	Function	Surface menu location	Hotkey
Circle Select	Select	Tool shelf	Left Mouse
Circle Select	Add to selection	Tool shelf	Shift Left Mouse
Circle Select	Subtract from selection	Tool shelf	Ctrl Left Mouse

3D View - Mesh - 3D View Tool : Select Lasso			
Name	Function	Surface menu location	Hotkey
Lasso Select	Select	Tool shelf	Tweak Left Any
Lasso Select	Add to selection	Tool shelf	Shift Tweak Left Any
Lasso Select	Subtract from selection	Tool shelf	Ctrl Tweak Left Any
Lasso Select	Intersect selection	Tool shelf	Shift Ctrl Tweak Left Any

3D View - Mesh - 3D View Tool : Cursor			
Name	Function	Surface menu location	Hotkey
Set 3D Cursor	Set 3D Cursor	Tool shelf	Left Mouse
Move	Move	Tool shelf	Tweak Left Any

3D View - Mesh - 3D View Tool : Move			
Name	Function	Surface menu location	Hotkey
Move	Move	Tool shelf	Tweak Left Any

3D View - Mesh - 3D View Tool : Rotate			
Name	Function	Surface menu location	Hotkey

3D View - Mesh - 3D View Tool : Rotate

Rotate	Rotate	Tool shelf	Tweak Left Any
--------	--------	------------	----------------

3D View - Mesh - 3D View Tool : Scale

Name	Function	Surface menu location	Hotkey
Scale	Scale	Tool shelf	Tweak Left Any

3D View - Mesh - 3D View Tool : Transform

Name	Function	Surface menu location	Hotkey
Transform from Gizmo	Transform from Gizmo	Tool shelf	Tweak Left Any

3D View - Mesh - 3D View Tool : Measure

Name	Function	Surface menu location	Hotkey
Ruler Add	Ruler Add	Tool shelf	Tweak Left Any
Ruler Remove	Ruler Remove	Tool shelf	Delete

3D View - Mesh - 3D View Tool : Edit Mesh, Add Primitive

Name	Function	Surface menu location	Hotkey
Add Cube	Add primitive	Tool shelf	Tweak Left Any

3D View - Mesh - 3D View Tool : Edit Mesh, Extrude Region

Name	Function	Surface menu location	Hotkey
Extrude Region and Move	Extrude Region and Move	Tool shelf	Tweak Left Any

3D View - Mesh - 3D View Tool : Edit Mesh, Extrude Along Normals

Name	Function	Surface menu location	Hotkey
Extrude Region and Shrink/Fatten	Extrude Region and Shrink/Fatten	Tool shelf	Tweak Left Any

3D View - Mesh - 3D View Tool : Edit Mesh, Extrude Individual

Name	Function	Surface menu location	Hotkey
Extrude Individual Faces and Move	Extrude Individual Faces and Move	Tool shelf	Tweak Left Any

3D View - Mesh - 3D View Tool : Edit Mesh, Extrude to Cursor

Name	Function	Surface menu location	Hotkey
Duplicate or Extrude to Cursor	Duplicate or Extrude to Cursor	Tool shelf	Left Mouse

3D View - Mesh - 3D View Tool : Edit Mesh, Inset Faces

Name	Function	Surface menu location	Hotkey
Inset Faces	Inset Faces	Tool shelf	Tweak Left Any

3D View - Mesh - 3D View Tool : Edit Mesh, Bevel

Name	Function	Surface menu location	Hotkey
------	----------	-----------------------	--------

3D View - Mesh - 3D View Tool : Edit Mesh, Bevel

Bevel	Bevel	Tool shelf	Tweak Left Any
-------	-------	------------	----------------

3D View - Mesh - 3D View Tool : Edit Mesh, Loop Cut

Name	Function	Surface menu location	Hotkey
Loop Cut and Slide	Loop Cut and Slide	Tool shelf Tool shelf	Left Mouse

3D View - Mesh - 3D View Tool : Edit Mesh, Offset Edge Loop Cut

Name	Function	Surface menu location	Hotkey
Offset Edge Slide	Offset Edge Slide	Tool shelf	Left Mouse

3D View - Mesh - 3D View Tool : Edit Mesh, Knife

Name	Function	Surface menu location	Hotkey
Knife Topology Tool	Knife Topology Tool	Tool shelf	Left Mouse

3D View - Mesh - 3D View Tool : Edit Mesh, Bisect

Name	Function	Surface menu location	Hotkey
Bisect	Bisect	Tool shelf	Tweak Left Any

3D View - Mesh - 3D View Tool : Edit Mesh, Poly Build

Name	Function	Surface menu location	Hotkey
Face at Cursor Move	Face at Cursor Move	Tool shelf	Left Mouse
Split at Cursor Move	Split at Cursor Move	Tool shelf	Ctrl Left Mouse
Poly Build Dissolve at Cursor	Poly Build Dissolve at Cursor	Tool shelf	Alt Left Mouse

3D View - Mesh - 3D View Tool : Edit Mesh, Spin

Name	Function	Surface menu location	Hotkey
Spin	Spin	Tool shelf	Tweak Left Any

3D View - Mesh - 3D View Tool : Edit Mesh, Spin Duplicate

Name	Function	Surface menu location	Hotkey
Spin Duplicate	Spin Duplicate	Tool shelf	Tweak Left Any

3D View - Mesh - 3D View Tool : Edit Mesh, Smooth

Name	Function	Surface menu location	Hotkey
Smooth	Smooth	Tool shelf	Tweak Left Any

3D View - Mesh - 3D View Tool : Edit Mesh, Randomize

Name	Function	Surface menu location	Hotkey
Randomize	Randomize	Tool shelf	Tweak Left Any

3D View - Mesh - 3D View Tool : Edit Mesh, Edge Slide

Name	Function	Surface menu location	Hotkey
------	----------	-----------------------	--------

3D View - Mesh - 3D View Tool : Edit Mesh, Edge Slide

Edge Slide	Edge Slide	Tool shelf	Tweak Left Any
------------	------------	------------	----------------

3D View - Mesh - 3D View Tool : Edit Mesh, Vertex Slide

Name	Function	Surface menu location	Hotkey
Vertex Slide	Vertex Slide	Tool shelf	Tweak Left Any

3D View - Mesh - 3D View Tool : Edit Mesh, Shrink/Fatten

Name	Function	Surface menu location	Hotkey
Shrink/Fatten	Shrink/Fatten	Tool shelf	Tweak Left Any

3D View - Mesh - 3D View Tool : Edit Mesh, Push Pull

Name	Function	Surface menu location	Hotkey
Push Pull	Push Pull	Tool shelf	Tweak Left Any

3D View - Mesh - 3D View Tool : Edit Mesh, Shear

Name	Function	Surface menu location	Hotkey
Shear	Shear	Tool shelf	Tweak Left Any

3D View - Mesh - 3D View Tool : Edit Mesh, To Sphere

Name	Function	Surface menu location	Hotkey
To Sphere	To Sphere	Tool shelf	Tweak Left Any

3D View - Mesh - 3D View Tool : Edit Mesh, Rip Region

Name	Function	Surface menu location	Hotkey
Rip Region	Rip Region	Tool shelf	Tweak Left Any

3D View - Mesh - 3D View Tool : Edit Mesh, Rip Edge

Name	Function	Surface menu location	Hotkey
Extend Vertices	Extend Vertices	Tool shelf	Tweak Left Any

3D View - Curve**3D View - Curve (Global)**

Name	Function	Surface menu location	Hotkey
Add Vertex	Adds a duplicate of the selected curve points under the mouse.	None	Ctrl Right Mouse
(De)select all	Selects all	3D Viewport / Select / (De)select all	A
Select None	Deselects all	3D Viewport / Select / (De)select all	Alt A
Select Inverse	Inverts the selection	3D Viewport / Select / Inverse	Ctrl I
(De)select all	deselects all	3D Viewport / Select / (De)select all	dbl A

3D View - Curve (Global)			
Select More	Select more	3D Viewport / Select / Select More	Ctrl Numpad +
Select Less	Select less	3D Viewport / Select / Select Less	Ctrl Numpad -
Select Linked	Select Linked	3D View / Select / Linked Pick Select	L
Select Linked	Deselect Linked	3D View / Select / Linked Pick Deselect	Shift L
Picks shortest path	Picks shortest path	None	Ctrl Left Mouse
Extrude	Extrudes a new path segment	3D Viewport / Tool Shelf / Tools / Curve Tools / Extrude	S
Add Duplicate	Add Duplicate	3D Viewport / Curve / Add Duplicate	Shift D
Make Segment	Make curve segment	3D Viewport / Control Points / Make Segments	F
Delete	Calls the Delete menu	3D Viewport / Curve / Delete	Delete
Dissolve Vertices	Delete	3D Viewport / Curve / Delete	Ctrl Delete
Transform	Shrink Fatten	3D Viewport / Curve / Transform / Shrink Fatten	Alt S
Reveal Hidden	Show hidden Objects	3D Viewport / Curve / Show Hide / Show Hidden	Alt H
Hide selection	Hide selected Object	3D Viewport / Curve / Show Hide / Hide selected	H
Hide selection	Hide unselected Object(s)	3D Viewport / Curve / Show Hide / Hide unselected	Shift H
Curve Context Menu	calls a menu under the mouse	None	Right Mouse Click
Set Tool by Name	builtin.select_box	Tool Shelf	B
Set Tool by Name	builtin.select_circle	Tool Shelf	G
Set Tool by Name	builtin.move	Tool Shelf	W
Set Tool by Name	builtin.rotate	Tool Shelf	E
Set Tool by Name	builtin.scale	Tool Shelf	R
Set Tool by Name	builtin.select	Tool Shelf	D

3D View - Curve - 3D View Tool : Tweak			
Name	Function	Surface menu location	Hotkey
Select	Select	Tool shelf	Left Mouse
Select	Toggle Selection	Tool shelf	Shift Left Mouse

3D View - Curve - 3D View Tool : Select Box			
Name	Function	Surface menu location	Hotkey
Box Select	Select	Tool shelf	Tweak Left Any
Box Select	Add to selection	Tool shelf	Shift Tweak Left Any
Box Select	Subtract from selection	Tool shelf	Ctrl Tweak Left Any
Box Select	Intersect selection	Tool shelf	Shift Ctrl Tweak Left Any

3D View - Curve - 3D View Tool : Select Circle

Name	Function	Surface menu location	Hotkey
Circle Select	Select	Tool shelf	Left Mouse
Circle Select	Add to selection	Tool shelf	Shift Left Mouse
Circle Select	Subtract from selection	Tool shelf	Ctrl Left Mouse

3D View - Curve - 3D View Tool : Select Lasso

Name	Function	Surface menu location	Hotkey
Lasso Select	Select	Tool shelf	Tweak Left Any
Lasso Select	Add to selection	Tool shelf	Shift Tweak Left Any
Lasso Select	Subtract from selection	Tool shelf	Ctrl Tweak Left Any
Lasso Select	Intersect selection	Tool shelf	Shift Ctrl Tweak Left Any

3D View - Curve - 3D View Tool : Cursor

Name	Function	Surface menu location	Hotkey
Set 3D Cursor	Set 3D Cursor	Tool shelf	Left Mouse
Move	Move 3d cursor	Tool shelf	Tweak Left Any

3D View - Curve - 3D View Tool : Move

Name	Function	Surface menu location	Hotkey
Move	Move	Tool shelf	Tweak Left Any

3D View - Curve - 3D View Tool : Rotate

Name	Function	Surface menu location	Hotkey
Rotate	Rotate	Tool shelf	Tweak Left Any

3D View - Curve - 3D View Tool : Scale

Name	Function	Surface menu location	Hotkey
Scale	Scale	Tool shelf	Tweak Left Any

3D View - Curve - 3D View Tool : Transform

Name	Function	Surface menu location	Hotkey
Transform from Gizmo	Transform from Gizmo	Tool shelf	Tweak Left Any

3D View - Curve - 3D View Tool : Measure

Name	Function	Surface menu location	Hotkey
Ruler Add	Ruler Add	Tool shelf	Tweak Left Any

3D View - Curve - 3D View Tool : Edit Curve, Draw

Name	Function	Surface menu location	Hotkey
Draw Curve	Draw Curve	Tool shelf	Left Mouse

3D View - Curve - 3D View Tool : Edit Curve, Extrude

Name	Function	Surface menu location	Hotkey
Extrude Curve and Move	Extrude Curve and Move	Tool shelf	Tweak Left Any

3D View - Curve - 3D View Tool : Edit Curve, Extrude Cursor

Name	Function	Surface menu location	Hotkey
Add Vertex	Add Vertex	Tool shelf	Left Mouse

3D View - Curve - 3D View Tool : Edit Curve, Radius

Name	Function	Surface menu location	Hotkey
Radius	Radius	Tool shelf	Tweak Left Any

3D View - Curve - 3D View Tool : Edit Curve, Tilt

Name	Function	Surface menu location	Hotkey
Tilt	Tilt	Tool shelf	Tweak Left Any

3D View - Curve - 3D View Tool : Edit Mesh, Shear

Name	Function	Surface menu location	Hotkey
Shear	Shear	Tool shelf	Tweak Left Any

3D View - Curve - 3D View Tool : Edit Curve, Randomize

Name	Function	Surface menu location	Hotkey
Randomize	Randomize	Tool shelf	Tweak Left Any

3D View - Curve**3D View - Curve (Global)**

Name	Function	Surface menu location	Hotkey
Set Select Mode	Mesh Object with hair curve in Sculpt mode - Set the select mode in the header to Control Point	Header, right besides the mode dropdown.	Alt 1
Set Select Mode	Mesh Object with hair curve in Sculpt mode - Set the select mode in the header to Curve	Header, right besides the mode dropdown.	Alt 2
(De)select all	Selects all	3D Viewport / Select / All	A
(De)select all	Deselects all	3D Viewport / Select / None	Alt A
(De)select all	Inverts the selection	3D Viewport / Select / Inverse	Ctrl I
(De)select all	deselects all	None	dbl A

3D View - Armature

3D View - Armature (Global)			
Name	Function	Surface menu location	Hotkey
Hide Selected	Hide selected bone/s	Show/Hide	H
Reveal Hidden	Show hidden bones	Show/Hide	Alt H
(De)Select All	Select all	3D Viewport / Select	A
Select None	Select nothing	3D Viewport / Select	Alt A
Select Inverse	Invert selection	3D Viewport / Select	Ctrl I
(De)Select All	Select nothing	None	dbl A
Select More	Select more	3D View / Select / More	Ctrl Numpad +
Select Less	Select less	3D View / Select / Less	Ctrl Numpad -
Select Linked All	Select connected bones	3D View / Select / Connected	L
Pick shortest Path	Picks shortest path between start and end point and selects everything in between	None	Ctrl Left Mouse
Duplicate	Duplicate	3D Viewport / Armature	Shift D
Extrude	Extrude	3D Viewport / Armature	S
Extrude forked	Extrudes with option Forked enabled. Bones extrudes from the center of the selected joints.	None	Shift S
Click-Extrude	Extrudes the bone to mouse position.	None	Ctrl Right Mouse
Separate Bones	Separates the selected bone(s) into a new armature.	3D Viewport / Armature	P
Hide unselected	Hide unselected bone/s	Show/Hide	Shift H
Delete selected Bone(s)	Delete	3D Viewport / Armature	Delete
Dissolve selected bone(s)	Unions selected bones into one bone	3D Viewport / Armature	Ctrl Delete
Armature Context Menu	calls a menu under the mouse	None	Right Mouse Click
Set Tool by Name	builtin.select_box	Tool Shelf	B
Set Tool by Name	builtin.select_circle	Tool Shelf	G
Set Tool by Name	builtin.move	Tool Shelf	W
Set Tool by Name	builtin.rotate	Tool Shelf	E
Set Tool by Name	builtin.scale	Tool Shelf	R
Set Tool by Name	builtin.select	Tool Shelf	D
Make parent	armature.parent_set	3D Viewport / Armature	Ctrl P
Clear parent	armature.parent_clear	3D Viewport / Armature	Alt P

3D View - Armature - 3D View Tool : Tweak			
Name	Function	Surface menu location	Hotkey
Select	Select	Tool shelf	Left Mouse
Select	Toggle Selection	Tool shelf	Shift Left Mouse

3D View - Armature - 3D View Tool : Select Box			
Box Select	Select	Tool shelf	Tweak Left Any
Box Select	Add to selection	Tool shelf	Shift Tweak Left Any
Box Select	Subtract from selection	Tool shelf	Ctrl Tweak Left Any
Box Select	Intersect selection	Tool shelf	Shift Ctrl Tweak Left Any

3D View - Armature - 3D View Tool : Select Box

Box Select	Select	Tool shelf	Tweak Left Any
------------	--------	------------	----------------

3D View - Armature - 3D View Tool : Select Circle

Name	Function	Surface menu location	Hotkey
Circle Select	Select	Tool shelf	Left Mouse
Circle Select	Add to selection	Tool shelf	Shift Left Mouse
Circle Select	Subtract from selection	Tool shelf	Ctrl Left Mouse

3D View - Armature - 3D View Tool : Select Lasso

Name	Function	Surface menu location	Hotkey
Lasso Select	Select	Tool shelf	Tweak Left Any
Lasso Select	Add to selection	Tool shelf	Shift Tweak Left Any
Lasso Select	Subtract from selection	Tool shelf	Ctrl Tweak Left Any
Lasso Select	Intersect selection	Tool shelf	Shift Ctrl Tweak Left Any

3D View - Armature - 3D View Tool : Cursor

Name	Function	Surface menu location	Hotkey
Set 3D Cursor	Set 3D Cursor	Tool shelf	Left Mouse
Move	Move	Tool shelf	Tweak Left Any

3D View - Armature - 3D View Tool : Move

Name	Function	Surface menu location	Hotkey
Move	Move	Tool shelf	Tweak Left Any

3D View - Armature - 3D View Tool : Rotate

Name	Function	Surface menu location	Hotkey
Rotate	Rotate	Tool shelf	Tweak Left Any

3D View - Armature - 3D View Tool : Scale

Name	Function	Surface menu location	Hotkey
Scale	Scale	Tool shelf	Tweak Left Any

3D View - Armature - 3D View Tool : Transform

Name	Function	Surface menu location	Hotkey
Transform from Gizmo	Transform from Gizmo	Tool shelf	Tweak Left Any

3D View - Armature - 3D View Tool : Measure

Name	Function	Surface menu location	Hotkey
Ruler Add	Ruler Add	Tool shelf	Tweak Left Any
Ruler Remove	Ruler Remove		Delete

3D View - Armature - 3D View Tool : Edit Armature - Roll

Name	Function	Surface menu location	Hotkey
Transform	Transform	Tool shelf	Tweak Left Any

3D View - Armature - 3D View Tool : Edit Armature - Bone Size

Name	Function	Surface menu location	Hotkey
Transform	Transform	Tool shelf	Tweak Left Any

3D View - Armature - 3D View Tool : Edit Armature - Bone Envelope

Name	Function	Surface menu location	Hotkey
Transform		Tool shelf	Tweak Left Any

3D View - Armature - 3D View Tool : Edit Armature - Extrude

Name	Function	Surface menu location	Hotkey
Extrude	Extrude	Tool shelf	Tweak Left Any

3D View - Armature - 3D View Tool : Edit Armature - Extrude to Cursor

Name	Function	Surface menu location	Hotkey
Click-Extrude	Click-Extrude	Tool shelf	Left Mouse

3D View - Armature - 3D View Tool : Edit Armature, Shear

Name	Function	Surface menu location	Hotkey
Shear	Shear	Tool shelf	Tweak Left Any

3D View - Metaball**3D View - Metaball(Global)**

Name	Function	Surface menu location	Hotkey
Reveal	Show hidden	Show/Hide /	Alt H
Hide	Hide selected	Show/Hide /	H
Delete	Delete	Delete	Delete
Duplicate		3D View / Metaball /	Shift D
(De)select all	Selects all.	3D View / Select / (De)select all	A
Select None	Deselects all	3D View / Select / (De)select all	Alt A
Select Inverse	Inverts the selection	3D View / Select / Inverse	Ctrl I
(De)select all	Deselects all	None	dbl A
Hide Unselected	Hide unselected	Show/Hide /	Shift H
Metaball Context Menu	calls the right mouse menu under the mouse	None	Right Mouse Click
Set Tool by Name	builtin.select_box	Tool Shelf	B
Set Tool by Name	builtin.select_circle	Tool Shelf	G
Set Tool by Name	builtin.move	Tool Shelf	W
Set Tool by Name	builtin.rotate	Tool Shelf	E
Set Tool by Name	builtin.scale	Tool Shelf	R

3D View - Metaball(Global)

Set Tool by Name	builtin.select	Tool Shelf	D
------------------	----------------	------------	---

3D View - Metaball - 3D View Tool : Tweak

Name	Function	Surface menu location	Hotkey
Select	Select	Tool shelf	Left Mouse
Select	Invert selection	Tool shelf	Shift Left Mouse

3D View - Metaball - 3D View Tool : Select Box

Name	Function	Surface menu location	Hotkey
Box Select	Select	Tool shelf	Tweak Left Any
Box Select	Add to selection	Tool shelf	Shift Tweak Left Any
Box Select	Subtract from selection	Tool shelf	Ctrl Tweak Left Any
Box Select	Intersect selection	Tool shelf	Shift Ctrl Tweak Left Any

3D View - Metaball - 3D View Tool : Select Circle

Name	Function	Surface menu location	Hotkey
Circle Select	Select	Tool shelf	Left Mouse
Circle Select	Add to selection	Tool shelf	Shift Left Mouse
Circle Select	Subtract from selection	Tool shelf	Ctrl Left Mouse

3D View - Metaball - 3D View Tool : Select Lasso

Name	Function	Surface menu location	Hotkey
Lasso Select	Select	Tool shelf	Tweak Left Any
Lasso Select	Add to selection	Tool shelf	Shift Tweak Left Any
Lasso Select	Subtract from selection	Tool shelf	Ctrl Tweak Left Any
Lasso Select	Intersect selection	Tool shelf	Shift Ctrl Tweak Left Any

3D View - Metaball - 3D View Tool : Cursor

Name	Function	Surface menu location	Hotkey
Set 3D Cursor	Set 3D Cursor	Tool shelf	Left Mouse
Move	Move 3D Cursor	Tool shelf	Tweak Left Any

3D View - Metaball - 3D View Tool : Move

Name	Function	Surface menu location	Hotkey
Move	Move	Tool shelf	Tweak Left Any

3D View - Metaball - 3D View Tool : Rotate

Name	Function	Surface menu location	Hotkey
Rotate	Rotate	Tool shelf	Tweak Left Any

3D View - Metaball - 3D View Tool : Scale

Name	Function	Surface menu location	Hotkey
------	----------	-----------------------	--------

3D View - Metaball - 3D View Tool : Scale

Scale	Scale	Tool shelf	Tweak Left Any
-------	-------	------------	----------------

3D View - Metaball - 3D View Tool : Transform

Name	Function	Surface menu location	Hotkey
Transform from Gizmo	Transform from Gizmo	Tool shelf	Tweak Left Any

3D View - Metaball - 3D View Tool : Measure

Name	Function	Surface menu location	Hotkey
Ruler Add	Add Ruler	Tool shelf	Tweak Left Any
Ruler Remove	Remove Ruler	Tool shelf	Delete

3D View - Armature - 3D View Tool : Shear

Name	Function	Surface menu location	Hotkey
Shear	Shear	Tool shelf	Tweak Left Any

3D View - Lattice**3D View - Lattice - Lattice(Global)**

Name	Function	Surface menu location	Hotkey
(De)select all	Selects all.	3D View / Select / (De)select all	A
Select None	Deselects all	3D View / Select / (De)select all	Alt A
Select Inverse	Inverts the selection	3D View / Select / Inverse	Ctrl I
(De)select all	Deselects all	None	dbl A
3D View / Lattice / Select More	Select more	3D View / Select / Select more	Ctrl Numpad +
3D View / Lattice / Select Less	Select less	3D View / Select / Select less	Ctrl Numpad -
Call Menu	Calls the context menu	None	dbl Right Mouse

3D View - Lattice - 3D View Tool : Tweak

Name	Function	Surface menu location	Hotkey
Select	Select	Tool shelf	Left Mouse
Select	Invert selection	Tool shelf	Shift Left Mouse

3D View - Lattice - 3D View Tool : Select Box

Name	Function	Surface menu location	Hotkey
Box Select	Select	Tool shelf	Tweak Left Any
Box Select	Add to selection	Tool shelf	Shift Tweak Left Any
Box Select	Subtract from selection	Tool shelf	Ctrl Tweak Left Any
Box Select	Intersect selection	Tool shelf	Shift Ctrl Tweak Left Any

3D View - Lattice - 3D View Tool : Select Circle

Name	Function	Surface menu location	Hotkey
------	----------	-----------------------	--------

3D View - Lattice - 3D View Tool : Select Circle

Circle Select	Select	Tool shelf	Left Mouse
Circle Select	Add to selection	Tool shelf	Shift Left Mouse
Circle Select	Subtract from selection	Tool shelf	Ctrl Left Mouse

3D View - Lattice - 3D View Tool : Select Lasso

Name	Function	Surface menu location	Hotkey
Lasso Select	Select	Tool shelf	Tweak Left Any
Lasso Select	Add to selection	Tool shelf	Shift Tweak Left Any
Lasso Select	Subtract from selection	Tool shelf	Ctrl Tweak Left Any
Lasso Select	Intersect selection	Tool shelf	Shift Ctrl Tweak Left Any

3D View - Lattice - 3D View Tool : Cursor

Name	Function	Surface menu location	Hotkey
Set 3D Cursor	Set 3D Cursor	Tool shelf	Left Mouse
Move	Move 3D Cursor	Tool shelf	Tweak Left Any

3D View - Lattice - 3D View Tool : Move

Name	Function	Surface menu location	Hotkey
Move	Move	Tool shelf	Tweak Left Any

3D View - Lattice - 3D View Tool : Rotate

Name	Function	Surface menu location	Hotkey
Rotate	Rotate	Tool shelf	Tweak Left Any

3D View - Lattice - 3D View Tool : Scale

Name	Function	Surface menu location	Hotkey
Scale	Scale	Tool shelf	Tweak Left Any

3D View - Lattice - 3D View Tool : Transform

Name	Function	Surface menu location	Hotkey
Transform from Gizmo	Transform from Gizmo	Tool shelf	Tweak Left Any

3D View - Lattice - 3D View Tool : Measure

Name	Function	Surface menu location	Hotkey
Ruler Add		Tool shelf	Tweak Left Any
Ruler Remove	Remove Ruler	Tool shelf	Delete

3D View - Lattice - 3D View Tool : Shear

Name	Function	Surface menu location	Hotkey
Shear	Shear	Tool shelf	Tweak Left Any

3D View - Font

3D View - Font - Font (Global)			
Name	Function	Surface menu location	Hotkey
Delete	Deletes selected text	3D View / Text / Delete	Delete
Delete	Deletes next word	None	Ctrl Delete
Delete	Deletes last letter	None	Backspace
Delete	Previous or selection	None	Shift Backspace
Delete	Deletes whole text	None	Ctrl Backspace
Move Cursor	Text navigation	None	Home
Move Cursor	Text navigation	None	End
Move Cursor	Text navigation	None	Left Arrow
Move Cursor	Text navigation	None	Right Arrow
Move Cursor	Text navigation	None	Ctrl Left Arrow
Move Cursor	Text navigation	None	Ctrl Right Arrow
Move Cursor	Text navigation	None	Up Arrow
Move Cursor	Text navigation	None	Down Arrow
Move Cursor	Text navigation	None	Page Up
Move Cursor	Text navigation	None	Page Down
Move Cursor	Text navigation	None	Ctrl Home
Move Cursor	Text navigation	None	Ctrl End
Move Select	Text navigation	None	Shift Home
Move Select	Text navigation	None	Shift End
Move Select	Text navigation	None	Shift Left Arrow
Move Select	Text navigation	None	Shift Right Arrow
Move Select	Text navigation	None	Shift Ctrl Left Arrow
Move Select	Text navigation	None	Shift Ctrl Right Arrow
Move Select	Text navigation	None	Shift Up Arrow
Move Select	Text navigation	None	Shift Down Arrow
Move Select	Text navigation	None	Shift Page Up
Move Select	Text navigation	None	Shift Page Down
Move Select	Text navigation	None	Shift Ctrl Home
Move Select	Text navigation	None	Shift Ctrl End
Change Spacing	Text navigation	None	Alt Left Arrow
Change Spacing	Text navigation	None	Alt Right Arrow
Change Character	Text navigation	None	Alt Up Arrow
Change Character	Text navigation	None	Alt Down Arrow
Select All	Select All	3D View / Edit / Select All	Ctrl A
Copy Text	Copy Text	3D View / Edit / Copy Text	Ctrl C
Copy Text	Cut Text	3D View / Edit / Copy Text	Ctrl X
Paste Text	Paste Text	3D View / Edit / Paste Text	Ctrl V
Line Break	Line Break	None	Return
Insert Text	Insert Text	None	
Insert Text	Insert Text	None	Alt Backspace
Text Context Menu	calls a menu under the mouse	None	Right Mouse Click

3D View - Font - 3D View Tool : Tweak

Name	Function	Surface menu location	Hotkey
Select	Select	Tool shelf	Left Mouse
Select	Invert selection	Tool shelf	Shift Left Mouse

3D View - Font - 3D View Tool : Cursor

Name	Function	Surface menu location	Hotkey
Set 3D Cursor	Set 3D Cursor	Tool shelf	Left Mouse
Move	Move 3D Cursor	Tool shelf	Tweak Left Any

3D View - Font - 3D View Tool : Measure

Name	Function	Surface menu location	Hotkey
Ruler Add	Add ruler	Tool shelf	Tweak Left Any
Ruler Remove	Remove Ruler	Tool shelf	Delete

3D View - Pose**3D View - Pose - Pose (Global)**

Name	Function	Surface menu location	Hotkey
Parent	Calls the Make Parent panel	3d view \ Pose Menu	Ctrl P
Hide selected	Hide selected	3d view \ Pose Menu	H
Reveal Selected	Show hidden	3d view \ Pose Menu	Alt H
Clear Pose Rotation	Clear Pose Rotation	Pose menu /clear transform	Alt E
Clear Pose Location	Clear Pose Location	Pose menu /clear transform	Alt W
Clear Pose Scale	Clear Pose Scale	Pose menu /clear transform	Alt R
Copy pose	Copy pose3d view \ Pose Menu	3d view \ Pose Menu	Ctrl C
Paste pose	Paste Pose	3d view \ Pose Menu	Ctrl V
Paste Pose	Paste Pose flipped	3d view \ Pose Menu	Shift Ctrl V
(De)select all	Selects all.	3D View / Select / (De)select all	A
Select None	Deselects all	3D View / Select / (De)select all	Alt A
Select Inverse	Inverts the selection	3D View / Select / Inverse	Ctrl I
(De)select all	Deselects all	3D View / Select / None	dbl A
Transform	BBone scale - just for bbone type	3d view \ Pose Menu \ Transform	Ctrl Alt S
Insert Keyframe Menu	Calls the Insert Keyframe menu	3d view \ Pose Menu	I
Delete Keyframe	Delete Keyframe	3d view \ Pose Menu	Alt I
Hide selected	Hide unselected	3d view \ Pose Menu	Shift H
Pose Context Menu	calls a menu under the mouse	None	Right Mouse Click
Set Tool by Name	builtin.select_box	Tool Shelf	B
Set Tool by Name	builtin.select_circle	Tool Shelf	G
Set Tool by Name	builtin.move	Tool Shelf	W
Set Tool by Name	builtin.rotate	Tool Shelf	E
Set Tool by Name	builtin.scale	Tool Shelf	R
Set Tool by Name	builtin.select	Tool Shelf	D

3D View - Pose - 3D View Tool : Tweak

Name	Function	Surface menu location	Hotkey
Select	Select	Tool shelf	Left Mouse
Select	Invert selection	Tool shelf	Shift Left Mouse

3D View - Pose - 3D View Tool : Select Box

Name	Function	Surface menu location	Hotkey
Box Select	Select	Tool shelf	Tweak Left Any
Box Select	Add to selection	Tool shelf	Shift Tweak Left Any
Box Select	Subtract from selection	Tool shelf	Ctrl Tweak Left Any
Box Select	Intersect selection	Tool shelf	Shift Ctrl Tweak Left Any

3D View - Pose - 3D View Tool : Select Circle

Name	Function	Surface menu location	Hotkey
Circle Select	Select	Tool shelf	Left Mouse
Circle Select	Add to selection	Tool shelf	Shift Left Mouse
Circle Select	Subtract from selection	Tool shelf	Ctrl Left Mouse

3D View - Pose - 3D View Tool : Select Lasso

Name	Function	Surface menu location	Hotkey
Lasso Select	Select	Tool shelf	Tweak Left Any
Lasso Select	Add to selection	Tool shelf	Shift Tweak Left Any
Lasso Select	Subtract from selection	Tool shelf	Ctrl Tweak Left Any
Lasso Select	Intersect selection	Tool shelf	Shift Ctrl Tweak Left Any

3D View - Pose - 3D View Tool : Cursor

Name	Function	Surface menu location	Hotkey
Set 3D Cursor		Tool shelf	Left Mouse
Move		Tool shelf	Tweak Left Any

3D View - Pose - 3D View Tool : Move

Name	Function	Surface menu location	Hotkey
Move		Tool shelf	Tweak Left Any

3D View - Pose - 3D View Tool : Rotate

Name	Function	Surface menu location	Hotkey
Rotate		Tool shelf	Tweak Left Any

3D View - Pose - 3D View Tool : Scale

Name	Function	Surface menu location	Hotkey
Scale		Tool shelf	Tweak Left Any

3D View - Pose - 3D View Tool : Transform

Name	Function	Surface menu location	Hotkey
Transform from Gizmo		Tool shelf	Tweak Left Any

3D View - Pose - 3D View Tool : Measure

Name	Function	Surface menu location	Hotkey
Ruler Add	Add Ruler	Tool shelf	Tweak Left Any
Ruler Remove	Remove Ruler	Tool shelf	Delete

3D View - Pose - 3D View Tool : Pose, Breakdowner

Name	Function	Surface menu location	Hotkey
Pose Breakdowner	Pose Breakdowner	Tool shelf	Tweak Left Any

3D View - Pose - 3D View Tool : Pose, Push

Name	Function	Surface menu location	Hotkey
Push Pose	Push Pose	Tool shelf	Tweak Left Any

3D View - Pose - 3D View Tool : Pose, Relax

Name	Function	Surface menu location	Hotkey
Relax Pose	Relax Pose	Tool shelf	Tweak Left Any

3D View - Vertex Paint**3D View - Vertex Paint Global**

Name	Function	Surface menu location	Hotkey
Vertex Paint	Vertex Paint	None	Left Mouse
Radial Control	Sets the brush radius	3D View / Tool Shelf / Tools / Brush / Radius Slider	F
Radial Control	Sets the brush radius with a value in the middle	3D View / Tool Shelf / Tools / Brush / Radius Slider	Shift F
Radial Control	Sets the brush direction. Useful for painting with maps. Like for scales.	3D View / Tool Shelf / Tools / Brush / Radius Slider	Ctrl F
Stencil Brush Control	Brush Mode Stencil navigation	None	Alt Right Mouse
Stencil Brush Control	Brush Mode Stencil navigation	None	Shift Right Mouse
Stencil Brush Control	Brush Mode Stencil. Changes the angle value in the Texture tab	3D View / Tool Shelf / Tools / Texture	Ctrl Right Mouse
Stencil Brush Control	Brush Mode Stencil navigation	None	Shift Ctrl Alt Right Mouse
Stencil Brush Control	Brush Mode Stencil navigation	None	Shift Alt Right Mouse
Stencil Brush Control	Brush Mode Stencil navigation	None	Ctrl Alt Right Mouse
Sample Color	Samples a color under the mouse cursor	Brush menu	S
Vertex Paint Context Menu	calls a menu under the mouse	None	Right Mouse Click
Set Tool by Name	builtin.select_box	Tool Shelf	B

3D View - Vertex Paint Global

Set Tool by Name	builtin.select_circle	Tool Shelf	G
Set Tool by Name	builtin.select	Tool Shelf	D
More	Increase selection	Select menu	Ctrl Numpad +
Less	Decrease selection	Select menu	Ctrl Numpad -

3D View - Weight Paint**3D View - Weight Paint - Weight Paint (Global)**

Name	Function	Surface menu location	Hotkey
Weight Paint		None	Left Mouse
Weight Paint	Weight paint	None	Left Mouse
Weight Paint Sample Weight	Click at a bone to select it for weight painting.	None	CTRL Right Mouse
Weight Paint Sample Group	Calls Weight Paint Sample Group panel, which shows the available group for the current position	None	Shift Right Mouse
Weight Gradient	Draws a gradient at the weightmap	None	Alt Left Mouse
Weight Gradient	Draws a gradient at the weightmap	None	Ctrl Alt Left Mouse
Radial Control	Sets the brush radius	3D View / Tool Shelf / Tools / Brush / Radius Slider	F
Radial Control	Sets the brush strength	3D View / Tool Shelf / Tools / Brush / Radius Slider	Shift F
Radial Control	Sets the brush direction. Useful for painting with maps. Like for scales.	3D View / Tool Shelf / Tools / Brush / Radius Slider	Ctrl F
Select	Select	None	Ctrl Left Mouse
Weights Context Menu	calls a menu under the mouse	None	Right Mouse Click
Set Tool by Name	builtin.select_box	Tool Shelf	B
Set Tool by Name	builtin.select_circle	Tool Shelf	G

3D View - Weight Paint - 3D View Tool : Paint Weight, Gradient

Name	Function	Surface menu location	Hotkey
Weight Gradient		Tool shelf	Left Mouse

3D View - Weight Paint - 3D View Tool : Paint Weight, Sample Weight

Name	Function	Surface menu location	Hotkey
Weight Paint Sample Weight		Tool shelf	Left Mouse

3D View - Weight Paint - 3D View Tool : Paint Weight, Sample Vertex Group

Name	Function	Surface menu location	Hotkey
Weight Paint Sample Group		Tool shelf	Left Mouse

3D View - Paint Vertex Selection (Weight, Vertex)

3D View - Paint Vertex Selection (Weight, Vertex)

Name	Function	Surface Menu location	Hotkey
(De)select all	Selects all.	3D View / Select / (De)select all	A
(De)select all	Deselects all	3D View / Select / (De)select all	Alt A
(De)select all	Inverts the selection	3D View / Select / Inverse	Ctrl I
(De)select all	Deselects all	None	dbl A
Box Select	Box Select	3D View / Weight Paint Vertex Selection / Box Select	B
Lasso Select	Lasso Select	3D View / Weight Paint Vertex Selection / Lasso Select	Tweak Left Any
Lasso Select	Lasso Select	3D View / Weight Paint Vertex Selection / Lasso Select	Tweak Left Any
Circle Select	Circle Select	3D View / Weight Paint Vertex Selection / Circle Select	G

3D View - Paint Face Mask (Weight, Vertex, Texture)

Name	Function	Surface menu location	Hotkey
(De)select all	Selects all.	3D View / Select / (De)select all	A
(De)select all	Deselects all	3D View / Select / (De)select all	Alt A
(De)select all	Inverts the selection	3D View / Select / Inverse	Ctrl I
(De)select all	Deselects all	None	dbl A
Face Select Hide	Hide selected	3D View / Brush / Show/Hide /	H
Face Select Hide	Hide unselected	3D View / Brush / Show/Hide /	Shift H
Face Select Reveal	Show hidden	3D View / Brush / Show/Hide /	Alt H
Select Linked		None	Ctrl L
Select Linked Pick	Select Linked	3D View / Select / Linked Pick Select	L
Select Linked Pick	Select Linked	3D View / Select / Linked Pick Deselect	Shift L
More	Increase selection	Select menu	Ctrl Numpad +
Less	Decrease selection	Select menu	Ctrl Numpad -

3D View - Image Paint

3D View - Image Paint (Global)

Name	Function	Surface menu location	Hotkey
Image Paint	Image Paint	None	Left Mouse
Image Paint	Image Paint	None	Ctrl Left Mouse
Swap Colors	Inverts the current selected color to paint with	3D View / Tool Shelf / Tools / Brush / toggle button	X
Sample Color	Turns Mouse into a color picker.	3D View / Tool Shelf / Tools / Brush / eyedropper button	S
Stencil Brush Control	Brush Mode Stencil.	3D View / Tool Shelf / Tools / Texture mask - when mask mapping is stencil	Alt Right Mouse

3D View - Image Paint (Global)			
Stencil Brush Control	Brush Mode Stencil.	3D View / Tool Shelf / Tools / Texture mask - when mask mapping is stencil	Shift Right Mouse
Stencil Brush Control	Brush Mode Stencil. Changes the angle value in the Texture tab	3D View / Tool Shelf / Tools / Texture mask - when mask mapping is stencil	Ctrl Right Mouse
Stencil Brush Control	Brush Mode Stencil.	3D View / Tool Shelf / Tools / Texture mask - when mask mapping is stencil	Shift Ctrl Alt Right Mouse
Stencil Brush Control	Brush Mode Stencil.	3D View / Tool Shelf / Tools / Texture mask - when mask mapping is stencil	Shift Alt Right Mouse
Stencil Brush Control	Brush Mode Stencil.	3D View / Tool Shelf / Tools / Texture mask - when mask mapping is stencil	Ctrl Alt Right Mouse
Radial Control	Sets the brush radius	Brush menu	F
Radial Control	Sets the brush radius with a value in the middle	Brush menu	Shift F
Radial Control	Sets the brush direction. Useful for painting with maps. Like for scales.	Brush menu	Ctrl F
Radial Control	Sets the brush direction. Useful for painting with maps. Like for scales.	Brush menu	Ctrl Alt F
Texture Paint Context Menu	calls the right mouse menu under the mouse	None	Right Mouse Click
Grab Clone	Calls a menu	None	Right Mouse
Set Tool by Name	builtin.select_box	Tool Shelf	B
Set Tool by Name	builtin.select_circle	Tool Shelf	G
Set Tool by Name	builtin.select	Tool Shelf	D

3D View - Sculpt

3D View - Sculpt - Sculpt(Global)			
Name	Function	Surface menu location	Hotkey
Sculpt	Sculpt	None	Left Mouse
Sculpt	Sculpt	None	Ctrl Left Mouse
Sculpt	Sculpt	None	Shift Left Mouse
Face Sets Visibility	Toggle Face Set visibility	3D View / Hide/Mask / Show Bounding Box	H
Face Sets Visibility	Hide Face Set(s)s	3D View / Hide/Mask / Hide Bounding Box	Shift H
Face Sets Visibility	Show All Face Sets	3D View / Hide/Mask / Show All	Alt H
Subdivision Set	Adds a Multires modifier to selected object and sets SDS Level to value	Subdivide /	Ctrl 0
Subdivision Set	Adds a Multires modifier to selected object and sets SDS Level to value	Subdivide /	Ctrl 1
Subdivision Set	Adds a Multires modifier to selected object and sets SDS Level to value	Subdivide /	Ctrl 2

3D View - Sculpt - Sculpt(Global)			
Subdivision Set	Adds a Multires modifier to selected object and sets SDS Level to value	Subdivide /	Ctrl 3
Subdivision Set	Adds a Multires modifier to selected object and sets SDS Level to value	Subdivide /	Ctrl 4
Subdivision Set	Adds a Multires modifier to selected object and sets SDS Level to value	Subdivide /	Ctrl 5
Mask Lasso Gesture	Lasso select to select a mask area	Mask menu	Shift Ctrl Left Mouse
Set Detail Size	Sets Detail size of brush in Dyntopo mode!	3D View / Tool Shelf / Tools / Dyntopo / Set Detail Size	Shift D
Radial Control	Sets the brush radius	3D View / Tool Shelf / Tools / Brush / Radial Control	F
Radial Control	Sets the brush radius with a value in the middle	3D View / Tool Shelf / Tools / Brush / Radial Control	Shift F
Radial Control	Sets the brush direction. Useful for painting with maps. Like for scales.	3D View / Tool Shelf / Tools / Brush / Radial Control	Ctrl F
Stencil Brush Control	Brush Mode Stencil.	3D View / Tool Shelf / Tools / Texture - shows with Brush mapping Stencil	Alt Right Mouse
Stencil Brush Control	Brush Mode Stencil.	3D View / Tool Shelf / Tools / Texture - shows with Brush mapping Stencil	Shift Right Mouse
Stencil Brush Control	Brush Mode Stencil.	3D View / Tool Shelf / Tools / Texture - shows with Brush mapping Stencil	Ctrl Right Mouse
Stencil Brush Control	Brush Mode Stencil.	3D View / Tool Shelf / Tools / Texture - shows with Brush mapping Stencil	Shift Ctrl Alt Right Mouse
Stencil Brush Control	Brush Mode Stencil.	3D View / Tool Shelf / Tools / Texture - shows with Brush mapping Stencil	Shift Alt Right Mouse
Stencil Brush Control	Brush Mode Stencil.	3D View / Tool Shelf / Texture - shows with Brush mapping Stencil	Ctrl Alt Right Mouse
Sculpt Context Menu	calls a menu under the mouse	None	Right Mouse Click
Set Tool by Name	builtin.move	Tool Shelf	W
Set Tool by Name	builtin.rotate	Tool Shelf	E
Set Tool by Name	builtin.scale	Tool Shelf	R
Face Sets Edit	calls a pie menu to set the face sets	None	Alt W
Mask Expand	Expand a Face Mask	None	Shift W
Edit Voxel Size		None	Shift R
Mask Expand	Expand mask by topology	Mask menu	Shift A
Mask Expand	Expand mask by curvature	Mask menu	Shift Alt A
Transfer Mode	Switch to another object without leaving the mode	Sculpt menu	D

3D View - Weight Paint - 3D View Tool : Sculpt, Box Mask			
Name	Function	Surface menu location	Hotkey
Box Select		Tool shelf	Tweak Left Any

3D View - Weight Paint - 3D View Tool : Sculpt, Box Mask

Box Select		Tool shelf	Tweak Left Any
------------	--	------------	----------------

3D View - Weight Paint - 3D View Tool : Sculpt, Lasso Mask

Name	Function	Surface menu location	Hotkey
Mask Lasso Gesture		Tool shelf	Tweak Left Any
Mask Lasso Gesture		Tool shelf	Tweak Left Any

3D View - Weight Paint - 3D View Tool : Sculpt, Box Hide

Name	Function	Surface menu location	Hotkey
Hide/Show		Tool shelf	Tweak Left Any
Hide/Show		Tool shelf	Tweak Left Any
Hide/Show		Tool shelf	Left Mouse

3D View - Weight Paint - 3D View Tool : Sculpt, Mesh Filter

Name	Function	Surface menu location	Hotkey
Filter Mesh		Tool shelf	Tweak Left Any

3D View - Weight Paint - 3D View Tool : Sculpt, Cloth Filter

Name	Function	Surface menu location	Hotkey
Filter Cloth		Tool shelf	Tweak Left Any

3D View - Weight Paint - 3D View Tool : Move

Name	Function	Surface menu location	Hotkey
Move		Tool shelf	Tweak Left Any

3D View - Weight Paint - 3D View Tool : Rotate

Name	Function	Surface menu location	Hotkey
Rotate		Tool shelf	Tweak Left Any

3D View - Weight Paint - 3D View Tool : Scale

Name	Function	Surface menu location	Hotkey
Resize		Tool shelf	Tweak Left Any

3D View - Weight Paint - 3D View Tool : Transform

Name	Function	Surface menu location	Hotkey
Transform from Gizmo		Tool shelf	Tweak Left Any

3D View - Sculpt Curves**3D View - Sculpt Curves**

User Preferences location	Function	Surface menu location	Hotkey
Stroke Curves Sculpt	Regluar sculpt	None	Left Mouse

3D View - Sculpt Curves			
Stroke Curves Sculpt	Invert sculpt	None	Ctrl Left Mouse
Stroke Curves Sculpt	Smooth strokes	None	Shift Left Mouse
Radial Control	Set Strength of the selection brush	None	X
Radial Control	Set Radius of the selection brush	None	C
(De)select all	Selects all.	3D View / Select / (De)select all	A
Select None	Deselects all	3D View / Select / (De)select all	Alt A
Select Inverse	Inverts the selection	3D View / Select / Inverse	Ctrl I
(De)select all	Deselects all	None	dbl A
Edit Minimum Distanace	Edit the minimum distance	None	Shift R
Select Grow	Grow selection	Select menu	Shift A
Set Select Mode	Set selection mode to control point	Header	Alt 1
Set Select Mode	Set selection mode to curve	Header	Alt 2

3D View - Particle

3D View - Particle - Particle (Global)			
User Preferences location	Function	Surface menu location	Hotkey
(De)select all	Selects all.	3D View / Select / (De)select all	A
Select None	Deselects all	3D View / Select / (De)select all	Alt A
Select Inverse	Inverts the selection	3D View / Select / Inverse	Ctrl I
(De)select all	Deselects all	None	dbl A
Select More	Select more	3D View / Select / Select More	Ctrl Numpad +
Select Less	Select less	3D View / Select / Select Less	Ctrl Numpad -
Select Linked All	Select Linked, in particle mode with Hair	3D View / Select / Select linked	L
Select Linked All	Select Linked, in particle mode with Hair	3D View / Select / Deselect linked	Shift L
Delete	Delete	Delete	Delete
Hide/Show	Show All	Show/Hide / Show All	Alt H
Hide/Show	Hide Selected	Show/Hide / Hide Selected	H
3D Manipulator	Painting with the brush	None	Left Mouse
Brush Edit	Painting with the brush	None	Left Mouse
Brush Edit	Painting with the brush	None	Shift Left Mouse
Radial Control	Sets the brush radius	3D View / Sidebar / Tools / Brush / Radial Control Size	F
Radial Control	Sets the brush strength	3D View / Sidebar / Tools / Brush / Radial Control Strength	Shift F
Hide/Show	Hide Unselected	Show/Hide / Show Hidden	Shift H

3D View - Particle - 3D View Tool : Tweak			
Name	Function	Surface menu location	Hotkey
Select	Select	Tool shelf	Left Mouse
Select	Invert selection	Tool shelf	Shift Left Mouse

3D View - Particle - 3D View Tool : Select Box

Name	Function	Surface menu location	Hotkey
Box Select	Select	Tool shelf	Tweak Left Any
Box Select	Add to selection	Tool shelf	Shift Tweak Left Any
Box Select	Subtract from selection	Tool shelf	Ctrl Tweak Left Any
Box Select	Intersect selection	Tool shelf	Shift Ctrl Tweak Left Any

3D View - Particle - 3D View Tool : Select Circle

Name	Function	Surface menu location	Hotkey
Circle Select	Select	Tool shelf	Left Mouse
Circle Select	Add to selection	Tool shelf	Shift Left Mouse
Circle Select	Subtract from selection	Tool shelf	Ctrl Left Mouse

3D View - Particle - 3D View Tool : Select Lasso

Name	Function	Surface menu location	Hotkey
Lasso Select	Select	Tool shelf	Tweak Left Any
Lasso Select	Add to selection	Tool shelf	Shift Tweak Left Any
Lasso Select	Subtract from selection	Tool shelf	Ctrl Tweak Left Any
Lasso Select	Intersect selection	Tool shelf	Shift Ctrl Tweak Left Any

3D View - Particle - 3D View Tool : Cursor

Name	Function	Surface menu location	Hotkey
Set 3D Cursor		Tool shelf	Left Mouse
Move		Tool shelf	Tweak Left Any

3D View - Knife Tool Modal Map

Name	Function	Surface menu location	Hotkey
Cancel	Cancel	None	Esc
Panning	Panning	None	Middle Mouse
Add Cut Closed		None	Dbl-Left Mouse
Add Cut	Add Cut	None	Left Mouse
Cancel	Cancel	None	Right Mouse
Confirm	Confirm	None	Return
Confirm	Confirm	None	Numpad Enter
Confirm	Confirm	None	Spacebar
End current cut	End current cut	None	E
Snap to Midpoints On	Snap to Midpoints On	None	Left Ctrl
Snap to Midpoints Off	Snap to Midpoints Off	None	Left Ctrl
Snap to Midpoints On	Snap to Midpoints On	None	Right Ctrl
Snap to Midpoints Off	Snap to Midpoints Off	None	Right Ctrl
Ignore Snapping On	Ignore Snapping On	None	Left Shift
Ignore Snapping Off	Ignore Snapping Off	None	Left Shift
Ignore Snapping On	Ignore Snapping On	None	Right Shift

3D View - Knife Tool Modal Map

Ignore Snapping Off	Ignore Snapping Off	None	Right Shift
Toggle Angle Snapping	Toggle Angle Snapping	None	C
Toggle Cut Through	Toggle Cut Through	None	Z

3D View - Custom Normals Modal Map

Name	Function	Surface menu location	Hotkey
Cancel	Cancel	None	Esc
Cancel	Cancel	None	Right Mouse
Confirm	Confirm	None	Return
Confirm	Confirm	None	Numpad Enter
Confirm	Confirm	None	Left Mouse
Reset	Reset	None	R
Invert	Invert	None	I
Spherize	Spherize	None	S
Align	Align	None	A
Use Mouse	Use Mouse	None	M
Use Pivot	Use Pivot	None	L
Use Object	Use Object	None	O
Set and Use 3D Cursor	Set and Use 3D Cursor	None	Ctrl Left Mouse
Select and Use Mesh Item	Select and Use Mesh Item	None	Ctrl Right Mouse

3D View - Bevel Modal Map

Name	Function	Surface menu location	Hotkey
Cancel	Cancel	None	Esc
Cancel	Cancel	None	Right Mouse
Confirm	Confirm	None	Return
Confirm	Confirm	None	Numpad Enter
Confirm	Confirm	None	Left Mouse
Change Offset		None	A
Change Profile		None	P
Change Segment		None	S
Increase Segments		None	Wheel Up
Increase Segments		None	Numpad +
Decrease Segments		None	Wheel Down
Decrease Segments		None	Numpad -
Change Offset Mode		None	M
Toggle Clamp Overlap		None	C
Toggle Vertex Only		None	V
Toggle harden normals		None	H
Toggle mark seam		None	U
Toggle mark sharp		None	K

3D View - Bevel Modal Map

Change outer miter		None	O
Change inner miter		None	I
Toggle custom profile		None	Z
Change intersection method		None	N

3D View - Paint Stroke Modal

Name	Function	Surface menu location	Hotkey
Paint Stroke Modal	End paint stroke	None	Esc

3D View - Paint Curve

Name	Function	Surface menu location	Hotkey
Add Curve Point and Slide	Add Curve Point and Slide	None	Ctrl Left Mouse
Select Paint Curve Point	Select Paint Curve Point	None	Left Mouse
Select Paint Curve Point	Select Paint Curve Point	None	Shift Left Mouse
Slide Paint Curve Point	Slide Paint Curve Point	None	Right Mouse
Slide Paint Curve Point	Slide Paint Curve Point	None	Shift Right Mouse
Select Paint Curve Point	Select Paint Curve Point	???	A
Place Cursor	Place Cursor	None	Right Mouse
Remove Paint Curve Point	Remove Paint Curve Point	None	Delete
Draw Curve	Draw Curve	None	Return
Draw Curve	Draw Curve	None	Numpad Enter
Translate	Translate	3D View / Navi / Translate	W
Translate	Translate	None	
Rotate	Rotate	3D View / Navi / Rotate	E
Resize	Resize	3D View / Navi / Resize	R

3D View - Object Non Modal

Name	Function	Surface menu location	Hotkey
Set Object Mode	Object Mode	3D View / Drop down Box in menu bar	1
Set Object Mode	Edit Mode	3D View / Drop down Box in menu bar	2
Set Object Mode	Sculpt Mode - mesh	3D View / Drop down Box in menu bar	3
Set Object Mode	Vertex Paint	3D View / Drop down Box in menu bar	4
Set Object Mode	Weight Paint	3D View / Drop down Box in menu bar	5
Set Object Mode	Texture Paint	3D View / Drop down Box in menu bar	6
Set Object Mode	Pose Mode	3D View / Drop down Box in menu bar	Shift 2

3D View - Object Non Modal			
Set Object Mode for Grease Pencil object	Edit Mode	3D View / Drop down Box in menu bar	2
Set Object Mode for Grease Pencil object	Sculpt Mode - grease pencil	3D View / Drop down Box in menu bar	3
Set Object Mode for Grease Pencil object	Draw Mode	3D View / Drop down Box in menu bar	Shift 2
Set Object Mode for Grease Pencil object	Vertex Paint	3D View / Drop down Box in menu bar	4
Set Object Mode for Grease Pencil object	Weight Paint	3D View / Drop down Box in menu bar	5
Set Object Mode for Grease Pencil object	Sculpt Mode - Empty Hair	3D View / Drop down Box in menu bar	3
Call Pie menu	Calls the modes pie menu	View / Pie menus	Ctrl Tab

3D View - View 3D Walk Modal			
Name	Function	Surface menu location	Hotkey
Cancel	Cancel	None	Right Mouse
Cancel	Cancel	None	Esc
Confirm	Confirm	None	Left Mouse
Confirm	Confirm	None	Return
Confirm	Confirm	None	Numpad Enter
Fast	Fast Enable	None	Left Shift
Fast (Off)	Fast Disable	None	Left Shift
Slow	Slow Enable	None	Left Alt
Slow (Off)	Slow Disable	None	Left Alt
Forward	Move Forward	None	W
Backward	Move Backward	None	S
Left (Strafe)	Move Left (Strafe)	None	A
Right (Strafe)	Move Right (Strafe)	None	D
Up	Move Up	None	E
Down	Move Down	None	Q
Stop Move Forward	Stop Move Forward	None	W
Stop Move Backward	Stop Move Backward	None	S
Stop Move Left (Strafe)	Stop Move Left (Strafe)	None	A
Stop Move Right (Strafe)	Stop Move Right (Strafe)	None	D
Stop Move Up	Stop Move Up	None	E
Stop Move Down	Stop Move Down	None	Q
Forward	Move Forward	None	Up Arrow
Backward	Move Backward	None	Down Arrow
Left (Strafe)	Move Left (Strafe)	None	Left Arrow
Right (Strafe)	Move Right (Strafe)	None	Right Arrow
Stop Move Forward	Stop Move Forward	None	Up Arrow
Stop Move Backward	Stop Move Backward	None	Down Arrow
Stop Move Left (Strafe)	Stop Move Left (Strafe)	None	Any Left Arrow
Stop Move Right (Strafe)	Stop Move Right (Strafe)	None	Any Right Arrow

3D View - View 3D Walk Modal			
Toggle Gravity	Toggle Gravity	None	Tab
Toggle Gravity	Toggle Gravity	None	G
Jump	Jump	None	V
Jump (Off)	Jump Stop	None	V
Teleport	Teleport	None	Spacebar
Teleport	Teleport	None	Middle Mouse
Accelerate	Accelerate	None	Numpad +
Decelerate	Decelerate	None	Numpad -
Accelerate	Accelerate	None	Wheel Up
Decelerate	Decelerate	None	Wheel Down

3D View - View 3D Fly Modal			
Name	Function	Surface menu location	Hotkey
Cancel	Cancel	None	Right Mouse
Cancel	Cancel	None	Esc
Confirm	Confirm	None	Left Mouse
Confirm	Confirm	None	Return
Confirm	Confirm	None	Spacebar
Confirm	Confirm	None	Numpad Enter
Accelerate	Accelerate	None	Numpad +
Decelerate	Decelerate	None	Numpad -
Accelerate	Accelerate	None	Wheel Up
Decelerate	Decelerate	None	Wheel Down
Confirm	Confirm	None	Mouse/Trackpad Pan
Pan	Pan Enable	None	Middle Mouse
Pan (Off)	Pan Disable	None	Middle Mouse
Forward	Fly Forward	None	W
Backward	Fly Backward	None	S
Left	Fly Left	None	A
Right	Fly Right	None	D
Up	Fly Up	None	E
Down	Fly Down	None	Q
Up	Fly Up	None	R
Down	Fly Down	None	F
Forward	Fly Forward	None	Up Arrow
Backward	Fly Backward	None	Down Arrow
Left	Fly Left	None	Left Arrow
Right	Fly Right	None	Right Arrow
X Axis Correction	X Axis Correction	None	X
X Axis Correction	X Axis Correction	None	Z
Precision	Precision Enable	None	Left Alt
Precision (Off)	Precision Disable	None	Left Alt
Precision	Precision Enable	None	Left Shift

3D View - View 3D Fly Modal

Precision (Off)	Precision Disable	None	Left Shift
Rotation	Rotation Enable	None	Left Ctrl
Rotation (Off)	Rotation Disable	None	Left Ctrl

3D View - View 3D Rotate Modal

Name	Function	Surface menu location	Hotkey
Confirm	Confirm	None	Middle Mouse
Confirm	Confirm	None	Esc
Axis Snap	Enable Axis Snap	None	Left Alt
Axis Snap (Off)	Disable Axis Snap	None	Left Alt

3D View - View 3D Move Modal

Name	Function	Surface menu location	Hotkey
Confirm	Confirm	None	Middle Mouse
Confirm	Confirm	None	Esc

3D View - View 3D Zoom Modal

Name	Function	Surface menu location	Hotkey
Confirm	Confirm	None	Middle Mouse
Confirm	Confirm	None	Esc

3D View - View 3D Dolly Modal

Name	Function	Surface menu location	Hotkey
Confirm	Confirm	None	Middle Mouse
Confirm	Confirm	None	Esc

3D View - 3D View Generic

Name	Function	Surface menu location	Hotkey
Toggle Sidebar	Calls or hides the Properties sidebar	3D View / View / Toggle Sidebar	Ctrl T
Tool Shelf	Calls or hides the Tool Shelf sidebar	3D View / View / Tool Shelf	T

Graph Editor**Graph Editor / Graph Editor (Global)**

Name	Function	Surface menu location	Hotkey
------	----------	-----------------------	--------

Graph Editor / Graph Editor (Global)			
Set Cursor	Set Cursor	None	Right Mouse
Select Keyframes	Select Keyframes	None	Left Mouse
Select Keyframes	Select Keyframes	None	Alt Left Mouse
Select Keyframes	Select Keyframes	None	Shift Left Mouse
Select Keyframes	Select Keyframes	None	Shift Alt Left Mouse
Select Keyframes	Select Keyframes	None	Ctrl Alt Left Mouse
Select Keyframes	Select Keyframes	None	Shift Ctrl Alt Left Mouse
Select Left/Right	Select Left/Right	None	Ctrl Left Mouse
Select Left/Right	Select Left/Right	None	Shift Ctrl Left Mouse
(De)select all	Select All	Graph Editor / Select /	A
Select None	Deselect All	Graph Editor / Select /	Alt A
Select Inverse	Invert Selection	Graph Editor / Select /	Ctrl I
(De)select all	Deselect all	Graph Editor / Select /	dbl A
Box Select	Box Select	Graph Editor / Select / Border Select	B
Lasso Select	Lasso Select	None	
Lasso Select	Lasso Select	None	
Circle Select	Circle Select	Graph Editor / Select / Circle Select	G
Select More	Select More	Graph Editor / Select / Select More	Ctrl Numpad +
Select Less	Select Less	Graph Editor / Select / Select Less	Ctrl Numpad -
Duplicate	Duplicate	Graph Editor / Key / Duplicate	Shift D
Click-Insert Keyframes	Insert Keyframes	None	Ctrl Right Mouse
Click-Insert Keyframes	Insert Keyframes	None	Shift Ctrl Right Mouse
Copy Keyframes	Copy Keyframes	Graph Editor / Key / Copy Keyframes	Ctrl C
Paste Keyframes / Flipped	Paste Keyframes	Graph Editor / Key / Paste Keyframes	Ctrl V
Paste Keyframes / Flipped	Paste Keyframes flipped	Graph Editor / Key / Paste Flipped	Shift Ctrl V
Auto Set Keyframe Range		View menu	Ctrl Alt P
Frame All	View All	Graph Editor / View / View All	Home
Frame All	View All. N dof device for 3dConnexion		NDOF Fit
Frame Selected	View Frame	Graph Editor / View / View Frame	Numpad 0
Go to Current Frame			Numpad .
Move	Translate	Graph Editor / Key / Transform /	W
Move			Tweak Left Any
Transform		Graph Editor / Key / Transform /	S
Rotate	Rotate	Graph Editor / Key / Transform /	E
Resize	Resize	Graph Editor / Key / Transform /	R
Delete Keyframes	Delete Keyframes	Graph Editor / Key / Delete Keyframes	Delete
Insert Keyframes		Graph Editor / Key /	I
F-Curve Context Menu	calls the right mouse menu under the mouse	None	Right Mouse Click

Graph Editor / Graph Editor Generic			
Name	Function	Surface menu location	Hotkey
Context Toggle	Opens /closes the Properties sidebar	Graph Editor / View / Properties	Ctrl T
Hide Curves	Hide selected curve	Graph Editor / Channel / Hide selected curve	H
Hide Curves	Hide unselected curves	Graph Editor / Channel / Hide unselected curves	Shift H
Reveal Curves	Show all curves	Graph Editor / Channel / Show all curves	Alt H

Dope sheet

Dope sheet (Global)			
User Preferences location	Function	Surface menu location	Hotkey
Select Keyframes	Mouse Select Keys	None	Left Mouse
Select Keyframes	Mouse Select Keys	None	Alt Left Mouse
Select Keyframes	Mouse Select Keys	None	Shift Left Mouse
Select Keyframes	Mouse Select Keys	None	Shift Alt Left Mouse
Select Keyframes	Mouse Select Keys	None	Ctrl Alt Left Mouse
Select Keyframes	Mouse Select Keys	None	Shift Ctrl Alt Left Mouse
Select Left/Right	Select Left/Right	None	Ctrl Left Mouse
Select Left/Right	Select Left/Right	None	Shift Ctrl Left Mouse
Select All	Select All	Dope Sheet / Select / Select All	A
Select None	Select Nothing	Dope Sheet / Select /	Alt A
Select Inverse	Inverts Selection	Dope Sheet / Select / Invert Selection	Ctrl I
Select All		None	dbl A
Box Select	Border Select	Dope Sheet / Select / Border Select	B
Lasso Select	Lasso Select	None	Tweak Left Any
Lasso Select	Lasso Select	None	Tweak Left Any
Circle Select	Circle Select	Dope Sheet / Select / Circle Select	G
Select More	Select more	Dope Sheet / Select / Select More	Ctrl Numpad +
Select Less	Select less	Dope Sheet / Select / Select Less	Ctrl Numpad -
Duplicate	Duplicate	Key menu	Shift D
Copy Keyframes	Copy Keyframes	Dope Sheet / Key / Copy Keyframes	Ctrl C
Paste Keyframes /Flipped	Paste Keyframes	Dope Sheet / Key / Paste Keyframes	Ctrl V
Paste Keyframes /Flipped	Paste Keyframes flipped	Key menu	Shift Ctrl V
Auto-Set Preview Range			Ctrl Alt P
Frame All	View All	Dope Sheet / View / View All	Home
Frame All	View All. N dof device for 3dConnexion	None	NDOF Fit
Frame Selected	View Frame	Dope Sheet / View / View Frame	Numpad 0

Dope sheet (Global)			
Go to current frame	View Selected	Dope Sheet / View / View Selected	Numpad ,
Find Channel	Calls a Find Channels panel	Dope Sheet / Channel / Find Channel	Ctrl F
Transform	Grab / Move	Dope Sheet / Key / Transform	W
Transform			Tweak Left Any
Transform	Extend	Dope Sheet / Key / Transform	E
Transform	Scale	Dope Sheet / Key / Transform	R
Transform	Slide	Dope Sheet / Key / Transform	Shift T
Delete Keyframes	Delete Keyframes	Dope Sheet / Key / Delete Keyframes	Delete
Insert Keyframes		Dope Sheet / Key /	I
Dope Sheet Context Menu	calls a menu under the mouse	None	Right Mouse Click

Dope sheet Generic

Dope sheet Generic			
Name	Function	Surface menu location	Hotkey
Context Toggle	Opens / closes the Sidebar	Dope sheet Generic / Properties	Ctrl T

NLA Editor

NLA Editor / NLA Editor (Global)			
Name	Function		Hotkey
Select		None	Left Mouse
Select		None	Shift Left Mouse
Select Left/Right		None	Ctrl Left Mouse
Select Left/Right		None	Shift Ctrl Left Mouse
(De)select all	Select All	Select / Select All	A
Select None	Select Nothing	Select / S	Alt A
Select Inverse	Inverts Selection	Select / Invert Selection	Ctrl I
(De)select all		None	dbl A
Box Select	Box Select	NLA / Select / Border Select	B
Auto Set Preview Range		NLA / View menu	Ctrl Alt P
Frame All	View All	NLA / View / View All	Home
Frame All	View All. N dof device for 3dConnexion	None	NDOF Fit
Frame Selected		View /	Numpad 0
Go to current frame			Numpad ,
Duplicate Strips	Duplicate Strips	NLA / Edit menu	Shift D
Duplicate Strips	Duplicate Linked Strips	NLA / Edit menu	Alt D
Delete Strips	Delete Strips	NLA / Edit / Delete Strips	Delete

NLA Editor / NLA Editor (Global)			
Move Strips up	Move Strips up	NLA / Edit / Move Strips up	Page Up
Move Strips down	Move Strips down	NLA / Edit / Move Strips down	Page Down
Add F Modifier	calls Add F Modifier menu	None	Shift Ctrl M
Transform	Transform / Move	NLA / Edit / Transform / Grab/Move	W
/Transform	Transform	None	Tweak Left Any
/Transform	Extend	NLA / Edit / Transform /	E
Transform	Scale	NLA / Edit / Transform / Scale	R
Add Time Marker		NLA / Marker menu	M
Rename Marker		NLA / Marker menu	Ctrl M
NLA Context Menu	calls the right mouse menu under the mouse	None	Right Mouse Click
Add Action Strip	Adds an action strip when pressed over the channels	NLA Editor / Add	Shift A

NLA Editor / NLA Channels			
Name	Function	Surface menu location	Hotkey
NLA Editor / NLA Channels / Mouse Click on NLA Channels	Mouse Click on NLA Channels	None	Left Mouse
NLA Editor / NLA Channels / Mouse Click on NLA Channels	Mouse Click on NLA Channels	None	Shift Left Mouse
NLA Editor / NLA Channels / Delete	Delete	NLA Editor / Edit / Delete Strips	Delete
NLA Channel Context Menu	calls the right mouse menu under the mouse	None	Right Mouse Click
Add Tracks	Adds a number of tracks based on selection count	NLA Editor / Add	Shift A
Add Tracks (Above Selected)	Adds a number of tracks based on selection count	NLA Editor / Add	Shift Ctrl A

NLA Editor / NLA Generic			
Name	Function	Surface menu location	Hotkey
Context Toggle	Opens/ Closes the Properties Sidebar	NLA Editor / View / Properties	Ctrl T
Enter Tweak Mode	Exit Tweak Mode.	NLA Editor / Edit / Stop tweaking Strip Actions	Tab
Exit Tweak Mode	Enter Tweak Mode.	NLA Editor / Edit / Start tweaking Strip Actions	Tab
Enter Tweak Mode	Exit Tweak Mode. Isolate Action	NLA Editor / Edit / Stop tweaking Stashed Action	Shift Tab
Exit Tweak Mode	Enter Tweak Mode. Isolate Action	NLA Editor / Edit / Start tweaking Stashed Action	Shift Tab

Image

Image / Image (Global)			
Name	Function	Surface menu location	Hotkey
Frame All	View All	Image Editor / View / View All	Home
Frame All	View All	None	Shift Home
View Center	View Center	Image Editor / View / View Center	Numpad 0
Pan View	View Pan	None	Middle Mouse
Pan View	View Pan	None	Shift Middle Mouse
Pan View	View Pan	None	Mouse/Trackpad Pan
Frame all	View All. N dof device for 3dConnexion	None	NDOF Fit
NDOF Pan/Zoom	NDOF Pan/Zoom. N dof device for 3dConnexion	None	NDOF Motion
Zoom in	View Zoom In	Image Editor / View / View Zoom In	Wheel In
Zoom Out	View Zoom Out	Image Editor / View / View Zoom Out	Wheel Out
Zoom in	View Zoom in	None	Numpad +
Zoom Out	View Zoom Out	None	Numpad -
Zoom View	View Zoom	None	Ctrl Middle Mouse
Zoom View	View Zoom	None	Mouse/Trackpad Zoom
Zoom View	View Zoom	None	Ctrl Mouse/Trackpad Pan
Zoom Border		View /	Shift B
Change Frame	Change Frame.	None	Left Mouse
Sample Color	Sample Color.	None	Right Mouse
Set Curves Point	Set Black point in color management curves panel. Image must be set to View as Render.	None	Ctrl Left Mouse
Set Curves Point	Set White point in color management curves panel. Image must be set to View as Render.	None	Shift Left Mouse
Render Region	define a render area by dragging a rectangle	View / Render Region	Ctrl B
Clear Render Region	removes the render border	View / Clear Render Region	Ctrl Alt B
Call Menu	Calls the Mask Context menu		dbl Right Mouse
Context Toggle - Widgets	Toggles the gizmos in the Image Editor	Header	Shift + Tab
Context Toggle - Overlays	Toggles the overlays in the Image Editor	Header	Tab

Image / UV Editor / UV Editor (Global)			
Name	Function	Surface menu location	Hotkey
Select Mode	Select mode with UV sync on		X
Select Mode	Select mode with UV sync on	Header	C
Select Mode	Select mode with UV sync on	Header	V
Select Mode	???		4
Context Set Enum	Select mode with UV sync off	Header	1
Context Set Enum	Select mode with UV sync off	Header	2
Context Set Enum	Select mode with UV sync off	Header	3

Image / UV Editor / UV Editor (Global)			
Context Set Enum	Select mode with UV sync off	Header	4
Select	Select	None	Left Mouse
Select	Select	None	Shift Left Mouse
Loop Select	Loop Select. No menu item possible, works with mouse position	None	Alt Left Mouse
Loop Select	Loop Select. No menu item possible, works with mouse position	None	Shift Alt Left Mouse
Lasso Select UV	Lasso Select	None	Tweak Right Any
Lasso Select UV	Lasso Select	None	Tweak Right Any
Select Linked Pick	Select Linked Pick	Image Editor / Select / Linked Pick	L
Select More	Select More	Image Editor / Select / More	Ctrl Numpad +
Select Less	Select Less	Image Editor / Select / Less	Ctrl Numpad -
(De)select all	Select All	Select / Select All	A
Select None	Select Nothing	Select /	Alt A
Select Inverse	Inverts Selection	Select / Invert Selection	Ctrl I
(De)select all		None	dbl A
Unwrap		None	U
Hide selection	Hide selected Object	Image Editor / UV's / Show/Hide Faces / Hide Selected	H
Hide selection	Hide unselected Object(s)	Image Editor / UV's / Show/Hide Faces / Hide Unselected	Shift H
Reveal Hidden	Show hidden Objects	Image Editor / UV's / Show/Hide Faces / Reveal Hidden	Alt H
Move	Translate	None	Tweak Left Any
Set 2D cursor	Sets the 2d cursor to mouse position	None	Alt Right Mouse
Move 2D cursor	Moves the 2D cursor	None	Shift Tweak Right Any
Mark Seam	Marks the selected edge(s) as seam for unwrapping with ABF or LSCM	UV Menu	M
Clear Seam	Clears the seam at the selected edge(s)	UV Menu	N
Call Menu	Calls the UV context menu	None	dbl Right Mouse
Set Tool By Name	builtin.move	Tool Shelf	W
Set Tool By Name	builtin.rotate	Tool Shelf	E
Set Tool By Name	builtin.scale	Tool Shelf	R
Set Tool By Name	builtin.select	Tool Shelf	D
Set Tool By Name	builtin.select_box	Tool Shelf	B
Set Tool By Name	builtin.select_circle	Tool Shelf	G
Pick shortest path	Pick shortest path	None	Ctrl Left Mouse
Pick shortest path	Pick shortest path with Fill Region	None	Shift Ctrl Left Mouse
Edge Ring Select	Select Edge Ring		Ctrl Alt Left Mouse
Edge Ring Select	Select Edge Ring with add to selection		Shift Ctrl Alt Left Mouse

Image / UV Editor / Image Editor Tool: UV, Tweak

Name	Function	Surface menu location	Hotkey
Select	Tweak Select	None	Left Mouse
Select	Tweak Select	None	Shift Left Mouse

Image / UV Editor / Image Editor Tool: UV, Select Box

Name	Function	Surface menu location	Hotkey
Box Select	Box Select	None	Tweak Left Any
Box Select	Box Select	None	Tweak Left Any
Box Select	Box Select	None	Tweak Left Any

Image / UV Editor / Image Editor Tool: UV, Select Circle

Name	Function	Surface menu location	Hotkey
Circle Select	Circle Select	None	Left Mouse
Circle Select	Circle Select	None	Shift Left Mouse
Circle Select	Circle Select	None	Ctrl Left Mouse

Image / UV Editor / Image Editor Tool: UV, Select Lasso

Name	Function	Surface menu location	Hotkey
Lasso Select	Box Select	None	Tweak Left Any
Lasso Select	Box Select	None	Tweak Left Any
Lasso Select	Box Select	None	Tweak Left Any

Image / UV Editor / Image Editor Tool: UV, Cursor

Name	Function	Surface menu location	Hotkey
Set 2D Cursor	Set 2D Cursor	None	Left Mouse
Move	Set 2D Cursor	None	Tweak Left Any

Image / UV Editor / Image Editor Tool: UV, Move

Name	Function	Surface menu location	Hotkey
Move	Move	None	Tweak Left Any

Image / UV Editor / Image Editor Tool: UV, Rotate

Name	Function	Surface menu location	Hotkey
Rotate	Rotate	None	Tweak Left Any

Image / UV Editor / Image Editor Tool: UV, Scale			
Name	Function	Surface menu location	Hotkey
Scale	Scale	None	Tweak Left Any

Image / Image Paint			
Name	Function	Surface menu location	Hotkey
Image Paint	Image Paint	None	Left Mouse
Image Paint	Image Paint	None	Ctrl Left Mouse
Swap colors	Toggles the current color	Image Editor / Sidebar / Tool / Brush , in the color picker	X
Sample Color	Sample Color	Image Editor / Sidebar / Paint	S
Stencil Brush control	Stencil Brush control	Image Editor / Sidebar / Texture Mask with Mask Mapping Stencil	Alt Right Mouse
Stencil Brush control	Stencil Brush control	Image Editor / Sidebar / Texture Mask with Mask Mapping Stencil	Shift Right Mouse
Stencil Brush control	Stencil Brush control	Image Editor / Sidebar / Texture Mask with Mask Mapping Stencil	Ctrl Right Mouse
Stencil Brush control	Stencil Brush control	Image Editor / Sidebar / Texture Mask with Mask Mapping Stencil	Shift Ctrl Alt Right Mouse
Stencil Brush control	Stencil Brush control	Image Editor / Sidebar / Texture Mask with Mask Mapping Stencil	Shift Alt Right Mouse
Stencil Brush control	Stencil Brush control	Image Editor / Sidebar / Texture Mask with Mask Mapping Stencil	Ctrl Alt Right Mouse
Radial Control	Radial Control	Image Editor / Brush /	F
Radial Control	Radial Control	Image Editor / Brush /	Shift F
Radial Control	Radial Control	Image Editor / Brush /	Ctrl F
Radial Control	Radial Control	Image Editor / Brush /	Ctrl Alt F
Texture Paint Context Menu	calls a menu under the mouse	None	Right Mouse Click
Grab Clone	Move the stencil image for the Clone tool in Paint mode	None	Right Mouse
Set Tool by Name	builtin.select_box	Tool Shelf	B
Set Tool by Name	builtin.select_circle	Tool Shelf	G
Set Tool by Name	builtin.select	Tool Shelf	D

Image / Image generic			
Name	Function	Surface menu location	Hotkey
New Image	New Image	Image /	Alt N
Open Image	Open Image	Image /	Alt O
Reload Image		Image /	Alt R
Save Image	Save Image	Image /	Alt S
Save as Image	Save as Image	Image /	Shift S
Context Toggle	Displays the sidebar	View /	Ctrl T
Context Toggle	Displays the Tool Shelf	View /	T

Outliner

Outliner			
	Function	Surface menu location	Hotkey
Update Highlight		None	Mouse Move
Rename	Rename Item	None	double-Left Mouse
Select	Activate Item	None	Left Mouse
Select	Activate Item	None	Shift Left Mouse
Select	Activate Item	None	Ctrl Left Mouse
Select	Activate Item	None	Shift Ctrl Left Mouse
Box Select	Border Select	View Menu	B
Box Select	Border Select		Tweak Left Any
Box Select	Border Select		Tweak Left Any
Box Select	Border Select		Tweak Left Any
Walk Select	Arrow navigation in the outliner	None	Up Arrow
Walk Select	Arrow navigation in the outliner - extend	None	Shift Up Arrow
Walk Select	Arrow navigation in the outliner	None	Down Arrow
Walk Select	Arrow navigation in the outliner - extend	None	Shift Down Arrow
Walk Select	Arrow navigation in the outliner	None	Left Arrow
Walk Select	Arrow navigation in the outliner - extend	None	Shift Left Arrow
Walk Select	Arrow navigation in the outliner	None	Right Arrow
Walk Select	Arrow navigation in the outliner - extend	None	Shift Right Arrow
Open/Close	Open/Close Item	None	Left Mouse
Open/Close	Open/Close Item	None	Shift Left Mouse
Open/Close		None	Tweak Left Any
Context Menu		None	Right Mouse
Drag and Drop		None	Tweak Left Any
Drag and Drop		None	Tweak Left Any
Show Hierarchy		View / Box Select	Home
Show Active		View / Box Select	.
Show Active		None	Numpad .
Scroll Page	Scroll Page	None	Page Down
Scroll Page	Scroll Page	None	Page Up
Show/ Hide One Level		None	Numpad +
Show/ Hide One Level		None	Numpad -
Toggle Selected	Select All	View / Select All	A
Toggle Selected	Select None	View / None	Alt A
Toggle Selected	Inverse Selection	View / Inverse	Ctrl I
Toggle Selected		None	dbl-A
Expand/Collapse All	Expand/Collapse All	View / Expand/Collapse All	Shift A
Keying Set Add Selected		None	K
Keying Set Remove Selected		None	Alt K

Outliner			
Insert Keyframe		None	I
Delete Keying Set Keyframe		None	Alt I
Add Drivers for Selected		Right click menu	Ctrl D
Delete Drivers for Selected		Header, at the right	Ctrl Alt D
New Collection		Header, at the right	C
Delete		Right click menu at the item	Delete
Move to Collection		M menu at the item	M
Link to Collection		Shift M menu at the item	Shift M
Hide		None	H
Unhide All		None	Alt H
Outliner ID Data Copy	Copy	None	Ctrl C
Outliner ID Data Paste	Paste	None	Ctrl V
Collection Object Select	Select all in a Collection	Collection	dbl – Shift Left Mouse
Outliner ID Data Operation	Renames the active collection or object in the outliner	Right click menu at the item, ID sub-menu	F2

Node Editor

Node Editor / Node Editor Global			
Name	Function	Surface menu location	Hotkey
Select	Select	None	Left Mouse
Select	Select	None	Ctrl Left Mouse
Select	Select	None	Alt Left Mouse
Select	Select	None	Shift Left Mouse
Select	Select	None	Shift Ctrl Left Mouse
Select	Select	None	Shift Alt Left Mouse
Select	Select	None	Ctrl Right Mouse
Select	Select	None	Shift Ctrl Alt Left Mouse
Lasso Select	Lasso Select	None	Tweak Left Any
Lasso Select	Lasso Select	None	Tweak Left Any
Link Nodes	Link Nodes	None	Tweak Left Any
Link Nodes	Link Nodes	None	Tweak Left Any
Resize Node	Resize Node	None	Tweak Left Any
Add Reroute	Add Reroute	None	Tweak Left Any
Cut Links	Cut Links	None	Tweak Left Any
Link Viewer	Link Viewer	None	Shift Ctrl Left Mouse
Background Image Move	Background Image Move	None	Alt Middle Mouse
Background Image Zoom	Background Image Zoom	Compositor / View /	V
Background Image Zoom	Background Image Zoom	Compositor / View /	Alt V
Background Image Fit	Background Image Fit	Compositor / View /	Alt Home
Back image Sample	Displays the color information of the Background Image under the current mouse position. Position, RGB Values, HSV, etc.	None	Alt Right Mouse

Node Editor / Node Editor Global			
Make Links	Make Links	Node Editor / Node /	F
Make Links	Make and replace Links	Node Editor / Node /	Shift F
Add			Shift A
Duplicate	Duplicate	Node Editor / Node / Duplicate	Shift D
Duplicate	Duplicate with keep inputs	Node Editor / Node / Duplicate Keep Input	Shift Ctrl D
Make Parent		Node menu	Ctrl P
Detach Nodes		Node Editor / Node /	Alt P
Join Nodes		Node Editor / Node /	Ctrl J
Hide	Hide	Node Editor / Node / Hide	H
Toggle Node Preview	Toggle Node Preview	Node Editor / Node / Toggle Node Preview	Shift H
Toggle Hidden Node Sockets	Toggle Hidden Node Sockets	Node Editor / Node / Toggle Hidden Node Sockets	Ctrl H
Frame All	View All	View / View All	Home
Frame All	View All. N dof device for 3dConnexion	View / View All	N dof Fit
Frame Selected	View Selected	View / View Selected	Numpad 0
Delete with reconnect		Node menu	Ctrl Delete
(De)select all	Select all	Node Editor / Select / (De)select all	A
Select none	Deselect all	Node Editor / Select /	Alt A
Select Inverse	Invert Selection	Node Editor / Select / Inverse	Ctrl I
(De)select all	Deselect all	None	dbl-A
Render changed layer		Node Editor / Node /	Z
Copy to Clipboard	Copy to Clipboard	Node Editor / Node / Copy	Ctrl C
Paste from Clipboard	Paste from Clipboard	Node Editor / Node / Paste	Ctrl V
Viewer Region		View menu	Ctrl B
Clear Viewer Border		View menu	Ctrl Alt B
Move and Attach	Move and Attach	Node Editor / Node / Translate	W
Move and Attach	Move and Attach	None	Tweak Left Any
Move and Attach	Move and Attach	None	Tweak Left Any
Move	Translate	Node Editor / Node / Move	W
Move	Translate	None	Tweak Left Any
Move	Translate	None	Tweak Left Any
Rotate	Rotate	Node Editor / Node / Rotate	E
Resize	Resize	Node Editor / Node / Resize	R
Duplicate Linked	Duplicate selected nodes	Node Editor / Node / Duplicate Linked	Alt D
Detach	Detach	None	Alt Right Mouse
Detach	Detach	None	Alt Left Mouse
Delete	Delete	Node Editor / Node / Delete	Delete
Node Context Menu	calls a menu under the mouse	None	Right Mouse Click
Set Tool by Name	builtin.select	Tool shelf	D
Set Tool by Name	builtin.select_box	Tool shelf	B
Set Tool by Name	builtin.select_circle	Tool shelf	G

Node Editor / Node Editor Global			
Edit Group	Toggles the edit of a node group	Sidebar / Relations tab / Group panel	Tab
Set Tool by Name	builtin.links_cut	Tool Shelf	K
Mute Links	Make existing links muted / unmute muted links	None, hotkey only	Ctrl Alt Right Mouse
Cut Links	Cut the links with a knife tool. Old version.	None, hotkey only	Ctrl Right Mouse

Node Editor / Generic			
Name	Function	Surface menu location	Hotkey
Context Toggle	Calls or closes the Properties panel	Node Editor / View / Properties	Ctrl T
Context Toggle	Calls or closes the Tool Shelf panel	Node Editor / View / Tool Shelf	T

SequencerCommon

SequencerCommon(Global)			
Name	Function	Surface menu location	Hotkey
Context Toggle	Calls or closes the Sidebar panel	View menu	Ctrl T
Context Toggle	Calls or closes the Tool Shelf panel	Sidebar, Viwe tab, Frame Overlay panel header	Shift O
Context Toggle values	Switches the editor under the mouse between the preview and sequencer view	None	Ctrl Tab

Sequencer

Sequencer (Global)			
User Preferences location	Function	Surface menu location	Hotkey
(De)select all	Select all	Sequencer / Select/ (De)select all	A
Select None	Deselect all	Sequencer / Select	Alt A
Select Inverse	Inverse	Sequencer / Select / Inverse	Ctrl I
(De)select all	Deselect all	None	dbl-A
Split Strips	Cut Strip	Sequencer / Strip	K
Split Strips	Cut Strip	Sequencer / Strip	Shift K
Mute Strips	Mute Strips	Sequencer / Strip / Lock/Mute	H
Mute Strips	Mute Strips	Sequencer / Strip / Lock/Mute	Shift H
Un-Mute Strips	Un-Mute Strips	Sequencer / Strip / Lock/Mute	Alt H
Un-Mute Strips	Un-Mute Strips	Sequencer / Strip / Lock/Mute	Shift Alt H
Lock Strips		Sequencer / Strip / Lock/Mute	Shift L
Unlock Strips		Sequencer / Strip / Lock/Mute	Shift Alt L
Reassign Inputs		None	R
Reload Strips		Sequencer / Strip / Inputs	Alt R

Sequencer (Global)			
Reload Strips		Sequencer / Strip / Inputs	Shift Alt R
Clear Strip Offset		Sequencer / Strip	Alt O
Duplicate Strips	Duplicate Strips	Sequencer / Strip / Duplicate Strips	Shift D
Erase Strips	Erase Strips	Sequencer / Strip / Erase Strips	Delete
Copy	Copy	Sequencer / Strip /	Ctrl C
Paste	Paste	Sequencer / Strip /	Ctrl V
Separate Images		None	Y
Toggle Meta Strips		None	Tab
Make Meta Strip		None	Ctrl G
UnMetaStrip		None	Ctrl Alt G
Frame All	View All	Sequencer / View / View All	Home
Frame All	View All . N dof device for 3dConnexion	None	NDOF Fit
Frame Selected	View Selected	Sequencer / View / View Selected	F
Go to current frame			Numpad ,
Jump to Strip	Jump to Strip	None	Page Up
Jump to Strip	Jump to Strip	None	Page Down
Jump to Strip	Jump to Strip	None	Alt Page Up
Jump to Strip	Jump to Strip	None	Alt Page Down
Swap Strip		Sequencer / Strip / Transform	Alt Left Arrow
Swap Strip		Sequencer / Strip / Transform	Alt Right Arrow
Remove Gaps		Sequencer / Strip / Transform	Backspace
Remove Gaps		Sequencer / Strip / Transform	Shift Backspace
Insert Gaps		Sequencer / Strip / Transform	Shift =
Snap Strips to the current frame		Sequencer / Strip	Shift S
Swap Inputs			Alt S
Split Multicam	Split Multicam	None	1
Split Multicam	Split Multicam	None	2
Split Multicam	Split Multicam	None	3
Split Multicam	Split Multicam	None	4
Split Multicam	Split Multicam	None	5
Split Multicam	Split Multicam	None	6
Split Multicam	Split Multicam	None	7
Split Multicam	Split Multicam	None	8
Split Multicam	Split Multicam	None	9
Split Multicam	Split Multicam	None	0
Select	Activate/Select	None	Shift Left Mouse
Select	Activate/Select	None	Alt Left Mouse
Select	Activate/Select	None	Shift Alt Left Mouse
Select	Activate/Select	None	Ctrl Left Mouse
Select	Activate/Select	None	Shift Ctrl Left Mouse
Select More	Select more	Sequencer/ Select / Select More	Ctrl Numpad +
Select Less	Select less	Sequencer / Select / Select Less	Ctrl Numpad -
Select Pick Linked	Select Pick Linked	???	L

Sequencer (Global)			
Select Pick Linked	Select Pick Linked	???	Shift L
Select Linked		Sequencer / Select	Ctrl L
Box Select	Box Select	Select menu	Ctrl B
Select Grouped		Sequencer / Select	Shift G
Call Menu		None	Shift A
Trim Strips		Strip / Transform	S
Context Set	Context Set for overlay frame	None	O
Sequence Slide	Sequence Slide. Grabs the current active clip and moves it with the mouse.	None	w
Sequence Slide	Sequence Slide	None	drag-left mouse
Transform		Strip / Transform	E
Add Time Marker		Marker /	M
Rename Marker	s	Marker /	Ctrl M
Sequencer Context Menu	calls a menu under the mouse	None	Right Mouse
Set Tool by Name	builtin.select	Tool Shelf	D
Set Tool by Name	builtin.select_box	Tool Shelf	B
Set Tool by Name	builtin.select_circle	Tool Shelf	G
Box Select	Box select set	None	drag-left mouse
Box Select	Box select extend	None	drag-left mouse
Box Select	Box select subtract	None	drag-left mouse

Sequencer Tool: Tweak			
Name	Function	Surface menu location	Hotkey
Select	Select	None	Left Mouse
Select	Select add	None	Shift Left Mouse
Change frame	Change frame	None	Shift Right Mouse

Sequencer Tool: Tweak (fallback)			
Name	Function	Surface menu location	Hotkey
Change frame	Change frame	None	Shift Right Mouse

Sequencer Tool: Select Box			
Name	Function	Surface menu location	Hotkey
Box Select	Box select set	None	Tweak Left Any
Box Select	Box select extend	None	Tweak Left Any
Box Select	Box select subtract	None	Tweak Left Any
Change frame	Change frame	None	Shift Right Mouse

Sequencer Tool: Select Box(fallback)			
Name	Function	Surface menu location	Hotkey
Box Select	Box select set	None	Tweak Left Any
Box Select	Box select extend	None	Tweak Left Any
Box Select	Box select subtract	None	Tweak Left Any

Sequencer Tool: Select Box(fallback)

Change frame	Change frame	None	Shift Right Mouse
--------------	--------------	------	-------------------

SequencerPreview**SequencerPreview (Global)**

Name	Function	Surface menu location	Hotkey
Select	Activate/Select	None	Left Mouse
Select	Activate/Select	None	Shift Left Mouse
Select	Activate/Select	None	Ctrl Left Mouse
Select	Activate/Select	None	Shift Ctrl Left Mouse
Frame All	View All	None	Home
Frame All	View All . N dof device for 3dConnexion	None	NDOF Fit
Border Offset View	Border Offset View	None	O
Sequencer View Zoom Ratio	Sequencer View Zoom Ratio	None	Ctrl Numpad 8
Sequencer View Zoom Ratio	Sequencer View Zoom Ratio	None	Ctrl Numpad 4
Sequencer View Zoom Ratio	Sequencer View Zoom Ratio	None	Ctrl Numpad 2
Sequencer View Zoom Ratio	Sequencer View Zoom Ratio	None	Numpad 1
Sequencer View Zoom Ratio	Sequencer View Zoom Ratio	None	Numpad 2
Sequencer View Zoom Ratio	Sequencer View Zoom Ratio	None	Numpad 4
Sequencer View Zoom Ratio	Sequencer View Zoom Ratio	None	Numpad 8
Move	Move	None	Tweak Left Any
Move	Move	None	W
Rotate	Rotate	None	E
Resize	Scale	None	R
Clear Strip Transform	Clear Position	None	Alt W
Clear Strip Transform	Clear Scale	None	Alt R
Clear Strip Transform	Clear Rotation	None	Alt E
Sequencer Preview Context Menu	Calls the context menu	None	Right Mouse
Sequencer Preview Context Menu	Calls the context menu	None	Application
Pivot Point	Pivot point pie menu	View menu - Pie menus	.
Context Toggle	Show Overlays	None	Shift Alt Z
Set 2D Cursor	Sets the 2d cursor	None	Alt Right Mouse
Move	Moves the 2d cursor	None	Shift drag Right mouse
Frame Selected	Centers the selected element and zooms to fit	View menu	F
Context Toggle - Widgets	Toggles the gizmos in the Sequencer Preview Editor	Header	Shift Tab
Context Toggle - Overlays	Toggles the overlays in the Sequencer Preview Editor	Header	Tab

Sequencer Tool: Tweak

Name	Function	Surface menu location	Hotkey
Select	Select	None	Left Mouse

Sequencer Tool: Tweak

Select	Select add	None	Shift Left Mouse
Change frame	Change frame	None	Shift Right Mouse

Sequencer Tool: Tweak (fallback)

Name	Function	Surface menu location	Hotkey
Change frame	Change frame	None	Shift Right Mouse

Sequencer Tool: Select Box

Name	Function	Surface menu location	Hotkey
Box Select	Box select set	None	Tweak Left Any
Box Select	Box select extend	None	Tweak Left Any
Box Select	Box select subtract	None	Tweak Left Any
Change frame	Change frame	None	Shift Right Mouse

Sequencer Tool: Select Box(fallback)

Name	Function	Surface menu location	Hotkey
Box Select	Box select set	None	Tweak Left Any
Box Select	Box select extend	None	Tweak Left Any
Box Select	Box select subtract	None	Tweak Left Any
Change frame	Change frame	None	Shift Right Mouse

Sequencer Tool: Cursor

Name	Function	Surface menu location	Hotkey
Set 2D Cursor	Sets the 2d cursor	None	Left Mouse
Move	Moves the 2d cursor	None	Tweak Left Any

Sequencer Tool: Move

Name	Function	Surface menu location	Hotkey
Move	Moves the selection	None	Tweak Left Any

Sequencer Tool: Rotate

Name	Function	Surface menu location	Hotkey
Rotate	Rotates the selection	None	Tweak Left Any

Sequencer Tool: Scale

Name	Function	Surface menu location	Hotkey
Resize	scales the selection	None	Tweak Left Any

Sequencer Tool: Sample

Name	Function	Surface menu location	Hotkey
Sample Color	Samples the color under the mouse	None	Left Mouse

File Browser

File Browser / File Browser (Global)

Name	Function	Surface menu location	Hotkey
Context Toggle	Toggles the bookmarks	File Browser / Select / Toggle Bookmarks	T
Toggle Region	Toggles the sidebar	File Browser / Select / Toggle Bookmarks	Ctrl T
Parent File	Parent File	None	Alt Up Arrow
Previous Folder	Previous Folder	None	Alt Left Arrow
Next Folder	Next Folder	None	Alt Right Arrow
Delete selected Files	Delete selected Files	None	Delete
Smooth Scroll	Smooth Scroll	None	Timer 1
Filter	Sets the focus to the search field in the header so that you can start typing immediately.	None	Ctrl F
Files Context Menu	Calls the context menu	None	Right Mouse
Increment Number in Filename	Increment Number in Filename by 1	The little + button left from the cancel button	Numpad +
Increment Number in Filename	Increment Number in Filename by 10	None	Shift Numpad +
Increment Number in Filename	Increment Number in Filename by 100	None	Ctrl Numpad +
Increment Number in Filename	Decrease Number in Filename by 1	The little - button left from the cancel button	Numpad -
Increment Number in Filename	Decrease Number in Filename by 10	None	Shift Numpad -
Increment Number in Filename	Decrease Number in Filename by 100	None	Ctrl Numpad -
Assets Context Menu	Calls the context menu in the assets browser	None	Right Mouse
Assets Context Menu	Calls the context menu in the assets browser	None	Application button
Rename File or Directory	Renames the active file or folder	Context Menu	F2

File Browser / File Browser Main

Name	Function	Surface menu location	Hotkey
Apply Pose Library Pose	Applies a Pose Library Pose	None	dbl-Left Mouse
Execute File Window	Execute File Window	None	dbl-Left Mouse
Select	Activate/Select File	None	Left Mouse
Select	Open	None	double-Left Mouse
Select	Open / Extend	None	Ctrl Left Mouse
Select	Extend / Fill	None	Shift Left Mouse
Walk Select/Deselect File	Walk Select/Deselect File	None	Up Arrow
Walk Select/Deselect File	Walk Select/Deselect File	None	Shift Up Arrow
Walk Select/Deselect File	Walk Select/Deselect File	None	Shift Ctrl Up Arrow
Walk Select/Deselect File	Walk Select/Deselect File	None	Down Arrow

File Browser / File Browser Main			
Walk Select/Deselect File	Walk Select/Deselect File	None	Shift Down Arrow
Walk Select/Deselect File	Walk Select/Deselect File	None	Shift Ctrl Down Arrow
Walk Select/Deselect File	Walk Select/Deselect File	None	Left Arrow
Walk Select/Deselect File	Walk Select/Deselect File	None	Shift Left Arrow
Walk Select/Deselect File	Walk Select/Deselect File	None	Shift Ctrl Left Arrow
Walk Select/Deselect File	Walk Select/Deselect File	None	Right Arrow
Walk Select/Deselect File	Walk Select/Deselect File	None	Shift Right Arrow
Walk Select/Deselect File	Walk Select/Deselect File	None	Shift Ctrl Right Arrow
(De)select all files	Select All	File Browser / Select	A
(De)select all files	Select None	File Browser / Select	Alt A
(De)select all files	Inverse Selection	File Browser / Select	Ctrl I
(De)select all files	Deselect	File Browser / Select	dbl-A
Box Select	Box select	File Browser / Select / Border Select	B
Box Select	Box select	None	Left Mouse
Box Select	Box select Extend	None	Shift Left Mouse
Box Select	Box select Subtract	None	Ctrl Left Mouse
Highlight File	Highlight File	None	Mouse Move
Sort from Column	Sort from Column	None	Left Mouse

File Browser / File Browser Buttons			
Name	Function	Surface menu location	Hotkey
Increment Number in Filename	Increment Number in Filename by 1	File browser, the tiny plus button besides the edit box	Numpad +
Increment Number in Filename	Increment Number in Filename by 10	None	Shift Numpad +
Increment Number in Filename	Increment Number in Filename by 100	None	Ctrl Numpad +
Increment Number in Filename	Decrease Number in Filename by 1	File browser, the tiny minus button besides the edit box	Numpad -
Increment Number in Filename	Decrease Number in Filename by 10	None	Shift Numpad -
Increment Number in Filename	Decrease Number in Filename by 100	None	Ctrl Numpad -

Info

Info			
Name	Function	Surface menu location	Hotkey
Select Report	Select Report	None	Left Mouse
Select Report	Extend select report	None	Shift Left Mouse
Border Select	Brings up a rectangle select	Header - Info menu	B
Replay Operator	Replay Operator.	None	R

Info			
Delete Reports	Delete Reports	Header - Info menu	Delete
Copy Reports to Clipboard	Copy Reports to Clipboard	Header - Info menu	Ctrl C
Info Context Menu	Calls the Info Context Menu	None	dbl Right Mouse
(De)select all	Selects all	Header - Info menu	A
(De)select all	Deselects all	Header - Info menu	Alt A
(De)select all	Inverts the selection	Header - Info menu	Ctrl I
(De)select all	Deselects all	None	dbl - A

Property Editor

Property Editor			
Name	Function	Surface menu location	Hotkey
Context Menu	Opens a Right Mouse menu where you can select to arrange the properties horizontally or vertically	None	Right Mouse
Cycle Space Context	Cycles through the tabs upwards	None	Ctrl Wheel Up
Cycle Space Context	Cycles through the tabs downwards	None	Ctrl Wheel Down
Remove Modifier	Remove modifier	Modifier header - Modifier menu	Delete
Copy Modifier	Copy modifier	Modifier header - Modifier menu	Shift D
Apply Modifier	Duplicate modifier	Modifier header - Modifier menu	Ctrl A
Remove Grease Pencil Modifier	Remove Grease pencil modifier	Modifier header - Modifier menu	Delete
Copy Modifier	Copy Grease pencil modifier	Modifier header - Modifier menu	Shift D
Apply Modifier	Duplicate Grease pencil modifier	Modifier header - Modifier menu	Ctrl A
Remove Grease Pencil Modifier	Remove shader fx grease pencil effect	Modifier header - Modifier menu	Delete
Copy Effect	Duplicate the modifier	Modifier header - Modifier menu	Shift D

Text

Text / Text (Global)			
Name	Function	Surface menu location	Hotkey
Move Cursor			Alt Left Arrow
Move Cursor			Alt Right Arrow
Context Int Cycle	Context Int Cycle	None	Ctrl Wheel Up
Context Int Cycle	Context Int Cycle	None	Ctrl Wheel Down
Context Int Cycle	Context Int Cycle	None	Ctrl Numpad +
Context Int Cycle	Context Int Cycle	None	Ctrl Numpad -
New Text	Create Text Block	Text / Text / Create Text Block	Alt N
Open Text	Open Text Block	Text / Text / Open Text Block	Alt O
Reload	Reload	Text / Text / Reload	Alt R
Save	Save	Text / Text / Save	Alt S

Text / Text (Global)			
Save As	Save As	Text / Text / Save As	Shift Ctrl Alt S
Run Script	Run Script	Text / Text / Run Script	Alt P
Cut	Cut	Text / Edit / Cut	Ctrl X
Copy	Copy	Text / Edit / Copy	Ctrl C
Paste	Paste	Text / Edit / Paste	Ctrl V
Duplicate Line	Duplicate Line	Text / Edit / Duplicate Line	Ctrl D
Select All	Select All	Text / Edit / Select All	Ctrl A
Select Line	Selects the whole Line.	Text / Edit / Select Line	Shift Ctrl A
Select Word	Select Word	None	double-Left Mouse
Move Lines	Move selected Lines up	Text / Edit / Move Line(s) up	Shift Ctrl Up Arrow
Move Lines	Move selected Lines down	Text / Edit / Text / Edit / Move Line(s) up	Shift Ctrl Down Arrow
Indent	Indent	Text / Format / Indent	Tab
Unindent	Unindent	Text / Format / Unindent	Shift Tab
Toggle Comments	Toggle Comments	Format /	Shift Ctrl D
Move Cursor	Move Cursor to start of line	None	Home
Move Cursor	Move Cursor to end of line	None	End
Move Cursor	Move Cursor to the right	None	Left Arrow
Move Cursor	Move Cursor to the left	None	Right Arrow
Move Cursor	Move Cursor to the right by word space	None	Ctrl Left Arrow
Move Cursor	Move Cursor to the left by word space	None	Ctrl Right Arrow
Move Cursor	Move Cursor to line above	None	Up Arrow
Move Cursor	Move Cursor to line below	None	Down Arrow
Move Cursor	Move Cursor up by text height	None	Page Up
Move Cursor	Move Cursor down by text height	None	Page Down
Move Cursor	Move Cursor to start of text	None	Ctrl Home
Move Cursor	Move Cursor to end of text	None	Ctrl End
Move Select	Select Text of line before the caret	None	Shift Home
Move Select	Select Text of line after the caret	None	Shift End
Move Select	Expands the text selection to the left	None	Shift Left Arrow
Move Select	Expands the text selection to the right	None	Shift Right Arrow
Move Select	Expands the text selection to the left by word space	None	Shift Ctrl Left Arrow
Move Select	Expands the text selection to the right by words space	None	Shift Ctrl Right Arrow
Move Select	Expands the text selection upwards by one line	None	Shift Up Arrow
Move Select	Expands the text selection downwards by one line	None	Shift Down Arrow
Move Select	Expands the text selection upwards by the width of the text window	None	Shift Page Up

Text / Text (Global)			
Move Select	Expands the text selection downwards by the width of the text window	None	Shift Page Down
Move Select	Expands the text selection upwards to the start of the text	None	Shift Ctrl Home
Move Select	Expands the text selection downwards to the end of the text	None	Shift Ctrl End
Delete	Deletes selection / next character	Text Editor / Edit / Delete / Next Character	Delete
Delete	Deletes selection / deletes previous character	Text Editor / Edit / Delete / Previous Character	Back Space
Delete	Deletes next word	Text Editor / Edit / Delete / Next Word	Ctrl Delete
Delete	Deletes previous word	Text Editor / Edit / Delete / Previous Word	Ctrl Back Space
Toggle Overwrite	Toggle Overwrite	None	Insert
Scroll bar	Scroll bar	None	Left Mouse
Scroll bar	Scroll bar	None	Middle Mouse
Scroll	Scroll	None	Middle Mouse
Scroll	Scroll	None	Mouse Trackpad Pan
Set Selection	Set Selection	None	Tweak Left Any
Set Cursor	Set Cursor	None	Right Mouse
Set Selection	Set Selection	None	Shift Left Mouse
Scroll	Scroll	None	Wheel Up
Scroll	Scroll	None	Wheel Down
Line Break	Line Break	None	Return
Line Break	Line Break	None	Numpad Enter
Text Auto Complete	Text Auto Complete	None	Ctrl Spacebar
Line Number	Line Number	None	
insert	insert	None	

Text / Text Generic			
Name	Function	Surface menu location	Hotkey
Context Toggle	Toggle sidebar	Text / View / Properties	Ctrl T
Find	Find	Text / Edit / Find	Ctrl F
Go To Line		Text / Edit /	Ctrl J
Find Set Selected		Sidebar / Find panel / Find next button	Ctrl G
Replace		Sidebar / Find panel / Replace button	Ctrl H

Console

Console			
User Preferences location	Function	Surface menu location	Hotkey
Move Cursor	Move Cursor Previous Word	Console / Edit / Cursor to Previous Word	Ctrl Left Arrow
Move Cursor	Move Cursor Next Word	Console / Edit / Cursor to Next Word	Ctrl Right Arrow
Move Cursor	Move Cursor Line Begin	Console / Edit / Cursor to Line Begin	Home
Move Cursor	Move Cursor Line End	Console / Edit / Cursor to Line End	End
Context Int Cycle	Scale text up	Console / Edit / Zoom Text out	Ctrl Wheel Up
Context Int Cycle	Scale text down	Console / Edit / Zoom Text in	Ctrl Wheel Down
Context Int Cycle	Scale text up	None	Ctrl Numpad +
Context Int Cycle	Scale text down	None	Ctrl Numpad -
Move Cursor	Move caret left	Console / Edit / Cursor to next Character	Left Arrow
Move Cursor	Move caret right	Console / Edit / Cursor to previous Character	Right Arrow
History Cycle	Move caret up	Console / Edit / History Cycle	Up Arrow
History Cycle	Move caret down	Console / Edit / History Cycle	Down Arrow
Delete	Delete next character	Console / Edit / Delete /	Delete
Delete	Delete previous character	Console / Edit / Delete / Previous Character	Backspace
Delete	Delete previous character	None	Shift Backspace
Delete	Delete next word	Console / Edit / Delete / Next Word	Ctrl Delete
Delete	Delete previous word	Previous Word	Ctrl Back Space
Clear Line	Clears the whole line	Console / Console / Clear Line	Shift Return
Clear Line	Clears the whole line	None	Shift Numpad Enter
Console Execute	Execute	Console / Console / Console Execute	Return
Console Execute	Execute	None	Numpad Enter
Console Auto complete	Auto complete	Console / Auto complete button in header	Ctrl Spacebar
Copy to Clipboard as script	Copy as script	Console / Console / Copy as script	Shift Ctrl C
Copy to Clipboard	Copy	Console / Console / Copy	Ctrl C
Paste from Clipboard	Paste	Console / Console / Paste	Ctrl V
Set Selection	Set caret	None	Left Mouse
Select word	Select whole word	None	dbl-Left Mouse
Insert	Insert	None	Ctrl Tab
Indent	Indents the line	Console / Console / Indent	Tab
Unindent	Unindents the line	Console / Console / Unindent	Shift Tab
Console Context Menu	Calls the right click menu under the mouse	None	dbl Right Mouse
Insert	Text Input		

Clip

Clip / Clip (Global)			
User Preferences location	Function	Surface menu location	Hotkey
Solving	Solving Pie Menu	None	Shift S
Marker Settings	Marker Pie Menu	None	Shift E
Reconstruction	Reconstruction Pie Menu	None	Shift W
Tracking	Tracking Pie Menu	None	S
Open Clip	Open Clip	Clip / Clip / Open Clip	Alt O
Context Toggle	Toggle Toolbar	Clip / View / Tools	T
Context Toggle	Toggle Properties	Clip / View / Properties	Ctrl T

Clip / Clip Editor			
User Preferences location	Function	Surface menu location	Hotkey
Pan View	View Pan	None	Middle Mouse
Pan View	View Pan	None	Shift Middle Mouse
Pan View	View Pan	None	Mouse/Trackpad Pan
View Zoom	View Zoom	None	Ctrl Middle Mouse
View Zoom	View Zoom	None	Mouse/Trackpad Zoom
View Zoom	View Zoom	None	Ctrl Mouse/Trackpad Pan
Zoom In	View Zoom In	Clip Editor / View / View zoom in	Wheel In
Zoom Out	View Zoom Out	Clip Editor / View / View zoom in	Wheel Out
Zoom In	View Zoom In	None	Numpad +
Zoom Out	View Zoom Out	None	Numpad -
View Zoom Ratio	View Zoom Ratio 1:1	Clip / View /View Zoom Ratio 1:1	Numpad 1
Frame All	View All	Clip / View /View All	Home
Frame Fit	View Fit	Clip / View /View Fit	F
Frame Selected	View Selected	Clip / View /View Selected	Numpad 0
Frame All.	View All. N dof device for 3dConnexion	None	NDOF Fit
NDOF Pan/Zoom.	NDOF Pan/Zoom. N dof device for 3dConnexion	None	NDOF Motion
Jump to Frame	Jump to Frame.	None	Shift Ctrl Left Arrow
Jump to Frame	Jump to Frame.	None	Shift Ctrl Right Arrow
Jump to Frame	Jump to Frame.	None	Shift Alt Left Arrow
Jump to Frame	Jump to Frame.	None	Shift Alt Left Arrow
Change Frame	Change Frame	None	Left Mouse
Select	Select	None	Left Mouse
Select	Select	None	Shift Left Mouse
(De)select all	Select all	Clip / Select / (De)select all	A
Select None	Deselect all	Clip / Select /	Alt A
Select Inverse	Inverts the selection	Clip / Select / Inverse	Ctrl I
(De)select all	Deselect all	None	dbl-A
Box Select	Border Select	Clip / Select / Border Select	B
Circle Select	Circle Select	Clip / Select / Circle Select	G
Lasso Select	Lasso Select	None	Tweak Right Any

Clip / Clip Editor			
Lasso Select	Lasso Select	None	Tweak Right Any
Add Marker and Slide	Add Marker and Slide	None	Ctrl Left Mouse
Delete Marker	Delete Marker	Clip / Track / Delete Marker	Shift Delete
Slide Marker	Slide Marker	None	Left Mouse
Disable Markers	Disable Markers	None	Shift D
Delete Track	Delete Track	Clip / Track / Delete Track	Delete
Hide Tracks	Hide Selected	Clip / Track / Show/Hide / Hide Selected	H
Hide Tracks	Hide Unselected	Clip / Track / Show/Hide / Hide Unselected	Shift H
Hide Tracks Clear	Show Hidden	Clip / Track / Show/Hide / Show Hidden	Alt H
Side Plane Marker	Side Plane Marker	None	Left Mouse
Insert Keyframe	Insert Keyframe	Track Menu	I
Delete Keyframe	Delete Keyframe	Track Menu	Alt I
Move	Translate	Clip / Track / Transform / Translate	W
Move	Translate		Tweak Left Any
Resize	Resize	Clip / Track / Transform / Resize	R
Rotate	Rotate		E
Set 2D Cursor	Set 2 D Cursor	None	Alt Right Mouse
Copy Tracks	Copy Tracks	Clip / Track / Copy Tracks	Ctrl C
Paste Tracks	Paste Tracks	Clip / Track / Paste Tracks	Ctrl V
Context Menu	calls the right click menu under the mouse	None	Right Mouse Click

Clip / Clip Graph Editor			
	Function	Surface menu location	Hotkey
Change Frame	Change Frame	None	Right Mouse
Select	Select	None	Left Mouse
Select	Adds to selection	None	Shift Left Mouse
(De)select all Markers	Select all Markers	Select /	A
Select Markers None	Deselect all Markers	Select /	Alt A
Select Markers Inverse	Inverts Marker Selection	Select /	Ctrl I
(De)select all Markers	Deselect all Markers	None	dbl-A
Box Select	Box Select	Select /	B
Delete Curve	Delete Curve	Graph /	Delete
Delete Knot	Delete Knot	Graph /	Shift Delete
Frame All	View All	Clip / View / Home	Home
Frame All	View All. N dof device for 3dConnexion	None	NDOF Fit
Center Current Frame	Center Current Frame	Clip / View / Center Current Frame	Numpad 0
Context Toggle	Context Toggle	None	L
Clear Track Path	Clear Track Path	Graph /	Alt T

Clip / Clip Graph Editor

Clear Track Path	Clear Track Path	Graph /	Shift
Clear Track Path	Clear Track Path	Graph /	Shift Alt T
Disable Markers	Disable Markers	Graph /	Shift D
Translate	Translate	Graph /	W
Translate	Translate		Tweak Left Any
Resize	Resize	Graph /	R
Rotate	Rotate	Graph /	E

Clip / Clip Dope sheet Editor

Name	Function	Surface menu location	Hotkey
Select Channel	Select Channel	None	Left Mouse
Frame All	View All	View /	Home
Frame All	View All. N dof device for 3dConnexion	Clip / View / Home	NDOF Fit

Grease Pencil

Grease Pencil / Grease Pencil(Global)

Name	Function	Surface menu location	Hotkey
Draw Annotation	Draw Freehand Annotation strokes	View / Annotation (Legacy	D Left Mouse
Draw Line Annotation	Draw Line Annotation strokes	View / Annotation (Legacy	Alt D Left Mouse
Draw Polyline Annotation	Draw Polyline Annotation strokes	View / Annotation (Legacy	Shift Alt D Left Mouse
Erase Annotation	Erase Annotation strokes	View / Annotation (Legacy	D Right Mouse
Add Annotation Layer	Adds Blank Annotation Frame	View / Annotation (Legacy	D B
Erase Annotation Active Keyframe	Deletes Annotation Layer	View / Annotation (Legacy	D Delete
Delete		Grease pencil menu	Delete

Grease Pencil / Stroke Curve Edit Mode

Name	Function	Surface menu location	Hotkey
No entry in this category			

Grease Pencil - Grease Pencil in Stroke edit mode

Name	Function	Surface menu location	Hotkey
Grease Pencil Interpolation	Grease Pencil Interpolation	Header Interpolate drop down box	Ctrl Alt E
Interpolate Sequence	Interpolate Sequence	Header Interpolate drop down box	Shift Ctrl E
Select		None	Left Mouse
(De)select all strokes	Select all	Select /	A
Select None	Deselect all	Select /	Alt A

Grease Pencil - Grease Pencil in Stroke edit mode			
Select Inverse	Inverts the current selection	Select /	Ctrl I
(De)select all strokes	Deselect all	None	dbl-A
Lasso select strokes	Lasso select strokes Event mapping	Select /	Tweak Right Any
Lasso select strokes	Lasso select strokes Event mapping	None	Tweak Right Any
Lasso select strokes	Lasso select strokes Event mapping	None	Tweak Right Any
Lasso select strokes	Lasso select strokes Event mapping	None	Tweak Right Any
Select	Adds the selection to the current selection	None	Shift Left Mouse
Select	Selects whole stroke	None	Alt Left Mouse
Select	Adds the selection to the current selection	None	Shift Alt Left Mouse
Select linked	Selects linked stroke	Select /	L
Select linked	Selects linked stroke	None	Ctrl L
Alternated		Select /	Shift L
Select Grouped	Selects Grouped stroke	Select / Grouped	Shift G
Select more	Expands the selection	Select /	Ctrl Numpad +
Select less	Reduces the selection	Select /	Ctrl Numpad -
Duplicate Strokes	Duplicates the currently selected stroke	Strokes /	Shift D
Delete	Calls the delete menu with further options	Strokes / Delete /	Delete
Dissolve	Delete selected points without splitting stroke	Strokes / Dissolve	Ctrl Delete
Delete all active Frames	Delete all active Frames	None	Shift Delete
Call Menu	Separate Menu	Strokes /	P
Join Strokes	Join Strokes	Strokes /	Ctrl J
Join Strokes	Join Strokes and copy	Strokes /	Shift Ctrl J
Copy	Copy strokes	Strokes /	Ctrl C
Paste	Paste strokes	Strokes /	Ctrl V
Show all layers	Show all layers	Strokes / Hide /	Alt H
Hide Layer(s)	Hide selected Grease pencil layer	Strokes / Hide /	H
Hide Layer(s)	Hide all Grease pencil layers	Strokes / Hide /	Shift H
Hide Selection		Strokes / Hide /	Ctrl H
Move Strokes to Layer	Move Strokes to Layer	Strokes / Move to Layer	M
Move	Move	None	Tweak Left Any
Mirror	Mirror	Strokes / Transform /	Ctrl M
Bend	Bend	Strokes / Transform /	Shift W
To Sphere	To Sphere	Strokes / Transform /	Shift Alt S
Shear		Strokes / Transform /	Shift Ctrl Alt S
Transform	Scales the current selected stroke section bigger or smaller	Strokes / Transform /	Alt S
Select Mode Toggle	Select only Points Mode	Header	X
Select Mode Toggle	Select all Stroke Points Mode	Header	C

Grease Pencil - Grease Pencil in Stroke edit mode			
Select Mode Toggle	Select all segments	Header	V
Call Menu	Calls the right click menu	None	dbl Right Mouse
Set Tool by Name	builtin.select_box	Tool shelf	B
Set Tool by Name	builtin.select_circle	Tool shelf	G
Set Tool by Name	builtin.move	Tool shelf	W
Set Tool by Name	builtin.rotate	Tool shelf	E
Set Tool by Name	builtin.scale	Tool shelf	R
Set Tool by Name	builtin.select	Tool shelf	D

Grease Pencil / Grease Pencil Stroke Paint (Draw Brush)			
Name	Function	Surface menu location	Hotkey
Grease Pencil Draw	Draw Freehand	None	Left Mouse
Grease Pencil Draw	Draw Freehand	None	Shift Left Mouse
Grease Pencil Draw	Draw straight lines	None	Alt Left Mouse
Grease Pencil Draw	Draw Poly Line	None	Shift Alt Left Mouse
Grease Pencil Draw	Eraser	None	Ctrl Left Mouse
Grease Pencil Draw	Guide tool related hotkey - sets the reference point (only in Cursor or Custom mode)	Grease Pencil Guide Panel	O
Grease Pencil Draw	Guide tool related hotkey - adjust guide angle by 15°, alt key 45°	Grease Pencil Guide Panel	J
Grease Pencil Draw	Guide tool related hotkey - adjust guide angle by 15°, alt key 45°	Grease Pencil Guide Panel	Alt J
Grease Pencil Draw	Guide tool related hotkey - adjust guide angle by 15°, alt key 45°	Grease Pencil Guide Panel	Shift J
Grease Pencil Draw	Guide tool related hotkey - ???	Grease Pencil Guide Panel	K
Grease Pencil Draw	Guide tool related hotkey - ???	Grease Pencil Guide Panel	Alt K
Grease Pencil Draw	Guide tool related hotkey - ???	Grease Pencil Guide Panel	Shift K
Grease Pencil Draw	Guide tool related hotkey - turn on Parallel Line guide	Grease Pencil Guide Panel	L
Grease Pencil Draw	Guide tool related hotkey - Use angle of last freehand stroke for Parallel mode	Grease Pencil Guide Panel	Alt L
Grease Pencil Draw	Guide tool related hotkey - turn on Parallel Line guide	Grease Pencil Guide Panel	Ctrl L
Grease Pencil Draw	Guide tool related hotkey - turn off guides	Grease Pencil Guide Panel	V
Grease Pencil Draw	Guide tool related hotkey - toggle between Circular & Radial mode or 90° in Parallel mode	Grease Pencil Guide Panel	M
Grease Pencil Draw	Guide tool related hotkey - turn on Circular guide then toggle between Circular and Radial	Tool Shelf	C
Grease Pencil Draw	Guide tool related hotkey - turn on Circular guide then toggle between Circular and Radial	Tool Shelf	Alt C
Grease Pencil Draw	Eraser	Tool Shelf	Eraser
Box Select	Box Select	Tool Shelf	B
Lasso Select Strokes	Lasso Select	Tool Shelf	Tweak Right Any

Grease Pencil / Grease Pencil Stroke Paint (Fill)

Name	Function	Surface menu location	Hotkey
Grease Pencil Fill	Draw Freehand	Tool Shelf	Left Mouse
Grease Pencil Fill	Draw Freehand	Tool Shelf	Shift Left Mouse
Grease Pencil Draw	Draw Freehand	Tool Shelf	Ctrl Left Mouse
Grease Pencil Draw	Draw Freehand	Tool Shelf	Alt Left Mouse
Lasso Select Strokes	Lasso Select	Tool Shelf	Tweak Right Any

Grease Pencil / Grease Pencil Stroke Paint (Erase)

Name	Function	Surface menu location	Hotkey
Grease Pencil Draw	Draw Freehand	Tool Shelf	Left Mouse
Grease Pencil Draw	Draw Freehand	Tool Shelf	Eraser
Box Select	Box Select	Tool Shelf	B
Lasso Select Strokes	Lasso Select	Tool Shelf	Tweak Right Any

Grease Pencil / Grease Pencil Stroke Paint (Tint)

Name	Function	Surface menu location	Hotkey
Stroke Vertex Paint	Vertex painting with tint tool	Tool Shelf	Left Mouse
Stroke Vertex Paint	Draw Freehand	Tool Shelf	Ctrl Left Mouse

Grease Pencil / Grease Pencil Stroke Paint Mode

Name	Function	Surface menu location	Hotkey
Radial Control	Radial Control - Brush strength	Tool Shelf	Shift F
Radial Control	Radial Control - Brush size	Tool Shelf	F
Radial Control	Radial Control - Eraser radius	Tool Shelf	Ctrl F
Draw Context Menu	calls the right click under the mouse	Tool Shelf	Right Mouse Click
Set Tool by name	builtin_brush.Draw		D
Set Tool by name	builtin_brush.Erase		E

Grease Pencil / Grease Pencil Stroke Sculpt Mode

Name	Function	Surface menu location	Hotkey
(De)select All Strokes	All	Select /	A
Select None	None	Select /	Alt A
Select Inverse	Inverse	Select /	Ctrl I
(De)select All Strokes	None	None	dbl-A
Circle Select	Circle Select	Select /	G
Box Select	Box Select	Select /	B
Lasso Select Strokes			Tweak Right Any
Lasso Select Strokes			Tweak Right Any
Lasso Select Strokes			Tweak Right Any
Lasso Select Strokes			Tweak Right Any
Select	Extend selection	None	Shift Left Mouse

Grease Pencil / Grease Pencil Stroke Sculpt Mode			
Select	Entire Stroke	None	Alt Left Mouse
Select	Entire Stroke, extend selection	None	Shift Alt Left Mouse
Select More		Select /	Ctrl Numpad +
Select Less		Select /	Ctrl Numpad -
Radial Control		Sculpt /	Shift F
Radial Control		Sculpt /	F
Context Toggle			Shift Q
Context Toggle			Shift Alt Q
Sculpt Context Menu	Calls the right click menu under the mouse	None	Double Right Mouse
Copy Strokes	Copies the stroke	None	Ctrl C
Animation	Calls the animation menu		I
Delete All Active Frames	Delete		Shift Delete
Set Tool by Name	builtin_brush.Push	Toolshelf	D

Grease Pencil / Grease Pencil Stroke Sculpt Mode (Smooth)			
Name	Function	Surface menu location	Hotkey
Stroke Sculpt	Smooth brush	Tool shelf	Left Mouse
Stroke Sculpt	Smooth brush	Tool Shelf	Ctrl Left Mouse
Stroke Sculpt	Smooth brush	Tool Shelf	Shift Left Mouse

Grease Pencil / Grease Pencil Stroke Sculpt Mode (Thickness)			
Name	Function	Surface menu location	Hotkey
Stroke Sculpt	Thickness brush	Tool shelf	Left Mouse
Stroke Sculpt	Thickness brush	Tool Shelf	Ctrl Left Mouse
Stroke Sculpt	Thickness brush	Tool Shelf	Shift Left Mouse

Grease Pencil / Grease Pencil Stroke Sculpt Mode (Strength)			
Name	Function	Surface menu location	Hotkey
Stroke Sculpt	Strength brush	Tool shelf	Left Mouse
Stroke Sculpt	Strength brush	Tool Shelf	Ctrl Left Mouse
Stroke Sculpt	Strength brush	Tool Shelf	Shift Left Mouse

Grease Pencil / Grease Pencil Stroke Sculpt Mode (Grab)			
Name	Function	Surface menu location	Hotkey
Stroke Sculpt	Grab brush	Tool shelf	Left Mouse
Stroke Sculpt	Grab brush	Tool Shelf	Ctrl Left Mouse
Stroke Sculpt	Grab brush	Tool Shelf	Shift Left Mouse

Grease Pencil / Grease Pencil Stroke Sculpt Mode (Push)			
Name	Function	Surface menu location	Hotkey
Stroke Sculpt	Push brush	Tool shelf	Left Mouse

Grease Pencil / Grease Pencil Stroke Sculpt Mode (Push)

Stroke Sculpt	Push brush	Tool Shelf	Ctrl Left Mouse
Stroke Sculpt	Push brush	Tool Shelf	Shift Left Mouse

Grease Pencil / Grease Pencil Stroke Sculpt Mode (Twist)

Name	Function	Surface menu location	Hotkey
Stroke Sculpt	Twist brush	Tool shelf	Left Mouse
Stroke Sculpt	Twist brush	Tool Shelf	Ctrl Left Mouse
Stroke Sculpt	Twist brush	Tool Shelf	Shift Left Mouse

Grease Pencil / Grease Pencil Stroke Sculpt Mode (Pinch)

Name	Function	Surface menu location	Hotkey
Stroke Sculpt	Pinch brush	Tool shelf	Left Mouse
Stroke Sculpt	Pinch brush	Tool Shelf	Ctrl Left Mouse
Stroke Sculpt	Pinch brush	Tool Shelf	Shift Left Mouse

Grease Pencil / Grease Pencil Stroke Sculpt Mode (Randomize)

Name	Function	Surface menu location	Hotkey
Stroke Sculpt	Clone brush	Tool shelf	Left Mouse
Stroke Sculpt	Clone brush	Tool Shelf	Ctrl Left Mouse
Stroke Sculpt	Clone brush	Tool Shelf	Shift Left Mouse

Grease Pencil / Grease Pencil Stroke Sculpt Mode (Clone)

Name	Function	Surface menu location	Hotkey
Stroke Sculpt	Clone brush	Tool shelf	Left Mouse
Stroke Sculpt	Clone brush	Tool Shelf	Ctrl Left Mouse
Stroke Sculpt	Clone brush	Tool Shelf	Shift Left Mouse

Grease Pencil / Grease Pencil Stroke Weight Mode

Name	Function	Surface menu location	Hotkey
Radial Control		Weights menu	Shift F
Radial Control		Weights Menu	F
Context Toggle			Shift Q
Context Toggle			Shift Alt Q
Insert Blank Frame			Shift I
Delete All Active Frames	Delete		Shift Delete
Change active Layer			Y
Animation	Calls the animation menu		I
Weight Paint Context Menu	Calls the right click menu under the mouse		dbl Right Mouse

Grease Pencil / Grease Pencil Stroke Weight (Draw)

Name	Function	Surface menu location	Hotkey
------	----------	-----------------------	--------

Grease Pencil / Grease Pencil Stroke Weight (Draw)

Weight painting	Weight brush	Tool shelf	Left Mouse
-----------------	--------------	------------	------------

Grease Pencil / Grease Pencil Stroke Vertex Mode

Name	Function	Surface menu location	Hotkey
(De)select All Strokes			A
(De)select All Strokes			Alt A
(De)select All Strokes			Ctrl I
(De)select All Strokes			dbl-A
Circle Select			G
Box Select			B
Lasso Select Strokes			Tweak Right Any
Lasso Select Strokes			Tweak Right Any
Lasso Select Strokes			Tweak Right Any
Lasso Select Strokes			Tweak Right Any
Select			Shift Left Mouse
Select			Alt Left Mouse
Select			Shift Alt Left Mouse
Select Linked		Select menu	L
Select Linked		Select menu	Ctrl L
Alternated			Shift L
Select Grouped			Shift G
Select More			Ctrl Numpad +
Select Less			Ctrl Numpad -
Radial Control		Weights menu	Shift F
Radial Control		Weights Menu	F
Context Toggle			Shift Q
Context Toggle			Shift Alt Q
Set tool by name	builtin_brush.Draw	Tool Shelf	D
Insert blank Frame	Inserts a blank grease pencil frame		Shift I
Delete all active Frames	Deletes all active grease pencil frames		Shift Delete
Change Active Layer	Change active grease pencil layer		Y
Animation	Calls the animation menu under the mouse		I
Vertex Paint Context Menu	Calls the right click menu under the mouse		Right Mouse Click

Grease Pencil / Grease Pencil Stroke Vertex (Draw)

Name	Function	Surface menu location	Hotkey
Stroke Vertex Paint	Vertex painting	Tool Shelf	Left Mouse
Stroke Vertex Paint	Vertex painting	Tool Shelf	Ctrl Left Mouse
Radial Control	Pen Strength		Shift F
Radial Control	Brush Strength		F

Grease Pencil / Grease Pencil Stroke Vertex (Blur)

Name	Function	Surface menu location	Hotkey
Stroke Vertex Paint	Vertex painting	Tool Shelf	Left Mouse
Radial Control	Pen Strength		Shift F
Radial Control	Brush Strength		F

Grease Pencil / Grease Pencil Stroke Vertex (Average)

Name	Function	Surface menu location	Hotkey
Stroke Vertex Paint	Vertex painting	Tool Shelf	Left Mouse
Stroke Vertex Paint	Vertex painting	Tool Shelf	Ctrl Left Mouse
Radial Control	Pen Strength		Shift F
Radial Control	Brush Strength		F

Grease Pencil / Grease Pencil Stroke Vertex (Smear)

Name	Function	Surface menu location	Hotkey
Stroke Vertex Paint	Vertex painting	Tool Shelf	Left Mouse
Radial Control	Pen Strength		Shift F
Radial Control	Brush Strength		F

Grease Pencil / Grease Pencil Stroke Vertex (Replace)

Name	Function	Surface menu location	Hotkey
Stroke Vertex Paint	Vertex painting	Tool Shelf	Left Mouse
Radial Control	Brush Strength		F

Mask Editing**Mask Editing**

Name	Function	Surface menu location	Hotkey
New Mask	New Mask	Image Editor / Header, Mask Drop down box	Alt N
Add Vertex and Slide	Add Vertex and Slide	None	Ctrl Left Mouse
Add Feather Vertex and Slide	Add Feather Vertex and Slide	None	Shift Ctrl Left Mouse
Delete	Delete	Image Editor / Mask / Delete	Delete
Select	Select	None	Left Mouse
Select	Select	None	Shift Left Mouse
(De)select all	(De)select all	Image Editor / Select / (De)Select all	A
Select None		Select menu	Alt A
Select Inverse	Invert Selection	Image Editor / Select / Inverse	Ctrl I
(De)select all		Image Editor / Select /	dbl-A
Select Linked all	Select Linked all	Image Editor / Select / Select Linked	Ctrl L
Select Linked	Select Linked	None	L

Mask Editing			
Select Linked	Select Linked	None	Shift L
Border Select	Border Select	Image Editor / Select / Border Select	B
Circle Select	Circle Select	Image Editor / Select / Circle Select	G
Lasso Select	Lasso Select	None	Tweak Right Any
Lasso Select	Lasso Select	None	Tweak Right Any
Select More	Select More	Image Editor / Select / Select More	Ctrl Numpad +
Select Less	Select Less	Image Editor / Select / Select Less	Ctrl Numpad -
Show hidden Layer	Show hidden Layer	Image Editor / Mask / Show / Hide	Alt H
Hide Layer	Hide selected Layer	Image Editor / Mask / Show / Hide	H
Hide Layer	Hide unselected Layer	Image Editor / Mask / Show / Hide	Shift H
Select	Select	None	Ctrl Left Mouse
Toggle Cyclic	Toggle Cyclic	Image Editor / Mask / Toggle Cyclic	Alt C
Slide Point	Slide Point	None	Left Mouse
Slide Spline Curvature	Slide Spline Curvature	None	Left Mouse
Set Handle Type	Set Handle Type	Image editor, Mask menu	V
Recalc Normals	Recalc Normals	Image Editor / Mask / Recalc Normals	Shift N
Make Parent	Make Parent	Image Editor / Mask / Make Parent	Ctrl P
Clear Parent	Clear Parent	Image Editor / Mask / Clear Parent	Alt P
Insert Shape key	Insert Shape key	Image Editor / Mask / Animation	I
Clear Shape Key	Clear Shape Key	Image Editor / Mask / Animation	Alt I
Add Duplicate	Add Duplicate	Mask menu	Shift D
Copy Splines	Copy Splines	Image Editor / Mask / Copy Splines	Ctrl C
Paste Splines	Paste Splines	Image Editor / Mask / Paste Splines	Ctrl V
Move	Translate	Image Editor / Mask / Transform	W
Move	Translate	None	Tweak Left Any
Resize	Resize	Image Editor / Mask / Transform	R
Rotate	Rotate	Image Editor / Mask / Transform	E
Transform	Scale Feather	Image Editor / Mask / Transform	Alt S
Set 2D Cursor		None	Alt Right Mouse
Move		None	Tweak Right Any

Frames

Frames			
Name	Function	Surface menu location	Hotkey
Frame Offset	Frame Offset	None	Left Arrow
Frame Offset	Frame Offset	None	Right Arrow
Jump to Endpoint		Timeline / Header / Play prop	Shift Right Arrow
Jump to Endpoint		Timeline / Header / Play prop	Shift Left Arrow
Jump to Keyframe	Jump to Keyframe	None	Up Arrow
Jump to Keyframe	Jump to Keyframe	None	Down Arrow
Jump to Keyframe	Jump to Keyframe	None	Media Last
Jump to Keyframe	Jump to Keyframe	None	Media First
Frame Offset	Frame Offset	None	Alt Wheel Down
Frame Offset	Frame Offset	None	Alt Wheel Up
Play Animation		Navi	Shift Spacebar
Play Animation		None	Shift Ctrl Spacebar
Cancel Animation		None	Esc
Play Animation		None	Media Play/Pause
Cancel Animation	Cancel Animation	None	Media Stop

Markers

Markers			
Name	Function	Surface menu location	Hotkey
Move Time Marker	Move Time Marker	None	Tweak Left Any
Duplicate Time Marker	Duplicate Time Marker	Graph, Dope sheet, NLA Editor / Marker / Duplicate Marker	Shift D
Select Time Marker	Select Time Marker	None	Left Mouse
Markers /Select Time Marker	Select Time Marker	None	Shift Left Mouse
Select Time Marker	Select Time Marker	None	Ctrl Left Mouse
Select Time Marker	Select Time Marker	None	Shift Ctrl Left Mouse
Marker Box Select	Marker Border Select	Graph, Dope sheet, NLA Editor / Select / Border Select	B
(De)select all markers	Select all markers	Marker / Select	A
De)select all markers	Deselect all markers	Marker / Select	Alt A
De)select all markers	Invert the selection	Marker / Select	Ctrl I
De)select all markers	Deselect all markers	None	dbl-A
Delete Markers	Delete Markers	Graph, Dope sheet, NLA Editor / Marker / Delete	Delete
Rename Marker	Rename markers	Marker /	Left Mouse double click
Rename Marker	Rename markers	Marker /	F2
Move Time Marker	Move Time Marker	None	W
Bind Camera to Marker	Bind Camera to Marker	Graph, Dope sheet, NLA Editor / View / Bind Camera to Marker	Ctrl B

Animation

Animation

Name	Function	Surface menu location	Hotkey
Animation / Change Frame	Change Frame	None	Right Mouse Click Drag

Animation Channels

Animation Channels

Name	Function	Surface menu location	Hotkey
Mouse Click on Channels	Select channel	None	Left Mouse
Mouse Click on Channels	Select channel, extend selected	None	Ctrl Left Mouse
Mouse Click on Channels	Select channel, extend range	None	Shift Left Mouse
Mouse Click on Channels	Select channel, select children only	None	Shift Ctrl Left Mouse
Rename Channels	Rename Channels	None	double-Left Mouse
Set Channel Keyframes	Set Channel Keyframes	None	double-Left Mouse
Set Channel Keyframes	Set Channel Keyframes	None	Shift double-Left Mouse
Find Channels		Marker /	Ctrl F
Select All	Select All	/ Select / Select All	A
Select All		/ Select /	Alt A
Select All	Inverts Selection	/ Select / Invert Selection	Ctrl I
Select All		None	dbl-A
Box Select	Box Select	/ Select / Border Select	B
Box Select	Border Select	None	Tweak Left Any
Delete Channels	Delete Channels	/ Channel / Delete Channels	Delete
Expands Channels	Expands Channels	/ Channel / Expands Channels	Numpad +
Collapse Channels	Collapse Channels	/ Channel / Collapse Channels	Numpad -
Expands Channels	Expands Channels	/ Channel / Expands Channels	Ctrl Numpad +
Collapse Channels	Collapse Channels	/ Channel / Collapse Channels	Ctrl Numpad -
Move Channels	Move Channels	/ Channel / Move / To Top	Page Up
Move Channels	Move Channels	/ Channel / Move / Up	Page Down
Move Channels	Move Channels	/ Channel / Move / Down	Shift Page Up
Move Channels	Move Channels	/ Channel / Move / To Bottom	Shift Page Down
Dope Sheet Channel Context Menu	calls the right click menu under the mouse	None	Right Mouse Click

View 3D Gesture Circle

View 3D Gesture Circle

Name	Function	Surface menu location	Hotkey
Cancel	Cancel	None	Esc
Cancel	Cancel	None	Right Mouse

View 3D Gesture Circle

Confirm	Confirm	None	Return
Confirm	Confirm	None	Numpad Enter
Select	Select	None	Left Mouse
Deselect	Deselect	None	Shift Left Mouse
No Operation	No Operation	None	Left Mouse
Deselect	Deselect	None	Middle Mouse
No Operation	No Operation	None	Left Mouse
Subtract	Subtract	None	Wheel Up
Subtract	Subtract	None	Numpad -
Add	Add	None	Wheel Down
Add	Add	None	Numpad +
Size	Size	None	Mouse Trackpad/Pan

Gesture Straight Line

Gesture Straight Line

Name	Function	Surface menu location	Hotkey
Cancel	Cancel	None	Esc
Cancel	Cancel	None	Right Mouse
Begin	Begin	None	Left Mouse
Select	Select	None	Left Mouse

Gesture Zoom Border

Gesture Zoom Border

Name	Function	Surface menu location	Hotkey
Cancel	Cancel	None	Esc
Cancel	Cancel	None	Right Mouse
Begin	Begin	None	Left Mouse
In	In	None	Left Mouse
Begin	Begin	None	Middle Mouse
Out	Out	None	Middle Mouse

Gesture Box

Gesture Box

	Function	Surface menu location	Hotkey
Cancel	Cancel	None	Esc
Cancel	Cancel	None	Right Mouse

Gesture Box			
Select	Select	None	Right Mouse
Begin	Begin	None	Shift Left Mouse
Deselect	Deselect	None	Shift Left Mouse
Begin	Begin	None	Left Mouse
Select	Select	None	Left Mouse
Begin	Begin	None	Middle Mouse
Deselect	Deselect	None	Middle Mouse

Standard Modal Map

Standard Modal Map			
Name	Function	Surface menu location	Hotkey
Cancel	Cancel	None	Esc
Apply	Apply	None	Left Mouse
Apply	Apply	None	Return
Apply	Apply	None	Numpad Enter
Snap on	Snap on	None	Left Ctrl
Snap off	Snap off	None	Left Ctrl

Transform Modal Map

Transform Modal Map			
Name	Function	Surface menu location	Hotkey
Confirm	Confirm	None	Left Mouse
Confirm	Confirm	None	Return
Confirm	Confirm	None	Numpad Enter
Cancel	Cancel	None	Right Mouse
Cancel	Cancel	None	Esc
X Axis			X
Y Axis			Y
Z Axis			Z
X Plane			ALT X
Y Plane			ALT Y
Z Plane			ALT Z
Clear Constraints			C
Move	Translate	None	W
Rotate	Rotate	None	E
Resize	Resize	None	R
Snap Toggle	Snap Toggle	None	Shift Tab
Snap Invert	Invert Snap On	None	Left Ctrl

Transform Modal Map			
Snap Invert (Off)	Invert Snap Off	None	Left Ctrl
Snap Invert	Invert Snap On	None	Right Ctrl
Snap Invert (Off)	Invert Snap Off	None	Right Ctrl
Add Snap Point	Add Snap Point	None	A
Remove last Snap Point	Remove last Snap Point	None	Alt A
Increase Proportional Influence	Increase Proportional Influence	None	Page Up
Decrease Proportional Influence	Decrease Proportional Influence	None	Page Down
Increase Proportional Influence	Increase Proportional Influence	None	Shift Page Up
Decrease Proportional Influence	Decrease Proportional Influence	None	Shift Page Down
Increase Proportional Influence	Increase Proportional Influence	None	Wheel Down
Decrease Proportional Influence	Decrease Proportional Influence	None	Wheel Up
Increase Proportional Influence	Increase Proportional Influence	None	Shift Wheel Down
Decrease Proportional Influence	Decrease Proportional Influence	None	Shift Wheel Up
	Adjust Proportional Influence	None	Mouse/Trackpad Pan
Select next Edge Slide Edge	Select next Edge Slide Edge	None	Alt Wheel Down
Select previous Edge Slide Edge	Select previous Edge Slide Edge	None	Alt Wheel Up
Increase Max AutoIK Chain Length	Increase Max AutoIK Chain Length	None	Shift Page Up
Decrease Max AutoIK Chain Length	Decrease Max AutoIK Chain Length	None	Shift Page Down
Increase Max AutoIK Chain Length	Increase Max AutoIK Chain Length	None	Shift Wheel Down
Decrease Max AutoIK Chain Length	Decrease Max AutoIK Chain Length	None	Shift Wheel Up
Toggle Direction for Node Auto-offset	Toggle Direction for Node Auto-offset	None	T
Automatic Constraint	Limits to a chosen axis in the 3d view.	None	Middle Mouse
Automatic Constraint	Limits to a chosen axis in the 3d view.	None	S
Automatic Constraint Plane	Limits to a chosen axis plane in the 3d view.	None	Alt Middle Mouse
Automatic Constraint Plane	Limits to a chosen axis plane in the 3d view.	None	Alt S

Eyedropper Modal Map

Eyedropper Modal Map			
Name	Function	Surface menu location	Hotkey
Cancel	Cancel	None	Esc
Cancel	Cancel	None	Right Mouse
Confirm Sampling	Confirm Sampling	None	Return
Confirm Sampling	Confirm Sampling	None	Numpad Enter
Confirm Sampling	Confirm Sampling	None	Left Mouse
Start Sampling	Start Sampling	None	Left Mouse

Eyedropper Modal Map

Reset Sampling	Reset Sampling	None	Spacebar
----------------	----------------	------	----------

Eyedropper ColorBand Point Sampling Map

Eyedropper ColorBand Point Sampling Map

Name	Function	Surface menu location	Hotkey
Cancel	Cancel	None	Esc
Cancel	Cancel	None	Back Space
Confirm Sampling	Confirm Sampling	None	Right Mouse
Confirm Sampling	Confirm Sampling	None	Return
Confirm Sampling	Confirm Sampling	None	Numpad Enter
Sample a point	Start Sampling	None	Left Mouse
Reset Sampling	Reset Sampling	None	Spacebar



42 - Important Hotkeys

The usage of Bforartists is UI centered. You should get away with using the tools from the UI, and not by hotkeys. And we have reduced the keymap dramatically compared to the Blender keymap.

There are however a few important hotkeys left that makes your life easier. And there are still some hotkeys that you simply need. Like the navigation with the mouse, which is also some kind of a hotkey.

Here we list some of the most used and basic hotkeys at one sheet, so that you don't have to dig through the manual and the whole keymap chapter or the menus to find the basic functionality.

3D view

All Modes

Move view	MMB	Move selection	W
Rotate view	RMB / Alt + MMB	Rotate selection	E
Zoom view	Scrollwheel / Ctrl + MMB	Scale selection	R
Trackball rotation	2 x E	Render Image	F12
Switch to Cameraview	Numpad 0		

Switch views to orthographic

Ortho front	Numpad 1	Ortho right	Numpad 3
Ortho back	Ctrl + Numpad 1	Ortho top	Numpad 7
Ortho left	Ctrl + Numpad 3	Ortho bottom	Ctrl + Numpad 7

To leave the orthographic views rotate the view.

Select

Tweak	D	Lasso Select	RMB
Box Select	B	Add to / Remove from selection	Hold Shift
Select Circle	G		

Modes

Object Mode	1	Vertex Paint	4
Edit Mode	2	Weight Paint	5

Sculpt Mode	3	Texture paint	6
Pose Mode	0		

Edit Mode with a Mesh object			
Edge Select	X	Select Edgeloop	Alt LMB
Vertice Select	C	Select Edgering	Shift Alt LMB
Face Select	V	Pick shortest Path	Ctrl Left Click
Extrude	S	Add to selection	Hold Shift

Edit mode with a Bone object			
Extrude	S	Clear Parent	Alt P
Extrude Forked	Shift S	Separate Bones	P
Make Parent	Ctrl P		

Sculpt Mode with a Mesh object			
Brush Size	F	Brush Angle	Ctrl F
Brush Strength	Shift F		

Vertex Mode with a Mesh object			
Brush Size	F	Brush Angle	Ctrl F
Brush Strength	Shift F		

Texture Paint Mode with a Mesh object			
Brush Size	F	Brush Angle	Ctrl F
Brush Strength	Shift F	Radial Control Mask Angle	Ctrl Alt F

Paint modes when working with a stencil map			
Move stencil Texture	Alt RMB	Move secondary stencil Texture	Shift Ctrl Alt RMB
Rotate stencil Texture	Shift RMB	Rotate secondary stencil Texture	Shift Alt RMB

Scale stencil Texture	Ctrl RMB	Scale secondary stencil Texture	Ctrl Alt RMB
------------------------------	----------	--	--------------

Global keys

Load Save

Open File	Ctrl O	Save as	Shift Ctrl S
Save File	Ctrl S	New File	Ctrl N

Undo Redo

Undo	Ctrl Z	Redo	Shift Ctrl Z
-------------	--------	-------------	--------------

F keys

Rename active item	F2	Batch rename item	Ctrl F2
Search Menu	F3	File context menu	F4
Flip Region (Sidebar and Tool shelf with the mouse over the area)	F5	System Console (Windows only)	Alt F5
Redo Last (Adjust last operation panel)	F6	Show / Hide Renderview	F11
Play rendered animation	Ctrl F11	Render Still	F12
Render Animation	Ctrl F12		