

7.1.12 Editors - 3D Viewport - Header - Mesh - Edit mode - Faces menu

Table of content

Detailed Table of content.....	1
Edit Mode - Faces menu.....	4
Legacy.....	4
Poke Faces.....	5
Triangulate Faces.....	6
Tris to Quads.....	6
Solidify Faces.....	7
Wire Frame.....	7
Fill.....	8
Grid Fill.....	8
Beautify Faces.....	9
Intersect (Knife).....	9
Intersect (Boolean).....	10
Weld Edges into Faces.....	11
Face Data.....	11

Detailed Table of content

Detailed table of content

Detailed Table of content.....	1
Edit Mode - Faces menu.....	4
Legacy.....	4
Inset Faces.....	4
Last Operator Inset Faces.....	4
Boundary.....	4
Offset Even.....	4
Offset Relative.....	4
Edge Rail.....	4
Thickness.....	5
Depth.....	5
Outset.....	5
Select Outer.....	5
Individual.....	5
Interpolate.....	5
Poke Faces.....	5
Last Operator Poke Faces.....	5
Poke Offset.....	5
Offset Relative.....	5
Poke Center.....	5
Triangulate Faces.....	6
Last Operator Triangulate Faces.....	6
Quad Method.....	6
Shortest diagonal.....	6

Fixed Alternate.....	6
Fixed.....	6
Beauty.....	6
Polygon Method.....	6
Clip.....	6
Beauty.....	6
Tris to Quads.....	6
Last Operator Tris to Quads.....	6
Max Face Angle.....	6
Max Shape Angle.....	6
Compare UV's.....	6
Compare VCols.....	7
Compare Seam.....	7
Compare Sharp.....	7
Compare Materials.....	7
Solidify Faces.....	7
Last Operator Solidify.....	7
Thickness.....	7
Wire Frame.....	7
Last Operator Wire Frame.....	7
Boundary.....	7
Offset Even.....	7
Offset Relative.....	7
Replace.....	7
Thickness.....	8
Offset.....	8
Crease.....	8
Crease Weight.....	8
Fill.....	8
Last Operator Fill.....	8
Beauty.....	8
Grid Fill.....	8
Last Operator Grid Fill.....	8
Span.....	8
Offset.....	8
Simple Blending.....	8
Beautify Faces.....	9
Last Operator Beautify Faces.....	9
Max Angle.....	9
Intersect (Knife).....	9
Last Operator Intersect.....	9
Source.....	9
Separate Mode.....	9
Merge Threshold.....	9
Intersect (Boolean).....	10
Last Operator Intersect (Boolean).....	10
Boolean.....	10
Swap.....	10
Merge Threshold.....	10
Weld Edges into Faces.....	11
Face Data.....	11
Rotate Colors.....	11
Last Operator Rotate Colors.....	11

Counter Clockwise.....	11
Reverse Colors.....	11
Rotate UV's.....	12
Last Operator Rotate UV's.....	12
Reverse UV's.....	12
Mark Freestyle Face.....	12
Clear Freestyle Face.....	12

Edit Mode - Faces menu

The faces menu is just visible for Mesh objects. It provides tools to work with faces.

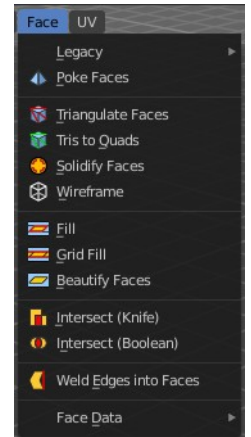

Legacy

The legacy sub menu contains tools that exists in the tool shelf already.

It's the old way to do things. Different to the tools in the tool shelf, these tools are usually modal. And performs once. You have to call them again in case you want to repeat the tool.



Inset Faces

Inset insets edges into the selected faces. Think of it as an extrude inwards the face.

Activate the tool, drag the mouse. But carefully. The control is not the best. You better adjust the amount in the last operator.

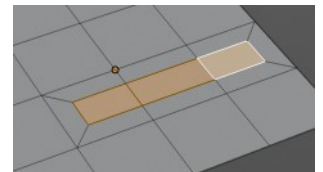

Last Operator Inset Faces

Boundary

With Boundary ticked you will get the connect edges in the corners. Without the edges ends straight.

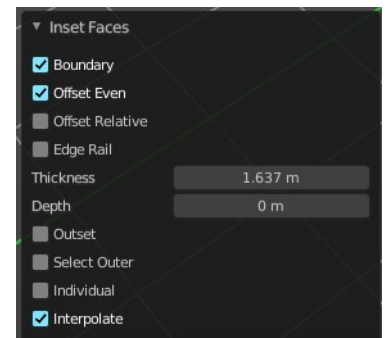
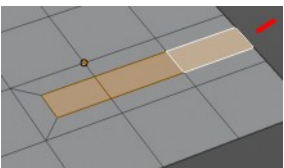

Offset Even

Scales the offset to give more even thickness.

Offset Relative

Scales the offset by surrounding geometry.

Edge Rail

Inset the region along existing edges.

Thickness

Thickness adjusts the thickness of the inset geometry.

Depth

With depth you can bevel the inset geometry. It is then not longer co planar to the initial face.

Outset

With outset ticked the Inset will not extrude inwards but outwards.

Select Outer

With Select Outer the outer ring will be selected after the Inset.

Individual

Inset every face individually.

Interpolate

Blend Face Data across the inset.

Poke Faces

Splits the selected faces to create a triangulated geometry.

Last Operator Poke Faces

Poke Offset

Normally the center vertice of the poke operation is planar with the rest. Adjust an offset.

Offset Relative

Scale the offset by surrounding geometry.

Poke Center

Poke Center is a drop-down box choose what the center of the poke operation should be. You can choose between weighted mean, mean and bounds.

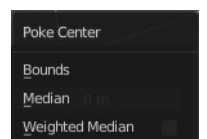
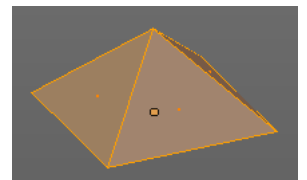
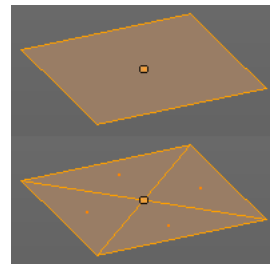

Triangulate Faces

Triangulate Faces triangulates the faces of the selected geometry.

Last Operator Triangulate Faces

Quad Method

Choose how quads should be triangulated.

Shortest diagonal

Splits the quads based on their distance between vertices.

Fixed Alternate

Splits the quads on the second and fourth vertice.

Fixed

Splits the quads on the first and third vertice.

Beauty

Tries to optimize the triangulation.

Polygon Method

Choose how N-Gons should be triangulated.

Clip

Splits the polygons with an ear clipping algorithm.

Beauty

Tries to optimize the triangulation.

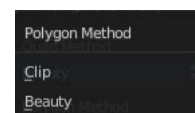
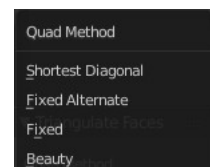
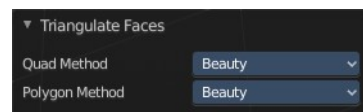
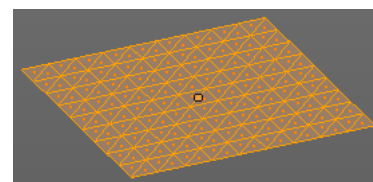

Tris to Quads

Tris to quads tries to convert triangulated geometry back to a quad geometry by removing the edges inside of the quads.

Last Operator Tris to Quads

Max Face Angle

Adjust the threshold to adjacent triangles.

Max Shape Angle

Adjust the shape angle limit.

Compare UV's

Takes the UV patches for the calculation into account. Border geometry will not be calculated.

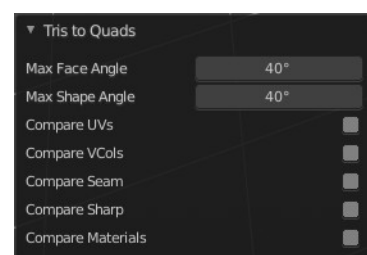
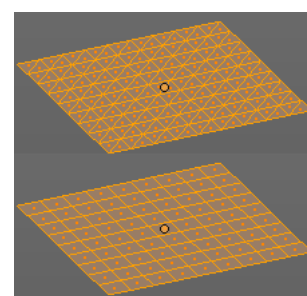

Compare VCols

Takes the Vertex colors for the calculation into account. Border geometry will not be calculated.

Compare Seam

Takes the Vertex colors for the calculation into account. Border geometry will not be calculated.

Compare Sharp

Takes the as sharp marked edges for the calculation into account. Border geometry will not be calculated.

Compare Materials

Takes the Materials colors for the calculation into account. Border geometry will not be calculated.

Solidify Faces

Gives the selected faces a thickness, and makes it solid.

There is also a Solidify modifier available.

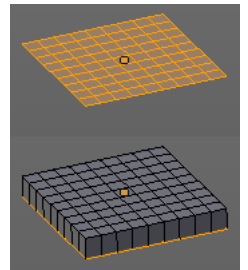

Last Operator Solidify

Thickness

Adjust the thickness. You can scale also into the negative range.



Wire Frame

Wire frame grabs the edges of the faces and turns them into tubes.

Last Operator Wire Frame

Boundary

Inset Face Boundaries.

Offset Even

Scales the offset to give more even thickness.

Offset Relative

Scales the offset by surrounding geometry.

Replace

Removes the source geometry.

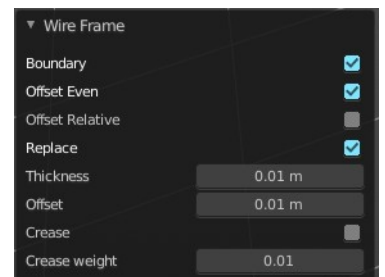
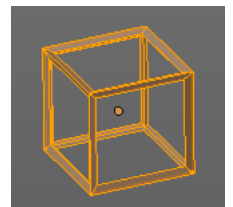

Thickness

Adjust the thickness of the tubes.

Offset

Adjust the offset of the tubes.

Crease

Crease adds close edges so that you have sharp corners when you use Subdivision Surface.

Crease Weight

Adjust the crease weight.

Fill

Fill closes holes in the selected mesh geometry, and triangulates the faces.

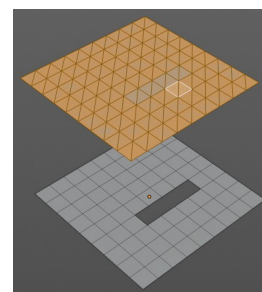

Last Operator Fill

Beauty

Uses the best possible triangulation.



Grid Fill

Grid Fill allows you to fill two edge loops with quad geometry that follows the surrounding geometry.

Usage: select two opposite edge loops. Then perform the tool.

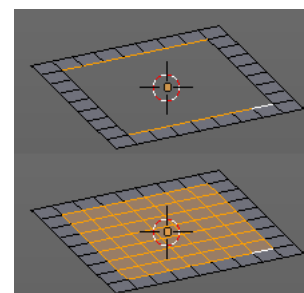

Last Operator Grid Fill

Span

Number of sides.

Offset

Define an offset

Simple Blending

Uses a simple interpolation. Faster but less accurate.

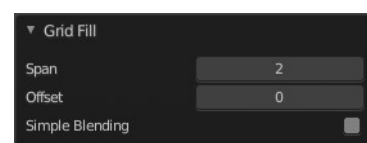

Beautify Faces

Beautify faces tries to optimize triangulation.



Last Operator Beautify Faces

Max Angle

Set an angle limit.



Intersect (Knife)

Intersect creates edges where geometry intersects.

This operation happens in Edit mode, and so all parts must be in the same mesh.

Last Operator Intersect

Source

Source is a drop-down box choose at which mesh part you want to operate.

Selected/Unselected works between the selected and unselected geometry.

Self Intersect works on the overlapping geometry of the mesh.

Separate Mode

Separate mode is a drop-down box choose the separation mode.

All splits the geometry at the new edge.

Cut keeps each side of the intersection separate without splitting the faces in half.

Merge merges all the geometry from the intersection.

Merge Threshold

Adjust the merge threshold. Increase it when some geometry is not calculated. But keep it small for fast calculation.

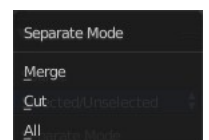
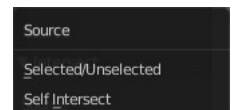
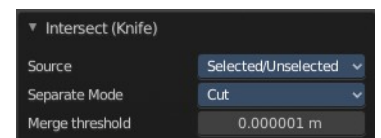
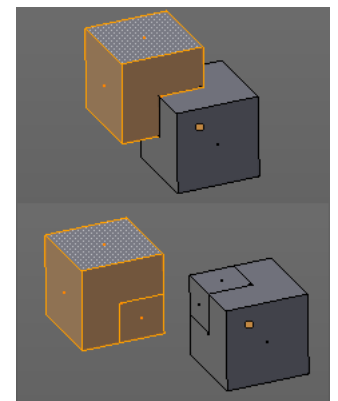

Intersect (Boolean)

Intersect (Boolean) performs a Boolean operation between the selected and unselected mesh parts.

This operation happens in Edit mode, and so all parts must be in the same mesh.

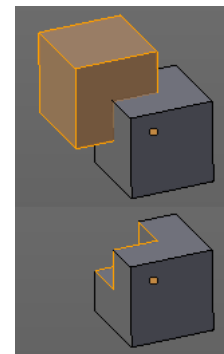

Last Operator Intersect (Boolean)

Boolean

Choose the Boolean method.

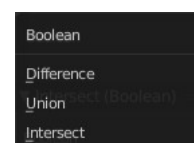
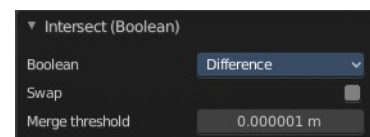

Difference subtracts the source geometry from the target geometry.

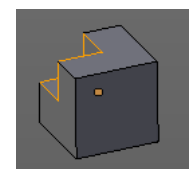

Union unions the source geometry with the target geometry. Geometry inside the source and target geometry gets removed.

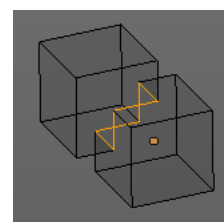

Intersect removes all geometry but the overlapping geometry.

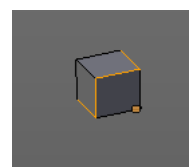

Swap

Inverts source and target geometry.

Merge Threshold

Adjust the tolerance for the Boolean operation. Increase it when some geometry is not calculated. But keep it small for fast calculation.

Weld Edges into Faces

This tool incorporates loose wire edges into selected faces.

You need a loose edge geometry to get it to work. By converting a curve to a Mesh geometry for example. You need to join the edge into the mesh where you want to use it. The operation happens in Edit mode.

In edit mode select the edge and the face where you want it to join. And then perform the tool.

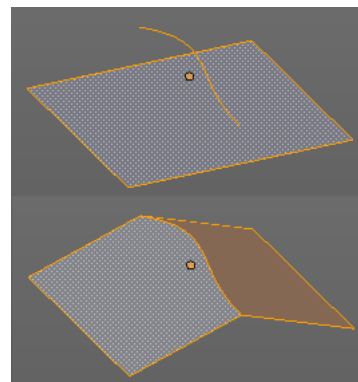

Face Data

Rotate Colors

Rotates the vertex colors for the selected geometry. This tool requires to have vertex colors painted at the mesh.

Note that there is no way to display vertex colors in Edit mode. So you need to switch to Vertex paint mode to see the result.

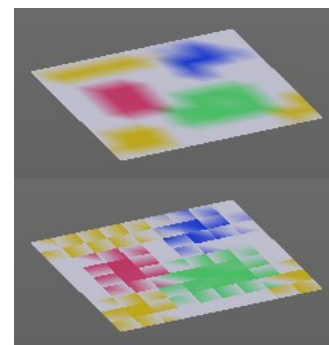
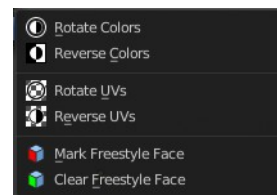

Last Operator Rotate Colors

Counter Clockwise

The tool rotates clockwise by default. With this option ticked the rotation happens counter clockwise.

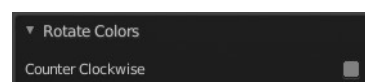

Reverse Colors

Reverses the vertex colors.

Note that there is no way to display vertex colors in Edit mode. So you need to switch to Vertex paint mode to see the result.

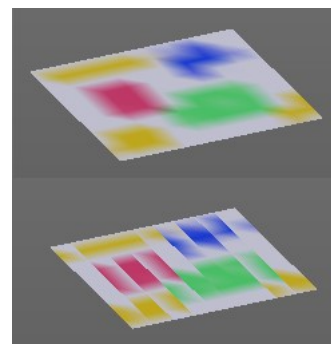

Rotate UV's

Rotates the UV space for the selected geometry by 90 degrees. This tool requires to have a working UV mapping.

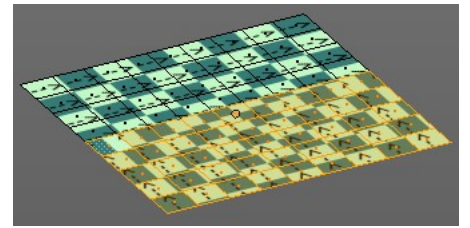

Last Operator Rotate UV's

The tool rotates clockwise by default. With this option ticked the rotation happens counter clockwise.



Reverse UV's

Reverses the UV Space for the selected geometry. This tool requires to have a working UV mapping.

Mark Freestyle Face

Mark selected Faces for exclusion from Freestyle Feature edge detection. Freestyle is a cartoon renderer that is also included in Bforartists.

Clear Freestyle Face

Unmark selected Faces for exclusion from Freestyle Feature edge detection. Freestyle is a cartoon renderer that is also included in Bforartists.
