



## 7.2.1 Editors - 3D View - Tool Shelf - Object Mode

### Table of content

Detailed table of content.....	1
Tool Shelf - Object Mode.....	7
Select Tools Group.....	7
Cursor.....	8
Move Rotate Scale Transform.....	9
Move.....	9
Rotate.....	11
Scale Tools Group.....	14
Transform.....	18
Annotate Tools group.....	18
Annotate tool.....	18
Annotate Line.....	20
Annotate Polygon.....	21
Annotate Eraser.....	23
Measure.....	23
Primitives Add tools group.....	24

### Detailed table of content

### Detailed table of content

Detailed table of content.....	1
Tool Shelf - Object Mode.....	7
Select Tools Group.....	7
Tweak.....	7
Select Box.....	7
Tool Settings.....	7
Mode.....	7
Set a new selection.....	7
Extend existing selection.....	7
Subtract existing selection.....	7
Inverts existing selection.....	7
Intersect existing selection.....	7
Select Circle.....	7
Tool Settings.....	8
Mode.....	8
Set a new selection.....	8
Extend existing selection.....	8
Subtract existing selection.....	8
Radius.....	8
Select Lasso.....	8
Tool Settings.....	8
Mode.....	8
Set a new selection.....	8
Extend existing selection.....	8

Subtract existing selection.....	8
Inverts existing selection.....	8
Intersect existing selection.....	8
Cursor.....	8
Tool Settings.....	9
Surface Project.....	9
Orientation.....	9
Move Rotate Scale Transform.....	9
Move.....	9
Snapping.....	9
Precision movement.....	9
Header Values.....	9
Numerical Input.....	10
Move without widget.....	10
Limit Axis.....	10
Tool Settings.....	10
Orientation.....	10
Last Operator Move.....	11
Move X, Y Z.....	11
Orientation.....	11
Proportional editing.....	11
Proportional Falloff.....	11
Proportional Size.....	11
Connected.....	11
Projected(2D).....	11
Rotate.....	11
Snapping.....	12
Precision rotation.....	12
Header Values.....	12
Numerical Input.....	12
Rotate without widget.....	12
Limit Axis.....	12
Tool Settings.....	13
Orientation.....	13
Last Operator Rotate.....	13
Angle.....	13
Axis.....	13
Orientation.....	13
Proportional editing.....	13
Proportional Falloff.....	13
Proportional Size.....	13
Connected.....	13
Projected(2D).....	13
Scale Tools Group.....	14
Scale.....	14
Snapping.....	14
Precision Scale.....	14
Header Values.....	14
Numerical Input.....	14
Scale without widget.....	14
Limit Axis.....	14
Tool Settings.....	15
Orientation.....	15

Last Operator Resize.....	15
Angle.....	15
Axis.....	15
Orientation.....	15
Proportional editing.....	15
Proportional Falloff.....	15
Proportional Size.....	15
Connected.....	16
Projected(2D).....	16
Scale Cage.....	16
Snapping.....	16
Header Values.....	16
Scale without widget.....	16
Limit Axis.....	16
Tool Settings.....	17
Orientation.....	17
Last Operator Resize.....	17
Angle.....	17
Axis.....	17
Orientation.....	17
Proportional editing.....	17
Proportional Falloff.....	17
Proportional Size.....	17
Connected.....	17
Projected(2D).....	17
Transform.....	18
Tool Settings.....	18
Drag Action.....	18
Orientation.....	18
Annotate Tools group.....	18
Annotate tool.....	18
Tool Settings.....	19
Color.....	19
Note.....	19
Annotations list.....	19
Edit Box.....	19
Fake User.....	19
Add Annotation.....	19
Remove Annotation.....	19
Active Layer Index.....	19
Add Annotation Layer.....	20
Remove Annotation Layer.....	20
Opacity.....	20
Thickness.....	20
Frame Locked/Unlocked.....	20
Delete Active Frame.....	20
Placement.....	20
Stabilize Stroke.....	20
Radius.....	20
Factor.....	20
Annotate Line.....	20
Tool Settings.....	20
Placement.....	21

Style Start.....	21
End.....	21
Annotate Polygon.....	21
Tool Settings.....	21
Color.....	21
Note.....	21
Annotations list.....	22
Edit Box.....	22
Fake User.....	22
Add Annotation.....	22
Remove Annotation.....	22
Active Layer Index.....	22
Add Annotation Layer.....	22
Remove Annotation Layer.....	22
Opacity.....	22
Thickness.....	22
Frame Locked/Unlocked.....	22
Delete Active Frame.....	22
Placement.....	22
Annotate Eraser.....	23
Tool Settings.....	23
Radius.....	23
Measure.....	23
Measuring angles.....	23
Snapping.....	23
Delete measure lines.....	23
Primitives Add tools group.....	24
Add Cube.....	24
Tool Settings.....	24
Depth.....	24
Position.....	24
Surface.....	25
3D Cursor Plane.....	25
3D Cursor View.....	25
Orientation.....	25
Snap To.....	25
Plane Axis.....	25
Auto Axis.....	25
Base.....	25
Origin.....	25
Aspect.....	25
Height.....	25
Origin.....	25
Aspect.....	25
Last Operator Add Cube Panel.....	25
Add Cone.....	26
Tool Settings.....	26
Depth.....	26
Position.....	26
Surface.....	26
3D Cursor Plane.....	26
3D Cursor View.....	26
Orientation.....	26

Snap To.....	26
Plane Axis.....	26
Auto Axis.....	26
Base.....	26
Origin.....	26
Aspect.....	26
Height.....	27
Origin.....	27
Aspect.....	27
Vertices.....	27
Base Fill Type.....	27
Last Operator Add Cone Panel.....	27
Add Cylinder.....	27
Tool Settings.....	27
Depth.....	28
Position.....	28
Surface.....	28
3D Cursor Plane.....	28
3D Cursor View.....	28
Orientation.....	28
Snap To.....	28
Plane Axis.....	28
Auto Axis.....	28
Base.....	28
Origin.....	28
Aspect.....	28
Height.....	28
Origin.....	28
Aspect.....	28
Vertices.....	28
Last Operator Add Circle Panel.....	29
Add UV Sphere.....	29
Tool Settings.....	29
Depth.....	29
Position.....	29
Surface.....	30
3D Cursor Plane.....	30
3D Cursor View.....	30
Orientation.....	30
Snap To.....	30
Plane Axis.....	30
Auto Axis.....	30
Base.....	30
Origin.....	30
Aspect.....	30
Height.....	30
Origin.....	30
Aspect.....	30
Segments.....	30
Rings.....	30
Last Operator Add UV Sphere Panel.....	30
Add Icosphere.....	31
Tool Settings.....	31

Depth.....	31
Position.....	31
Surface.....	31
3D Cursor Plane.....	31
3D Cursor View.....	31
Orientation.....	31
Snap To.....	31
Plane Axis.....	31
Auto Axis.....	31
Base.....	32
Origin.....	32
Aspect.....	32
Height.....	32
Origin.....	32
Aspect.....	32
Subdivisions.....	32
Last Operator Add Ico Sphere Panel.....	32

## Tool Shelf - Object Mode

In Object mode you will see mainly the general select and transform tools.

Those tools will also appear in other modes like Edit mode. We will not cover it again there.



## Select Tools Group

Tools with a triangle down right are a group of tools. Click and hold to reveal the content. Then choose the tool that you need.

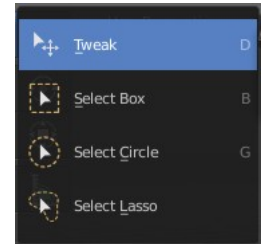

### Tweak

Allows you to select or tweak single elements by clicking at it.

### Select Box

Draws a box to select several elements at once. Click at the start point, then drag.

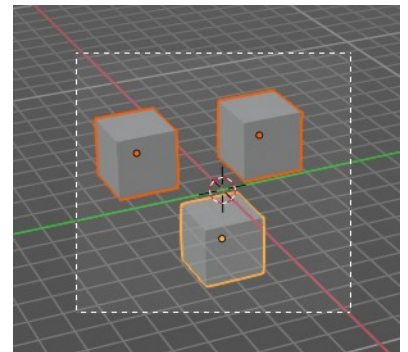

### Tool Settings

#### Mode

The available selection modes. The mode titles are pretty self explaining. So i won't go into detail here.

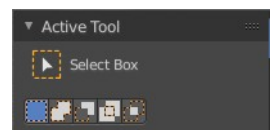

***Set a new selection***

***Extend existing selection***

***Subtract existing selection***

***Inverts existing selection***

***Intersect existing selection***

### Select Circle

Draws a box to select several elements at once. Click at the start point, then drag.

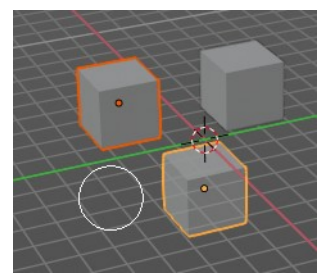

## Tool Settings

### Mode

The available selection modes. The mode titles are pretty self explaining. So i won't go into detail here.



***Set a new selection***

***Extend existing selection***

***Subtract existing selection***

### Radius

The brush radius.

## Select Lasso

Draws a box to select several elements at once. Click at the start point, then drag.

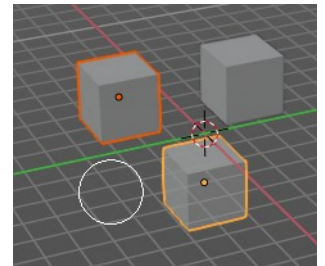

## Tool Settings

### Mode

The available selection modes. The mode titles are pretty self explaining. So i won't go into detail here.

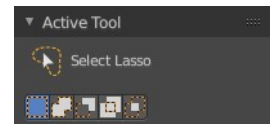

***Set a new selection***

***Extend existing selection***

***Subtract existing selection***

***Inverts existing selection***

***Intersect existing selection***

## Cursor

The cursor tool allows you to move the 3d cursor around.





## Tool Settings

### Surface Project

Project the 3D cursor onto the surface.

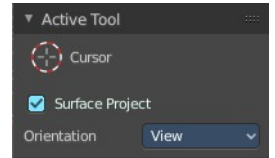

### Orientation

The 3d cursor can have different orientations. The menu items should be self explaining.

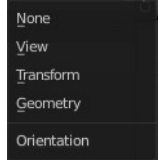

# Move Rotate Scale Transform

The transformation tools

## Move

Activates the move tool. Activating the move tool also reveals a move widget at the object. This widget allows you to move the object around, by using the corresponding axis.

When you click at one of the square buttons at the icon, then you can move the object along the plane of the two adjacent axis. The rectangle buttons between the arrows allows you to move in direction of the blue and green arrows. This can also be done by clicking at the tip of the arrow and holding down shift. Then you can move the cube along the two other axis.

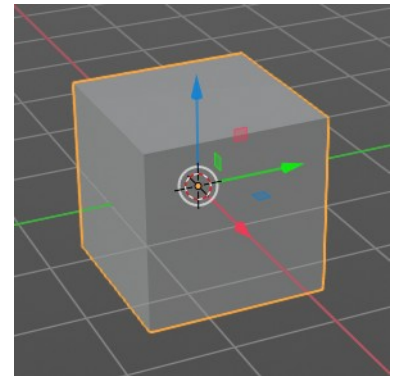

## Snapping

Holding down Ctrl activates temporary global snapping.

### Precision movement

When you hold down shift, then you will have a much slower but also much preciser movement.

## Header Values

When you move your object then you will see some values in the header, which defines the current position of the object.

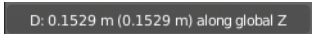

The value m stands for the default metric system. Meters. You can change the units in the Properties editor in the Scene properties in the Units panel. When you choose kilometers here then you will see a km instead m.

The value D stands for the distance of the current selected axis. This can also be two axis. Then you have two d values. The value in the brackets is then the direct distance to the starting point.

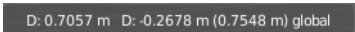

These values are always relative to the starting point. You always start with zero, regardless of the real world position.

## Numerical Input

When you move the object, and hold down the mouse and type in a value, like 20, then the movement will be performed by the value that you have typed in. In this case by 20 units in direction of the selected axis.

## Move without widget

You don't have to use the widget to move the object. You can also click aside of it, and drag the object around. The mouse turns into a move cursor. The standard behavior then is to move in screen space. When you want to move into a specific axis, then press X or Y or Z to limit the movement to this axis.

## Limit Axis

When you want to rotate a specific axis, then press X or Y or Z to limit the rotation to this axis. You usually start in global orientation. But you can change this in the Orientation settings.

D: 0.1529 m (0.1529 m) along global Z

By holding down the mouse button and pressing the X, Y or Z key twice you can toggle this to local. But also to other orientations. This depends in what orientation you start. With normal you can toggle that way between Normal and global.

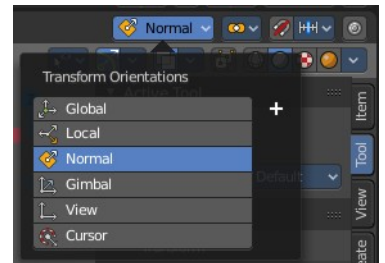

This can be combined with the numerical input. Type in X, type in X again to use the local space, type in 20 to move by 20 units in local orientation. Release the mouse to confirm.

## Tool Settings

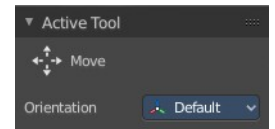

## Orientation

The widget can have different orientations. The menu items should be self explaining.

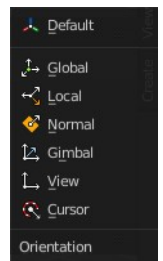

## Last Operator Move

### Move X, Y Z

The position. Attention, the actual world orientation and rotation does not matter here. It always starts with a value of zero, and moves relative to this zero then. For the actual location values have a look in the sidebar in the transform panel.

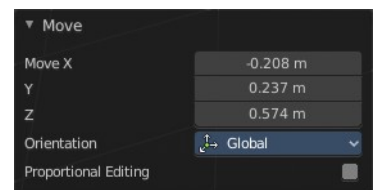

## Orientation

The widget can have different orientations. The menu items should be self explaining.

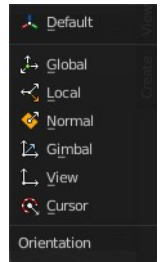

## Proportional editing

Enables proportional editing. Activating proportional editing reveals further settings.

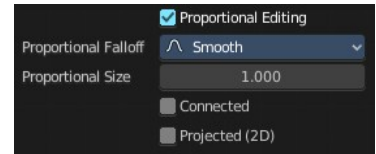

### Proportional Falloff

Adjust the falloff methods.

### Proportional Size

See and adjust the falloff radius.

### Connected

The proportional falloff gets calculated for connected parts only.

### Projected(2D)

The proportional falloff gets calculated in the screen space. Depth doesn't play a role. When it's in the radius, then it gets calculated.

---

## Rotate

Activates the Rotate tool. Activating the move tool also reveals a rotate widget at the object. This widget allows you to rotate the object, by using the corresponding axis.

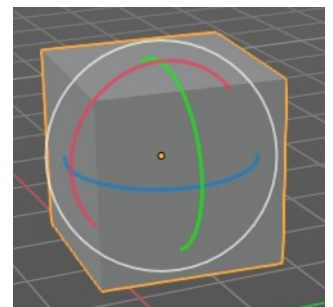

## Snapping

Holding down Ctrl activates temporary global snapping. It snaps then by 5 degrees steps.

When you use the white circle to rotate, then the widget also shows a division circle around the widget. This divisions shows even finer when you do precision rotation.

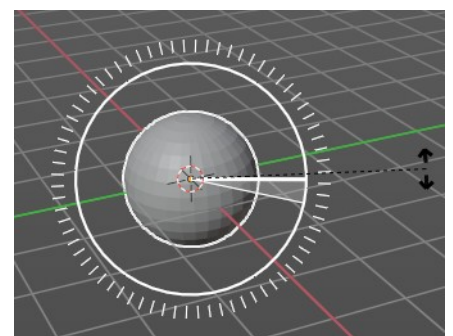

## Precision rotation

When you hold down shift, then you will have a much slower but also much preciser rotation.

## Header Values

When you rotate your object then you will see some values in the header, which defines the current rotation of the object. The rotation is shown in degrees.

Rot: -3.57 global

## Numerical Input

When you rotate the object, and hold down the mouse and type in a value, like 20, then the rotation will be performed by the value that you have typed in. In this case by 20 degree around the selected axis.

## Rotate without widget

You don't have to use the widget to rotate the object. You can also click asides and drag the object around. A black arrow will appear. The standard behavior then is to rotate in viewport orientation.

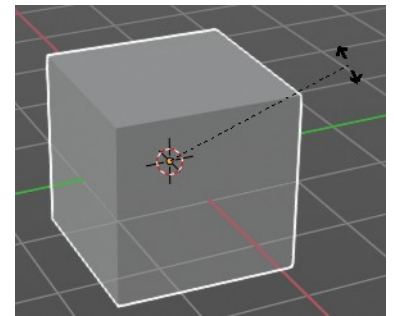

## Limit Axis

When you want to rotate a specific axis, then press X or Y or Z to limit the rotation to this axis. You usually start in global orientation. But you can change this in the Orientation settings.

Rot: -0.08 along normal X

By holding down the mouse button and pressing the X, Y or Z key twice you can toggle this to local. But also to other orientations. This depends in what orientation you start. With normal you can toggle that way between Normal and Global.

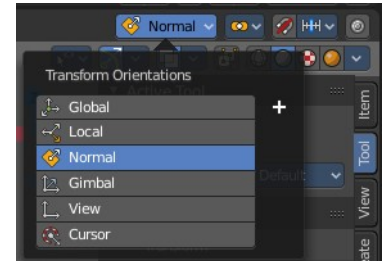

This can be combined with the numerical input. Type in X, type in X again to use the local space, type in 20 to rotate by 20 degree. Release the mouse to confirm.

## Tool Settings

## Orientation

The 3d cursor can have different orientations. The menu items should be self explaining.

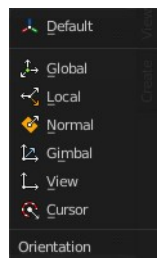
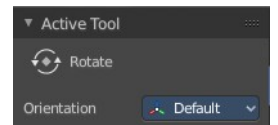

## Last Operator Rotate

### Angle

The rotation. Attention, the actual world orientation and rotation does not matter here. It always starts with a value of zero, and rotates relative to this zero then. For the actual rotation values have a look in the sidebar in the transform panel.

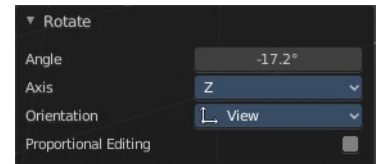

### Axis

Which axis to rotate.

### Orientation

The widget can have different orientations. The menu items should be self explaining.

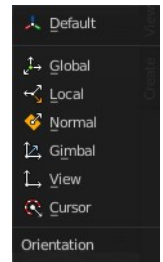

### Proportional editing

Enables proportional editing. Activating proportional editing reveals further settings.

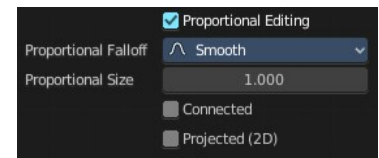

### Proportional Falloff

Adjust the falloff methods.

### Proportional Size

See and adjust the falloff radius.

### Connected

The proportional falloff gets calculated for connected parts only.

### Projected(2D)

The proportional falloff gets calculated in the screen space. Depth doesn't play a role. When it's in the radius, then it gets calculated.

---

## Scale Tools Group

You can use two scale tools with different widget styles.

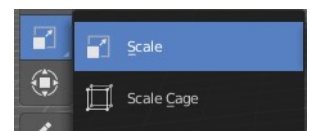

## Scale

Activates the Scale tool. Activating the scale tool also reveals a traditional scale widget at the object. This widget allows you to scale the object, by using the corresponding axis. When you click at the outer white circle and drag, then you can scale the object uniformly.

The rectangle buttons between the arrows allows you to scale in direction of the adjacent arrows. This can also be done by clicking at the tip of the arrow and holding down shift. Then you can scale the cube along the two other axis.

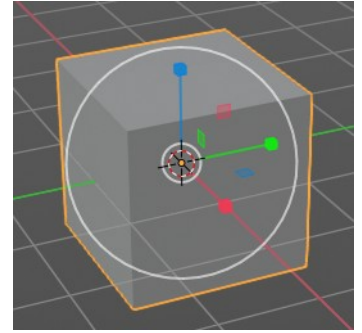

## Snapping

Holding down Ctrl activates temporary global snapping.

## Precision Scale

When you hold down shift, then you will have a much slower but also much preciser scale.

## Header Values

When you scale your object then you will see some values in the header, which defines the current scale of the object.

Scale: 1.1996 global

These values are always relative to the starting point. You always start with 1, regardless of the real world scale.

## Numerical Input

When you scale the object, and hold down the mouse and type in a value, like 20, then the scale will be performed by the value that you have typed in. In this case by factor 20 along the selected axis.

## Scale without widget

You don't have to use the widget to scale the object. You can also click asides and drag the object around. A black arrow will appear. The standard behavior then is to scale uniformly. When you want to scale into a specific axis, then press X or Y or Z to limit the scale to this axis.

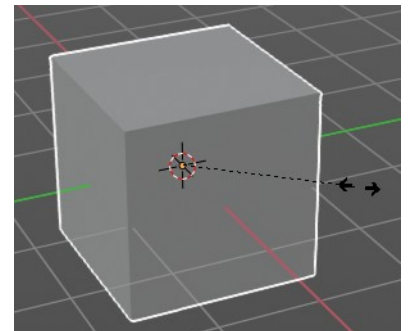

## Limit Axis

When you want to rotate a specific axis, then press X or Y or Z to limit the scale to this axis. You usually start in global orientation. But you can change this in the Orientation settings.

Rot: -0.08 along normal X

By holding down the mouse button and pressing the X, Y or Z key twice you can toggle this to local. But also to other orientations. This depends in what orientation you start. With normal you can toggle that way between Normal and Global.

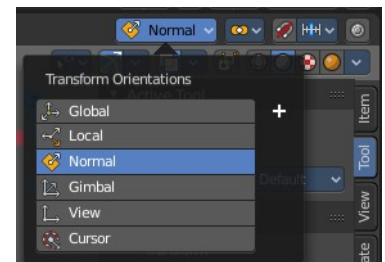

This can be combined with the numerical input. Hold down mouse, type in X, type in X again to use the local space, type in 20 to scale by 20 units. Release the mouse to confirm.

## Tool Settings

### Orientation

The 3d cursor can have different orientations. The menu items should be self explaining.

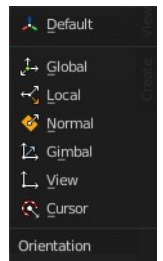
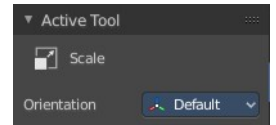

## Last Operator Resize

### Angle

The rotation. Attention, the actual world orientation and rotation does not matter here. It always starts with a value of zero, and rotates relative to this zero then. For the actual rotation values have a look in the sidebar in the transform panel.

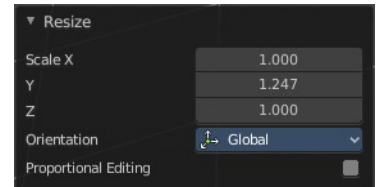

### Axis

Which axis to rotate.

### Orientation

The widget can have different orientations. The menu items should be self explaining.

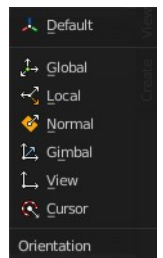

## Proportional editing

Enables proportional editing. Activating proportional editing reveals further settings.

### Proportional Falloff

Adjust the falloff methods.

### Proportional Size

See and adjust the falloff radius.

### Connected

The proportional falloff gets calculated for connected parts only.

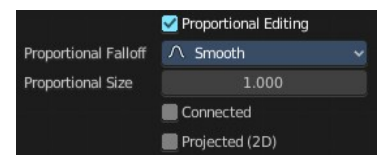

## **Projected(2D)**

The proportional falloff gets calculated in the screen space. Depth doesn't play a role. When it's in the radius, then it gets calculated.

## **Scale Cage**

Activates the Scale tool. Activating the scale tool also reveals a scale widget in cage style at the object. This widget allows you to scale the object by clicking at the white handler points and drag them in the desired direction.

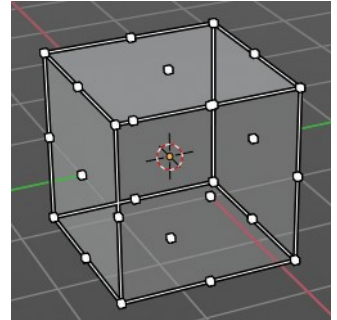

## **Snapping**

Holding down Ctrl activates temporary global snapping.

## **Header Values**

When you scale your object then you will see some values in the header, which defines the current scale of the object.

These values are always relative to the starting point. You always start with 1, regardless of the real world scale.

## **Scale without widget**

You don't have to use the widget to scale the object. You can also click asides and drag the object around. A black arrow will appear. The standard behavior then is to scale uniformly. When you want to scale into a specific axis, then press X or Y or Z to limit the scale to this axis.

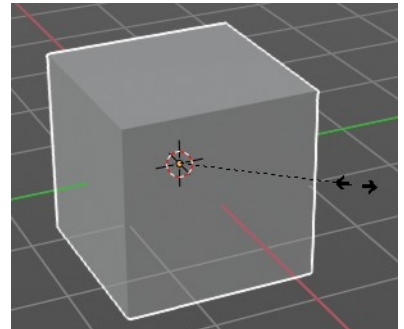

## **Limit Axis**

When you want to rotate a specific axis, then press X or Y or Z to limit the rotation to this axis. You usually start in global orientation. But you can change this in the Orientation settings.

By holding down the mouse button and pressing the X, Y or Z key twice you can toggle this to local. But also to other orientations. This depends in what orientation you start. With normal you can toggle that way between Normal and Global.

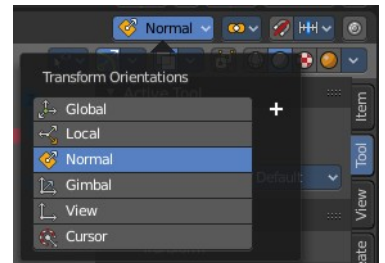

## **Tool Settings**

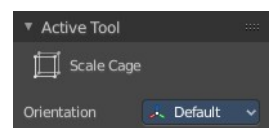



## Orientation

The 3d cursor can have different orientations. The menu items should be self explaining.

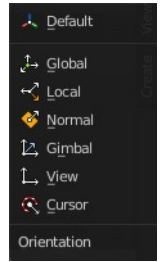

## Last Operator Resize

### Angle

The rotation. Attention, the actual world orientation and rotation does not matter here. It always starts with a value of zero, and rotates relative to this zero then. For the actual rotation values have a look in the sidebar in the transform panel.

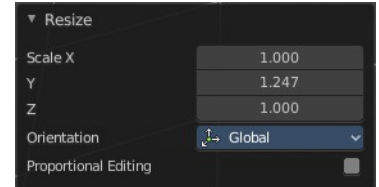

### Axis

Which axis to rotate.

## Orientation

The widget can have different orientations. The menu items should be self explaining.

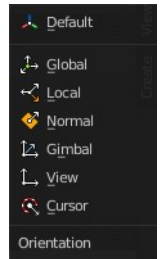

## Proportional editing

Enables proportional editing. Activating proportional editing reveals further settings.

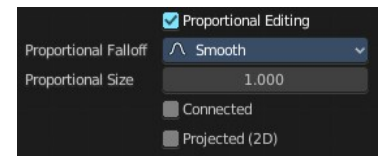

### Proportional Falloff

Adjust the falloff methods.

### Proportional Size

See and adjust the falloff radius.

### Connected

The proportional falloff gets calculated for connected parts only.

### Projected(2D)

The proportional falloff gets calculated in the screen space. Depth doesn't play a role. When it's in the radius, then it gets calculated.

## Transform

Transform reveals a multi transform widget with all three transform methods available at once. Move, Rotate and Scale.

The rules are the same than for the single tools, and also the last operators. Dependent of which widget part you pull here. So i won't go into detail again here.

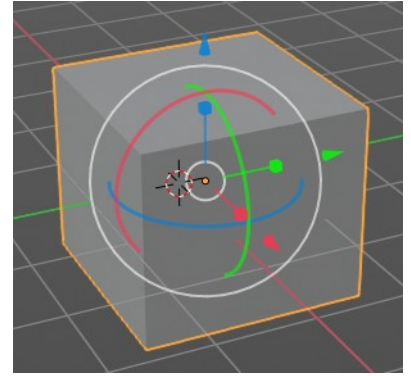

## Tool Settings

### Drag Action

Define what kind of transform should happen when you click not at the widget but besides, and drag the mouse.

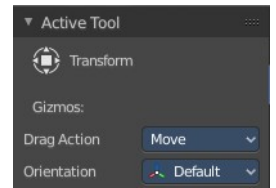

### Orientation

The 3d cursor can have different orientations. The menu items should be self explaining.



## Annotate Tools group

The annotation tool is available in multiple editors. With this tool you can write notes at the screen. The annotate tools is the little brother of the grease pencil objects.

Further settings for annotate can be found in the sidebar. Here you can also remove an annotation when you don't longer need it. And here you can also adjust the size of the stroke.

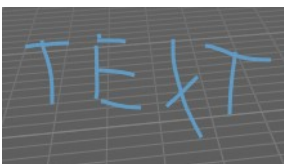
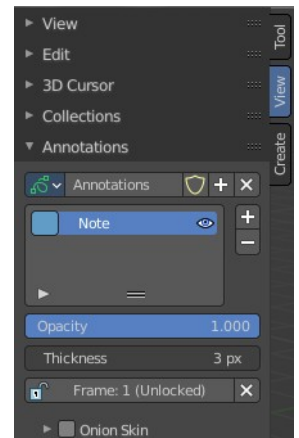
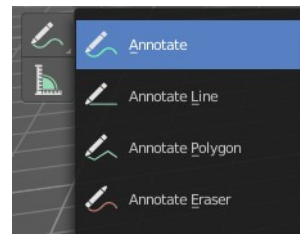

## Annotate tool

Draw free-hand strokes in the main window.

## Tool Settings

The tool settings for the Annotate tool.

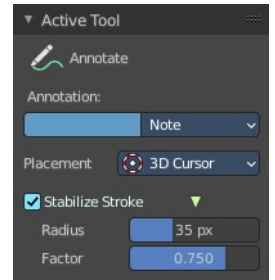

## Color

Clicking at the left color field reveals a color picker. Define the color for the annotation stroke.



## Note

Clicking at the Note drop down box reveals a panel with further settings. It's the same content than in the annotations in the View tab.

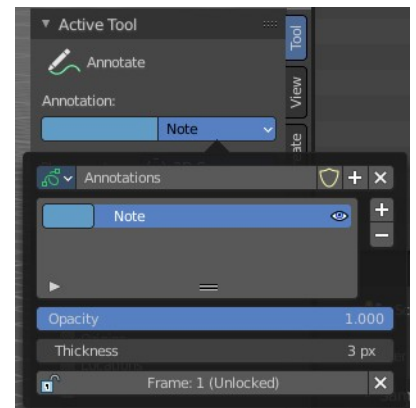

## Annotations list

Add, remove and rename new annotations.

## Edit Box

The name of the current annotation. You can rename the annotation to your needs here.

## Fake User

Assign a fake user to this annotation. Fake users is an odd concept to keep data in the scene even if it has no user somewhere. The fake user is then a dummy user so that the object is not deleted when saving the scene.

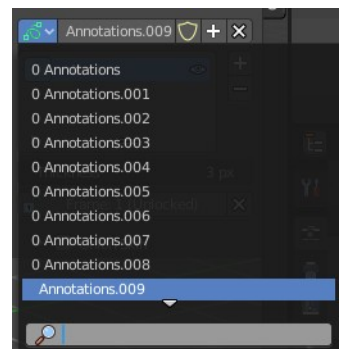

## Add Annotation

Add a new annotation.

## Remove Annotation

Delete the annotation.

## Active Layer Index

The list of annotation layers.



## Add Annotation Layer

Add a new annotation layer.

## Remove Annotation Layer

Remove the selected annotation layer.

## Opacity

The opacity of the stroke.

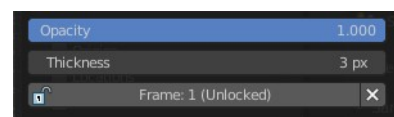

## Thickness

The thickness of the annotation stroke.

## Frame Locked/Unlocked

Lock frame displayed by current layer. This toggles whether the active layer is the only one that can be edited.

## Delete Active Frame

Deletes the active frame from the active grease pencil layer.

---

## Placement

Define how annotation strokes are aligned in the 3d space.

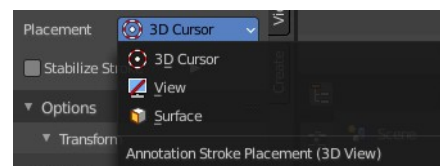

---

## Stabilize Stroke

Helper to draw smooth and clean lines. Pressing shift inverts the effect.

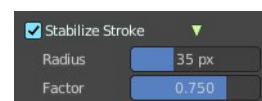

## Radius

The radius for the stroke stabilization.

## Factor

Stabilizer stroke factor. Higher values gives a smoother stroke.

---

## Annotate Line

Click and drag to create a line.

## Tool Settings

The tool settings for the Annotate tool.

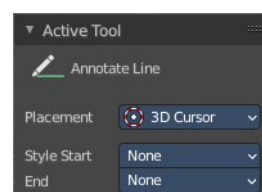

## Placement

Define how annotation strokes are aligned in the 3d space.

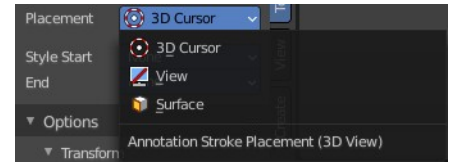

## Style Start

The stroke start style. With an arrow for example you place an arrow at the start of the stroke.



## End

The stroke end style. With an arrow for example you place an arrow at the end of the stroke.

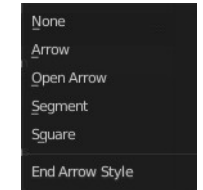

## Annotate Polygon

Click multiple times to create multiple connected lines. The current polygon is finished when Esc or RMB is pressed.

## Tool Settings

The tool settings for AnnotatePolygon.

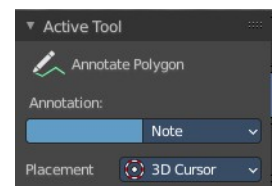

## Color

Clicking at the left color field reveals a color picker. Define the color for the annotation stroke.



## Note

Clicking at the Note drop down box reveals a panel with further settings. It's the same content than in the annotations in the View tab.

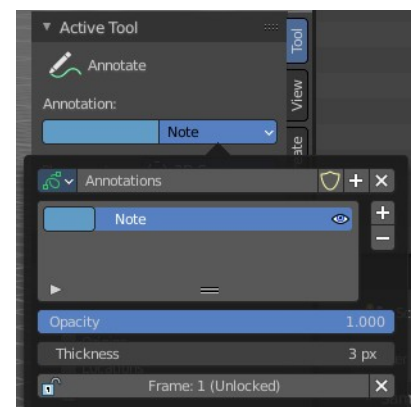

## Annotations list

Add, remove and rename new annotations.

## Edit Box

The name of the current annotation. You can rename the annotation to your needs here.

## Fake User

Assign a fake user to this annotation. Fake users is an odd concept to keep data in the scene even if it has no user somewhere. The fake user is then a dummy user so that the object is not deleted when saving the scene.

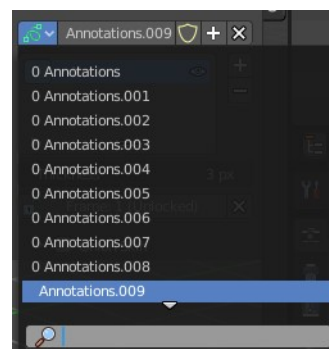

## Add Annotation

Add a new annotation.

## Remove Annotation

Delete the annotation.

## Active Layer Index

The list of annotation layers.



## Add Annotation Layer

Add a new annotation layer.

## Remove Annotation Layer

Remove the selected annotation layer.

## Opacity

The opacity of the stroke.

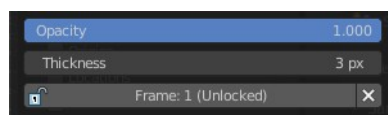

## Thickness

The thickness of the annotation stroke.

## Frame Locked/Unlocked

Lock frame displayed by current layer. This toggles whether the active layer is the only one that can be edited.

## Delete Active Frame

Deletes the active frame from the active grease pencil layer.

---

## Placement

Define how annotation strokes are aligned in the 3d space.

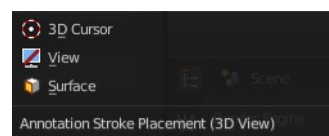

## Annotate Eraser

Click and drag to remove annotate lines.

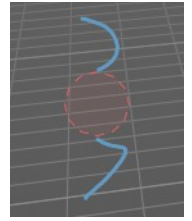

### Tool Settings

#### Radius

The radius of the eraser pencil.

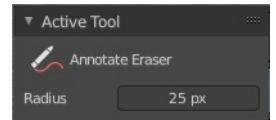

## Measure

Measure allows you to draw measure lines into the view.

The measure tool has a few options, which are described in the tool tip.

New measure lines gets created by left clicking and dragging.

When you change the tool then the measure lines becomes visible. But they are not removed. When you activate the measure tool then they reappear.

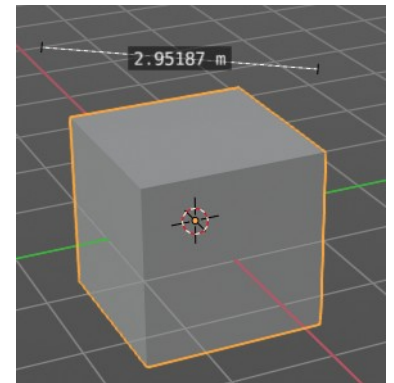
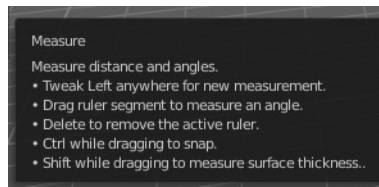

### Measuring angles

When you want to measure an angle, first create a straight measure line. Then grab it in the middle to drag out a new point at the line. Then align everything proper.

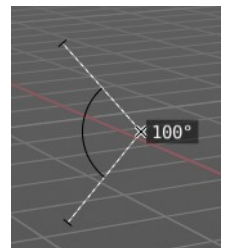

### Snapping

Holding down Ctrl activates temporary global snapping.

### Delete measure lines

Select them and press delete. When you have selected an angle point then first this angle point gets deleted. You need to have to select an endpoint to make the whole stroke active.

## Primitives Add tools group

This tools allows you to create primitives by dragging with the mouse. First you create a ground plane by dragging a rectangle. Then you release the mouse and drag the mouse upwards to create the third dimension of it. And a left click makes the object real then.

You can choose between five primitive types. Cube, Cone, Cylinder, UV Sphere and Icosphere.

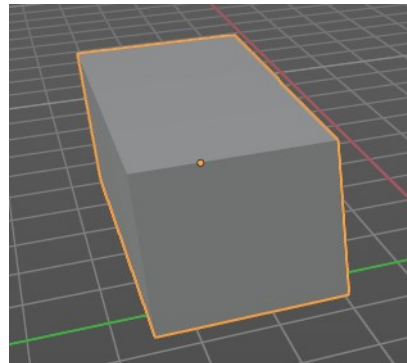
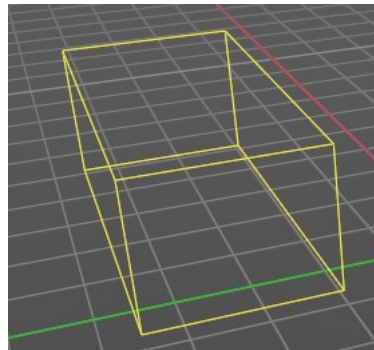
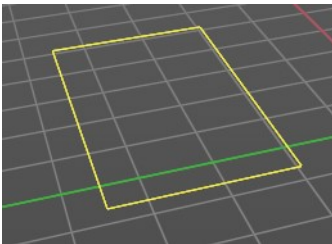
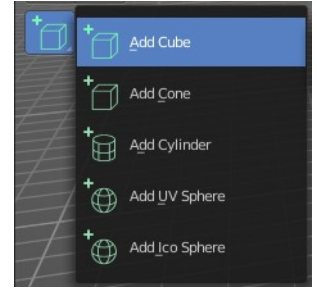

By default the ground plane starts to scale from one of the edges.

Holding down ALT key while dragging scales from the center instead of the default corner.

Holding down Shift key while dragging allows you to scale uniformly.

Holding down CTRL while dragging snaps to other objects.

### Add Cube

Adds a cube primitive.

### Tool Settings

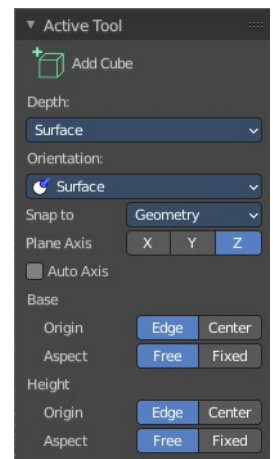

### Depth

#### Position

How to position the primitive.

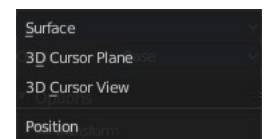



## Surface

Start placing on the surface. The 3d cursor acts as a fallback.

## 3D Cursor Plane

Start placement using a point that is projected at the selected axis at the 3d cursor position

## 3D Cursor View

Start placement using the mouse cursor projected onto the view plane.

## Orientation

In which orientation the new object to create.

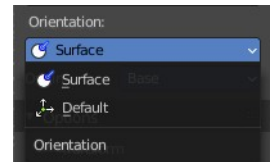

## Snap To

The target for snapping. Geometry snaps to existing mesh geometry. Default snaps to the ground.

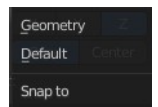

## Plane Axis

What plane axis to use.

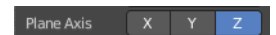

## Auto Axis

Select the closest axis when placing objects. Surface overrides.

## Base

### Origin

From where to scale the primitive. From one of its corners or from the center.

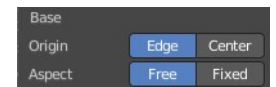

### Aspect

Scale uniformly or in drag direction.

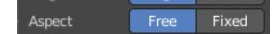

## Height

### Origin

From where to scale the primitive. From one of its corners or from the center.

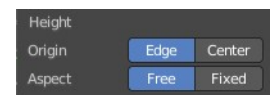

### Aspect

Scale uniformly or in drag direction.



## Last Operator Add Cube Panel

Size is in real the size of the Cube.

**Generate UV's** creates UV's for this primitive.

**Align to view** aligns the geometry to the chosen view. World, View or 3D cursor.

**Location** defines the location of the Cube.

**Rotation** defines the rotation of the Cube.

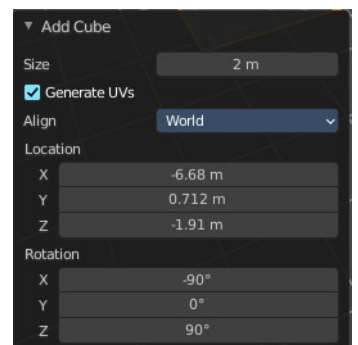

## Add Cone

Adds a cone primitive.

### Tool Settings

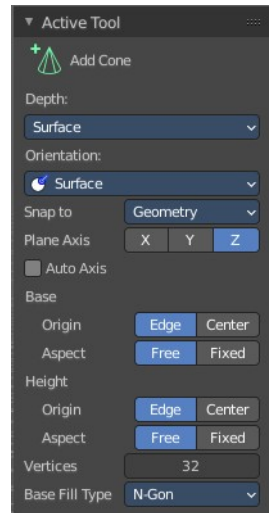

### Depth

### Position

How to position the primitive.

### Surface

Start placing on the surface. The 3d cursor acts as a fallback.

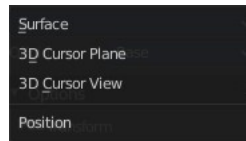

### 3D Cursor Plane

Start placement using a point that is projected at the selected axis at the 3d cursor position

### 3D Cursor View

Start placement using the mouse cursor projected onto the view plane.

### Orientation

In which orientation the new object to create.

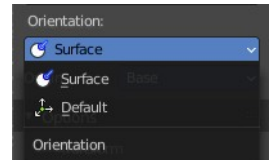

### Snap To

The target for snapping. Geometry snaps to existing mesh geometry. Default snaps to the ground.

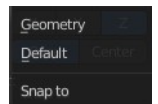

### Plane Axis

What plane axis to use.



### Auto Axis

Select the closest axis when placing objects. Surface overrides.

### Base

### Origin

From where to scale the primitive. From one of its corners or from the center.

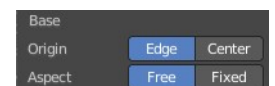

### Aspect

Scale uniformly or in drag direction.

## Height

### Origin

From where to scale the primitive. From one of its corners or from the center.

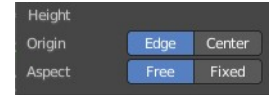

### Aspect

Scale uniformly or in drag direction.

### Vertices

The number of vertices for the cone ground plane.

### Base Fill Type

Defines how the Base face is filled.

Nothing means you have no base face.

N-Gon means that the base face is an N-Gon face.

Triangle Fan means that the base face is triangulated.

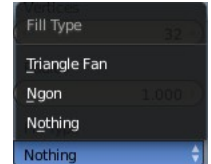

## Last Operator Add Cone Panel

**Vertices** defines of how much vertices the circle is made.

**Radius 1** defines the base radius of the Cone.

**Radius 2** defines the top radius of the Cone.

**Depth** defines the length of the Cone.

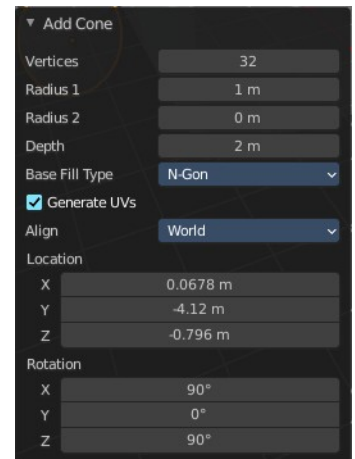

**Base Fill Type** defines how the Base face is filled.

- Nothing means you have no base face.
- N-Gon means that the base face is an N-Gon face.
- Triangle Fan means that the base face is triangulated.

**Generate UV's** creates UV's for this primitive.

**Align to view** aligns the geometry to the chosen view. World, View or 3D cursor.

**Location** defines the location of the Cone.

**Rotation** defines the rotation of the Cone.

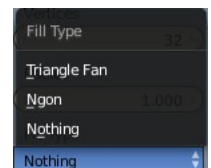

## Add Cylinder

Adds a cylinder primitive.

### Tool Settings

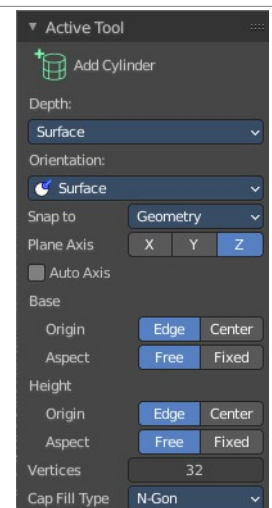

## Depth

### **Position**

How to position the primitive.

### **Surface**

Start placing on the surface. The 3d cursor acts as a fallback.

### **3D Cursor Plane**

Start placement using a point that is projected at the selected axis at the 3d cursor position

### **3D Cursor View**

Start placement using the mouse cursor projected onto the view plane.

### **Orientation**

In which orientation the new object to create.



### **Snap To**

The target for snapping. Geometry snaps to existing mesh geometry. Default snaps to the ground.

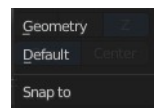
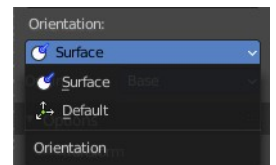

### **Plane Axis**

What plane axis to use.



### **Auto Axis**

Select the closest axis when placing objects. Surface overrides.

### **Base**

#### **Origin**

From where to scale the primitive. From one of its corners or from the center.

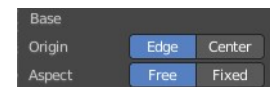

#### **Aspect**

Scale uniformly or in drag direction.

### **Height**

#### **Origin**

From where to scale the primitive. From one of its corners or from the center.

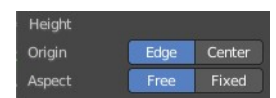

#### **Aspect**

Scale uniformly or in drag direction.

### **Vertices**

The number of vertices.

**Cap Fill Type** defines how the cap face is filled.

- Nothing means you have no face at the top and the bottom of the Cylinder.
- N-Gon means that the cap face is an N-Gon face.
- Triangle Fan means that the cap face is triangulated.

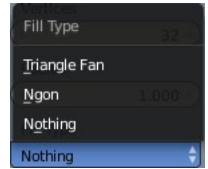

### **Last Operator Add Circle Panel**

**Vertices** defines of how much vertices the circle is made.

**Radius** defines the radius of the Cylinder.

**Depth** defines the length of the Cylinder.

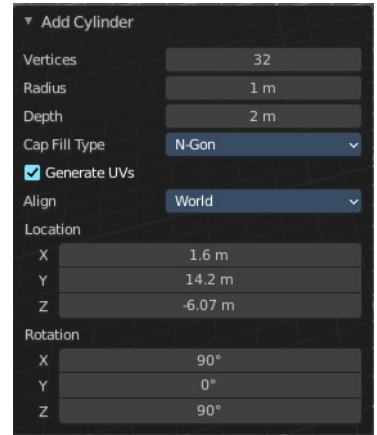

**Cap Fill Type** defines how the cap face is filled.

- Nothing means you have no face at the top and the bottom of the Cylinder.
- N-Gon means that the cap face is an N-Gon face.
- Triangle Fan means that the cap face is triangulated.

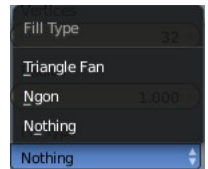

**Generate UV's** creates UV's for this primitive.

**Align to view** aligns the geometry to the chosen view. World, View or 3D cursor.

**Location** defines the location of the Cylinder.

**Rotation** defines the rotation of the Cylinder.

## **Add UV Sphere**

Adds a UV sphere primitive.

### **Tool Settings**

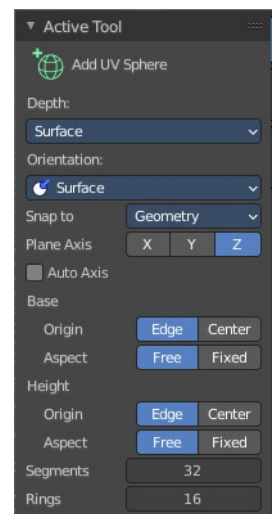

**Depth**

**Position**

How to position the primitive.

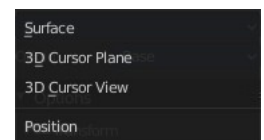

## Surface

Start placing on the surface. The 3d cursor acts as a fallback.

## 3D Cursor Plane

Start placement using a point that is projected at the selected axis at the 3d cursor position

## 3D Cursor View

Start placement using the mouse cursor projected onto the view plane.

## Orientation

In which orientation the new object to create.

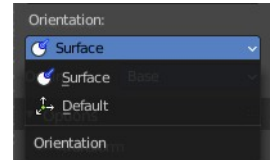

## Snap To

The target for snapping. Geometry snaps to existing mesh geometry. Default snaps to the ground.

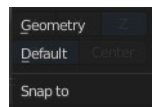

## Plane Axis

What plane axis to use.



## Auto Axis

Select the closest axis when placing objects. Surface overrides.

## Base

### Origin

From where to scale the primitive. From one of its corners or from the center.

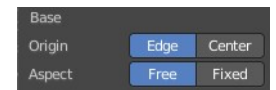

### Aspect

Scale uniformly or in drag direction.

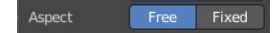

## Height

### Origin

From where to scale the primitive. From one of its corners or from the center.

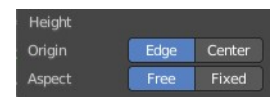

### Aspect

Scale uniformly or in drag direction.



## Segments

Defines of how much segments the sphere has vertically.

## Rings

Defines how much rings the sphere has horizontally.

## Last Operator Add UV Sphere Panel

**Segments** defines of how much segments the sphere has vertically.

**Rings** defines how much rings the sphere has horizontally.

**Size** defines the radius of the UV Sphere.

**Generate UV's** creates UV's for this primitive.

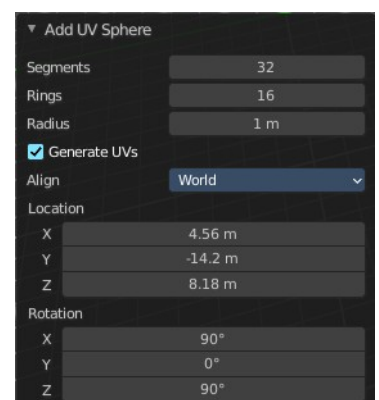

**Align to view** aligns the geometry to the chosen view. World, View or 3D cursor.

**Location** defines the location of the Sphere.

**Rotation** defines the rotation of the Sphere.

## Add Icosphere

Adds an icosphere primitive.

### Tool Settings

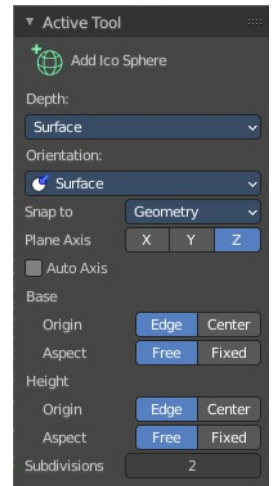

### Depth

#### Position

How to position the primitive.

#### Surface

Start placing on the surface. The 3d cursor acts as a fallback.

#### 3D Cursor Plane

Start placement using a point that is projected at the selected axis at the 3d cursor position

#### 3D Cursor View

Start placement using the mouse cursor projected onto the view plane.

#### Orientation

In which orientation the new object to create.

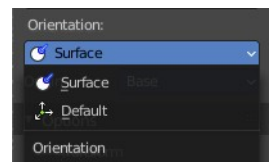
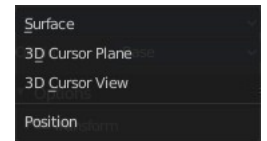

#### Snap To

The target for snapping. Geometry snaps to existing mesh geometry. Default snaps to the ground.

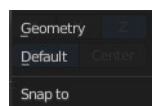

#### Plane Axis

What plane axis to use.



#### Auto Axis

Select the closest axis when placing objects. Surface overrides.

## **Base**

### **Origin**

From where to scale the primitive. From one of its corners or from the center.

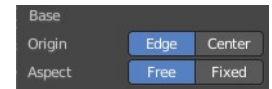

### **Aspect**

Scale uniformly or in drag direction.

## **Height**

### **Origin**

From where to scale the primitive. From one of its corners or from the center.

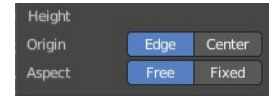

### **Aspect**

Scale uniformly or in drag direction.

## **Subdivisions**

The subdivision level of the Ico Sphere.

## **Last Operator Add Ico Sphere Panel**

**Subdivisions** defines the subdivision level of the Ico Sphere.

**Size** defines the radius of the Ico Sphere.

**Generate UV's** creates UV's for this primitive.

**Align to view** aligns the geometry to the chosen view. World, View or 3D cursor.

**Location** defines the location of the Sphere.

**Rotation** defines the rotation of the Sphere.

